

Transmittal Number PT 15-083	Date November 2015
Publication Distribution To: <i>Design Manual</i> Holders	
Publication Title <i>Design Manual</i> – November 2015	Publication Number M 22-01.12
Originating Organization WSDOT Development Division, Design Office – Design Policy, Standards, and Safety Research Section	

Remarks and Instructions

What's changed in the Design Manual for November 2015?

For a summary of the 2015 substantial revisions, technical errata, and minor revisions, see pages 4 through 9. This revision cycle, the *Design Manual* is reverting back to one volume. As a user, you can use the online manual or paper. If you use paper, you can determine the number and size of binders you will need for the information, and label them in a way that is convenient for you.

How do you stay connected to current design policy?

It's the designer's responsibility to apply current design policy when developing transportation projects at WSDOT. The best way to know what's current is to reference the manual online.

Access the current electronic WSDOT *Design Manual*, the latest revision package, and individual chapters at: www.wsdot.wa.gov/publications/manuals/m22-01.htm

We're ready to help. If you have comments or questions about the Design Manual, please don't hesitate to contact us.

Area of Practice	Your Contacts		
Geometric Design	Andrew Beagle	360-705-7272	BEAGLEA@wsdot.wa.gov
Roadside Safety and Traffic Barriers	Jeff Petterson	360-705-7246	PETTERJ@wsdot.wa.gov
General Guidance and Support	Chris Schroedel	360-705-7299	SCHROEC@wsdot.wa.gov
	John Donahue	360-705-7952	DONAHJO@wsdot.wa.gov

To get the latest information on individual WSDOT publications:

Sign up for email updates at: www.wsdot.wa.gov/publications/manuals/

HQ Design Office Signature /s/ Jeff Carpenter	Phone Number 360-705-7821
---	------------------------------

Remove/Insert instructions for those who maintain a printed manual

NOTE: Also replace the **Title Page**, **Foreword**, and **Comment Form**.

CHAPTER/SECTION	REMOVE PAGES	INSERT PAGES
Contents/Exhibits	Vol 1: 1-1 – 1-12 and Vol 2: 2-1 – 2-18	New Single Volume 1 – 26
Technical Errata	N/A	TE-1&2
100 Manual Description	Entire Chapter	Entire Chapter
110 Design Build Projects	Entire Chapter	Entire Chapter
120 Planning	Entire Chapter	Retired
130 Project Development Sequence	Entire chapter	Retired
225 Environmental Coordination	Entire chapter	Entire chapter
300 Design Documentation, Approval, and Process Review	Entire chapter	Entire chapter
305 Managing Projects	Entire chapter	Entire chapter
310 Value Engineering	Entire chapter	Entire chapter
320 Traffic Analysis	Entire chapter	Entire chapter
321 Sustainable Safety	Entire chapter	Entire chapter
510 Right of Way Considerations	Entire chapter	Entire chapter
520 Access Control	Entire chapter	Entire chapter
530 Limited Access Control	Entire chapter	Entire chapter
540 Managed Access Control	Entire chapter	Entire chapter
550 Interchange Justification Report	Entire chapter	Entire chapter
610 Investigation of Soils, Rock, and Surfacing Materials	610-9&10	610-9&10
620 Design of Pavement Structure	Entire chapter	Entire chapter
710 Site Data for Structures	Entire chapter	Entire chapter
720 Bridges	Entire chapter	Entire chapter
730 Retaining Walls and Steep Reinforced Slopes	730-5–8	730-5–8
1010 Work Zone Safety and Mobility	1010-1&2	1010-1&2
1020 Signing	Entire chapter	Entire chapter
1030 Delineation	1030-1&2, 9-12	1030-1&2, 9-12
1040 Illumination	1040-3&4, 9&10	1040-3&4, 9&10
1100 Design Matrix Procedures	Entire chapter	Retired
1110 Minor Operational Enhancement Projects	Entire chapter	Retired
1120 Basic Design Level	Entire chapter	Retired
1130 Modified Design Level	Entire chapter	Retired
1140 Full Design Level	Entire chapter	Retired
1150 Context and Modally Integrated Design – Main Streets	Entire chapter	Retired
1100 Practical Design	N/A	New chapter
1101 Need Identification	N/A	New chapter
1102 Context Identification	N/A	New chapter
1103 Design Control Selection	N/A	New chapter
1104 Alternatives Analysis	N/A	New chapter
1105 Design Element Selection	N/A	New chapter
1106 Design Element Dimensions	N/A	New chapter
1120 Preservation Projects	N/A	New chapter
1210 Geometric Plan Elements	Entire chapter	Entire chapter
1220 Geometric Profile Elements	Entire chapter	Entire chapter
1230 Geometric Cross Section	Entire chapter	Entire chapter
1240 Turning Roadways	Entire chapter	Entire chapter
1250 Superelevation	Entire chapter	Entire chapter
1260 Sight Distance	1260-1&2	1260-1&2
1270 Auxiliary Lanes	Entire chapter	Entire chapter

CHAPTER/SECTION		REMOVE PAGES	INSERT PAGES
1300	Intersection Control Type	Entire Chapter	Entire Chapter
1310	Intersections	Entire Chapter	Entire Chapter
1340	Driveways	1340-3&4	1340-3&4
1360	Interchanges	Entire chapter	Entire chapter
1410	High-Occupancy Vehicle Facilities	1410-1&2, 9&10, 13-16	1410-1&2, 9&10, 13-16
1420	HOV Direct Access	Entire chapter	Entire chapter
1430	Transit Facilities	Entire chapter	Entire chapter
1510	Pedestrian Facilities	1510-27–30, 35–42	1510-27–30, 35–42
1520	Roadway Bicycle Facilities	Entire chapter	Entire chapter
1600	Roadside Safety	Entire chapter	Entire chapter
1610	Traffic Barriers	Entire chapter	Entire chapter
1620	Impact Attenuator Systems	1620-1&2	1620-1&2
1720	Weigh Sites	1720-1&2, 5&6	1720-1&2, 5&6
Glossary		Entire glossary	Entire glossary

About revision marks and footer dates:

- A new date appears in the footer of each page that has changes or new/different pagination.
- When a chapter is new or substantially rewritten, no revision marks are applied; new dates are assigned.
- Many chapters have been edited to remove prior terminology like *design matrices*, *design levels*, *evaluate upgrade*; replace *collision* with *crash*, and other changes. While this was being accomplished it was an opportune time to update chapters' appearances. So many chapters were assigned new dates and latest chapter styles were applied. References sections are moved to back of chapters in most cases, causing sections to be renumbered.

Summary of *Design Manual* Changes – November 2015 (Revisions merit careful study beyond this summary)

Highlights of the More Substantial Revisions

New chapters on WSDOT Practical Design replace the previous chapters in the 1100 series. Other key revised chapters include 300, 321, 1230, and 1520 (see highlights below.)

The new 1100 series chapters instruct on procedures and tools to perform practical design.

- **New documentation tools** are presented in the chapters. They include Basis of Design, Design Parameters, Alternatives Comparison Table, and replacing deviations using the Design Analysis tool.
- **Examples are provided** in the new chapters to aid in understanding and application of practical design procedures and tools.
- **Additional Practical Design Guidance Documents** are available online. They are not considered part of the *Design Manual*. However new chapters do reference them and provide links to the design support website where they are.

Chapter 1100 Practical Design

- Provides a process and informational overview of practical design and how to implement it.
- New terminology, general information, and a procedural process overview are provided, while Chapters 1101-1106 & 1120 provide specific design policy details for each procedural step.

Chapter 1101 Need Identification

- Instruction on different types of needs—baseline and contextual—used in WSDOT’s practical design procedures for design element selection and dimensioning.
- A method to diagnose and analyze the contributing factors of the identified need.
- Instruction on how to determine performance metrics and targets for identified need.

Chapter 1102 Context Identification

- Provides overview and details for determining land use and transportation contexts.
- Discusses how context impacts design control selection.

Chapter 1103 Design Control Selection

- This chapter provides guidance on the selection of design controls for state routes.
- Five WSDOT design controls are: design year, modal priority, access control, target speed, and terrain classification.

Chapter 1104 Alternatives Analysis

- This chapter discusses how information from planning phases and Chapters [1101](#), [1102](#), and [1103](#) is utilized in alternative solution formation.

Chapter 1105 Design Element Selection

- Chapter instructs on design elements and documentation for elements that are employed and/or changed by the preferred alternative or strategy.

Chapter 1106 Design Element Dimensions

- Methods are presented to determine design element dimensions and document them.
- Design analysis is presented as a procedure and instrument to document justification underlying the design element selection and dimensioning associated with a preferred alternative for a specific dimensioning method.

Chapter 300 Design Documentation, Approval, and Process Review

- Changes correspond with practical design updates in 1100 series.

- Basis of Design (BOD) added to narrative and approvals exhibit. Basis of Design is found via links in Chapter 300 and 1100 series.
- Revised text and tables related to FHWA oversight and approvals, per the *Stewardship and Oversight Agreement by and between FHWA and WSDOT*, March 2015.
- Design Analysis content added.
- Chapter content reorganized.

Technical Errata

- “Design deviation” is a term being removed from the *Design Manual*. It is replaced with “Design Analysis.” Chapters 300 and 1106 provide new instruction about design analysis tools, procedures and approvals. However, not all chapters have replaced the term *deviation* with *design analysis*. The Errata instructs where encountered in the Design Manual, replace the term *deviation* or *design deviation* with *Design Analysis* and to see Chapters 300 and 1106 for further information.
- A future update will incorporate the needed chapter revisions to remove and replace *deviation* with *design analysis* and/or revise content in some other manner.

Chapter 321 Sustainable Safety

- This revised chapter has a strong tie to new practical design content in the 1100 chapter series, related to quantifying safety performance using scientific tools and assessment techniques to determine appropriate safety countermeasures.
- New content provided related to when consultation is needed for determining scale and scope of safety analysis.

Chapter 530 Limited Access Control

- Revisions relate to practical design by identifying access control as a design control, terminology changes throughout, and an understanding that re-evaluation of locations planned for limited access are appropriate given the decades old limited access plans.
- Description changes related to limited access control procedures, and procedural content changes for road approaches.

Chapter 540 Managed Access Control:

- Practical design related terminology changes and general chapter organizational changes.
- Revised to prompt access evaluation as a design control
- Clarified WSDOT policy on evaluating existing access connections when outside an incorporated city or town.
- Legal requirements are contained under each of the five managed access classes, and minor word changes were made to emphasize multiple intersection control types versus simply a narrative about traffic signals.

Chapter 1230 Geometric Cross Section

- Chapter revised and expanded with example cross-sections for various contexts, modal priorities, and speeds, to coincide with practical design chapters in the 1100 series.
- A range of values for design elements are provided in the sections where prior content typically provided a single standard value.
- WSDOT’s “design up” philosophy emphasized.

Chapter 1300 Intersection Control Type

- Updated with spot edits and terminology changes to better align with Practical Design content in the 1100 series of chapters
- Increased region and HQ traffic offices roles and responsibilities
- Increased content required for analysis to include evaluation of multimodal operations
- Reinforced the requirement to analyze roundabouts

- Rewrite of former public involvement section to align with the new WSDOT Community Engagement Plan

Chapter 1520 Roadway Bicycle Facilities

- Updated to align with Practical Design content in the 1100 series, and Chapter 1230 – Geometric Cross Section.
- Presents a larger variety of bicycle facility types consistent with WSDOT’s NACTO Guide endorsement.
- Presents intersection treatments for enhancing the bicycle performance.
- Presents examples for bicycle facilities going through different interchange configurations.

Highlights of Other Chapter Revisions

Chapter 100 – Manual Description

- Updated description of manual and chapters; reduced content about Practical Solutions, since the new 1100 chapters now provide this.

Chapter 305 – Managing Projects

- Updated information on, and links to Secretary’s Executive Orders including *Moving Washington Forward: Practical Solutions*.
- Updates title and link to Instructional; Letter IL 4071, *Use of Risk-Based Project Estimates for Budgeting and Project Management*
- Strengthened connection to Chapter 310 regarding VERA and VE procedures
- Updated text in section on Context Sensitive solutions

Chapter 310 – Value Engineering

- Combined Value Engineering and Risk Assessment
- Value Engineering and the connection with Practical Design
- Project management accountability section discusses expedient follow through
- on VE recommendations
- VE elements from WSDOT’s Master Deliverables List are emphasized
- Updated links to Federal policy

Chapter 320 Traffic Analysis

- Updated content on *design year* and *horizon year*, added reference to new Chapter 1103; updated content on Traffic Analysis Software per Traffic Office; added more chapters to the references section.

Chapter 510 Right of Way Considerations

- Revised content on right of way widths and removed reference to Chapter 1140.

Chapter 520 Access Control

- This chapter is an overview of vocabulary used in Chapters 530 and 540 and only required minor text revisions.
- Removed reference to retired Chapter 1140, Full Design Level; provided link to functional classification website. Minor rephrasing in 520.01.

Chapter 610 Investigation of Soils, Rock, and Surfacing Materials

- Removed reference and nonworking link to old Facilities Operating Procedure in 610.04(9)
- Changed chapter reference from 1130 to 730 in 610.04(10)(b).

Chapter 620 Pavement Design

- WSDOT HQ Materials Lab has revised this chapter to correspond to current procedures and manuals.

Chapter 710 Site Data for Structures

- Clarifies procedures and Bridge office design roles based on structure type and size. The Structure Site Data Checklist is updated and base map requirements are specified

Chapter 720 Bridges

- Removed reference to the outgoing design matrices and replaced with examples of projects that likely trigger the need to request a structural capacity report.
- Exhibits were reordered to coincide with text flow.

Chapter 730 Retaining Walls and Steep Reinforced Slopes

- Section 730.04(7)(b) Fall Protection is revised to align with state requirements for fall protection.

Chapter 1010 work Zone Safety and Mobility

- Added statement about high speed being 45 mph or greater, for purposes of this chapter
- Added reference and link to April 2015 Executive Order 1060.

Chapter 1020 Signing

- Removed reference to *Design Matrices* and *design levels*; added criteria for determining sign replacement or modifications
- Revised content on sign illumination; revised reflective sheeting for overhead signs (Exhibit 1020-1) to reflect Traffic office's analysis and concurrence from Region Traffic Engineers.

Chapter 1030 Delineation

- Added statement to not recess side-to-side RPMs on wide dotted lane lines, per Traffic office
- Replaced references to Chapter 1140 with 1230
- Updated terminology and documentation statement.

Chapter 1040 Illumination

- Removed reference to retired chapters 1110, 1120, 1130, and 1140.
- Removed reference to *design level* classifications; replaced with link to functional classification.

Chapter 1210 Geometric Plan Elements

- Replaced references to retired chapters with reference to Chapter 1230. Updated terminology consistent with practical design procedural chapters. Updated chapter format, and moved definition terms to the Glossary and references to the back of chapter;
- Added considerations about maintaining basic number of lanes in 1210.04;

Chapter 1240 – Turning Roadways

- Added content in several sections about this chapter's applicability based on vehicle types, safety and operational performance
- Removed references to retired chapters, other minor terminology changes, and moved references to back of chapter.
- Updated Documentation section

Chapter 1250 – Superelevations

- Removed references to retired chapters; moved definitions to the Glossary and References to back of chapter.
- Removed statement in 1250.06: Single-lane ramps have a lane width of 15 feet in curves, requiring the runoff length to be adjusted (deletion side bar provided on page)

Chapter 1270 Auxiliary Lanes

- Removed references to retired chapters, updated Documentation section, moved Reference section to back of chapter.
- Added chapter/subject references in General
- Added text in multiple sections and exhibits about dimensioning of design elements, and added references to chapters 1105, 1106 or 1230, as applicable.
- Added text for traffic engineer's concurrence in 1270.03(4)(a) regarding continuous passing lanes
- Added text in 1270.04(2) about slow-moving vehicle turnout width based on vehicle type expected
- Added text in 1270.05(1) about shoulder driving for slow vehicles as a means to meet performance objectives

Chapter 1310 Intersections

- References section moved to back; chapter sections renumbered.
- Replaced terminology throughout, and added content and references consistent with 1106 and 1230 in multiple sections and exhibits.
- 1310.01: Added new text pertaining to multimodal design.
- 1310.02(7): Removed reference to Ch. 1140 and revised text related to local agency-owned crossroads.
- 1310.05 Removed terms *design exception* and *evaluate upgrade* and replaced both (for now) with *deviation*.
- 1310.07(3): Removed *variance* and *evaluate upgrade*; replaced with *deviation*, pertaining to local agency or developer-initiated intersections and approvals.

Chapter 1340 Driveways

- 1340.03(2): Removed reference to *design matrices* and replaced with new statement about when to evaluate existing driveways

Chapter 1360 – Interchanges

- Added references to new chapters 1103 and 1106 in multiple sections, terminology changes, references section moved to back; Definitions section removed; terms remain in Glossary;
- Sections renumbered and revisions tracked. This accounts for the majority of side bar marks.
- Removed reference to *design exception* in Acceleration Lane and Deceleration Lane text.
- 1360.03(4) Cross Sections, and Exhibit 1360-6 Ramp Widths: revised text, notes and values in table providing a range for traveled way dimensions, considering operational needs and vehicle tracking.
- Multiple exhibits beginning with 1360-9: drawings and tables remain unchanged; Note added to determine lane widths based on Exhibit 1360-6 and Chapters 1230 and 1106.

Chapter 1410 High-Occupancy Vehicle Facilities

- Removed references to retired chapters, updated terminology, and updated Documentation statement
- Removed statement: *A deviation is required when any proposed or existing design element does not meet the applicable design level for the project*
- Removed statement: *Restriping of lane or shoulder widths to less than the design level and functional class of the highway is a design deviation and approval is required*
- Revised statement about enforcement area design

Chapter 1420 HOV Direct Access

- Renamed and revised content in 1420.01(1); text replaces previous content that referred to *design matrices* and old Chapter 1100. The section offers more considerations now in terms of performance and tradeoffs with general purpose lanes.
- References section moved to back
- Added references to new chapters 1103 and 1106 in General and throughout.
- Removed references to retired chapters, Reference section moved to back of chapter, and added references to new chapters, updated ADA references.

- Added notes to multiple exhibits regarding determining lane widths according to 1420.03(5)(c), Chapter 1230 and using Chapter 1106 procedures.

Chapter 1430 – Transit Facilities

- Revision clarifies chapter is intended to be used by WSDOT staff, transit agencies, or others involved the development of transit facilities on state highways
- Updated bus stop policy and guidance to align with changes to WAC 468-46 Transit Vehicles and Stop Zones
- Updated guidance on parking area design for Park and Ride lots
- Updated references

Chapter 1510 Pedestrian Facilities

- Replaced references to retired chapters
- Minor terminology updates

Chapter 1600 Roadside Safety

- Removed references to retired chapters, minor terminology updates throughout, and new references to chapters 1105 and 1230 added.

1610 Traffic Barriers

- Removed references to retired chapters, minor terminology updates throughout, and new references to chapters 1105 added where applicable.
- 1610.06(4)(b)&(c): Replaced 45 with 50 and 40 with 45 pertaining to traffic barriers and highway speeds.
- 1610.08(3): Removed reference to *Barrier and Terminals column of Design Matrix*; revised instruction to replace sloped-down concrete terminals when they don't meet criteria.
- 1610.10(2): Removed reference to *design exception* and replaced with instruction to see Chapter 1510, pertaining to sidewalks.

1620 Impact Attenuator Systems

- 1620.02: Reference to *Barrier Terminals and Transition Sections columns on a design matrix* is removed.

1720 Weigh Sites

- Removed reference to Chapter 1140 and replaced with Glossary or Chapter 1103 references.

Chapters Retired

- The previous 1100 series is replaced with the above new 1100 practical design series content.
- The Planning and Project Development Chapters 120 and 130 are retired. Some Chapter 120 content was relocated to new Chapter 1103. The new 1100 series and revised Chapter 300 cover procedures for practical design. As planning evolves, more may be added to the *Design Manual*, or references to online WSDOT resources added.



Design Manual

M 22-01.12

November 2015

- Division 1 – General Information
- Division 2 – Hearings, Environmental, and Permits
- Division 3 – Project Documentation
- Division 4 – Surveying
- Division 5 – Right of Way and Access Control
- Division 6 – Soils and Paving
- Division 7 – Structures
- Division 8 – Hydraulics
- Division 9 – Roadside Development
- Division 10 – Traffic Safety Elements
- Division 11 – Practical Design
- Division 12 – Geometrics
- Division 13 – Intersections and Interchanges
- Division 14 – HOV and Transit
- Division 15 – Pedestrian and Bicycle Facilities
- Division 16 – Roadside Safety Elements
- Division 17 – Roadside Facilities

Engineering and Regional Operations

Development Division, Design Office

Americans with Disabilities Act (ADA) Information

Materials can be made available in an alternative format by emailing the WSDOT Diversity/ADA Affairs Team at wsdotada@wsdot.wa.gov or by calling toll free: 855-362-4ADA (4232). Persons who are deaf or hard of hearing may contact that number via the Washington Relay Service at 7-1-1.

Title VI Notice to Public

It is Washington State Department of Transportation (WSDOT) policy to ensure no person shall, on the grounds of race, color, national origin, or sex, as provided by Title VI of the Civil Rights Act of 1964, be excluded from participation in, be denied the benefits of, or be otherwise discriminated against under any of its federally funded programs and activities. Any person who believes his/her Title VI protection has been violated may file a complaint with WSDOT's Office of Equal Opportunity (OEO). For Title VI complaint forms and advice, please contact OEO's Title VI Coordinator at 360-705-7082 or 509-324-6018.

To get the latest information on individual WSDOT publications, sign up for email updates at:

 www.wsdot.wa.gov/publications/manuals

Foreword

The *Design Manual* is for use by Washington State Department of Transportation engineering personnel and consultant workforces. It provides policies, procedures, and methods for developing and documenting the design of improvements to the transportation network in Washington. It has been developed for state facilities and may not be appropriate for all county roads or city streets that are not state highways.

The *Design Manual* supplements the engineering analyses and judgment inherent with practical design. It provides uniform procedures for documenting and implementing design decisions.

The Federal Highway Administration has agreed to approve designs that follow the guidance in the *Design Manual*; therefore, following the guidance is mandatory for state highway projects. When proposed designs meet the requirements contained in the *Design Manual*, little additional documentation is required.

The complexity of transportation design requires designers to make fundamental trade-off decisions that balance competing spatial considerations. Although this adds to the complexity of design, it acknowledges the unique needs of specific projects and the relative priorities of various projects and programs. Projects are designed in light of finite transportation funding. The *Design Manual* emphasizes “practical design” as a means to produce environmentally conscious, sustainable, context-based designs that achieve the purpose and need for the lowest cost. Implementing practical design considers the needs of all users, fostering livable communities and modally integrated transportation systems used safely by all, including motorists, freight haulers, transit, pedestrians, and bicyclists.

Updating the *Design Manual* is an ongoing process and revisions are issued regularly. The addition of new or modified design criteria to the *Design Manual* through the revision process does not imply that existing features are deficient or inherently dangerous. Nor does it suggest or mandate immediate engineering review or initiation of new projects. Comments, questions, and improvement ideas are welcomed. Use the comment form on the next page or the contact information on the Design Policy Internet Page: www.wsdot.wa.gov/design/policy

/s/ Jeff Carpenter _____

Jeff Carpenter, P.E.

Director & State Design Engineer,
Development Division

Comment Form

From:	_____	Date:	_____
	_____	Phone:	_____

To: WSDOT Headquarters
Development Division, Design Office
Attn: Policy, Standards, and Research Section
PO Box 47329
Olympia, WA 98504-7329

Subject: *Design Manual* Comment

Comment (marked copies attached):

Technical Errata

Technical Errata November 2015

This Technical Errata is provided with the November 2015 *Design Manual* publication and will be fully incorporated in the *Design Manual* in 2016.

Errata Purpose

- To achieve the November 2015 *Design Manual* publication schedule as planned.
- To institute new terminology, documentation, and procedures related to design deviations.

Errata Description

WSDOT is changing terminology and documentation format for what has been known as *design deviations*.

The new terminology that hereby replaces *design deviation* is **Design Analysis**.

A **Design Analysis Documentation** tool replaces the previous Exhibit in Chapter 300 that provided design deviation content outline.

Chapter 300 and 1106 are updated for this new terminology and documentation tool used for varying from WSDOT or AASHTO criteria. However other chapters will need to be modified in 2016 to remove and replace content.

Errata Instruction

Where encountered in the Design Manual, replace the term *deviation* or *design deviation* with *Design Analysis*.

Refer to instruction in Chapter 300 and Chapter 1106 for further information about *Design Analysis*.

- Both chapters contain a link to the *Design Analysis* documentation tool.
- Chapter 300 contains instruction on Design Analysis approval authorities.

Division 1 – General Information

- Chapter 100 Manual Description**
- 100.01 Purpose
 - 100.02 Presentation and Revisions
 - 100.03 Practical Solutions
 - 100.04 Manual Applications
 - 100.05 Manual Use
 - 100.06 Manual Organization
- Chapter 110 Design-Build Projects**
- 110.01 General
 - 110.02 Terminology and Language Used
 - 110.03 Design and Documentation Responsibility
 - 110.04 References

Division 2 – Hearings, Environmental, and Permits

- Chapter 210 Public Involvement and Hearings**
- 210.01 General
 - 210.02 References
 - 210.03 Definitions
 - 210.04 Public Involvement
 - 210.05 Public Hearings
 - 210.06 Environmental Hearing
 - 210.07 Corridor Hearing
 - 210.08 Design Hearing
 - 210.09 Limited Access Hearing
 - 210.10 Combined Hearings
 - 210.11 Administrative Appeal Hearing
 - 210.12 Follow-Up Hearing
 - 210.13 Documentation
- Chapter 225 Environmental Coordination**
- 225.01 General
 - 225.02 References
 - 225.03 Determining the Environmental Documentation
 - 225.04 Identifying the Project Classification
 - 225.05 Environmental Commitment File
 - 225.06 Environmental Permits and Approvals
 - 225.07 Documentation

Division 3 – Project Documentation

- Chapter 300 Design Documentation, Approval, and Process Review**
- 300.01 General
 - 300.02 WSDOT Project Development
 - 300.03 Design Documentation and Records Retention Policy
 - 300.04 Project Design Approvals
 - 300.05 FHWA Oversight and Approvals
 - 300.06 Project Documents and Approvals
 - 300.07 Process Review
 - 300.08 References

Chapter 301	Design and Maintenance Coordination
301.01	Introduction
301.02	Communication
301.03	Incorporating Maintenance Considerations in Design
301.04	Documentation
301.05	References
Chapter 305	Managing Projects
305.01	Introduction
305.02	References
305.03	Definitions
305.04	Design Project Management Overview
305.05	Cost Estimating for Design Project Development
305.06	Value Engineering
305.07	Context Sensitive Solutions (CSS)
305.08	Additional Design Resources
Chapter 310	Value Engineering
310.01	General
310.02	References
310.03	Statewide VE Program
310.04	VE Procedure
310.05	Value Engineering Combined with Risk Assessment (VERA)
310.06	Practical Design Workshops
310.07	Project Management Accountability
310.08	Documentation
Chapter 320	Traffic Analysis
320.01	General
320.02	Design Year and Forecasting Considerations
320.03	Traffic Analysis Software
320.04	Travel Demand Forecasting
320.05	Traffic Impact Analysis (TIA)
320.06	TIA Scope
320.07	TIA Methods and Assumptions Document
320.08	TIA Methodologies
320.09	TIA Mitigation Measures
320.10	TIA Report
320.11	References
Chapter 321	Sustainable Safety
321.01	General
321.02	General Sustainable Safety Process
321.03	Sustainable Safety for I-2 Projects
321.04	Sustainable Safety for P3 – Major Signal and Illumination Projects
321.05	Sustainable Safety for I-1 and I-3 Projects
321.06	Stand-Alone Sustainable Safety Applications
321.07	Safety Analysis Resources and Tools
321.08	Reports and Documentation
321.09	References

Division 4 – Surveying

Chapter 400 Surveying and Mapping

- 400.01 General
- 400.02 References
- 400.03 Procedures
- 400.04 Datums
- 400.05 Global Positioning System
- 400.06 WSDOT Survey Monument Database
- 400.07 Geographic Information System
- 400.08 Photogrammetric Surveys
- 400.09 Documentation

Chapter 410 Monumentation

- 410.01 General
- 410.02 References
- 410.03 Control Monuments
- 410.04 Alignment Monuments
- 410.05 Property Corners
- 410.06 Other Monuments
- 410.07 Filing Requirements
- 410.08 Documentation

Division 5 – Right of Way and Access Control

Chapter 510 Right of Way Considerations

- 510.01 General
- 510.02 Special Features
- 510.03 Easements and Permits
- 510.04 Programming for Funds
- 510.05 Appraisal and Acquisition
- 510.06 Transactions
- 510.07 Documentation
- 510.08 References

Chapter 520 Access Control

- 520.01 General
- 520.02 References
- 520.03 Definitions
- 520.04 Vocabulary

Chapter 530 Limited Access Control

- 530.01 General
- 530.02 Achieving Limited Access
- 530.03 Full Control (Most Restrictive)
- 530.04 Partial Control
- 530.05 Modified Control (Least Restrictive)
- 530.06 Access Approaches
- 530.07 Frontage Roads
- 530.08 Turnbacks
- 530.09 Adjacent Railroads
- 530.10 Changes to Highway Limited Access Control
- 530.11 Documentation

Chapter 540 Managed Access Control

- 540.01 General
- 540.02 Design Considerations
- 540.03 Managed Access Highway Classes
- 540.04 Corner Clearance Criteria
- 540.05 Access Connection Categories
- 540.06 Access Connection Permit
- 540.07 Permitting and Design Documentation
- 540.08 Other Considerations
- 540.09 Preconstruction Conference
- 540.10 Adjudicative Proceedings
- 540.11 Documentation
- 540.12 References

Chapter 550 Interchange Justification Report

- 550.01 General
- 550.02 Procedures
- 550.03 Interchange Justification Report and Supporting Analyses
- 550.04 Report Organization and Appendices
- 550.05 IJR Review and Approval
- 550.06 Updating an IJR
- 550.07 Documentation
- 550.08 References

Chapter 560 Fencing

- 560.01 General
- 560.02 References
- 560.03 Design Criteria
- 560.04 Fencing Types
- 560.05 Gates
- 560.06 Procedure
- 560.07 Documentation

Division 6 – Soils and Paving

Chapter 610 Investigation of Soils, Rock, and Surfacing Materials

- 610.01 General
- 610.02 References
- 610.03 Materials Sources
- 610.04 Geotechnical Investigation, Design, and Reporting
- 610.05 Use of Geotechnical Consultants
- 610.06 Geotechnical Work by Others
- 610.07 Surfacing Report
- 610.08 Documentation

Chapter 620 Design of Pavement Structure

- 620.01 General
- 620.02 Estimating Tables

Chapter 630 Geosynthetics

- 630.01 General
- 630.02 References
- 630.03 Geosynthetic Types and Characteristics
- 630.04 Geosynthetic Function Definitions and Applications
- 630.05 Design Approach for Geosynthetics
- 630.06 Design Responsibility
- 630.07 Documentation

Division 7 – Structures

- Chapter 700 Project Development Roles and Responsibilities for Projects With Structures**
 - 700.01 General
 - 700.02 Procedures
- Chapter 710 Site Data for Structures**
 - 710.01 General
 - 710.02 Required Data for All Structures
 - 710.03 Additional Data for Waterway Crossings (Bridges and Buried Structures)
 - 710.04 Additional Data for Grade Separations
 - 710.05 Additional Data for Widening
 - 710.06 Documentation
 - 710.07 References
- Chapter 720 Bridges**
 - 720.01 General
 - 720.02 Bridge Locations
 - 720.03 Bridge Site Design Elements
 - 720.04 Documentation
 - 720.05 References
- Chapter 730 Retaining Walls and Steep Reinforced Slopes**
 - 730.01 General
 - 730.02 References
 - 730.03 Design Principles
 - 730.04 Design Requirements
 - 730.05 Guidelines for Wall/Slope Selection
 - 730.06 Design Responsibility and Process
 - 730.07 Documentation
- Chapter 740 Noise Barriers**
 - 740.01 General
 - 740.02 References
 - 740.03 Design
 - 740.04 Procedures
 - 740.05 Documentation

Division 8 – Hydraulics

- Chapter 800 Hydraulic Design**
 - 800.01 General
 - 800.02 References
 - 800.03 Hydraulic Considerations
 - 800.04 Safety Considerations
 - 800.05 Design Responsibility
 - 800.06 Documentation

Division 9 – Roadside Development

- Chapter 900 Roadsides**
 - 900.01 General
 - 900.02 References
 - 900.03 Project Development
 - 900.04 Documentation

Chapter 950	Public Art
950.01	General
950.02	References
950.03	Standard Architectural Design
950.04	Criteria for Public Art
950.05	Process and Project Delivery Timing
950.06	Approvals
950.07	Documentation

Division 10 – Traffic Safety Elements

Chapter 1010	Work Zone Safety and Mobility
1010.01	General
1010.02	References
1010.03	Definitions
1010.04	Work Zone Safety and Mobility
1010.05	Transportation Management Plans and Significant Projects
1010.06	Developing TMP Strategies
1010.07	Capacity Analysis
1010.08	Work Zone Design Standards
1010.09	Temporary Traffic Control Devices
1010.10	Positive Protection Devices
1010.11	Other Traffic Control Devices or Features
1010.12	Traffic Control Plan Development and PS&E
1010.13	Training and Resources
1010.14	Documentation
Chapter 1020	Signing
1020.01	General
1020.02	Design Components
1020.03	Overhead Installation
1020.04	State Highway Route Numbers
1020.05	Mileposts
1020.06	Guide Sign Plan
1020.07	Documentation
1020.08	References
Chapter 1030	Delineation
1030.01	General
1030.02	References
1030.03	Definitions
1030.04	Pavement Markings
1030.05	Guideposts
1030.06	Barrier Delineation
1030.07	Object Markers
1030.08	Wildlife Warning Reflectors
1030.09	Documentation

Chapter 1040 Illumination

- 1040.01 General
- 1040.02 References
- 1040.03 Definitions
- 1040.04 Design Considerations
- 1040.05 Required Illumination
- 1040.06 Additional Illumination
- 1040.07 Design Criteria
- 1040.08 Documentation

Chapter 1050 Intelligent Transportation Systems

- 1050.01 General
- 1050.02 References
- 1050.03 Systems Engineering
- 1050.04 FHWA Washington Division ITS Project Contracting Guidance
- 1050.05 Documentation

Division 11 – Practical Design

Chapter 1100 Practical Design

- 1100.01 General
- 1100.02 Practical Design Procedure
- 1100.03 Community Engagement
- 1100.04 Multiagency, Interdisciplinary, and Stakeholder Advisory Team
- 1100.05 Need and Performance Identification
- 1100.06 Context Identification
- 1100.07 Design Control Selection
- 1100.08 Alternative Formulation and Evaluation
- 1100.09 Design Element Selection and Dimensions
- 1100.10 Documentation Tools
- 1100.11 References

Chapter 1101 Need Identification

- 1101.01 General
- 1101.02 Baseline Needs
- 1101.03 Contextual Needs
- 1101.04 Contributing Factors Analysis
- 1101.05 Project Need Statement
- 1101.06 Documentation
- 1101.07 References

Chapter 1102 Context Identification

- 1102.01 General Overview
- 1102.02 Context Identification Procedures
- 1102.03 Context Information Sources
- 1102.04 Context Types, Relationships and Key Characteristics
- 1102.05 Future Context Identification and Context Transitions
- 1102.07 Additional Context Considerations
- 1102.08 Documentation
- 1102.09 References

Chapter 1103 Design Control Selection

- 1103.01 General Overview
- 1103.02 Control: Design Year

- 1103.03 Control: Modal Priority
- 1103.04 Control: Access Management
- 1103.05 Control: Design Speed
- 1103.06 Control: Terrain Classification
- 1103.07 Documentation
- 1103.08 References

Chapter 1104 Alternatives Analysis

- 1104.01 General
- 1104.02 Alternative Solution Formulation
- 1104.03 Alternative Solution Evaluation
- 1104.04 Documentation
- 1104.05 References

Chapter 1105 Design Element Selection

- 1105.01 General
- 1105.02 Selecting Design Elements
- 1105.03 Related Elements
- 1105.04 Documentation
- 1105.05 References

Chapter 1106 Design Element Dimensions

- 1105.01 General
- 1105.02 Dimensioning Design Elements
- 1105.03 Dimensioning Iterations
- 1105.04 Documenting Dimensions
- 1106.05 References

Chapter 1120 Preservation Projects

- 1120.01 General
- 1120.02 Preservation Projects
- 1120.03 Preservation Project Features and Elements
- 1120.04 Documentation

Division 12 – Geometrics

Chapter 1210 Geometric Plan Elements

- 1210.01 General
- 1210.02 Horizontal Alignment
- 1210.03 Distribution Facilities
- 1210.04 Number of Lanes and Arrangement
- 1210.05 Pavement Transitions
- 1210.06 Procedures
- 1210.07 Documentation
- 1210.08 References

Chapter 1220 Geometric Profile Elements

- 1220.01 General
- 1220.02 Vertical Alignment
- 1220.03 Coordination of Vertical and Horizontal Alignments
- 1220.04 Airport Clearance
- 1220.05 Railroad Crossings
- 1220.06 Procedures
- 1220.07 Documentation
- 1220.08 References

Chapter 1230	Geometric Cross Section
1230.01	General
1230.02	Context and Modally Integrated Cross Sections
1230.03	Cross Section Zones and Elements
1230.04	Medians and Outer Separations
1230.05	Curbs
1230.06	Cross Slope
1230.07	Structure Width
1230.08	Documentation
1230.09	References
Chapter 1240	Turning Roadways
1240.01	General
1240.02	Turning Roadway Widths
1240.03	Documentation
1240.04	References
Chapter 1250	Superelevation
1250.01	General
1250.02	Superelevation Rate Selection
1250.03	Existing Curves
1250.04	Turning Movements at Intersections
1250.05	Runoff for Highway Curves
1250.06	Runoff for Ramp Curves
1250.07	Documentation
1250.08	References
Chapter 1260	Sight Distance
1260.01	General
1260.02	References
1260.03	Stopping Sight Distance
1260.04	Passing Sight Distance
1260.05	Decision Sight Distance
1260.06	Documentation
Chapter 1270	Auxiliary Lanes
1270.01	General
1270.02	Climbing Lanes
1270.03	Passing Lanes
1270.04	Slow-Moving Vehicle Turnouts
1270.05	Shoulder Driving for Slow Vehicles
1270.06	Emergency Escape Ramps
1270.07	Chain-Up and Chain-Off Areas
1270.08	Documentation
1270.09	References

Division 13 – Intersections and Interchanges

Chapter 1300	Intersection Control Type
1300.01	General
1300.02	Intersection Control Objectives
1300.03	Common Types of Intersection Control
1300.04	Intersection Treatments for all Modes
1300.05	Procedures
1300.06	Documentation
1300.07	References

Chapter 1310 Intersections

- 1310.01 General
- 1310.02 References
- 1310.03 Design Considerations
- 1310.04 Design Elements
- 1310.05 U-Turns
- 1310.06 Intersection Sight Distance
- 1310.07 Signing and Delineation
- 1310.08 Procedures
- 1310.09 Documentation

Chapter 1320 Roundabouts

- 1320.01 General
- 1320.02 References
- 1320.03 Roundabout Types
- 1320.04 Capacity Analysis
- 1320.05 Geometric Design
- 1320.06 Pedestrians
- 1320.07 Bicycles
- 1320.08 Signing and Pavement Marking
- 1320.09 Illumination
- 1320.10 Road Approach, Parking, and Transit Facilities
- 1320.11 Approvals
- 1320.12 Documentation

Chapter 1330 Traffic Control Signals

- 1330.01 General
- 1330.02 References
- 1330.03 Definitions
- 1330.04 Procedures
- 1330.05 Signal Warrants
- 1330.06 Conventional Traffic Signal Design
- 1330.07 Documentation

Chapter 1340 Driveways

- 1340.01 General
- 1340.02 References
- 1340.03 Design Considerations
- 1340.04 Driveway Design Templates
- 1340.05 Sidewalks
- 1340.06 Driveway Sight Distance
- 1340.07 Stormwater and Drainage
- 1340.08 Mailboxes
- 1340.09 Documentation

Chapter 1350 Railroad Grade Crossings

- 1350.01 General
- 1350.02 References
- 1350.03 Plans
- 1350.04 Traffic Control Systems
- 1350.05 Nearby Roadway Intersections
- 1350.06 Pullout Lanes
- 1350.07 Crossing Surfaces
- 1350.08 Crossing Closure
- 1350.09 Traffic Control During Construction and Maintenance
- 1350.10 Railroad Grade Crossing Petitions and WUTC Orders

- 1350.11 Grade Crossing Improvement Projects
- 1350.12 Light Rail
- 1350.13 Documentation

Chapter 1360 Interchanges

- 1360.01 General
- 1360.02 Interchange Design
- 1360.03 Ramps
- 1360.04 Interchange Connections
- 1360.05 Ramp Terminal Intersections at Crossroads
- 1360.06 Interchanges on Two-Lane Highways
- 1360.07 Interchange Plans for Approval
- 1360.08 Documentation
- 1360.09 References

Chapter 1370 Median Crossovers

- 1370.01 General
- 1370.02 Analysis
- 1370.03 Design
- 1370.04 Plan Updates and Approvals
- 1370.05 Documentation

Division 14 – HOV and Transit

Chapter 1410 High-Occupancy Vehicle Facilities

- 1410.01 General
- 1410.02 References
- 1410.03 Definitions
- 1410.04 Preliminary Design and Planning
- 1410.05 Operations
- 1410.06 Design Criteria
- 1410.07 Documentation

Chapter 1420 HOV Direct Access

- 1420.01 General
- 1420.02 HOV Access Types and Locations
- 1420.03 Direct Access Geometrics
- 1420.04 Passenger Access
- 1420.05 Traffic Design Elements
- 1420.06 Documentation
- 1420.07 References

Chapter 1430 Transit Facilities

- 1430.01 General
- 1430.02 Bus Stops and Pullouts
- 1430.03 Passenger Amenities
- 1430.04 Park and Ride Lots
- 1430.05 Transfer/Transit Centers
- 1430.06 Roadway and Intersection Design
- 1430.07 Documentation
- 1430.08 References

Division 15 – Pedestrian and Bicycle Facilities

Chapter 1510 Pedestrian Facilities

- 1510.01 General
- 1510.02 References
- 1510.03 Definitions
- 1510.04 Policy
- 1510.05 ADA Requirements by Project Type
- 1510.06 Pedestrian Circulation Paths
- 1510.07 Pedestrian Access Routes (PARs)
- 1510.08 Sidewalks
- 1510.09 Curb Ramps
- 1510.10 Crosswalks
- 1510.11 Raised Medians/Traffic Islands
- 1510.12 Pedestrian Pushbuttons at Signals
- 1510.13 At-Grade Railroad Crossings
- 1510.14 Pedestrian Grade Separations (Structures)
- 1510.15 Other Pedestrian Facilities
- 1510.16 Illumination and Signing
- 1510.17 Work Zone Pedestrian Accommodation
- 1510.18 Documentation

Chapter 1515 Shared-Use Paths

- 1515.01 General
- 1515.02 References
- 1515.03 Definitions
- 1515.04 Shared-Use Path Design – The Basics
- 1515.05 Intersections and Crossings Design
- 1515.06 Grade Separation Structures
- 1515.07 Signing, Pavement Markings, and Illumination
- 1515.08 Restricted Use Controls
- 1515.09 Documentation

Chapter 1520 Roadway Bicycle Facilities

- 1520.01 General
- 1520.02 Roadway Bicycle Facility Types
- 1520.03 Bicycle Facility Selection
- 1520.04 Intersection Design Treatments
- 1520.05 Additional Bicycle Design Requirements and Considerations
- 1520.06 Documentation
- 1520.07 References

Division 16 – Roadside Safety Elements

Chapter 1600 Roadside Safety

- 1600.01 General
- 1600.02 References
- 1600.03 Clear Zone
- 1600.04 Mitigation Guidance
- 1600.05 Medians
- 1600.06 Other Roadside Safety Features
- 1600.07 Documentation

Chapter 1610 Traffic Barriers

- 1610.01 General
- 1610.02 References
- 1610.03 Definitions
- 1610.04 Project Criteria
- 1610.05 Barrier Design
- 1610.06 Beam Guardrail
- 1610.07 Cable Barrier
- 1610.08 Concrete Barrier
- 1610.09 Special-Use Barriers
- 1610.10 Bridge Traffic Barriers
- 1610.11 Other Barriers
- 1610.12 Documentation

Chapter 1620 Impact Attenuator Systems

- 1620.01 General
- 1620.02 Design Criteria
- 1620.03 Selection
- 1620.04 Impact Attenuator Systems
- 1620.05 Documentation

Division 17 – Roadside Facilities

Chapter 1710 Safety Rest Areas and Traveler Services

- 1710.01 General
- 1710.02 References
- 1710.03 Definitions
- 1710.04 Safety Rest Area Project Team
- 1710.05 Location, Access, and Site Design
- 1710.06 Buildings
- 1710.07 Utilities
- 1710.08 Documentation

Chapter 1720 Weigh Sites

- 1720.01 General
- 1720.02 Definitions
- 1720.03 Planning, Development, and Responsibilities
- 1720.04 Permanent Facilities
- 1720.05 Portable Facilities
- 1720.06 Shoulder Sites
- 1720.07 Federal Participation
- 1720.08 Procedures
- 1720.09 Documentation

Glossary

110-1	Design Documentation Sequence for a Typical Design-Build Project
210-1	Types of Public Hearings
210-2	Public Hearing Formats
210-3	Prehearing Packet Checklist
210-4	Sequence for Corridor, Design, and Environmental Hearings
210-5	Sequence for Limited Access Hearing
210-6	Hearing Summary Approvals
300-1	Design Approval Level
300-2	Approvals
300-3	PS&E Process Approvals NHS (Including Interstate) and Non-NHS
300-4	Design to Construction Transition Project Turnover Checklist Example
301-1	General Input Form with Listed Performance Objectives
301-2	Design Option Worksheet Showing Example of Life Cycle Cost Assessment
301-3	Excerpts from Olympic Region Review Checklist
305-1	WSDOT Project Management Process
310-1	Seven-Phase Job Plan for VE Studies
310-2	VE Analysis Team Tools
310-3	VERA Process
310-4	Master Deliverables List of Value Engineering Project Elements
310-5	Master Deliverables List of Cost Risk Assessment Project Elements
400-1	Interagency Agreement
400-2	Report of Survey Mark Example
410-1	Monument Documentation Summary
410-2	DNR Permit Application
410-3	DNR Completion Report Form
410-4	Land Corner Record
510-1	Appraisal and Acquisition
520-1	Access Control Vocabulary
530-1a	Full Access Control Limits: Interchange
530-1b	Full Access Control Limits: Interchange
530-1c	Full Access Control Limits: Interchange With Roundabouts
530-1d	Full Access Control Limits: Ramp Terminal With Transition Taper
530-1e	Full Access Control Limits: Single Point Urban Interchange
530-2a	Partial Access Control Limits: At-Grade Intersections
530-2b	Partial Access Control Limits: Roundabout Intersections
530-3a	Modified Access Control Limits: Roundabout Intersections

530-3b	Modified Access Control Limits: Intersections
540-1	Managed Access Highway Class Description
540-2	Minimum Corner Clearance: Distance From Access Connection to Public Road or Street
550-1	Interstate Routes: IJR Content and Review Levels
550-2	Non-Interstate Routes: IJR Content and Review Levels
550-3	Interstate IJR: Process Flow Chart
550-4	Non-Interstate IJR: Process Flow Chart
550-5	Methods and Assumptions Document for IJR: Concurrence Form Example
550-6	IJR: Stamped Cover Sheet Example
610-1	Materials Source Development
620-1	Estimating: Miscellaneous Tables
620-2	Estimating: Hot Mix Asphalt Pavement and Asphalt Distribution Tables
620-3	Estimating: Bituminous Surface Treatment
620-4	Estimating: Base and Surfacing Typical Section Formulae and Example
620-5a	Estimating: Base and Surfacing Quantities
620-5b	Estimating: Base and Surfacing Quantities
620-5c	Estimating: Base and Surfacing Quantities
620-5d	Estimating: Base and Surfacing Quantities
620-5e	Estimating: Base and Surfacing Quantities
620-5f	Estimating: Base and Surfacing Quantities
620-5g	Estimating: Base and Surfacing Quantities
620-5h	Estimating: Base and Surfacing Quantities
630-1	Selection Criteria for Geotextile Class
630-2	Maximum Sheet Flow Lengths for Silt Fences
630-3	Maximum Contributing Area for Ditch and Swale Applications
630-4	Design Process for Drainage and Erosion Control: Geotextiles and Nonstandard Applications
630-5	Design Process for Separation, Soil Stabilization, and Silt Fence
630-6	Examples of Various Geosynthetics
630-7	Geotextile Application Examples
630-8	Definition of Slope Length
630-9	Definition of Ditch or Swale Storage Length and Width
630-10	Silt Fences for Large Contributing Area
630-11	Silt Fence End Treatment
630-12	Gravel Check Dams for Silt Fences
700-1	Determination of the Roles and Responsibilities for Projects With Structures: Project Development Phase
710-1	Structure Site Plan Scales
710-2	Structure Site Data Checklist
720-1	Phased Development of Multilane Divided Highways

Exhibits

720-2	Highway Structure Over Railroad
720-3	Bridge Vertical Clearances
720-4	Embankment Slope at Bridge Ends
730-1	Summary of Mechanically Stabilized Earth (MSE) Gravity Wall/Slope Options Available
730-2	Summary of Prefabricated Modular Gravity Wall Options Available
730-3	Summary of Rigid Gravity and Semigravity Wall Options Available
730-4	Summary of Nongravity Wall Options Available
730-5	Summary of Anchored Wall Options Available
730-6	Other Wall/Slope Options Available
730-7	Typical Mechanically Stabilized Earth Gravity Walls
730-8	Typical Prefabricated Modular Gravity Walls
730-9	Typical Rigid Gravity, Semigravity Cantilever, Nongravity Cantilever, and Anchored Walls
730-10	Typical Rockery and Reinforced Slopes
730-11	MSE Wall Drainage Detail
730-12	Retaining Walls With Traffic Barriers
730-13a	Retaining Wall Design Process
730-13b	Retaining Wall Design Process: Proprietary
740-1	Standard Noise Wall Types
1010-1	General Lane Closure Work Zone Capacity
1010-2	Minimum Work Zone Clear Zone Distance
1010-3	Transportation Management Plan Components Checklist
1020-1	Reflective Sheeting Requirements for Overhead Signs
1020-2	Timber Posts
1020-3	Wide Flange Steel Posts
1020-4	Laminated Wood Box Posts
1030-1	Pavement Marking Material Guide
1030-2	Guidepost Placement
1040-1a	Freeway Lighting Applications
1040-1b	Freeway Lighting Applications
1040-1c	Freeway Lighting Applications
1040-2	Freeway Ramp Terminals
1040-3	Ramp With Meter
1040-4	Vacant
1040-5	HOT (High-Occupancy Toll) Lane Enter/Exit Zone
1040-6	Lane Reduction
1040-7	Vacant
1040-8a	Intersection With Left-Turn Channelization: Divided Highway
1040-8b	Intersections With Left-Turn Channelization
1040-9	Vacant

1040-10	Intersections With Traffic Signals
1040-11	Intersection Without Channelization
1040-12	Roundabout
1040-13	Railroad Crossing With Gates or Signals
1040-14	Midblock Pedestrian Crossing
1040-15	Transit Flyer Stop
1040-16	Major Parking Lot
1040-17	Minor Parking Lot
1040-18	Truck Weigh Site
1040-19	Safety Rest Area
1040-20	Chain-Up/Chain-Off Parking Area
1040-21	Vacant
1040-22	Bridge Inspection Lighting System
1040-23	Traffic Split Around an Obstruction
1040-24	Construction Work Zone and Detour
1040-25	Light Levels and Uniformity Ratios
1050-1	Systems Engineering Process (“V” Diagram)
1050-2	Intelligent Transportation Systems (ITS) Systems Engineering Analysis Worksheet
1050-3	FHWA Washington Division – ITS Project Contracting Guidance
1100-1	Practical Design Procedural Flowchart Where Basis of Design is Needed
1100-2	Basis of Design Flowchart
1102-1	Context Identification Procedures
1102-2	Key Land Use Characteristics
1102-3	Key Transportation Characteristics
1102-4	Network Connectivity Comparison
1103-1	WSDOT Design Controls
1103-2	Key Context Characteristics and Modal Compatibility
1103-3	Modal Compatibility Assessment Example
1103-4	Speed Transition Segment Example
1103-5	Geometric Traffic Calming Treatments and Considerations
1103-6	Roadside, Streetside, and Pavement-Oriented Traffic Calming Treatments
1105-1	Required Design Elements
1210-1	Maximum Angle Without Curve
1210-2a	Alignment Examples
1210-2b	Alignment Examples
1210-2c	Alignment Examples
1220-1	Grade Length
1220-2a	Coordination of Horizontal and Vertical Alignments
1220-2b	Coordination of Horizontal and Vertical Alignments

1220-2c	Coordination of Horizontal and Vertical Alignments
1220-3	Grading at Railroad Crossings
1230-1	State and City Jurisdictional Responsibilities
1230-2a	Pedestrian-Oriented Example Cross Section
1230-2b	Pedestrian-Oriented Example Cross Section
1230-3a	Bicycle-Oriented Example Cross Section for Intermediate-Speed Locations
1230-3b	Bicycle-Oriented Example Cross Section for Low-Speed Locations
1230-4a	Transit-Oriented Cross Section Transit Boulevard
1230-4b	Transit-Oriented Cross Section
1230-4c	Transit-Oriented Cross Section Hard Running Shoulder
1230-5a	Motorized Vehicle-Oriented Cross Section
1230-5b	Motorized Vehicle-Oriented Cross Section
1230-5c	Motorized Vehicle-Oriented Cross Section
1230-6a	Complete Street – High-Speed Example Cross Section
1230-6b	Complete Street – Intermediate-Speed Example Cross Section
1230-6c	Complete Street – Low- to Intermediate-Speed Multiway Boulevard Example Cross Section
1230-6d	Complete Street – Low-Speed Main Street Example Cross Section
1230-7	Shoulder Functional Uses and Width Considerations
1230-8a	Shoulder Details
1230-8b	Shoulder Details
1230-9a	Roadway Sections in Rock Cuts: Design A
1230-9b	Roadway Sections in Rock Cuts: Design B
1230-10	Stepped Slope Design
1230-11	Drainage Ditch Details
1230-12a	Bridge End Slopes
1230-12b	Bridge Side Slope Details
1230-13	High- to Intermediate-Speed Median Functions and Guidance
1230-14a	Divided Highway Median Sections
1230-14b	Divided Highway Median Sections
1230-14c	Divided Highway Median Sections
1230-15	Low- to Intermediate-Speed Median Functions and Guidance
1240-1a	Traveled Way Width for Two-Lane Two-Way Turning Roadways
1240-1b	Traveled Way Width for Two-Lane Two-Way Turning Roadways: Based on the Delta Angle
1240-2a	Traveled Way Width for Two-Lane One-Way Turning Roadways
1240-2b	Traveled Way Width for Two-Lane One-Way Turning Roadways: Based on the Delta Angle
1240-3a	Traveled Way Width for One-Lane Turning Roadways
1240-3b	Traveled Way Width for One-Lane Turning Roadways: Based on the Delta Angle,

	Radius on Outside Edge of Traveled Way
1240-3c	Traveled Way Width for One-Lane Turning Roadways: Based on the Delta Angle, Radius on Inside Edge of Traveled Way
1250-1	Minimum Radius for Normal Crown Section
1250-2	Minimum Radius for Existing Curves
1250-3	Side Friction Factor
1250-4a	Superelevation Rates (10% Max)
1250-4b	Superelevation Rates (8% Max)
1250-4c	Superelevation Rates (6% Max)
1250-5	Superelevation Rates for Intersections and Low-Speed Urban Roadways
1250-6a	Superelevation Transitions for Highway Curves
1250-6b	Superelevation Transitions for Highway Curves
1250-6c	Superelevation Transitions for Highway Curves
1250-6d	Superelevation Transitions for Highway Curves
1250-6e	Superelevation Transitions for Highway Curves
1250-7a	Superelevation Transitions for Ramp Curves
1250-7b	Superelevation Transitions for Ramp Curves
1260-1	Design Stopping Sight Distance
1260-2	Design Stopping Sight Distance on Grades
1260-3	Stopping Sight Distance on Grades
1260-4	Stopping Sight Distance: Crest Vertical Curves
1260-5	Sight Distance: Crest Vertical Curve
1260-6	Stopping Sight: Distance for Sag Vertical Curves
1260-7	Sight Distance: Sag Vertical Curve
1260-8	Horizontal Stopping Sight Distance
1260-9	Sight Distance: Horizontal Curves
1260-10	Sight Distance: Overlapping Horizontal and Crest Vertical Curves
1260-11	Existing Stopping Sight Distance
1260-12	Passing Sight Distance
1260-13	Passing Sight Distance: Crest Vertical Curve Calculation
1260-14	Passing Sight Distance: Crest Vertical Curves
1260-15	Decision Sight Distance
1270-1	Climbing Lane Example
1270-2a	Speed Reduction Warrant: Performance for Trucks
1270-2b	Speed Reduction Warrant Example
1270-3	Auxiliary Climbing Lane
1270-4	Passing Lane Example
1270-5	Length of Passing Lanes
1270-6	Passing Lane Configurations
1270-7	Buffer Between Opposing Passing Lanes

Exhibits

1270-8	Auxiliary Passing Lane
1270-9	Emergency Escape Ramp Example
1270-10	Emergency Escape Ramp Length
1270-11	Rolling Resistance (R)
1270-12	Typical Emergency Escape Ramp
1270-13	Chain Up/Chain Off Area
1300-1	Intersection Design Areas
1300-2	RCUT Intersection US23, North Carolina
1310-1	Lane Alignment Taper Rate
1310-2	Ramp Terminal Intersection Details
1310-3	Median at Two-Way Ramp Terminal
1310-4	Intersection Balance Example
1310-5	Diamond Interchange With Advance Storage
1310-6	Initial Ranges for Right-Turn Corner (Simple Curve-Taper)
1310-7a	Left-Turn Storage Guidelines: Two-Lane, Unsignalized
1310-7b	Left-Turn Storage Guidelines: Four-Lane, Unsignalized
1310-8a	Left-Turn Storage Length: Two-Lane, Unsignalized (40 mph)
1310-8b	Left-Turn Storage Length: Two-Lane, Unsignalized (50 mph)
1310-8c	Left-Turn Storage Length: Two-Lane, Unsignalized (60 mph)
1310-9	Left-Turn Storage With Trucks (ft)
1310-10a	Median Channelization: Widening
1310-10b	Median Channelization: Median Width 11 ft or More
1310-10c	Median Channelization: Median Width 23 ft to 26 ft
1310-10d	Median Channelization: Median Width of More Than 26 ft
1310-10e	Median Channelization: Minimum Protected Storage
1310-10f	Median Channelization: Two-Way Left-Turn Lane
1310-11	Right-Turn Lane Guidelines
1310-12	Right-Turn Pocket and Right-Turn Taper
1310-13	Right-Turn Lane
1310-14	Acceleration Lane
1310-15a	Traffic Island Designs
1310-15b	Traffic Island Designs: Compound Curve
1310-15c	Traffic Island Designs
1310-16	U-Turn Spacing
1310-17	U-Turn Roadway
1310-18	U-Turn Median Openings
1310-19a	Sight Distance at Intersections
1310-19b	Sight Distance at Intersections
1320-1	Suggested Initial Design Ranges

1320-2	Radii-Speed Relationship
1320-3	Intersection Sight Distance
1330-1	Responsibility for Facilities
1330-2	Standard Intersection Movements and Head Numbers
1330-3	Phase Diagrams: Four-Way Intersections
1330-4	Left-Turn Lane Configuration Examples
1330-5	Vacant
1330-6a	Vacant
1330-6b	Vacant
1330-7	Decision Zone Loop Placement
1330-8	Loop Numbering Layout
1330-9	Signal Display Maximum Heights
1330-10	Signal Display Areas
1330-11a	Strain Pole and Foundation Selection Procedure
1330-11b	Strain Pole and Foundation Selection Procedure
1330-12	Strain Pole and Foundation Selection Example
1330-13	Conduit and Conductor Sizes
1330-14a	Traffic Signal Display Placements
1330-14b	Traffic Signal Display Placements
1330-14c	Traffic Signal Display Placements
1330-14d	Traffic Signal Display Placements
1330-14e	Traffic Signal Display Placements
1330-14f	Traffic Signal Display Placements
1340-1	Driveway Design Template SU-30 and Smaller
1340-2	Driveway Design Template SU-30 and Larger
1340-3	Driveway Sight Distance
1350-1	Sight Distance at Railroad Crossing
1350-2	Typical Pullout Lane at Railroad Crossing
1360-1	Basic Interchange Patterns
1360-2	Interchange Spacing
1360-3	Minimum Ramp Connection Spacing
1360-4	Ramp Design Speed
1360-5	Maximum Ramp Grade
1360-6	Ramp Widths
1360-7a	Lane Balance
1360-7b	Lane Balance
1360-8	Main Line Lane Reduction Alternatives
1360-9	Acceleration Lane Length
1360-10	Deceleration Lane Length

1360-11a	Gore Area Characteristics
1360-11b	Gore Area Characteristics
1360-12	Length of Weaving Sections
1360-13a	On-Connection: Single-Lane, Tapered
1360-13b	On-Connection: Single-Lane, Parallel
1360-13c	On-Connection: Two-Lane, Parallel
1360-13d	On-Connection: Two-Lane, Tapered
1360-14a	Off-Connection: Single-Lane, Tapered
1360-14b	Off-Connection: Single-Lane, Parallel
1360-14c	Off-Connection: Single-Lane, One-Lane Reduction
1360-14d	Off-Connection: Two-Lane, Tapered
1360-14e	Off-Connection: Two-Lane, Parallel
1360-15a	Collector-Distributor: Outer Separations
1360-15b	Collector Distributor: Off-Connections
1360-15c	Collector Distributor: On-Connections
1360-16	Loop Ramp Connections
1360-17	Temporary Ramps
1360-18	Interchange Plan
1410-1	Minimum Traveled Way Widths for Articulated Buses
1410-2	Typical HOV Lane Sections
1410-3	Roadway Widths for Two-Lane Ramps With an HOV Lane
1410-4a	Single-Lane Ramp Meter With HOV Bypass
1410-4b	Two-Lane Ramp Meter With HOV Bypass
1410-5a	Enforcement Area: One Direction Only
1410-5b	Enforcement Area: Median
1430-1	Bus Zone Dimensions
1430-2	Pullout for Bus Stop along a Road
1430-3	Bus Stop Pullouts: Arterial Streets
1430-4	Bus Zone and Pullout After Right Turn
1430-5	Bus Stop Accessibility Features
1430-6	Bus Berth Design
1430-7	Design Alternative for a Combination of Bus Berths at a Platform
1510-1	Pedestrian Circulation Paths
1510-2	Relationship Between Pedestrian Circulation Paths and Pedestrian Access Routes
1510-3	Obstructed Pedestrian Access Route
1510-4	Beveling Options
1510-5	Surface Discontinuities (Noncompliant)
1510-6	Sidewalks With Buffers
1510-7	Typical Sidewalk Designs

1510-8	Typical Driveways
1510-9	Perpendicular Curb Ramp
1510-10	Perpendicular Curb Ramp Common Elements
1510-11	Parallel Curb Ramp
1510-12	Parallel Curb Ramp Common Elements
1510-13	Combination Curb Ramp
1510-14	Typical Curb Ramp Drainage
1510-15	Unmarked Crosswalks
1510-16	Marked Pedestrian Crossing
1510-17	Vacant
1510-18	Midblock Pedestrian Crossing
1510-19	Obstructed Line of Sight at Intersection
1510-20	Improved Line of Sight at Intersection
1510-21	Curb Extension Examples
1510-22	Raised Islands With Curb Ramps and Pedestrian Cut-Throughs
1510-23	Typical Pedestrian Pushbutton
1510-24	Clear Space Parallel and Forward Approach Orientation
1510-25	Accessible Pedestrian Signal Pushbutton Stations
1510-26	Pedestrian Railroad Crossings
1510-27	Pedestrian Railroad Warning Device
1510-28	Pedestrian Bridges
1510-29	Pedestrian Tunnel
1510-30	Access Ramp With Accessible Handrails
1510-31	Work Zones and Pedestrian Facilities
1515-1	Shared-Use Path
1515-2	Bicycle Design Speeds
1515-3	Two-Way Shared-Use Path: Independent Alignment
1515-4a	Two-Way Shared-Use Path: Adjacent to Roadway (≤ 35 mph)
1515-4b	Two-Way Shared-Use Path: Adjacent to Roadway (> 35 mph)
1515-4c	Two-Way Shared-Use Path: Attached to Roadway (>35 mph)
1515-5	Shared-Use Path Side Slopes and Railing
1515-6	Shared-Use Path Landing Profile
1515-7	Shared-Use Path Landing and Rest Area
1515-8	Typical Redesign of a Diagonal Midblock Crossing
1515-9	Adjacent Shared-Use Path Intersection
1515-10	Roadway Crossing Refuge Area
1515-11	Shared-Use Path Bridge and Approach Walls
1515-12	Bridge and Pedestrian Rail
1515-13	Shared-Use Path in Limited Access Corridor

1515-14a	Stopping Sight Distance for Downgrades
1515-14b	Stopping Sight Distance for Upgrades
1515-15	Minimum Lengths for Crest Vertical Curves
1515-16	Lateral Clearance for Horizontal Curves
1520-1	Raised and Curb-Separated Bike Facility
1520-2	Separated Buffered Bike Lane
1520-3	Buffered Bike Lane
1520-4	Bike Lane
1520-5	Shared Lane Markings
1520-6a	Bicycle Facility Selection Chart – Interested, but Concerned Cyclists
1520-6b	Bicycle Facility Selection Chart – Confident Cyclists
1520-7	Bike Box and Intersection Crossing Markings
1520-8	Two-Stage Left-Turn Queue Box
1520-9	Approach Through Lanes
1520-10	Median Refuge Island for Cyclists
1520-11	Length of Solid Green Pavement Marking Preceding Conflict Area
1520-12	At-Grade Railroad Crossings
1520-13	Barrier Adjacent to Bicycle Facilities
1520-14a	Bike Facility Crossing On and Off Ramps
1520-14b	Bicycle Facility Crossing Single Lane On Ramp
1520-14c	Bicycle Facility Crossing Option for Dual Lane On-Ramp Configuration
1520-14d	Bicycle Facility Crossing Option for Dual Off-Ramp
1600-1	City and State Responsibilities and Jurisdictions
1600-2	Design Clear Zone Distance Table
1600-3	Design Clear Zone Inventory Form (# 410-026 EF)
1600-4	Recovery Area
1600-5	Design Clear Zone for Ditch Sections
1600-6	Guidelines for Embankment Barrier
1600-7	Mailbox Location and Turnout Design
1600-8	Glare Screens
1610-1	Type 7 Bridge Rail Upgrade Criteria
1610-2	Longitudinal Barrier Deflection
1610-3	Longitudinal Barrier Flare Rates
1610-4	Traffic Barrier Locations on Slopes
1610-5	Old Type 3 Anchor
1610-6	Guardrail Connections
1610-7	Concrete Barrier Shapes
1610-8	Concrete Barrier Placement Guidance: Assessing Impacts to Wildlife
1610-9	Transitions and Connections

1610-10a	Barrier Length of Need on Tangent Sections
1610-10b	Barrier Length of Need
1610-10c	Barrier Length of Need on Curves
1610-10d	W-Beam Guardrail Trailing End Placement for Divided Highways
1610-11	Beam Guardrail Post Installation
1610-12a	Beam Guardrail Terminals
1610-12b	Beam Guardrail Terminals
1610-13a	Single Cable Barrier Placement Locations on Median Slopes
1610-13b	Cable Barrier Locations on Shoulder Slopes
1610-13c	Cable Barrier Placement for Divided Highways
1610-14	Thrie Beam Rail Retrofit Criteria
1620-1a	Impact Attenuator System Comparison
1620-1b	Impact Attenuator Systems: Universal TAU II and QuadGuard Configurations
1620-2	Impact Attenuator Distance Beyond Length of Need
1710-1	WSDOT Safety Rest Area
1710-2	WSDOT's SRA Project and Programming Roles
1710-3	Additional Safety Rest Area Resources
1710-4	Roadside Facilities Level of Development
1710-5	Typical Truck Storage
1710-6	WSDOT Safety Rest Area Building – Adaptive Reuse Historic Preservation
1720-1	Truck Weigh Site: Multilane Highways
1720-2	Truck Weigh Site: Two-Lane Highways
1720-3	Vehicle Inspection Installation
1720-4	Minor Portable Scale Site
1720-5	Major Portable Scale Site
1720-6	Small Shoulder Site
1720-7	Large Shoulder Site
1720-8	MOU Related to Vehicle Weighing and Equipment: Inspection Facilities on State Highways

- 100.01 Purpose
- 100.02 Presentation and Revisions
- 100.03 Practical Solutions
- 100.04 Manual Applications
- 100.05 Manual Use
- 100.06 Manual Organization

100.01 Purpose

The Washington State Department of Transportation (WSDOT) has developed the *Design Manual* to reflect policy, outline a uniformity of methods and procedures, and communicate vital information to its employees and others who develop projects on state highways. When properly used, the manual will facilitate the development of a highway system consistent with the needs of the multimodal traveling public.

WSDOT designers are required to comply with the *Design Manual*. The Federal Highway Administration (FHWA) has agreed to approve designs that follow guidance in the *Design Manual*; therefore, adherence to the guidance presented is not optional for state highway projects.

The information, guidance, and references contained herein are not intended as a substitute for sound engineering judgment. The *Design Manual* is not a comprehensive textbook on highway engineering, nor does it attempt to cover all the possible scenarios Washington's highways present. It is recognized that some situations encountered are beyond the scope of this presentation.

If you have design questions not answered by the *Design Manual*, contact the Headquarters (HQ) Design Office.

100.02 Presentation and Revisions

The *Design Manual* is available on the Internet. It can be accessed through the:

- WSDOT Home Page:
www.wsdot.wa.gov/
- Design Policy Web Page:
www.wsdot.wa.gov/design/policy/
- Active *Design Manual* Revisions Web Page:
www.wsdot.wa.gov/design/manual/activerevisions.htm
- Publications Services Web Page:
www.wsdot.wa.gov/publications/manuals/index.htm

The online version of the manual enables you to conduct a word search of the entire manual. Opening an individual chapter is faster, but a word search is limited to that chapter.

The *Design Manual* is continually revised to reflect changing processes, procedures, regulations, policies, and organizations. Feedback from users is encouraged to improve the manual for everyone. Comments may be submitted by any method that is convenient for you. There is a comment form in the front of the manual, or comments may be made via the contact names on the Design Policy Internet page (see link above). Note that the Design Policy Internet page includes a link to an errata page, which provides a list of known technical errors in the manual. Manual users are encouraged to view this page on a regular basis.

A contents section lists all chapters and the major headings of the sections/pages. The exhibits section lists all the exhibits in the manual.

Most chapters include a list of references, including laws, administrative codes, manuals, and other publications, which are the basis for the information in the chapter. The definitions for terms used in the *Design Manual* are found in the [Glossary](#).

100.03 Practical Solutions

Practical Solutions is a two-part strategy that includes least cost planning and practical design, which WSDOT defines in [Executive Order E 1090](#).

WSDOT deploys this strategy to enable more flexible and sustainable transportation investment decisions. It encourages this by: (1) increasing the focus on addressing identified performance gaps (needs) throughout all phases of development, and (2) engaging local stakeholders at the earliest stages of scope definition to ensure their input is included at the right stage of the solution development process. Practical Solutions includes one or a combination of strategies, including, but not limited to, operational improvements, off-system solutions, transportation demand management, and incremental strategic capital solutions. (See [Chapter 1100](#) for more information.)

100.04 Manual Applications

Design Manual guidance is provided to encourage the statewide uniform application of design details under normal conditions. It also guides designers through the project development process used by WSDOT. The *Design Manual* is used by the department to:

- Interpret current design principles, including American Association of State Highway and Transportation Officials (AASHTO) and other appropriate policy sources, findings, and federal and state laws.
- Develop projects that address modal and community performance needs.
- Balance the competing performance needs of highway construction projects.
- Design for low-cost solutions.

The *Design Manual* is designed to allow for flexibility in design for specific and unusual situations. For unusual circumstances, the manual provides mechanisms for documenting the reasons for the choices made.

The *Design Manual* is developed for use on Interstate and state highways and may not be suitable for projects on county roads or city streets.

100.05 Manual Use

The WSDOT *Design Manual* is intended to be used for design of department-owned facilities, especially the transportation facilities associated with state highways as designated by [RCW 47.17](#).

For state highway routes, projects are designed using the *Design Manual* practical design approach (see [Chapter 1100](#) and Division 11). If WSDOT guidance is not used on a project, appropriate documentation and approvals are required (see Chapters [300](#) and [1100](#)).

When WSDOT designs facilities that will be turned over to local jurisdictions, those facilities are to be designed using appropriate local geometric design criteria.

When local jurisdictions design any element of state highway facilities, the *Design Manual* must be used. Local jurisdictions are free to adopt this manual for their local criteria or to develop their own specialized guidance for facilities not on state highway routes.

100.06 Manual Organization

The *Design Manual* is divided into a series of divisions that address a portion of the project development and design processes. The divisions are composed of chapters that address the general topic in detail and are, in some cases, specific to a particular discipline.

Division 1 – General Information: Presents general background on planning, managing project delivery, project development, and programming.

- **Chapter 100 – Manual Description:** Chapter content/resources within the *Design Manual*.
- **Chapter 110 – Design-Build Projects:** How the *Design Manual* applies to design-build projects: includes terminology and reference to design-build contract documents.

Division 2 – Hearings, Environmental, and Permits: Provides the designer with information about the public involvement and hearings process, the environmental documentation process, and the permit process.

- **Chapter 210 – Public Involvement and Hearings:** Developing a project-specific public involvement plan; the ingredients of an effective public involvement plan; and methods for public involvement.
- **Chapter 225 – Environmental Coordination:** Provides a summary of the relevant provisions in the *Environmental Manual*. Gives designers a brief overview and direction to environmental resources.

Division 3 – Project Documentation: Provides designers with information on value engineering, traffic analysis, design documentation, and approvals.

- **Chapter 300 – Design Documentation, Approval, and Process Review:** Building the Project File (PF) and the Design Documentation Package (DDP) and recording the recommendations and decisions that lead to a project by preserving the documents from the planning, scoping, programming, and design phases (includes permits, approvals, contracts, utility relocation, right of way, advertisement and award, and construction). [Links to websites to download documentation templates.](#)

- **Chapter 301 – Design and Maintenance Coordination – Best Practices:** Means and methods for coordinating design with maintenance concerns and needs.
- **Chapter 305 – Managing Projects:** Brief description and links to WSDOT design and project development resources.
- **Chapter 310 – Value Engineering:** A systematic, multidisciplinary process study early in the project design stage to provide recommendations to improve scope, functional design, constructability, environmental impacts, or project cost—required by federal law for high-cost, complex projects.
- **Chapter 320 – Traffic Analysis:** Procedural guidance and general requirements for conducting traffic analyses.
- **Chapter 321 – Sustainable Safety:** Informational and procedural guidance for conducting safety analyses, within the current extent of the applications.

Division 4 – Surveying: Includes criteria for surveying, mapping, and monumentation requirements.

- **Chapter 400 – Surveying and Mapping:** The procedures within WSDOT for project surveying.
- **Chapter 410 – Monumentation:** The requirements and procedures for Monumentation.

Division 5 – Right of Way and Access Control: Provides guidance on right of way considerations; interchange justification reports; limited/managed access; and fencing.

- **Chapter 510 – Right of Way Considerations:** The right of way and easement acquisition process.
- **Chapter 520 – Access Control:** WSDOT Access Control program information.
- **Chapter 530 – Limited Access Control:** Clarification on full, partial, and modified limited access control.
- **Chapter 540 – Managed Access Control:** The classes of managed access highways and the access connection permitting process.
- **Chapter 550 – Interchange Justification Report:** The process for access point revisions on limited access controlled highways and the steps for producing an interchange justification report.
- **Chapter 560 – Fencing:** The purpose of fencing, types of fencing, and fencing design criteria.

Division 6 – Soils and Paving: Presents guidance for investigating soils, rock, and surfacing materials; estimating tables; and guidance and criteria for the use of geosynthetics.

- **Chapter 610 – Investigation of Soils, Rock, and Surfacing Materials:** The requirements for qualifying a materials source, geotechnical investigations, and the documentation to be included in the Project File.
- **Chapter 620 – Design of Pavement Structures:** Estimating tables for the design of pavement structures.
- **Chapter 630 – Geosynthetics:** The types/applications of geosynthetic drainage, earthwork, erosion control, and soil reinforcement materials.

Division 7 – Structures: Provides guidance for the design of structures for highway projects, including site data for structures, bridges, retaining walls, and noise walls.

- **Chapter 700 – Project Development Roles and Responsibilities for Projects With Structures:** WSDOT’s project development process: roles and responsibilities for projects with structures during the project development phase of a project.
- **Chapter 710 – Site Data for Structures:** Information required by the HQ Bridge and Structures Office to provide structural design services.
- **Chapter 720 – Bridges:** Basic design considerations for developing preliminary bridge plans and guidelines on basic bridge geometric features.
- **Chapter 730 – Retaining Walls and Steep Reinforced Slopes:** Design principles, requirements, and guidelines for retaining walls and steep reinforced slopes.
- **Chapter 740 – Noise Barriers:** Factors considered when designing a noise barrier.

Division 8 – Hydraulics: Addresses the issue of hydraulics and serves as a guide to highway designers to identify and consider hydraulic-related factors that may impact the design.

- **Chapter 800 – Hydraulic Design:** Hydraulic considerations for highway projects involving flood plains, stream crossings, channel changes, and groundwater.

Division 9 – Roadside Development: Provides guidance on the portion of state highways between the traveled way and the right of way boundary.

- **Chapter 900 – Roadside Development:** Managing the roadside environment, including the area between the traveled way and the right of way boundary, unpaved median strips, and auxiliary facilities such as rest areas, wetlands, and stormwater treatment facilities.
- **Chapter 950 – Public Art:** Policies and procedures for including public art in state transportation corridors.

Division 10 – Traffic Safety Elements: Introduces the designer to traffic safety elements such as work zone traffic control, signing, delineation, illumination, traffic control signals, and Intelligent Transportation Systems (ITS).

- **Chapter 1010 – Work Zone Safety and Mobility:** Planning, design, and preparation of highway project plans that address work zone safety and mobility requirements.
- **Chapter 1020 – Signing:** The use of signing to regulate, warn, and guide motorists.
- **Chapter 1030 – Delineation:** The use of pavement markings to designate safe traffic movement.
- **Chapter 1040 – Illumination:** Illumination design on state highway construction projects.
- **Chapter 1050 – Intelligent Transportation Systems (ITS):** Applying computer and communication technology to optimize the safety and efficiency of the highway system.

Division 11 – Practical Design: Provides practical design guidance for WSDOT projects.

- **Chapter 1100 – Practical Design:** Includes an overview and description of the WSDOT Practical Solutions initiative, the practical design process, and the relevant chapter information necessary to complete each process step.

- **Chapter 1101 – Need Identification:** Includes guidance on accurate and concise identification of project needs for practical design.
- **Chapter 1102 – Context Identification:** Guidance is presented in two parts: land use context and transportation context.
- **Chapter 1103 – Design Control Selection:** Provides guidance on design controls used in WSDOT projects.
- **Chapter 1104 – Alternatives Analysis:** Discusses how information determined from planning phases and *Design Manual* chapters is utilized in alternative solution formation, and how to evaluate the alternative solutions developed.
- **Chapter 1105 – Design Element Selection:** Provides guidance on selecting design elements for projects.
- **Chapter 1106 – Design Element Dimensions:** Discusses the practical design approach to selecting design element dimensions.
- **Chapter 1120 – Preservation Projects:** Provides scoping links and elements and features to be evaluated in preservation projects.

Division 12 – Geometrics: Covers geometric plan elements; horizontal alignment; lane configurations and pavement transitions; geometric profile elements; vertical alignment; geometric cross sections; and sight distance.

- **Chapter 1210 – Geometric Plan Elements:** The design of horizontal alignment, lane configuration, and pavement transitions.
- **Chapter 1220 – Geometric Profile Elements:** The design of vertical alignment.
- **Chapter 1230 – Geometric Cross Section:** Roadway width and roadside slope design.
- **Chapter 1240 – Turning Roadways:** Widening curves to make the operating conditions comparable to those on tangent sections.
- **Chapter 1250 – Superelevation:** Superelevating curves and ramps so design speeds can be maintained.
- **Chapter 1260 – Sight Distance:** Stopping, passing, and decision sight distance design elements.
- **Chapter 1270 – Auxiliary Lanes:** Auxiliary facilities such as climbing lanes, passing lanes, slow-vehicle turnouts, shoulder driving for slow vehicles, emergency escape ramps, and chain-up areas.

Division 13 – Intersections and Interchanges: Addresses the design considerations of at-grade intersections, roundabouts, road approaches, railroad grade crossings, and traffic interchanges.

- **Chapter 1300 – Intersection Control Type:** Guidance on preliminary intersection analysis and selection of control type.
- **Chapter 1310 – Intersections:** Designing intersections at grade, including at-grade ramp terminals.
- **Chapter 1320 – Roundabouts:** Guidance on the design of roundabouts.

- **Chapter 1330 – Traffic Control Signals:** The use of power-operated traffic control devices that warn or direct traffic.
- **Chapter 1340 – Driveways:** The application and design of road approaches on state highways.
- **Chapter 1350 – Railroad Grade Crossings:** The requirements for highways that cross railroads.
- **Chapter 1360 – Traffic Interchanges:** The design of interchanges on interstate highways, freeways, and other multilane divided routes.
- **Chapter 1370 – Median Crossovers:** Guidance on locating and designing median crossovers for use by maintenance, traffic service, emergency, and law enforcement vehicles.

Division 14 – HOV and Transit: Provides design guidance on HOV lanes and transit facilities.

- **Chapter 1410 – High-Occupancy Vehicle Facilities:** Evaluating and designing high-occupancy vehicle (HOV) facilities.
- **Chapter 1420 – HOV Direct Access:** Design guidance on left-side direct access to HOV lanes and transit facilities.
- **Chapter 1430 – Transit Facilities:** Operational guidance and information for designing transit facilities such as park & ride lots, transfer/ transit centers, and bus stops and pullouts.

Division 15 – Pedestrian and Bicycle Facilities: Provides guidance on pedestrian and bicycle facility design.

- **Chapter 1510 – Pedestrian Facilities:** Designing facilities that encourage efficient pedestrian access that meets ADA.
- **Chapter 1515 – Shared-Use Paths:** Guidance that emphasizes pedestrians are users of shared-use paths and accessibility requirements apply in their design.
- **Chapter 1520 – Roadway Bicycle Facilities:** Selecting and designing useful and cost-effective bicycle facilities.

Division 16 – Roadside Safety Elements: Addresses design considerations for the area outside the roadway, and includes clear zone, roadside hazards, safety mitigation, traffic barriers, and impact attenuator systems.

- **Chapter 1600 – Roadside Safety:** Clear zone design, roadside hazards to consider for mitigation, and some roadside safety features.
- **Chapter 1610 – Traffic Barriers:** Design of traffic barriers based on the design levels identified in the design matrices.
- **Chapter 1620 – Impact Attenuator Systems:** Permanent and work zone impact attenuator systems.

Division 17 – Roadside Facilities: Provides design guidance for the area outside the roadway, including rest areas and truck weigh sites.

- **Chapter 1710** – Safety Rest Areas and Traveler Services: Typical layouts for safety rest areas.
- **Chapter 1720 – Weigh Sites:** Guidance on designing permanent, portable, and shoulder-sited weigh sites.

- [110.01 General](#)
- [110.02 Terminology and Language Used](#)
- [110.03 Design and Documentation Responsibility](#)
- [110.04 References](#)

110.01 General

This chapter emphasizes that the *Design Manual* applies to the delivery methods of all Washington State Department of Transportation (WSDOT) capital projects, including design-build projects. Certain terms are defined to coincide with WSDOT design-build project delivery; however, it is beyond the scope of this manual to extensively define design-build projects. Design-build projects are based on their own contractual documents (such as a Request for Proposal), which present directive language intended to legally define the project and identify requirements and controls, roles and responsibilities, and procedures and outcomes.

Design-build is a method of project delivery in which WSDOT executes a single contract with one entity (the design-builder) for design and construction services to provide a finished product. In a traditional WSDOT design-bid-build contract, the design process is completed independent of the construction contract. Under WSDOT policy, the Basis of Design (see Chapters [1100](#) and [300](#)) is approved prior to issuing an RFP.

Delivering a project using design-build contracting eliminates *very few steps* when compared to the typical WSDOT design-bid-build process. The same project work tasks and products are normally required whether performed by WSDOT or the design-builder. The timing, order, and level of task detail performed are what make design-build contracting different than design-bid-build. The design-build process may shift many tasks and responsibilities from WSDOT to the design-builder depending on the project's scope/risk analysis. The shift changes the order and development detail of the tasks and thus must be reflected in the process through contractual documents.

According to state law, to be considered for design-build designation in Washington State, a project must be greater than \$2 million and provide the opportunity for one of the following:

- Highly specialized construction activities requiring significant input into the design.
- Greater innovation and efficiencies between the designer and the builder.
- Significant savings in project delivery time.

110.02 Terminology and Language Used

110.02(1) *Application of Terminology*

Several terms are encountered throughout the *Design Manual* that are not normally applicable to design-build project delivery. They are expanded in this chapter to provide appropriate meaning for design-build projects and design-build personnel. It is intended that design-build personnel acknowledge these expanded meanings and apply them throughout the manual, which will eliminate the need to restate them each time they are encountered.

design-builder The firm, partnership, joint venture, or organization that contracts with WSDOT to perform the work.

designer This term applies to WSDOT design personnel. Wherever “designer” appears in this manual, design-build personnel shall deem it to mean: Engineer of Record, Design Quality Assurance Manager, design-builder, or any other term used in the design-build contract to indicate design-build personnel responsible for the design elements of a design-build project, depending on the context of information being conveyed.

Project Engineer This term applies to WSDOT personnel. Wherever “Project Engineer” appears in this manual, the design-builder shall deem it to mean “Engineer of Record.”

Request for Proposal (RFP) The document package issued by WSDOT requesting submittal of proposals for the project and providing information relevant to the preparation and submittal of proposals, including the instructions to proposers, contract documents, bidding procedures, and reference documents.

Additional terms are presented in the *Design Manual* [Glossary](#).

110.02(2) Language Used for Design Flexibility

The *Design Manual* is primarily written for WSDOT engineering personnel; however, design-builders, local agencies, and developers also use it for state and local agency projects. Under WSDOT practical design, flexibility is encouraged to develop independent designs tailored to context and identified performance need. (See chapters in the 1100 series for more information about practical design policy and guidance.)

With the exclusion of this chapter, the *Design Manual* is intentionally written to avoid or minimize the use of directive words like “shall” and “should” in order to retain this important flexibility for the larger set of users.

In the case of design-build projects, design flexibility applies to the extent allowed by the contract. The design-builder shall refer to the project-specific RFP for design guidance. The RFP will identify design decisions and provide technical specifications relating to the project’s design.

110.03 Design and Documentation Responsibility

In the traditional design-bid-build format, WSDOT bears the entire responsibility and risk for any design-related issues. As the owner, all responsibility for design decisions and conformance to standards rests with WSDOT.

For design-build projects, many design responsibilities shift to the design-builder once the Notice to Proceed is issued. WSDOT is still responsible for establishing the scope, performance measurements, and existing conditions of the site as part of preliminary design. Any preliminary design done by WSDOT would be filed and documented in the Design Documentation Package (DDP) and/or the Project File (PF), which are provided to the selected design-builder to maintain throughout the design-build project design phase and then returned to WSDOT for retention.

It is important to note that the design content presented in this manual has valid application based not on delivery method, but on practical design procedures and specified needs such as roadway and land use context, traffic volumes, and identified performance needs, as presented in Chapter 1100 (and other chapters).

It is also important to specify that design documentation is a requirement for WSDOT projects, regardless of delivery method. WSDOT still holds the valid requirement to have an organized design documentation file and as-constructed plans for future reference after the project is built.

Plan accuracy, conformance with established design guidelines, and constructability of the project rests with the design-builder.

The DDP and the PF include all the elements identified in the project RFP. The RFP specifies various DDP and PF submittals to WSDOT, identifying how each item will be submitted (report, plan sheet element, Basis of Design and design parameter element, and so on) and who is responsible for the development status (such as *complete*, *in progress*, or *not started*) of each item. The RFP also indicates that some of the DDP and PF items have components that were started by WSDOT and that the design-builder shall complete or update those item(s). It is the design-builder's responsibility to obtain copies of the information from WSDOT for use in completing the DDP and PF items.

The DDP and the PF require retention of original, signed documents—not copies.

The RFP typically specifies that the design-builder shall provide WSDOT with updates to the DDP and PF items throughout construction of the project.

For further guidance on design documentation and WSDOT acceptance thereof, see [Chapter 300](#), the project RFP, and the Design Documentation Checklist.

110.04 References

110.04(1) Design-Build Guidance

The Design-Build Guidance Statements listed below are available at:

www.wsdot.wa.gov/projects/delivery/designbuild/

- Design Quality Control, Quality Assurance, and Quality Verification on Design-Build Projects
- Project Basic Configuration Development
- Use of Reference Documents on Design-Build Projects

Exhibit 110-1 Design Documentation Sequence for a Typical Design-Build Project

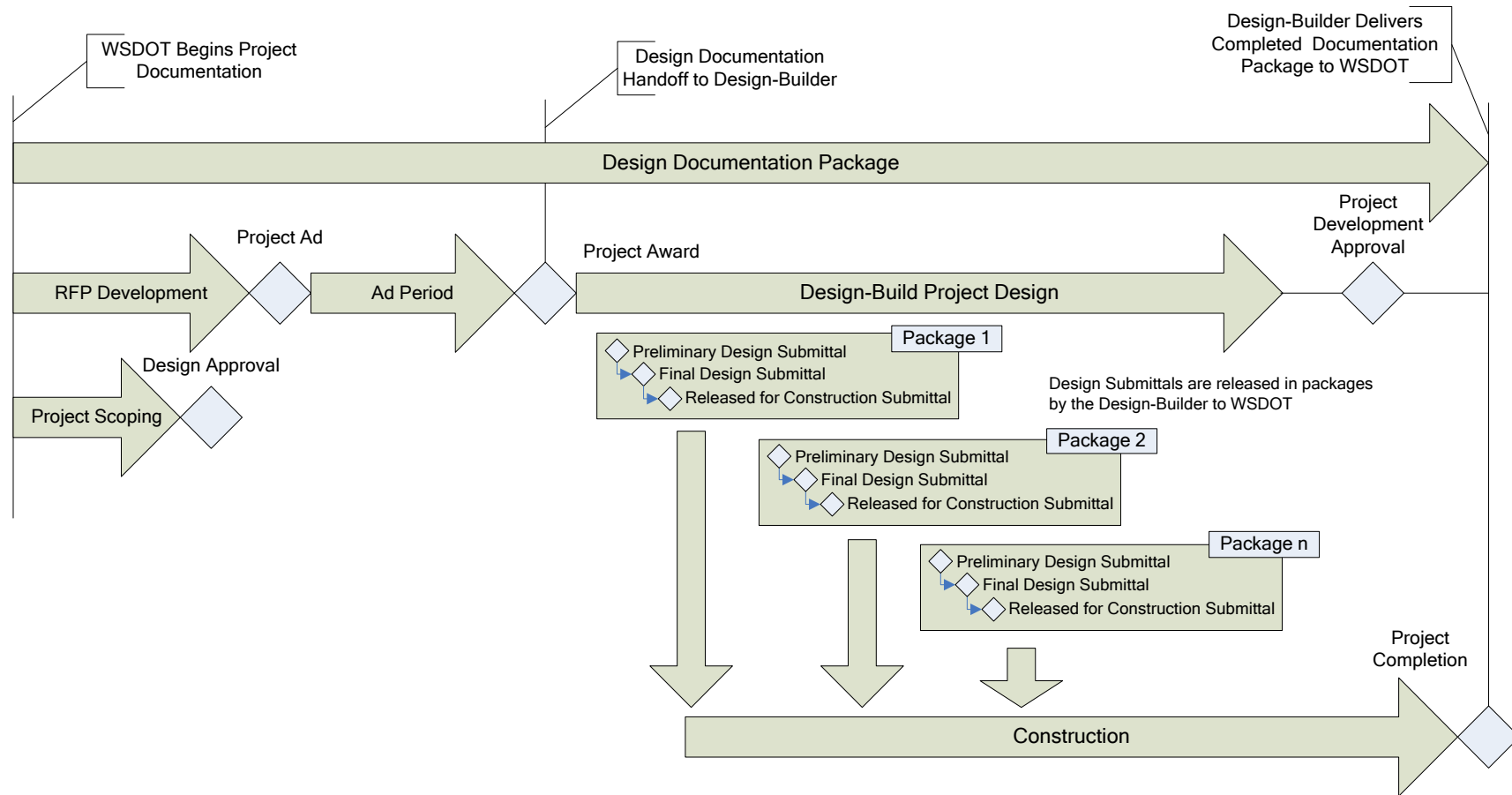

Notes:

- The Design Documentation Package (DDP) is started by WSDOT during scoping/pre-RFP design. The design-builder completes the DDP as the project proceeds.
- The design-builder shall refer to the RFP for specific review and approval processes. The RFP will specify procedures for design submittals, including notifications to WSDOT and the time allowed for reviews.
- WSDOT will review design submittals for conformance with requirements of the contract.

- [225.01 General](#)
- [225.02 References](#)
- [225.03 Determining the Environmental Documentation](#)
- [225.04 Identifying the Project Classification](#)
- [225.05 Environmental Commitment File](#)
- [225.06 Environmental Permits and Approvals](#)
- [225.07 Documentation](#)

225.01 General

The term “environmental documentation” refers to the documents produced for a project to satisfy the requirements contained in the National Environmental Policy Act (NEPA) and the State Environmental Policy Act (SEPA). The [Environmental Manual](#) and supporting web pages provide detailed instructions on how to determine what level of documentation is required and how to prepare the documents. This chapter provides a summary of the relevant provisions in the *Environmental Manual*.

The purpose of the environmental document is to provide decision makers, agencies, and the public with information on a project’s environmental impacts, alternatives to the proposed action, and mitigation measures to reduce unavoidable impacts. Final environmental documents identify and evaluate the project to be constructed. Because projects vary in their level of environmental impacts, the rules on environmental documentation allow for different levels of documentation. As a project’s impacts increase, so does the level of documentation.

The region Environmental Office and the NEPA/SEPA Compliance Section of the Headquarters Environmental Services Office routinely provide environmental documentation assistance to designers and project engineers.

225.02 References

225.02(1) Federal/State Laws and Codes

- [42 United States Code \(USC\) 4321](#), National Environmental Policy Act of 1969 (NEPA)
- [23 Code of Federal Regulations \(CFR\) Part 771](#), Environmental Impact and Related Procedures
- [23 CFR Part 774](#); [49 USC Section 303](#), Policy on Lands, Parks, Recreation Areas, Wildlife and Waterfowl Refuges, and Historic Sites
- [36 CFR Part 800](#), Protection of Historic and Cultural Properties
- [40 CFR Parts 1500-1508](#), Council for Environmental Quality Regulations for Implementing NEPA
- [Chapter 43.21C Revised Code of Washington \(RCW\)](#), State Environmental Policy Act (SEPA)
- [Chapter 197-11 Washington Administrative Code \(WAC\)](#), SEPA Rules
- [Chapter 468-12 WAC](#), WSDOT SEPA Rules

225.02(2) WSDOT Environmental Resources

WSDOT region environmental staff

Environmental Permitting webpage:

www.wsdot.wa.gov/environment/permitting/default.htm

Environmental Manual, M 31-11, WSDOT

www.wsdot.wa.gov/publications/manuals/m31-11.htm

225.03 Determining the Environmental Documentation

The Environmental Review Summary (ERS) provides the first indication of what form the environmental documentation will take. The ERS is developed as part of the Project Summary, which is prepared during the scoping phase of all projects in the construction program. The Project Summary (see [Chapter 300](#) for additional information) includes two components:

- Project Definition
- Environmental Review Summary

The ERS is part of the Project Summary database. The ERS describes the potential environmental impacts, proposed mitigation, and necessary permits for a project. It establishes the initial environmental classification and identifies the key environmental elements addressed in the NEPA/SEPA process. The ERS database includes fully integrated “Help” screens. Contact your region Environmental Office or Program Management Office to get set up to work in the database.

The typical process for classifying projects and determining the level of environmental documentation is as follows:

- Once the project has been sufficiently developed to assess any environmental impacts, the region completes the ERS based on the best information available at the scoping phase of development.
- The region Environmental Manager then concurs with the classification by approving the ERS, which enables the completed form to be included in the Project Summary package.
- For NEPA, if a project has been determined to be a Categorical Exclusion (CE), the Environmental Classification Summary/SEPA Checklist (ECS/SEPA Checklist) is completed. The NEPA environmental review process is considered complete when the region Environmental Manager approves the ECS package (guidance is provided in the online Help in the ECS/SEPA Checklist database). If it is determined that a Categorical Exclusion (CE), an Environmental Assessment (EA), or Environmental Impact Statement (EIS) is required, the region evaluates the project schedule and arranges for preparation of the appropriate document.
- For SEPA, the signing and submittal of the ECS/SEPA Checklist completes the environmental classification process. On projects that are categorized as exempt from SEPA, the environmental process is complete unless the project requires consultation under the Endangered Species Act. On projects that do not meet the criteria for a SEPA Categorical Exemption (WACs [197-11-800](#) and [468-12](#)) and require a SEPA checklist ([WAC 197-11-960](#)) or an EIS, those documents are prepared as necessary prior to Project Development Approval.

At this early stage, the ERS allows environmental staff to consider potential impacts and mitigations and required permits. For many projects, the WSDOT Geographic Information System (GIS) Workbench coupled with a site visit provides sufficient information to fill out the ERS (see the GIS Workbench online Help).

For most WSDOT projects, the Federal Highway Administration (FHWA) is the lead agency for NEPA. Other federal lead agencies on WSDOT projects are the U.S. Army Corps of Engineers, Federal Aviation Administration, Federal Railroad Administration, and Federal Transit Administration.

225.04 Identifying the Project Classification

Based on the environmental considerations identified during preparation of the ERS, WSDOT projects are classified for NEPA/SEPA purposes to determine the type of environmental documentation required. Projects with a federal nexus (using federal funds, involving federal lands, or requiring federal approvals or permits) are subject to NEPA and SEPA. Projects that are state funded only, with no federal nexus, follow SEPA guidelines. Since many WSDOT projects are prepared with the intent of obtaining federal funding, NEPA guidelines are usually followed. (See Chapter 300 of the *Environmental Manual* for more information.)

225.05 Environmental Commitment File

As an initial part of project development, the region establishes a project commitment file. Establishment of this file generally coincides with preparation of the environmental documentation. The file consists of proposed mitigation measures; commitments made to regulatory agencies, tribes, and other stakeholders; and other documented commitments made on the project. Further commitment types (right of way, maintenance, and so on) may be added at the region's discretion.

The region Environmental Office is responsible for creating and maintaining the commitment file as a project progresses through its development process. Whenever commitments are made, they are incorporated into project documents and added to the environmental commitment file once they are finalized. Commitments are typically included within, but not limited to, the following documents or approvals and any of their supplements or amendments:

- Memoranda, Agreements, Letters, Electronic Communications
- No-Effect Letters
- Biological Assessments
- Biological Opinions
- Concurrence Letters
- SEPA Checklists
- NEPA Categorical Exclusions
- NEPA Environmental Assessments
- NEPA/SEPA Environmental Impact Statements
- Finding of No Significant Impact (FONSI)
- Record of Decision (ROD)

- Section 106 Concurrence Letter from Tribes and Department of Archaeology & Historic Preservation
- Mitigation Plans
- Environmental Permits and Applications, and Associated Drawings and Plans

Additional information (see [Procedure 490-a](#)) for establishing a commitment file is available online at WSDOT's [Tracking Commitments](#) webpage. WSDOT has a Commitment Tracking System to organize and track commitments from the commitment file. Refer to the [Environmental Manual](#) (Chapter 490) for policies associated with tracking commitments.

225.06 Environmental Permits and Approvals

WSDOT projects are subject to a variety of federal, state, and local environmental permits and approvals. Understanding and anticipating what permits and approvals may be required for a particular project type will assist the designer in project delivery. The [Environmental Permitting](#) website provides guidance on the applicability of permits and approvals. Because the facts of each project vary and the environmental regulations are complex, reliance on either the Design Manual or the [Environmental Manual](#) is insufficient. Consult region environmental staff.

The Environmental Review Summary, which is prepared as part of the Project Summary, identifies some of the most common environmental permits that might be required based on the information known at that stage. As the project design develops, additional permits and approvals can be identified. Conducting project site visits for engineering and environmental features may reduce project delays caused by late discoveries. Coordinate with and communicate any project changes to region environmental staff.

The permit process begins well in advance of the actual permit application. For some permits, WSDOT has already negotiated permit conditions through the use of programmatic and general permits. These permits typically apply to repetitive, relatively simple projects, and the permit conditions apply regardless of the actual facts of the project type. For complex projects, the negotiations with permit agencies often begin during the environmental documentation phase for compliance with the National Environmental Policy Act (NEPA) and the State Environmental Policy Act (SEPA). The mitigation measures developed for the NEPA/SEPA documents are captured as permit conditions on the subsequent permits.

Environmental permits require information prepared during the design phase to demonstrate compliance with environmental rules, regulations, and policies. To avoid delays in project delivery, it is necessary for the designer to understand and anticipate this exchange of information. The timing of this exchange often affects design schedules, while the permit requirements can affect the design itself. In complex cases, the negotiations over permit conditions can result in iterative designs as issues are raised and resolved.

225.07 Documentation

Refer to [Chapter 300](#) for design documentation requirements.

300.01	General
300.02	WSDOT Project Development
300.03	Design Documentation and Records Retention Policy
300.04	Project Design Approvals
300.05	FHWA Oversight and Approvals
300.06	Project Documents and Approvals
300.07	Process Review
300.08	References

300.01 General

This chapter provides the WSDOT design procedures, documentation and approvals necessary to deliver successful projects on the transportation network in Washington, including projects involving the Federal Highways Administration.

This chapter presents critical information for design teams, including:

- WSDOT's Project Development process.
- Design documentation tools, procedures, and records retention policy.
- Major Project approvals including Design Approval, Project Development Approval, Basis of Design, Design Analysis, and other specific project documents for design-bid-build and for design-build delivery methods.
- FHWA oversight and approvals on Projects of Division Interest (PoDI).
- WSDOT and FHWA approvals for non-PoDI projects including Interstate new and reconstruction and other specific documents as shown in the approvals exhibits.
- Information about conducting project process reviews.
- Additional references and resources.

For operational changes and local agency and developer projects on state highways, design documentation is also needed. It is retained by the region office responsible for the project oversight, in accordance with the WSDOT records retention policy. All participants in the design process are to provide the appropriate documentation for their decisions. For more information about these types of projects, see the *Local Agency Guidelines* and *Development Services Manual* available at the Publications Services Index website:

 <http://www.wsdot.wa.gov/Publications/Manuals/index.htm>

For emergency projects, also refer to the *Emergency Relief Procedures Manual*. It provides the legal and procedural guidelines for WSDOT employees to prepare all necessary documentation to respond to, and recover from, emergencies and disasters that affect the operations of the department.

300.02 WSDOT Project Development

In general, the region initiates the development of a specific project by preparing the Project Summary (see [300.06\(1\)](#)). Projects may also be initiated by other WSDOT groups such as the HQ Bridge and Structures Office or the HQ Traffic Office. The project coordination with other disciplines (such as Real Estate Services, Roadside and Site Development, Utilities, and Environmental) is started in the project scoping phase and continues throughout the project's development. The project team coordinates with all parties with an interest including the public, tribes, state and federal agencies, and local agencies as appropriate to provide and obtain information to assist in developing the project.

The Environmental Review Summary (ERS) and the Project Definition (PD) are required for most projects. Exceptions will be identified by the HQ Capital Program Development and Management (CPDM) Office.

The project is developed in accordance with all applicable procedures, Executive Orders, Directives, Instructional Letters, Supplements, and manuals; the Washington State Highway System Plan; approved corridor sketches and planning studies; the FHWA/WSDOT Stewardship and Oversight Agreement; the Project Summary and the Basis of Design.

The region develops and maintains documentation for each project using this chapter and the Project File / Design Documentation Package checklists (see [300.03\(3\)](#))

Refer to the *Plans Preparation Manual* for PS&E documentation. [Exhibit 300-4](#) is an example checklist of recommended items to be turned over to the construction office at the time of project transition. An expanded version is available here:

www.wsdot.wa.gov/design/projectdev/

300.02(1) Environmental Requirements

All projects involving a federal action require National Environmental Policy Act (NEPA) documentation. WSDOT uses the Environmental Review Summary (ERS) portion of Project Summary for FHWA concurrence on the environmental class of action (EIS/EA/CE). The environmental approval levels are shown in [Exhibit 300-2](#).

Upon receipt of the ERS approval for projects requiring an EA or EIS under NEPA, the region proceeds with environmental documentation, including public involvement, appropriate for the magnitude and type of the project (see [Chapter 210](#) and [WSDOT Community Engagement Plan](#)).

300.02(2) Real Estate Acquisition

Design Approval and approval of right of way plans are required prior to acquiring property. Federal law ([23 USC 108](#)) allows for acquisition of right of way using federal funds prior to completion of NEPA. (See the [April 2, 2013, memorandum on early acquisition policy](#) and the [Right of Way Manual](#) for more information.)

300.03 Design Documentation and Records Retention Policy

300.03(1) Purpose

Design documentation records the evaluations and decisions by the various disciplines that result in design recommendations. Design assumptions and decisions made prior to and during

the scoping phase are included. Changes that occur throughout project development are documented. Required justifications and approvals are also included.

300.03(2) Certification of Documents by Licensed Professionals

All original technical documents must bear the certification of the responsible licensee as listed in [Executive Order E 1010](#).

300.03(3) Project File and Design Documentation Package

The Project File and Design Documentation Package include documentation of project work, including planning; scoping; community engagement; environmental action; the Basis of Design; right of way acquisition; Plans, Specifications, and Estimates (PS&E) development; project advertisement; and construction.

The **Project File (PF)** contains the documentation for planning, scoping, programming, design, approvals, contract assembly, utility relocation, needed right of way, advertisement, award, construction, and maintenance review comments for a project. A Project File is completed for all projects and is retained by the region office responsible for the project. Responsibility for the project may pass from one office to another during the life of a project, and the Project File follows the project as it moves from office to office. With the exception of the DDP, the Project File may be purged when retention of the construction records is no longer necessary.

See the Project File checklist for documents to be preserved in the Project File:

 <http://www.wsdot.wa.gov/Design/Support.htm>

The **Design Documentation Package (DDP)** is a part of the Project File and preserves the decision documents generated during the design process. In each package, a summary (list) of the documents included is recommended. The DDP documents and explains design decisions, design criteria, and the design process that was followed. The DDP is retained in a permanent retrievable file for a period of 75 years, in accordance with the Washington State Department of Transportation (WSDOT) records retention policy.

The Basis of Design, Design Parameters, Alternatives Comparison Table, and Design Analyses are tools developed to document WSDOT practical design and decisions. Retain these in the DDP.

Refer to the remainder of this chapter and DDP checklist for documents to be preserved in the DDP. See Design Documentation Package Checklist here:

 <http://www.wsdot.wa.gov/Design/Support.htm>

300.04 Project Design Approvals

This section describes WSDOT's project design milestones known as Design Approval and Project Development Approval. They are required approvals regardless of delivery method chosen by WSDOT. Many of the documents listed under these milestones are described further in 300.06.

Information pertaining to FHWA approvals and oversight is provided in [300.05](#) which describes Projects of Division Interest (PoDI) which are governed by a separate plan that specifies FHWA and State responsibilities for the project. Documents for projects requiring FHWA review, Design Approval, and Project Development Approval are submitted through the HQ Design Office.

300.04(1) Design Approval

When the Project Summary (see [300.06](#)) documents are approved, and the region is confident that the proposed design adequately addresses the purpose and need for the project, a Design Approval may be pursued and granted at this early stage. Early approval is an option at this point in the design phase and is likely most relevant to larger projects with longer PE phases because it provides early approved documentation that locks in design policy for three years. This is a benefit for longer PE phases in that it avoids design changes due to policy updates during that time and provides consistency when purchasing right of way or producing environmental documentation.

If early Design Approval is not beneficial for a subject project, the typical items (below) that are part of this package become required in the combined Design Approval/Project Development Approval Package. Design Approval may occur prior to NEPA approval. Generally, Design Approval will not be provided prior to an IJR being approved on an Interstate project. Approval levels for design and PS&E documents are presented in Exhibits [300-1](#) through [300-3](#).

The following items are typically provided for Design Approval. See [300.06](#) for additional information.

- Stamped cover sheet (project description)
- A reader-friendly memo that describes the project
- Project Summary documents
- Basis of Design
- Alternatives Comparison Table
- Design Parameters worksheets
- Crash Analysis Report
- Design Analysis
- Design Variance Inventory (for known design analyses at this stage)
- Channelization plans, intersection plans, or interchange plans (if applicable)
- Alignment plans and profiles (if project significantly modifies either the existing vertical or horizontal alignment)
- Current cost estimate with a Basis of Estimate

Design Approval is entered into the Design Documentation Package and remains valid for three years or as approved by the HQ Design Office.

- If the project is over this three-year period and has not advanced to Project Development Approval, evaluate policy changes or revised design criteria that are adopted by the department during this time to determine whether these changes would have a significant impact on the scope or schedule of the project.
- If it is determined that these changes will not be incorporated into the project, document this decision with a memo from the region Project Development Engineer that is included in the DDP.

- For an overview of design policy changes, consult the Detailed Chronology of Design Manual revisions: www.wsdot.wa.gov/design/policy/default.htm

300.04(1)(a) Design-Build Projects

Design Approval applies to design-build projects. Design documentation begins in the project scoping phase and continues through the life of the design-build project. This documentation is thus started by WSDOT and is completed by the design-builder. Since Design Approval is related to project scoping, this milestone shall be accomplished prior to issuing a Design-Build Request for Proposal (see [Exhibit 110-1](#)). However, the design-builder shall refer to the Request for Proposal (RFP) for direction on approval milestones. An approved Basis of Design is required prior to issuing a Design-Build Request for Proposal (RFP).

300.04(2) Project Development Approval

When all project development documents are completed and approved, Project Development Approval is granted by the approval authority designated in [Exhibit 300-1](#). The Project Development Approval becomes part of the DDP.

Refer to this chapter and the DDP checklist for design documents that may lead to Project Development Approval. Exhibits [300-1](#) through [300-3](#) provide approval levels for project design and PS&E documents,.

The following items must be approved prior to Project Development Approval:

- Required environmental documentation
- Design Approval documents (and any supplements)
- Updated Basis of Design
- Updated Design Variance Inventory (all project Design Analyses)
- Cost estimate and Updated Basis of Estimate
- Stamped cover sheet (project description)

Project Development Approval remains valid for three years.

- Evaluate policy changes or revised design criteria that are adopted by the department during this time to determine whether these changes would have a significant impact on the scope or schedule of the project.
- If it is determined that these changes will not be incorporated into the project, document this decision with a memo from the region Project Development Engineer that is included in the DDP.
- For an overview of design policy changes, consult the Detailed Chronology of Design Manual revisions: www.wsdot.wa.gov/design/policy/default.htm

300.04(2)(a) Design-Build Projects

For design-build projects, the design-builder shall refer to the project Request for Proposal (RFP) for specification on final and intermediate deliverables and final records for the project. Project Development Approval is required prior to project completion.

It is a prudent practice to start the compilation of design documentation early in a project and to acquire Project Development Approval before the completion of the project. At the start of a project, it is critical that WSDOT project administration staff recognize the importance of all required documentation and how it will be used in the design-build project delivery process.

300.05 FHWA Oversight and Approvals

The March 2015 Stewardship & Oversight (S&O) [Agreement](#) between WSDOT and FHWA Washington Division created new procedures and terminology associated with FHWA oversight and approvals. One such term, and new relevant procedure, is “Projects of Division Interest” (PoDI) described below.

For all projects, on the National Highway System (NHS), the level of FHWA oversight and approvals can vary for numerous reasons such as type of project, the agency doing the work, PoDI/non-PoDI designation, and funding sources. Oversight and funding do not affect the level of design documentation required for a project.

Documents for projects requiring FHWA review, Design Approval, and Project Development Approval are submitted through the HQ Design Office.

300.05(1) FHWA Projects of Division Interest (PoDI)

Projects of Division Interest (PoDI) are a primary set of projects for which FHWA determines the need to exercise oversight and approval authority. These are projects that have an elevated risk, contain elements of higher risk, or present a meaningful opportunity for FHWA involvement to enhance meeting program or project objectives. Collaborative identification of these projects allows FHWA Washington Division to concentrate resources on project stages or areas of interest. It also allows WSDOT to identify which projects are PoDIs and plan for the expected level of engagement with FHWA.

The Stewardship & Oversight Agreement generally defines Projects of Division Interest as:

- Major Projects (A federal aid project with total cost >\$500M)
- TIGER Discretionary Grant Projects
- NHS Projects that may require FHWA Project or Program Approvals
- Projects Selected by FHWA based on Risk or Opportunity

The S&O Agreement also states: Regardless of retained project approval actions, any Federal-aid Highway Project either on or off the NHS that the Division identifies as having an elevated level of risk can be selected for risk-based stewardship and oversight and would then be identified as a PoDI.

For each project designated as a PoDI, FHWA and WSDOT prepare a Project-Specific PoDI Stewardship & Oversight Agreement which identifies project approvals and related responsibilities specific to the project. This means PoDI projects have their own set of approval requirements and the approvals tables at the end of this chapter apply to non-PoDI projects.

300.05(2) FHWA Approvals on Non-PoDI Projects

On projects that are not identified as PoDI, FHWA approvals are still required for various items as shown in [Exhibit 300-1](#). For example, FHWA approval is still required for any new or revised

access point (including interchanges, temporary access breaks, and locked gate access points) on the Interstate System, regardless of funding source or PoDI designation (see [Chapter 550](#)).

The [Exhibit 300-1](#) approval table refers to New/Reconstruction projects on the Interstate. New/Reconstruction projects include the following types of work:

- Capacity changes: add a through lane, convert a general-purpose (GP) lane to a special-purpose lane (such as an HOV or HOT lane), or convert a high-occupancy vehicle (HOV) lane to GP.
- Other lane changes: add or eliminate a collector-distributor or auxiliary lane. (A rural truck climbing lane that, for its entire length, meets the warrants in Chapter 1270 is not considered new/reconstruction.)
- New interchange.
- Changes in interchange type such as diamond to directional or adding a ramp.
- New or replacement bridge (on or over, main line, or interchange ramp).
- New Safety Rest Areas Interstate.

Documents for projects requiring FHWA review, Design Approval, and Project Development Approval are submitted through the HQ Design Office.

300.06 Project Documents and Approvals

This section lists several major design documents generated for a project and they all are retained in the Design Documentation Package. The Basis of Design, Alternatives Comparison Table, Design Parameters, and Design Analyses are tools used to document practical design decisions.

See the Project File and Design Documentation Package checklists described in [300.03\(3\)](#) for complete list of documents.

For approval levels see Exhibits [300-1](#) through [300-3](#) or a project-specific S&O Agreement for PoDI projects.

300.06(1) *Project Summary*

The Project Summary provides information on the results of the scoping phase; links the project to the Washington State Highway System Plan and the Capital Improvement and Preservation Program (CIPP); and documents the design decisions, the environmental classification, and agency coordination. The Project Summary is developed and approved before the project is funded for design and construction, and it consists of the ERS, and PD documents. The Project Summary database contains specific online instructions for completing the documents.

300.06(1)(a) **Project Definition (PD)**

The PD identifies the various disciplines and design elements that are anticipated to be encountered in project development. It also states the purpose and need for the project, the program categories, and the recommendations for project phasing. The PD is initiated early in the scoping phase to provide a basis for full development of the ERS, schedule, estimate, Basis of Estimate, and Basis of Design (where indicated in scoping instructions). If circumstances

necessitate a change to an approved PD, process a Project Change Request Form for approval by the appropriate designee.

300.06(1)(b) Environmental Review Summary (ERS)

The ERS lists the potentially required environmental permits and approvals, environmental classifications, and environmental considerations. The ERS is prepared during the scoping phase and is approved by the region. If there is a change in the PD, the information in the ERS must be reviewed and revised to match the rest of the Project Summary. For actions classified as a CE under NEPA, the approved ERS becomes the ECS when the project is funded and moves to design. The region may revise the ECS as appropriate (usually during final design) as the project advances. The ECS serves as the NEPA environmental documentation for CE projects. The region Environmental Manager approves the ECS and may send it to FHWA for their approval. The ERS/ECS database includes fully integrated help screens that provide detailed guidance. Contact your region Environmental Office for access.

300.06(2) Basis of Design (BOD)

The BOD captures important decisions that control the outcome of a project, including identified performance needs, context, design controls and design elements necessary to design the practical alternative. When applicable attach supporting documents, such as the Alternatives Comparison Table and Design Parameters to the BOD. (See [Chapter 1100](#) for further discussion on these documents). The Basis of Design (BOD) is part of the DDP.

300.06(3) Basis of Estimate (BOE)

The BOE contains the assumptions, risks, and information used to develop an estimate. The BOE is reviewed and updated during each phase of a project. The confidence of the estimate, either overall or for particular items, is also identified within the BOE. Generally, the BOE is started during the scoping phase because it is required for Project Summary approval; however, in more complex situations the BOE may have begun during the planning phase. For more information, see the [Cost Estimating Manual for WSDOT Projects](#).

300.06(4) Design Analysis

A Design Analysis refers to the process used to document important design decision(s), summarizing information needed for an approving authority to understand and support the decision.

The following information is addressed in a Design Analysis, or may be referenced from other sources (including the Basis of Design and/or design parameter sheets): project need, existing conditions and design data, a safety analysis, any identified system wide benefits applied to project cost savings, any performance mitigation measures, evidence of deviations approved for previous projects at the location, and an evaluation of options considered (cost estimate, B/C ratio, advantages and disadvantages of each alternative, and reasons for selection or rejecting each alternative). A template is available to guide the development of the document (see <http://www.wsdot.wa.gov/Design/Support.htm>).

Once they are approved, Design Analyses are tracked in the Design Variance Inventory System (DVIS). All projects that have Design Analyses must catalog those in the DVIS. All projects have their own inventory within the DVIS. The DVIS database can be accessed from this website: <http://wwwi.wsdot.wa.gov/design/>.

300.06(4)(a) Design Analysis Approval

A Design Analysis requires different levels of approval depending on the project (see [Exhibit 300-1](#).) If a dimension or design element meets current AASHTO guidance adopted by the Federal Highway Administration (FHWA), such as *A Policy on Geometric Design of Highways and Streets*, but is less than the corresponding *Design Manual* criteria, then an approval by FHWA or the HQ Design Office is not required. It does require region approval.

300.07 Process Review

The Assistant State Design Engineers work with the regions on project development and conduct process reviews on projects. The process review is done to provide reasonable assurance that projects are prepared in compliance with established policies and procedures and that adequate records exist to show compliance with state and federal requirements. Process reviews are conducted by WSDOT, FHWA, or a combination of both.

The design and PS&E process review is performed in each region at least once each year by the HQ Design Office. The documents used in the review process are the Design Documentation Package Checklist(s), Basis of Design, Basis of Estimate, the PS&E Review Checklist, and the PS&E Review Summary. These are generic forms used for all project reviews. Copies of these working documents are available for reference when assembling project documentation. The HQ Design Office maintains current copies at: www.wsdot.wa.gov/design/support.htm

Each project selected for review is examined completely and systematically beginning with the scoping phase (including planning documents) and continuing through contract plans and, when available, construction records and change orders. Projects are normally selected after contract award. For projects having major traffic design elements, the HQ Traffic Operations Office is involved in the review. The WSDOT process reviews may be held in conjunction with FHWA process reviews.

The HQ Design Office schedules the process review and coordinates it with the region and FHWA.

300.07(1) Process Review Agenda

When conducting joint process review with FHWA, the Process Review Report will outline specific agenda items.

A WSDOT process review follows this general agenda:

1. Review team meets with region personnel to discuss the object of the review.
2. Review team reviews the design and PS&E documents, construction documents, and change orders (if available) using the checklists.
3. Review team meets with region personnel to ask questions and clarify issues of concern.
4. Review team meets with region personnel to discuss findings.
5. Review team submits a draft report to the region for comments and input.
6. If the review of a project shows a serious discrepancy, the region design authority is asked to report the steps that will be taken to correct the deficiency.

7. Process review summary forms are completed.
8. Summary forms and checklists are evaluated by the Director & State Design Engineer, Development Division.
9. Findings and recommendations of the Director & State Design Engineer, Development Division, are forwarded to the region design authority for action and/or information within 30 days of the review.

300.08 References

300.08(1) Federal/State Laws and Codes

23 Code of Federal Regulations (CFR) 635.111, Tied bids

23 CFR 635.411, Material or product selection

[Revised Code of Washington \(RCW\) 47.28.030](#), Contracts – State forces – Monetary limits – Small businesses, minority, and women contractors – Rules

[RCW 47.28.035](#), Cost of project, defined

“Washington Federal-Aid Stewardship Agreement,”
<http://www.fhwa.dot.gov/wadiv/wadivsa.cfm>

300.08(2) Design Guidance

WSDOT Directional Documents Index, including the one listed below:

<http://wwwi.wsdot.wa.gov/publications/policies>

- [Executive Order E 1010](#), “Certification of Documents by Licensed Professionals,” WSDOT

WSDOT technical manuals, including those listed below:

www.wsdot.wa.gov/publications/manuals/index.htm

- *Advertisement and Award Manual*, M 27-02, WSDOT
- *Cost Estimating Manual for WSDOT Projects*, M 3034.03, WSDOT
- *Design Manual*, M 22-01, WSDOT
- *Emergency Relief Procedures Manual*, M 3014, WSDOT
- *Environmental Manual*, M 31-11, WSDOT
- *Hydraulics Manual*, M 23-03, WSDOT
- *Highway Runoff Manual*, M 31-16, WSDOT
- *Plans Preparation Manual*, M 22-31, WSDOT
- *Project Control and Reporting Manual*, M 3026, WSDOT
- *Roadside Manual*, M 25-30, WSDOT
- *Roadside Policy Manual*, M 3110, WSDOT

Limited Access and Managed Access Master Plan, WSDOT

www.wsdot.wa.gov/design/accessandhearings/tracking.htm

Washington State Highway System Plan, WSDOT

www.wsdot.wa.gov/planning/

300.08(3) Supporting Information

A Policy on Geometric Design of Highways and Streets (Green Book), AASHTO, 2011

Mitigation Strategies for Design Exceptions, FHWA, July 2007. This publication provides detailed information on design exceptions and mitigating the potential adverse impacts to highway safety and traffic operations.

Highway Capacity Manual (HCM), latest edition, Transportation Research Board, National Research Council

Highway Safety Manual (HSM), AASHTO

Exhibit 300-1 Design Approval Level

Project Design	Design Analysis Approval [1][2]	Design and Project Development Approvals
Interstate		
New/Reconstruction [3] Regardless of funding source	FHWA	FHWA [4]
Interstate (posted speed ≥ 50mph) Regardless of work performed / FHWA controlling criteria [11] only	FHWA	FHWA
Intelligent Transportation Systems (ITS) Improvement project over \$1 million Preservation project	HQ Design HQ Design	HQ Design Region
All Other Federal funds State funds Local agency funds	HQ Design	Region
National Highway System (NHS)		
Facilities where posted speed ≥ 50mph regardless of work performed / FHWA controlling criteria [11] only	HQ Design	Region
WSDOT project on a managed access highway outside incorporated cities and towns or inside unincorporated cities and towns, or limited access highway	HQ Design [5]	Region
WSDOT project on a managed access highway within incorporated cities and towns [6] Inside curb or EPS [7][8] Outside curb or EPS	HQ Design HQ LP	Region City/Town
Non-National Highway System (Non-NHS)		
Improvement project on managed access highway outside incorporated cities and towns or within unincorporated cities and towns, or on limited access highway	HQ Design	Region
Improvement project on managed access highway within incorporated cities and towns [6][10] Inside curb or EPS [7][8] Outside curb or EPS	HQ Design HQ LP	Region City/Town
Preservation project on managed access highway outside incorporated cities and towns or within unincorporated cities and towns, or on limited access highway [9]	Region	Region
Preservation project on managed access highway within incorporated cities and towns [6][9] Inside curb or EPS [7][8] Outside curb or EPS	Region HQ LP	Region City/Town

For table notes, see the following page.

Exhibit 300-1 Design Approval Level (continued)

FHWA = Federal Highway Administration

HQ = WSDOT Headquarters

HQ LP = WSDOT Headquarters Local Programs Office

EPS = Edge of paved shoulder where curbs do not exist

If a project is identified as a PoDI, FHWA approvals and involvement will be outlined in a Project Specific PoDI S&O Agreement.

Notes:

- [1] These approval levels also apply to Design Analysis processing for local agency and developer work on a state highway.
- [2] See [300.06\(4\)](#) and the Technical Errata issued with the November 2015 *Design Manual* Publication.
- [3] For definition of New/Reconstruction, see [300.05\(2\)](#).
- [4] FHWA will provide Design Approval prior to NEPA Approval, but will not provide Project Development Approval until NEPA is complete.
http://www.wsdot.wa.gov/publications/fulltext/design/ASDE/2015_Stewardship.pdf
- [5] For guidance on Design Analyses related to access management, see the Technical Errata included in the November 2015 *Design Manual* revision package and [Chapter 530](#).
- [6] Applies to the area within the incorporated limits of cities and towns.
- [7] Includes raised medians.
- [8] Curb ramps are still included (see [Chapter 1510](#)).
- [9] For Bridge Replacement projects in the Preservation program, follow the approval level specified for Improvement projects.
- [10] Refer to [RCW 47.24.020](#) for more specific information about jurisdiction and responsibilities that can affect approvals.
- [11] http://safety.fhwa.dot.gov/geometric/pubs/mitigationstrategies/chapter3/3_controlcriteria.cfm

Exhibit 300-2 Approvals

Item	Approval Authority		
	Region	HQ	FHWA
Program Development			
Work Order Authorization		X	X [1]
Public Hearings			
Corridor Hearing Summary		X [2]	
Design Summary		X [3]	
Access Hearing Plan		X [4]	
Access Findings and Order		X [5]	
Environmental Document			
Class I NEPA (EIS)		[7]	X
SEPA (EIS)		X	
Class II NEPA – Categorical Exclusion (CE) Documented in ECS form	X		
SEPA – Categorical Exemption (CE)	X		
Class III NEPA – Environmental Assessment (EA)		[7]	X
SEPA Environmental Checklist & Determination of Non-Significance (DNS)	X		
Design			
Basis of Design	X	X	X [9]
Intersection Control Type	X [22]	X [24]	
Experimental Features		X	X
Environmental Review Summary	X		
Final Project Definition		X [10]	
Interstate Interchange Justification Report		[7]	X
Any Break in Interstate Limited Access		[7]	X
Non-Interstate Interchange Justification Report		X	
Break in Partial or Modified Limited Access		X	
Intersection or Channelization Plans	X [11]		
Right of Way Plans	[12]	X	
Monumentation Map	X		
Materials Source Report		X [13]	
Pavement Determination Report		X [13]	
Roundabout Geometric Design (see Chapter 1320 for guidance)	X		
Resurfacing Report		X [13]	
Signal Permits	X [14]		
Geotechnical Report		X [13]	
Tied Bids	X [15]		

Table is continued on the following page, which also contains the notes.

Exhibit 300-2 Approvals (continued)

Item	Approval Authority		
	Region	HQ	FHWA
Bridge Design Plans (Bridge Layout)	X	X	
Preliminary Bridge Plans for Unusual/Complex Bridges on the Interstate		[7]	X
Structures Requiring TS&Ls		X	
Hydraulic Report	X [16]	X [16]	
Preliminary Signalization Plans		X [6][20]	
Signalization Plans	X [22]		
Illumination Plans	X [22]		
Intelligent Transportation System (ITS) Plans	X [22]		
ITS Systems Engineering Analysis Worksheet (Exhibit 1050-2)	X [22]		
Rest Area Plans		X	
Roadside Restoration Plans	X [18]	X [19]	
Planting Plans	X [18]	X [19]	
Grading Plans	X		
Continuous Illumination – Main Line		X [20]	
Tunnel Illumination		X [20]	
High Mast Illumination		X [20]	
Project Change Request Form	X [21]	X [21]	
Work Zone Transportation Management Plan/Traffic Control Plan	X [22]		
Public Art Plan – Interstate (see Chapter 950)	X [18]	X [19][23]	X
Public Art Plan – Non-Interstate (see Chapter 950)	X [18]	X [19][23]	
ADA Maximum Extent Feasible Document (see Chapter 1510)	X	X	
Notes:			
[1] Federal-aid projects only.	[11] Include channelization details.		
[2] Approved by Assistant Secretary, Engineering & Regional Operations.	[12] Certified by the responsible professional licensee.		
[3] Approved by Director & State Design Engineer, Development Division.	[13] Submit to HQ Mats Lab for review and approval.		
[4] Approved by Right of Way Plans Manager.	[14] Approved by Regional Administrator or designee.		
[5] Refer to Chapter 210 for approval requirements.	[15] Per 23 CFR 635.111.		
[6] Final review & concurrence required at the region level prior to submittal to approving authority.	[16] See the <i>Hydraulics Manual</i> for approvals levels.		
[7] Final review & concurrence required at HQ prior to submittal to approving authority.	[18] Applies to regions with a Landscape Architect.		
[8] Vacant	[19] Applies to regions without a Landscape Architect.		
[9] Interstate facilities where posted speed \geq 50mph regardless of work performed / FHWA controlling criteria only.	[20] Approved by State Traffic Engineer.		
[10] Approved by HQ Capital Program Development and Management (CPDM).	[21] Consult CPDM for clarification on approval authority.		
	[22] Region Traffic Engineer or designee.		
	[23] The State Bridge and Structures Architect reviews and approves the public art plan (see Chapter 950 for further details on approvals).		
	[24] State Traffic Engineer or designee.		

Exhibit 300-3 PS&E Process Approvals NHS (including Interstate) and Non-NHS

Item	Headquarters or Region Approval Authority
DBE/training goals * **	Office of Equal Opportunity
Right of way certification for federal-aid projects***	Region; HQ Real Estate Services Office or HQ Local Programs Right of Way Manager [7]
Right of way certification for state or local funded projects***	Region; HQ Real Estate Services Office or HQ Local Programs Right of Way Manager
Railroad agreements	HQ Design Office
Work performed for public or private entities *	Region [1][2]
State force work *	Region [3][4]
Use of state-furnished materials *	Region [3][4]
Work order authorization	Capital Program Development and Management [5]
Ultimate reclamation plan approval through DNR	Region
Proprietary item use *	[4][6] HQ Design Office
Mandatory material sources and/or waste sites *	Region [4]
Nonstandard bid item use *	Region
Incentive provisions	HQ Construction Office
Nonstandard time for completion liquidated damages *	HQ Construction Office
Interim liquidated damages *	Statewide Travel and Collision Data Office
<p>Notes:</p> <p>FHWA PS&E Approval has been delegated to WSDOT unless otherwise stated differently in a Project Specific PoDI S&O Agreement.</p> <p>[1] This work requires a written agreement.</p> <p>[2] Region approval subject to \$250,000 limitation.</p> <p>[3] Use of state forces is subject to \$60,000 limitation and \$100,000 in an emergency situation, as stipulated in RCWs 47.28.030 and 47.28.035. Region justifies use of state force work and state-furnished materials and determines if the work is maintenance or not. HQ CPDM reviews to ensure process has been followed.</p> <p>[4] Applies only to federal-aid projects; however, document for all projects.</p> <p>[5] Prior FHWA funding approval required for federal-aid projects.</p> <p>[6] The HQ Design Office is required to certify that the proprietary product is either: (a) necessary for synchronization with existing facilities, or (b) a unique product for which there is no equally suitable alternative.</p> <p>[7] For any federal aid project FHWA only approves Right of Way Certification 3s (All R/W Not Acquired), WSDOT approves Right of Way Certification 1s and 2s for all other federal aid projects.</p> <p>References:</p> <p>* Plans Preparation Manual</p> <p>** Advertisement and Award Manual</p> <p>*** Right of Way Manual</p>	

Exhibit 300-4 Design to Construction Transition Project Turnover Checklist Example

This checklist is recommended for use when coordinating project transition from design to construction.

1. Survey

- End areas (cut & fill)
- Staking data
- Horizontal/Vertical control
- Monumentation/Control information

2. Design Backup

- Index for all backup material
- Backup calculations for quantities
- Geotech shrink/swell assumptions
- Basis of Design, Design decisions and constraints
- Approved deviations & project/corridor analysis
- Hydraulics/Drainage information
- Clarify work zone traffic control/workforce estimates
- Geotechnical information (report)
- Package of as-builts used (which were verified) and right of way files
- Detailed assumptions for construction CPM schedule (working days)
- Graphics and design visualization information (aerials)
- Specific work item information for inspectors (details not covered in plans)
- Traffic counts
- Management of utility relocation

3. Concise Electronic Information With Indices

- Detailed survey information (see Survey above)
- Archived InRoads data
- Only one set of electronic information
- "Storybook" on electronic files (what's what)
- CADD files

4. Agreements, Commitments, and Issues

- Agreements and commitments by WSDOT
- RES commitments
- Summary of environmental permit conditions/commitments
- Other permit conditions/commitments
- Internal contact list
- Construction permits
- Utility status/contact
- Identification of the work elements included in the Turnback Agreement (recommend highlighted plan sheets)

5. Construction Support

- Assign a Design Technical Advisor (Design Lead) for construction support

An expanded version of this checklist is available at: www.wsdot.wa.gov/design/projectdev

- [305.01 Introduction](#)
- [305.02 References](#)
- [305.03 Definitions](#)
- [305.04 Design Project Management Overview](#)
- [305.05 Cost Estimating for Design Project Development](#)
- [305.06 Value Engineering](#)
- [305.07 Context Sensitive Solutions \(CSS\)](#)
- [305.08 Additional Design Resources](#)

305.01 Introduction

This chapter outlines the principles and methodology adopted by the Washington State Department of Transportation (WSDOT) for successful project management. WSDOT's project management process is the standard practice adopted by the department to manage projects, and it provides a method to meet WSDOT's management principles. This chapter focuses on preconstruction activities such as cost estimating, risk management, task planning, schedule development, and budgeting, as well as managing scope, schedule, and budget.

The WSDOT Secretary's Executive Orders 1028, 1032, 1038, and 1053 were issued to ensure a consistent process for context sensitive solutions (CSS), design project management, and risk-management statewide.

Secretary's Executive Order E 1090, Moving Washington Forward: Practical Solutions, directs employees to implement least cost planning and practical design principles throughout all phases of project delivery. One of the primary objectives is to do more projects, and address more problems, more quickly. This supplements Secretary's Executive Order E 1082, Business Practices for Moving Washington, which established the expectation that decision-making will be sustainable and cost-effective, in support of our economy, environment, and communities. Links to these polices are provided in the References section below. (See [Chapter 1100](#) for more information on practical design.)

WSDOT's project management process includes "best management practices" and the tools, templates, examples, and guidance necessary to successfully deliver Capital Transportation projects. The process will enhance communications when designers hand off projects to construction project management.

Following are brief discussions about and links to other WSDOT project development resources. These include technical manuals, research reports, and online design-related websites.

305.02 References

305.02(1) *Federal/State Laws and Codes*

[23 United States Code \(USC\) 106](#), Project approval and oversight

305.02(2) WSDOT Policies

Directives, Executive Orders, Instructional Letters, Manuals, and Policy Statements

🔗 <http://wwwi.wsdot.wa.gov/publications/policies/default.htm>

Executive Order E 1028, Context Sensitive Solutions

🔗 <http://wwwi.wsdot.wa.gov/publications/policies/fulltext/1028.pdf>

Executive Order E 1032, Project Management

🔗 <http://wwwi.wsdot.wa.gov/publications/policies/fulltext/1032.pdf>

Executive Order E 1038, Enterprise Risk Management

🔗 <http://wwwi.wsdot.wa.gov/publications/policies/fulltext/1038.pdf>

Executive Order E 1053, Project Risk Management and Risk Based Estimating

🔗 www.wsdot.wa.gov/publications/fulltext/cevp/1053policy.pdf

Executive Order E 1090, Moving Washington Forward: Practical Solutions

🔗 <http://wwwi.wsdot.wa.gov/publications/policies/fulltext/1090.pdf>

Executive Order E 1096, WSDOT 2015–17: Agency Emphasis and Expectations

🔗 <http://wwwi.wsdot.wa.gov/publications/policies/fulltext/1096.pdf>

Executive Order E 1082, Business Practices for Moving Washington

🔗 <http://wwwi.wsdot.wa.gov/publications/policies/fulltext/1082.pdf>

Instructional Letter IL 4071, Risk-Based Project Estimates for Inflation Rates, Market Conditions, and Percentile Selection

🔗 <http://wwwi.wsdot.wa.gov/publications/policies/fulltext/4071.pdf>

Project Delivery Memos

🔗 www.wsdot.wa.gov/design/projectdev/memos.htm

305.03 Definitions

For a complete glossary of project management terms, see:

🔗 www.wsdot.wa.gov/publications/fulltext/projectmgmt/pmog/pm_glossary.pdf

For a complete glossary of cost estimating and risk assessment terms, see:

🔗 <http://www.wsdot.wa.gov/nr/rdonlyres/d10b9b96-9c03-479c-8b52-17ff7bff9a0f/0/glossaryofterms.doc>

For cost estimating definitions, see:

🔗 www.wsdot.wa.gov/publications/manuals/m3034.htm

305.04 Design Project Management Overview

WSDOT's project management process provides the framework for project managers to deliver projects on time and within scope and budget. WSDOT employs a number of tools to manage projects effectively and efficiently.

305.04(1) Project Management Process

305.04(1)(a) Overview

For an overview of project management, with links to the WSDOT project management process for delivering the WSDOT Capital Construction Program, see the following website:

🔗 www.wsdot.wa.gov/projects/projectmgmt

Exhibit 305-1 shows the five steps in the project management process used to deliver Capital Transportation projects. The following link takes you to a table with a more detailed description of the five steps: 🔗 www.wsdot.wa.gov/nr/rdonlyres/a76c71ef-c926-4a13-9615-c9f341f3baaf/0/wsdotproj_mgmt_process.pdf

305.04(1)(b) Design Process Deliverables

The following website will take you to the Deliverable Expectation Matrix, which identifies the appropriate design process deliverable cells in the Master Deliverables List (see 305.04(2)(b)):

🔗 www.wsdot.wa.gov/publications/fulltext/design/demintro.pdf

Exhibit 305-1 WSDOT Project Management Process

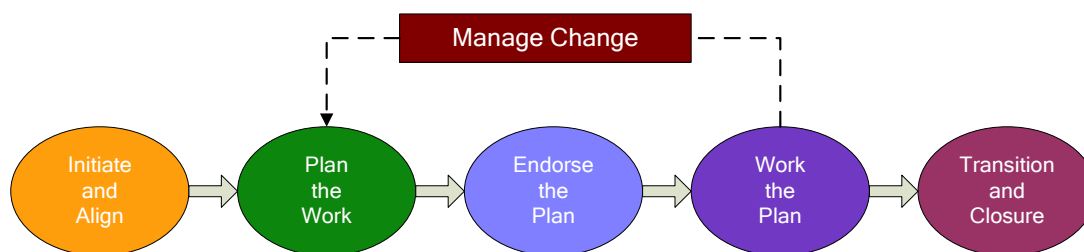

305.04(2) Project Management Tools

305.04(2)(a) Project Management and Reporting System (PMRS)

The PMRS is a tool for effective and efficient management of design project schedules, resources, and costs. The following website provides tools for project planning, work breakdown structure (WBS) development, scheduling, and resource and cost management:

🔗 <http://wwwi.wsdot.wa.gov/planning/cpdm/pmrs.htm>

305.04(2)(b) WSDOT's Master Deliverables List (MDL)

The Master Deliverables List (MDL) is a comprehensive listing of project elements. This list is agreed upon across WSDOT and is intended as a starting point for the creation of the project Work Breakdown Structure (WBS) and to ensure:

- All appropriate project elements are included in the project management plan and schedule.
- The MDL activity codes, related titles, and descriptions provide a common vocabulary across all projects and between project teams, region and Headquarters (HQ) management, and specialty/support groups.

For additional information, see:

🔗 www.wsdot.wa.gov/projects/projectmgmt/masterdeliverables.htm

305.05 Cost Estimating for Design Project Development

Cost estimating guidance has been developed by the Strategic Assessment and Estimating Office (SAEO) and WSDOT Project Development.

305.05(1) Project Phases

There are four main phases or levels of design project development:

- Planning
- Scoping
- Design
- Plans, Specifications, and Estimates (PS&E)

The estimate for each level of project development has a specific purpose, methodology, and expected level of accuracy. As the project progresses, more data are available and the expected accuracy range narrows. For more information, see the [Cost Estimating Manual for WSDOT Projects](#).

305.05(1)(a) Planning

The planning-level estimate is used to estimate the funding needs for long-range planning and to prioritize needs for the Highway System Plan. These estimates are typically prepared with little project definition detail.

305.05(1)(b) Scoping

A scoping-level estimate is used to set the baseline cost for the project and to program the project. A project is programmed when it is entered into the Capital Improvement and Preservation Program (CIPP) and the Biennial Transportation Program. The scoping estimate is important because it is the baseline used by the Legislature to set the budget, and all future estimates will be compared against it.

305.05(1)(c) Design

Estimates prepared at the various design levels, including Geometric Review, General Plans Review, and Preliminary Contract Review, are used to track changes in the estimated cost to complete the project in relation to the current budget (CIPP or “Book” amount).

Design Approval is an important stage of design for estimating purposes. At Design Approval, the configuration of the project is known. This will solidify many items in the scope, such as right of way needs, likely permit conditions, environmental mitigation, quantities of major items, and outside stakeholders. As scope definition improves, the accuracy of the estimate will likewise improve. The work effort required to prepare, document, and review the estimate also increases.

An important element of the project is the Basis of Estimate (BOE). The BOE is a documented record of pertinent communications that have occurred and agreements that have been made between the estimator and other project stakeholders. The BOE, which is to be included in the Project File, is characterized as *the one deliverable that defines the scope of the project, and it ultimately becomes the basis for change management*. For guidance in developing the BOE, and a template to help in its preparation, see the [Cost Estimating Manual for WSDOT Projects](#).

305.05(1)(d) PS&E

The Engineer's Estimate (part of PS&E) is prepared for the Final Contract Review in preparation for advertisement, and it is used to obligate construction funds and evaluate contractors' bids.

305.05(2) Risk Management

Project risks can be "opportunities" (positive events) as well as "threats" (negative events) that might affect scope, schedule, or budget. Risk assessment is the first phase of project risk management. Its purpose is to maximize the results of positive events and minimize the consequences of adverse events. For more information on risk assessment, see:

 www.wsdot.wa.gov/projects/projectmgmt/riskassessment/

305.05(2)(a) Design Project Risk Management Process**305.05(2)(a)(1) Risk Management Planning**

Using a systematic process, determine how to approach, plan, and execute risk management activities throughout the life of a design project.

305.05(2)(a)(2) Identify Risk Events

Determine which risks might affect the design project and document their characteristics. It may be a simple risk assessment organized by the design project team or an outcome of the Cost Estimate Validation Process/Cost Risk Assessment workshop process.

305.05(2)(a)(3) Qualitative Risk Analysis

Assess the impact and likelihood of the identified risk and develop prioritized lists of these risks for further analysis or direct mitigation. The design team should elicit assistance from subject matter experts or functional units to assess the risks in their respective fields.

305.05(2)(a)(4) Quantitative Risk Analysis

Numerically estimate the probability that the design project will meet its cost and time objectives. Quantitative analysis is based on a simultaneous evaluation of the impacts of all identified and quantified risks.

305.05(2)(a)(5) Risk Response Planning

Develop options and determine actions to enhance opportunities and reduce threats to the design project's objectives.

305.05(2)(a)(6) Risk Monitoring and Control

Track and monitor the impact of identified risks, monitor residual risks, and identify new risks, ensuring the execution of risk plans, and evaluate their effectiveness in reducing risk or enhancing opportunities. Risk Monitoring and Control is an ongoing process for the life of the design project.

For more information on risk planning and risk management, see:

 www.wsdot.wa.gov/publications/fulltext/cevp/projectriskmanagement.pdf

305.05(2)(b) Inclusion of Formal Project Risk Assessment: CRA, CEVP, VERA

WSDOT policy requires a Cost Risk Assessment (CRA) for projects over \$25 million and a Cost Estimate Validation Process (CEVP) for projects over \$100 million. Both of these processes include an estimate review.

Value Engineering Methodology may be combined with any risk assessment for use in project evaluation. Value Engineering Risk Assessment (VERA) is a process that combines both Value Engineering Methodology and the tools and procedures of Cost Risk Assessment. The VERA process is used when accelerated project delivery is desired along with minimizing and/or mitigating quantified risks.

It is recommended that all projects undergo at least an internal project team review for each estimate update.

- Consider a peer review or region review for each estimate that is complex or includes significant changes to scope or design development.
- Consider a region/HQ or external estimate review for all projects over \$10 million or for projects that are complex during the design phase.

Document each estimate review in the Project File, and clearly show any changes made to the estimate as a result of the review.

Refer to the *Project Risk Management Guide* for more information about risk, CRAs, and CEVPs:
www.wsdot.wa.gov/projects/projectmgmt/riskassessment/default.htm

305.06 Value Engineering

Value engineering (VE) is a systematic process that uses a team chosen from a variety of disciplines to improve the value of a project through the analysis of its functions. The VE process incorporates, to the greatest extent possible, the values of design; construction; maintenance; contractor; state, local and federal approval agencies; other stakeholders; and the public.

For additional information about value engineering, see [Chapter 310](#).

305.07 Context Sensitive Solutions (CSS)

Context Sensitive Solutions is a model for transportation project development that considers the total context of a transportation project. CSS is a collaborative, interdisciplinary, holistic approach to the development of transportation projects. It is both process and product, characterized by a number of attributes. It involves all stakeholders, including community members, elected officials, interest groups, and affected local, state, and federal agencies. CSS supports practical design, helping all parties understand context, design considerations, and trade-offs in decision-making. Often associated with design in transportation projects, CSS should be a part of all phases of program delivery, including long-range planning, programming, environmental studies, design, construction, operations, and maintenance.

Essentially, the CSS approach is that transportation projects must be designed for the physical aspects of facilities serving specific transportation objectives, as well as for a project's effect on the aesthetic, social, economic, and environmental needs and constraints.

Key issues for designers may include:

- Access management
- Urban median design
- Bike and pedestrian access and safety
- Streetscaping
- Transit and freight
- Traffic calming
- Business access
- Operational intent of the facility
- Urban forestry

For guidance on incorporating Context Sensitive Design, see:

🔗 www.wsdot.wa.gov/design/policy/csdesign

305.08 Additional Design Resources

305.08(1) Technical Manuals

There are many WSDOT technical manuals used in project development. Links to the most recent versions are available at the Publications Services Index website:

🔗 www.wsdot.wa.gov/publications/manuals/index.htm

305.08(2) Administrative Manuals

Some administrative manuals (such as the *Agreements Manual*) are used in project development. These manuals are available on WSDOT's internal Administrative Manuals website: 🔗 <http://wwwi.wsdot.wa.gov/publications/manuals/>

305.08(3) Transportation Research and Reports

The following WSDOT Research websites may be of interest during project development:

Understanding Flexibility in Transportation Design – Washington guidance manual:

🔗 www.wsdot.wa.gov/research/reports/600/638.1.htm

Transportation Research home page: 🔗 www.wsdot.wa.gov/research/

Research Reports Index: 🔗 www.wsdot.wa.gov/research/reports

305.08(4) Online Design Guidance

The WSDOT Design Support website contains the DDP and Project File Checklists, Basis of Design and instructions, Design Parameters and Criteria worksheets:

🔗 <http://www.wsdot.wa.gov/Design/Support.htm>

The WSDOT Development Division's website provides links to various design and PS&E-related resources and contacts: 🔗 www.wsdot.wa.gov/design/

The Project Development home page is a design-related resource:

🔗 www.wsdot.wa.gov/design/projectdev/

305.08(5) Project Management Online Guide

The WSDOT Project Management Online Guide (PMOG) is an interactive website that includes links to project management tools and templates, to manuals and specifications, and examples of good practice:

 www.wsdot.wa.gov/projects/projectmgmt/onlineguide/preconstruction.htm

305.08(6) Project Management and Reporting System (PMRS) Web Portal

WSDOT implemented the Project Management and Reporting System (PMRS) to assist with managing and reporting the status of capital transportation projects. PMRS provides WSDOT project managers with current business practices and integrated tools to assist with making good decisions on management of project scope, schedule, and cost.

 <http://wwwi.wsdot.wa.gov/planning/cpdmo/pmrs.htm>

- 310.01 General
- 310.02 References
- 310.03 Statewide VE Program
- 310.04 VE Procedure
- 310.05 Value Engineering Combined with Risk Assessment (VERA)
- 310.06 Practical Design Workshops
- 310.07 Project Management Accountability
- 310.08 Documentation

310.01 General

Value engineering (VE) analysis is a systematic process of reviewing and assessing a project by a multidisciplinary team not directly involved in the planning and development phases of a specific project. The VE process incorporates the values of design; construction; maintenance; contractor; state, local, and federal approval agencies; other stakeholders; and the public.

Value engineering analyses are conducted early in WSDOT project development to identify ideas that might reduce cost; refine scope definition; improve design functionality; improve constructability; improve coordination/schedule; and identify other value improvements, including reduced environmental impacts and congestion.

A VE analysis¹ may be applied as a quick-response study to address a problem or as an integral part of an overall organizational effort to stimulate innovation and improve performance characteristics.

Project managers are accountable for ensuring their projects meet all value engineering requirements when applicable. In addition, local programs projects are accountable for ensuring they comply with all requirements put forth in the *Local Agency Guidelines*. In all cases, when a VE study is completed, the project manager is accountable for completing, signing, and submitting the VE Recommendations Approval Form.

310.02 References

310.02(1) Federal Laws and Codes

[Title 23 U.S.C. Section 106\(e\)](#) – Value Engineering Analysis

[Title 23 CFR Part 627](#) – Value Engineering

MAP-21 (Moving Ahead for Progress in the 21st Century), Section 1503

Circular A-131, Office of Management and Budget (OMB)

http://www.whitehouse.gov/omb/circulars_a131

FHWA Value Engineering Policy

<http://www.fhwa.dot.gov/legsregs/directives/orders/13111b.cfm>

¹ This chapter uses the terms “study” and “analysis” interchangeably.

310.02(2) Design Guidance

Value Engineering for Highways, Study Workbook, U.S. Department of Transportation, FHWA Value Standard and Body of Knowledge, SAVE International, The Value Society:

www.value-eng.org/

WSDOT Value Engineering website:

www.wsdot.wa.gov/design/valueengineering/

310.03 Statewide VE Program

310.03(1) Annual VE Plan

The State VE Manager coordinates annually with the Capital Program Development and Region VE Coordinators to prepare an annual VE Plan, with specific projects scheduled quarterly. The VE Plan is the basis for determining the projected VE program needs, including team members, team leaders, consultants, and training. The Statewide VE Plan is a working document, and close coordination is necessary between Headquarters (HQ) and the regions to keep it updated and projects on schedule.

310.03(2) Selecting Projects for VE Analysis

310.03(2)(a) Requirements

WSDOT projects for VE studies may be selected from any of the categories identified in the Highway Construction Program, including Preservation and Improvement projects, depending on the size and/or complexity of the project. In addition to the cost, other issues adding to the complexity of the project design or construction are considered in the selection process. These include projects that have critical constraints, difficult technical issues, expensive solutions, external influences, and complicated functional requirements, regardless of the estimated project cost.

WSDOT may conduct VE analyses on any projects the project manager determines will benefit from the exercise. In addition, WSDOT conducts VE analyses for all projects as required by the criteria set forth in Federal Highway Administration (FHWA) Value Engineering Policy Order.

1. WSDOT policy requires a value engineering analysis for:
 - Any project with an estimated cost (which includes project development, design, right of way, and construction costs) of \$25 million or more, regardless of funding;
 - Each bridge project located on or off of the federal-aid system with an estimated total cost of \$20 million or more (WSDOT policy is to conduct a VE analysis regardless of funding source); and
 - Any other projects the Secretary or FHWA determines to be appropriate.
2. In addition to the projects described above, WSDOT strongly encourages a VE analysis on other projects where there is a high potential for cost savings in comparison to the cost of the VE analysis, or the potential exists to improve the projects' performance or quality. Projects involving complex technical issues, challenging project constraints, unique requirements, and competing community and stakeholder objectives offer opportunities for improved value by conducting VE analyses.

3. Any use of Federal-Aid Highway Program (FAHP) funding on a Major Project² requires that a VE analysis be conducted. In some cases, regardless of the amount of FAHP funding, a project team may be required to perform more than one VE analysis for a Major Project.
4. After completing the required VE analysis, if the project is subsequently split into smaller projects in final design or is programmed to be completed by the advertisement of multiple construction contracts, an additional VE analysis is not required. However, splitting a project into smaller projects or multiple construction contracts is not an accepted method to avoid the requirements to conduct a VE analysis.
5. WSDOT may require a VE analysis to be conducted if a region or public authority encounters instances when the design of a project has been completed but the project does not immediately proceed to construction.
 - a. If a project meeting the above criteria encounters a three-year or longer delay prior to advertisement for construction, and a substantial change to the project's scope or design is identified, WSDOT may require a new VE analysis or an update to the previous VE analysis; or
 - b. If a project's estimated cost was below the criteria identified above but the project advances to construction advertisement, and a substantial change occurs to the project's scope or design, causing an increase in the project cost so that it meets the criteria identified above and results in a **required re-evaluation of the environmental document**, WSDOT requires that a VE analysis be conducted.
6. When the design of a project has been completed but the project does not immediately proceed to construction, the requirement to conduct a VE analysis is considered to be satisfied, or not necessary, if:
 - a. A project met the criteria identified above and had a VE analysis conducted, and the project advances to advertisement for construction without any substantial changes in its scope or its design; or
 - b. A project's estimated cost initially fell *below* the criteria identified above, but when advancing to advertisement for construction, falls *above* the criteria due to inflation, standard escalation of costs, or minor modifications to the project's design or contract.

Other projects that should be considered for value engineering have a total estimated cost exceeding \$5 million and include one or more of the following:

- Alternative solutions that vary the scope and cost
- New alignment or bypass sections
- Capacity improvements that widen the existing highway
- Major structures
- Interchanges
- Extensive or expensive environmental or geotechnical requirements

² Based on the *Safe, Accountable, Flexible, Efficient Transportation Equity Act: A Legacy for Users (SAFETEA-LU)*, signed into law on August 10, 2005, a Major Project is defined as "a project with a total estimated cost of \$500 million or more that is receiving financial assistance." FHWA also has the discretion to designate a project with a total cost of less than \$500 million as a Major Project. FHWA may choose to do so in situations where the projects require a substantial portion of the State Transportation Agency's (STA's) program resources; have a high level of public or congressional interest; are unusually complex; have extraordinary implications for the national transportation system; or are likely to exceed \$500 million in total cost.

- Materials that are difficult to acquire or that require special efforts
- Inferior materials sources
- New/Reconstruction projects
- Major traffic control requirements or multiple construction stages

310.03(3) VE Analysis Timing

310.03(3)(a) When to Conduct the VE Analysis

Timing is very important to the success of the VE analysis. A VE analysis should be conducted as early as practicable in the planning or development of a project, preferably before the completion of preliminary design. At a minimum, the VE analysis is to be conducted prior to completing the final design.

The VE analysis should be closely coordinated with other project development activities to minimize the impact approved recommendations might have on: previous agency, community, or environmental commitments; the project's scope; and the use of innovative technologies, materials, methods, plans, or construction provisions. In addition, VE analyses should be coordinated with risk assessment workshops such as Cost Risk Assessment (CRA) or Cost Estimate Validation Process (CEVP) (see www.wsdot.wa.gov/design/saeo/).

Benefits can potentially be realized by performing a VE analysis at any time during project development; however, the WSDOT VE program identifies the following three windows of opportunity for performing a VE analysis.

1. Scoping Phase

Early in preliminary engineering, once the project need has been defined (the project summary has been completed) and the project scope and preliminary costs are available, is a good time for value analysis consideration. This is a good time to consider the alternatives or design solutions with a high potential for the VE team's recommendations to be implemented. At the conclusion of the VE study, the project scope, preliminary costs, and major design decisions can be informed by the recommendations.

When conducting value engineering during the scoping phase of a project, the VE analysis focuses on issues affecting project drivers. This stage often provides an opportunity for building consensus with stakeholders.

2. Start of Design

At the start of design, the project scope and preliminary costs have already been established and the major design decisions have been made. Some Plans, Specifications, and Estimates (PS&E) activities may have begun, and coordination has been initiated with the various support groups and subject matter experts that will be involved with the design. At this stage, the established project scope, preliminary costs, and schedule will define the limits of the VE analysis, and there is still opportunity to focus on the technical issues of the specific design elements.

3. Design Approval

After the project receives Design Approval, most of the important project decisions have been made and the opportunity to affect the project design is limited. Provided that the Design Approval is early enough to incorporate the adopted VE recommendations, the VE analysis should focus on constructability, construction sequencing, staging, traffic control, and any significant design issues identified during design development.

An additional VE analysis may be beneficial late in the development stage when the estimated cost of the project exceeds the project budget. The value engineering process can be applied to the project to lower the cost while maintaining the value and quality of the design.

310.03(4) VE Program Roles and Responsibilities

310.03(4)(a) Region VE Coordinator

- Identifies region projects for VE analyses (from Project Summaries and available planning documents).
- Makes recommendations for timing of the VE analysis for each project.
- Presents a list of the identified projects to region management to prioritize into a regional annual VE Plan.
- Identifies potential team facilitators and members for participation statewide.

310.03(4)(b) State VE Manager

- Reviews regional VE Plans regarding content and schedule.

310.03(4)(c) State VE Coordinator

- Incorporates the regional annual VE Plans and the Headquarters Plan to create the Statewide VE Plan.
- Prepares annual VE Report.
- Maintains policy documents for the department.
- Coordinates studies.
- Arranges training for future VE team leaders and members.

310.03(4)(d) VE Team Leader

The quality of the VE analysis largely depends on the skills of the VE team leader. This individual guides the team's efforts and is responsible for its actions during the analysis. The VE team leader should be knowledgeable and proficient in transportation design and construction and in the VE analysis process for transportation projects.

The VE team leader's responsibilities include the following:

- Plans, leads, and facilitates the VE study.
- Ensures proper application of a value methodology.
- Follows the Job Plan.
- Guides the team through the activities needed to complete the pre-study, the VE study, and the post-study stages of a VE study.
- Schedules a preworkshop meeting with the project team and prepares the agenda for the VE study.

Team leaders from within WSDOT are encouraged, but not required, to be certified by the Society of American Value Engineers (SAVE) as a Certified Value Specialist (CVS) or as a Value Methodology Practitioner (VMP). Team leadership can be supplied from within the region, from another region, or from Headquarters. A statewide pool of qualified team leaders is maintained by the State VE Coordinator, who works with the Region VE Coordinator to select the team leader.

When using consultant team leaders, SAVE certification is required.

310.03(4)(e) VE Team Members

The VE team is typically composed of five to ten people with diverse expertise relevant to the specific study. The team members may be selected from the regions; Headquarters; other local, state, or federal agencies; or the private sector.

Team members are not directly involved in the planning and development phases of the project. They are selected based on the identified expertise needed to address the major functional areas and critical high-cost issues of the study. All team members must be committed to the time required for the study. It is desirable for team members to have attended Value Engineering Module 1 training before participating in a VE study.

310.04 VE Procedure

The VE analysis uses the Seven-Phase Job Plan shown in [Exhibit 310-1](#). A detailed discussion of how each phase is supposed to be conducted can be found in the document, *Value Methodology Standard and Body of Knowledge*, developed by SAVE International, The Value Society. This document can be downloaded at the SAVE website: www.value-eng.org/

310.04(1) Pre-Study Preparation

To initiate a VE study, the project manager submits a Request for Value Engineering Study form to the Region VE Coordinator at least two months before the proposed study date. The form is located on the WSDOT value engineering website:

www.wsdot.wa.gov/design/valueengineering/tools/

The Region VE Coordinator then works with the State VE Coordinator to determine the team leader and team members for the VE study. Contacts are listed on the WSDOT value engineering website: www.wsdot.wa.gov/design/valueengineering

The design team prepares a study package of project information for each of the team members. (A list of potential items is shown in [Exhibit 310-2](#)). Work with the State VE Coordinator for the best/most concise list of materials to send to the team members. If the package is provided via a network drive or FTP site, make sure the materials are well titled and sorted in a well-titled file structure. The VE team members should receive this information or a link to this information at least one week prior to the study so they have time to review the material.

The region provides a facility and the equipment for the study (see [Exhibit 310-2](#)).

310.04(2) *VE Analysis Requirements*

The time required to conduct a VE analysis varies with the complexity and size of the project, but typically ranges from three to five days. The VE team leader working with the project manager will determine the best length of time for the study.

The VE analysis Final Report includes an executive summary; a narrative description of project information; the background, history, constraints, and controlling decisions; the VE team's focus areas; a discussion of the team's speculation and evaluation processes; and the team's final recommendations. All of the team's evaluation documentation, including sketches, calculations, analyses, and rationale for recommendations, is included in the Final Report. A copy of the Final Report is to be included in the Project File. The project manager will specify the number of copies to be provided to the project team. The State VE Manager also provides a copy of the report to the FHWA for projects on the National Highway System or federal-aid system.

Post-VE analysis activities include:

- Implementation and evaluation of the approved recommendations and their outcomes.
- Documentation of the reasons for not implementing approved recommendations.

Note: These post-analysis activities are conducted prior to the final design phase to ensure the recommendations are included in the final design or the reasons for not implementing the recommendations are included in the design documentation.

310.04(3) *Resolution Phase (Phase 7 of the VE Study)*

As soon as possible, preferably no more than two weeks following the VE analysis, the project manager reviews and evaluates the VE team's recommendation(s). The project manager completes the VE Recommendation Approval form included in the Final Report and returns it to the Statewide VE Manager.

For each recommendation that is not approved or is modified by the project manager, the project manager provides justification in the form of a VE Decision Document. The VE Decision Document includes a specific response for each of the disapproved or modified recommendations. Responses include a summary statement containing the project manager's decision not to use the recommendations in the project.

The project manager sends the completed VE Recommendation Approval form and, if necessary, the VE Decision Document to the State VE Manager within three months following receipt of the Final Report or by September 1 of each year, whichever comes first, so the results can be included in WSDOT's annual VE Report to FHWA.

A VE Decision Document must be submitted and forwarded to the Director & State Design Engineer, Development Division, for review. The only time a VE Decision Document is not submitted is if all of the recommendations were adopted and implemented (in other words, no recommendations were rejected or modified).

Exhibit 310-1 Seven-Phase Job Plan for VE Studies

VE Study Phase	Job Plan
1. Information Phase	Gather project information, including project commitments and constraints. <ul style="list-style-type: none"> • Investigate technical reports and field data • Develop team focus and objectives
2. Function Analysis Phase	Analyze the project to understand the required functions. <ul style="list-style-type: none"> • Define project functions using active verb/measurable noun context • Review and analyze these functions to determine which need improvement, elimination, or creation to meet project goals
3. Creative Phase	Generate ideas on ways to accomplish the required functions that improve project performance, enhance quality, and lower project costs. <ul style="list-style-type: none"> • Be creative • Brainstorm alternative proposals and solutions to lower project costs, improve project performance, and enhance quality
4. Evaluation Phase	Evaluate and select feasible ideas for development. <ul style="list-style-type: none"> • Analyze design alternatives, technical processes, and life-cycle costs
5. Development Phase	Develop the selected alternatives into fully supported recommendations. <ul style="list-style-type: none"> • Develop technical and economic supporting data to prove the benefits and feasibility of the desirable concepts • Develop team recommendations (long-term as well as interim solutions)
6. Presentation Phase	Present the VE recommendation to the project stakeholders. <ul style="list-style-type: none"> • Present the VE recommendation to the project team and region management in an oral presentation • Provide a written report
7. Resolution Phase	Evaluate, resolve, and implement all approved recommendations and document in the VE Recommendation Approval form and VE Decision document.
Note: Phases 1–6 are performed during the study; see <i>Value Standard and Body of Knowledge</i> for procedures during these steps.	

Exhibit 310-2 VE Analysis Team Tools

Project-Related Input* and Design Resources (Study Package)
Vicinity map
Aerial photos
Large-scale aerial photographs
Pertinent maps - Land use, contours, quadrant, etc.
Crash data with collision analysis
Existing as-built plans
Design file
Cross sections and profiles
Environmental documents Environmental constraints, and commitments
Estimates
Geotechnical reports
Hydraulic Report
Plan sheets
Quantities
Right of way plans
Bridge condition report
<i>Bridge List</i>
<i>Design Manual</i>
<i>Field Formulas</i> and <i>Field Tables</i>
<i>Standard Plans</i>
<i>Standard Specifications</i>
<i>State Highway Log</i>
<i>Other manuals</i> as needed

Study-Related Facilities and Equipment
AASHTO Green Book
Calculators
Computer / projector
Easel(s) and easel paper pads
Marking pens
Masking and clear tape
Network computer access (if available)
Power strip(s) and extension cords
Room with a large table and adequate space for the team
Scales, straight edges, and curves
Telephone
Vehicle or vehicles with adequate seating to transport the VE team for a site visit**

*Not all information listed may be available to the team, depending on the project stage. Work with the State VE Coordinator to verify that all needed information is available.

**If a site visit is not possible, provide video of the project.

310.05 Value Engineering Combined with Risk Assessment (VERA)

Project managers are encouraged to explore the possibility of combining their Value Engineering Study with a Cost Risk Assessment. This offers the possibility of efficiently and effectively accomplishing both processes in a timely manner. Exhibit 310-3 depicts the process for combining VE and risk assessment.

Exhibit 310-3 VERA Process

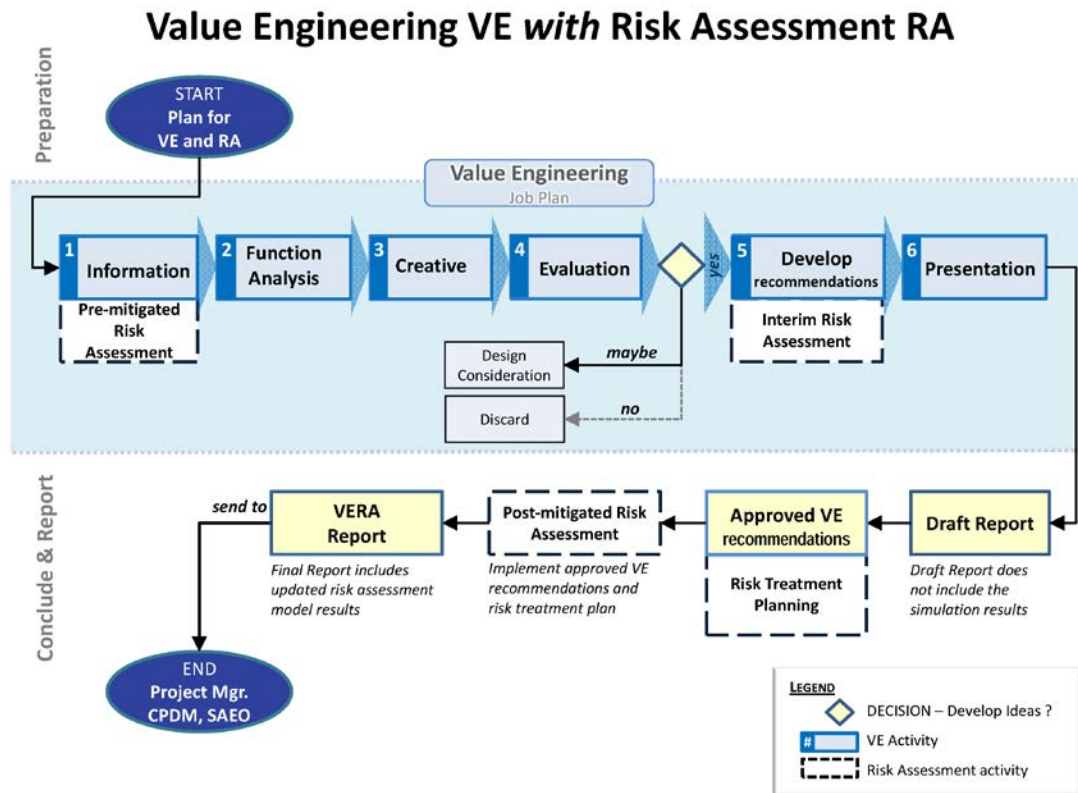

310.06 Practical Design Workshops

Practical design is an approach to making project decisions that focuses on the need for the project and looks for the lowest-cost solutions. This objective is similar to the objectives of value engineering studies, which break projects into their most basic functions and attempt to generate low-cost or high-value solutions for those individual functions. WSDOT has created a Practical Design Peer Review, utilizing some value engineering methods to assist project teams with focusing on the project problem statement or “need.”

The peer review is scalable, generally one day with some advanced preparation. The peer review utilizes a multidisciplinary team to discuss and validate the reason the project exists. Properly identifying, and isolating, the project need from the project scope enhances the focus on scope elements to resolve the most basic need. Depending on the scale and objectives requested for the workshop, the study team may advance the redefined needs statement into the speculation phase, taking advantage of the multidisciplinary team to creatively brainstorm based on potential contributing factors informed by each discipline. In some cases, there may be sufficient time to narrow potential solutions/strategies identified using common VE evaluation methods.

The Practical Design Workshop is another tool to help refocus project teams toward a least-cost solution. Findings and discussion from the workshop may also help inform design deviations for elements typically required by the project type, but not necessary to resolve the refined need statement generated.

For more information and examples of Practical Design, see the following:

<http://www.wsdot.wa.gov/projects/practicaldesign/>

310.07 Project Management Accountability

WSDOT is required to make a determination about every VE recommendation generated. To that end, project managers, in consultation with their project teams, support staff, other management support, and subject matter experts, make a determination within two months regarding the action that will be taken about each recommendation.

Project management organization for value engineering (as well as cost risk assessment) is found in the Master Deliverables List (MDL) (see Exhibits 310-4 and 310-5).

Exhibit 310-4 Master Deliverables List of Value Engineering Project Elements

MDL Code	MDL Name	Description
PE.PD.10	Value Engineering	A systematic process designed to focus on the major issues of a complex project or process.
PE.PD.10.01	VE Study	A systematic process designed to focus on the major issues of a complex project or process. It uses a multidisciplinary team to develop recommendations for value improvement. (See <i>Design Manual Chapter 310</i> for details.) All projects (such as construction, right of way, preliminary engineering, utilities) with a total estimated cost over \$25 million and any bridge project over \$20 million will need to have a VE study.
PE.PD.10.02	VE Final Report	The VE study Final Report and Workbook should include a narrative description of project; background and history; constraints and drivers, identified needs; VE team focus areas; and a discussion of the team speculation, evaluation, and recommendations. All other evaluation documentation, including sketches, calculations, analysis, and rationale for recommendations, must be included in the Workbook as part of the Final Report.
PE.PD.10.03	VE Recommendations Response	The project team's responses to the VE team recommendations should be provided to the Regional Managers for use in developing the VE Decision Document. The VE Recommendations Response is documented on the Value Engineering Recommendation Approval Form. The project team completes it and send it to HQ VE Coordinator after they have evaluated and quantified the actual savings or cost added.

Exhibit 310-5 Master Deliverables List of Cost Risk Assessment Project Elements

MDL Code	MDL Name	Description
PE.PD.04	Cost Risk Estimate & Management	Cost Risk Estimate and Management (CREM) is an integral phase of project risk management. The CREM starts with a risk assessment that it is documented on a Cost Risk Analysis Report that may be delivered via: Cost Estimating and Validation Process (CEVP®), Cost Risk Analysis (CRA), or Combined Value Engineering and Risk Analysis (VERA). For more information, see the Cost Risk Estimate & Management website at: www.wsdot.wa.gov/projects/projectmgmt/riskassessment/
PE.PD.04.01	CEVP®	A Cost Estimate Validation Process (CEVP®) is required for any project with an estimated cost of \$100 million or more. Refer to the Cost Risk Estimate & Management website above.
PE.PD.04.02	CRA Workshop	A Cost Risk Assessment (CRA) is required for all projects with an estimated cost of \$25 million or more. Refer to the Cost Risk Estimate & Management website above.
PE.PD.04.03	Informal Cost Risk Analysis	An informal Cost Risk Analysis is required for all projects of \$10 million to \$25 million. Refer to the Cost Risk Estimate & Management website above.
PE.PD.04.04	Qualitative Risk Assessment	A qualitative risk assessment is required for all projects. Refer to the Cost Risk Estimate & Management website above.
PE.PD.04.05	Combined Value Engineering and Risk Analysis and (VERA)	When it is appropriate the efforts of cost risk analysis and values engineering may be combined. Refer to the Cost Risk Estimate & Management website above.
PE.PD.04.06	Risk Management Plan	A document prepared by Regional Managers that includes specific responses for each of the risk identified. Refer to the Cost Risk Estimate & Management website above.

310.08 Documentation

Refer to [Chapter 300](#) for design documentation requirements.

The following value engineering documentation is required:

- **Project File** – Value Engineering Final Report
- **Design Documentation Package** – Value Engineering Recommendation Approval Form
- **Project File** – Value Engineering Decision Document

- 320.01 General
- 320.02 Design Year and Forecasting Considerations
- 320.03 Traffic Analysis Software
- 320.04 Travel Demand Forecasting
- 320.05 Traffic Impact Analysis (TIA)
- 320.06 TIA Scope
- 320.07 TIA Methods and Assumptions Document
- 320.08 TIA Methodologies
- 320.09 TIA Mitigation Measures
- 320.10 TIA Report
- 320.11 References

320.01 General

This chapter is intended to address policy-related issues associated with Washington State Department of Transportation (WSDOT) multimodal traffic analysis. It is not intended to address the specifics of demand forecasting; mesoscopic, analytical/deterministic, stochastic microsimulation; or safety performance analyses. For those items, see the latest versions of the *Highway Capacity Manual*, *Traffic Analysis Procedures Manual* (TAPM), and *Highway Safety Manual* (HSM).

Traffic analysis is intended to produce information for decision makers; it is not intended as a stand-alone tool for making decisions. Consideration of empirical data, similar traffic situations, studies, local knowledge, and seasoned traffic engineering and planning experience can also add to a pool of traffic information that is provided to decision makers.

Traffic analysis is either “operational” or “planning” in nature. Operational analysis is associated with engineering concepts focusing on near-term or existing/opening year, while planning analyses are generally focused on a horizon year or interim phase years. Planning-level analyses are also used to determine impacts for environmental documentation phases of Environmental Assessment (EA) or Environmental Impact Statement (EIS) work. Much caution should be used when operational tools are used with planning-level future year projection data.

Be aware that operational models were not primarily intended for use with planning-level future year projected volumes, but there is a need to understand the difference between proposed future scenarios. Therefore, operational models need to use data from forecasting models, but analysts need to do so with an understanding of the imperfections.

Forecasting demand volumes 20 years into the future can be difficult to do well, so there should be little expectation that intersection turning movement projection-related traffic analyses by themselves will be sufficient to produce actionable designs. Consequently, some future year Measures of Effectiveness (MOEs) such as turn lane queue length should not be considered accurate, but they may be useful when comparing various scenarios if the reported differences are substantial.

With the aforementioned limitations, project-specific traffic volumes, forecasts, and system capacities are used to establish the extent of improvements needed for facilities to operate acceptably from year of opening or through interim phases and, eventually, through to the horizon year; for example:

- Number of general purpose/HOV/HOT lanes
- Length and number of ramp or auxiliary lanes
- Intersection or interchange spacing
- Channelization
- Signal timing
- Right of way needs
- Roundabout design parameters
- Width of sidewalks
- Extent of bike lanes
- Ferry holding lanes

Traffic analysis should examine multimodal access, mobility, and safety objectives; project benefits and costs; development impacts; and mitigation needs.

Not all projects will require the same level of effort. The specific depth and complexity of a traffic analysis will depend on a variety of factors, including:

- Project proponents (federal, tribal, state, local, and private sector)
- Legal requirements (laws, regulations, procedures, and contractual obligations)
- Lead agency
- Purpose or scope of the traffic analysis
- Data availability
- Time of day (am/pm peak hour or other)
- Funding
- ROW availability

For projects that fall under FHWA approval, coordinate with the Headquarters (HQ) Traffic Office for concurrence on traffic analysis details. Other projects can be coordinated through region Traffic offices. (See [Chapter 300](#) for FHWA oversight and approval policy.)

320.02 Design Year and Forecasting Considerations

Project evaluation requirements can be (1) focused on near-term functionality, (2) contain interim phases, and/or (3) require a long-term focus. The project proponent can be the state (WSDOT or other state agencies) or developers (other public agencies or private concerns).

For Interchange Justification Reports (IJR), the design year and multimodal travel demand forecasting methodologies are to be documented by the project stakeholders in the Methods and Assumptions (M&A) Documents.

Guidance on the horizon year and interim design year(s) for projects is given in [Chapter 1103, Design Controls](#).

When selecting horizon year and interim design year phases, stakeholders need to consider the regional significance of a proposed project, how it functions within the existing system, and the expected lifespan. The traffic analysis for developer-related projects will typically focus on existing conditions and the build-out year of the proposed project. Some larger developer projects will need to be evaluated in multiple phases, as they have the potential to significantly impact the transportation system and will thus require a longer-term focus. Mitigation measures may also be phased with these projects.

Project teams are encouraged to consider the strategic importance, economic potential, network constraints, and investment scale when determining the analysis methodologies for project phasing, design year, and forecasts. With acceptance/concurrence by the Traffic Office of purview,¹ the following are possible approaches to be used individually or in concert to develop future year demand volumes:

- Travel demand models
- Trend line projections
- Cumulative impacts
- Limitations of the surrounding network

320.03 Traffic Analysis Software

With acceptance by the Traffic Office of purview, use the least complex and data-intensive software deemed reasonable for any given project. Agreement for software and versions must be documented in the study's M&A. Use the latest version sanctioned by WSDOT HQ Traffic.

- For near-term analysis of locations that do not require an understanding of interactions between various transportation systems, Sidra, Rodel, Synchro, and HCS are the primary analytical tools.
- For systemwide multimodal complex forecasting, EMME3, TransCad, and Visum are the primary tools.
- For choosing between scenarios involving multimodal traffic and/or where various transportation system elements interact, CORSIM, Vissim, or Dynameq are the primary tools.

The software mentioned above may have version limitations due to WSDOT purchased rights and contract limitations. For details about these and other traffic analysis software used by WSDOT, see the [Traffic Analysis Procedures Manual](#) or contact the region or HQ Traffic Office.

320.04 Travel Demand Forecasting

Designers, planners, and analysts need to be aware of the practical limitations of the selected method of multimodal traffic demand forecasting and should consider the impact of demand uncertainty when conducting analyses and drawing conclusions from those analyses. Special attention should be given to any post-processing efforts. For guidance in the selection of analysis methodology, refer to the [Traffic Analysis Procedures Manual](#). Following are brief descriptions of the four main methods for demand forecasting.

¹ See [Chapter 300](#) and the Federal-Aid Highway Program Stewardship and Oversight Agreement: Generally, region for non-Highways of Statewide Significance (HSS) or non-National Highway System (NHS), and Headquarters for HSS and NHS.

320.04(1) Travel Demand Models

For the vast majority of projects, this will be the proper approach for developing future year demand volumes. However, caution should be taken when using this approach to draw conclusions from operational model Measures of Effectiveness (MOEs) that are based on such forecasts, because specific and accurate turning movement volumes are needed to produce credible MOEs. Forecast models are most commonly used to produce general volumes that can help traffic planners evaluate and compare the relative merits of potential solutions against each other.

320.04(2) Trend Line Projections

Where travel demand models are not established or are otherwise considered inadequate, trend data can be used but must be constrained by system flow limitations. Trend line growth cannot account for peak spreading when traffic demand exceeds system supply. Use with caution and consult the [HQ Transportation Data & GIS Office](#) (TDGO) for further details about this method and any inherent limitations.

320.04(3) Cumulative Impacts

This method is typically used to forecast volumes in areas that demonstrate uniform growth and exhibit only minor changes and marginal impacts to the region. It is also useful for analyzing growth in suburban areas that are experiencing rapid development, as other methods may not be as reliable. The basic concept is to add volumes for developments to the trending background traffic growth. The comprehensive plan for such areas should be consistent with the expected growth predicted by a project (and include other anticipated projects) in order to result in a reasonable estimate of cumulative impacts. Use with caution due to an inability to fully account for secondary impacts like future environmental issues, local network connectivity, public services, and multimodal demands.

320.04(4) Limitations of the Surrounding Network

For projects that contain infrastructure of particular importance, extraordinary expense, life span expectancy beyond 20 years, or where travel demand will likely always exceed transportation system capacity constraints, give consideration to the concept of facility capacity balancing within the context of the larger transportation system.

This approach needs to demonstrate that the maximum amount of upstream traffic flowing into a project, as well as all project-area traffic flowing into downstream sections, can be handled acceptably. This does not require traditional travel demand forecasting, which has a limitation of about 20 years. Instead, it requires a sensitivity approach where maximum up- and downstream flows are used to right-size the project area's proposed improvements. The simplest example is the SR 520 Floating Bridge: constraints on either end of the bridge limit the usefulness of adding more lanes on the bridge.

TIA and IJR (see [Chapter 550](#)) shall clearly describe the methodology and process used to develop forecasts in support of a proposed project's analysis. For example, include only those projects that:

- Are on the six-year Transportation Improvement Plan.
- Are fully funded.
- Have entered the environmental review process.

320.05 Traffic Impact Analysis (TIA)

TIA is a term used for all analyses that are not structured IJR (see [Chapter 550](#)) or planning-level efforts like corridor studies. The quality and level of service² for state-owned and state-interest facilities shall be based upon MOEs that support the project purpose and need. They shall also be developed and presented in accordance with the latest versions of the *Highway Capacity Manual* (HCM), [FHWA Traffic Analysis Toolbox](#), [Traffic Analysis Procedures Manual](#), and WSDOT Vissim Protocol.

For some example MOEs, see the [FHWA MOE List](#), which describes measures typically used for analyzing state and local agency facilities such as freeway segments, signalized intersections, ramp terminals/junctions, sidewalks, and transit services.

Depending on the facility and when HCM Level of Service MOE is used, WSDOT thresholds are “C” for rural and “D” for urban non-NHS facilities, unless a WSDOT region specifies otherwise for specific route segments. (See each WSDOT region for details.) Refer to the [WSDOT State Highway Log](#) for a determination of existing route segment definitions for urban or rural status.

Depending on the project type and purpose, multimodal MOEs may be employed.

320.05(1) Updating an Existing TIA

TIAs require either updating or a sensitivity analysis if they become more than 3 years old; however, a TIA will require updating sooner in rapidly developing areas. TIAs can avoid such update efforts in slowly developing areas. To determine if an update is required, an assessment of critical infrastructure functionality must be documented.

If the amount or character of traffic in the study area is significantly different from an earlier analysis, an update will be required. The definition of significant is 10% (volume, flow rate, travel time, delay, density, or other key MOEs) where existing operations are currently acceptable. If they are not currently acceptable, the threshold is reduced to 5%. In cases where greater than 10% change or failed MOEs have been found, consultation and concurrence with WSDOT Traffic Office of purview is required to avoid a full IJR or TIA update.

Developer-initiated TIAs are typically valid for 5 or 6 years, as that is the window provided under the Growth Management Act for concurrency. The Development Services Office should be consulted regarding the need for updates to TIAs for developer, tribal, and local agency projects.

320.06 TIA Scope

To establish the appropriate scope, consultation between the lead agency, WSDOT, and those preparing the TIA is encouraged before beginning work. TIA-required elements can be found in the [Traffic Analysis Procedures Manual](#) (an abbreviated list is provided below). **Note:** For developer-initiated TIAs, the local agency may prescribe the scope of the TIA per the local agency’s adopted standards.

² WSDOT sets level of service (LOS) standards for state highways and ferry routes of statewide significance (HSS) based on [RCW 47.06.140\(2\)](#). Regional transportation planning organizations (RTPOs) and WSDOT jointly develop and RTPOs establish LOS standards for regionally significant state highways and ferry routes (non-HSS) based on [RCW 47.80.030\(1\)\(c\)](#).

320.06(1) TIA Boundaries

The traffic impacts of local streets and roads can impact intersections on state highway facilities. In these cases, include in the TIA an analysis of adjacent local facilities (driveways, intersections, main lines, and interchanges) upstream and downstream of the intersection with the state highway. A “lesser analysis” may include obtaining traffic counts, preparing signal warrants, or a focused TIA. For developer projects, the boundaries of the analysis (such as the city limits) may be determined in consultation with local agencies and WSDOT. For further guidance, consult the [Traffic Analysis Procedures Manual](#) and [Development Services Manual](#).

320.06(2) Traffic Analysis Scenarios

WSDOT must understand the effects of plan updates and amendments, as well as the effects of specific project elements (including site plans, conditional use permits, subdivisions, and rezoning) that have the potential to impact state facilities. Consultation between the lead agency, WSDOT, and those preparing the TIA is essential early in the process to help determine appropriate scenario analyses and goals. For further guidance, consult the [Traffic Analysis Procedures Manual](#) and [Development Services Manual](#).

Depending on the type of work being analyzed, required TIA scenarios can range from simple “existing conditions with and without project,” to more complex analyses where TIA scenarios could include: existing; opening year with and without project; interim years with and without project; and design year with and without project. If developed with WSDOT, and if following IJR guidance, pre-IJR work such as Area Study TIAs can be used in future IJR.

The appropriate and necessary scenarios shall be agreed upon by the TIA study team and documented in the TIA Methods and Assumptions (M&A) Document.

For existing networks, calibrate models to existing conditions.

If a near-term baseline network is required, only funding-secured projects should be added to the existing network. This is typical of opening year models that are a few years beyond existing year.

For interim scenario networks, include only projects or developments within the forecasting process that have the highest probability within the 10-year horizon. For example, include projects that are fully funded or have a construction phase in the six-year Transportation Improvement Plan.

For scenarios with phases beyond 10 years, TIA or IJR teams should discuss and document the merits of including other potential projects. For example:

- Projects on current long-range regional transportation plans (or the locally-adopted transportation plan, if the TIA is not on a regionally-significant facility)
- Projects on the HSP or MTP

All other potential influences with lower probability should not be allowed to affect travel or trip demand forecast results—with one exception: TIAs and IJR s may include multiple scenarios for the design year. For example, if a major assumption for unfunded additional lanes “feeding traffic into” or “allowing traffic from” the project is desired for the design year to allow for a better understanding of expensive infrastructure sizing (such as ultimate bridge widths), ensure a constrained design year scenario is included so that proper funding-based phasing solutions are communicated.

320.07 TIA Methods and Assumptions Document

The TIA M&A is similar to an IJR M&A in that it documents the “who, what, where, when, how, and why” items associated with the traffic analysis portion of a project.

Prior to any substantial fieldwork or traffic/facility data collection, consultation between the lead agency, WSDOT, and those preparing the TIA is encouraged to help reach and document consensus on study data needs and assumptions. These and other items should be documented and the M&A signed by all lead staff that conduct work in association with the TIA M&A document. For further guidance, consult the [Traffic Analysis Procedures Manual](#) and [Development Services Manual](#).

320.08 TIA Methodologies

The [FHWA Traffic Analysis Toolbox](#), Volume 2, provides a methodology for selecting traffic analysis tools. However, in general, traffic analysis methodologies for those facility types indicated below are used by WSDOT and will be accepted if agreed upon by those who sign TIA or IJR M&A Documents.

- **Freeway Segments:** *Highway Capacity Manual/Software* (HCM/S); operational and design analysis; macroscopic, mesoscopic, and microsimulation
- **Weaving Areas:** *Design Manual* (DM); HCM/S; operational and design analysis; microsimulation
- **Ramps and Ramp Terminals:** HCM/S; operational and design analysis; DM; microsimulation
- **Multilane Highways:** HCM/S; operational and design analysis; macroscopic, mesoscopic, and microsimulation
- **Two-Lane Highways:** HCM/S; operational and design analysis
- **Intersection, Signalized:** Sidra; Synchro; SimTraffic; HCM/S; Vissim,
- **Intersection, Roundabout:** Sidra; Rodel; HCM; Vissim
- **Corridors:** Sidra; Synchro; SimTraffic; HCM; Vissim
- **Stop-Controlled Intersections:** HCM/S for capacity; DM [Chapter 1330](#) and the [MUTCD](#) for signal warrants (if a signal is being considered)
- **Transit:** HCM/S; operational and design analysis; [Traffic Manual](#)
- **Pedestrians:** HCM/S
- **Bicycles:** HCM/S

- **WSDOT Criteria/Warrants:** [MUTCD](#) (signals, stop signs); [Traffic Manual](#) (school crossings); DM [Chapter 1040](#) (freeway lighting, conventional highway lighting)
- **Channelization:** DM

The procedures in the *Highway Capacity Manual* do not explicitly address operations of closely spaced signalized intersections, nor does WSDOT currently endorse microsimulation or roundabout guidance as noted in the HCM/S. Under such conditions, several unique characteristics must be considered, including spill-back potential from the downstream intersection to the upstream intersection; effects of downstream queues on upstream saturation flow rates; and unusual platoon dispersion or compression between intersections. An example of such closely spaced operations is signalized ramp terminals at urban interchanges. Queue interactions between closely spaced intersections can seriously distort the results of analyses that follow the procedures in the HCM.

Other analysis methods may be accepted; however, consultation between the lead agency, region or HQ Traffic, and those preparing the TIA is encouraged to reach consensus on the data necessary for the analysis if meso- or microsimulation is employed. When a state highway has saturated flows, the use of a meso- or microsimulation models can provide additional understanding. Note, however, that the simulation model must be calibrated and validated for reliable results and is intended for near-term operational analyses (see the [Traffic Analysis Procedures Manual](#) for guidance on calibration and validation).

Operational MOEs for simulation models based on long-term forecasts should be used primarily to determine which scenarios are better than others. The models can only do so if the resultant MOEs demonstrate significant differentiation between scenarios. TIA or IJR teams will determine what is considered significant and will document those findings in the study. However, at a minimum, significant must be greater than the expected error band of the models used. For example, if Vissim is considered to be calibrated to a given MOE within 15% of existing conditions (a very wide band), the scenarios need to show greater than 15% differentiation between each other to be significant.

320.09 TIA Mitigation Measures

Consultation between the lead agency, WSDOT, and the responsible parties preparing the TIA is recommended in order to reach consensus on the project mitigation measures. Mitigation measures, if applicable, need to be included in the TIA to determine whether a project's impacts can be eliminated or reduced to a level of insignificance. Eliminating or reducing impacts to a level of insignificance is the standard pursuant to the State Environmental Policy Act (SEPA) and National Environmental Policy Act (NEPA). The lead agency is responsible for administering the SEPA and/or NEPA review process. WSDOT is responsible for reviewing the TIA for impacts that pertain to state highway facilities. However, the authority vested in the lead agency under SEPA/NEPA does not take precedence over other authorities in law.

Development work in the state highway right of way requires a WSDOT permit or agreement. Normally, this work is coordinated by the region Development Services Office.

Mitigation measures may take the following forms:

- Channelization such as turn lanes or raised islands
- Installation of a roundabout or, if necessary, a traffic signal (signal warrant analysis per [MUTCD](#) is required)
- Frontage improvements
- Donation of right of way
- Addressing any design or operational deficiencies created by the proposal
- Possible restrictions of turning movements
- Sight distance enhancements
- Traffic mitigation payment (pro rata share contribution) to a programmed WSDOT project (see Chapter 4 of the [Development Services Manual](#))
- Satisfaction of local agency guidelines and interlocal agreements

320.10 TIA Report

320.10(1) TIA Minimum Contents

The minimum contents of a TIA report are listed in the [Traffic Analysis Procedures Manual](#) and [Development Services Manual](#). Listed below is a summary; however, the depth and detail of content under each element varies in relation to the scale and complexity of the project.

(a) Executive Summary

(b) Table of Contents

1. List of Exhibits (Maps)
2. List of Tables

(c) Introduction

1. Description of the proposed project with purpose and need.
2. Traffic Impact Analysis Methods and Assumptions summary.
3. Map of project location.
4. Site plan, including all access to state highways (site plan, map).
5. Circulation network, including all access to state highways (vicinity map).
6. Land use and zoning.
7. Phasing plan, including proposed dates of project (phase) completion.
8. Project sponsor and contact person(s).
9. References to other traffic impact studies.
10. Other mitigation measures considered.

(d) Traffic Analysis

1. TIA M&A (see the [Traffic Analysis Procedures Manual](#) for a template or the [Development Services Manual](#)).
2. Existing and projected conditions of the site: posted speed; traffic counts (to include turning movements); sight distance; channelization; design deviations; pedestrian and bicycle facilities; design vehicle; and traffic controls, including signal phasing and multi-signal progression where appropriate (exhibit(s)).
3. DHV and ADT; project trip generation and distribution map, including references and a detailed description of the process involved in forecasting the projected trips, including tables.
4. Project-related transportation mode split, with a detailed description of the process involved in determining transportation mode split.
5. Project-generated trip distribution and assignment with a detailed description of the process involved in distributing and assigning the generated traffic, including exhibit(s).
6. If intersection control additions are employed and traffic signals are assumed, include functionality and warrant analyses. With roundabouts or signals, include existing conditions, cumulative conditions, and full-build of plan conditions with and without project.
7. Safety performance analysis (see [Chapter 321](#) and the [Traffic Analysis Procedures Manual](#)).

(e) Conclusions and Recommendations

1. Quantified or qualified LOS, QOS, and other appropriate MOEs of impacted facilities with and without mitigation measures.
2. Predicted safety performance with and without mitigation measures.
3. Mitigation phasing plan with dates of proposed mitigation measures.
4. Defined responsibilities for implementing mitigation measures.
5. Cost estimates for mitigation measures and financing plan.

(f) Appendices

1. Description of traffic data and how data was collected and manipulated.
2. Description of methodologies and assumptions used in analyses.
3. Worksheets used in analyses; for example, signal warrants, LOS, QOS, and traffic count information.
4. If microsimulation is used, provide a copy of the Confidence and Calibration Report.

320.11 References

320.11(1) Federal/State Laws and Codes

[42 United States Code 4321](#), National Environmental Policy Act (NEPA) of 1969

[Revised Code of Washington \(RCW\) 43.21C](#), State environmental policy ([Chapter 197-11 WAC](#) and [Chapter 468-12 WAC](#))

[RCW 36.70a](#), Growth Management Act

[RCW 36.70A.070](#), Comprehensive plans – Mandatory elements

[RCW 47.06.140](#), Transportation facilities and services of statewide significance – Level of service standards

[Washington Administrative Code \(WAC\) 365-196-430](#), Transportation elements of comprehensive plans

[Manual on Uniform Traffic Control Devices for Streets and Highways](#), USDOT, FHWA; as adopted and modified by [Chapter 468-95 WAC](#) “Manual on uniform traffic control devices for streets and highways” (MUTCD)

320.11(2) Design Guidance

Design Manual, [Chapter 321](#), for sustainable safety

Design Manual, [Chapter 550](#), for interchange justification report guidelines

Design Manual, [Chapter 1300](#), for selecting intersection control type

Design Manual, [Chapter 1310](#), for intersection guidelines

Design Manual, [Chapter 1320](#), for roundabout guidelines

Federal-Aid Highway Program Stewardship and Oversight Agreement:

<http://www.wsdot.wa.gov/nr/rdonlyres/Of8eaddb-7fcc-4ea0-8609-5bca74634ebd/0/fhwawsdotstewardshipagreement.pdf>

Highway Capacity Manual (HCM), latest edition, Transportation Research Board, National Research Council

[Level of Service Standards for Washington State Highways](#)

Roadside Design Guide and *A Policy on Geometric Design of Highways and Streets*, latest editions, American Association of State Highway and Transportation Officials (AASHTO)

[Standard Plans for Road, Bridge, and Municipal Construction \(Standard Plans\)](#), M 21-01, WSDOT

[Traffic Analysis Procedures Manual \(TAPM\)](#)

WSDOT Traffic Analysis web page:

<http://www.wsdot.wa.gov/design/traffic/analysis/>

320.11(3) Supporting Information

Development Services Manual, M 3007.00, WSDOT

FHWA Traffic Analysis Toolbox:

 <http://www.ops.fhwa.dot.gov/trafficanalysistools/index.htm>

Traffic Manual, M 51-02, WSDOT

“Trip Generation,” Institute of Transportation Engineers (ITE)

WSDOT’s Highway Segment Analysis Program

WSDOT’s *Mobility Project Prioritization Process Manual* and Workbook:

 www.wsdot.wa.gov/mapsdata/travel/mobility.htm

WSDOT’s Planning Level Cost Estimation (PLCE) Tool

- 321.01 General
- 321.02 General Sustainable Safety Process
- 321.03 Sustainable Safety for I-2 Projects
- 321.04 Sustainable Safety for P3 – Major Signal and Illumination Projects
- 321.05 Sustainable Safety for I-1 and I-3 Projects
- 321.06 Stand-Alone Sustainable Safety Applications
- 321.07 Safety Analysis Resources and Tools
- 321.08 Reports and Documentation
- 321.09 References

321.01 General

The Washington State Strategic Highway Safety Plan, “Target Zero” has a vision to reduce traffic fatalities and serious injuries to zero by 2030. WSDOT is pursuing this goal along with partners such as Washington State Patrol (WSP) and Washington Traffic Safety Commission (WTSC). WSDOT recognizes that risk exists in all modes of transportation. The universal objective is to reduce the number and severity of crashes within the limits of available resources, science, technology, and legislatively mandated priorities.

The [Secretary’s Executive Order E1085, Sustainable Highway Safety Program](#), sets the policy for the Washington State Department of Transportation (WSDOT) to embark on a targeted and scientifically-based Engineering approach for identifying and addressing crash risks that is multimodal and coordinated with the other three “E”s, Education, Enforcement, and Emergency Services. Sustainable Safety employs a “5th E”, Evaluation, the analysis and diagnosis of crashes and to target their contributing factors in addressing highway safety performance. Evaluation relies on quantifying safety performance using scientific tools and assessment techniques to determine appropriate safety countermeasures.

Sustainable Safety is the approach to transportation safety at WSDOT through the use of “...tools and procedures based on accepted science, data, and proven practice” in accordance with [Secretary’s Executive Order E 1096, Agency Emphasis and Expectations](#), to target safety needs, and “deliver the right solutions at the right time and at the right location.”

Practical Solutions is an approach to making project decisions that focus on resolving the project need for the least cost without adversely impacting safety performance. Sustainable Safety is the approach for resolving safety performance within WSDOT’s Practical Solutions as directed in both E 1096 and [Secretary’s Executive Order E 1090, Moving Washington Forward: Practical Solutions](#).

[E 1085](#) directs engineers to base project-level decisions on safety analysis of specific locations and corridors and focus on proven lower-cost targeted countermeasures at specific locations that optimize the return on investment of safety dollars. These lower-cost investments allow for additional identified locations to be addressed. Sustainable Safety is therefore an essential part of successful Practical Design implementation. It provides the process and methods to incorporate safety performance assessment and peer-review into Performance-Based Practical Design. Sustainable Safety allows the planner, engineer, and decision maker, to identify and quantify the safety performance of alternatives during project development.

Implementing Sustainable Safety improves WSDOT's effectiveness in reducing the risk of fatal and serious injury crashes statewide. It focuses on the contributing factors and types of crashes through the use of state-of-the-art principles and analytical methods to diagnose, quantify, and predict safety performance. The Sustainable Highway Safety Policy directs WSDOT to use effective and efficient resources, like the *AASHTO Highway Safety Manual (HSM)* to achieve the goals of the Washington State Strategic Highway Safety Plan: Target Zero. This approach:

1. Optimizes the reduction in the risk of fatal and serious injury crashes on Washington's highways.
2. Provides reliable and accurate assessment of crash risk.
3. Identifies locations of risk that have a higher potential for crash reduction.
4. Provides reliable and accurate assessment of potential crash reduction benefits.
5. Identifies and deploys solutions with optimal benefit/cost within the WSDOT priority array or through low cost operational improvements.
6. Reduces waste by removing design elements that provide marginal or no reduction in crash risk.
7. Addresses the higher crash risk reduction locations for a given investment level.
8. Provides an accurate assessment of project and program performance.
9. Provides scientific and engineering tools to continually improve and refine safety analyses.

Sustainable Safety is a critical, integral part of Practical Solutions that supports Washington in reaching its Target Zero goal.

321.02 General Sustainable Safety Process

The sustainable safety analysis process is intended to be scalable. The HQ Safety Technical Group is responsible for assisting project teams with setting the scale and scope of analysis on planning studies and projects with oversight by the Director of Quality Assurance and Transportation System Safety. The programs of predetermined interest when determining scope and scale of crash risk analysis are:

- Planning Studies
- I-2 (Safety subprogram)
- P-3 (Major Signal and Illuminations portion of subprogram only)
- I-1 (Mobility subprogram)
- I-3 (Economic initiatives subprogram)

While these sub-programs are known to have specific interest regarding a determination for understanding the scale and scope of analysis, all projects outside the P-1 program will consult with the HQ Safety Technical Group to determine the scope and scale of analysis. P-1 subprogram projects will use [Chapter 1120](#) for determining potential safety components to be included or excluded within a project, and do not require crash risk analysis or consultation with the HQ Safety Technical Group. The remaining sections of this chapter will cover projects within specific subprograms of interest listed above.

321.03 Sustainable Safety for I-2 Projects

The Multimodal Safety Executive Committee (MSEC) formally adopted the *AASHTO Highway Safety Manual* (HSM) for statewide implementation in 2011. The HSM and associated tools provide a science-based technical approach to identify sites with the most potential for reducing crash severity or frequency, and potential countermeasures for addressing factors contributing to those crashes. For a brief introduction of the Highway Safety Manual, see:

🔗 <https://bookstore.transportation.org/>

As part of the endorsement of the HSM, WSDOT uses AASTHOWare Safety Analyst (SA) as the tool for screening and initial ranking of sites within the state system and the development of the WSDOT priority array. SA is used to analyze the entire roadway network and identify sites with potential for safety improvements. Sites with the highest potential for reducing the number and/or severity of fatal and serious injury crashes are prioritized for further analysis. The formal process for evaluating and scoping safety projects is illustrated in the [Safety Scoping Process flowchart](#). The Sustainable Safety approach relies on peer review of projects presented to region and Headquarters (HQ) experts to critically review and offer potential options to project scope and approaches.

321.03(1) I-2 Program Safety Management Process

The safety management process is a methodology used to reduce crashes on existing roadway networks statewide. These steps are a set of tools available for use in conjunction with sound engineering judgment. The groups typically responsible are mentioned below; however, depending on how a region is organized, the responsible groups may vary. The seven steps are:

1. **Network Screening** is initiated by HQ Capital Program Development & Management (CPDM), approved by MSEC. In this step, the whole or a subset of the transportation network is screened to identify and rank sites from most likely to least likely to realize reductions in crash frequency and/or severity by implementing countermeasures.
2. **Diagnosis** is usually done through preparation of a Crash Analysis Report (see [321.08\(1\)](#)) by the region Program Management or Traffic Office. This step provides an understanding of the site's safety performance using observed crash history and physical characteristics to determine contributing factors, and uses HSM methodologies to determine whether the site has higher-than-normal safety opportunities compared to similar types of facilities.
3. **Selecting Countermeasures** is usually done by the region Program Management or Traffic Office with region Design Office input. In this step, sites with higher-than-expected crash experience are further evaluated to identify factors that may be contributing to observed crashes. Countermeasures are then selected to address the factors. Tools available for use in selecting recommended countermeasures include the HSM, SafetyAnalyst, Road Safety Assessments (RSAs), HSM prediction models, and the Crash Modification Factor Clearinghouse. New and other tools will be assessed for use as they become available. WSDOT's "Short List" of approved crash modification factors (CMFs) for countermeasures can be found here:
🔗 <http://wwwi.wsdot.wa.gov/riskmanagement/shs/safetycountermeasures.htm>
4. **Economic Appraisals** are usually done by the region Program Management Office in coordination with the region Design and Traffic Offices. In this step, an economic appraisal is performed to compare the benefits of potential crash countermeasures (calculated using crash modification factors) to countermeasure costs and the effect on overall project costs.

5. **Prioritize Projects** is usually done in coordination with the region Program Management office, region Traffic Office and CPDM. In this step, potential safety projects are reviewed and prioritized based on their benefit/cost analysis and other programming considerations.
6. **Design decision documentation** is responsibility of the region office preparing the design. This step involves using safety analyses to make design decisions and documenting those decisions. Specific uses include:
 - Safety analysis based project design decisions
 - Comparing design alternatives based on safety performance
 - Comparing options of a design decision based on safety performance
 - Analyzing work zone design options based on safety performance
7. **Safety Effectiveness Evaluation** is a post-project step, usually performed by HQ CPDM, HQ Design Office, HQ Traffic Office or the region. It analyzes countermeasures used in past projects for their effectiveness in reducing the number and/or severity of crashes in order to determine if predicted crash reductions were realized. Safety effectiveness evaluations play an important role in assessing how well funds have been invested in safety improvements. These evaluations are used in future decision-making activities related to allocation of funds and revisions to highway agency policies.

321.04 Sustainable Safety for P3 – Major Signal and Illumination Projects

On P-3 – Major Signal and Illumination projects, the analysis shall include development of a Crash Analysis Report and the report shall include the evaluation of a roundabout as an alternative. However, a formal Intersection Control Type Analysis (ICA) described in [Chapter 1300](#) is not required.

321.05 Sustainable Safety for I-1 and I-3 Projects

I-1 and I-3 projects are typically larger in size and more complex. The scale and scope of analysis can impact both the time and cost associated with the analysis. For that reason, consult with the HQ Safety Technical Group to determine the scale and scope of analysis prior to initiating sustainable safety analysis for the project.

The baseline metric, “number of fatal and serious crashes,” will be required on all I-1 and I-3 program projects. The initial target is a 100% reduction in fatal and serious crashes. If analysis determines that the target cannot be accomplished within the acceptable performance trade-offs under evaluation, then follow the target refinement process described in [Chapter 1106](#).

321.06 Stand-Alone Sustainable Safety Applications

The HSM and associated analysis tools have been developed to aid decision making and documentation in the project development process. It helps quantify safety performance implications of decisions in project development and provides a basis for predicting and documenting the potential safety performance of those decisions. Safety analysis tools may be appropriate for the following activities:

- Design Decisions
 - o To analyze and document the safety performance of design alternatives and design element dimensioning decisions, including cross-section design element dimensioning and other countermeasures treatment options.

- Interchange Justification Reports (IJRs) and IJR Feasibility Studies (See [Chapter 550](#))
 - o Identify and document the existing safety performance of the freeway section and the adjacent affected local surface system.
 - o Predict the safety performance from traffic flow and geometric conditions imposed by the access point revision alternatives.
 - o The scope of a crash analysis in an IJR is decided by the IJR support team and the approving authority(ies), the Assistant State Design Engineer for the region, and the Federal Highway Administration (FHWA) Safety/Design Engineer.

321.07 Safety Analysis Resources and Tools

Various tools are available to support a safety analysis. All of the safety performance tools mentioned below can be found through the Sustainable Highway Safety website:

 <http://wwwi.wsdot.wa.gov/riskmanagement/shs/>

- **SafetyAnalyst:** This application is used by and CPDM for network screening. It is also used during scoping and design for gathering crash data for analysis. SafetyAnalyst has crash data broken down into highway segments and intersections that can be displayed in tables, graphs, and charts. The crash data in SafetyAnalyst is updated once per year when the roadway, traffic, and crash databases are complete
- **The Collision Data Mart:** This database application is another way to obtain crash data. Access to this application is granted by your supervisor and the Transportation Data & GIS Office. The data is updated as it comes in.
- **Crash Analysis Report:** This template is the basis for all crash analyses for all types of design documentation that need crash analyses (see [321.08\(1\)](#)).
- **Interchange Safety Analysis Tool enhanced (ISATe):** This tool analyzes the safety performance of freeway segments, speed change lanes, interchange ramps, ramp terminal intersections, and collector-distributor (CD) lanes.
- **Highway Safety Manual Spreadsheets:** There are different spreadsheet options for Highway Safety Manual safety performance predictions. Each of these spreadsheet tools can predict the safety performance of highway segments and intersections for three types of highways: Rural Two-lane Two-way, Rural Multilane, and Urban-Suburban Arterial.

Following are the spreadsheet options, with their benefits and limitations:

1. **AASHTO Highway Spreadsheets:** These spreadsheets are the simplest of the three, but they can only handle a maximum of two segments and two intersections of the same type of highway at a time.
2. **Extended Highway Spreadsheets:** These spreadsheets are a little more complicated, but they can handle an unlimited number of highway segments and intersections of the same highway type. In other words, you can analyze an unlimited number of highway segments and intersections as long as you don't change highway types.
3. **Crash Analysis Tool (CAT):** This is an application with an accessible spreadsheet behind it. It can handle an unlimited number of segments and intersections for any of the highway types. In other words, you can analyze an unlimited number of highway segments and intersections and can mix and match highway types. This tool also calculates Benefit Cost ratio of alternatives.

4. **WSDOT Crash Modification Factor (CMF) Short List:** This is a spreadsheet displaying the latest pre-approved CMFs that can be readily used if the context of the listed CMF matches the context of the alternative being analyzed. To back up the CMFs on this spreadsheet, there are detailed investigation reports for each CMF type.
5. **Crash Modification Factor Clearinghouse:** For needed CMFs not yet on the short list, this online AASHTO database holds all of the advertised CMFs. Consult this database when no suitable CMF can be found on the short list:
<http://wwwi.wsdot.wa.gov/riskmanagement/shs/safetycountermeasures.htm>

321.08 Reports and Documentation

The Crash Analysis Report (CAR) and Basis of Design (BOD) are used to document outcomes for sustainable safety analysis. Both are described in the following subsections. For any additional approval requirements, refer to [Chapter 300](#).

321.08(1) Crash Analysis Report (CAR)

The primary tool used to document the results of a safety analysis is the Crash Analysis Report. A report template with instructions is available here:

<http://wwwi.wsdot.wa.gov/riskmanagement/shs/safetytools.htm>

Conduct a crash data analysis to determine the contributing factors to fatal and serious injury crashes reported for the intersection, segment or corridor. Identify the most prevalent or target crash type(s) at the intersection, segment or corridor. Use the contributing factors and target crash type(s) to identify countermeasures that target these types and factors. Countermeasures can include low cost, short range and operational improvement options. Complete a benefit/cost analysis to support evaluation of different alternatives.

321.08(2) Basis of Design

The Basis of Design (BOD) and the Alternative Comparison Table (ACT) are used to reference the outcome of crash risk analysis completed for the no-build and other alternatives considered. Depending on the type of project and the scale and scope of analysis agreed upon, a CAR may exist and forms part of the project design documentation package (See [Chapter 300](#)).

321.09 References

321.09(1) Federal/State Directives, Laws, and Codes

[23 United States Code \(USC\) 148](#) – Federal requirements for the Highway Safety Improvement Program (HSIP)

[Revised Code of Washington \(RCW\) 47.05.010](#) – The statement of purpose for priority programming of transportation projects

[Secretary's Executive Order 1085](#) – Sustainable Highway Safety Program

[Secretary's Executive Order 1090](#) – Moving Washington Forward: Practical Solutions

[Secretary's Executive Order 1096](#) – WSDOT 2015-17: Agency Emphasis and Expectations

321.09(2) Design Guidance

Highway Safety Manual (HSM), AASHTO, 2010

A Policy on Geometric Design of Highways and Streets (Green Book), AASHTO, 2011

321.09(3) Supporting Information

Safety Scoping Process for State Routes flowchart Internal Web Page:

🔗 <http://wwwi.wsdot.wa.gov/ppsc/pgmmgt/wwwi/planprog/scoping/safetyscopingprocessflowchart.pdf>

Strategic Highway Safety Plan: Target Zero – Washington State’s strategic traffic safety plan developed by the Washington Traffic Safety Commission: 🔗 <http://www.targetzero.com/>

Sustainable Highway Safety Internal Web Page – Contains all of the procedures and tools to implement highway safety: 🔗 <http://wwwi.wsdot.wa.gov/riskmanagement/shs/>

Washington Transportation Plan – Washington State Transportation Commission’s recommended strategic transportation plan; includes a highway safety element:

🔗 http://www.wstc.wa.gov/wtp/documents/wtp2030_201012.pdf

510.01	General
510.02	Special Features
510.03	Easements and Permits
510.04	Programming for Funds
510.05	Appraisal and Acquisition
510.06	Transactions
510.07	Documentation
510.08	References

510.01 General

Washington State Department of Transportation (WSDOT) Real Estate Services personnel participate in the project definition phase of a project to assist in minimizing right of way costs, defining route locations and acquisition areas, and determining potential problems and possible solutions.

Due to the variables in land acquisition, the categories of right of way costs considered in the project definition phase are:

- Purchase costs (acquisition compensation).
- Relocation assistance benefits payments.
- Other Real Estate Services staff expenses (acquisition services, relocation services, and interim property management services).

Right of way cost estimates are made by Real Estate Services specialists. When the parcels from which additional right of way will be acquired are known, title reports (including assessors' land areas) can be requested.

Real Estate Services personnel also make project field inspections at appropriate times throughout the development of a project to ensure adequate consideration is given to significant right of way elements involved (including possible social, economic, and environmental effects) in accordance with the [Right of Way Manual](#).

During plan development:

- Title reports are examined for easements or other encumbrances that would reveal the existence and location of water lines, conduits, drainage or irrigation lines, and so on, that must be provided for in construction.
- Easements that indicate other affected ownerships are added to the right of way and limited access plan.
- Arrangements are made to obtain utility, railroad, haul road, detour routes, or other essential agreements, as instructed in the [Utilities Manual](#) and the [Agreements Manual](#).
- Right of way acquisition, disposal, and maintenance are planned.
- Easements and permits are planned (to accommodate activities outside of the right of way).

Engineering considerations for right of way are contained in many chapters in this manual. Examples include chapters in the 700 series related to bridges and walls and in [Chapter 1230, Geometric Cross Section](#). (See [Chapter 1102, Context Identification](#), as a recommended first read for discussion of right of way.) Preliminary right of way widths are developed and may be modified based on Real Estate Services' input, but cannot be moved to coincide with property boundaries in anticipation of a total take. Jogs in the final widths of the right of way are held to a minimum. (See [Right of Way Manual](#), Chapter 6, for discussion of remainders.)

All acquisition documents are processed through Headquarters (HQ) Real Estate Services except temporary permits that are not shown on right of way plans and are not needed for the project (such as for driveway connections).

510.02 Special Features

510.02(1) Road Approaches

On managed access highways, the department will reconstruct legally existing road approaches that are removed or destroyed as part of the highway construction. New approaches required by new highway construction are negotiated by the region with the approval of the Regional Administrator. The negotiator coordinates with the region's design section to ensure new approaches conform to the requirements of [Chapter 1340](#) for road approaches. All new approaches will be by permit through the appropriate region office.

On limited access highways, road approaches of any type must be approved by the Director & State Design Engineer, Development Division, before there is legal basis for negotiation by Real Estate Services. When approved, approaches will be specifically reserved in the right of way transaction and will contain the identical limitations set by the Director & State Design Engineer, Development Division, and as shown on the approved right of way and limited access plan.

510.02(2) Cattle Passes

The desirability of or need for a cattle pass will be considered during the appraisal or negotiation process. A cattle pass will be approved only after complete studies of location, utilization, cost, and safety elements have proved its necessity. Upon approval, such an improvement and appurtenant rights will be established. Future right of access for maintenance is negotiated during acquisition.

On limited access highways, approval by the Director & State Design Engineer, Development Division, and the addition of a traffic movement note on the right of way and limited access plan (see the [Plans Preparation Manual](#)) are required.

510.02(3) Pit, Stockpile, and Waste Sites

These sites are investigated and planned as outlined in the [Plans Preparation Manual](#). Detour and haul road agreements, approved by the Regional Administrator, are necessary when the state proposes to use city streets or county roads for the purpose of detouring traffic or hauling certain materials. (See the [Utilities Manual](#) for detour and haul road agreement guidelines.)

510.02(4) **International Boundaries**

Construction proposed “within a 20-foot strip, 10 feet on each side of the international boundary,” must be coordinated between the department and the British Columbia Ministry of Highways and Public Works.

Permission of the International Boundary Commission is required to work “within 10 feet of an international boundary.” Their primary concern is monumentation of the boundary line and the line of sight between monuments. The Commission requires a written request stating what, when, and why construction will be done, sent to:

International Boundary Commission
United States and Canada
2000 L Street NW, Suite 615
Washington, DC 20036
(☎ www.internationalboundarycommission.org)

510.03 **Easements and Permits**

510.03(1) **General**

If others request rights within existing WSDOT ownership, they are to contact the region Real Estate Services Office.

Easements and permits to accommodate WSDOT activities outside the right of way usually fall into one of the categories defined below.

Easements and permits are processed in accordance with the requirements of the *Right of Way Manual*. The region Real Estate Services Office drafts the legal descriptions for all easements and permits for acquisition of property and property rights. HQ Real Estate Services drafts the legal description for all easements and permits for disposition of property or property rights. The region Real Estate Services Office either obtains or assists in obtaining easements and permits. The region is responsible for compliance with and appropriate retention of the final documents. Records of permanent property rights acquired are maintained by HQ Real Estate Services. Easements and permits are to be shown on the contract plans in accordance with the *Plans Preparation Manual*.

510.03(2) **Perpetual Easements**

Perpetual easements are shown on the right of way plans in accordance with the *Plans Preparation Manual*.

510.03(2)(a) **State Maintenance Easement**

Used when the state is to construct a facility and provide all maintenance. Examples are slope and drainage easements.

510.03(2)(b) **Dual Maintenance Easement**

Used when the state is to construct and maintain a facility and the owner is to maintain the remainder. Examples include the surface area above a tunnel and the area behind a retaining wall or noise wall.

510.03(2)(c) Transfer Easement

On occasion an easement must be acquired for transfer to another party. In these cases, contact the region Real Estate Services Office for early involvement. The right of way and limited access plan is modified to identify the party to whom the easement will be transferred. The department cannot obtain easements for transfer across lands under the jurisdiction of the Department of Natural Resources, and WSDOT cannot condemn for a transfer easement.

510.03(3) Temporary Easements

Temporary easements are used when the state requires a temporary property right that involves either more than minor work or construction activities on privately owned property. In the cases where the rights required or the work to be performed is not beneficial to the property owner, just compensation must be paid.

When WSDOT is paying for the rights or when the encroachment is significant, temporary easements are shown on the right of way plans, in accordance with the [Plans Preparation Manual](#). Consult the region Plans and Real Estate Services personnel for exceptions. If the easement is not mapped, mark and submit plans according to the following information.

- (a) The region provides a right of way plan with the required temporary easement(s) delineated in red to the region Real Estate Services Office. These plan sheets provide:
 - Ownership boundaries. Confirmation of ownership and parcel boundaries may be completed by a search of county records and mapping; a formal title report is required for temporary easements.
 - A parcel number assigned to each ownership.
 - Sufficient engineering detail to write legal descriptions.
 - A statement of the intended use of each temporary easement area.
- (b) In limited access areas, contact the HQ Access and Hearings Office.

510.03(4) Construction Permits

Construction permits are used for temporary rights during construction. They are not used when WSDOT needs a perpetual right. A construction permit is only valid with the current owner and must be renegotiated if property ownership changes before construction begins. For private ownerships, a temporary construction easement is recommended. A construction permit is recommended for rights of entry to publicly owned property. Local agencies might require the use of specific forms when applying for these rights of entry. Regardless of the form or its name, the region is responsible for appropriate central storage of the original document.

When there is a benefit to the property owner (for example, driveway or parking lot approach improvements) the construction permit is usually obtained without the payment of compensation (for example, donation or mutual benefits). Consult the region Plans and Real Estate Services offices for exceptions.

510.04 Programming for Funds

For plan development, the phases in [Exhibit 510-1](#) apply to the authorization of stage programming.

When federal funds are involved, special attention must be given to Federal Highway Administration (FHWA) requirements. When federal participation in right of way costs is anticipated, specific authorization must be obtained from the FHWA. The rules and procedures provided in [RCW 8.26](#), [WAC 468-100](#), and the *Right of Way Manual* must be followed to ensure federal and state participation. In many cases, federal funds are contingent upon the department setting up a relocation advisory procedure for any owner or tenant who is displaced by a project and desires such assistance. Relocation advisory assistance is a function of HQ Real Estate Services.

510.05 Appraisal and Acquisition

510.05(1) All Highways

[Exhibit 510-1](#) shows plan development phases for both limited access highways and managed access highways; thus, it applies to the authorization of right of way acquisition for all state highways.

510.05(2) Exceptions

Exceptions can be made to the requirements in [Exhibit 510-1](#) if unusual hardships result for the individual or the state. The approval of right of way hardship action will be based on the individual parcel merit and is processed in accordance with hardship acquisition policy (see the *Right of Way Manual*).

510.06 Transactions

510.06(1) Private Ownerships

Right of way is ordinarily acquired from private property owners by region-level negotiation between the owner and the right of way agent.

510.06(2) Utilities

The region determines the ownership of all utilities and makes arrangements for necessary adjustment, including relocation of portions of the utility, if necessary. Provisions for relocation or adjustment are included in the Plans, Specifications, and Estimates (PS&E) when:

- The items are normal construction items and the department is obligated for the moving expense.
- The utility requests that relocation be performed by the department and the department has approved the request.

Readjustment may require WSDOT to purchase substitute rights of way or easements for eventual transfer to the utility. Such rights of way or easements must be shown on the right of way plans with the same engineering detail as highway right of way. On limited access highways, if an approach is required for maintenance of a utility, the approach will be shown on the approach schedule. (See the *Utilities Accommodation Policy* regarding location of and access to utilities.)

Negotiations with the utilities are often done by HQ Real Estate Services. Because of the considerable time required to obtain approvals, processing of utility relocation agreements must begin as soon as possible.

510.06(3) Railways

Right of way is generally not acquired in fee from a railroad company. Instead, the state acquires a perpetual easement for encroachment or crossing. A construction and maintenance agreement may also be required. The easement must be shown on the right of way plan and identified by both highway and railroad stationing.

The HQ Design Office coordinates with the railroad design staff to determine a mutually agreeable location before the proposed easement is sent to Real Estate Services. The negotiations with the railroads are generally done by HQ Real Estate Services. Because of the considerable time required to obtain approvals, processing of railroad agreements must begin as soon as possible.

The perpetual easement document is executed by the Real Estate Services Director.

510.06(4) Federal Agencies

Acquisition of right of way from most federal agencies must be negotiated and processed through several federal offices. Allow at least one year for efficient and economical right of way acquisition. Depending upon the particular federal agency involved, special exhibit maps and other documentation may be required, and the right of way may be acquired as an easement rather than in fee. The negotiations with the federal agencies are generally done by HQ Real Estate Services.

510.06(5) Other State Agencies

Acquisition from other state agencies must be negotiated and processed through the individual agencies or designees. Negotiations with other state agencies are generally handled by HQ Real Estate Services. As in the case of federal agencies, substantial time must be allowed for compliance with applicable statutes and regulations peculiar to the agency before right of way will be granted.

510.06(6) Condemnations

Condemnation can result from a disagreement between the department and the owner regarding a fair settlement or a faulty title. Since several months might elapse between the filing of a condemnation case and a court decision, the region Real Estate Services Office can be requested to investigate the possibility of obtaining a negotiated possession and use agreement as in the case of an emergency project or when a sundry site is required immediately.

510.07 Documentation

Refer to [Chapter 300](#) for design documentation requirements.

510.08 References

510.08(1) *Federal/State Laws and Codes*

[23 Code of Federal Regulations \(CFR\) Part 710](#)

[49 CFR Part 24](#), Uniform Relocation Assistance and Real Property Acquisition for Federal and Federally Assisted Programs

[Revised Code of Washington \(RCW\) 8.26](#), Relocation assistance – Real property acquisition policy

[Washington Administrative Code \(WAC\) 468-100](#), Uniform relocation assistance and real property acquisition

510.08(2) *Design Guidance*

[Agreements Manual](#), M 22-99, WSDOT

[Plans Preparation Manual](#), M 22-31, WSDOT

[Right of Way Manual](#), M 26-01, WSDOT

[Utilities Manual](#), M 22-87, WSDOT

Exhibit 510-1 Appraisal and Acquisition

Plan Approval	Plan Approval	Programming of Funds for Appraisal and Acquisition
Limited Access Highways		
<p>PHASE 1 Access Report Plan</p>	<p>Director & State Design Engineer, Development Division,* approves access report plan for prehearing discussion with county and city officials.</p> <p>The access report plan may be used for preparation of federal-aid program data for appraisals if federal funds are to be used for right of way acquisition. It may be used for requesting advance appraisal funds through the Planning and Capital Program Management for all projects with either state or federal funds.</p>	<p>Program appraisals of total takes. (No acquisition.)</p>
<p>PHASE 2 Access Hearing Plan</p>	<p>Director & State Design Engineer, Development Division,* approves access hearing plan for use at a public access hearing. R/W information is complete.</p> <p>The access hearing plan may be used for the preparation of federal-aid program data for negotiations on federally funded projects and for the preparation of true cost estimates and fund requests.</p>	<p>Program all appraisals and acquisitions.</p> <p>Note: Do not appraise or purchase partial takes in areas subject to controversy. Appraise or purchase total takes only if federal design hearing requirements are met.</p>
<p>PHASE 3 Findings and Order Plan</p>	<p>No signature required.</p> <p>Results of findings and order access hearing are marked in red and green on access hearing plan and sent to HQ R/W Plans Section.</p>	<p>Program appraisals of partial takes where data is available to appraisers.</p> <p>Acquisition of total takes.</p>
<p>PHASE 4 Final R/W and L/A Plan</p>	<p>Director & State Design Engineer, Development Division,* approves final R/W and L/A plans or approves revisions to established R/W and L/A plans.</p>	<p>Program all remaining appraisals and all remaining acquisitions.</p> <p>Note: If appeal period is not complete, delay action in areas subject to controversy and possible appeal.</p>
Managed Access Highways		
<p>PHASE 5 Final R/W Plan</p>	<p>R/W plan submitted to HQ R/W Plans Section for approval.</p>	<p>Program appraisals.</p>
	<p>Director & State Design Engineer, Development Division,* approves new R/W plans or approves revisions to established R/W plans.</p>	<p>Program all appraisals and acquisitions.</p>

*Or a designee.

- 520.01 General
- 520.02 References
- 520.03 Definitions
- 520.04 Vocabulary

520.01 General

The Washington State Department of Transportation (WSDOT) controls access to the state's highways (with a few exceptions) in order to preserve the safety and efficiency of these highways as well as the public investment. All Washington State highways are distinguished as being either *limited access* or *managed access* highways. Control of access is accomplished by either acquiring rights of access from abutting property owners (limited access control) or by regulating access connections to the highway (managed access control). Until limited access rights have been acquired from abutting property owners, the route is a managed access highway. Managed access permits are issued either by a local authority (city or town) or by WSDOT.

Numerous studies have shown that controlling and limiting access to highways is a cost-effective way to help maintain the safety, capacity, and functional integrity of a highway. Adding more lanes to an existing highway is expensive and frequently not possible. Controlling access to our state highways by promoting the use of frontage roads or other existing county or city roads, and advocating the internal shared circulation within adjacent developments, is a proactive and cost-effective way to accomplish this objective.

WSDOT has been purchasing access rights and implementing limited access control since 1951 ([RCW 47.52](#)). While this has been effective, it is an expensive way to control access to the state highway system. Adequate funding to accomplish the purchasing of access rights has not kept up with the state's continual population growth and land use development over the years. As a result, state lawmakers introduced a bill in the early 1990s recognizing that controlling access to the state highway system by regulation was a cost-effective means to preserve the safety and capacity of our state highway system.

In 1991, the Legislature passed and the Governor approved [RCW 47.50](#), titled "Highway access management." This new law directed WSDOT to develop new rules to be included in the Washington Administrative Code for those state highways not already limited access highways. The result was a new class of access control called *managed access*.

Chapter [530](#) describes limited access highways in greater detail. [Chapter 540](#) describes managed access highways in greater detail.

The following references and definitions apply to Washington's access control as presented in Chapters [530](#) and [540](#).

520.02 References

520.02(1) Federal/State Laws and Codes

[Revised Code of Washington \(RCW\) 18.43](#), Engineers and land surveyors

[RCW 35.78](#), Streets – Classification and design standards

[RCW 46.61](#), Rules of the road

[RCW 47.17](#), State highway routes

[RCW 47.24](#), City streets as part of state highways

[RCW 47.32](#), Obstructions on right-of-way

[RCW 47.50](#), Highway access management

[RCW 47.52](#), Limited access facilities

[Washington Administrative Code \(WAC\) 468-51](#), Highway access management access permits – Administrative process

[WAC 468-52](#), Highway access management – Access control classification system and standards

[WAC 468-54](#), Limited access hearings

[WAC 468-58](#), Limited access highways

520.02(2) Design Guidance

[Agreements Manual](#), M 22-99, WSDOT

[Manual on Uniform Traffic Control Devices for Streets and Highways](#), USDOT, FHWA; as adopted and modified by Chapter 468-95 WAC “Manual on Uniform Traffic Control Devices for Streets and Highways” (MUTCD)

[Plans Preparation Manual](#), M 22-31, WSDOT

[Right of Way Manual](#), M 26-01, WSDOT

[Utilities Accommodation Policy](#), M 22-86, WSDOT

WSDOT Headquarters (HQ) Access and Hearings Section’s Internet page:

www.wsdot.wa.gov/design/accessandhearings

520.02(3) Supporting Information

[Access Management Manual](#), Transportation Research Board (TRB), Washington DC, 2003

Highways Over National Forest Lands, MOU between WSDOT and USFS, M 22-50, 2002:

www.wsdot.wa.gov/publications/manuals/m22-50.htm

520.03 Definitions

access A means of entering or leaving a public road, street, or highway with respect to abutting property or another public road, street, or highway.

access control The limiting and regulating of public and private access to Washington State’s highways, as required by state law.

Access Control Tracking System Limited Access and Managed Access Master Plan A database list, related to highway route numbers and mileposts, that identifies either the level of limited access or the class of managed access: www.wsdot.wa.gov/design/accessandhearings

access connection See *approach and access connection*.

access connection permit A written authorization issued by the permitting authority for a specifically designed access connection to a managed access highway at a specific location; for a specific type and intensity of property use; and for a specific volume of traffic for the access connection based on the final stage of the development of the applicant's property. The actual form used for this authorization is determined by the permitting authority.

access deviation A deviation (see [Chapter 300](#)) that authorizes deferring or staging acquisition of limited access control, falling short of a 300-foot requirement, or allowing an existing access point to stay within 130 feet of an intersection on a limited access highway. Approval by the Director & State Design Engineer, Development Division, is required (see [Chapter 530](#)).

access hearing plan A limited access plan prepared for presentation at an access hearing.

access point Any point that allows private or public entrance to or exit from the traveled way of a state highway, including "locked gate" access and maintenance access points.

access point spacing On a managed access highway, the distance between two adjacent access points on one side of the highway, measured along the edge of the traveled way from one access point to the next (see also *corner clearance*).

access report plan A limited access plan prepared for presentation to local governmental officials at preliminary meetings before preparation of the access hearing plan.

access rights Property rights that allow an abutting property owner to enter and leave the public roadway system.

allowed Authorized.

application for an access connection An application provided by the permitting authority to be completed by the applicant for access to a managed access highway.

approach and access connection These terms are listed under the specific access section to which they apply. The first section below is for limited access highways and uses the term *approach*. The second section below is for managed access highways and uses the term *access connection*. Approaches and access connections include any ability to leave or enter a highway right of way other than at an intersection with another road or street.

(a) **limited access highways: approach** An access point, other than a public road/street, that allows access to or from a limited access highway on the state highway system. There are five types of approaches to limited access highways that are allowed:

- **Type A** An off and on approach in a legal manner, not to exceed 30 feet in width, for the sole purpose of serving a single-family residence. It may be reserved by the abutting owner for specified use at a point satisfactory to the state at or between designated highway stations. This approach type is allowed on partial and modified control limited access highways.

- **Type B** An off and on approach in a legal manner, not to exceed 50 feet in width, for use necessary to the normal operation of a farm, but not for retail marketing. It may be reserved by the abutting owner for specified use at a point satisfactory to the state at or between designated highway stations. This approach type is allowed on partial and modified control limited access highways. This approach type may be used for wind farms when use of the approach is limited to those vehicles necessary to construct and maintain the farm for use in harvesting wind energy.
 - **Type C** An off and on approach in a legal manner, for a special purpose and width to be agreed upon. It may be specified at a point satisfactory to the state at or between designated highway stations. This approach type is allowed on partial and modified control limited access highways and on full control limited access highways where no other reasonable means of access exists, as solely determined by the department.
 - **Type D** An off and on approach in a legal manner, not to exceed 50 feet in width, for use necessary to the normal operation of a commercial establishment. It may be specified at a point satisfactory to the state at or between designated highway stations. This approach type is allowed only on modified control limited access highways.
 - **Type E** This type is no longer allowed to be constructed because of the requirements that there be only one access point per parcel on a limited access state highway.
 - **Type F** An off and on approach in a legal manner, not to exceed 30 feet in width, for the sole purpose of serving a wireless communication site. It may be specified at a point satisfactory to the state at or between designated highway stations. This approach type is allowed only on partial control limited access highways. (See [WAC 468-58-080\(vi\)](#) for further restrictions.)
- (b) **managed access highways: access connection** An access point, other than a public road/street, that permits access to or from a managed access highway on the state highway system. There are five types of access connection permits:
- **conforming access connection** A connection to a managed access highway that meets current WAC and WSDOT location, spacing, and design criteria.
 - **grandfathered access connection** Any connection to the state highway system that was in existence and in active use on July 1, 1990, and has not had a significant change in use.
 - **joint-use access connection** A single connection to a managed access highway that serves two or more properties.
 - **nonconforming access connection** A connection to a managed access highway that does not meet current WSDOT location, spacing, or design criteria, pending availability of a future conforming access connection.
 - **variance access connection** A connection to a managed access highway at a location not normally allowed by current WSDOT criteria.

(c) **managed access connection category** There are four access connection permit categories for managed access connections to state highways: Category I, Category II, Category III, and Category IV (see [Chapter 540](#)).

annual daily traffic (ADT) The volume of traffic passing a point or segment of a highway, in both directions, during a period of time, divided by the number of days in the period, and factored to represent an estimate of traffic volume for an average day of the year.

average annual daily traffic (AADT) The average volume of traffic passing a point or segment of a highway, in both directions, during a year.

average weekday vehicle trip ends (AWDVTE) The estimated total of all trips entering plus all trips leaving the applicant's site based on the final stage of proposed development.

connection See **approach and access connection**.

contiguous parcels Two or more pieces of real property, under the same ownership, with one or more boundaries that touch and have similarity of use.

corner clearance On a managed access highway, the distance from an intersection of a public road or street to the nearest access connection along the same side of the highway. The minimum corner clearance distance (see [Chapter 540, Exhibit 540-2](#)) is measured from the closest edge of the intersecting road or street to the closest edge of the traveled way of the access connection, measured along one side of the traveled way (through lanes) (see also **access point spacing**).

DHV Design hourly volume.

E&EP WSDOT's Environmental and Engineering Programs Division.

easement A documented right, as a right of way, to use the property of another for designated purposes.

findings and order (F&O) A legal package containing information based on the hearing record from a limited access hearing (see [Chapters 210](#) and [530](#)).

findings and order (F&O) plan A limited access plan, prepared after a limited access hearing, which is based on the hearing record.

HQ WSDOT's Headquarters in Olympia.

intersection An at-grade access point connecting a state highway with a road or street duly established as a public road or public street by the local governmental entity.

limited access Full, partial, or modified access control is planned and established for each corridor and then acquired as the right to limit access to each individual parcel.

- **planned limited access control** Limited access control is planned for some time in the future; however, no access hearing has been held.
- **established limited access control** An access hearing has been held and the Assistant Secretary, Environmental and Engineering & Regional Operations Programs Director, has adopted the findings and order, which *establishes* the limits and level of control.
- **acquired limited access control** Access rights have been purchased.

limited access highway All highways listed as “Established L/A” on the Limited Access and Managed Access Master Plan (see below) and where the rights of direct access to or from abutting lands have been acquired from the abutting landowners.

- **full access control** This most restrictive level of limited access provides access, using interchanges, for selected public roads/streets only, and prohibits highway intersections at grade.
- **partial access control** The second most restrictive level of limited access. At grade intersections with selected public roads are allowed, and there may be some crossings and some driveway approaches at grade. Direct commercial access is not allowed.
- **modified access control** The least restrictive level of limited access. Characteristics are the same as for partial access control except that direct commercial access is allowed.

Limited Access and Managed Access Master Plan A map of Washington State that shows established and planned limited access highways:

 www.wsdot.wa.gov/design/accessandhearings

managed access highway Any highway not listed as “Established L/A” on the Limited Access and Managed Access Master Plan and any highway or portion of a highway designated on the plan as “Established L/A” until such time as the limited access rights are acquired. Under managed access legislation, the property owner’s access rights are regulated through an access connection permitting process.

median The portion of a divided highway separating vehicular traffic traveling in opposite directions.

median opening An opening in a continuous median for the specific purpose of allowing vehicle movement.

MOU Memorandum of Understanding. There is one MOU (*Highways Over National Forest Lands*) between the United States Forest Service (USFS) and WSDOT that requires the USFS to obtain a road approach permit for new access to a state highway that is crossing Forest Service land.

permit holder The abutting property owner or other legally authorized person to whom an access connection permit is issued by the permitting authority.

permitted access connection A connection for which an access connection permit has been issued by a permitting authority.

permitting authority The agency that has legal authority to issue managed access connection permits. For access connections in unincorporated areas, the permitting authority is WSDOT; for access connections within corporate limits, the permitting authority is a city or town.

right of way (R/W) A general term denoting land or interest therein, acquired for or designated for transportation purposes. More specifically, lands that have been dedicated for public transportation purposes or land in which WSDOT, a county, or a municipality owns the fee simple title, has an easement devoted to or required for use as a public road/street and appurtenant facilities, or has established ownership by prescriptive right.

right of way and limited access plan (R/W and L/A plan) A right of way plan that also shows limited access control details.

road approach A road or driveway built to provide private access to or from the state highway system.

shoulder The portion of the highway contiguous with the traveled lanes for the accommodation of stopped vehicles for emergency use and, where allowed, for bicycles (see [Chapter 530](#)).

state highway system All roads, streets, and highways designated as state routes in compliance with [RCW 47.17](#).

520.04 Vocabulary

The entries shown in [Exhibit 520-1](#) are examples of suitable wording for the distinctly different types of access control in Chapters [530](#) and [540](#).

These entries demonstrate the difference in terminology between limited access and managed access in the applicable WACs. For instance, there is nothing about *permit*, *connection*, *category*, or *class* in the limited access vocabulary and, likewise, nothing about *approach* or *type* in the managed access vocabulary.

Also note that [Chapter 1340](#) uses *road approach*, *access*, and *driveway* in a generic way, unrelated to WAC legal terminology, and makes no distinction related to access control.

Exhibit 520-1 Access Control Vocabulary

Access Control Vocabulary	
intersections at grade, geometrics roundabout geometrics road approach geometrics interchange geometrics freeway access point functional classification of highways	Chapter 1310 Chapter 1320 Chapter 1340 Chapter 1360 Chapter 550 WSDOT Functional Classification web site: http://www.wsdot.wa.gov/mapsdata/travel/hpms/functionalclass.htm
Limited Access Highway (Chapter 530)	Managed Access Highway (Chapter 540)
Access point (freeway ramp or other access break) Approach (street, road, driveway) <ul style="list-style-type: none"> Road approach (street, road, driveway) Driveway approach (not street or road) 	Access point (public or not) <ul style="list-style-type: none"> Public access point Access connection (not public)
(Level of) limited access (highway) <ul style="list-style-type: none"> Full/partial/modified control limited access highway 	Managed access highway class <ul style="list-style-type: none"> Class (1-5) managed access highway
Type (A, B, C, D, F) approach Type A approach = Type A road approach	Category (I-IV) access connection
Allowed (policy)	Permitted (a document) or allowed (policy)
	Conforming access connection permit (among others)
Terms Not Used in Chapter 530	Terms Not Used in Chapter 540
class	classification (except functional)
category	type
connection	approach
permit or permitted	

530.01	General	530.07	Frontage Roads
530.02	Achieving Limited Access	530.08	Turnbacks
530.03	Full Control (Most Restrictive)	530.09	Adjacent Railroads
530.04	Partial Control	530.10	<u>Changes to Highway Limited Access Control</u>
530.05	Modified Control (Least Restrictive)	530.11	Documentation
530.06	Access Approaches		

530.01 General

Limited access control is established to preserve the safety and efficiency of specific highways and to preserve the public investment. Limited access control is achieved by acquiring access rights from abutting property owners and by selectively limiting approaches to a highway. (For an overview of access control and the references list and definitions of terminology for this chapter, see [Chapter 520](#), Access Control.)

Requirements for the establishment of limited access highways are set forth in [Revised Code of Washington \(RCW\) 47.52](#). The type of access control applied to a location is considered a design control (see [Chapter 1103](#)), and is determined during planning, scoping, or the early stages of design in conformance with this chapter.

Highways controlled by acquiring abutting property owners' access rights are termed limited access highways and are further distinguished as having *full*, *partial*, or *modified* control. The number of access points per mile, the spacing of interchanges or intersections, and the location of frontage roads or local road/street approaches are determined by the:

- Functional classification and importance of the highway
- Character of the traffic
- Current and future land use
- Environment and aesthetics
- Highway design and operation
- Economic considerations involved

The Federal Highway Administration (FHWA) has jurisdiction on the Interstate System. The Washington State Department of Transportation (WSDOT) has full jurisdiction on all other limited access highways, whether they are inside or outside incorporated city limits.

WSDOT maintains a record of the status of limited access control, by state route number and milepost, in the Access Control Tracking System Limited Access and Managed Access Master Plan database ([Access Master Plan](#)).

The Access Master Plan identifies the current access classification based on the characteristics identified above. The existing access classification is periodically updated to reflect changes on a corridor segment. The planned limited access reflects the vision for access on a corridor by resolution from the Washington Transportation Commission in the 1960s and 1970s. Conditions may have changed since the plan for limited access was envisioned. It is important to re-evaluate this plan and determine the access design control most appropriate for the agreed context. (See [Chapters 1102 and 1103](#) for context and design control guidance, respectively.)

The [Access Master Plan](http://www.wsdot.wa.gov/design/accessandhearings) database is available at: www.wsdot.wa.gov/design/accessandhearings

Nothing in this chapter is to be construed in any way that would prevent acquisition of short sections of full, partial, or modified control of access.

530.02 Achieving Limited Access

530.02(1) Evaluation

The acquisition of full, partial, or modified control is to be evaluated during project development if the route is shown in the Access Control Tracking System Limited Access and Managed Access Master Plan database as either “established” or “planned” for limited access. It is generally known that full limited access control applies to interstates and freeways. However, state highways that do not fall under full access control may have more flexibility in the type of control applied (whether limited or managed control). These highways can benefit by having access control evaluations conducted early in project development.

The cost of acquiring limited access is evaluated to determine whether those costs will be included in the project. The evaluation includes the societal costs of crashes, current and future land use development, and the improved level of service of limited access highways. Use the Basis of Design documentation tool to summarize key results of the evaluation process. (See chapters in the [1100](#) series for more information on using the Basis of Design tool.)

530.02(2) Process

All Washington State highways are managed access highways (see [Chapter 540](#)), except where limited access rights have been acquired. The right of way and limited access plans for routes show the acquired limited access boundaries. This is further represented in the Access Control Tracking System, a database that identifies the status and type of access control for all state highways. The database lists the specific types of limited access control (full, partial, or modified) and identifies whether the control is planned, established, or acquired for a specific route segment. If limited access has not been acquired, the database reports the type of managed access classification that currently applies. For help determining the status of limited access control for any state highway, consult the Headquarters (HQ) Access and Hearings Section.

530.02(2)(a) Procedure for Limited Access Control

Use the following procedure to achieve limited access control:

1. The Secretary of Transportation (or a designee) first identifies a highway as “Planned for Limited Access.”
2. To establish or revise limited access on a new or existing highway, a limited access hearing is held. (See [Chapter 210](#), Public Involvement and Hearings, regarding hearings, and [Chapter 510](#), Right of Way, for the phases of appraisal and acquisition.)

a. Phase 1

The region develops a limited access report and a limited access report plan for department approval and presentation to local officials. The plan notes the level of limited access proposed to be established.

b. Phase 2

The region develops a limited access hearing plan for Director & State Design Engineer, Development Division (or designee), approval and for presentation at the hearing.

c. Phase 3

After the hearing, the region develops the findings and order and revises the limited access hearing plan to become the findings and order plan (see [Chapter 210](#)). The findings and order is processed and sent to the HQ Access and Hearings Section for review and approval. The Assistant Secretary, Engineering & Regional Operations, adopts the findings and order and thus establishes the limits and level of limited access control to be acquired.

d. Phase 4

The findings and order plan is now revised by the HQ Right of Way Plans Section for approval by the Director & State Design Engineer, Development Division (or designee), as a Phase 4 final right of way and limited access plan.

3. Real Estate Services acquires limited access rights from individual property owners based on final design decisions and updates the right of way and limited access plans and the property deed.
4. These highways or portions thereof are now limited access highways and no longer fall under the managed access program.

530.02(3) Access Report ([RCW 47.52.131](#))

The Access Report is developed by the region to inform local governmental officials of the proposed limited access highway and the principal access features involved, and to secure their approval. This report is not furnished to abutting property owners. Three copies of the report are submitted to the HQ Access and Hearings Section for review and approval prior to submission to local authorities.

530.02(3)(a) Access Report Content

The Access Report consists of the following:

1. A description of the existing and proposed highways, including data on the history of the existing highway, which may include references to crashes and locations identified in WSDOT's Priority Array.
2. Traffic analyses pertaining to the proposed highway, including available information about current and potential future traffic volumes on county roads and city streets crossing or severed by the proposed highway and reference sources such as origin-destination surveys.

Traffic data developed for the Design Decision Summary, together with counts of existing traffic available from state or local records, is normally adequate. Special counts of existing traffic are obtained only if circumstances indicate that the available data is inadequate or outdated.

3. A discussion of factors affecting the design of the subject highway, including:
 - Functional class

- Level and limits of limited access control.
 - Roadway section.
 - Interchange, grade separation, and intersection spacing.
 - Pedestrian and bicycle trails or paths.
 - Operational controls with emphasis on proposed fencing, the general concept of illumination, signing, and other traffic control devices.
 - Location of utilities and how they are affected.
 - Proposed plan for landscaping and beautification, including an artist's graphic rendition or design visualization.
4. Governmental responsibility, and comprehensive planning, land use, and community service relative to the new highway.
 5. The disposition of frontage roads, city street and county road intersections, and excess right of way.
 6. An appendix containing:
 - A glossary of engineering terms.
 - A traffic volume diagram(s).
 - Pages showing diagrammatically or graphically the roadway section(s), operational controls, and rest areas (if rest areas are included in the project covered by the report).
 - A vicinity map.
 - An access report plan and profiles for the project.

The limited access report plan shows the effects of the proposed highway on the street and road system by delineating the points of public access. (See the [Plans Preparation Manual](#) for a list of the minimum details to be shown on the plan and for a sample plan.)

7. Notifications and reviews. Upon receipt of the Phase 1 approval (see [Exhibit 510-1](#)) from the Director & State Design Engineer, Development Division, the region publishes the necessary copies, submits the limited access report to the county or city officials for review and approval, and meets with all involved local governmental agencies to discuss the report. Providing a form letter with a signature block for the local agency to use to indicate its approval of the limited access report can help expedite the review and approval process.

Including local agencies as stakeholders from the onset of the project helps establish project expectations and positive working relationships, making reviews and approvals run as smoothly as possible. The region reviews any requests for modification and submits recommendations, with copies of any correspondence or related minutes, to the HQ Access and Hearings Section.

530.02(4) Limited Access Hearing Plan

The region prepares a limited access hearing plan to be used as an exhibit at the public hearing (see [Chapter 210](#) for hearings) and forwards it to the HQ Right of Way Plans Section for review. (See the [Plans Preparation Manual](#) for a list of data to be shown on the access hearing plan in addition to the access report plan data.)

When the plan review is completed by Headquarters, the access hearing plan is placed before the Director & State Design Engineer, Development Division, for approval of Phase 2 authority (see [Exhibit 510-1](#)).

530.02(5) Documentation

Documentation for the establishment of limited access control is in [Chapter 210](#).

530.03 Full Control (Most Restrictive)

530.03(1) Introduction

Full control limited access highways provide almost complete freedom from disruption by allowing access only through interchanges at selected public roads/streets, rest areas, viewpoints, or weigh stations, and by prohibiting at-grade crossings and approaches. Gated approaches are occasionally allowed, with approval of the requirements listed in [Chapter 550](#) and Exhibits [550-1](#) and [2](#).

At times, on state highways (except interstate) where full access control has been established, staged acquisition of limited access may be used, subject to the approval of an access deviation, with initial acquisition as partial or modified control and with ultimate acquisition of full control planned on the highway. When there is no feasible alternative within a reasonable cost, the decision to defer acquisition of limited access control must be documented and is subject to the approval of an access deviation.

530.03(2) Application

Terminate full control limited access sections at apparent logical points of design change. The following guidelines are to be used for the application of full control on limited access highways.

530.03(2)(a) Interstate

Full control is required on interstate highways.

530.03(2)(b) Principal Arterial

Documentation assessing the evaluation of full control is required for principal arterial highways requiring four or more through traffic lanes within a 20-year design period unless approved for partial or modified control on existing highways.

530.03(2)(c) Minor Arterial and Collector

Minor arterial and collector highways will not normally be considered for development to full control.

530.03(3) Crossroads at Interchange Ramps

The extension of limited access control beyond an intersection is measured from the centerline of ramps, crossroads, or parallel roads (as shown in Exhibits [530-1a](#), [1b](#), and [1c](#)), from the terminus of transition tapers (see [Exhibit 530-1d](#)), and in the case of ramp terminals at single point urban interchanges (as shown in [Exhibit 530-1e](#)). For guidance on interchange spacing, see [Chapter 1360](#).

530.03(3)(a) Ramps

At-grade intersections and approaches are prohibited within the full length of any interchange ramp. The ramp is considered to terminate at its intersection with the local road or street.

530.03(3)(b) Frontage Roads

Direct access from the highway to a local service or frontage road is allowed only via the interchange crossroad (see Exhibits [530-1a](#), [1b](#), and [1c](#)).

530.03(3)(c) Interchange Crossroads

In both urban and rural areas, full control limited access must be established and then acquired along the crossroad at an interchange for a minimum distance of 300 feet beyond the centerline of the ramp or the end of the transition taper.

If a frontage road or local road is located at or within 350 feet of a ramp, limited access will be established and then acquired along the crossroad and for an additional minimum distance of 130 feet in all directions from the centerline of the intersection of the crossroad and the frontage or local road (see Exhibits [530-1a](#), [1b](#), and [1c](#)).

For interchanges incorporating partial cloverleaf or buttonhook ramps (see [Exhibit 530-1b](#)), limited access is required for all portions of the crossroad and frontage roads between the ramp terminals and for a distance of 300 feet beyond the ramp terminals. If an at-grade intersection for a local road or street is served directly opposite the ramp terminals, limited access will be extended for a minimum of 300 feet along that leg of the intersection.

When the intersection in question is a roundabout, see [Exhibit 530-1c](#). This shows extension of full control to be 300 feet, measured from the center of the roundabout for an intersection with a ramp terminal. Exhibit 530-1c also shows that if a frontage road or local road is located at or within 350 feet of a ramp terminal, limited access will be established and then acquired along the crossroad (between the roundabouts) and for an additional minimum distance of 130 feet in all directions along the local frontage roadway, measured from the outside edge of the circulating roadway of the roundabout.

[Exhibit 530-1d](#) shows the terminus of transition taper and that full control limited access is extended a minimum distance of 300 feet beyond the end of the farthest taper.

For a single point urban interchange (SPUI) with a right- or left-turn “ramp branch” separated by islands, limited access control is established and acquired for a minimum distance of 300 feet from the intersection of the centerline of the ramp branch with the centerline of the nearest directional roadway (see [Exhibit 530-1e](#).)

530.03(3)(d) Levels of Limited Access: Location of Approaches

Provide full control for 300 feet from the centerline of the ramp or terminus of a transition taper (see Exhibits [530-1a](#), [1b](#), [1c](#), [1d](#), and [1e](#)).

If the economic considerations to implement full control for the entire 300 feet are excessive, then provide full control for at least the first 130 feet; partial or modified control may be provided for the remainder, for a total minimum distance of 300 feet of limited access. Contact the HQ Access and Hearings Section when considering this option.

An approved access deviation is required if the limited access control falls short of 300 feet or for any approach that has been allowed to remain within the first 130 feet.

Ensure approaches are far enough away from a frontage road intersection to provide efficient intersection operation.

530.03(4) Location of Utilities, Bus Stops, and Mailboxes

530.03(4)(a) Utilities

Connecting utility lines are allowed along the outer right of way line between intermittent frontage roads. (See the [Utilities Accommodation Policy](#) regarding the location of and access to utilities.)

530.03(4)(b) Bus Stops

Common carrier or school bus stops are not allowed, except at:

- Railroad crossings (see [Chapter 1350](#)).
- Locations provided by the state on the interchanges (such as flyer stops).
- In exceptional cases, along the main roadway where pedestrian separation is available.

530.03(4)(c) Mailboxes

Mailboxes are not allowed on full control limited access highways. Mail delivery will be from frontage roads or other adjacent local roads.

530.03(5) Pedestrian and Bicycle Crossings and Paths

All nonmotorized traffic is limited as follows:

- At-grade pedestrian crossings are allowed only at the at-grade intersections of ramp terminals.
- Pedestrian separations or other facilities are provided specifically for pedestrian use.
- Bicyclists use facilities provided specifically for bicycle use (separated paths).
- Shared-use paths are only for bicyclists, pedestrians, and other forms of nonmotorized transportation.
- Bicyclists use the right-hand shoulders, except where such use has been specifically prohibited. Information pertaining to such prohibition is available from the [WSDOT website](#): <http://wsdot.wa.gov/bike/closed.htm>

Pedestrians and bicycles are allowed, consistent with “Rules of the Road” ([RCW 46.61](#)), within the limits of full control limited access highways. Where paths are allowed they must be documented on the right of way and limited access plan. The plan shows the location of the path and where the path crosses limited access and provides movement notes (see [530.10\(1\)](#)).

530.04 Partial Control

530.04(1) Introduction

Partial control may be established, when justified, on any highway except interstate. Partial control provides a considerable level of protection from traffic interference and protects the highway from future strip-type development.

Upon acquisition of partial control limited access rights, the number, type, and use of access approaches of abutting property are frozen. The abutting property access rights and type of use are recorded on the property deed. The rights and use may not be altered by the abutting property owner, the local jurisdiction, or the region. This authority resides with the Director & State Design Engineer, Development Division (see [530.10](#)).

530.04(2) Application

Partial control will not normally be used in urban areas or inside corporate limits on existing principal arterial highways where traffic volumes are less than 700 design hourly volume (DHV).

Terminate limited access sections at apparent logical points of design change.

530.04(2)(a) Principal Arterial

Partial control is required when the estimated traffic volumes exceed 3,000 average daily traffic (ADT) within a 20-year design period on principal arterial highways requiring two through traffic lanes. For multilane principal arterial highways, see [530.03\(2\)\(b\)](#).

530.04(2)(b) Minor Arterial

The minimum route length is: urban, 2 miles; rural, 5 miles; and combination urban and rural, 3 miles.

Partial control is required on:

- Rural minor arterial highways at both new and existing locations.
- Urban minor arterial highways at new locations requiring four or more through traffic lanes within a 20-year design period or requiring only two through traffic lanes where the estimated traffic volumes exceed 3,000 ADT within a 20-year design period.

Other rural minor arterial highways with only two lanes may be considered for partial control if any of the following conditions applies:

- The partial control can be acquired at a reasonable cost.
- The route connects two highways of a higher functional classification.
- The potential land development can result in numerous individual approaches, such as encountered in recreational or rapidly developing areas.
- The highway traverses publicly owned lands where partial control is desirable.

530.04(2)(c) Collector: New Alignment

Partial control is required on collector highways in new locations requiring four or more through traffic lanes in a 20-year design period.

530.04(2)(d) Collector: Existing

Existing collector highways will normally be considered for partial control limited access only when all of the following conditions apply:

- The highway serves an area that is not directly served by a higher functional classification of highway.
- Existing or planned development will result in traffic volumes significantly higher than what is required for partial control on minor arterials.
- Partial control can be established without a major impact on development of abutting properties within the constraints of established zoning at the time the partial control is proposed.

530.04(3) Interchanges and Intersections**530.04(3)(a) Interchanges**

Where an interchange occurs on a partial control limited access highway, full control applies at the interchange and interchange ramps. Refer to [530.03\(3\)](#) and see Exhibits [530-1a](#), [1b](#), and [1c](#) for required minimum lengths of access control along the crossroad. (See [Chapter 1360](#) for guidance on interchange spacing.)

530.04(3)(b) Intersections

At an at-grade intersection on a partial control limited access highway, control will be established and acquired along the crossroad for a minimum distance of 300 feet from the centerline of the highway (see [Exhibit 530-2a](#)).

If another frontage or local road is located at or within 350 feet of the at-grade intersection, limited access will be established and then acquired along the crossroad, between the intersections, and:

- For an additional minimum distance of 130 feet in all directions from the centerline of the intersection of the frontage or local road (see [Exhibit 530-2a](#)).
- In the case of a roundabout, for an additional minimum distance of 300 feet along the crossroad, measured from the center of the roundabout (as shown in [Exhibit 530-2b](#)).

On multilane highways, measurements will be made from the centerline of the nearest directional roadway.

An approved access deviation is required if the limited access control falls short of 300 feet or for any access that has been allowed to remain within the first 130 feet.

At-grade intersections with public roads are limited to the number allowed for the functional classification of highway involved, as follows:

530.04(3)(b)(1) Principal Arterial

If the ADT of the crossroad is less than 2,000, 1-mile spacing (minimum), centerline to centerline. If over 2,000 ADT within 20 years, plan for grade separation.

530.04(3)(b)(2) Minor Arterial

If the ADT of the crossroad is less than 2,000, ½-mile spacing (minimum), centerline to centerline. If over 2,000 ADT within 20 years, plan for grade separation.

530.04(3)(b)(3) Collector

Road (or street) plus property approaches, not more than six per side per mile.

With approval from the Director & State Design Engineer, Development Division, shorter intervals may be used where topography or other conditions (such as parcel sizes in some cases) restrict the design. Where intersecting roads are spaced farther apart than one per mile, median crossings may be considered for U-turns, in accordance with [Chapter 1310](#). Keep U-turns to a minimum, consistent with requirements for operation and maintenance of the highway.

To discourage movement in the wrong direction on multilane highways, locate private approaches 300 feet or more from an at-grade intersection. At a tee intersection, a private approach may be located directly opposite the intersection or a minimum of 300 feet away from the intersection. Ensure a private approach directly opposite a tee intersection cannot be mistaken for a continuation or part of the public traveled way.

530.04(4) Access Approach

Partial control is exercised to the level that, in addition to intersections with selected public roads, some crossings and private driveways may be allowed.

530.04(4)(a) Approach Types

Partial control limited access highways allow at-grade intersections with selected public roads and private approaches using Type A, B, C, and F approaches. (See [Chapter 520](#) for the definitions of approach types.)

Type D, commercial approaches, are not allowed direct access to partial control limited access highways. Commercial access is allowed only by way of public roads.

The type of approach provided for each parcel is based on current and potential land use and on an evaluation. (See [530.05\(4\)](#) for a list of evaluation criteria.)

530.04(4)(b) Design Considerations

The following considerations are used to determine the number and location of access approaches on partial control limited access highways.

1. Access approaches must be held to a minimum. The number is limited as follows:
 - Principal arterial: two per side per mile
 - Minor arterial: four per side per mile
 - Collector: six per side per mile, including at-grade intersections
2. Approaches in excess of the number listed above may be allowed as staged construction (until full buildout is complete) if approved by the Director & State Design Engineer, Development Division.

3. Approaches are not allowed for parcels that have reasonable access to other public roads unless a parcel has extensive highway frontage.
4. Relocate or close approaches in areas where sight limitations create undue hazards.
5. Allow only one approach for each parcel, except for very large ownerships, or where terrain features do not allow the property to be served by a single approach. This includes contiguous parcels under a single ownership.
6. Where possible, locate a single approach to serve two or more parcels.
7. The approved design is to provide for future development of frontage roads that will eliminate an excessive number of approaches.

530.04(5) Location of Utilities, Bus Stops, and Mailboxes

530.04(5)(a) Utilities

Connecting utility lines are allowed along the outer right of way line between intermittent frontage roads. (See the [Utilities Accommodation Policy](#) regarding the location of and access to utilities.)

530.04(5)(b) Bus Stops

Bus stops for both common carriers and school buses are not allowed on either two-lane or four-lane highways except:

- At railroad crossings (see [Chapter 1350](#)).
- At locations of intersections with necessary pullouts to be constructed by the state.
- Where shoulder widening has been provided for mail delivery service.
- For a designated school bus loading zone on or adjacent to the traveled lane, that has been approved by WSDOT.

Buses are not allowed to stop in the traveled lanes blocking at-grade intersections or private approaches to load or unload passengers.

School bus loading zones on partial control limited access highways must be posted with school bus loading zone signs, in accordance with the latest edition of the [Manual on Uniform Traffic Control Devices](#) (MUTCD).

530.04(5)(c) Mailboxes

Locate mailboxes on frontage roads or at intersections, with the following exceptions for properties that are served by Type A or B approaches:

- Locate mailboxes on a four-lane highway only on the side of the highway on which the deeded approach is provided.
- Locate mailboxes on a two-lane highway on the side of the highway that is on the right in the direction of the mail delivery.

Wherever mailboxes are allowed on a partial control limited access highway, provide mailbox turnouts to allow mail delivery vehicles to stop clear of the through traffic lanes. (See [Chapter 1600](#) for additional information concerning mailbox locations and turnouts.)

530.04(6) Pedestrian and Bicycle Crossings and Paths

Pedestrian crossings are allowed when they are grade-separated.

At-grade pedestrian crossings are allowed:

- Only at intersections where an at-grade crossing is provided in accordance with [Chapter 1510](#).
- On two-lane highways at mailbox locations.
- On two-lane highways not less than 100 feet from a school bus loading zone (pullout) adjacent to the traveled lane, if school district and WSDOT personnel determine that stopping in the traveled lane is hazardous.
- On two-lane highways where the school bus is stopped on the traveled lane to load or unload passengers and the required sign and signal lights are displayed.

On partial control limited access highways, pedestrian and bicycle traffic is allowed, consistent with “Rules of the Road” ([RCW 46.61](#)), except where unusual safety conditions support prohibition. Information pertaining to such prohibitions is available from the [WSDOT website](#): <http://wsdot.wa.gov/bike/closed.htm>

Where paths are allowed, they must be documented on the right of way and limited access plan. The plan shows the location of the path and where the path crosses limited access, and it provides movement notes (see [530.10\(1\)](#)).

530.05 Modified Control (Least Restrictive)

530.05(1) Introduction

Modified control is intended to prevent further deterioration in the safety and operational characteristics of existing highways by limiting the number and location of access points.

Upon acquisition of modified control limited access, the number, type, and use of access approaches of abutting property are frozen. The abutting property access rights and type of use are recorded on the property deed. The rights and use may not be altered by the abutting property owner, the local jurisdiction, or the region. This authority resides with the Director & State Design Engineer, Development Division (see [530.10](#)).

530.05(2) Application

In general, modified control is applied where some level of control is desired, but existing and potential commercial development precludes the implementation of full or partial control.

530.05(2)(a) Existing Highways

Modified control may be established and acquired on existing highways other than [main line](#) interstate. Priority is given to highway segments where one or both of the following conditions applies:

- Commercial development potential is high, but most of the adjoining property remains undeveloped.

- There is a reasonable expectation that the adjoining property will be redeveloped to a more intensive land use, resulting in greater traffic congestion.

530.05(2)(b) Design Analysis

Selection of highways on which modified control may be applied is based on a design analysis that includes the following contextual factors:

- Traffic volumes
- Level of service, or other selected mobility performance metric
- Selected safety performance
- Functional class
- Route continuity
- Mix of residential and employment densities
- Operational considerations related to achieving the selected target speed
- Local land use planning
- Current and potential land use
- Predicted growth rate
- Economic analysis

530.05(2)(c) Exceptions

Where modified control is to be established, developed commercial areas may be excepted from control when all or most of the abutting property has been developed to the extent that few, if any, additional commercial approaches will be needed with full development of the area. Contact the HQ Access and Hearings Section when considering this option. If this exception is within the limits of access control, an approved access deviation is required.

530.05(3) Intersections

At an intersection on a modified control limited access highway, access control will be established and acquired along the crossroad for a minimum distance of 130 feet:

- Measured from the centerline of a two-lane highway (see [Exhibit 530-3b](#)).
- Measured from the centerline of the nearest directional roadway of a four-lane highway (see [Exhibit 530-3b](#)).
- Measured from the outside edge of the circulating roadway of a roundabout (see [Exhibit 530-3a](#)).

Approaches are allowed within this area only when there is no reasonable alternative. An approved access deviation is required for any access that has been allowed to remain within the first 130 feet.

530.05(4) Access Approach

The number and location of approaches on a highway with modified control must be carefully planned and monitored to provide a safe and efficient highway compatible with present and potential land use.

530.05(4)(a) Approach Types

Modified control limited access highways allow at-grade intersections with selected public roads and with private approaches using Type A, B, C, D, and F approaches. (See [Chapter 520](#) for definitions of the approach types.)

The type of approach provided for each parcel is based on present and potential land use and an evaluation of the following criteria:

- Local comprehensive plans, zoning, and land use ordinances
- Property covenants and agreements
- City or county ordinances
- The highest and best use of the property
- The highest and best use of adjoining lands
- A change in use by merger of adjoining ownerships
- All other factors bearing upon proper land use of the parcel

530.05(4)(b) Design Considerations

The following items are used to determine the number and location of approaches:

1. Parcels that have access to another public road or street are not normally allowed direct access to the highway.
2. Relocate or close approaches located in areas where sight limitations create undue hazards.
3. Hold the number of access approaches to a minimum. Access approaches are limited to one approach for each parcel of land or where adjoining parcels are under one contiguous ownership.
4. Encourage joint use of access approaches where similar use of land allows.
5. Additional approaches may be allowed for future development consistent with local zoning. Once limited access has been acquired, this will require a value determination process (see [530.10](#)).

Close existing access approaches not meeting the above.

530.05(5) Location of Utilities, Bus Stops, and Mailboxes

530.05(5)(a) Utilities

Connecting utility lines are allowed along the outer right of way line between intermittent frontage roads. (See the [Utilities Accommodation Policy](#) regarding location of and access to utilities.)

530.05(5)(b) Bus Stops and Pedestrian Crossings

Bus stops and pedestrian crossings are allowed as follows:

- In rural areas, bus stops and pedestrian crossings are subject to the same restrictions as in [530.04\(5\)](#) and [\(6\)](#).
- In urban areas, bus stops for both commercial carriers and school buses are allowed. (See [Chapter 1430](#) for requirements.)

530.05(5)(c) Mailboxes

Locate mailboxes adjacent to or opposite all authorized approaches as follows:

- On a four-lane highway only on the side of the highway on which the deeded approach is provided.
- On a two-lane highway on the side of the highway that is on the right in the direction of the mail delivery.

Where mailboxes are allowed, a mailbox turnout is recommended to allow mail delivery vehicles to stop clear of the through traffic lanes. (See [Chapter 1600](#) for additional information concerning mailbox locations and turnouts.)

530.05(6) Pedestrian and Bicycle Traffic and Paths

Pedestrians and bicyclists are allowed, consistent with “Rules of the Road” ([RCW 46.61](#)), on modified control limited access highways except where unusual safety considerations support prohibition. Information pertaining to such prohibitions is available from the [WSDOT website](#): <http://wsdot.wa.gov/bike/closed.htm>

Where paths are allowed, they must be documented in the right of way and limited access plan. The plan shows the location of the path and where the path crosses limited access, and it provides movement notes (see [530.10\(1\)](#)).

530.06 Access Approaches

530.06(1) General

Access approaches may be allowed on limited access highways, consistent with the requirements outlined in [530.03](#), [530.04](#), and [530.05](#).

For additional information pertaining to approaches, refer to Chapters [1320](#) (roundabouts), [1340](#) (approach design templates), and [510](#) (right of way), and the [Plans Preparation Manual](#).

530.06(2) Definitions

The widths for the approach types are negotiated, and only the negotiated widths are shown on the right of way and limited access plan. (See [Chapter 520](#) for definitions of the approach types.)

530.07 Frontage Roads

Local agency approval is required for any planned frontage roads, county roads, city streets, or cul-de-sacs. The local agency must also agree in writing to accept and maintain the new section as a county road or city street.

530.07(1) General

Frontage roads are provided in conjunction with limited access highways to:

- Limit access to the main line.
- Provide access to abutting land ownerships.
- Restore the continuity of the local street or roadway system.

Refer to [Chapter 1210](#) for frontage road general policy and [Chapter 300](#) for required documentation.

By agreement under which the state is reimbursed for all costs involved, frontage roads that are not the responsibility of the state may be built by the state upon the request of a local political subdivision, a private agency, or an individual.

530.07(2) County Road and City Street

To connect roads or streets that have been closed off by the highway, short sections of county roads or city streets that are not adjacent to the highway may be constructed if they will serve the same purpose as, and cost less than, a frontage road.

530.07(3) Cul-de-sacs

For a frontage road or local street bearing substantial traffic that is terminated or closed at one end, provide a cul-de-sac or other street or roadway consistent with local policy or practice, that is sufficient to allow vehicles to turn around without encroachment on private property.

530.08 Turnbacks

When WSDOT transfers jurisdiction of operating right of way to a city, town, or county, a turnback agreement is required. (See the [Agreements Manual](#) for turnback procedures.)

Locate the turnback limits at points of logical termination. This will allow WSDOT to retain an adequate amount of right of way for maintenance of the highway and for other operational functions.

In areas where limited access rights have been acquired from the abutting property owners, the limited access rights will continue to be required for highway purposes; therefore, the limited access rights will not be included as part of a turnback agreement.

When a signalized intersection is in the area of a turnback, locate the turnback limit outside the detector loops if WSDOT is continuing the ownership, operation, and maintenance of the signal system. For a roundabout, locate the turnback limit at the back of the raised approach splitter island if WSDOT is continuing the ownership, operation, and maintenance of the roundabout.

530.09 Adjacent Railroads

530.09(1) General

A limited access highway and a railroad are considered adjacent when they have a common right of way border with no other property separating them. The allowed approaches apply only to adjacent railroad property that is directly used for current railroad operation.

530.09(2) Requirements

It is in the public's interest to provide access to the railroad right of way, from limited access highways, for maintenance of the railroad and the utilities located on the railroad right of way where other access is not feasible. This applies to both new highways and to existing highways where limited access has been acquired.

Direct access is allowed where local roads are infrequent or there are few highway-railroad crossings from which trail-type access for maintenance purposes is feasible, and where unique topography or other unusual conditions lead to its use.

To provide direct approaches for access to railroad right of way, all of the following conditions must be met:

- A maximum of one approach is allowed for every 2 miles of highway.
- The approach must not adversely affect the design, construction, stability, traffic safety, or operation of the highway.
- Except where the railroad is located in the median area, the approach is to be accomplished in a legal manner by right turns only, to and from the roadway nearest the railroad. Median crossing is not allowed.
- The approach is secured by a locked gate under arrangements satisfactory to the department. (See the Definitions section in [Chapter 520](#) for Approach Type C, and [Chapter 550](#).)
- The parking of any vehicles or railroad equipment is prohibited within limited access highway right of way.
- A special emergency maintenance permit must be obtained for periods of intensive railroad maintenance.
- The approach must be closed if the railroad operation ceases.
- Approaches are limited to use by the railroad company unless specific provisions for other use are shown on the right of way and limited access plan and included in the right of way negotiations.

530.09(3) Restrictions

Direct access from the highway is considered unnecessary and is not allowed where:

- There are local roads adjacent to or crossing the railroad.
- A trail-type road can be provided by the railroad between crossroads.
- The limited access highway is paralleled by a frontage road adjacent to the railroad.
- No highway previously existed adjacent to the railroad.

530.10 Changes to Highway Limited Access Control

530.10(1) **General**

Changes to limited access control on state highways can only be made by the application of current design requirements and with the approval of the Assistant Secretary, Engineering & Regional Operations (or designee), and FHWA (when appropriate). The right of way and limited access plan must be revised and deeds may need to be rewritten.

Example changes to limited access control:

- Constructing new fence openings
- Closing existing fence openings
- Adding new roadway connections, like an at-grade intersection
- Adding shared-use paths or trails that cross into and out of the right of way
- Widening existing approaches

Any changes proposed on interstate limited access facilities must include environmental documentation in the request. Contact the HQ Access and Hearings Section for assistance.

Consider the following factors when evaluating a request for modification of a limited access highway:

- Existing level of control on the highway
- Functional classification and importance of the highway
- Percentage of truck traffic
- Highway operations
- Present or future land use
- Environment or aesthetics
- Economic considerations
- Safety considerations

Evaluate all revisions to limited access highways to determine if access hearings are required.

For requirements to be met for selected modifications to full control limited access highways such as the Interstate System and multilane state highways, see [Chapter 550](#), Interchange Justification Report.

530.10(2) **Changes for Private Access Approaches (Modified/Partial Control Only)**

Private accesses are allowed within modified control and sometimes allowed within partial control ([WAC 468-58-010](#)).

530.10(2)(a) Requirements

Examples of access modifications requested by abutting property owners include additional road approaches, changes in the allowed use, or additional users of existing road approaches.

Plan revisions that provide for additional access to abutting properties after WSDOT has purchased the access rights are discouraged. However, these revisions may be considered if all of the following can be established:

- There are no other reasonable alternatives.
- The efficiency and safety of the highway will not be adversely impacted.

- The existing situation causes extreme hardship on the owner(s).
- The revision is consistent with the limited access highway requirements.

530.10(2)(b) Procedures

The region initiates a preliminary engineering review of the requested modification to or break in limited access. This preliminary review will be conducted with the HQ Access and Hearings Section to determine whether conceptual approval can be granted for the request. If conceptual approval can be granted, then:

- The region initiates an engineering review of the requested modification.
- The region prepares and submits to the HQ Right of Way Plans Section a preliminary right of way and limited access plan revision, together with a recommendation for Headquarters approval. When federal-aid funds are involved in any phase of the project, the proposed modification will be sent to FHWA for review and approval.
- The recommendation will include an item-by-item analysis of the factors listed in [530.10\(1\)](#) and [530.10\(2\)\(a\)](#).

530.10(2)(c) Valuation Determination

Upon preliminary approval, region Real Estate Services prepares an appraisal for the value of the access change using a before and after appraisal.

- The appraisal follows the requirements set forth in the *Right of Way Manual*.
- The appraisal package is sent to HQ Real Estate Services for review and approval.
- If federal-aid funds were involved in purchasing access control, HQ Real Estate Services will send a copy of the appraisal package to FHWA for review and approval.

530.10(2)(d) Final Processing

- Region Real Estate Services informs the requester of the approved appraised value for the change.
- If the requester is still interested, the region prepares a “Surplus Disposal Package” for HQ Real Estate Services’ review and approval.
- At the same time, the preliminary right of way and limited access plan revision previously transmitted is processed for approval.
- After the department collects the payment from the requester, the region issues a permit for the construction, if required.
- If an existing approach is being surrendered, region Real Estate Services obtains a conveyance from the property owner.
- HQ Real Estate Services prepares and processes a deed granting the change to the access rights.

530.10(3) Changes for Public At-Grade Intersections

530.10(3)(a) Requirements

- Public at-grade intersections on partial control limited access highways serve local arterials that form part of the local transportation network.
- Requests for new intersections on limited access highways must be made by or through the local governmental agency to WSDOT. The region will forward this request, including the data referenced in [530.10\(1\)](#) and [530.10\(2\)\(a\)](#) to the [HQ Access and Hearings Section](#).
- WSDOT must comply with the hearing, or waiver, process as outlined in [Chapter 210](#). The access acquisition and conveyance must be completed prior to beginning construction of the new intersection. The new intersection is to meet WSDOT design and spacing requirements.

530.10(3)(b) Procedures

- The region evaluates the request for modification and contacts the HQ Access and Hearings Section for conceptual approval.
- The region submits an intersection plan for approval (see [Chapter 1310](#)) and a right of way and limited access plan revision request (see the [Plans Preparation Manual](#)). This plan includes the limited access design requirements along the proposed public at-grade intersection.
- The Director & State Design Engineer, Development Division, approves the intersection plan.
- The Assistant Secretary, Engineering & Regional Operations (or designee), approves the access revision.
- The region submits the construction agreement to the Director & State Design Engineer, Development Division (see the [Agreements Manual](#)).
- The Assistant Secretary, Engineering & Regional Operations (or designee), approves the construction agreement.

530.10(3)(c) Valuation Determination

- When a requested public at-grade intersection will serve a local arterial that immediately connects to the local transportation network, compensation will not be required.
- When a requested public at-grade intersection will serve only a limited area, does not immediately connect to the local transportation network, or is primarily for the benefit of a limited number of developers, compensation for the access change will be addressed in the plan revision request. In these situations, compensation is appropriate and a value will be determined as outlined in [530.10\(2\)\(c\)](#).

530.10(4) Temporary Access Breaks

Contact the HQ Access and Hearings Section for any temporary limited access control breaks. The submittal requirements can be found at the following link:

 www.wsdot.wa.gov/design/accessandhearings/

All temporary breaks require approval from either:

- WSDOT HQ Access and Hearings Section for non-interstate highways
- FHWA for all interstate highways

Example:

Temporary access breaks are typically used for short durations and might be requested from an abutter for logging property adjacent to a state highway.

530.11 Documentation

Refer to Chapters [210](#), [300](#), and [550](#) for design documentation requirements.

Exhibit 530-1a Full Access Control Limits: Interchange

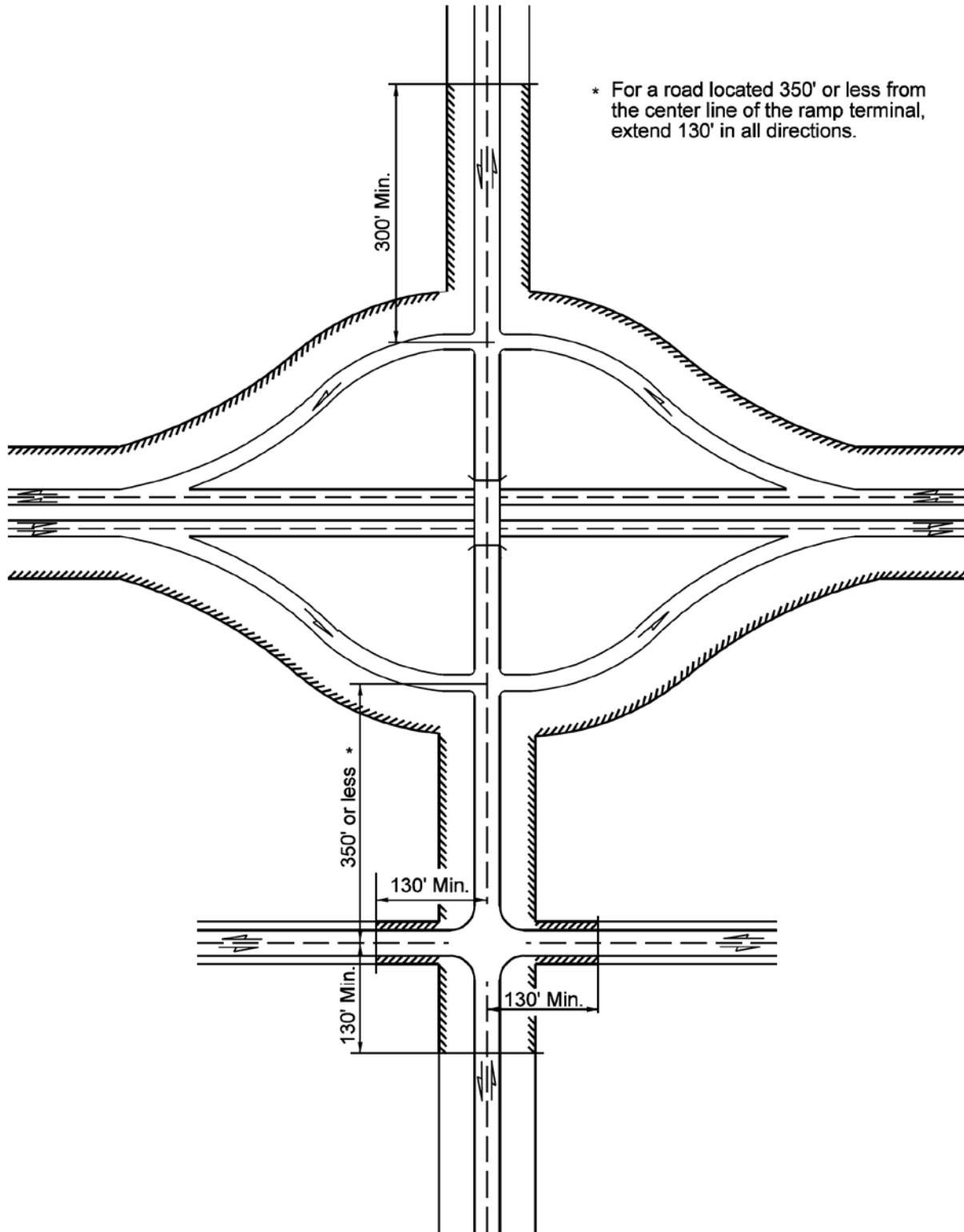

Exhibit 530-1b Full Access Control Limits: Interchange

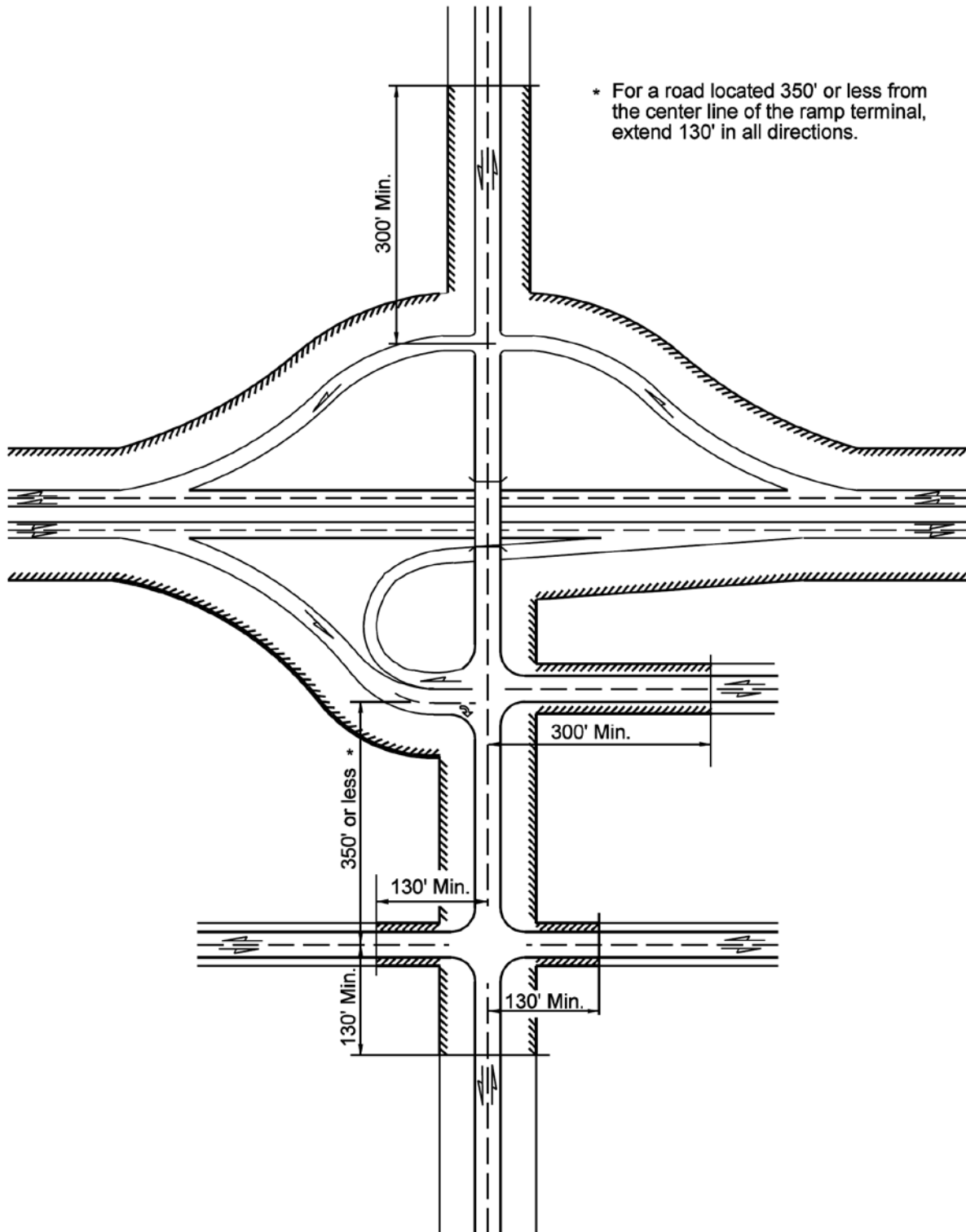

Exhibit 530-1c Full Access Control Limits: Interchange with Roundabouts

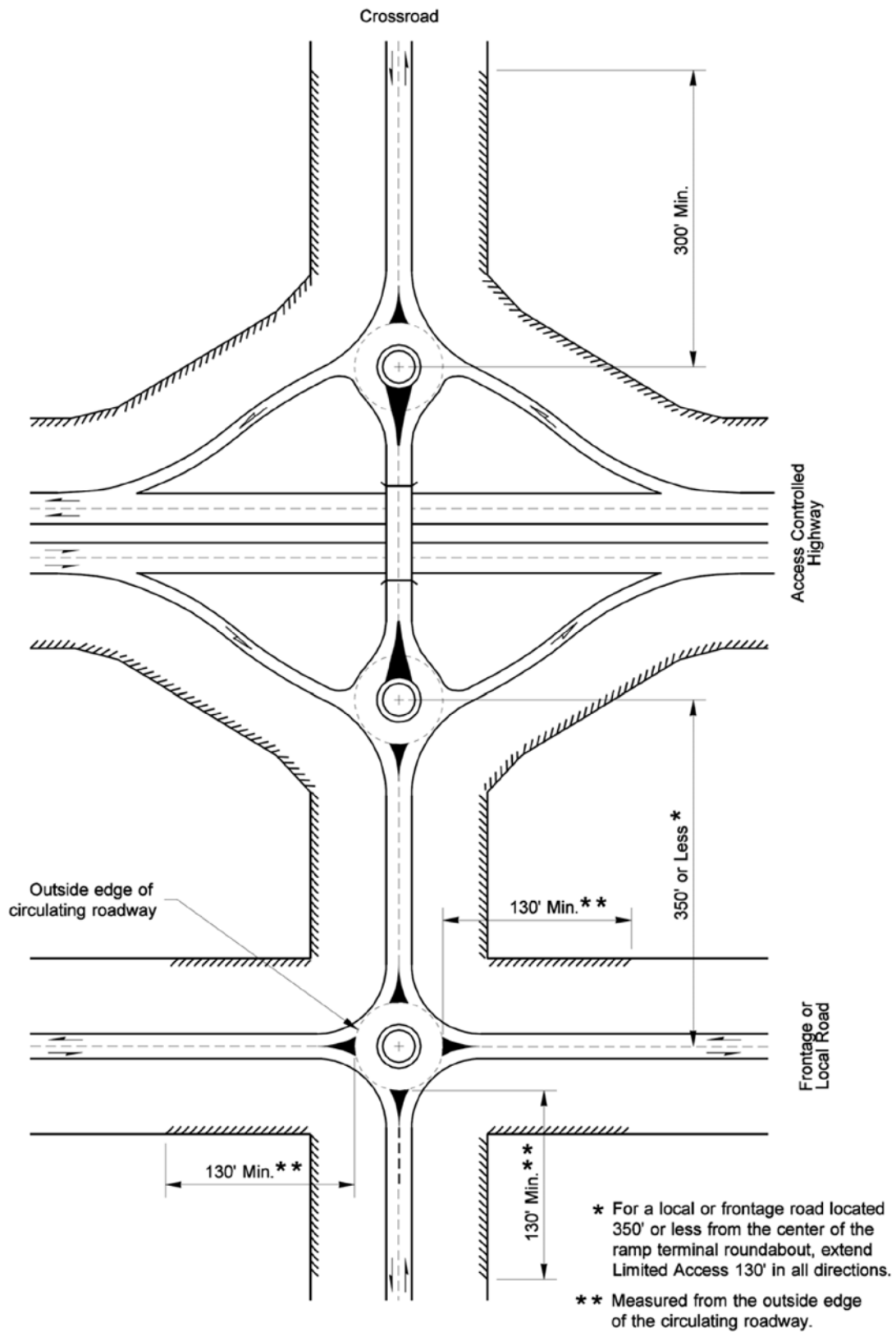

Exhibit 530-1d Full Access Control Limits: Ramp Terminal with Transition Taper

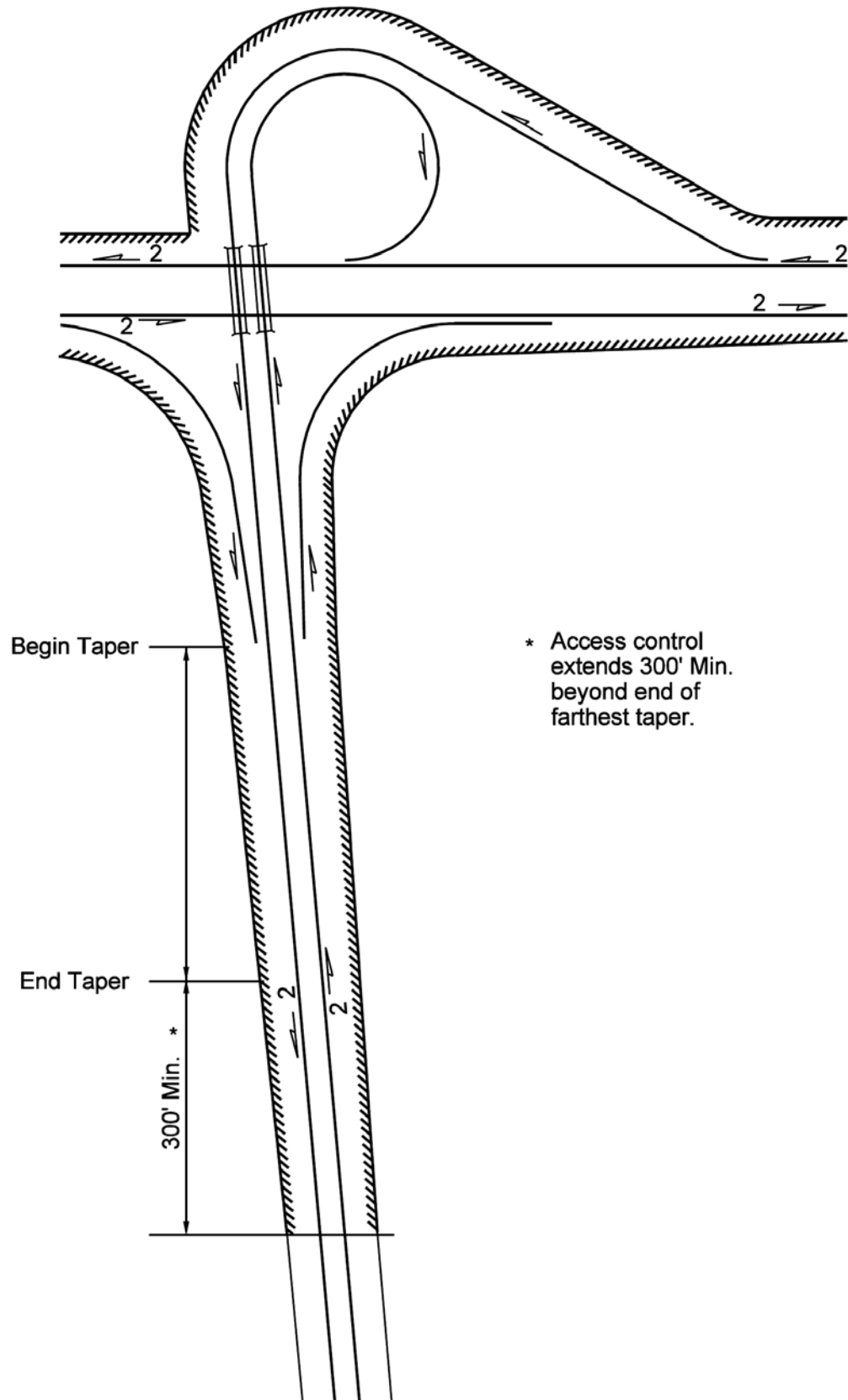

Exhibit 530-1e Full Access Control Limits: Single Point Urban Interchange

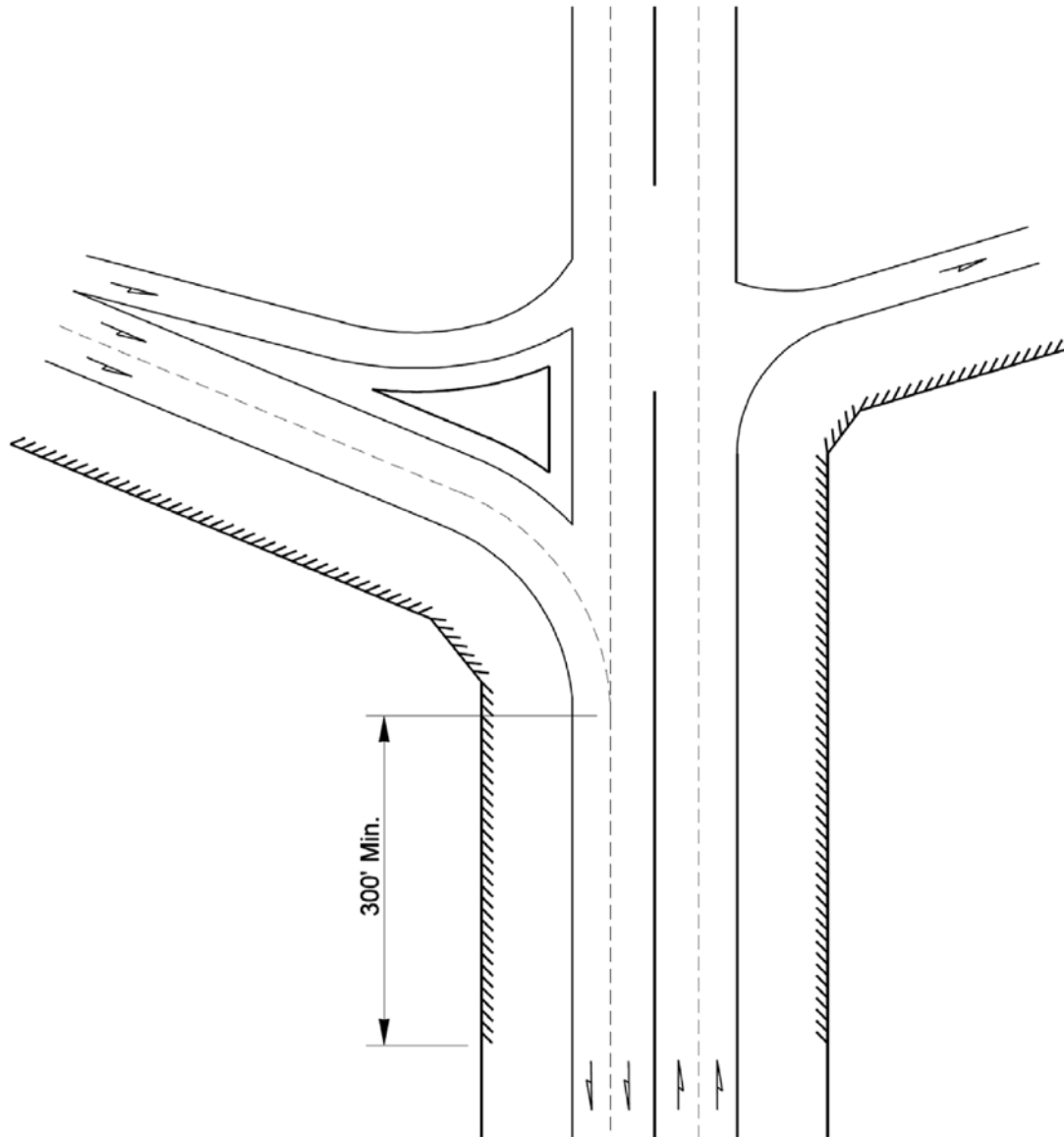

Exhibit 530-2a Partial Access Control Limits: At-Grade Intersections

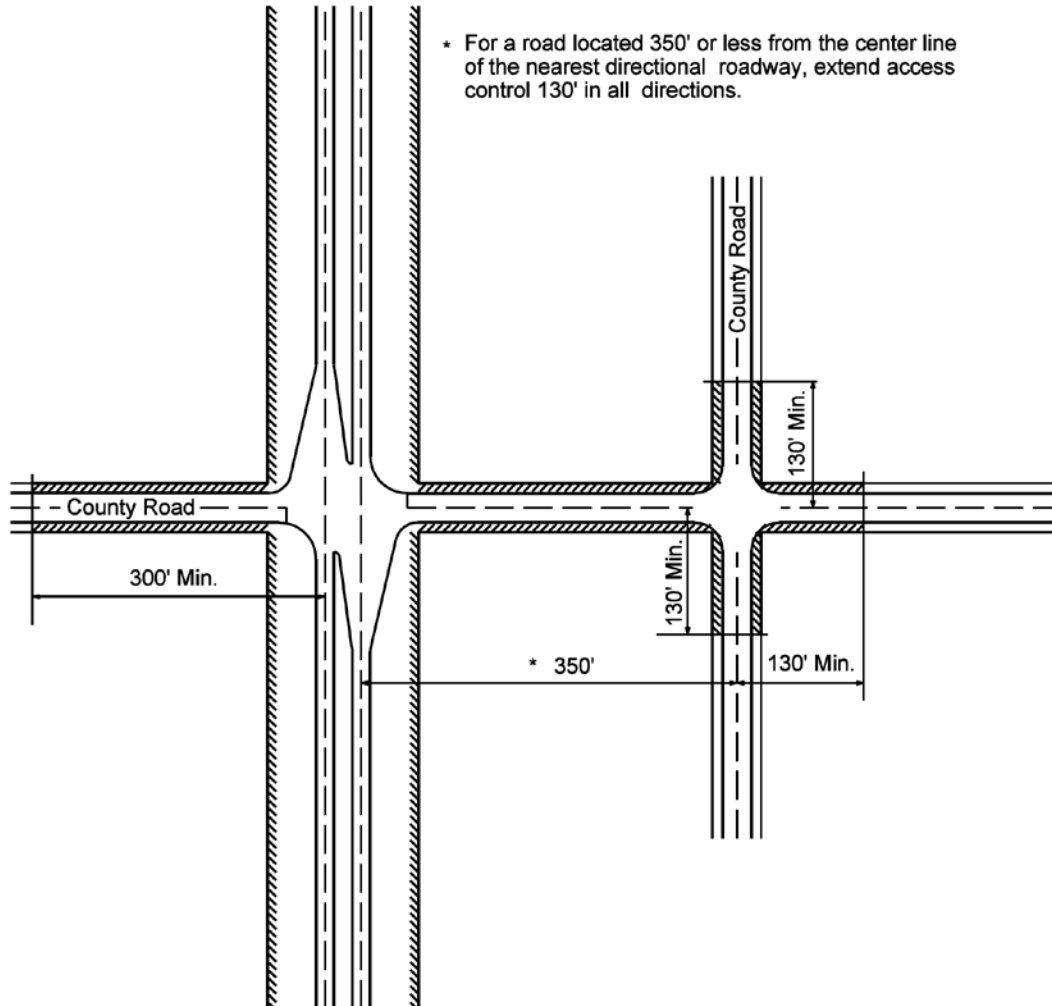
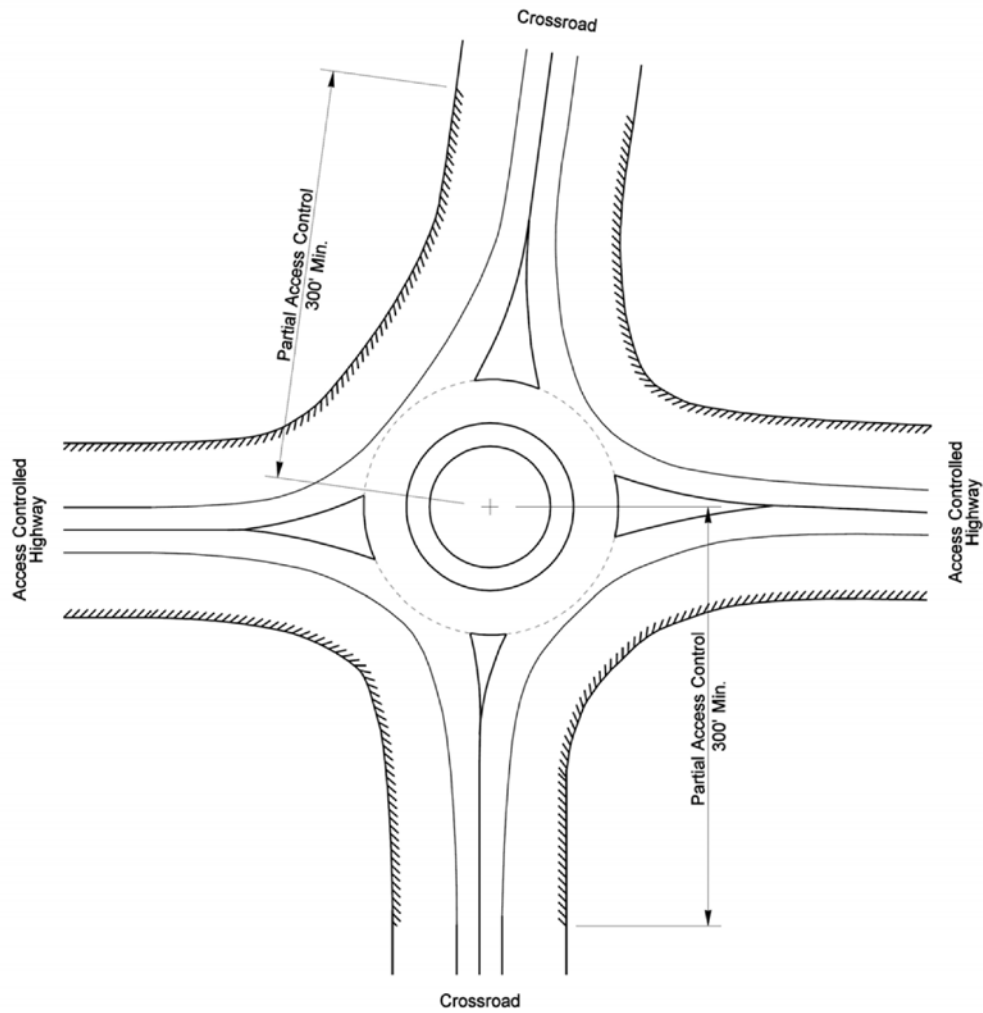

Exhibit 530-2b Partial Access Control Limits: Roundabout Intersections



Note:

Partial access control is measured from the center of the roundabout.

Exhibit 530-3a Modified Access Control Limits: Roundabout Intersections

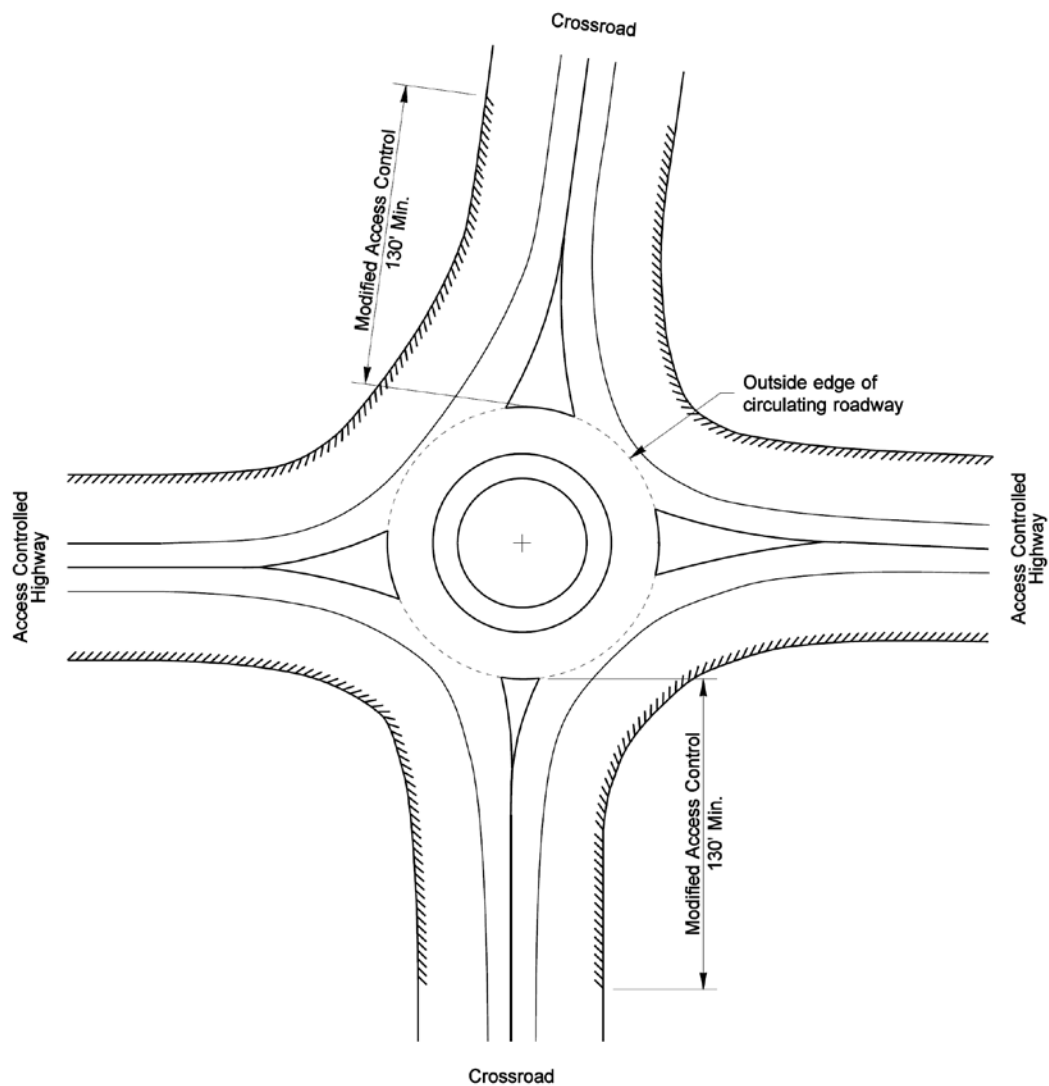

Note:

Modified access control is measured from the outside edge of the circulating roadway.

Exhibit 530-3b Modified Access Control Limits: Intersections

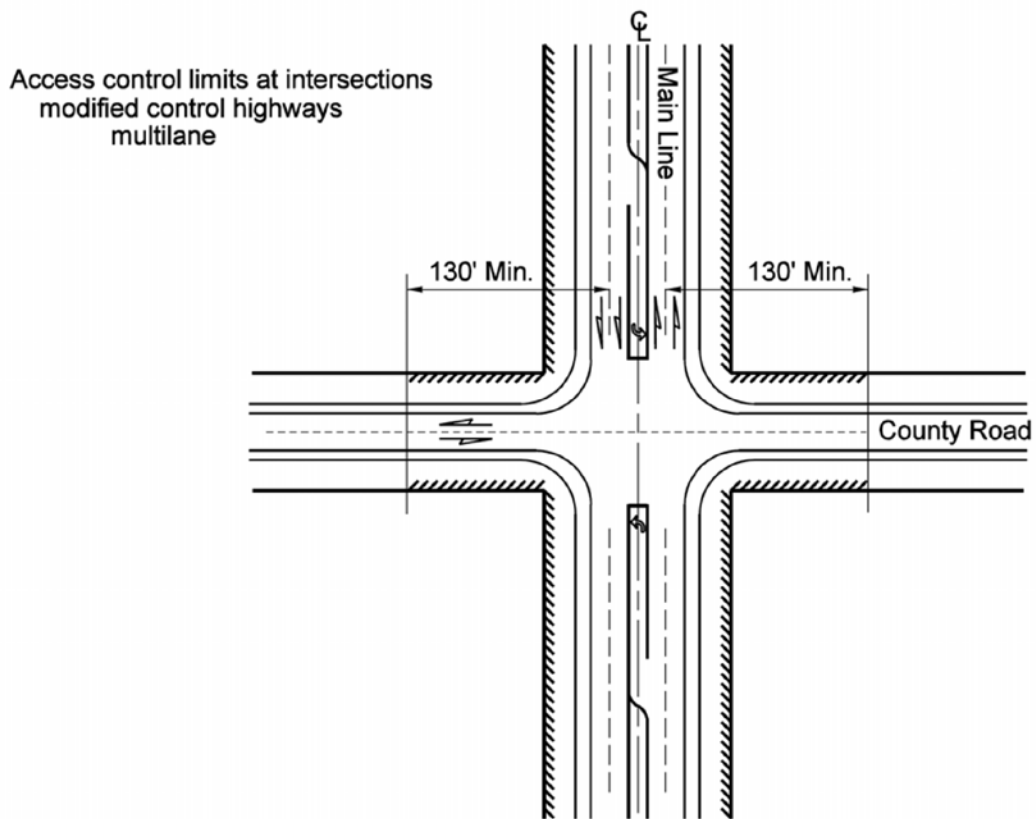
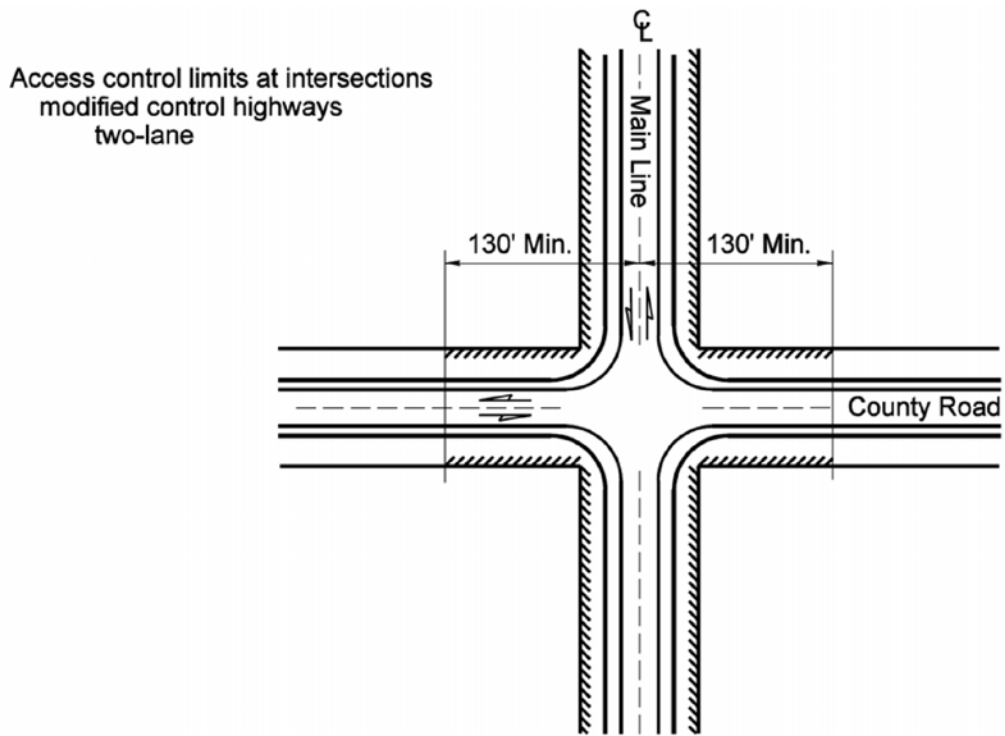

540.01	General	540.07	Permitting and Design Documentation
540.02	Design Considerations	540.08	Other Considerations
540.03	Managed Access Highway Classes	540.09	Preconstruction Conference
540.04	Corner Clearance Criteria	540.10	Adjudicative Proceedings
540.05	Access Connection Categories	540.11	Documentation
540.06	Access Connection Permit	540.12	References

540.01 General

Access management is the systematic regulation of the location, spacing, design, and operation of driveway, city street, and county road connections to state highways. This chapter describes the access management process for granting permission to connect to managed access highways within cities and unincorporated areas. For an overview of access control, references to related state laws and codes, and definitions of terminology for this chapter, see [Chapter 520](#), Access Control.

In Washington State, managed access highways include all state highways that are not limited access highways. State highways that are planned for or established as limited access, are treated as managed access highways until the limited access rights are acquired.

The Access Control Tracking System Limited Access and Managed Access Master Plan (Access Master Plan) identifies not only the limits of limited access control, but also managed access control segments. The current managed access classification is based on access connection densities, distance between access connections, spacing of intersections, and context (see [Washington Administrative Code \(WAC\) 468-52-040](#)). The existing access classification is periodically updated by Headquarters (HQ) with region input to reflect changes on a corridor segment. Conditions may have changed since the Access Master Plan was envisioned or the last managed access classification update. On non-freeways it is important to consider the current classification and any classifications previously planned, and determine the access design control most appropriate for the agreed context (see Chapters [1102](#) and [1103](#) for context and design control guidance, respectively). The Access Master Plan database is available at: www.wsdot.wa.gov/design/accessandhearings

Access to managed access highways is regulated by the governmental entity with jurisdiction over a highway's roadsides. Access connection permits are issued on managed access highways. The Washington State Department of Transportation (WSDOT) has access connection permitting authority over all state highways outside incorporated towns and cities. Incorporated towns and cities have access connection permitting authority for city streets that are part of state highways, as specified in [Revised Code of Washington \(RCW\) 47.24.020](#). When any project is developed on a state highway outside an incorporated city or town, state law requires that existing access connections be evaluated to determine whether they are consistent with all current department spacing, location, and design standards (see [540.03](#)).

540.02 Design Considerations

Evaluate access connections by using the Access Master Plan database to identify the route classification and determine access connection requirements in conformance with this chapter or [Chapter 530](#) as appropriate. See also [Chapter 1100](#), Practical Design, and chapters in that series for guidance on how access control is used as a design control.

Review all connections and verify whether they are in the Roadway Access Management Permit System (RAMPS) database. Contact the region Development Services Office or the HQ Access and Hearings Section for permission to log on to the link through this page:

www.wsdot.wa.gov/design/accessandhearings

If a nonconforming connection is identified, consider relocating, modifying, or eliminating the connection. It is not the intent of the managed access program that modifications to the connection will change the general functionality of the property.

Where current department standards cannot be met while providing the same general functionality, classify the connection as nonconforming and process the appropriate documentation as discussed below. This documentation is part of the permit process.

540.03 Managed Access Highway Classes

The principal objective of the managed access classification system is to maintain the safety and capacity of existing highways. This is accomplished by establishing access management criteria, which are to be adhered to in the planning and regional approval of access connections to the state highway system.

The classification system for state managed access highways consists of five classes. The classes are arranged from the most restrictive, Class 1, to the least restrictive, Class 5. In general, most state highways outside the incorporated limits of a city or town have been designated as Class 1 or Class 2, with only the most urban and lowest-speed state highways within an incorporated town or city designated as Class 5. [Exhibit 540-1](#) shows the five classes of highways, with a brief description of each class. WSDOT keeps a record of the assigned managed access classifications, by state route and milepost, in the Access Control Tracking System database:

www.wsdot.wa.gov/design/accessandhearings

One of the goals of state law is to restrict or keep access connections to a minimum in order to help preserve the safety, operation, and functional integrity of the state highway. On Class 1 highways, mobility is the primary function, while on Class 5 highways, access needs have priority over mobility needs. Class 2 highways also favor mobility, while Class 3 and Class 4 highways generally achieve a balance between mobility and access.

The most notable distinction between the five highway classes is the minimum spacing requirements of access connections. [Exhibit 540-1](#) shows the minimum distances between access points on the same side of the highway. [Exhibit 540-2](#) applies to the minimum clearance from a public road or street.

In all five highway classes, access connections are to be located and designed to minimize interference with transit facilities and high-occupancy vehicle (HOV) facilities on state highways where such facilities exist or are proposed in state, regional, metropolitan, or local transportation plans. In these cases, if reasonable access is available to the local road/street system, access is to be provided to the local road/street system rather than directly to the state highway. Following are the functional characteristics and the legal requirements for each class.

540.03(1) Class 1

540.03(1)(a) Functional Characteristics

Class 1 highways provide for high-speed and/or high-volume traffic movements for interstate, interregional, and intercity (and some intracity) travel needs. Service to abutting land is subordinate to providing service to major traffic movements.

Highways in Class 1 are typically distinguished by a highly-controlled, limited number of (public and private) access points, restrictive medians with limited median openings on multilane facilities, and infrequent intersections.

540.03(1)(b) Legal Requirements

1. It is the intent that Class 1 highways be designed to have a posted speed limit of 50 to 65 mph. Intersecting streets, roads, and highways are planned with a minimum spacing of 1 mile. Spacing of ½ mile may be allowed, but only when no reasonable alternative access exists.
2. Private access connections to the state highway are not allowed except where the property has no other reasonable access to the local road/street system. When a private access connection must be provided, the following conditions apply:
 - The access connection continues until such time other reasonable access to a highway with a less restrictive access control class or access to the local road/street system becomes available and is allowed.
 - The minimum distance to another (public or private) access point is 1,320 feet along the same side of the highway. Nonconforming access connection permits may be issued to provide access connections to parcels whose highway frontage, topography, or location otherwise precludes issuance of a conforming access connection permit; however, variance permits are not allowed.
 - No more than one access connection may be provided to an individual parcel or to contiguous parcels under the same ownership.
 - All private access connections are for right turns only on multilane facilities. Where special conditions apply, justify the exception in a traffic analysis in the access connection permit application that is signed and sealed by a qualified professional engineer who is registered in accordance with [RCW 18.43](#).
 - Additional access connections to the state highway are not allowed for newly created parcels resulting from property divisions. All access for these parcels must be provided by an internal road/street network. Access to the state highway will be at existing permitted locations or revised locations.
3. Restrictive medians are provided on multilane facilities to separate opposing traffic movements and to prevent unauthorized turning movements.

540.03(2) Class 2

540.03(2)(a) Functional Characteristics

Class 2 highways provide for medium-to-high-speed and medium-to-high-volume traffic movements over medium and long distances for interregional, intercity, and intracity travel needs. Direct access service to abutting land is subordinate to providing service to traffic movements.

Highways in Class 2 are typically distinguished by existing or planned restrictive medians on multilane facilities and by large minimum distances between (public and private) access points.

540.03(2)(b) Legal Requirements

1. It is the intent that Class 2 highways be designed to have a posted speed limit of 35 to 50 mph in urbanized areas and 45 to 55 mph in rural areas. Intersecting streets, roads, and highways are planned with a minimum spacing of $\frac{1}{2}$ mile. Intersection spacing of less than $\frac{1}{2}$ -mile may be allowed, but only when no reasonable alternative access exists.

In urban areas and developing areas where higher volumes are present or growth that will require a change to intersection control is expected in the foreseeable future, it is imperative that the location of any public access point be planned carefully to ensure adequate traffic progression. The addition of all new public or private access points that might require signalization or other form of intersection control will require an engineering analysis that is signed and sealed by a qualified professional engineer who is registered in accordance with [RCW 18.43](#).

2. Private access connections to the state highway system are allowed only where the property has no other reasonable access to the local road/street system or where access to the local road/street system will cause unacceptable traffic operational conditions or safety concerns on that system. When a private access connection must be provided, the following conditions apply:
 - The access connection continues until such time other reasonable access to a highway with a less restrictive access control class or acceptable access to the local road/street system becomes available and is allowed.
 - The minimum distance to another (public or private) access point is 660 feet on the same side of the highway. Nonconforming access connection permits may be issued to provide access to parcels whose highway frontage, topography, or location precludes issuance of a conforming access connection permit.
 - Only one access connection is allowed for an individual parcel or to contiguous parcels under the same ownership. This applies unless the highway frontage exceeds 1,320 feet and it can be shown that the additional access connection will not adversely affect the desired function of the state highway in accordance with the assigned managed access Class 2 or the safety or operation of the state highway.
 - Variance permits may be allowed if there are special conditions and the exception can be justified to the satisfaction of the department by a traffic analysis in the access connection permit application that is signed and sealed by a qualified professional engineer who is registered in accordance with [RCW 18.43](#).
 - All private access connections are for right turns only on multilane facilities. This applies unless there are special conditions and the exception can be justified to the satisfaction of the department by a traffic analysis in the access connection permit application that is signed and sealed by a qualified professional engineer who is registered in accordance with [RCW 18.43](#) and only if left-turn channelization is provided.

- Additional access connections to the state highway are not allowed for newly created parcels that result from property divisions. All access for these parcels must be provided by an internal road/street network. Access to the state highway will be at existing permitted locations or at revised locations.
3. On multilane facilities, restrictive medians are provided to separate opposing traffic movements and to prevent unauthorized turning movements. However, a nonrestrictive median or a two-way left-turn lane may be used where special conditions exist and main line volumes are below 20,000 average daily traffic (ADT).

540.03(3) Class 3

540.03(3)(a) Functional Characteristics

Class 3 highways provide for moderate travel speeds depending on context, and moderate traffic volumes for medium and short travel distances for intercity, intracity, and intercommunity travel needs. There is a reasonable balance between access and mobility needs for highways in this class. This class is to be used primarily where the existing level of development of the adjoining land is less intensive than maximum buildout and where the probability of significant land use change and increased traffic demand is high.

Highways in Class 3 are typically distinguished by planned restrictive medians on multilane facilities and by meeting minimum distances between (public and private) access points. Two-way left-turn lanes may be used where justified and main line traffic volumes are below 25,000 ADT. Development of properties with internal road/street networks and joint access connections is encouraged.

540.03(3)(b) Legal Requirements

1. It is the intent that Class 3 highways be designed to have a posted speed limit of 30 to 40 mph in urbanized areas and 45 to 55 mph in rural areas. In rural areas, intersecting streets, roads, and highways are planned with a minimum spacing of ½ mile. Intersection spacing of less than ½-mile may be allowed, but only when no reasonable alternative access exists.

In urban areas and developing areas where higher volumes are present or growth that will require a change to intersection control is expected in the foreseeable future, it is imperative that the location of any public access point be planned carefully to ensure adequate traffic progression. Where feasible, major intersecting roadways that might ultimately require signalization or other intersection control type are planned with a minimum of ½-mile spacing. The addition of all new public or private access points that may require signalization or other intersection control type, will require an engineering analysis that is signed and sealed by a qualified professional engineer who is registered in accordance with [RCW 18.43](#).

2. Private Access Connections
 - No more than one access connection may be provided to an individual parcel or to contiguous parcels under the same ownership. This applies unless it can be shown that additional access connections will not adversely affect the desired function of the state highway in accordance with the assigned managed access Class 3 and will not adversely affect the safety or operation of the state highway.

- The minimum distance to another (public or private) access point is 330 feet on the same side of the highway. Nonconforming access connection permits may be issued to provide access to parcels whose highway frontage, topography, or location precludes issuance of a conforming access connection permit.
- Variance permits may be allowed if there are special conditions and the exception can be justified to the satisfaction of the department by a traffic analysis in the access connection permit application that is signed and sealed by a qualified professional engineer who is registered in accordance with [RCW 18.43](#).

540.03(4) Class 4

540.03(4)(a) Functional Characteristics

Class 4 highways provide for moderate travel speeds and moderate traffic volumes for medium and short travel distances for intercity, intracity, and intercommunity travel needs. There is a reasonable balance between direct access and mobility needs for highways in this class. This class is to be used primarily where the existing level of development of the adjoining land is more intensive and where the probability of major land use changes is less than on Class 3 highway segments.

Highways in Class 4 are typically distinguished by existing or planned nonrestrictive medians. Restrictive medians may be used to mitigate unfavorable operational conditions such as turning, weaving, and crossing conflicts. Minimum access connection spacing requirements apply if adjoining properties are redeveloped.

540.03(4)(b) Legal Requirements

1. It is the intent that Class 4 highways be designed to have a posted speed limit of 30 to 35 mph in urbanized areas and 35 to 45 mph in rural areas. In rural areas, intersecting streets, roads, and highways are planned with a minimum spacing of $\frac{1}{2}$ mile. Intersection spacing of less than $\frac{1}{2}$ mile may be allowed, but only when no reasonable alternative access exists.

In urban areas and developing areas where higher volumes are present or growth that will require a change in intersection control is expected in the foreseeable future, it is imperative that the location of any public access point be planned carefully to ensure adequate traffic progression. Where feasible, major intersecting roadways that might ultimately require intersection control changes are planned with a minimum of $\frac{1}{2}$ -mile spacing. The addition of all new public or private access points that may require signalization, or other intersection control type, will require an engineering analysis that is signed and sealed by a qualified professional engineer who is registered in accordance with [RCW 18.43](#).

2. Private Access Connections

- No more than one access connection may be provided to an individual parcel or to contiguous parcels under the same ownership. This applies unless it can be shown that additional access connections will not adversely affect the desired function of the state highway in accordance with the assigned managed access Class 4 and will not adversely affect the safety or operation of the state highway.

- The minimum distance to another (public or private) access point is 250 feet on the same side of the highway. Nonconforming access connection permits may be issued to provide access connections to parcels whose highway frontage, topography, or location precludes issuance of a conforming access connection permit.
- Variance permits may be allowed if there are special conditions and the exception can be justified to the satisfaction of the department by a traffic analysis in the access connection permit application that is signed and sealed by a qualified professional engineer who is registered in accordance with [RCW 18.43](#).

540.03(5) Class 5

540.03(5)(a) Functional Characteristics

Class 5 highways provide for moderate travel speeds and moderate traffic volumes for primarily short travel distances for intracity and intracommunity trips and for access to state highways of a higher class. Access needs generally may be higher than the need for through-traffic mobility without compromising the public's health, welfare, or safety. These highways will normally have nonrestrictive medians.

540.03(5)(b) Legal Requirements

1. It is the intent that Class 5 highways be designed to have a posted speed limit of 25 to 35 mph. In rural areas, intersecting streets, roads, and highways are planned with a minimum spacing of $\frac{1}{4}$ mile. Spacing of less than $\frac{1}{4}$ mile may be allowed where no reasonable alternative exists. In urban areas and developing areas where higher volumes are present or growth that will require changes to intersection control is expected in the foreseeable future, it is imperative that the location of any public access point be planned carefully to ensure adequate traffic progression. Where feasible, major intersecting roadways that might ultimately require changes to intersection control are planned with a minimum of $\frac{1}{4}$ -mile spacing. The addition of all new public or private access points that might require signalization, or other control type, will require an engineering analysis that is signed and sealed by a qualified professional engineer who is registered in accordance with [RCW 18.43](#).
2. Private Access Connections
 - No more than one access connection may be provided to an individual parcel or to contiguous parcels under the same ownership. This applies unless it can be shown that additional access connections will not adversely affect the desired function of the state highway in accordance with the assigned managed access Class 5 and will not adversely affect the safety or operation of the state highway.
 - The minimum distance to another (public or private) access point is 125 feet on the same side of the highway. Nonconforming access connection permits may be issued to provide access to parcels whose highway frontage, topography, or location precludes issuance of a conforming access connection permit.
 - Variance permits may be allowed if there are special conditions and the exception can be justified to the satisfaction of the department by a traffic analysis in the access connection permit application that is signed and sealed by a qualified professional engineer who is registered in accordance with [RCW 18.43](#).

Exhibit 540-1 Managed Access Highway Class Description

Class	Non-Conforming ^[1]	Variance ^[2]	Conforming ^[3]	Access Point Spacing**	Limitations ^[4]
Class 1 Mobility is the primary function	Yes*	No	No	1,320 ft	<ul style="list-style-type: none"> One access only to contiguous parcels under same ownership Private access connection is not allowed unless no other reasonable access exists (must use local road/street system if possible)
Class 2 Mobility is favored over access	Yes*	Yes*	No	660 ft	<ul style="list-style-type: none"> One access connection only to contiguous parcels under same ownership unless frontage > 1,320 ft Private access connection not allowed unless no other reasonable access exists; must use local road/street system if possible
Class 3 Balance between mobility and access in areas with less than maximum buildout	Yes	Yes	Yes	330 ft	<ul style="list-style-type: none"> One access connection only to contiguous parcels under same ownership Joint access connection for subdivisions preferred; private connection allowed, with justification
Class 4 Balance between mobility and access in areas with less than maximum buildout	Yes	Yes	Yes	250 ft	One access connection only to contiguous parcels under same ownership, except with justification
Class 5 Access needs may have priority over mobility	Yes	Yes	Yes	125 ft	More than one access connection per ownership, with justification

*The access connection continues only until such time other reasonable access to a highway with a less restrictive class or acceptable access to the local road/street system becomes available and is allowed.

**Minimum, on the same side of the highway.

[1] See 540.07(2).

[2] See 540.07(3).

[3] See 540.07(1).

[4] Unless grandfathered (see 540.06).

540.03(6) Changes in Managed Access Classification

WSDOT, RTPOs, MPOs, or other entities such as cities, towns, or counties may initiate a review of managed access classifications per the process identified by [WAC 468-52](#). In all cases, WSDOT consults with the RTPOs, MPOs, and local agencies and takes into consideration comments received during the review process. For city streets that are designated as state highways, the department will obtain concurrence in the final classification assignment from the city or town.

The modified highway classification list shall be submitted to Headquarters for approval by the Director & State Design Engineer, Development Division, or a designee. WSDOT regions shall notify the RTPOs, MPOs, and local governmental entities in writing of the final determination of the reclassification.

540.04 Corner Clearance Criteria

In addition to the five access control classes, there are also corner clearance criteria that must be used for access connections near intersections (see [Exhibit 540-2](#)).

Corner clearance spacing must meet or exceed the minimum access point spacing requirements of the applicable managed access highway class. A single access connection may be placed closer to the intersection, in compliance with the permit application process specified in [WAC 468-51](#) and in accordance with the following criteria:

- The minimum corner clearance criteria in [Exhibit 540-2](#) may be used where access point spacing cannot be obtained due to property size and where a joint-use access connection cannot be secured or where it is determined by WSDOT not to be feasible because of conflicting land use or conflicting traffic volumes or operational characteristics.
- Some local agencies have adopted corner clearance as a design element in their design standards; these standards are to meet or exceed WSDOT standards. Coordinate with the local agency regarding corner clearance of an access connection on or near an intersecting local road or street.
- When a joint-use access connection or an alternate road/street system access—meeting or exceeding the minimum corner clearance requirements—becomes available, the permit holder must close the permitted access connection unless the permit holder shows to WSDOT's satisfaction that such closure is not feasible.

Exhibit 540-2 Minimum Corner Clearance: Distance From Access Connection to Public Road or Street

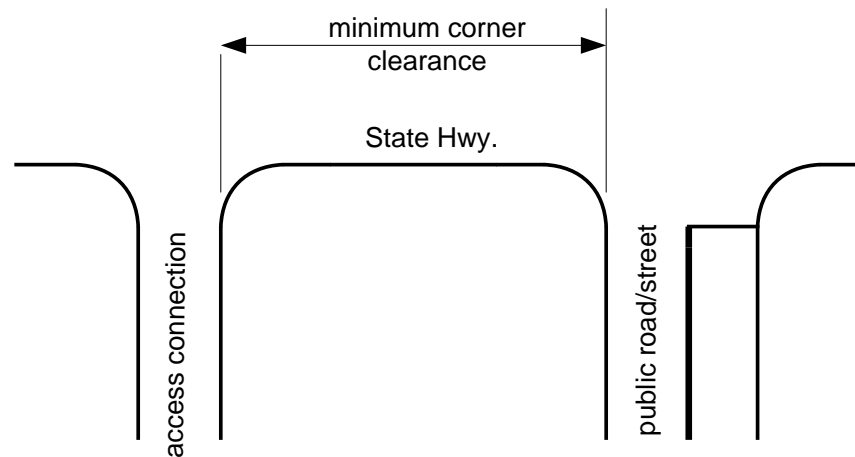

With Restrictive Median		
Position	Access Allowed	Minimum (ft)
Approaching Intersection	Right In/Right Out	115
Approaching Intersection	Right In Only	75
Departing Intersection	Right In/Right Out	230*
Departing Intersection	Right Out Only	100
Without Restrictive Median		
Position	Access Allowed	Minimum (ft)
Approaching Intersection	Full Access**	230*
Approaching Intersection	Right In Only	100
Departing Intersection	Full Access**	230*
Departing Intersection	Right Out Only	100
*125 ft may be used for Class 5 facilities with a posted speed of 35 mph or less.		
**Full Access = All four movements (Right in/Right out; Left in/Left out)		

540.05 Access Connection Categories

Whenever an access connection permit is issued on a managed access state highway, the permit must also specify one of four access connection categories: Category I to Category IV. Categories I through III are based on the maximum vehicular usage of the access connection. Category IV specifies temporary use, usually for less than a year. Access connection permits must specify the category and the maximum vehicular usage of the access connection in the permit.

All access connections are determined by WSDOT to be in one of the following categories ([WAC 468-51-040](#)):

540.05(1) Category I

“Category I – minimum connection” provides connection to the state highway system for up to ten single-family residences, a duplex, or a small multifamily complex of up to ten dwelling units that use a common access connection. This category also applies to permanent access connections to agricultural and forestlands, including field entrances; access connections for the operation, maintenance, and repair of utilities; and access connections serving other low-volume traffic generators expected to have average weekday vehicle trip ends (AWDVTE) of 100 or less.

540.05(2) Category II

“Category II – minor connection” provides connection to the state highway system for medium-volume traffic generators expected to have an AWDVTE of 1,500 or less, but not included in Category I.

540.05(3) Category III

“Category III – major connection” provides connection to the state highway system for high-volume traffic generators expected to have an AWDVTE exceeding 1,500.

540.05(4) Category IV

“Category IV – temporary connection” provides a temporary, time-limited connection to the state highway system for a specific property for a specific use with a specific traffic volume. Such uses include, but are not limited to, logging, forestland clearing, temporary agricultural uses, temporary construction, and temporary emergency access. The department reserves the right to remove any temporary access connection at its sole discretion and at the expense of the property owner after the expiration of the permit. Further, a temporary access connection permit does not bind the department, in any way, to the future issuance of a permanent access connection permit at the temporary access connection location.

540.06 Access Connection Permit

[RCW 47.50](#) requires all access connections to be permitted. This can be accomplished by the permitting process (see [540.07](#)) or by the connection being “grandfathered” (in place prior to July 1, 1990).

All new access connections to state highways, as well as alterations and improvements to existing access connections, require an access connection permit. Every owner of property that abuts a managed access state highway has the right to reasonable access, but not a particular means of access. This right may be restricted with respect to the highway if reasonable access can be provided by way of another local road/street.

When a new private road or street is to be constructed, approval by the permitting authority is required for intersection design, spacing, and construction work on the right of way. However, if an access connection permit is issued, it will be rendered null and void if and when the road or street is duly established as a local road or street by the local governmental entity.

It is the responsibility of the applicant or permit holder to obtain all necessary local, state, and federal approvals and permits (which includes all environmental permits and documentation). The access connection permit only allows the applicant permission to connect to the state highway. It is also the responsibility of the applicant to acquire any and all property rights necessary to provide continuity from the applicant's property to the state highway.

The alteration or closure of any existing access connection caused by changes to the character, intensity of development, or use of the property served by the access connection or the construction of any new access connection must not begin before an approved access connection permit is obtained.

If a property owner or permit holder with a valid access connection permit wishes to change the character, use, or intensity of the property or development served by the access connection, the permitting authority must be contacted to determine whether an upgraded access connection permit will be required.

540.07 Permitting and Design Documentation

An access connection permit is obtained from the department by submitting the appropriate application form, including the fee, plans, traffic data, and access connection information, to the department for review. All access connection and roadway design documents for Category II and III permits must bear the seal and signature of a professional engineer registered in Washington State.

The permitting process begins with the application. Upon submittal of the application with all the attached requirements, it is reviewed and either denied or accepted. If denied, the department must notify the applicant in writing stating the reasons, and the applicant will have thirty (30) days to submit a revised application. Once the application is approved and the permit is issued, the applicant may begin construction.

The Access Manager in each region keeps a record of all access points, including those that are permitted and those that are grandfathered (see 540.08). A permit for a grandfathered access point is not required but may be issued for recordkeeping reasons.

540.07(1) Conforming Access Connection Permit

Conforming access connection permits may be issued for access connections that conform to the functional characteristics and all legal requirements for the designated class of the highway.

540.07(2) Nonconforming Access Connection Permit

Nonconforming access connection permits may be issued:

- For short-term access connections pending the availability of a future joint-use access connection or local road/street system access.
- For location and spacing not meeting requirements.
- For Category I through IV permits.
- After an analysis and determination by the department that a conforming access connection cannot be made at the time of permit application submittal.
- After a finding that the denial of an access connection will leave the property without a reasonable means of access to the local road/street system.

In such instances, the permit is to be noted as being a nonconforming access connection permit and may contain the following specific restrictions and provisions:

- Limits on the maximum vehicular use of the access connection.
- The future availability of alternate means of reasonable access for which a conforming access connection permit can be obtained.
- The removal of the nonconforming access connection at the time the conforming access is available.
- The properties to be served by the access connection.
- Other conditions as necessary to carry out the provisions of [RCW 47.50](#).

540.07(3) Variance Access Connection Permit

Variance access connection is a special nonconforming or additional access connection permit issued for long-term use where future local road/street system access is not foreseeable:

- For location and spacing not meeting requirements or for an access connection that exceeds the number allowed for the class.
- After an engineering study demonstrates, to the satisfaction of the department, that the access connection will not adversely affect the safety, maintenance, or operation of the highway in accordance with its assigned managed access class.

In such instances, the permit is to be noted as being a variance access connection permit and may contain the following specific restrictions and provisions:

- Limits on the maximum vehicular use of the access connection
- The properties to be served by the access connection
- Other conditions as necessary to carry out the provisions of [RCW 47.50](#)

This permit will remain valid until modified or revoked by the permitting authority unless an upgraded permit is required due to changes in property site use (see [540.08\(1\)](#)).

A variance access connection permit must not be issued for an access connection that does not conform to minimum corner clearance requirements (see [540.04](#)).

540.07(4) Corner Clearance Design Deviations

540.07(4)(a) Outside Incorporated City Limits

A deviation request will be required for nonconforming access connections if corner clearance criteria are not met. The HQ Design Office is to be involved early in the process. Such an access will be outside the corner radius and as close as feasible to the property line farthest away from the intersection.

The deviation is recorded in the Design Variance Inventory System (DVIS). Any deviations will be included in the Design Documentation Package (DDP) as well.

For non-WSDOT projects, the region Development Services Office or Local Programs Office is responsible for entering the deviation into the DVIS.

540.07(4)(b) Within Incorporated Cities

In accordance with [RCW 35.78.030](#) and [RCW 47.50](#), incorporated cities and towns have jurisdiction over access permitting on streets designated as state highways. Accesses located within incorporated cities and towns are regulated by the city or town and no deviation by WSDOT will be required. Document decisions made on these accesses in the DDP.

540.08 Other Considerations

540.08(1) Changes in Property Site Use With Permitted Access Connection

The access connection permit is issued to the permit holder for a particular type of land use generating specific projected traffic volumes at the final stage of proposed development. Any changes made in the use, intensity of development, type of traffic, or traffic flow require the permit holder, an assignee, or the property owner to contact the department to determine whether further analysis is needed because the change is significant and will require a new permit and modifications to the access connection ([WAC 468-51-110](#)).

A significant change is one that will cause a change in the category of the access connection permit or one that causes an operational, safety, or maintenance problem on the state highway system based on objective engineering criteria or available collision data. Such data will be provided to the property owner and/or permit holder and tenant upon written request ([WAC 468-51-110](#)).

540.08(2) Existing Access Connections

540.08(2)(a) Closure of Grandfathered Access Connections

Any access connections that were in existence and in active use on July 1, 1990, are grandfathered.

The grandfathered access connection may continue unless:

- There are changes from the 1990 AWDVTE.
- There are changes from the 1990 established use.
- The department determines that the access connection does not provide minimum acceptable levels of highway safety and mobility based on collision and/or traffic data or accepted traffic engineering criteria, a copy of which must be provided to the property owner, permit holder, and/or tenant upon written request ([WAC 468-51-130](#)).

540.08(2)(b) Department Construction Projects

540.08(2)(b)(1) Notification

The department must notify affected property owners, permit holders, business owners, and emergency services in writing, when appropriate, whenever the department's work program requires the modification, relocation, or replacement of its access connections. In addition to written notification, the department will facilitate, when appropriate, a process that may include, but is not limited to, public notices, meetings, or hearings, as well as individual meetings.

540.08(2)(b)(2) Modification Considerations

When the number, location, or design of existing access connections to the state highway is being modified by a department construction project, the resulting modified access connections must provide the same general functionality for the existing property use as they did before the modification, taking into consideration the existing site design, normal vehicle types, and traffic circulation requirements. These are evaluated on an individual basis.

It is important to remember that the intent is not to damage the property owner by removing nonconforming access connections, but to eliminate access connections that are both nonconforming and not needed.

The permitting authority evaluates each property individually to make a determination about which category of access connection (see [540.05](#)) and which design template (see [Chapter 1340](#)) will be reasonable. If it is a commercial parcel, determine whether the business can function with one access connection. Each parcel, or contiguous parcels under the same ownership being used for the same purpose, is allowed only one access connection. If the business cannot function properly with only one access connection, a variance permit may be issued for additional access connections. If the property is residential, only one access connection is allowed; however, certain circumstances might require an additional access connection (see [540.07\(4\)\(a\)](#)).

540.08(2)(b)(3) Costs: Replacement of/Modifications to Existing Access Connections

The costs of modifying or replacing the access points are borne by the department if the department construction project caused the replacement or modification. Modification of the connection may require a change to the existing permit.

540.08(3) Work by Permit Holder's Contractor

The department requires that work by the owner's contractor be accomplished at the completion of the department's contract or be scheduled so as not to interfere with the department's contractor. The department may require a surety bond prior to construction of the access connection in accordance with [WAC 468-51-070](#).

540.09 Preconstruction Conference

All new access connections, including alterations and improvements to existing access connections to the highway, require an access connection permit. The permitting authority may require a preconstruction conference prior to any work being performed on the access. The preconstruction conference must be attended by those necessary to ensure compliance with the terms and provisions of the permit. Details regarding the individual access connections will be included in the construction permit. This may include access connection widths, drainage requirements, surfacing requirements, mailbox locations, and other information ([WAC 468-51-090](#)).

540.10 Adjudicative Proceedings

Any person who can challenge any of the following departmental actions may request an adjudicative proceeding (an appeal to an Administrative Law Judge) within thirty (30) days of the department's written decision ([WAC 468-51-150](#)):

- Denial of an access connection permit application pursuant to [WAC 468-51-080](#)
- Permit conditions pursuant to [WAC 468-51-150](#)
- Permit modifications pursuant to [WAC 468-51-120](#)
- Permit revocation pursuant to [WAC 468-51-120](#)
- Closure of permitted access connection pursuant to [WAC 468-51-120](#)
- Closure of grandfathered access connection pursuant to [WAC 468-51-130](#)

An appeal of a decision by the department can be requested only if the administrative fee has been paid. If the fee has not been paid, the permit application is considered incomplete and an adjudicative proceeding cannot be requested.

540.10(1)(a) Adjudicative Proceedings Process

Following is a brief summary of the adjudicative proceeding process. For the purpose of this summary, the responsibilities of the department are separated into those actions required of the region and those actions required of Headquarters. The summary is written as if the appealable condition was a denial of an access connection request.

1. The region receives an access connection permit application, with fee.
2. The region processes the application and makes a determination that the access connection request will be denied.
3. The region sends the applicant a written letter denying the access connection. Included in this letter is notification that the applicant has thirty (30) days to request an adjudicative proceeding if the applicant disagrees with the region's denial decision. The region must notify affected property owners, permit holders, business owners, tenants, lessees, and emergency services, as appropriate.
4. The applicant requests, within thirty (30) days, an adjudicative proceeding.
5. The region reviews its initial denial decision and determines whether there is any additional information presented that justifies reversing the original decision.
6. If the region determines that the original denial decision will stand, the region then forwards copies of all applicable permit documentation to the HQ Development Services & Access Manager for review and processing.
7. The HQ Development Services & Access Manager reviews the permit application and sends the permit documentation and appeal request to the Office of the Attorney General (AG).
8. If the initial findings of the AG agree with the region's denial decision, the AG's Office sends the applicant a written letter, with the AG's signature, informing the applicant that a hearing will be scheduled for the applicant to appeal in person the department's decision to deny access.
9. The region reserves a location and obtains a court reporter, and Headquarters obtains an Administrative Law Judge (ALJ) to conduct the proceeding. The AG, by written letter, notifies the applicant of the time and place for the hearing. The AG's Office has ninety (90) days from receipt of the applicant's appeal to approve or deny the appeal application, schedule a hearing, or decide not to conduct a hearing. The actual hearing date can be set beyond this ninety-day (90-day) review period.

10. The AG's Office leads the department's presentation and works with the region regarding who will testify and what displays and other information will be presented to the ALJ. The HQ Development Services & Access Manager will typically not attend these proceedings.
11. After hearing all the facts, the ALJ issues a decision, usually within a few weeks after the proceedings. However, the ALJ has ninety (90) days in which to serve a written Initial Order stating the decision.
12. The ALJ's decision is final unless the applicant, or the department through the HQ Development Services & Access Manager, decides to appeal the ALJ's decision to the Director & State Design Engineer, Development Division. This second appeal must occur within twenty (20) days of the ALJ's written decision.
13. If appealed to the Director & State Design Engineer, Development Division, the Director & State Design Engineer has ninety (90) days to review the Initial Order and all the facts and supporting documentation and issue a Final Order. The review by the Director & State Design Engineer does not require the applicable parties to be present and may involve only a review of the material submitted at the adjudicative proceeding.
14. The Director & State Design Engineer's decision is final unless appealed within thirty (30) days to the Washington State Superior Court.

The above represents a general timeline if all appeals are pursued. Based on the noted timelines, it can take nearly a year before a Final Order is issued. If appealed to Superior Court, up to an additional 18 months can be added to the process. In any case, contact the region Development Services Engineer for further guidance and direction if an appeal might be forthcoming.

540.11 Documentation

Refer to [Chapter 300](#) for design documentation requirements.

540.12 References

540.12(1) State Laws and Codes

[Chapter 520](#), Access Control, provides reference to laws and codes

540.12(2) Design Guidance

[Chapter 520](#), Access Control

Chapters in the [1100](#) series for guidance on practical design, context, and design controls

[Chapter 1230](#), Geometric Cross Section

Chapters [1300](#) and [1310](#), for intersection design policy and guidance

[Chapter 1340](#), Driveways

[Chapter 1600](#), Roadside Safety

- 550.01 General
- 550.02 Procedures
- 550.03 Interchange Justification Report and Supporting Analyses
- 550.04 Report Organization and Appendices
- 550.05 IJR Review and Approval
- 550.06 Updating an IJR
- 550.07 Documentation
- 550.08 References

550.01 General

The primary function of limited access freeways and highways is to provide safe and reliable travel for people, goods, and services from state to state and region to region within a state. They should not be used for local trips as an extension of the local street network. Adding or revising access can adversely impact the safety and operations of these facilities; therefore, access revisions must be done with caution. For this reason, new and/or modified access must be justified, and this chapter contains the process for seeking access approval.

An Interchange Justification Report (IJR) is the document used to justify a new access point or access point revision on existing limited access freeways and highways in Washington State. This chapter provides policy and guidance on developing the required documentation for an IJR, and the sequence of an IJR presentation, for both Interstate and non-Interstate limited access routes.

Federal law requires Federal Highway Administration (FHWA) approval of all revisions to the Interstate system, including changes to limited access. Both FHWA and Washington State Department of Transportation (WSDOT) policy require the formal submission of a request to either break or revise the existing limited access on Interstate routes. This policy also facilitates decision-making regarding proposed changes in access to the Interstate system in a manner that considers and is consistent with the vision, goals, and long-range transportation plans of a metropolitan area, region, and state. Breaking or revising existing limited access on state routes must be approved in accordance with [Chapter 530](#), Limited Access Control. An IJR is a document that includes all of the necessary supporting information needed for a request. It documents the IJR team's assumptions and the design of the preferred alternative, the planning process, the evaluation of the alternatives considered, and the coordination that supports and justifies the request for an access revision. FHWA cannot give final approval to the IJR unless environmental analysis/documentation has been approved for the project. Therefore, the IJR process and the environmental analysis (EA/EIS) should be conducted concurrently.

Engineers at the WSDOT Headquarters (HQ) Design Office Access and Hearings Section specialize in providing support for meeting the guidance provided in this chapter. To ensure project success, consult with them before any of the IJR work is started. They can help during the development of the study, Methods and Assumptions Document, and the Interchange Justification Report.

An IJR support team, including HQ Access and Hearings, agrees upon what an IJR will include. IJR on the Interstate require that all eight policy points contained in the [FHWA Policy on Adding Additional Interchanges](#) be addressed. The scale and complexity of the report varies considerably with the scope of the proposal. [Exhibit 550-1](#) lists typical projects for Interstates and the required policy points to address. The level of effort is set by the support team and documented in the Methods and Assumptions Document. For non-Interstate IJR, [Exhibit 550-2](#) lists project types and required policy points to address.

When a local agency or developer is proposing an access point revision, WSDOT requires that a support team be formed.

The IJR will contain a signature page that will be stamped by the Engineer of Record responsible for the report's preparation and the Traffic Analysis Engineer responsible for the traffic analysis included in [Policy Point 3](#). (See [Exhibit 550-6](#) for an example.)

550.02 Procedures

An access point revision is a multistep process. It begins with assembling a support team to conduct a feasibility or planning-level study. The purpose of this study is to determine whether there are improvements that can be made to the local roadway network to meet the purpose and need of the proposed access modification. If the study shows that the purpose and need of the proposal cannot be achieved with the local infrastructure only, the next step would normally be to prepare an IJR (see the Interstate IJR: Process Flow Chart, [Exhibit 550-3](#)).

The IJR is typically initiated early in the environmental process. Traffic analyses help define the area of impact and the range of alternatives. Since the traffic data required for the National Environmental Policy Act (NEPA) or the State Environmental Policy Act (SEPA) and the operational/safety analyses of the IJR are the same, these documents need to be coordinated and developed together, using the same data sources and procedures.

The required steps in the IJR process are described in detail in this chapter, and include:

- Assemble the support team to engage subject experts and decision makers.
- Define purpose and need of the proposal (team).
- Determine whether a feasibility study needs to be conducted or already exists (team).
- Prepare Methods and Assumptions Document to lay the groundwork for the IJR, including scope of IJR and team roles and responsibilities (team).
- Endorse Methods and Assumptions Document to prepare the IJR (team).
- Prepare draft IJR (team or consultant).
- Review draft IJR (team).
- Finalize IJR by addressing comments and issues.
- Review and approve IJR (or conceptual approval).

550.02(1) Organize Support Team and Conduct Study

550.02(1)(a) Support Team

Establish a support team before beginning the feasibility study. This same support team is also involved with the IJR process if the study shows that either a revision or a new access point is needed to meet the proposal purpose and need.

The support team normally consists of the following:

- FHWA Area Engineer and FHWA Safety and Geometric Design Engineer (for Interstate projects)
- Region Planning, Design, or Project Development Engineer (or designee)
- HQ Assistant State Design Engineer
- HQ Development Services & Access Manager
- HQ Traffic Office Representative
- Representative from local agencies (city, county, port, or tribal government)
- Recorder (records and prepares meeting minutes for documentation purposes)

The support team enlists specialists, including but not limited to:

- Metropolitan Planning Organization (MPO)
- Regional Transportation Planning Organization (RTPO)
- WSDOT region (planning, design, environmental, maintenance, and traffic)
- WSDOT Headquarters (design, bridge, traffic, and geotechnical)
- Project proponent specialists (region, local agency, developer)
- Transit agencies
- Other identified stakeholders/partners

The support team's role is to:

- Develop processes for reaching agreement, resolving disputes, and assigning responsibility for final decisions. This is especially important for complex proposals.
- Review regional and state transportation plans to see if the request is consistent with the needs and solutions shown in those plans.
- Develop purpose and need statements for the proposal, consistent with the project environmental document.
- Expedite the study steps (and, if needed, the IJR development and review process) through early communication and agreement.
- Establish the agreed-upon study area (including baseline transportation improvements) and future travel demand forecasts for each of the alternatives being considered.
- Develop and endorse the Methods and Assumptions Document.
- Provide guidance and support.
- Evaluate data and identify possible alternatives for the proposal during the study and, if needed, for an IJR.
- Contribute material for the report that documents the discussions and decisions.
- Review results and determine whether an IJR is warranted.
- Ensure the compatibility of data used in adjacent or overlapping studies.
- Ensure integration of the following as required: Project Definition process, value engineering studies, public involvement efforts, environmental analyses, operational analyses, safety analyses, and other analyses for the study. This encourages the use of consistent data.

The support team works together, from the corridor study through preparation of the assumptions document and completion of the IJR.

- Address design elements. Status of known deviations must be noted in Policy Point 4. Deviations are discouraged on new accesses.

550.02(1)(b) Methods and Assumptions Document

This document is developed to record assumptions used in the IJR, the purpose and need, along with analysis methodologies, criteria, and support team decisions. The document presents the proposed traffic analysis tool and approach, safety analysis methodology, study area, peak hour(s) for analysis, traffic data, design year, opening year, travel demand forecasts, baseline conditions, and design year conditions. It also documents the team's decisions on how much detail will be included in each policy point. The signed Methods and Assumptions Document represents endorsement by the support team on the IJR approach, tools, data, and criteria used throughout the IJR process. This document is used on both interstate & non-interstate IJRs.

The Methods and Assumptions Document is dynamic, and is updated and re-endorsed when changed conditions warrant. The document also serves as a historical record of the processes, dates, and decisions made by the team. WSDOT and FHWA require the development and acceptance of the document, because early agreement on details results in the highest level of success for the IJR process.

Use the WSDOT Methods and Assumptions Document template here:

 www.wsdot.wa.gov/design/accessandhearings

Refer to [Exhibit 550-5](#) for an example form for support team's concurrence to Methods and Assumptions Document.

550.02(1)(c) Feasibility Study

The feasibility study will include practical design procedures described in Division 11 of this Design Manual. The support team identified in [550.02\(1\)\(a\)](#) will assume the role of the Multiagency and Interdisciplinary Advisory (MAIA) team described in [Chapter 1100](#). Prior to commencing the feasibility study it is critical to establish the project performance needs (see [Chapter 1101](#)) with the support team.

Study the transportation network in the area. This study must identify the segments of both the local and regional network that are currently experiencing congestion or safety deficiencies, or where planned land use changes will prompt the need to evaluate the demands on and the capacity of the transportation system. The study area includes the affected existing and proposed interchanges/ intersections upstream and downstream from the proposed access point revision. Extend the study area far enough that the proposal creates no significant impacts to the adjacent interchanges/intersections, then analyze only through the area of influence. When the area of influence extends beyond one interchange/intersection upstream and downstream, extend the analysis to include the extent of the traffic impacts.

Segments of the local and regional network within the study area will be evaluated for system improvements. Part of the study process is to identify local infrastructure needs and develop a proposal. The study must investigate investments in local infrastructure improvements to meet the purpose and need of the proposal. It must be shown that the local infrastructure alone cannot be improved to address the purpose and need. The limited access facility should not be used to solve congestion problems on the local network.

During the feasibility study process and while developing a proposal, it is important to use the data and analysis methods required for an IJR. If the study indicates that an IJR is warranted, the study data can then be utilized in the IJR. The feasibility study and the IJR can also be used to support the transportation analysis requirements in the project's environmental documentation (DCE, EA, or EIS).

550.02(1)(d) Analysis and Data to Support Proposal

The proposal analysis tools, data, and study area must be agreed upon by the support team. Use the Methods and Assumptions Document to detail the specific items and record the team's agreement to them. Establishing assumptions upfront ensures the project will have the highest rate of success. For further guidance and examples on assumptions documents, see: www.wsdot.wa.gov/design/accessandhearings

Show that a preliminary (planning level) analysis, comparing build to no-build data, was conducted for the current year, year of opening, and design year, comparing baseline, no-build condition, and build alternatives. Include the following steps:

1. Define the study area. The study area is a minimum of one interchange upstream and downstream from the proposal. The study area should be expanded as necessary to capture operational impacts of adjacent interchanges in the vicinity that are, or will be, bottlenecks or chokepoints that influence the operations of the study interchange.
2. Establish baseline transportation networks and future land use projections for the study area. The baseline transportation network typically includes local, regional, and state transportation improvement projects that are funded. The land use projection includes population and employment forecasts consistent with the regional (MPO or RTPO) and local jurisdiction forecasts.
3. Collect and analyze current traffic volumes to develop current year, year of opening, and design year peak hour traffic estimates for the regional and local systems in the area of the proposal. Use regional transportation planning organization-based forecasts, refined by accepted travel demand estimating procedures. Forecasts for specific ramp traffic may require other methods of estimation procedures and must be consistent with the projections of the travel demand models. Modeling must include increased demand caused by anticipated development.
4. Identify the origins and destinations of trips on the local systems, the existing interchange/intersections, and the proposed access using existing information.
5. Develop travel demand forecasts corresponding to assumed improvements that might be made to the following:

- The local system: widen, add new surface routes, coordinate the signal system, control access, improve local circulation, or improve parallel roads or streets.
 - The existing interchanges: lengthen or widen ramps, add park & ride lots, or add frontage roads.
 - The freeway lanes: add collector-distributor roads or auxiliary lanes.
 - Transportation system management and travel demand management measures.
6. Describe the current year, year of opening, and design year level of service at all affected locations within the study area, including local systems, existing ramps, and freeway lanes.

550.02(2) Conduct Analysis and Prepare IJR

Prepare a detailed IJR using the guidance in [550.03](#), Interchange Justification Report and Supporting Analyses, and [Exhibit 550-3](#).

550.02(2)(a) IJR Policy Points

The IJR addresses the following eight specific policy points, which are described in detail in [550.04](#):

1. Need for the Access Point Revision
2. Reasonable Alternatives
3. Operational and Crash Analyses
4. Access Connections and Design
5. Land Use and Transportation Plans
6. Future Interchanges
7. Coordination
8. Environmental Processes

550.03 Interchange Justification Report and Supporting Analyses

The eight policy points are presented below. Factors that affect the scope include location (rural or urban), access points (new or revised), ramps (new or existing), and ramp terminals (freeway or local road).

550.03(1) Policy Point 1: Need for the Access Point Revision

What are the current and projected needs? Why are the existing access points and the existing or improved local system unable to meet the proposal needs? Is the anticipated demand short or long trip?

Describe the need for the access point revision and why the existing access points and the existing or improved local system cannot address the need. How does the proposal meet the design year travel demand? Provide the analysis and data to support the need for the access request.

550.03(1)(a) Project Description

Describe the needs being addressed, and define the current problem or deficiency that the project is looking to address or overcome. Using specific performance measures can be helpful; for example, state the average speed or throughput during the A.M. or P.M. peak. The need for improvement should be established using factors such as existing conditions and the conditions anticipated to occur in the analysis years under the “no-build” alternative, or other factors such as the need for system linkage.

Demonstrate that improvements to the local transportation system and the existing interchanges cannot be improved to satisfactorily accommodate the design year travel demands. Describe traffic mitigation measures considered at locations where the level of service (LOS) is (or will be) below agreed-upon service standards in the design year. (See the State Highway System Plan for further information on LOS standards.) Additional measures of effectiveness (such as density, speed changes, delay, and travel times) should be discussed and documented in the Methods and Assumptions Document.

The access point revision should meet regional, not local, travel demands. Describe the local and regional traffic (trip link and/or route choice) benefiting from the proposal.

550.03(2) Policy Point 2: Reasonable Alternatives

Describe the reasonable alternatives that have been evaluated.

Describe all reasonable alternatives that have been considered. These include the design options, locations, project phasing, and transportation system management-type improvements such as ramp metering, public transportation, and HOV facilities that have been assessed and that meet the proposal’s design year needs. The alternatives analysis must be the same as that used in the environmental documentation.

After describing each of the alternatives that were proposed, explain why reasonable alternatives were omitted or dismissed from further consideration. Where operational and safety concerns are some of the reasons that alternatives are rejected, the support group may need operational and/or safety analyses for those alternatives (see [Policy Point 3](#) below).

Future projects must be coordinated as described in [Policy Point 7](#), Coordination.

550.03(3) Policy Point 3: Operational and Crash Analyses

How will the proposal affect safety and traffic operations at year of opening and design year?

Policy Point 3 documents the operational and safety effects of the proposal(s) and the results that support the final proposal, including any mitigation measures that compensate for operational and/or safety tradeoffs. Policy Point 3 shall also include a conceptual plan of the type and location of the signs proposed to support the design alternative.

The preferred operational alternative is selected, in part, by showing that it will meet the access needs without causing a significant adverse impact on the operation and safety of the freeway and the affected local network, or that the proposal impacts will be mitigated.

Document the results of the following analyses in the report:

- Operational Analysis – “No-Build” Alternative: An operational analysis of the current year, year of opening, and design year for the existing limited access freeway and the affected local roadway system. This is the baseline plus state transportation plan and comprehensive plan improvements expected to exist at the year of opening or design year. All of the alternatives will be compared to the no-build condition. The report should document the calibration process and results that show the current year operations closely match actual field conditions.
- Operational Analysis – “Build” Alternative: An operational analysis of the year of opening and design year for the proposed future freeway and the affected local roadway system.
- Crash Analysis – “Observed crash history”: Document the observed crash history, for the most current data years, of the existing limited access freeway and the affected local roadway system. The support team will determine the number of years as well as the scope and detail of this section.
- Crash Analysis – “Proposal(s)”: A crash analysis should be performed for the year of opening and design year of the existing limited access freeway and the affected local roadway system for the “no-build,” “build,” and possibly other scenarios as determined by the support team. The support team will also determine the year of opening and design year as well as the scope and detail of this section.

The data used for the operational and safety analyses must be the same as the data used in the environmental documentation. If not, describe and justify the discrepancies in the Methods and Assumptions Document as well as in this section of the IJR. The transportation section of the environmental document should include a similar discussion, and the Methods and Assumption Document should be included in the appendix of the environmental document.

550.03(3)(a) Operational Analyses

Demonstrate that the proposal does not have a significant adverse impact on the operation of the freeway and the affected local roadway system. If there are proposal impacts, explain how the impacts will be mitigated.

To understand the proposal’s positive and negative impacts to main line, crossroad, and local system operations, the selection of the appropriate analysis tool(s) is critical. This is a major piece of the assumptions process. Record the support team’s tool selection agreement in the Methods and Assumptions Document. FHWA’s [Traffic Analysis Toolbox](#) provides an overview and details for making the best tool category selection.

Document the selected operational analysis procedures. For complex urban projects, a refined model might be necessary. WSDOT supports the traffic analysis and traffic simulation software listed on the HQ Traffic Operations website:

 www.wsdot.wa.gov/design/traffic/analysis/

All operational analyses shall be of sufficient detail, and include sufficient data and procedure documentation, to allow independent analysis during FHWA and Headquarters evaluation of the proposal. For Interstate proposals, Headquarters must provide concurrence before it transmits the proposal to FHWA with its recommendation.

Prepare a layout displaying adjacent interchanges/intersections and the data noted below, based on support team determination, which should show:

- Distances between intersections or ramps of a proposed interchange, and those of adjacent existing and known proposed interchanges.
- Design speeds.
- Grades.
- Truck volume percentages on the freeway, ramps, and affected roadways.
- Adjustment factors (such as peak hour factors).
- Affected freeway, ramp, and local roadway system traffic volumes for the “no-build” and each “build” option. This will include: A.M. and P.M. peaks (noon peaks, if applicable); turning volumes; average daily traffic (ADT) for the current year; and forecast ADT for year of opening and design year.
- Affected main line, ramp, and local roadway system lane configurations.

The study area of the operational analysis on the local roadway system includes documenting that the local network is able to safely and adequately collect and distribute any new traffic loads resulting from the access point revision. Expand the limits of the study area, if necessary, to analyze the coordination required with an in-place or proposed traffic signal system. Record the limits of the analysis as well as how the limits were established in the project Methods and Assumptions Document.

Document the results of analyzing the existing access and the proposed access point revision at all affected locations within the limits of the study area, such as weave, merge, diverge, ramp terminals, crash sites, and HOV lanes; along the affected section of freeway main line and ramps; and on the affected local roadway system. In the report, highlight the following:

- Any location for which there is a significant adverse impact on the operation or safety of the freeway facility, such as causing a reduction of the operational efficiency of a merge condition at an existing ramp; introducing a weave; or significantly reducing the level of service on the main line due to additional travel demand. Note what will be done to mitigate this adverse impact.
- Any location where a congestion point will be improved or eliminated by the proposal, such as proposed auxiliary lanes or collector-distributor roads for weave sections.
- Any local roadway network conditions that will affect traffic entering or exiting the freeway. If entering traffic is to be metered, explain the effect on the connecting local system (for example, vehicle storage).
- When the existing local and freeway network does not meet agreed-upon level of service standards, show how the proposal will improve the level of service or keep it from becoming worse than the no-build condition in the year of opening and the design year. Level of service should not be the only performance measure

evaluated. There are other measures of effectiveness that can be used to illustrate a broader traffic operation perspective.

550.03(3)(b) Crash Analysis

This section describes the two parts of an IJR crash analysis: the existing (observed) condition as well as the proposed “no-build,” “build,” and possibly other scenarios as determined by the support team. It is the intent of this section that future readers will fully understand the existing condition and all of the presented scenarios without the need for other documents. The study limits (area and years) are the same as the study limits of the operational analyses. If the support team determines that some limits are different from the operational analysis, document them by describing and justifying the differences in the Methods and Assumptions Document as well as in Policy Point 3 of the IJR. Document all the tools used and all assumptions made and agreed to as well as the basis and reason(s) for using those tools and assumptions. The data used for the crash analysis must be the same as the data used in the operational analysis and the environmental documentation. If not, describe and justify the differences. (Chapter 321, Sustainable Safety, gives crash analysis guidance.)

Crash analysis data needs to include a disclaimer: “Under Section 409 of Title 23 of the United States Code, crash data is prohibited from use in any litigation against state, tribal, or local government that involves the location(s) mentioned in the crash data.”

550.03(3)(b)(1) Existing (Observed) Portion of Crash Analysis

Identify and document the crash histories, severities, and types for the existing freeway section and the adjacent affected local surface system within the study area as determined by the support team. A five-year crash history is a good default; however, the support team will determine the number of years.

Document all the tools used and all assumptions made and agreed to as well as the basis and reason(s) for using those tools and assumptions.

Detailed list of the existing (observed) portion of the crash analysis:

Document the existing safety performance of the freeway section and the adjacent affected local surface system within the study area.

- Produce a diagram of the crash history of the freeway section and the adjacent affected local surface system within the study limits.
- Analyze the existing performance of the freeway section and the adjacent affected local surface system within the study area for over dispersions of crash types, contributing circumstances, and/or severities.
 - o What types of crashes are occurring (overturns, rear-ends, enter-at-angle, hitting fixed object)?
 - o What types of crashes are most prevalent?
 - o Are there any patterns of crash type or cause?

- o Use ISATe (Enhanced Interchange Safety Analysis Tool) to determine if there are any over dispersions of crash types or causes.
- Determine severity (fatalities, serious injuries, evident injuries, possible injuries, and/or property damage only).
 - o What crash severities are most prevalent?
 - o Are there any crash severity patterns?
 - o Use ISATe to determine if there are any over dispersions of severities.
- Use ISATe to perform an expected safety performance analysis using the observed crashes to determine if the existing safety performance is normal for the existing configuration as compared to others like it (see [Chapter 321](#) for guidance).

550.03(3)(b)(2) Proposed Portion of Crash Analysis

Identify and document the predicted safety performance of the proposed access point revision proposal(s), including the freeway section, speed change lanes, ramps, collector-distributor (c-d) lanes, ramp terminal intersections, and the adjacent affected local surface system, including segments and intersections.

Demonstrate that (1) the final proposal does not have a significant adverse impact on the safety of the freeway or the adjacent affected local surface system, or (2) a list of the mitigation measures mitigate each adverse impact.

Document all the tools used and all assumptions made and agreed to as well as the basis and reason(s) for using those tools and assumptions.

Detailed list of the predicted safety performance portion of the crash analysis.

- Document the predicted safety performance of the freeway section using the Highway Safety Manual (to access ISATe), speed change lanes, ramps, c-d lines, ramp terminal intersections, and the adjacent affected local surface system, including segments and intersections within the study limits for each of the proposed “no-build,” “build,” and possibly other scenarios and alternatives as determined by the support team.
- Document the design elements that contribute to the predicted safety performance, including types and severities of crashes, especially design elements that contribute to significant adverse safety impacts of the freeway or the adjacent affected local surface system.
- Compare the safety performances of the “no-build” scenario(s) with the safety performance of the proposed scenario(s) to demonstrate that the final proposal(s) do not have a significant adverse impact on the safety of the freeway or the adjacent affected local surface system.
 - o Break out fatal and serious injuries in this analysis.

550.03(4) Policy Point 4: Access Connections and Design

Will the proposal provide fully directional interchanges connected to public streets or roads, spaced appropriately, and designed to meet the identified performance needs?

Provide for all directions of traffic movement on Interstate system-to-system type interchanges, unless justified. The intent is to provide full movement at all interchanges, whenever feasible. Partial interchanges are discouraged and will not likely be approved for Interstate access. Less than fully directional interchanges for special-purpose access for transit vehicles, for HOVs, or to or from park & ride lots will be considered on a case-by-case basis.

A proposed new or revised interchange access must connect to a public freeway, road, or street and be endorsed by the local governmental agency or tribal government having jurisdiction over said public freeway, road, or street.

Explain how the proposed access point relates to present and future proposed interchange configurations and the Design Manual spacing criteria. Note that urban and rural interchange spacing for crossroads also includes additional spacing requirements between adjacent ramps, as noted in [Chapter 1360](#).

Develop the proposal in sufficient detail to conduct a design and operational analysis. Include the number of lanes, horizontal and vertical curvature, lateral clearance, lane width, shoulder width, weaving distance, ramp taper, interchange spacing, and all traffic movements. This information is presented as a sketch or a more complex layout, depending on the complexity of the proposal.

The status of all known or anticipated project deviations must be noted in this policy point, as described in [Chapter 300](#).

550.03(5) Policy Point 5: Land Use and Transportation Plans

Is the proposed access point revision compatible with all land use and transportation plans for the area?

Show that the proposal is consistent with local and regional land use and transportation plans. Before final approval, all requests for access point revisions must be consistent with the regional or statewide transportation plan, as appropriate. The proposed access point revision may affect adjacent land use and, conversely, land use may affect the travel demand generated. Therefore, reference and show compatibility with the land use plans, zoning controls, and transportation ordinances in the affected area.

Explain the consistency of the proposed access point revision with the plans and studies, the applicable provisions of [23 CFR Part 450](#), the applicable transportation conformity requirements of [40 CFR Parts 51 and 93](#), and [Chapter 36.70A RCW](#).

The support team reviews regional and state transportation plans to determine whether the need and proposed solution are already identified. Proposals to request new or reconstructed interchanges must be consistent with those plans.

If the proposed access is not specifically referenced in the transportation plans, define its consistency with the plans and indicate the process for the responsible planning agency to incorporate the project. In urbanized areas, the plan refinement must be adopted by the metropolitan planning organization (MPO) before the project is designed. The action must also be consistent with the multimodal State Transportation Plan.

550.03(6) Policy Point 6: Future Interchanges

Is the proposed access point revision compatible with a comprehensive network plan? Is the proposal compatible with other known new access points and known revisions to existing points?

The report must demonstrate that the proposed access point revision is compatible with other planned access points and revisions to existing points.

Reference and summarize any comprehensive freeway network study, plan refinement study, or traffic circulation study.

Explain the consistency of the proposed access point revision with those studies.

550.03(7) Policy Point 7: Coordination

Are all coordinating projects and actions programmed and funded?

When the request for an access point revision is generated by new or expanded development, demonstrate appropriate coordination between the development and the changes to the transportation system. Coordination will include local agencies, local groups, and public outreach. See [Chapter 1100.03 Community Engagement](#).

Show that the proposal includes a commitment to complete the other non-interchange/non-intersection improvements that are necessary for the interchange/intersection to function as proposed. For example, if improvements to the local circulation system are necessary for the proposal to operate, they must be in place before new ramps are opened to traffic. If future reconstruction is part of the mitigation for design year level of service, the reconstruction projects must be in the State Highway System Plan and Regional Transportation Plan.

All elements for improvements are encouraged to include known fiscal commitments and an anticipated time for completion. If the project is to be constructed in phases, it must be demonstrated in Policy Point 3 that each phase can function independently and does not affect the safety and operational efficiency of the freeway. Identify the funding sources, both existing and projected, and the estimated time of completion for each project phase.

550.03(8) Policy Point 8: Environmental Processes

What is the status of the proposal's environmental processes? This section should be something more than just a status report of the environmental process; it should be a brief summary of the environmental process.

All requests must closely adhere to the planning and environmental review processes as required in 23 CFR parts 450 and 771. This means the final FHWA approval of requests for new or revised access cannot precede the completion of these processes or necessary actions.

All requests for access point revisions on freeways must contain information on the status of the environmental approval and permitting processes.

The following are just a few examples of environmental status information that may apply:

- Have the environmental documents been approved? If not, when is the anticipated approval date?
- What applicable permits and approvals have been obtained and/or are pending?
- Are there hearings still to be held?

- Is the environmental process waiting for an engineering and operational acceptability decision?
- Are the assumptions, methodology, study area, and traffic analysis used in the transportation element of the environmental document consistent with the IJR? If no, explain why not and provide justification.

550.04 Report Organization and Appendices

Begin the IJR with an executive summary. Briefly describe the access point revision being submitted for a decision and why the revision is needed. Include a brief summary of the proposal.

The IJR must be assembled in the policy point order noted in [550.02\(2\)](#).

Formatting for the IJR includes providing numbered tabs in the report for each policy point section and each appendix and numbering all pages, including references and appendices. A suggestion for page numbering is to number each individual section, such as “Policy Point 3, PP3–4” and “Appendix 2, A2–25.” This allows for changes without renumbering the entire report.

On the bottom of each page, place the revision date for each version of the IJR. As an individual page is updated, this revision date will help track the most current version of that page. Also, include the title of the report on the bottom of each page.

Use a three-ring binder for ease of page replacement. Do not use comb or spiral binding.

Appendix A is reserved for the Methods and Assumptions Document. Include meeting notes where subsequent decisions are made as additional appendices to the original signed document.

Additional appendices may include documents such as technical memorandums, memos, and traffic analysis operations output.

550.05 IJR Review and Approval

Concurrence and approval of a new or revised access point is based on the IJR. The IJR must contain sufficient information about and evaluation/analysis of the proposal to provide assurance that the safety and operations of the freeway and local systems are not significantly impacted.

The region, or proponents, with the help of the support team, prepares the IJR and submits four draft copies, including backup traffic data, to the HQ Access and Hearings Section for review.

For a final IJR submittal, contact the HQ Access and Hearing Section for the necessary number of copies.

550.05(1) Interstate IJR Approval

On Interstate projects, a submittal letter is sent by the region to the HQ Access and Hearings Section, requesting final FHWA approval of the IJR. Interstate IJR's are submitted by Headquarters to FHWA for approval.

Interstate access point revisions are reviewed by both WSDOT Headquarters and FHWA. This can be a two-step process:

- If environmental documentation has not yet been approved, a finding of engineering and operational acceptability can be given.
- If the environmental documentation is complete, final approval can be given.

Some Interstate IJR's are reviewed and approved by the Washington FHWA Division Office. Other Interstate IJR's are reviewed and approved by the FHWA Headquarters Office in Washington DC. Additional review time is necessary for reports that have to be submitted to Washington DC (see [Exhibit 550-1](#)).

Final IJR approval by FHWA is provided when the appropriate final environmental decision is complete: ECS, FONSI, or ROD (see the [Glossary](#)).

550.05(2) Non-Interstate IJR Approval

On non-Interstate projects, concurrence from the support team is required on the Methods and Assumptions to document the acceptance of the scope and complexity of the IJR or the acceptance of the decision that an IJR is not required. If an IJR is prepared, the appropriate WSDOT HQ Assistant State Design Engineer grants the final approval (see [Exhibits 550-2](#) and [550-4](#)).

550.06 Updating an IJR

Recognizing that the time period between the approval of the IJR and the construction contract commonly spans several years, the approved IJR will be reviewed and updated to identify changes that may have occurred during this time period. If no work has begun in accordance with the environmental documentation, and several years have passed, a re-evaluation of the EA/EIS/DCE may be required. Submit a summary assessment to the HQ Design Office for evaluation to determine whether the IJR needs to be updated. The HQ Design Office will forward the assessment to FHWA if necessary. The assessment is a document summarizing the significant changes since it was approved. Contact the HQ Access and Hearings Section to coordinate this summary assessment.

550.07 Documentation

Refer to [Chapter 300](#) for design documentation requirements.

550.08 References

550.08(1) Federal/State Laws and Codes

[23 Code of Federal Regulations \(CFR\) Part 450](#) (implementing 23 United States Code [USC] Section 135)

[40 CFR Parts 51 and 93](#) (regarding federal conformity with state and federal air quality implementation plans)

[23 USC Sections 111](#) (requires the U.S. Secretary of Transportation to approve access revisions to the Interstate System), [134](#) (metropolitan transportation planning), and [135](#) (statewide transportation planning)

FHWA “Interstate System Access Information Guide”

🔗 www.fhwa.dot.gov/design/interstate/pubs/access/access.pdf

Notice of policy statement: “Additional Interchanges to the Interstate System,” FHWA notice published in the Federal Register, February 11, 1998 (Vol. 63, No. 28)

🔗 www.access.gpo.gov/su_docs/fedreg/a980211c.html

[Revised Code of Washington \(RCW\) 36.70A](#), Growth management – Planning by selected counties and cities

550.08(2) Design Guidance and Supporting Information

Design Manual, [Chapter 320](#), Traffic Analysis

Design Manual, [Chapter 321](#), Sustainable Safety

Design Manual Glossary – Defines many of the terms encountered in this chapter

FHWA Traffic Analysis Toolbox (tools used in support of traffic operations analyses)

🔗 www.ops.fhwa.dot.gov/trafficanalysistools/index.htm

Highway Capacity Manual, (HCM) 2010, Transportation Research Council

Highway Safety Manual

[Local Agency Guidelines](#) (LAG), M 36-63, WSDOT

State Highway System Plan 🔗 www.wsdot.wa.gov/planning/HSP

WSDOT GeoPortal – Tool for viewing WSDOT spatial data (like Functional Class, Interchange Drawings, City Limits, and State Routes) via a web browser. Users can check a box to select from a variety of base maps and data layers.

🔗 wwwi.wsdot.wa.gov/planning/data/gis/tools/geoportal_int.htm

WSDOT HQ Access and Hearings web page (provides guidance and timelines for preparing IJR and example Methods and Assumptions Documents):

🔗 www.wsdot.wa.gov/design/accessandhearings

Exhibit 550-1 Interstate Routes: IJR Content and Review Levels

Project Type	Support Team	Policy Point								Concurrence	Approval
		1	2	3	4	5	6	7	8		
Interstate Routes											
New freeway-to-crossroad interchange in a Transportation Management Area ^[1]	Yes	✓	✓	✓	✓	✓	✓	✓	✓	FHWA and HQ	FHWA DC
New partial interchange	Yes	✓	✓	✓	✓	✓	✓	✓	✓	FHWA and HQ	FHWA DC
New HOV direct access	Yes	✓	✓	✓	✓	✓	✓	✓	✓	FHWA and HQ	FHWA DC
New freeway-to-freeway interchange	Yes	✓	✓	✓	✓	✓	✓	✓	✓	FHWA and HQ	FHWA DC
Revision to freeway-to-freeway interchange in a Transportation Management Area ^{[1][2]}	Yes	✓	✓	✓	✓	✓	✓	✓	✓	FHWA and HQ	FHWA
New freeway-to-crossroad interchange not in a Transportation Management Area ^[1]	Yes	✓	✓	✓	✓	✓	✓	✓	✓	HQ	FHWA
Revision to freeway-to-freeway interchange not in a Transportation Management Area ^{[1][2]}	Yes	✓	✓	✓	✓	✓	✓	✓	✓	HQ	FHWA
Revision to interchange ^{[2][3]}	Yes	✓	✓	✓	✓	✓	✓	✓	✓	HQ	FHWA
Transit flyer stop on main line	Yes	✓	✓	✓	✓	✓	✓	✓	✓	HQ	FHWA
Transit flyer stop on an on-ramp	No	✓		✓	✓					HQ	FHWA
Addition of entrance or exit ramps that complete basic movements at an existing interchange	Yes	✓	✓	✓	✓	✓	✓	✓	✓	HQ	FHWA
Abandonment of a ramp ^[4]	Yes	✓	✓	✓	✓	✓	✓	✓	✓	HQ	FHWA
Locked gate ^[6]	No	✓			[5]					HQ	FHWA
Access breaks that do not allow any type of access to main line or ramps	No	✓	✓		[5]					HQ	FHWA
Pedestrian structure	No	✓			[5]					HQ	FHWA
Construction/emergency access break	No	✓	✓	✓	✓					Region	FHWA

Notes:

All policy points must be addressed on all studies. The scale and scope of the project dictate the level of effort needed to address each policy point. Blank cells in the table above indicate that the policy point will need to be addressed briefly in the IJR. Consult the HQ Access and Hearings Section for direction.

- [1] In Washington, designated Transportation Management Areas include Clark, King, Kitsap, Pierce, Snohomish, and Spokane counties.
- [2] "Revision" includes changes in interchange configuration, even though the number of access points does not change. Changing from a cloverleaf to a directional interchange is an example of a "revision."
- [3] Revisions that might adversely affect the level of service of the through lanes. Examples include: doubling lanes for an on-ramp with double entry to the freeway; adding a loop ramp to an existing diamond interchange; and replacing a diamond ramp with a loop ramp. Revisions to the ramp terminal intersections may not require an IJR unless the traffic analysis shows an impact to the main line traffic.
- [4] Unless it is a condition of the original approval.
- [5] Update the right of way/limited access plan as necessary.
- [6] As part of [Policy Point 1](#), include a narrative stating that all other alternatives are not feasible.

Exhibit 550-2 Non-Interstate Routes: IJR Content and Review Levels

Project Type	Support Team	Policy Point								Concurrence	Approval
		1	2	3	4	5	6	7	8		
Non-Interstate Routes											
New freeway-to-crossroad interchange on a predominately grade-separated corridor	Yes	✓	✓	✓	✓	✓	✓	✓	✓	Region	HQ
New freeway-to-freeway interchange	Yes	✓	✓	✓	✓	✓	✓	✓	✓	Region	HQ
Revision to freeway-to-freeway interchange	Yes	✓	✓	✓	✓	✓	✓	✓	✓	Region	HQ
New freeway-to-crossroad interchange on a predominately at-grade corridor ^[5]	No	✓		✓	✓					Region	HQ
Revision to interchange ^[1]	No	✓		✓	✓					Region	HQ
Addition of entrance or exit ramps that complete basic movements at an existing interchange	No	✓		✓	✓					Region	HQ
Abandonment of a ramp ^[2]	No	✓		✓						Region	HQ
Transit flyer stop on main line	Yes	✓	✓	✓	✓	✓	✓	✓	✓	Region	HQ
Transit flyer stop on an on-ramp	No	✓		✓	✓					Region	HQ
Locked gate ^[4]	No	✓			[3]					Region	HQ
Pedestrian structure	No	✓			[3]					Region	HQ
Construction/emergency access break	No	✓	✓	✓						Region	HQ

Notes:

Policy points to be addressed will be determined by the IJR support team. The scale and scope of the project dictate the level of effort needed to address each policy point. Blank cells in the table above indicate that the policy point will need to be addressed briefly in the IJR as determined by the support team. Consult the HQ Access and Hearings Section for direction.

- [1] Revisions that might adversely affect the level of service of the through lanes. Examples include: doubling lanes for an on-ramp with double entry to the freeway; adding a loop ramp to an existing diamond interchange; and replacing a diamond ramp with a loop ramp.
- [2] Unless it is a condition of the original approval.
- [3] Update the right of way/limited access plan as necessary.
- [4] As part of [Policy Point 1](#), include a narrative stating that all other alternatives are not feasible.
- [5] Example: Revising an existing at-grade intersection into an access controlled grade-separated interchange.

Exhibit 550-3 Interstate IJR: Process Flow Chart

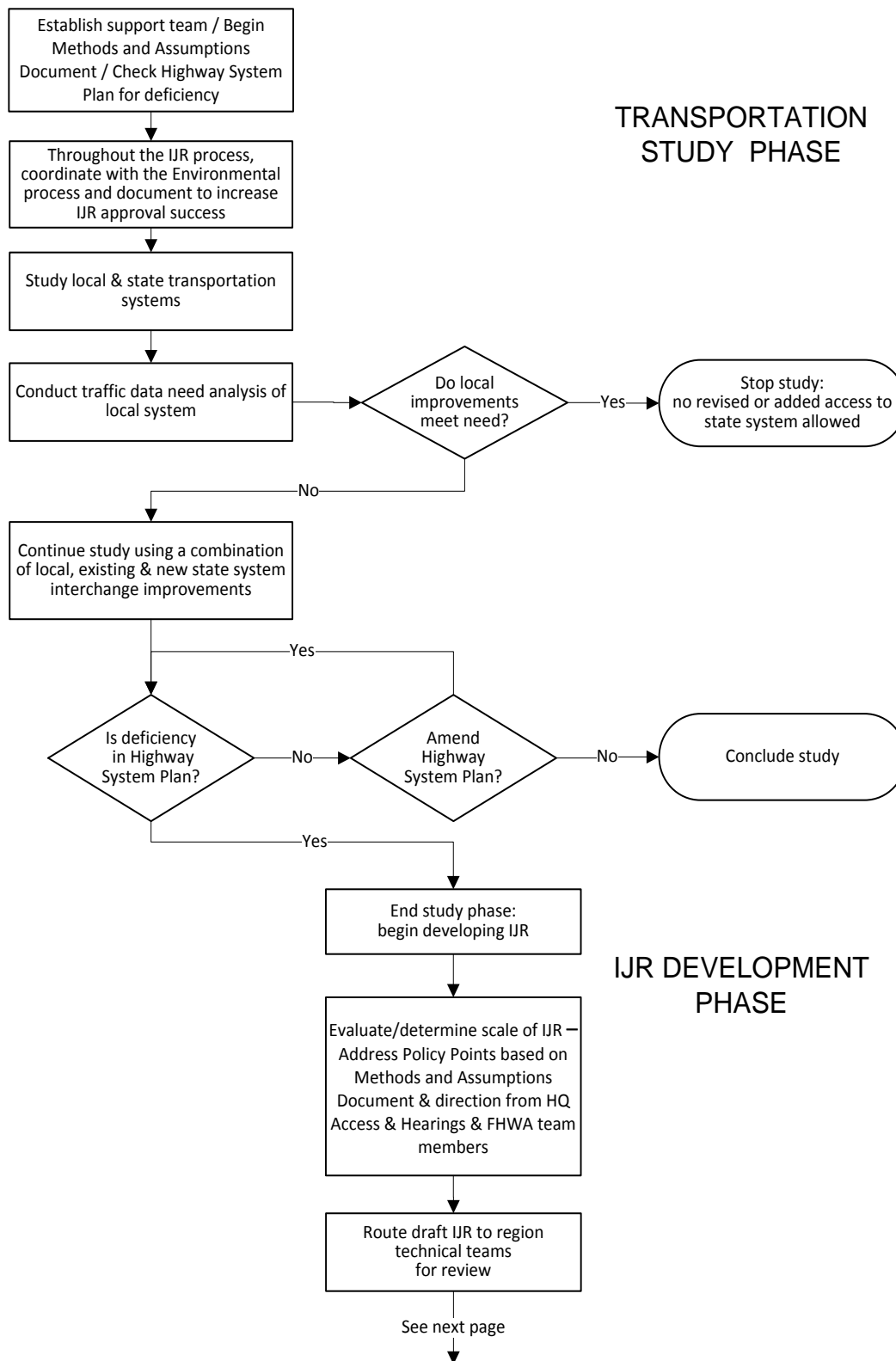

Exhibit 550-3 Interstate IJR: Process Flow Chart (continued)

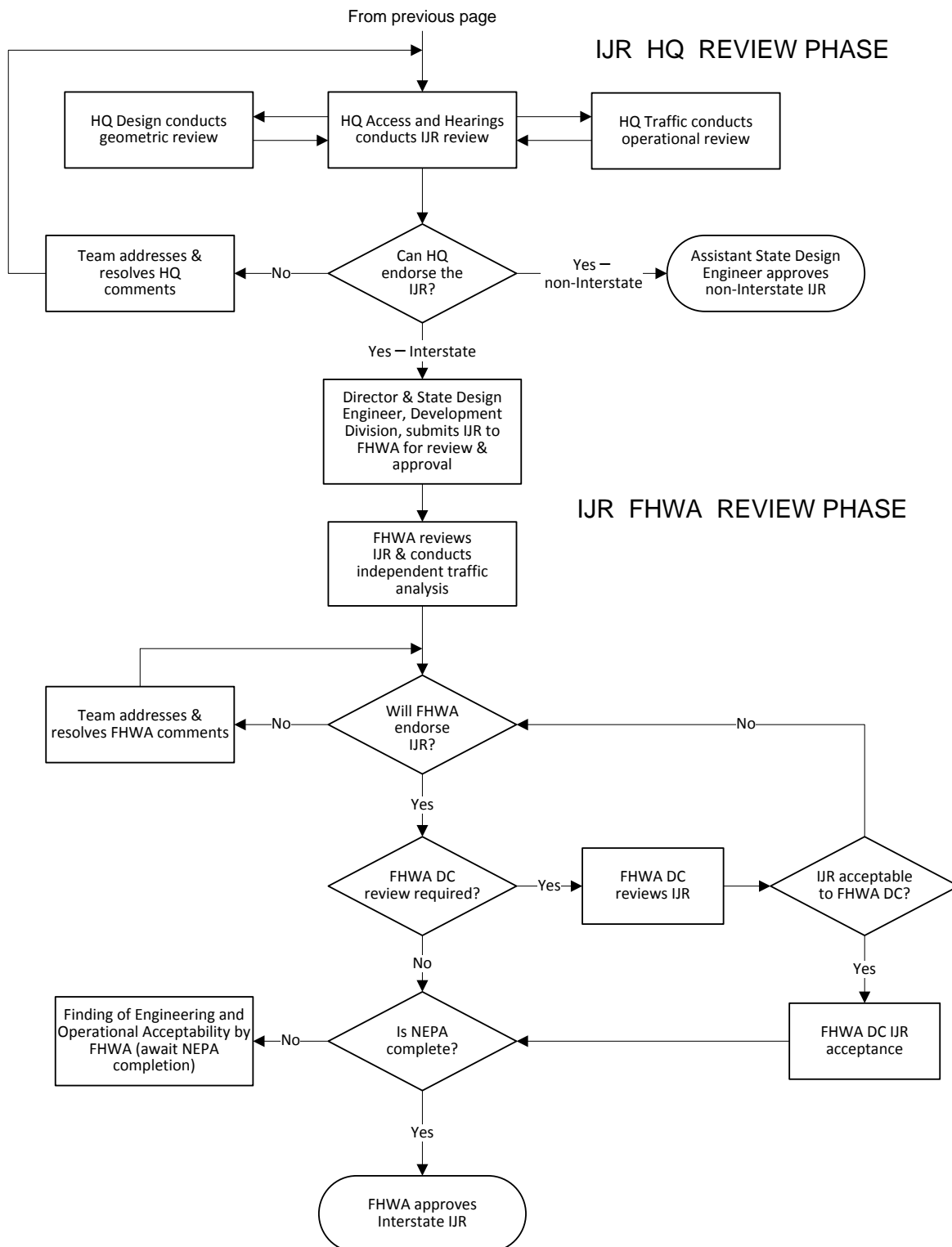

Exhibit 550-4 Non-Interstate IJR: Process Flow Chart

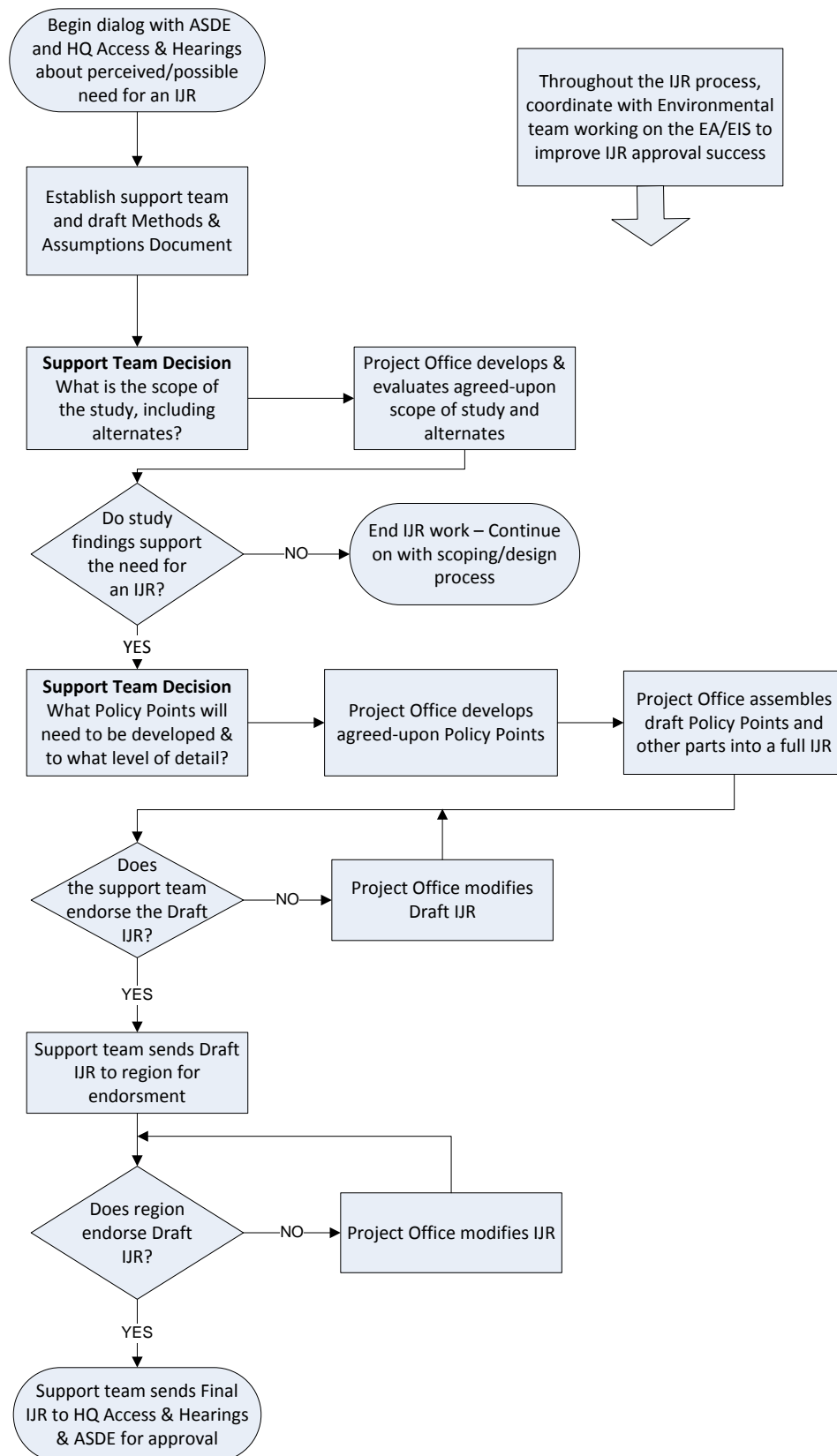

Exhibit 550-5 Methods and Assumptions Document for IJR: Concurrence Form Example

**Methods and Assumptions Document Concurrence Form
for Interchange Justification Report
"Project Title" "MP to MP"**

<p>We the undersigned hereby concur with the methods and assumptions used for the (INSERT PROJECT NAME) Interchange Justification Report.</p>	
<p>IJR Engineer of Record:</p>	<p>By: _____ Date: _____</p>
<p>Traffic Analysis Engineer</p>	<p>By: _____ Date: _____</p>
<p>Region Traffic Engineer</p>	<p>By: _____ Date: _____</p>
<p>Project Development Engineer</p>	<p>By: _____ Date: _____</p>
<p>Development Services and Access Manager</p>	<p>By: _____ Date: _____</p>
<p>Assistant State Design Engineer</p>	<p>By: _____ Date: _____</p>
<p>FHWA Area Engineer</p>	<p>By: _____ Date: _____</p>
<p>FHWA Safety and Design Engineer</p>	<p>By: _____ Date: _____</p>
<p>City Representative</p>	<p>By: _____ Date: _____</p>
<p>County Representative</p>	<p>By: _____ Date: _____</p>

Exhibit 550-6 IJR: Stamped Cover Sheet Example

Interchange Justification Report
“Project Title”
“MP to MP”

This **Interchange Justification Report** has been prepared under my direct supervision, in accordance with Chapter 18.43 RCW and appropriate Washington State Department of Transportation manuals.

IJR Engineer of Record

By: _____ P.E.
 Project Engineer

Date: _____

Traffic Analysis Engineer

By: _____ P.E.
 Traffic Analysis Engineer

Date: _____

**Concurrence –
 Region Traffic Engineer**

By: _____ P.E.

Date: _____

**Concurrence –
 Project Development Engineer**

By: _____ P.E.

Date: _____

**WSDOT Approval –
 Development Services and
 Access Manager**

By: _____ P.E.

Date: _____

**WSDOT Approval –
 Assistant State Design Engineer**

By: _____ P.E.

Date: _____

**FHWA Approval –
 FHWA Safety and Design
 Engineer**

By: _____

Date: _____

610.04(9) Buildings, Park & Ride Lots, Communication Towers, and Rest Areas

In general, the RME functions as the clearinghouse for the geotechnical work to be conducted in each of the phases, for technical review of the work if it is performed by consultants, or for getting the work done in-house. For sites and designs that are more geotechnically complex, the RME contacts the HQ Geotechnical Office for assistance. (See the [Geotechnical Design Manual](#) for geotechnical investigation and design requirements for these types of facilities.)

610.04(9)(a) Site Selection

Conceptual geotechnical investigation (based on historical data and minimal subsurface investigation) of several alternative sites is performed in which the geotechnical feasibility of each site for its intended use is evaluated, allowing the sites to be ranked. In this phase, geological hazards (such as landslides, rockfall, compressible soils, and liquefaction) are identified, and geotechnical data adequate to determine a preliminary cost to develop and build on the site is gathered.

610.04(9)(b) Schematic Design

For the selected site, the best locations for structures, utilities, and other elements of the project are determined based on site constraints and ground conditions. In this phase, the site is characterized more thoroughly than in the site selection phase, but subsurface exploration is not structure specific.

610.04(9)(c) Design and PS&E Development

The final locations of each of the project structures, utilities, and other project elements determined from the schematic design phase are identified. Once these final locations are available, a geotechnical investigation is conducted that is adequate to complete the final design of each of the project elements, such as structure foundations, detention/retention facilities, utilities, parking lots, roadways, and site grading. From this investigation and design, the final PS&E is developed.

610.04(10) Retaining Walls, Reinforced Slopes, and Noise Walls**610.04(10)(a) Project Definition**

The designer provides the RME with a description and location of the proposed walls or reinforced slopes, including the potential size of the proposed structures and other pertinent site information. At this stage, only the identification and feasibility of the proposed walls or reinforced slopes are investigated. A field review may also be conducted as part of the investigation effort. In general, if soil/rock conditions are poor and/or large walls or reinforced slopes are anticipated, the RME requests that the HQ Geotechnical Office participate in the field review and reporting efforts. The cost and schedule requirements for the geotechnical investigation are also determined at this time.

A brief conceptual-level report that summarizes the results of the investigation may be provided to the designer at this time, depending on the complexity of the geotechnical issues.

610.04(10)(b) Project Design and PS&E Development

Geotechnical data necessary to allow completion of the PS&E-level design for walls and reinforced slopes are compiled during the design and PS&E development phases. These include soils borings, testing, and final geometric data. Detailed designs of walls and reinforced slopes can be done once the roadway geometry is established and geotechnical data are available. The purpose of this design effort is to determine the wall and slope geometry needed for stability; noise wall and retaining wall foundation requirements; and the potential for short- and long-term settlement.

The designer requests a geotechnical report from the RME for retaining walls, noise walls, and reinforced slopes that are not part of the bridge preliminary plan. For walls that are part of the bridge preliminary plan, the HQ Bridge and Structures Office requests the geotechnical report for the walls from the HQ Geotechnical Office. (See [Chapter 730](#) for the detailed design process for retaining walls and reinforced slopes, [Chapter 740](#) for the detailed design process for noise walls, and the *Geotechnical Design Manual* for design requirements for all walls.) It is important that requests for a geotechnical report be made as early as possible in the design phase. The time required to obtain permits and rights of entry must be considered when establishing schedule requirements.

For retaining walls and reinforced slopes, the site data to be provided with the request for a geotechnical report are as given in [Chapter 730](#). Supply right of entry agreements and permits required for the geotechnical investigation. The site data given in [610.04\(4\)](#), as applicable, are provided for noise walls.

The RME or the HQ Geotechnical Office provides the information (see [Chapter 730](#) or [740](#) for specific responsibilities for design) specified in the *Geotechnical Design Manual* as part of the project geotechnical report.

The recommendations may also include the background regarding the analysis approach and any agreements with the region or other customers regarding the definition of acceptable level of risk. Additional details and design issues to be considered in the geotechnical report are as provided in [Chapter 730](#) for retaining walls and reinforced slopes and in [Chapter 740](#) for noise walls. The designer uses this information for final wall/reinforced slope selection and to complete the PS&E.

For final PS&E preparation, special provisions and plan details (if not received as part of the report provided during design) are developed with the assistance of the region Materials Laboratory or the HQ Geotechnical Office. Both the region Materials Laboratory and the HQ Geotechnical Office can review the contract plans before the PS&E review process begins, if requested. Otherwise, they will review the contract plans during the normal PS&E review process.

610.04(11) Unstable Slopes

Unstable slope mitigation includes the stabilization of known landslides and rockfall that occur on slopes adjacent to the WSDOT transportation system and that have been programmed under the P3 Unstable Slope Program.

610.04(11)(a) Project Definition

The region Project Office provides the RME with a description and location of the proposed unstable slope mitigation work. Location of the proposed work can be milepost limits or stationing. The designer meets at the project site with the RME and HQ Geotechnical Office to conduct a field review, discuss project requirements, and identify geotechnical issues associated with the unstable slope project. The RME requests that the HQ Geotechnical Office participate in the field review and Project Definition reporting.

620.01 General

620.02 Estimating Tables

620.01 General

Detailed criteria and methods that govern pavement design are in the Washington State Department of Transportation (WSDOT) Pavement Policy, which is available from the Pavements website: www.wsdot.wa.gov/business/materialslab/pavements/default.htm

The pavement design for all Design-Build project Request For Proposals (RFPs) will be conducted by the State Materials Lab, Pavement Division.

620.02 Estimating Tables

The tables in Exhibits 620-1 through 620-5h are for developing estimates of quantities for pavement sections, shoulder sections, stockpiles, asphalt distribution, and fog seal.

Exhibit 620-1 Estimating: Miscellaneous Tables

Unit Dry Weight – Gravel Base and Surfacing				
Type of Material	Truck Measure		Compacted on Roadway	
	lb/cy	T/cy	lb/cy	T/cy
Ballast	3,100	1.55	3,900	1.95
Crushed Surfacing Top Course	2,850	1.43	3,700	1.85
Crushed Surfacing Base Course	2,950	1.48	3,700	1.85
Screened Gravel Surfacing			3,700	1.85
*Gravel Base			3,400 – 3,800	1.70 – 1.90
Permeable Ballast			2,800	1.40
*3,700 lb/cy (1.85 tons/cy) is recommended as the most suitable factor; however, if the grading approaches the coarseness of ballast, the factor would approach 3,800 lb/cy (1.90 tons/cy), and if the grading contains more than 45% sand, the factor would decrease, approaching 3,400 lb/cy (1.70 tons/cy) for material that is essentially all sand.				

Notes:

- Weights shown are dry weights and corrections are required for water contents.
- The tabulated weights for the materials are reasonably close; however, apply corrections in the following order:

$$\text{For specific gravity: } \text{Wt.} = \frac{\text{tabular wt.} \times \text{specific gravity on surface report}}{2.65}$$

$$\text{For water content: } \text{Wt.} = \text{tabular wt.} \times (1 + \text{free water \% in decimals})$$

- If material is to be stockpiled, increase required quantities by 10% to allow for waste.
- Consider the inclusion of crushed surfacing top course material for keystone when estimating quantities for projects having ballast course.

Exhibit 620-2 Estimating: Hot Mix Asphalt Pavement and Asphalt Distribution Tables

Fog Seal						
Asphalt						
Application	Type of Emulsified Asphalt	Application gal* per sy	Tons* per sy	Tons/Mile Width (ft)		
				10	11	12
Fog Seal	CSS-1/CSS-1h	0.07	0.000292	1.7	1.9	2.1

*Quantities shown are retained (residual) asphalt.

Specific Data ^{[1][2]}														
Hot Mix Asphalt Paving Quantities (tons/mile)*														
Width (ft)	Depth of Pavement (ft)													
	0.10	0.15	0.20	0.25	0.30	0.35	0.40	0.45	0.50	0.55	0.60	0.65	0.70	0.75
4	161	241	321	402	482	563	643	723	804	884	964	1045	1125	1206
6	241	362	482	603	723	844	964	1085	1206	1326	1447	1567	1688	1808
8	321	482	643	804	964	1125	1286	1447	1607	1768	1929	2090	2250	2411
10	402	603	804	1005	1206	1407	1607	1808	2009	2210	2411	2612	2813	3014
11	442	663	884	1105	1326	1547	1768	1989	2210	2431	2652	2873	3094	3315
12	482	723	964	1206	1447	1688	1929	2170	2411	2652	2893	3135	3376	3617
22	884	1326	1768	2210	2652	3094	3536	3978	4421	4863	5305	5747	6189	6631
24	964	1447	1929	2411	2893	3376	3858	4340	4822	5305	5787	6269	6751	7234

*Based on 137 lbs/sy (0.0685 tons/sy) of 0.10 ft compacted depth = 2.05 tons/cy

Notes:

- [1] The specific gravity of the aggregate will affect the weight of aggregate in the completed mix.
- [2] Quantities shown do not provide for widening, waste from stockpile, or thickened edges.

Exhibit 620-3 Estimating: Bituminous Surface Treatment

Bituminous Surface Treatment ^[1]																
Type of Application	Average Application		Mineral Aggregate						Average Spread	Asphalt ^{[2][4]}						Basic ^[3] Asphalt Used
			10 ft		11 ft		12 ft			10 ft		11 ft		12 ft		
	lb/sy	cy/sy	T/mi	cy/mi	T/mi	cy/mi	T/mi	cy/mi	gal/sy	gal/mi	T/mi	gal/mi	T/mi	gal/mi	T/mi	
New Construction 3/4 inch – 1/2 inch																
First Application									0.50	2933	11.8	3227	13.0	3520	14.1	CRS-2P
Crushed Screenings 3/4 inch – 1/2 inch	35	0.0146	103	86	113	94	123	103								
Second Application									0.48	2787	11.2	3065	12.3	3344	13.4	CRS-2P
Crushed Screenings 1/2 inch – No. 4	32	0.0121	93	71	103	78	113	85								
Choke Stone No. 4 – 0	5	0.0017	15	10	16	11	18	12								
Totals	72	0.0284	211	167	232	183	254	200	0.98	5720	23.0	6292	25.3	6864	27.5	
New Construction 1/2 inch – No. 4																
First Application									0.50	2933	11.8	3227	13.0	3520	14.1	CRS-2P
Crushed Screenings 1/2 inch – No. 4	35	0.0132	102	77	113	85	123	93								
Second Application									0.48	2787	11.2	3065	12.3	3344	13.4	CRS-2P
Crushed Screenings 1/2 inch – No. 4	32	0.0121	93	71	103	78	113	85								
Choke Stone No. 4 – 0	5	0.0017	15	10	16	11	18	12								
Totals	72	0.0270	210	158	232	174	254	190	0.98	5720	23.0	6292	25.3	6864	27.5	
Seal Coats 5/8 inch – No. 4																
Seal Coat									0.53	3109	12.5	3420	13.7	3731	15.0	CRS-2P
Crushed Screenings 5/8 inch – No. 4	35	0.0130	102	76	113	84	124	92								
Choke Stone No. 4 – 0	5	0.0017	15	10	16	11	18	12								
Totals	40	0.0147	117	86	129	95	142	104	0.53	3109	12.5	3420	13.7	3731	15.0	

Table and notes continued on the next page.

Exhibit 620-3 Estimating: Bituminous Surface Treatment (continued)

Bituminous Surface Treatment ^[1]																
Type of Application	Average Application		Mineral Aggregate						Average Spread	Asphalt ^{[2][4]}						Basic ^[3] Asphalt Used
			10 ft		11 ft		12 ft			10 ft		11 ft		12 ft		
	lb/sy	cy/sy	T/mi	cy/mi	T/mi	cy/mi	T/mi	cy/mi	gal/sy	gal/mi	T/mi	gal/mi	T/mi	gal/mi	T/mi	
Seal Coats 1/2 inch – No. 4																
Seal Coat									0.45	2640	10.6	2904	11.7	3168	12.7	CRS-2P
Crushed Screenings 1/2 inch – No. 4	28	0.0106	81	62	89	68	97	74								
Choke Stone No. 4 – 0	5	0.0017	15	10	16	11	18	12								
Totals	33	0.0123	96	72	105	79	115	86	0.45	2640	10.6	2904	11.7	3168	12.7	
Seal Coats 3/8 inch – No. 4																
Seal Coat									0.45	2640	10.6	2904	11.7	3168	12.7	CRS-2P
Crushed Screenings 3/8 inch - No. 4	30	0.0106	88	62	96	68	106	75								
Choke Stone No. 4 – 0	5	0.0017	15	10	16	11	18	12								
Totals	35	0.0123	103	72	112	79	124	74	0.45	2640	10.6	2904	11.7	3168	12.7	

Notes:

- [1] Quantities shown do not provide for widening, waste from stockpile, or thickened edges.
- [2] Quantities of asphalt shown are based on 60°F temperature. Recompute to the application temperature for the particular grade.
- [3] The column “Basic Asphalt Used” is shown for the purpose of conversion to proper weights for the asphalt being used and does not imply that the particular grade shown is required for the respective treatment.
- [4] For stress-absorbing membrane (rubberized asphalt), increase asphalt by 25%.

Exhibit 620-4 Estimating: Base and Surfacing Typical Section Formulae and Example

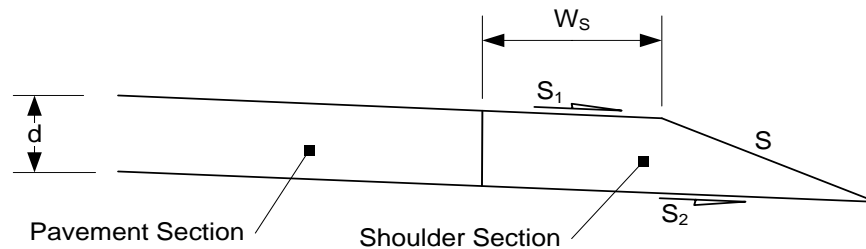

- W_s = Shoulder Width (Varies 4 ft, 6 ft, 8 ft, 10 ft, 12 ft)
 d = Depth of Section (Varies 0.05 ft to 2 ft)
 S = Side Slope (H:V) (Varies 2:1, 3:1, 4:1, and 6:1)
 S_1 = Top Shoulder Slope (Varies -0.02 ft/ft or -0.05 ft/ft)
 S_2 = Bottom Shoulder Slope (Varies -0.02 ft/ft or -0.05 ft/ft)

Formula for Shoulder Section		
Tons/mile = (A)(K)		$K = (5280/27)(1.85 \text{ tons/cy})$
$A = \frac{[d + W_s(1/S - S_1)]^2 S}{2(1 - SS_2)} - \frac{W_s^2}{2}(1/S - S_1)$		
Case 1	$S_1 = S_2 = -0.02 \text{ ft/ft}$	$A = \frac{[d + W_s(1/S - 0.02)]^2 S}{2(1 - 0.02S)} - \frac{W_s^2}{2}(1/S - 0.02)$
Case 2	$S_1 = -0.02 \text{ ft/ft}, S_2 = -0.05 \text{ ft/ft}$	$A = \frac{[d + W_s(1/S - 0.02)]^2 S}{2(1 - 0.05S)} - \frac{W_s^2}{2}(1/S - 0.02)$
Case 3	$S_1 = -0.05 \text{ ft/ft}, S_2 = -0.02 \text{ ft/ft}$	$A = \frac{[d + W_s(1/S - 0.05)]^2 S}{2(1 - 0.02S)} - \frac{W_s^2}{2}(1/S - 0.05)$ *
Case 4	$S_1 = S_2 = -0.05 \text{ ft/ft}$	$A = \frac{[d + W_s(1/S - 0.05)]^2 S}{2(1 - 0.05S)} - \frac{W_s^2}{2}(1/S - 0.05)$

*Limit: Positive Values of A only when $d = W_s(0.03)$

EXAMPLE: Shoulder Section

- Given:** Shoulder Width (W_s) = 8 ft
 Top Course = 0.25 ft
 Base Course = 0.80 ft
 Total Depth (d) = 1.05 ft
 Side Slope (S) = 3:1
 Shoulder Slope (S_1) = -0.05
 Subgrade Slope (S_2) = -0.02

 Depth 1.05 ft (Case 3) = 3,070 tons/mile
 Top Course 0.25 ft (Case 4) = 763 tons/mile
 Base Course = 2,307 tons/mile

 Top Course = 763 tons/mile
 Base Course = 2,307 tons/mile

Exhibit 620-5a Estimating: Base and Surfacing Quantities

Shoulder Section												
Shldr. Width W _s (ft)	Side Slope S:1	Case	Quantity in Tons Per Mile*									
			Surfacing Depth (ft)									
			0.05	0.10	0.15	0.20	0.25	0.30	0.35	0.40	0.45	0.50
4	2	1	73	148	226	304	385	468	553	639	728	818
		2	171	251	333	417	504	592	682	774	869	965
		3	N/A	N/A	131	205	281	360	440	522	605	691
		4	73	149	226	306	387	470	556	643	733	824
	3	1	74	150	230	313	398	486	577	671	768	868
		2	178	262	350	442	536	634	734	838	945	1056
		3	N/A	N/A	131	206	285	366	450	537	627	720
		4	74	151	231	315	402	492	585	681	780	883
	4	1	74	153	235	321	411	505	603	705	810	920
		2	185	275	370	469	572	681	793	910	1032	1158
		3	N/A	N/A	131	208	288	373	461	554	650	750
		4	75	154	237	326	418	516	617	724	834	950
	6	1	75	157	245	339	439	545	658	776	901	1032
		2	204	307	417	535	661	794	936	1085	1242	1406
		3	N/A	N/A	131	210	296	387	485	589	699	815
		4	76	160	252	351	459	574	696	827	965	1111
6	2	1	109	221	334	449	566	685	806	929	1053	1180
		2	325	444	565	688	812	939	1068	1199	1332	1467
		3	N/A	N/A	N/A	239	349	461	575	691	809	929
		4	110	221	335	450	568	687	809	933	1058	1186
	3	1	110	223	339	457	579	703	830	961	1094	1230
		2	338	462	590	722	856	994	1134	1278	1426	1576
		3	N/A	N/A	N/A	239	350	464	581	701	824	949
		4	110	223	340	460	583	709	838	970	1106	1245
	4	1	110	225	343	466	592	722	856	994	1136	1282
		2	352	483	619	760	905	1055	1209	1368	1531	1699
		3	N/A	N/A	N/A	239	351	467	587	711	839	971
		4	111	226	346	470	599	733	871	1013	1160	1311
	6	1	112	229	353	483	620	762	911	1066	1227	1394
		2	386	534	690	853	1025	1204	1391	1585	1788	1998
		3	N/A	N/A	N/A	239	353	474	600	733	871	1016
		4	112	233	360	496	640	791	950	1116	1291	1473
8	2	1	146	293	443	594	747	902	1059	1218	1379	1541
		2	526	683	843	1004	1167	1333	1500	1670	1841	2015
		3	N/A	N/A	N/A	N/A	376	522	670	820	972	1125
		4	146	293	443	595	749	904	1062	1222	1384	1548
	3	1	146	295	447	602	760	920	1084	1250	1419	1591
		2	546	711	879	1050	1224	1402	1583	1766	1954	2144
		3	N/A	N/A	N/A	N/A	376	523	673	825	981	1139
		4	146	296	448	604	763	926	1091	1260	1432	1607
	4	1	147	297	452	610	773	939	1109	1284	1462	1644
		2	568	741	919	1101	1288	1479	1675	1875	2080	2290
		3	N/A	N/A	N/A	N/A	376	524	675	831	990	1153
		4	147	298	454	615	780	950	1124	1302	1486	1673
	6	1	148	302	462	628	801	979	1164	1355	1552	1755
		2	622	816	1017	1226	1443	1668	1900	2140	2388	2643
		3	N/A	N/A	N/A	N/A	376	525	681	842	1009	1183
		4	149	305	469	641	820	1008	1203	1406	1616	1835

*Tabulated quantities are based on compacted weight of 1.85 tons/yd³

Exhibit 620-5b Estimating: Base and Surfacing Quantities

Shoulder Section												
Shldr. Width W _s (ft)	Side Slope S:1	Case	Quantity in Tons Per Mile*									
			Surfacing Depth (ft)									
			0.55	0.60	0.65	0.70	0.75	0.80	0.85	0.90	0.95	1.00
4	2	1	910	1004	1100	1198	1297	1399	1502	1608	1715	1824
		2	1063	1163	1266	1370	1476	1585	1695	1807	1922	2038
		3	779	868	960	1053	1148	1245	1344	1445	1548	1652
		4	918	1013	1110	1210	1311	1415	1520	1628	1738	1849
	3	1	971	1076	1185	1296	1410	1527	1647	1770	1896	2024
		2	1169	1286	1406	1529	1655	1785	1918	2053	2193	2335
		3	816	914	1016	1120	1228	1338	1451	1567	1686	1807
		4	989	1098	1210	1326	1444	1566	1691	1820	1951	2086
	4	1	1034	1151	1273	1398	1528	1661	1798	1939	2085	2234
		2	1289	1424	1564	1708	1857	2010	2168	2330	2497	2668
		3	855	963	1075	1191	1311	1435	1562	1694	1830	1969
		4	1070	1194	1323	1456	1594	1737	1884	2035	2191	2352
	6	1	1169	1312	1462	1617	1779	1947	2121	2301	2488	2680
		2	1579	1759	1947	2142	2346	2557	2776	3002	3237	3479
		3	937	1066	1200	1341	1488	1641	1800	1966	2138	2315
		4	1265	1426	1596	1773	1957	2150	2350	2558	2774	2998
6	2	1	1308	1438	1570	1704	1840	1978	2117	2259	2402	2548
		2	1603	1742	1883	2026	2171	2318	2467	2618	2771	2926
		3	1050	1174	1299	1426	1555	1686	1819	1954	2090	2229
		4	1315	1447	1581	1716	1854	1994	2135	2279	2425	2573
	3	1	1369	1510	1655	1802	1953	2106	2262	2421	2583	2748
		2	1729	1886	2046	2209	2376	2545	2718	2894	3073	3255
		3	1078	1209	1343	1480	1620	1763	1909	2058	2209	2363
		4	1387	1532	1681	1832	1987	2145	2306	2471	2638	2809
	4	1	1432	1586	1743	1905	2070	2240	2413	2591	2772	2957
		2	1871	2048	2229	2415	2606	2801	3000	3204	3412	3625
		3	1106	1246	1389	1537	1688	1843	2003	2166	2333	2504
		4	1467	1628	1793	1963	2137	2315	2499	2686	2878	3075
	6	1	1567	1746	1932	2124	2322	2526	2736	2953	3175	3404
		2	2215	2441	2674	2916	3164	3421	3685	3957	4237	4525
		3	1167	1325	1488	1658	1833	2015	2203	2398	2598	2805
		4	1663	1861	2066	2279	2500	2729	2965	3209	3461	3721
8	2	1	1706	1872	2040	2211	2383	2557	2732	2910	3090	3271
		2	2190	2367	2547	2728	2912	3097	3285	3475	3666	3860
		3	1281	1438	1597	1758	1921	2086	2253	2422	2592	2765
		4	1713	1881	2051	2223	2397	2573	2751	2930	3112	3296
	3	1	1766	1944	2125	2309	2495	2685	2877	3072	3271	3472
		2	2338	2534	2734	2937	3144	3353	3566	3782	4001	4223
		3	1300	1464	1631	1801	1974	2149	2328	2509	2693	2880
		4	1785	1966	2151	2339	2530	2724	2921	3122	3326	3533
	4	1	1830	2020	2214	2411	2613	2819	3028	3242	3459	3681
		2	2504	2722	2945	3172	3404	3641	3882	4128	4378	4632
		3	1320	1491	1666	1845	2028	2215	2405	2600	2799	3001
		4	1865	2062	2263	2469	2679	2894	3114	3337	3566	3799
	6	1	1965	2181	2402	2630	2864	3105	3351	3604	3863	4128
		2	2907	3178	3457	3743	4038	4340	4650	4967	5292	5626
		3	1363	1549	1741	1940	2144	2355	2572	2795	3024	3259
		4	2061	2295	2536	2786	3043	3308	3580	3861	4149	4445

*Tabulated quantities are based on compacted weight of 1.85 tons/yd³

Exhibit 620-5c Estimating: Base and Surfacing Quantities

Shoulder Section												
Shldr. Width W_s (ft)	Side Slope S:1	Case	Quantity in Tons Per Mile*									
			Surfacing Depth (ft)									
			0.05	0.10	0.15	0.20	0.25	0.30	0.35	0.40	0.45	0.50
10	2	1	182	366	551	739	928	1119	1312	1507	1704	1903
		2	773	969	1167	1367	1569	1773	1979	2187	2397	2609
		3	N/A	N/A	N/A	N/A	N/A	543	724	908	1094	1281
		4	182	366	552	740	930	1122	1315	1511	1709	1909
	3	1	182	368	556	747	941	1137	1337	1539	1745	1953
		2	802	1007	1215	1426	1640	1858	2079	2303	2530	2760
		3	N/A	N/A	N/A	N/A	N/A	543	725	910	1098	1289
		4	182	368	557	749	944	1143	1344	1549	1757	1968
	4	1	183	370	560	755	954	1156	1363	1573	1787	2006
		2	834	1049	1268	1492	1721	1954	2191	2433	2679	2930
		3	N/A	N/A	N/A	N/A	N/A	543	726	912	1103	1298
		4	183	371	563	760	961	1167	1377	1592	1811	2035
	6	1	184	374	570	773	982	1196	1417	1644	1878	2117
		2	913	1153	1399	1654	1916	2186	2464	2750	3043	3344
		3	N/A	N/A	N/A	N/A	N/A	543	727	917	1113	1316
		4	185	377	578	786	1001	1225	1456	1695	1942	2197
12	2	1	218	438	660	883	1109	1336	1566	1797	2030	2265
		2	1066	1301	1537	1776	2016	2259	2504	2750	2999	3249
		3	N/A	N/A	N/A	N/A	N/A	N/A	N/A	956	1175	1397
		4	218	438	660	884	1110	1339	1569	1801	2035	2271
	3	1	219	440	664	891	1121	1354	1590	1829	2071	2315
		2	1106	1351	1599	1850	2104	2362	2623	2887	3154	3424
		3	N/A	N/A	N/A	N/A	N/A	N/A	N/A	956	1177	1401
		4	219	441	666	894	1125	1360	1598	1839	2083	2330
	4	1	219	442	669	900	1134	1373	1616	1862	2113	2367
		2	1151	1407	1668	1933	2203	2478	2757	3040	3328	3621
		3	N/A	N/A	N/A	N/A	N/A	N/A	N/A	956	1179	1405
		4	219	443	672	904	1142	1384	1630	1881	2137	2397
	6	1	220	446	679	918	1162	1413	1671	1934	2203	2479
		2	1259	1544	1836	2136	2444	2759	3083	3414	3752	4099
		3	N/A	N/A	N/A	N/A	N/A	N/A	N/A	957	1182	1413
		4	221	450	686	930	1182	1442	1709	1985	2268	2558
Pavement Section												
Width W_p (ft)			0.05	0.10	0.15	0.20	0.25	0.30	0.35	0.40	0.45	0.50
11			199	398	597	796	995	1194	1393	1592	1791	1990
12			217	434	651	868	1085	1302	1519	1737	1954	2171
22			398	796	1194	1592	1990	2388	2786	3184	3582	3980
24			434	868	1302	1737	2171	2605	3039	3473	3907	4341

*Tabulated quantities are based on compacted weight of 1.85 tons/yd³

Exhibit 620-5d Estimating: Base and Surfacing Quantities

Shoulder Section												
Shldr. Width W _s (ft)	Side Slope S:1	Case	Quantity in Tons Per Mile*									
			Surfacing Depth (ft)									
			0.55	0.60	0.65	0.70	0.75	0.80	0.85	0.90	0.95	1.00
10	2	1	2104	2306	2511	2717	2925	3135	3347	3561	3777	3995
		2	2823	3039	3257	3477	3699	3923	4149	4378	4608	4840
		3	1471	1662	1855	2050	2247	2446	2646	2849	3053	3260
		4	2111	2315	2521	2729	2939	3151	3366	3582	3800	4020
	3	1	2164	2378	2595	2815	3038	3264	3492	3724	3958	4195
		2	2994	3230	3470	3714	3960	4209	4462	4718	4977	5239
		3	1483	1680	1880	2082	2288	2496	2707	2921	3138	3358
		4	2183	2401	2621	2845	3072	3303	3536	3773	4013	4256
	4	1	2228	2454	2684	2918	3156	3398	3643	3893	4147	4404
		2	3186	3446	3710	3980	4253	4531	4814	5101	5393	5689
		3	1496	1699	1905	2116	2330	2548	2770	2996	3227	3460
		4	2263	2496	2734	2976	3222	3473	3729	3989	4253	4522
	6	1	2363	2615	2873	3137	3407	3684	3966	4255	4550	4851
		2	3653	3969	4294	4626	4965	5313	5668	6031	6402	6781
		3	1524	1739	1960	2187	2420	2660	2906	3157	3415	3679
		4	2459	2729	3007	3292	3585	3887	4195	4512	4836	5168
12	2	1	2502	2740	2981	3224	3468	3714	3962	4212	4464	4718
		2	3502	3757	4013	4272	4533	4795	5060	5327	5596	5866
		3	1620	1845	2072	2301	2532	2765	2999	3236	3474	3714
		4	2509	2750	2992	3236	3482	3730	3981	4233	4487	4743
	3	1	2562	2813	3066	3322	3581	3843	4107	4375	4645	4919
		2	3698	3975	4255	4538	4824	5114	5406	5702	6001	6304
		3	1627	1857	2089	2324	2562	2803	3047	3294	3544	3796
		4	2581	2835	3092	3352	3615	3882	4151	4424	4700	4980
	4	1	2626	2888	3154	3424	3698	3976	4258	4544	4834	5128
		2	3918	4220	4526	4837	5152	5472	5796	6125	6458	6796
		3	1635	1869	2107	2348	2594	2844	3098	3355	3617	3882
		4	2661	2930	3204	3482	3765	4052	4344	4640	4941	5246
	6	1	2761	3049	3343	3643	3950	4262	4581	4906	5237	5575
		2	4453	4815	5185	5562	5948	6341	6742	7150	7566	7991
		3	1651	1894	2144	2400	2662	2930	3205	3485	3772	4065
		4	2857	3163	3477	3799	4128	4465	4810	5163	5524	5892
Pavement Section												
Width W _P (ft)	0.55	0.60	0.65	0.70	0.75	0.80	0.85	0.90	0.95	1.00		
11	2189	2388	2587	2786	2985	3184	3383	3582	3781	3980		
12	2388	2605	2822	3039	3256	3473	3690	3907	4124	4341		
22	4378	4775	5173	5571	5969	6367	6765	7163	7561	7959		
24	4775	5210	5644	6078	6512	6946	7380	7814	8249	8683		

*Tabulated quantities are based on compacted weight of 1.85 tons/yd³

Exhibit 620-5e Estimating: Base and Surfacing Quantities

Shoulder Section												
Shldr. Width W _s (ft)	Side Slope S:1	Case	Quantity in Tons Per Mile*									
			Surfacing Depth (ft)									
			1.05	1.10	1.15	1.20	1.25	1.30	1.35	1.40	1.45	1.50
4	2	1	1935	2048	2163	2279	2398	2518	2640	2765	2891	3019
		2	2157	2277	2399	2524	2650	2779	2909	3042	3176	3312
		3	1759	1867	1977	2089	2203	2319	2437	2557	2678	2802
		4	1963	2078	2196	2315	2437	2561	2686	2814	2943	3075
	3	1	2156	2290	2428	2568	2711	2857	3006	3157	3312	3470
		2	2480	2629	2781	2936	3094	3255	3420	3588	3759	3933
		3	1932	2059	2190	2323	2459	2598	2740	2885	3033	3183
		4	2223	2364	2509	2656	2806	2960	3117	3277	3441	3607
	4	1	2387	2543	2704	2869	3038	3210	3387	3567	3752	3940
		2	2844	3025	3210	3399	3593	3792	3995	4202	4415	4631
		3	2113	2260	2412	2567	2726	2890	3057	3228	3403	3582
		4	2517	2686	2860	3039	3222	3410	3602	3799	4000	4206
	6	1	2879	3084	3295	3513	3736	3966	4201	4443	4691	4946
		2	3729	3986	4252	4525	4806	5094	5391	5695	6007	6327
		3	2499	2689	2886	3088	3297	3512	3733	3960	4193	4433
		4	3229	3468	3715	3969	4232	4502	4779	5065	5358	5659
6	2	1	2695	2844	2995	3147	3302	3459	3617	3778	3940	4104
		2	3083	3242	3403	3566	3731	3898	4067	4238	4411	4586
		3	2369	2511	2655	2802	2949	3099	3251	3404	3560	3717
		4	2722	2874	3028	3184	3341	3501	3663	3827	3993	4160
	3	1	2916	3086	3260	3436	3615	3798	3983	4170	4361	4555
		2	3440	3629	3821	4016	4214	4416	4620	4828	5039	5253
		3	2521	2681	2844	3010	3179	3351	3525	3703	3883	4067
		4	2983	3160	3341	3524	3711	3901	4094	4290	4490	4692
	4	1	3146	3339	3536	3737	3942	4151	4364	4580	4801	5026
		2	3843	4065	4291	4523	4758	4998	5243	5492	5746	6004
		3	2679	2858	3041	3228	3418	3613	3812	4014	4221	4431
		4	3276	3482	3692	3907	4127	4350	4579	4812	5049	5291
	6	1	3639	3880	4127	4381	4640	4906	5178	5456	5741	6031
		2	4820	5123	5434	5753	6079	6413	6755	7105	7462	7827
		3	3017	3236	3461	3693	3930	4174	4423	4679	4941	5210
		4	3989	4264	4547	4837	5136	5442	5756	6078	6407	6745
8	2	1	3454	3640	3827	4016	4207	4399	4594	4791	4989	5189
		2	4055	4253	4452	4654	4858	5063	5271	5480	5692	5906
		3	2939	3115	3293	3473	3655	3839	4024	4212	4401	4592
		4	3482	3670	3860	4052	4246	4442	4640	4840	5042	5246
	3	1	3675	3882	4092	4304	4520	4738	4959	5183	5410	5640
		2	4449	4677	4909	5144	5382	5624	5869	6116	6367	6622
		3	3070	3263	3459	3658	3859	4064	4271	4481	4695	4911
		4	3743	3956	4173	4392	4615	4841	5071	5303	5539	5778
	4	1	3906	4135	4368	4606	4847	5092	5341	5593	5850	6111
		2	4891	5155	5423	5696	5973	6255	6541	6832	7127	7427
		3	3208	3418	3632	3851	4073	4299	4529	4763	5001	5243
		4	4036	4278	4524	4775	5031	5291	5556	5825	6098	6376
	6	1	4399	4676	4959	5249	5545	5847	6155	6469	6790	7116
		2	5966	6315	6671	7035	7407	7787	8174	8569	8972	9383
		3	3501	3749	4002	4262	4529	4801	5079	5364	5655	5952
		4	4748	5060	5379	5706	6040	6383	6733	7091	7456	7830

*Tabulated quantities are based on compacted weight of 1.85 tons/yd³

Exhibit 620-5f Estimating: Base and Surfacing Quantities

Shoulder Section												
Shldr. Width W _s (ft)	Side Slope S:1	Case	Quantity in Tons Per Mile*									
			Surfacing Depth (ft)									
			1.55	1.60	1.65	1.70	1.75	1.80	1.85	1.90	1.95	2.00
4	2	1	3148	3280	3414	3549	3687	3826	3967	4110	4255	4402
		2	3451	3591	3734	3878	4025	4173	4324	4477	4631	4788
		3	2927	3054	3183	3314	3447	3582	3718	3857	3997	4139
		4	3209	3344	3482	3622	3763	3907	4053	4201	4350	4502
	3	1	3630	3793	3959	4129	4300	4475	4653	4834	5017	5203
		2	4110	4291	4475	4662	4852	5045	5242	5441	5644	5850
		3	3337	3493	3652	3814	3979	4147	4318	4492	4668	4848
		4	3777	3950	4126	4305	4488	4673	4862	5054	5250	5448
	4	1	4133	4329	4529	4733	4941	5153	5369	5589	5812	6040
		2	4852	5078	5308	5543	5782	6026	6274	6527	6784	7046
		3	3764	3951	4142	4337	4535	4738	4944	5155	5369	5587
		4	4416	4631	4850	5074	5302	5535	5773	6015	6261	6512
	6	1	5206	5473	5745	6024	6310	6601	6898	7202	7512	7828
		2	6654	6989	7332	7683	8041	8407	8781	9163	9552	9950
		3	4678	4930	5188	5452	5722	5999	6282	6570	6865	7166
		4	5968	6285	6609	6941	7281	7628	7984	8347	8718	9096
6	2	1	4270	4438	4608	4779	4953	5128	5306	5485	5666	5849
		2	4763	4942	5123	5306	5491	5678	5868	6059	6252	6447
		3	3876	4038	4201	4365	4532	4701	4871	5044	5218	5394
		4	4330	4502	4676	4852	5030	5210	5391	5575	5761	5949
	3	1	4752	4951	5153	5359	5567	5778	5992	6208	6428	6651
		2	5471	5691	5915	6142	6372	6605	6842	7082	7325	7571
		3	4253	4442	4634	4829	5026	5227	5430	5637	5846	6058
		4	4898	5107	5320	5535	5754	5976	6201	6429	6660	6895
	4	1	5254	5486	5723	5963	6207	6455	6707	6963	7223	7487
		2	6267	6534	6806	7082	7363	7648	7938	8233	8532	8835
		3	4645	4864	5086	5312	5542	5776	6014	6256	6501	6751
		4	5537	5788	6044	6304	6569	6838	7111	7389	7672	7959
	6	1	6328	6630	6939	7254	7576	7903	8237	8577	8923	9275
		2	8200	8581	8969	9365	9769	10181	10600	11028	11463	11905
		3	5484	5765	6051	6344	6643	6949	7260	7578	7901	8231
		4	7090	7442	7803	8171	8547	8931	9322	9721	10128	10543
8	2	1	5391	5595	5801	6009	6219	6431	6644	6859	7077	7296
		2	6121	6339	6559	6780	7004	7230	7457	7687	7919	8153
		3	4785	4980	5177	5376	5577	5779	5984	6190	6398	6608
		4	5452	5660	5870	6082	6296	6512	6730	6950	7172	7396
	3	1	5873	6109	6347	6589	6833	7080	7330	7583	7839	8098
		2	6879	7140	7403	7670	7940	8214	8490	8770	9053	9339
		3	5129	5351	5576	5803	6034	6267	6503	6743	6985	7229
		4	6020	6265	6514	6765	7020	7278	7539	7804	8071	8342
	4	1	6376	6644	6917	7193	7473	7758	8046	8338	8634	8934
		2	7731	8040	8354	8671	8994	9321	9652	9988	10329	10674
		3	5488	5738	5992	6249	6511	6776	7046	7319	7596	7877
		4	6659	6946	7238	7534	7835	8140	8450	8764	9083	9406
	6	1	7449	7788	8133	8485	8842	9206	9575	9951	10333	10722
		2	9801	10227	10661	11103	11552	12009	12474	12947	13427	13915
		3	6255	6565	6880	7202	7530	7864	8204	8550	8903	9262
		4	8211	8600	8997	9401	9813	10233	10661	11096	11539	11990

*Tabulated quantities are based on compacted weight of 1.85 tons/yd³

Exhibit 620-5g Estimating: Base and Surfacing Quantities

Shoulder Section												
Shldr. Width W _s (ft)	Side Slope S:1	Case	Quantity in Tons Per Mile*									
			Surfacing Depth (ft)									
			1.05	1.10	1.15	1.20	1.25	1.30	1.35	1.40	1.45	1.50
10	2	1	4214	4436	4659	4884	5111	5340	5571	5804	6038	6275
		2	5074	5310	5548	5788	6031	6275	6521	6769	7019	7272
		3	3468	3678	3890	4104	4320	4537	4757	4978	5201	5427
		4	4242	4466	4692	4920	5150	5382	5617	5853	6091	6331
	3	1	4435	4678	4924	5173	5424	5679	5936	6196	6460	6726
		2	5505	5774	6045	6320	6599	6880	7165	7453	7744	8038
		3	3581	3806	4035	4266	4501	4738	4978	5221	5467	5715
		4	4503	4752	5005	5261	5520	5782	6048	6316	6588	6863
	4	1	4666	4931	5201	5474	5751	6032	6317	6606	6899	7196
		2	5990	6295	6605	6919	7238	7561	7889	8221	8558	8900
		3	3698	3940	4186	4436	4689	4947	5208	5474	5743	6017
		4	4796	5074	5357	5644	5935	6232	6532	6838	7147	7462
	6	1	5158	5472	5792	6117	6449	6787	7132	7482	7839	8202
		2	7167	7561	7963	8373	8790	9215	9648	10088	10537	10993
		3	3950	4226	4509	4798	5093	5394	5701	6015	6334	6660
		4	5508	5856	6211	6574	6945	7323	7710	8104	8506	8915
12	2	1	4974	5231	5491	5752	6015	6281	6548	6816	7087	7360
		2	6139	6414	6691	6969	7250	7533	7818	8104	8393	8684
		3	3956	4200	4446	4694	4944	5195	5449	5704	5961	6220
		4	5002	5262	5524	5788	6055	6323	6593	6866	7140	7416
	3	1	5195	5474	5756	6041	6329	6619	6913	7209	7509	7811
		2	6609	6918	7230	7545	7863	8184	8509	8837	9168	9502
		3	4052	4310	4571	4836	5103	5372	5645	5921	6199	6481
		4	5262	5548	5837	6129	6424	6723	7024	7329	7637	7948
	4	1	5425	5727	6033	6342	6656	6973	7294	7619	7948	8282
		2	7138	7485	7836	8192	8553	8917	9287	9661	10039	10422
		3	4151	4425	4702	4983	5268	5557	5850	6147	6448	6753
		4	5556	5870	6189	6512	6840	7172	7509	7851	8197	8547
	6	1	5918	6268	6624	6986	7354	7728	8109	8495	8888	9287
		2	8422	8862	9309	9764	10227	10698	11176	11662	12156	12657
		3	4364	4669	4981	5298	5622	5952	6288	6630	6979	7333
		4	6268	6652	7043	7442	7849	8264	8687	9117	9555	10001
Pavement Section												
Width W _P (ft)	1.05	1.10	1.15	1.20	1.25	1.30	1.35	1.40	1.45	1.50		
11	4179	4378	4576	4775	4974	5173	5372	5571	5770	5969		
12	4558	4775	4993	5210	5427	5644	5861	6078	6295	6512		
22	8357	8755	9153	9551	9949	10347	10745	11143	11541	11939		
24	9117	9551	9985	10419	10853	11287	11722	12156	12590	13024		

*Tabulated quantities are based on compacted weight of 1.85 tons/yd³

Exhibit 620-5h Estimating: Base and Surfacing Quantities

Shoulder Section												
Shldr. Width W _s (ft)	Side Slope S:1	Case	Quantity in Tons Per Mile*									
			Surfacing Depth (ft)									
			1.55	1.60	1.65	1.70	1.75	1.80	1.85	1.90	1.95	2.00
10	2	1	6513	6753	6995	7239	7485	7733	7983	8234	8488	8743
		2	7526	7782	8041	8301	8563	8827	9094	9362	9632	9905
		3	5654	5883	6113	6346	6581	6817	7056	7296	7538	7782
		4	6573	6818	7064	7312	7562	7814	8069	8325	8583	8843
	3	1	6995	7266	7541	7819	8099	8382	8669	8958	9250	9545
		2	8335	8636	8940	9247	9557	9870	10187	10506	10829	11156
		3	5967	6221	6479	6739	7002	7268	7537	7809	8084	8361
		4	7141	7423	7707	7995	8286	8581	8878	9179	9482	9789
	4	1	7497	7802	8111	8423	8740	9060	9385	9713	10045	10381
		2	9246	9596	9951	10311	10675	11043	11416	11794	12176	12563
		3	6294	6575	6860	7149	7442	7739	8040	8344	8653	8966
		4	7780	8104	8432	8764	9101	9442	9788	10139	10494	10853
	6	1	8571	8946	9327	9715	10108	10508	10914	11326	11744	12169
		2	11457	11928	12408	12895	13390	13892	14403	14921	15447	15980
		3	6992	7330	7674	8025	8382	8744	9113	9488	9870	10257
		4	9333	9758	10191	10631	11079	11536	11999	12471	12950	13437
12	2	1	7634	7911	8189	8469	8751	9035	9321	9609	9899	10190
		2	8977	9272	9569	9868	10168	10471	10776	11083	11392	11703
		3	6481	6744	7009	7276	7544	7814	8087	8361	8637	8915
		4	7695	7975	8258	8542	8828	9117	9407	9700	9994	10291
	3	1	8116	8424	8735	9049	9365	9685	10007	10333	10661	10992
		2	9840	10180	10524	10871	11221	11575	11931	12291	12654	13020
		3	6765	7052	7342	7635	7931	8230	8532	8836	9144	9454
		4	8263	8581	8901	9225	9553	9883	10216	10553	10893	11236
	4	1	8619	8960	9304	9653	10006	10363	10723	11088	11456	11829
		2	10810	11202	11599	12000	12405	12816	13230	13650	14073	14502
		3	7061	7374	7691	8011	8335	8664	8996	9332	9672	10017
		4	8902	9262	9626	9994	10367	10745	11127	11514	11905	12300
	6	1	9692	10103	10521	10945	11374	11810	12253	12701	13155	13616
		2	13167	13684	14209	14741	15282	15830	16386	16949	17521	18100
		3	7694	8061	8434	8813	9199	9590	9988	10392	10802	11218
		4	10454	10915	11384	11861	12346	12838	13338	13846	14361	14885
Pavement Section												
Width W _P (ft)			1.55	1.60	1.65	1.70	1.75	1.80	1.85	1.90	1.95	2.00
11			6168	6367	6566	6765	6964	7163	7362	7561	7760	7959
12			6729	6946	7163	7380	7597	7814	8031	8249	8466	8683
22			12337	12735	13133	13530	13928	14326	1472	14122	15520	15918
24			13458	13892	14326	14761	15195	15629	16063	16497	16931	17365

*Tabulated quantities are based on compacted weight of 1.85 tons/yd³

- 710.01 General
- 710.02 Required Data for All Structures
- 710.03 Additional Data for Waterway Crossings ([Bridges and Buried Structures](#))
- 710.04 Additional Data for Grade Separations
- 710.05 Additional Data for Widening
- 710.06 Documentation
- 710.07 References

710.01 General

The Washington State Department of Transportation (WSDOT) Headquarters (HQ) Bridge and Structures Office provides preliminary site data reviews to determine the applicability of, and requirements surrounding, proprietary structural solutions, or the need for specific structural design strategies, as well as structural design services to the regions. This chapter describes the information required by the HQ Bridge and Structures Office to perform these functions.

710.02 Required Data for All Structures

Structure site data provides information about the type of crossing, topography, type of structure, and potential future construction. Submit structure site data to the HQ Bridge and Structures Office for all structures meeting the [Chapter 720](#) definition of a bridge: essentially all structures of a span greater than 20 feet measured along the overcrossing alignment. This includes all buried structures such as precast concrete arch structures, reinforced concrete arch structures, precast reinforced concrete three-sided structures, precast reinforced concrete box culverts, and precast reinforced concrete split box culverts greater than a 20-foot span. Site data can also provide information on nonstandard retaining walls requiring project-specific design by the HQ Bridge and Structures Office.

Provide a cover memo that gives general information on the project, describes the attachments, and transmits the forms and data included in the submittal. Submit site data as a CAD file, supplemental drawings, and a report. (See [Exhibit 710-2](#) for items to include in a structure site data submittal). Direct any questions relating to the preparation of structure site data to the HQ Bridge and Structures Office. The [Bridge Design Manual](#) shows examples of required WSDOT forms.

710.02(1) Scour

At any location where a structure can be in contact with water (such as culvert outfall, lake, river, or floodplain), there is a risk of scour. This risk must be analyzed. Contact the HQ Geotechnical Office and the HQ Hydraulics Office to determine whether a scour analysis is required.

710.02(2) CAD Files and Supplemental Drawings

CAD files prepared for use as structure site data will be accepted in DGN (preferred) or DWG (acceptable) format.

Prepare plan, profile, and section drawings for all structures. Include copies of the CAD site data and supplemental drawings in the reduced plan sheet format with the submittal.

Use a complete and separate CAD file for each structure. Create the base map in 2D expanded level format only at 1:1 scale, with only one model per DGN or DWG file, and all base map levels in accordance with the *Plans Preparation Manual* Division 5. Create a separate base map in 3D with the alignment and contour lines only—no contour text. Turn on all levels (existing and proposed) and merge all reference files, leaving the reference file list empty. Put the new and existing alignments in the same file.

The *Bridge Design Manual* contains examples of completed bridge preliminary plans. These plans show examples of the line styles and drawing format for site data in CAD.

Structure site data is used to prepare the layout plan, which is to be used in the contract plans. Include the following information in the CAD files or in the supplemental drawings:

710.02(2)(a) Plan

- The drawing scales shown in [Exhibit 710-1](#) are for the full-sized contract plan format and are a guide only. Consider the width and general alignment of the structure when selecting the scale. For structures on curved alignments or where the structure width is nearly equal to or greater than the structure length, consult the HQ Bridge and Structures Office for an appropriate plan scale.

Exhibit 710-1 Structure Site Plan Scales

Length of Structure	Scale
20 ft to 100 ft	1"=10'
100 ft to 500 ft	1"=20'
500 ft to 800 ft	1"=30'
800 ft to 1,100 ft	1"=40'
More than 1,100 ft	1"=50'

- Vertical and horizontal datum control (see Chapters [400](#) and [410](#)).
- Contours of the existing ground surface (index and intermediate). Use intervals of 2 feet. Show contours beneath an existing or proposed structure and beneath the water surface of any waterway. Do not partially delete contour lines that cover index contour text.
- Alignment of the proposed highway and traffic channelization in the vicinity.
- Location by section, township, and range.
- Type, size, and location of all existing or proposed sewers, telephone and power lines, water lines, gas lines, traffic barriers, culverts, bridges, buildings, and walls.
- Location of right of way lines and easement lines.
- Distance and direction to nearest state highway intersections along the main alignment in each direction.
- Location of all roads, streets, and detours.
- Stage construction plan and alignment.
- Type, size, and location of all existing and proposed sign structures, light standards, and associated conduits and junction boxes. Provide proposed signing and lighting items when the information becomes available.

- Location of existing and proposed drainage.
- Horizontal curve data. Provide the Inroads report for each alignment. Include coordinates for all control points.

710.02(2)(b) Profile

- Profile view showing the grade line of the proposed or existing alignment and the existing ground line along the alignment line.
- Vertical curve data. Provide the Inroads report for each alignment along with the CAD detail.
- Superelevation transition diagram for each alignment as applicable.

710.02(2)(c) Section

- Channelization roadway sections on the structure and at structure approaches. Indicate the lane and shoulder widths, cross slopes and side slopes, ditch dimensions, and traffic barrier requirements.
- Stage construction roadway geometrics with the minimum lane and roadway widths specified.

710.02(3) Report

Submit DOT Form 235-002, Bridge Site Data-General. Supplement the CAD drawings with the following items:

- Vicinity maps
- Class of highway
- Design speed
- Special requirements for replacing or relocating utility facilities
- ADT and DHV counts
- Truck traffic percentage
- Requirements for road or street maintenance during construction

710.02(4) Video and Photographs

Submit a video of the site. Show all the general features of the site and details of existing structures. Scan the area slowly, spending extra time showing existing bridge pier details and end slopes. A “voice over” narrative on the video is necessary for orientation.

Color photographs of the structure site are desirable. Include detailed photographs of existing abutments, piers, end slopes, and other pertinent details for widenings, bridge replacements, or sites with existing structures.

710.03 Additional Data for Waterway Crossings (Bridges and Buried Structures)

Coordinate with the HQ Hydraulics Section and supplement the structure site data for all waterway crossings with the DOT Form 235-001, Bridge Site Data for Stream Crossings, and the following:

- Show riprap or other slope protection requirements at the structure site (type, plan limits, and cross section) as determined by the HQ Hydraulics Section.
- Show a profile of the waterway. The extent will be determined by the HQ Hydraulics Section.
- Show cross sections of the waterway, defining the bankfull width and the bank shelf widths and slopes. The extent will be determined by the HQ Hydraulics Section. The requirements for waterway profile and cross sections may be less stringent if the HQ Hydraulics Section has sufficient documentation (FEMA reports, for example) to make a determination. Contact the HQ Hydraulics Section to verify the extent of the information needed. Coordinate any rechannelization of the waterway with the HQ Hydraulics Section.

Many waterway crossings require a permit from the U.S. Coast Guard (see [Bridge Design Manual](#) Chapter 2.2.4 and the [Environmental Manual](#)). Generally, ocean tide-influenced waterways and waterways used for commercial navigation require a Coast Guard permit. These structures require the following additional information:

- Names and addresses of the landowners adjacent to the bridge site.
- Quantity of new embankment material within the floodway. This quantity denotes, in cubic yards, the material below and the material above normal high water.

Some waterways may qualify for an exemption from Coast Guard permit requirements if certain conditions are met (see the [Bridge Design Manual](#)). If the waterway crossing appears to satisfy these conditions, then submit a statement explaining why this project is exempt from a Coast Guard permit. Attach this exemption statement to the Environmental Classification Summary prepared for the project and submit it to the HQ Design Office for processing to the Federal Highway Administration (FHWA).

The region is responsible for coordination with the HQ Bridge and Structures Office, U.S. Army Corps of Engineers, and U.S. Coast Guard for waterways that may qualify for a permit exemption. The HQ Bridge and Structures Office is responsible for coordination with the U.S. Coast Guard for waterways that require a permit.

710.04 Additional Data for Grade Separations

710.04(1) Highway-Railroad Separation

Supplement structure site data for structures involving railroads with the following:

710.04(1)(a) Plan

- Alignment of all existing and proposed railroad tracks.
- Center-to-center spacing of all tracks.
- Angle, station, and coordinates of all intersections between the highway alignment and each track.
- Location of railroad right of way lines.
- Horizontal curve data. Include coordinates for all circular and spiral curve control points.

710.04(1)(b) Profile

- For proposed railroad tracks: profile, vertical curve, and superelevation data for each track.
- For existing railroad tracks: elevations accurate to 0.1 foot taken at 10-foot intervals along the top of the highest rail of each track. Provide elevations to 50 feet beyond the extreme outside limits of the existing or proposed structure. Tabulate elevations in a format acceptable to the HQ Bridge and Structures Office.

710.04(2) Highway-Highway Separation

Supplement structure site data for structures involving other highways by the following:

710.04(2)(a) Plan

- Alignment of all existing and proposed highways, streets, and roads.
- Angle, station, and coordinates of all intersections between all crossing alignments.
- Horizontal curve data. Include coordinates for all curve control points.

710.04(2)(b) Profile

- For proposed highways: profile, vertical curve, and superelevation data for each.
- For existing highways: elevations accurate to 0.1 foot taken at 10-foot intervals along the centerline or crown line and each edge of shoulder, for each alignment, to define the existing roadway cross slopes. Provide elevations to 50 feet beyond the extreme outside limits of the existing or proposed structure. Tabulate elevations in a format acceptable to the HQ Bridge and Structures Office.

710.04(2)(c) Section

- Roadway sections of each undercrossing roadway indicating the lane and shoulder widths, cross slopes and side slopes, ditch dimensions, and traffic barrier requirements.
- Falsework or construction opening requirements. Specify minimum vertical clearances, lane widths, and shy distances.

710.05 Additional Data for Widening

Bridge rehabilitations and modifications that require new substructure are defined as bridge widenings.

710.05(1) Bridge Widenings

Submit DOT Form 235-002A, Supplemental Bridge Site Data-Rehabilitation/ Modification. Supplement structure site data for structures involving bridge widenings by the following:

710.05(1)(a) Plan

- Stations for existing back of pavement seats, expansion joints, and pier centerlines based on field measurements along the survey line and each curb line.
- Locations of existing bridge drains. Indicate whether these drains are to remain in use or be plugged.

710.05(1)(b) Profile

- Elevations accurate to 0.1 foot taken at 10-foot intervals along the curb line of the side of the structure being widened. Pair these elevations with corresponding elevations (same station) taken along the crown line or an offset distance (10-foot minimum from the curb line). This information will be used to establish the cross slope of the existing bridge. Tabulate elevations in a format acceptable to the HQ Bridge and Structures Office.

Take these elevations at the level of the concrete roadway deck. For bridges with concrete overlay, elevations at the top of the overlay will be sufficient. For bridges with a nonstructural overlay, such as an asphalt concrete overlay, take elevations at the level of the concrete roadway deck. For skewed bridges, take elevations along the crown line or at an offset distance (10-foot minimum from the curb line) on the approach roadway for a sufficient distance to enable a cross slope to be established for the skewed corners of the bridge.

710.06 Documentation

Refer to [Chapter 300](#) for design documentation requirements.

710.07 References

Bridge Design Manual, M 23-50, WSDOT

Plans Preparation Manual, M 22-31, WSDOT

Exhibit 710-2 Structure Site Data Checklist**PLAN** (in CAD file)

- _____ Survey Lines and Station Ticks
- _____ Survey Line Intersection Angles
- _____ Survey Line Intersection Stations
- _____ Survey Line Bearings
- _____ Roadway and Median Widths
- _____ Lane and Shoulder Widths
- _____ Sidewalk Width
- _____ Connection/Widening for Traffic Barrier
- _____ Profile Grade and Pivot Point
- _____ Roadway Superelevation Rate (if constant)
- _____ Lane Taper and Channelization Data
- _____ Traffic Arrows
- _____ Mileage to Towns Along Main Line
- _____ Existing Drainage Structures
- _____ Existing Utilities: Type/Size/Location
- _____ New Utilities: Type/Size/Location
- _____ Light Standards, Junction Boxes, Conduits
- _____ Bridge-Mounted Signs and Supports
- _____ Contours
- _____ Bottom of Ditches
- _____ Test Holes (if available)
- _____ Riprap Limits
- _____ Stream Flow Arrow
- _____ R/W Lines and/or Easement Lines
- _____ Exist. Bridge No. (to be removed, widened)
- _____ Section, Township, Range
- _____ City or Town
- _____ North Arrow
- _____ SR Number
- _____ Scale

TABLES (in tabular format in CAD file)

- _____ Curb Line Elevations at Top of Existing Bridge Deck
- _____ Undercrossing Roadway Existing Elevations
- _____ Undercrossing Railroad Existing Elevations
- _____ Curve Data

OTHER SITE DATA (may be in CAD file or on supplemental sheets or drawings)

- _____ Superelevation Diagrams
- _____ End Slope Rate
- _____ Profile Grade Vertical Curves
- _____ Coast Guard Permit Status
- _____ Railroad Agreement Status
- _____ Highway Classification
- _____ Design Speed
- _____ ADT, DHV, and % Trucks

FORMS (information noted on the form or attached on supplemental sheets or drawings)

Bridge Site Data General

- _____ Slope Protection
- _____ Pedestrian Barrier/Pedestrian Rail Height Requirements
- _____ Construction/Falsework Openings
- _____ Stage Construction Channelization Plans
- _____ Bridge (before/with/after) Approach Fills
- _____ Datum
- _____ Video of Site
- _____ Photographs of Site
- _____ Control Section
- _____ Project Number
- _____ Region Number
- _____ Highway Section

Bridge Site Data for Stream Crossings

- _____ Water Surface Elevations and Flow Data
- _____ Riprap Cross Section Detail
- _____ Bankfull width
- _____ Bank shelf width

Supplemental Bridge Site Data: Rehabilitation/Modification

BRIDGE, CROSSROAD, AND APPROACH ROADWAY CROSS SECTIONS (may be in CAD file or on separate drawings)

- _____ Bridge Roadway Width
- _____ Lane and Shoulder Widths
- _____ Profile Grade and Pivot Point
- _____ Superelevation Rate
- _____ Survey Line
- _____ PB/Pedestrian Rail Dimensions
- _____ Stage Construction Lane Orientations
- _____ Locations of Temporary Barrier
- _____ Conduits/Utilities in Bridge
- _____ Location and Depth of Ditches
- _____ Shoulder Widening for Barrier
- _____ Side Slope Rate

- 720.01 General
- 720.02 Bridge Locations
- 720.03 Bridge Site Design Elements
- 720.04 Documentation
- 720.05 References

720.01 General

The National Bridge Inspection Standards (NBIS), published in the Code of Federal Regulations (23 CFR 650, Subpart C), defines a bridge as:

A structure including supports erected over a depression or an obstruction, such as water, highway, or railway, and having a track or passageway for carrying traffic or other moving loads, and having an opening measured along the center of the roadway of more than 20 feet between undercopings of abutments or spring lines of arches, or extreme ends of openings for multiple boxes; it may also include multiple pipes, where the clear distance between openings is less than half of the smaller contiguous opening.

The term “bridge” as used in this chapter applies to all structures conforming to the above definition. This includes all buried structures of a span greater than 20 feet measured along the overcrossing alignment, such as precast reinforced concrete three-sided structures, precast reinforced concrete box culverts, and precast reinforced concrete split box culverts.

Bridge design is the responsibility of the Washington State Department of Transportation (WSDOT) Headquarters (HQ) Bridge and Structures Office, which develops a preliminary bridge plan for a new or modified structure in collaboration with the region. This chapter provides basic design considerations for the development of this plan. Unique staging requirements, constructability issues, and other considerations are addressed during plan development. Contact the HQ Bridge and Structures Office early in the planning stage regarding issues that might affect the planned project (see [Chapter 700](#)). A Project File (PF) is required for all bridge construction projects.

720.02 Bridge Locations

Bridge locations are chosen to conform to the alignment of the highway. Conditions that can simplify design efforts, minimize construction activities, and reduce structure costs are:

- A perpendicular crossing.
- The minimum required horizontal and vertical clearances.
- A constant bridge width (without tapered sections).
- A tangential approach alignment of sufficient length not to require superelevation on the bridge.
- A crest vertical curve profile that will facilitate drainage.
- An adequate construction staging area.

720.03 Bridge Site Design Elements

720.03(1) Structural Capacity

The structural capacity of a bridge is a measure of the structure's ability to carry vehicle loads. For new bridges, the bridge designer chooses the design load that determines the structural capacity. For existing bridges, the structural capacity is calculated to determine the "load rating" of the bridge. The load rating is used to determine whether or not a bridge is "posted" for legal weight vehicles or "restricted" for overweight permit vehicles.

720.03(1)(a) New Structures

All new structures that carry vehicular loads are designed to HL-93 notional live load in accordance with AASHTO's LRFD Bridge Design Specifications.

720.03(1)(b) Existing Structures

When the structural capacity of a bridge will be affected by the project, request a Structural Capacity Report from the Risk Reduction Engineer in the HQ Bridge and Structures Office. Permanent redistribution of traffic, introduction of median barrier, and widening or deck rehabilitation are among the triggers for evaluation of a bridge's structural capacity. The report will state:

- The structural capacity status of the structures within the project limits.
- What action, if any, is appropriate.
- Whether a deficient bridge is included in the 6-year or 20-year plans for replacement or rehabilitation under the P2 program and, if so, in which biennium the P2 project is likely to be funded.

Include the Structural Capacity Report in the Design Documentation Package (DDP).

The considerations used to evaluate the structural capacity of a bridge are as follows:

1. On National Highway System (NHS) routes (including Interstate routes):
 - The operating load rating is at least 36 tons (which is equal to HS-20).
 - The bridge is not permanently posted for legal weight vehicles.
 - The bridge is not permanently restricted for vehicles requiring overweight permits.
2. On non-NHS routes:
 - The bridge is not permanently posted for legal weight vehicles.
 - The bridge is not permanently restricted for vehicles requiring overweight permits.

720.03(2) Bridge Widths for Structures

Refer to Chapters [1105](#), [1106](#), and [1230](#) for criteria and procedures relevant to determining design element widths for new and existing structures. All structures on city or county routes crossing over a state highway must conform to the [Local Agency Guidelines](#).

720.03(3) **Horizontal Clearance**

Horizontal clearance for structures is the distance from the edge of the traveled way to bridge piers and abutments, traffic barrier ends, or bridge end embankment slopes. Minimum distances for this clearance vary depending on the type of structure. (See Chapters 1600 and 1610 and the *Bridge Design Manual* for guidance on horizontal clearance.)

For structures involving railroads, contact the HQ Design Office Railroad Liaison.

720.03(4) **Bridge Medians**

Designs for bridges on divided multilane highways often include the decision to join parallel bridges as one or build them as independent structures. There are several factors in this decision, such as in new corridor construction, phased construction of corridors over time, and the general median width of the divided highway. This section covers some common design considerations related to bridge medians.

Chapter 1230 provides design criteria for medians. Chapter 1230 indicates that independent horizontal and vertical alignments are desirable on divided highways, particularly in rural settings.

Past Design Manual guidance on bridge medians stated a preference for joining two parallel structures as one, based on the distance between the structures. This guidance originated from a concern that errant vehicles may travel into the open space between two separate, parallel structures. Joining the two roadways on a single bridge and separating traffic with median barrier addressed this concern. Errant motorists occur on highways, and reducing the crash severity of these types of collision remains a priority for WSDOT. Advances in crash barriers and their applications have resulted in an expanded set of choices for bridge medians on divided highways.

Changed barrier designs and applications have allowed for longer runs of traffic barrier, different barrier types, and bullnose guardrail designs for shielding the gap between parallel structures. These tools have reduced collisions with abrupt bridge ends as well as shielded the opening between bridges.

WSDOT designers today encounter varying constraints, tradeoffs and existing contexts, along with limited project scopes and budgets. With fewer new corridors being constructed, many WSDOT projects are devoted to preservation of the mature highway system, leading to additional project considerations and tradeoffs.

Some highway corridors are initially planned as multilane divided highways but may be developed in logical, affordable phases and individual projects. This could result in an initial phase where a corridor may open as a two-lane rural highway used by both travel directions. A later phase could convert the facility to a divided highway, bringing with it the need for median separation. Consider the long-range plans when determining median widths for bridges. The photos in [Exhibit 720-1](#) show a completed multilane highway where two separate bridges were ultimately constructed years apart and a new corridor underway where one bridge is now built.

Joining two structures may not be the most cost-effective or sustainable solution for all projects. Coordinate with the Bridge and Structures Office and the local Maintenance Office when discussing options and concerns. For bridges on parallel horizontal and vertical alignments, practical considerations for joining two structures as one include, but are not limited to:

- Phased development where one structure exists and another is planned.
- Old and new structure types and compatibility (with phased corridor construction).
- Median width.
- Median barrier treatment options.
- Environmental contexts and regulations.
- Seismic conditions and load ratings.
- Bridge maintenance and inspection techniques: accessibility options and equipment for terrain in specific contexts. An open area between structures may be needed for bridge inspection.
- Economics.
- Historical/aesthetic value of existing bridges to remain in place.

Document this evaluation in the Design Documentation Package.

Exhibit 720-1 Phased Development of Multilane Divided Highways



720.03(5) Vertical Clearance

Vertical clearance is the critical height under a structure that will accommodate vehicular and rail traffic based on its design characteristics. This height is the least height available from the lower roadway surface (including usable shoulders) or the plane of the top of the rails to the bottom of the bridge. Usable shoulders are the design shoulders for the roadway and do not include paved widened areas that may exist under the structure.

In addition to the following vertical clearance guidance, consider whether the corridor experiences overheight loads. Consider a vertical clearance such that it will not create a new “low point” in the corridor.

720.03(5)(a) Vertical Falsework Clearance for Bridges Over Highways

Construction of new bridges and the reconstruction or widening of existing structures often requires the erection of falsework across the traveled way of a highway. The erection of this falsework can reduce the vertical clearance for vehicles to pass under the work area. The potential for collisions to occur by hitting this lower construction stage falsework is increased.

1. On all routes that require a 16-foot-6-inch vertical clearance, maintain the 16 foot-6-inch clearance for falsework vertical clearance.
 - On structures that currently have less than a 16-foot-6-inch vertical clearance for the falsework envelope, maintain existing clearance.
 - On new structures, maintain the falsework vertical clearance at least to those of the minimum vertical clearances referenced below.
2. Any variance from the above must be approved by the Regional Administrator or designee in writing and made a part of the Project File.

720.03(5)(b) Minimum Clearance for New Structures

For new structures, the minimum vertical clearances are as follows:

720.03(5)(b)(1) Bridge Over a Roadway

The minimum vertical clearance for a bridge over a roadway is 16.5 feet.

720.03(5)(b)(2) Bridge Over a Railroad Track

The minimum vertical clearance for a bridge over a railroad track is 23.5 feet (see [Exhibit 720-2](#)). A lesser clearance may be negotiated with the railroad company based on certain operational characteristics of the rail line; however, any clearance less than 22.5 feet requires the approval of the Washington State Utilities and Transportation Commission (WUTC) per [WAC 480-60](#). Vertical clearance is provided for the width of the railroad clearance envelope. Coordinate railroad clearance issues with the HQ Design Office Railroad Liaison.

720.03(5)(b)(3) Pedestrian Bridge Over a Roadway

The minimum vertical clearance for a pedestrian bridge over a roadway is 17.5 feet.

Exhibit 720-2 Highway Structure Over Railroad

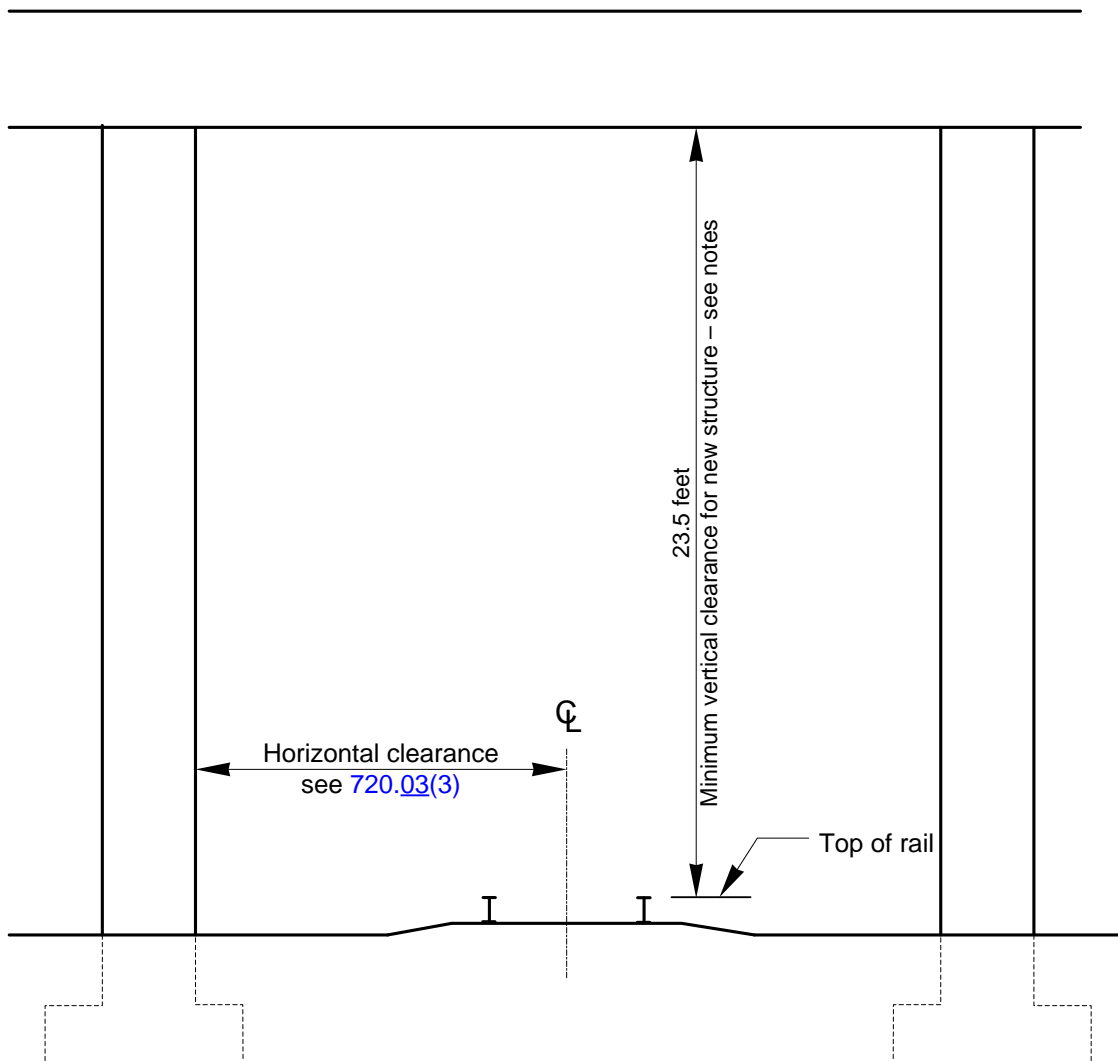
**Notes:**

- Use 22.5-foot vertical clearance for existing structures.
- Lesser vertical clearance may be negotiated (see [720.03\(5\)](#)).
- Increase horizontal clearance when the track is curved.
- Coordinate railroad clearance issues with the HQ Design Office Railroad Liaison.

720.03(5)(c) Minimum Clearance for Existing Structures

The criteria used to evaluate the vertical clearance for existing structures depend on the work being done on or under that structure. When evaluating an existing structure on the Interstate System, see [720.03\(5\)\(e\)](#), Coordination. This guidance applies to bridge clearances over state highways and under state highways at interchanges. For state highways over local roads and streets, city or county vertical clearance requirements may be used as minimum design criteria. (See [Exhibit 720-3](#) for bridge vertical clearances.)

720.03(5)(c)(1) Bridge Over a Roadway

For a project that will widen an existing structure over a highway or where the highway will be widened under an existing structure, the vertical clearance can be as little as 16.0 feet on the Interstate System or other freeways or 15.5 feet on nonfreeway routes. An approved deviation is required for clearance less than 16.0 feet on Interstate routes or other freeways and 15.5 feet on nonfreeway routes.

For a planned resurfacing of the highway under an existing bridge, if the clearance will be less than 16.0 feet on the Interstate System or other freeways and 15.5 feet on nonfreeway routes, evaluate the following options and include in a deviation request:

- Pavement removal and replacement
- Roadway excavation and reconstruction to lower the roadway profile
- Providing a new bridge with the required vertical clearance

Reducing roadway paving and surfacing thickness under the bridge to achieve the minimum vertical clearance can cause accelerated deterioration of the highway and is not recommended. Elimination of the planned resurfacing in the immediate area of the bridge might be a short-term solution if recommended by the Region Materials Engineer (RME). Solutions that include milling the existing surface followed by overlay or inlay must be approved by the RME to ensure adequate pavement structure is provided.

For other projects that include an existing bridge where no widening is proposed on or under the bridge, and the project does not affect vertical clearance, the clearance can be as little as 14.5 feet. For these projects, document the clearance in the Design Documentation Package. For an existing bridge with less than a 14.5-foot vertical clearance, an approved deviation request is required.

720.03(5)(c)(2) Bridge Over a Railroad Track

For an existing structure over a railroad track (see [Exhibit 720-2](#)), the vertical clearance can be as little as 22.5 feet. A lesser clearance can be used with the agreement of the railroad company and the approval of the Washington State Utilities and Transportation Commission. Coordinate railroad clearance issues with the HQ Design Office Railroad Liaison.

Exhibit 720-3 Bridge Vertical Clearances

Project Type	Vertical Clearance ^[8]	Documentation Requirement (see notes)
Interstate and Other Freeways^[1]		
New Bridge	> 16.5 ft	[2]
Widening Over or Under Existing Bridge	> 16 ft	[2]
	< 16 ft	[4]
Resurfacing Under Existing Bridge	> 16 ft	[2]
	< 16 ft	[4]
Other With No Change to Vertical Clearance	> 14.5 ft	[3]
	< 14.5 ft	[4]
Nonfreeway Routes		
New Bridge	> 16.5 ft	[2]
Widening Over or Under Existing Bridge	> 15.5 ft	[2]
	< 15.5 ft	[4]
Resurfacing Under Existing Bridge	> 15.5 ft	[2]
	< 15.5 ft	[4]
Other With No Change to Vertical Clearance	> 14.5 ft	[3]
	< 14.5 ft	[4]
Bridge Over Railroad Tracks^[7]		
New Bridge	> 23.5 ft	[2]
	< 23.5 ft	[4][5]
Existing Bridge	> 22.5 ft	[2]
	< 22.5 ft	[4][5]
Pedestrian Bridge Over Roadway		
New Bridge	> 17.5 ft	[2]
Existing Bridge	17.5 ft	[6]
Notes:		
[1] Applies to all bridge vertical clearances over highways and under highways at interchanges.		
[2] No documentation required.		
[3] Document to Design Documentation Package.		
[4] Approved deviation required.		
[5] Requires written agreement between railroad company and WSDOT and approval via petition from the WUTC.		
[6] Maintain 17.5-ft clearance.		
[7] Coordinate railroad clearance with the HQ Design Office Railroad Liaison.		
[8] See 720.03(5) .		

720.03(5)(d) Signing

Low-clearance warning signs are necessary when the vertical clearance of an existing bridge is less than 15 feet 3 inches. Refer to the [Manual on Uniform Traffic Control Devices](#) and the [Traffic Manual](#) for other requirements for low-clearance signing.

720.03(5)(e) Coordination

The Interstate System is used by the Department of Defense (DOD) for the conveyance of military traffic. The Military Traffic Management Command Transportation Engineering Agency (MTMCTEA) represents the DOD in public highway matters. The MTMCTEA has an inventory of vertical clearance deficiencies over the Interstate System in Washington State. Contact the MTMCTEA, through the Federal Highway Administration (FHWA), if either of the following changes is proposed to these bridges:

- A project would create a new deficiency of less than a 16.0-foot vertical clearance over an Interstate highway.
- The vertical clearance over the Interstate is already deficient (less than 16.0 feet) and a change (increase or decrease) to vertical clearance is proposed.

Coordination with MTMCTEA is required for these changes on all rural Interstate highways and for one Interstate route through each urban area.

720.03(6) Liquefaction Impact Considerations

To determine the amount of settlement and the potential for the soil to flow laterally during the design level earthquake due to liquefaction, an analysis performed by the HQ Geotechnical Office is needed for each bridge project site location. The information collected is used by bridge engineers to determine the bridge's capability to withstand the movement and loading in a seismic event and to explore other foundation mitigation options not necessitating total bridge replacement.

The HQ Bridge and Structures Office, in collaboration with the HQ Geotechnical Office, evaluates bridge-widening projects involving liquefiable soils and recommends appropriate liquefaction mitigation. The following guidance is intended to assist designers in making project decisions that balance project risks with project and program budget realities.

720.03(6)(a) Design Decision Considerations

The following design decision guidance is generally in order of the complexity of project decision making, starting with the most straightforward through the most complex.

1. New bridges will be designed to current seismic and liquefaction standards.
2. Bridge widening that does not require new substructure (a new column) does not require consideration of liquefaction mitigation.
3. Widening that involves any new substructure will require a settlement and lateral loading analysis by the HQ Bridge and Structures Office in collaboration with the HQ Geotechnical Office. Each analysis will be unique to the conditions at that particular bridge site.
 - a. If a bridge has less than 15 years of its service life remaining, no liquefaction mitigation is necessary according to FHWA guidelines.

- b. If the HQ Geotechnical Office analysis demonstrates that the differential settlement induced by liquefaction between the existing bridge and the widened portion will not create forces great enough to cause collapse of the existing bridge, and if lateral loading and movement caused by the liquefaction is minimal, liquefaction mitigation may not be necessary. The decision must be endorsed by the State Geotechnical Engineer, the State Bridge Engineer and the Regional Administrator. The decision and rationale are to be included in the Design Documentation Package.
- c. If the HQ Geotechnical Office analysis demonstrates that the differential settlement induced by liquefaction or the lateral loading and movement will be substantial and these movements will result in the collapse of the existing and widened portion of the bridge, additional analysis and documentation are necessary for the project to proceed. A preliminary design and estimate of the mitigation necessary to prevent collapse needs to be performed. Consider alternative designs that eliminate or reduce the need for the widening.

720.03(6)(b) Deferring Liquefaction Mitigation

720.03(6)(b)(1) Consideration of Deferment

If an alternative design concept is not feasible given the constraints of the project or program, consideration may be given to defer the liquefaction mitigation. Project-related structural retrofits that are deferred because of scope-related issues are to be considered for implementation through the WSDOT seismic retrofit program. The operating characteristics of the roadway and overall estimated cost of the liquefaction mitigation is typically considered in making that decision.

720.03(6)(b)(2) Deferment Requires Approval

A decision to defer the mitigation to the seismic retrofit program is made by the WSDOT Chief Engineer after reviewing and considering the alternatives. The decision is to be included in the Design Documentation Package (DDP). A memo from the Chief Engineer will be provided to the structural designer of record documenting the agency's decision to defer the mitigation work to the WSDOT seismic retrofit program. A copy of the memo is to be included in the DDP and the contract general notes.

720.03(7) Pedestrian and Bicycle Facilities

When pedestrians or bicyclists are anticipated on bridges, provide facilities consistent with guidance in Chapters 1510, 1515, and 1520. For instances where pedestrian users are not anticipated, evaluate the potential for stranded motorists to become pedestrians, where they may have exited their vehicle after a breakdown or other emergency. The infrequent and random nature of these occurrences makes it difficult to identify locations with even a moderate probability of pedestrian exposure.

Evolving programs and technologies such as incident response, personal cell phones, and ITS cameras have further reduced the probability of motorists becoming pedestrians. Investigate other methods of treatment such as pedestrian scale signing or other low-cost safety improvement measures. Document decisions in the DDP.

720.03(8) Bridge Approach Slab

Bridge approach slabs are reinforced concrete pavement installed across the full width of the bridge ends. They provide a stable transition from normal roadway cross section to the bridge ends, and they compensate for differential expansion and contraction of the bridge and the roadway.

Bridge approach slabs are provided on all new bridges. If an existing bridge is being widened and it has an approach slab, slabs are required on the widenings. The region, with the concurrence of the State Geotechnical Engineer and the State Bridge Design Engineer, may decide to omit bridge approach slabs. Document decisions in the DDP.

720.03(9) Traffic Barrier End Treatment

Plans for new bridge construction and bridge traffic barrier modifications include provisions for the connection of bridge traffic barriers to the longitudinal barrier approaching and departing the bridge. Indicate the preferred longitudinal barrier type and connection during the review of the bridge preliminary plan.

720.03(10) Bridge End Embankments

The design of embankment slopes at bridge ends depends on several factors. The width of the embankment is determined not only by the width of the roadway, but also by the presence of traffic barriers, curbs, and sidewalks, all of which create the need for additional widening. Examples of the additional widening required for these conditions are shown in the [Standard Plans](#).

The end slope is determined by combining the recommendations of several technical experts within WSDOT. [Exhibit 720-4](#) illustrates the factors taken into consideration and the experts involved in the process.

720.03(11) Bridge Slope Protection

Slope protection provides a protective and aesthetic surface for exposed slopes under bridges. Slope protection is normally provided under:

- Structures over state highways.
- Structures within an interchange.
- Structures over other public roads unless requested otherwise by the public agency.
- Railroad overcrossings if requested by the railroad.

Slope protection is usually not provided under pedestrian structures.

The type of slope protection is selected at the bridge preliminary plan stage. Typical slope protection types are concrete slope protection, and rubble stone.

720.03(12) Slope Protection at Water Crossings

The HQ Hydraulics Section determines the slope protection requirements for structures that cross waterways. The type, limits, and quantity of slope protection are shown on the bridge preliminary plan.

Exhibit 720-4 Embankment Slope at Bridge Ends

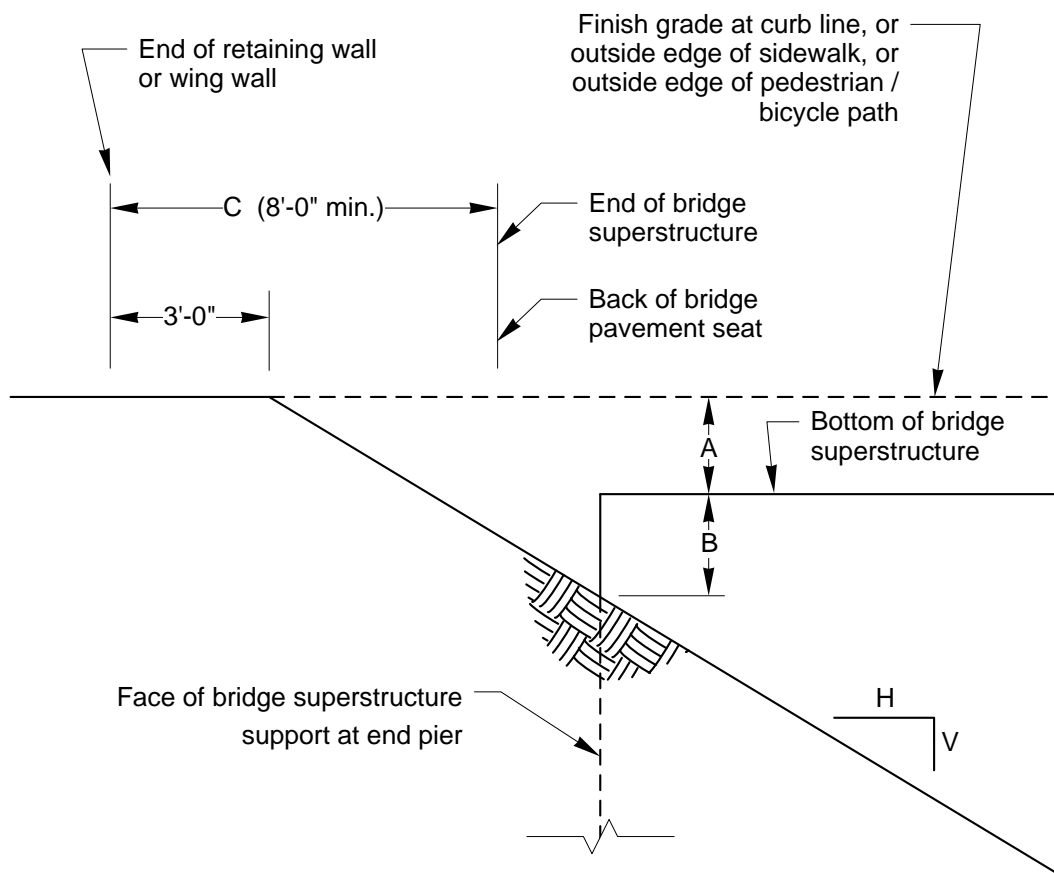
**Bridge End Elevation**

Applies to retaining wall or wing wall (or combination) extending beyond bridge superstructure (barrier omitted for clarity)

Legend

- A = Superstructure depth: recommended by HQ Bridge and Structures Office
- B = Vertical clearance from bottom of superstructure to embankment: recommended by Bridge Preservation Engineer
- C = Distance from end of retaining wall or wing wall to back of pavement seat: recommended by HQ Bridge and Structures Office
- H & V = Embankment slope: recommended by Geotechnical Engineer

720.03(13) Screening for Highway Structures

The Washington State Patrol (WSP) classifies the throwing of an object from a highway structure as an assault, not an accident or collision. Therefore, records of these assaults are not contained in WSDOT's crash databases. Contact the Region Traffic Engineer, RME's office and the WSP for the history of reported incidents.

Screening might reduce the number of incidents, but will not stop a determined individual at that location, or deter them from moving to other locations in the area. Enforcement provides the most effective deterrent and is typically the first approach used.

Installation of screening is analyzed on a case-by-case basis at the following locations:

- On existing structures where there is a history of multiple incidents of objects being dropped or thrown and where enforcement has not changed the situation.
- On new structures near schools, playgrounds, or areas frequently used by children not accompanied by adults.
- In urban areas on new structures used by pedestrians where surveillance by local law enforcement personnel is not likely.
- On new structures with walkways where experience on similar structures within a 1 mile radius indicates a need.
- On private property structures, such as buildings or power stations, subject to damage.

In most cases, the installation of a screen on a new structure can be postponed until there are indications of need.

Submit all proposals to install screening on structures to the Director & State Design Engineer, Development Division, for approval. Contact the HQ Bridge and Structures Office for approval to attach screening to structures and for specific design and mounting details.

720.04 Documentation

Refer to [Chapter 300](#) for design documentation requirements.

720.05 References

720.05(1) Federal/State Laws and Codes

23 CFR Part 650, Subpart C – National Bridge Inspection Standards

[Washington Administrative Code \(WAC\) 480-60](#), Railroad companies – Clearances

720.05(2) Design Guidance

[Bridge Design Manual LRFD](#), M 23-50, WSDOT

[Geotechnical Design Manual](#), M 46-03, WSDOT

[Local Agency Guidelines \(LAG\)](#), M 36-63, WSDOT

LRFD Bridge Design Specifications, 4th Edition, Washington DC, AASHTO, 2007

Manual on Uniform Traffic Control Devices for Streets and Highways, USDOT, FHWA; as adopted and modified by *Chapter 468-95 WAC* “Manual on uniform traffic control devices for streets and highways” (MUTCD)

Standard Plans for Road, Bridge, and Municipal Construction (Standard Plans), M 21-10, WSDOT

Standard Specifications for Road, Bridge, and Municipal Construction (Standard Specifications), M 41-10, WSDOT

Traffic Manual, M 51-02, WSDOT

720.05(3) Supporting Information

A Policy on Geometric Design of Highways and Streets (Green Book), AASHTO, current edition

Manual for Railway Engineering, American Railway Engineering and Maintenance-of-Way Association (AREMA)

needs to be considered in the design stage and reviewed by the region Materials Engineer during construction. The drainage features shown in the *Standard Plans* are the minimum basic requirements. Underdrains behind the wall/slope need to daylight at some point in order to adequately perform their drainage function. Provide positive drainage at periodic intervals to prevent entrapment of water.

Native soil may be used for retaining wall and reinforced slope backfill if it meets the requirements for the particular wall/slope system. In general, use backfill that is free-draining and granular in nature. Exceptions to this can be made depending on the site conditions as determined by the Geotechnical Office of the Headquarters (HQ) Materials Laboratory.

A typical drainage detail for a gravity wall (in particular, an MSE wall) is shown in [Exhibit 730-11](#). Include drainage details with a wall unless otherwise recommended to be deleted by the Region Materials Engineer or HQ Geotechnical Office.

(5) Aesthetics

Retaining walls and slopes can have a pleasing appearance that is compatible with the surrounding terrain and other structures in the vicinity. To the extent possible within functional requirements and cost-effectiveness criteria, this aesthetic goal is to be met for all visible retaining walls and reinforced slopes.

Aesthetic requirements include consideration of the wall face material, top profile, terminals, and surface finish (texture, color, and pattern). Where appropriate, provide planting areas and irrigation conduits. These will visually soften walls and blend them with adjacent areas. Avoid short sections of retaining wall or steep slope where possible.

In higher walls, variations in slope treatment are recommended for a pleasing appearance. High continuous walls are generally not desirable from an aesthetic standpoint, because they can be quite imposing. Consider stepping high or long retaining walls in areas of high visibility. Plantings may be considered between wall steps.

Approval by the State Bridge and Structures Architect is required on all retaining wall aesthetics, including finishes, materials, and configuration (see [Chapter 950](#)).

(6) Constructability

Consider the potential effect that site constraints might have on the constructability of the specific wall/slope. Constraints to be considered include but are not limited to site geometry, access, time required to construct the wall, environmental issues, and impact on traffic flow and other construction activities.

(7) Coordination With Other Design Elements

(a) Other Design Elements

Retaining wall and slope designs are to be coordinated with other elements of the project that might interfere with or impact the design or construction of the wall/slope. Also consider drainage features; utilities; luminaire or sign structures; adjacent retaining walls or bridges; concrete traffic barriers; and beam guardrails. Locate these design elements in a manner that will minimize the impacts to the wall elements. In general, locate obstructions within the wall backfill (such as

guardrail posts, drainage features, and minor structure foundations) a minimum of 3 feet from the back of the wall facing units.

Greater offset distances may be required depending on the size and nature of the interfering design element. If possible, locate these elements to miss reinforcement layers or other portions of the wall system. Conceptual details for accommodating concrete traffic barriers and beam guardrails are provided in [Exhibit 730-12](#).

Where impact to the wall elements is unavoidable, the wall system needs to be designed to accommodate these impacts. For example, it may be necessary to place drainage structures or guardrail posts in the reinforced backfill zone of MSE walls. This may require that holes be cut in the upper soil reinforcement layers or that discrete reinforcement strips be splayed around the obstruction. This causes additional load to be carried in the adjacent reinforcement layers due to the missing soil reinforcement or the distortion in the reinforcement layers.

The need for these other design elements and their impacts on the proposed wall systems are to be clearly indicated in the submitted wall site data so the walls can be properly designed. Contact the HQ Bridge and Structures Office (or the Geotechnical Office for geosynthetic walls/slopes and soil nail walls) for assistance regarding this issue.

(b) **Worker Fall Protection**

Department of Labor and Industries regulations require that, when employees are exposed to the possibility of falling from a location 4 feet or more above the roadway (or other lower area), the employer is to ensure fall restraint or fall arrest systems are provided, installed, and implemented.

Design fall protection in accordance with [WAC 296-155-24609](#) for walls that create a potential for a fall of 4 feet or more. During construction or other temporary or emergency condition, fall protection will follow [WAC 296-155](#). Any need for maintenance of the wall's surface or the area at the top can expose employees to a possible fall. If the area at the top will be open to the public, see [Chapter 1510, Pedestrian Facilities](#).

For maintenance of a tall wall's surface (10 feet or more), consider harness tie-offs if other protective means are not provided.

For maintenance of the area at the top of a tall wall, a fall restraint system is required when all of the following conditions will exist:

- A possible fall will be of 4 feet or more.
- Periodic maintenance will be performed on the area at the top.
- The area at the top is not open to the public.

Recommended fall restraint systems are:

- Wire rope railing with top and intermediate rails of ½-inch-diameter steel wire rope.
- Steel pipe railing with 1½-inch nominal outside diameter pipe as posts and top and intermediate rails.
- Concrete as an extension of the height of the retaining wall.

A fall restraint system is to be 42 inches high, plus or minus 3 inches, measured from the top of the finished grade, and capable of withstanding a 200 lb force from any direction, at the top, with minimal deflection. An intermediate cable or rail shall be halfway between the top rail and the platform. A toe board with a minimum height of 4 inches will be provided. Post spacing is no more than 8 feet on centers. (See the *Construction Manual* and *WAC 296-155* for fall arrest and protection information.) For wire rope railing, the top railing shall be flagged at not more than 6-foot intervals with high-visibility material.

The designer is to contact maintenance personnel regarding fall protection and debris removal considerations.

Contact the HQ Bridge and Structures Office for design details for any retrofit to an existing retaining wall and for any attachments to a new retaining wall.

730.05 Guidelines for Wall/Slope Selection

Wall/slope selection is dependent on:

- Whether the wall/slope will be located primarily in a cut or fill (how much excavation/shoring will be required to construct the wall or slope).
- If located in a cut, the type of soil/rock present.
- The need for space between the right of way line and the wall/slope or easement.
- The amount of settlement expected.
- The potential for deep failure surfaces to be present.
- The structural capacity of the wall/slope in terms of maximum allowable height.
- The nature of the wall/slope application.
- Whether or not structures or utilities will be located on or above the wall.
- Architectural requirements.
- Overall economy.

(1) *Cut and Fill Considerations*

Due to the construction technique and base width required, some wall types are best suited for cut situations, whereas others are best suited for fill situations. For example, anchored walls and soil nail walls have soil reinforcements drilled into the in-situ soil/rock and are therefore generally used in cut situations. Nongravity cantilevered walls are drilled or cut into the in-situ soil/rock, have narrow base widths, and are also well suited to cut situations. Both types of walls are constructed from the top down. Such walls are also used as temporary shoring to allow other types of walls or other structures to be constructed where considerable excavation will otherwise be required.

MSE walls and reinforced slopes, however, are constructed by placing soil reinforcement between layers of fill from the bottom up and are therefore best suited to fill situations. Furthermore, the base width of MSE walls is typically on the order of 70% of the wall height, which requires considerable excavation in a cut situation. Therefore, in a cut situation, base width requirements usually make MSE structures uneconomical and possibly unconstructible.

Semigravity (cantilever) walls, rigid gravity walls, and prefabricated modular gravity walls are free-standing structural systems built from the bottom up, but they do not rely on soil reinforcement techniques (placement of fill layers with soil reinforcement) to provide stability.

These types of walls generally have a narrower base width than MSE structures (on the order of 50% of the wall height). Both of these factors make these types of walls feasible in fill situations as well as many cut situations.

Reinforced slopes generally require more room overall to construct than a wall because of the sloping face, but they typically are a feasible alternative to a combination wall and fill slope to add a new lane. Reinforced slopes can also be adapted to the existing ground contours to minimize excavation requirements where fill is placed on an existing slope. Reinforced slopes might also be a feasible choice to repair slopes damaged by landslide activity or deep erosion.

Rockeries are best suited to cut situations as they require only a narrow base width, on the order of 30% of the rockery height. Rockeries can be used in fill situations, but the fill heights they support need to be kept relatively low. It is difficult to get the cohesive strength needed in granular fill soils to provide minimal stability of the soil behind the rockery at the steep slope typically used for rockeries in a cut (such as 1H:6V or 1H:4V).

The key considerations in deciding which walls or slopes are feasible are the amount of excavation or shoring required and the overall height. The site geometric constraints are defined to determine these elements. Another consideration is whether or not an easement will be required. For example, a temporary easement might be required for a wall in a fill situation to allow the contractor to work in front of the wall. For walls in cut situations, especially anchored walls and soil nail walls, a permanent easement may be required for the anchors or nails.

(2) Settlement and Deep Foundation Support Considerations

Settlement issues, especially differential settlement, are of primary concern in the selection of walls. Some wall types are inherently flexible and can tolerate a great deal of settlement without suffering structurally. Other wall types are inherently rigid and cannot tolerate much settlement. In general, MSE walls have the greatest flexibility and tolerance to settlement, followed by prefabricated modular gravity walls. Reinforced slopes are also inherently very flexible. For MSE walls, the facing type used can affect the ability of the wall to tolerate settlement. Welded wire and geosynthetic wall facings are the most flexible and the most tolerant to settlement, whereas concrete facings are less tolerant to settlement. In some cases, after the wall settlement is complete, concrete facing can be placed such that the concrete facing does not limit the wall's tolerance to settlement. Facing may also be added for aesthetic reasons.

Semigravity (cantilever) walls and rigid gravity walls have the least tolerance to settlement. In general, total settlement for these types of walls needs to be limited to approximately 1 inch or less. Rockeries also cannot tolerate much settlement, as rocks can shift and fall out. Therefore, semigravity cantilever walls, rigid gravity walls, and rockeries are not used in settlement prone areas.

If very weak soils are present that will not support the wall and are too deep to be overexcavated, or if a deep failure surface is present that results in inadequate slope stability, select a wall type capable of using deep foundation support and/or anchors. In general, MSE walls, prefabricated modular gravity walls, and some rigid gravity walls are not appropriate for these situations. Walls that can be pile-supported, such as concrete semigravity cantilever walls, nongravity cantilever walls, and anchored walls, are more appropriate for these situations.

- 1010.01 General
- 1010.02 References
- 1010.03 Definitions
- 1010.04 Work Zone Safety and Mobility
- 1010.05 Transportation Management Plans and Significant Projects
- 1010.06 Developing TMP Strategies
- 1010.07 Capacity Analysis
- 1010.08 Work Zone Design Standards
- 1010.09 Temporary Traffic Control Devices
- 1010.10 Positive Protection Devices
- 1010.11 Other Traffic Control Devices or Features
- 1010.12 Traffic Control Plan Development and PS&E
- 1010.13 Training and Resources
- 1010.14 Documentation

1010.01 General

Addressing work zone impacts to road users is an important component in the design of a project and needs to be given adequate consideration early in the design process. Most work zones create some level of traffic impacts and require additional safety features; therefore, all work areas and operations needed for construction must be identified and addressed during the project design. It is not acceptable to allow a project to move forward to advertisement without appropriately addressing work zone impacts, as the costs can account for up to 30% of the project cost. Planners, designers, construction engineers, maintenance personnel, and others all play a role in developing a comprehensive work zone design.

This chapter provides the designer with guidance to develop comprehensive work zone strategies and plans to address a project's safety, mobility, and constructability issues. A systematic process for addressing work zone impacts is required by federal regulations and state policy.

For the purposes of this chapter high speed means 45 mph and above.

1010.02 References

1010.02(1) Federal/State Laws and Codes

[23 Code of Federal Regulations \(CFR\) Part 630 Subpart J](#) – Work Zone Safety and Mobility

Americans with Disabilities Act of 1990 (ADA) (28 CFR Part 36, Appendix A, as revised July 1, 1994)

“Final Rule on Work Zone Safety and Mobility,” Federal Highway Administration (FHWA), Effective Date October 12, 2007

www.ops.fhwa.dot.gov/wz/resources/final_rule.htm

Manual on Uniform Traffic Control Devices for Streets and Highways, USDOT, FHWA; as adopted and modified by [Chapter 468-95 WAC](#) “Manual on uniform traffic control devices for streets and highways” (MUTCD)

1010.02(2) Design Guidance

A Policy on Geometric Design of Highways and Streets (Green Book), AASHTO

Accessible Rights-of-Way: A Design Guide, U.S. Access Board, Washington DC

🔗 <http://www.access-board.gov/guidelines-and-standards>

Americans with Disabilities Act and Architectural Barriers Act Accessibility Guidelines (ADAAG), July 23, 2004, U.S. Access Board

🔗 www.wbdg.org/ccb/astand/ada_aba.pdf

Executive Order E 1001, Work Zone Safety and Mobility

🔗 <http://wwwi.wsdot.wa.gov/publications/policies/fulltext/1001.pdf>

Executive Order E 1060, Speed Limit Reductions in Work Zones

🔗 <http://wwwi.wsdot.wa.gov/publications/policies/fulltext/1060.pdf>

Executive Order E 1033, WSDOT Employee Safety

🔗 <http://wwwi.wsdot.wa.gov/publications/policies/fulltext/1033.pdf>

Plans Preparation Manual, M 22-31, WSDOT

Standard Plans for Road, Bridge, and Municipal Construction (Standard Plans), M 21-10, WSDOT

Standard Specifications for Road, Bridge, and Municipal Construction (Standard Specifications), M 41-10, WSDOT

Traffic Manual, M 51-02, WSDOT

Work Zone Traffic Control Guidelines, M 54-44, WSDOT

1010.02(3) Supporting Information

Construction Manual, M 41-01, WSDOT

“Crashworthy Work Zone Traffic Control Devices,” Report 553, NCHRP, 2006

Environmental Manual, M 31-11, WSDOT

Highway Capacity Manual, 2010, TRB

ITE Temporary Traffic Control Device Handbook, 2001

ITS in Work Zones

🔗 www.ops.fhwa.dot.gov/wz/its/

“Recommended Procedures for the Safety Evaluation of Highway Features,” Report 350, NCHRP, 1993

Roadside Design Guide, AASHTO, 2011

Manual for Assessing Safety Hardware, AASHTO, 2009

Work Zone & Traffic Analysis, FHWA

🔗 www.ops.fhwa.dot.gov/wz/traffic_analysis.htm

Work Zone Operations Best Practices Guidebook, FHWA, 2007

🔗 www.ops.fhwa.dot.gov/wz/practices/practices.htm

Work Zone Safety and Mobility, FHWA

🔗 www.ops.fhwa.dot.gov/wz/index.asp

Work Zone Safety Web Page, WSDOT

🔗 www.wsdot.wa.gov/safety/workzones/

1020.01	General
1020.02	Design Components
1020.03	Overhead Installation
1020.04	State Highway Route Numbers
1020.05	Mileposts
1020.06	Guide Sign Plan
1020.07	Documentation
1020.08	References

1020.01 General

The Washington State Department of Transportation (WSDOT) uses signing as the primary mechanism for regulating, warning, and guiding traffic. Signing must be in place when any section of highway is open to the motoring public. Each highway project has unique and specific signing requirements. For statewide signing uniformity and continuity, it is sometimes necessary to provide signing beyond the project limits. Design characteristics of the facility determine the size and legend for a sign. As the design speed increases, larger sign sizes are necessary to provide adequate message comprehension time. The [MUTCD](#), the [Traffic Manual](#), and the [Sign Fabrication Manual](#) contain standard sign dimensions, specific legends, and reflective sheeting types for all new signs.

Guide signing provides the motorist with directional information to destinations. This information is always presented in a consistent manner. In some cases, there are specific laws, regulations, and policies governing the content of the messages on these signs. All proposed guide signs for a project require the approval of the region Traffic Engineer. The use of nonstandard signs is strongly discouraged and their use requires the approval of the State Traffic Engineer.

Apply the following criteria when determining whether to replace or modify existing signs:

- Current sign's service life is reached
- Lack of nighttime retroreflectivity
- Substantial damage, vandalism, or deterioration
- Replace signs with Type I sheeting
- Change in sign use policy
- Improper location
- Message or destination changes necessary to satisfy commitments to public or local agencies
- Substandard mounting height
- Change in jurisdiction (for example, a county road becomes a state route)

Address sign support breakaway features in accordance with [Chapter 1600](#).

1020.02 Design Components

1020.02(1) Location

The [MUTCD](#) contains the guidelines for positioning signs. Check sign locations to ensure the motorist's view of the sign is not obscured by other roadside appurtenances. Also, determine whether the proposed sign will obstruct the view of other signs or limit the motorist's sight distance of the roadway. Reposition existing signs, when necessary, to satisfy these visibility requirements. Where possible, locate signs behind existing traffic barriers, on grade separation structures, or where terrain features will minimize their exposure to errant vehicles.

1020.02(2) Longitudinal Placement

The [MUTCD](#) and the [Traffic Manual](#) provide guidelines for the longitudinal placement of signs that are dependent on the type of sign. Select a location to fit the existing conditions to provide for visibility and adequate response time. In most cases, signs can be shifted longitudinally to enhance safety without compromising their intended purpose.

1020.02(3) Lateral Clearance

The [Standard Plans](#) and the [MUTCD](#) contain minimum requirements for the lateral placement of signs. Where possible, position the signs at the maximum feasible lateral clearance for safety and reduced maintenance costs. Locate large guide signs and motorist information signs beyond the Design Clear Zone (see [Chapter 1600](#)) where limited right of way or other physical constraints are not a factor. On steep fill slopes, an errant vehicle is likely to be partially airborne from the slope break near the edge of shoulder to a point 12 feet down the slope. When signs are placed on fill slopes steeper than 6H:1V, locate the support at least 12 feet beyond the slope break.

Use breakaway sign support features, when required, for signs located within the Design Clear Zone and for signs located beyond this zone where there is a possibility they might be struck by an errant vehicle. Breakaway features are not necessary on signposts located behind traffic barriers. Install longitudinal barriers to shield signs without breakaway features within the Design Clear Zone when no other options are available.

Sign bridges and cantilever sign structures have limited span lengths. Locate the vertical components of these structures as far from the traveled way as possible and, where appropriate, install traffic barriers (see [Chapter 1610](#)).

Do not locate signposts in the bottom of a ditch or where the posts will straddle the ditch. The preferred location is beyond the ditch or on the ditch backslope (see the [Standard Plans](#)). In high-fill areas where conditions require placement of a sign behind a traffic barrier, consider adding embankment material to reduce the length of the sign supports.

1020.02(4) Sign Heights

For ground-mounted signs installed at the side of the road, provide a mounting height of at least 7 feet, measured from the bottom of the sign to the edge of traveled way. Supplemental plaques, when used, are mounted directly below the primary sign. At these locations, the minimum mounting height of the plaque is 5 feet.

Do not attach supplemental guide signs to the posts below the hinge mechanism or the saw cut notch on multiple-post installations. The location of these hinges or saw cuts on the sign supports are shown in the [Standard Plans](#).

A minimum 7-foot vertical height from the bottom of the sign to the ground directly below the sign is necessary for the breakaway features of the sign support to function properly when struck by a vehicle. The minimum mounting height for new signs located behind longitudinal barriers is 7 feet, measured from the bottom of the sign to the edge of traveled way. A lower mounting height of 5 feet may be used when replacing a sign panel on an existing sign assembly located behind the longitudinal barrier. The [Standard Plans](#) shows typical sign installations.

For ground-mounted signs installed on multiple posts that are a minimum of

12 feet from the edge of traveled way in cut sections, the minimum height clearance between the sign and the ground for the post farther from the edge of traveled way is as follows:

- For slopes 2H:1V and steeper, the minimum height clearance is 2 feet.
- For slopes 3H:1V or flatter, the minimum height clearance is 7 feet.

Signs used to reserve parking for people with disabilities are installed at each designated parking stall and are mounted 7 feet above the surface at the sign location.

1020.02(5) Foundations

Foundation details for timber and steel ground-mounted sign supports are shown in the [Standard Plans](#), which also contains foundation designs for truss-type sign bridges and cantilever sign structures. Three designs, Types 1, 2, and 3, are shown for each structure.

An investigation of the foundation material is necessary to determine the appropriate foundation design. Use the data obtained from the geotechnical report to select the foundation type.

- The **Type 1** foundation design uses a large concrete shaft and is the preferred installation when the lateral bearing pressure of the soil is 2,500 psf or greater.
- The **Type 2** foundation design has a large rectangular footing design and is an alternative to the Type 1 foundation when the concrete shaft is not suitable.
- The **Type 3** foundation design is used in poorer soil conditions where the lateral bearing pressure of the soil is between 1,500 psf and 2,500 psf.

If a nonstandard foundation or monotube structure design is planned, forward the report to the Headquarters (HQ) Bridge and Structures Office for use in developing a suitable foundation design (see [Chapter 610](#)).

1020.02(6) Signposts

Ground-mounted signs are installed on either timber posts, laminated wood box posts, or steel posts. The size and number of posts required for a sign installation are based on the height and surface area of the sign, or signs, being supported. Use the information in Exhibits [1020-2](#), [1020-3](#), and [1020-4](#) and the [Standard Plans](#) to determine the posts required for each installation. Coordinate with the region Maintenance Office concerning signpost installation.

Use steel posts with breakaway supports that are multidirectional if the support is likely to be hit from more than one direction. For any wide flange multiple-steel post installations located within the Design Clear Zone, the total weight of all the posts in a 7-foot-wide path is not to exceed a combined post weight of 34 lbs/foot. Use the Wide Flange Beam Weights table in [Exhibit 1020-3](#) to determine wide flange steel post weights. If the proposed sign configuration does not meet the weight criterion, relocate, resize, or provide barrier protection for the proposed installation.

All signposts are to be designed to 90 mph wind loads. Design features of breakaway supports are shown in the [Standard Plans](#). Steel signposts commonly used are: Perforated Square Steel Tube (PSST); Square Steel Tube (SST); Round Pipe (RP); and Wide Flange "H-Beam." Steel posts with Type TP-A, TP-B, PL, PL-T, PL-U, AS, AP, SB-1, and SB-2 bases have multidirectional breakaway features.

1020.03 Overhead Installation

Guidance on the use of overhead sign installations is provided in the [MUTCD](#). Where possible, mount overhead signs on grade separation structures rather than sign bridges or cantilever supports.

Details for the construction of truss-type sign bridges and cantilever sign supports are shown in the [Standard Plans](#).

The HQ Bridge and Structures Office designs structure-mounted sign mountings, monotube sign bridges, and monotube cantilever sign supports. For overhead sign installation designs, provide sign dimensions, horizontal location in relation to the roadway, and location of the lighting fixtures to facilitate design of the mounting components by the HQ Bridge and Structures Office.

1020.03(1) Illumination

The retroreflectivity of currently approved sign sheeting removes the need to provide illumination for most sign installations.

The sign lights for existing illuminated overhead and ground-mounted signs can only be de-energized and removed if the retroreflective sheeting is adequate for nighttime legibility, or replace the existing sign with a new sign (see [Exhibit 1020-1](#) for sheeting requirements).

A nighttime assessment of all nonilluminated overhead signs within the project limits is required. Replace all signs that have inadequate retroreflectivity (contact the region Traffic Office). In situations where a nonhighway light source interferes with a sign's legibility, consider relocating the sign or providing sign lights.

Flashing beacon signs are used to alert motorists of unusual or unexpected driving conditions ahead. Sign lights are unnecessary on flashing beacon signs when appropriate sign sheeting, full circle or tunnel signal head visors, and automatic dimmer devices are used.

Exhibit 1020-1 Reflective Sheeting Requirements for Overhead Signs

Overhead Sign Type	Sheeting Type (Background)	Sheeting Type (Legend & Border)
EXIT ONLY guide sign	IV*	XI
Guide signs for left side exits	IV	XI
Other guide signs	IV	XI
Overhead street name signs	IV	XI
Regulatory signs	IV	n/a
Warning signs	IX or XI	n/a
*For Yellow Background Sheeting, use Type IX or XI Fluorescent Sheeting.		

All other overhead signs are illuminated only when one of the following conditions is present:

- Sign visibility is less than 800 feet due to intervening sight obstructions such as highway structures or roadside features.
- Signs directly adjacent to other overhead signs have sign lights.

1020.03(2) Vertical Clearance

The minimum vertical clearance from the roadway surface to the lowest point of an overhead sign assembly is 17 feet 6 inches. The minimum vertical clearance from the roadway surface to the lowest point of an overhead sign assembly without sign light(s) is 19 feet 6 inches. The maximum clearance is 21 feet. Contact the HQ Traffic Office regarding signs under bridges and in tunnels.

1020.03(3) Horizontal Placement

Consider roadway geometrics and anticipated traffic characteristics when locating signs above the lane(s) to which they apply. Install advance guide signs/exit direction signs that require an EXIT ONLY and “down arrow” panel directly above the drop lanes. To reduce driver confusion about which lane is being dropped, avoid locating a sign with an EXIT ONLY panel on a horizontal curve.

1020.03(4) Service Walkways

Walkways are provided on structure-mounted signs, truss-type sign bridges, and truss-type cantilever sign supports where roadway and traffic conditions prohibit normal sign maintenance activities. Monotube sign bridges/cantilever sign supports normally do not have service walkways.

Vandalism of signs, particularly in the form of graffiti, can be a major problem in some areas. Vandals sometimes use the service walkways and vandalize the signs. Maintenance costs for cleaning or replacing the vandalized signs at these locations can exceed the benefit of providing the service walkway.

1020.04 State Highway Route Numbers

For state routes, [RCW 47.36.095](#) authorizes WSDOT to sign state highways using a system of state route numbers assigned to eliminate duplication of numbers. This numbering system follows the system employed by the federal government in the assignment of Interstate and U.S. routes: odd numbers indicate general north-south routes and even numbers indicate general east-west routes.

1020.05 Mileposts

Milepost markers are a part of a statewide system for all state highways and are installed in accordance with [Executive Order E 1064](#), “State Route Mileposts,” and Chapter 2 of the [Traffic Manual](#).

1020.06 Guide Sign Plan

A preliminary guide sign plan is developed to identify existing and proposed guide signing on state highways and is reviewed by the region Traffic Engineer. Preliminary guide signs for Interstate routes are to be furnished to the HQ Traffic Office for review and concurrence. The plan provides an easily understood graphic representation of the signing and its continuity to motorist destinations, activities, and services. It is also used to identify deficiencies or poorly defined routes of travel. A guide sign plan for safety and mobility Improvement projects is desirable. When proposed highway work affects signing to a city or town, the guide sign plan can be furnished to the official governing body for review and consideration. The guide sign plan is reviewed and approved by the region Traffic Engineer.

1020.07 Documentation

Refer to [Chapter 300](#) for design documentation requirements.

1020.08 References

1020.08(1) *Federal/State Laws and Codes*

[23 Code of Federal Regulations \(CFR\) 655](#), Traffic Operations

WSDOT [Executive Order E 1064](#), “State Route Mileposts,” WSDOT

[Revised Code of Washington \(RCW\) 47.36](#), Traffic control devices

1020.08(2) *Design Guidance*

[Manual on Uniform Traffic Control Devices for Streets and Highways](#) (MUTCD), 2003 Edition, FHWA, 2003, including the Washington State Modifications to the MUTCD, M 24-01, 2003

[Plans Preparation Manual](#), M 22-31, WSDOT

[Sign Fabrication Manual](#), M 55-05, WSDOT

[Standard Plans for Road, Bridge, and Municipal Construction](#) (*Standard Plans*), M 21-01, WSDOT

[Standard Specifications for Road, Bridge, and Municipal Construction](#) (*Standard Specifications*), M 41-10, WSDOT

[Standard Specifications for Structural Supports for Highway Signs, Luminaires, and Traffic Signals](#), 4th Edition, Washington DC, AASHTO, 2001

[Traffic Manual](#), M 51-02, WSDOT

Exhibit 1020-2 Timber Posts

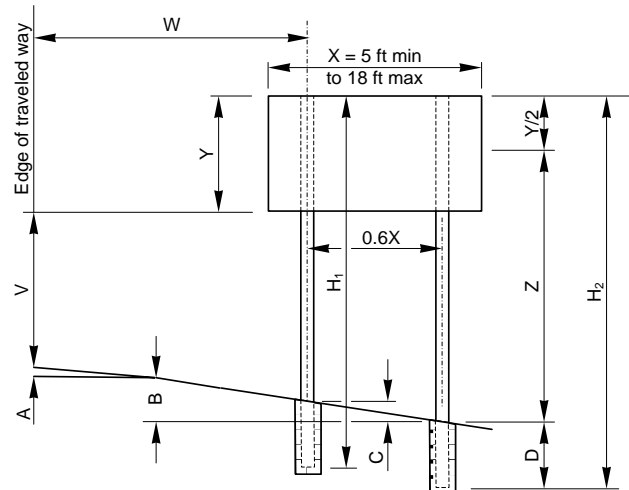
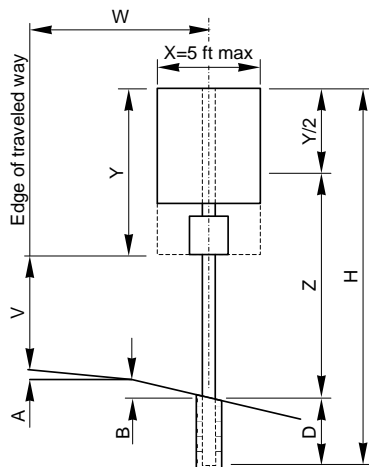

Notes:

The following designs are *not permitted* when a sign is to be located in or outside the Design Clear Zone in an area where it is likely to be struck by an errant vehicle:

1. A sign with any post larger than 6x8 inches.
2. A 2-post, 3-post, or 4-post sign that uses 6x6-inch or larger posts and has two posts spaced less than 7 ft apart on center.

Table 1 Timber Post Selection

Post Size (in)	(X)(Y)(Z) (ft ³)				D (ft)
	Number of Posts				
	1	2	3	4	
4 x 4	60	115	175	235	3
4 x 6	125	335	500	675	4
6 x 6	200	415	620	815	4
6 x 8	330	695	1150	1515	5
6 x 10	670	1355	2030	2700	6
8 x 10	835	1685	2515	3360	6
6 x 12	985	2005	2965	3945	7

Values shown are the maximum permitted.

For timber grade requirements, see the [Standard Specifications](#).

Foundation depths are based on allowable lateral bearing pressure in excess of 2500 psf.

If the value (X)(Y)(Z) amount exceeds the limit for 6x12 post(s), use steel post(s) for sign installation.

A = Vertical distance from edge of traveled way to edge of shoulder

B = Vertical distance from slope catch point to centerline of longest post

C = Vertical distance between adjacent posts

X & Y = Single sign or back-to-back signs: Overall dimensions of the sign

Multiple signs: Dimensions of the area within the perimeter of a rectangle enclosing the extremities of the sign

Z = Height from ground line to midheight of sign at the centerline of the longest post

D = Embedment depth

H = Total post height

V = Vertical clearance from edge of traveled way

W = Distance from edge of traveled way to the centerline of the post nearest the roadway

Design Example – Single Post

Given:

Sign 3 ft wide, 3.5 ft high; a secondary sign 1.5 ft wide, 2 ft high, mounted 3 inches (0.25 ft) below; 8-ft shoulder with 2% slope; 6H:1V embankment; W = 15 ft; V = 5 ft

Solution:

X = 3 ft

Y = 3.5 + 2 + 0.25 = 5.75 ft

A = (0.02)(8) = 0.16

B = (W-8)/6 = (15-8)/6 = 1.17

Z = Y/2 + V + A + B

= (5.75/2) + 5 + 0.16 + 1.17 = 9.2 ft

(X)(Y)(Z) = (3)(5.75)(9.2) = 158.7 ft³

Since 159 ft³ < 200 ft³, from Table 1, select 6x6 post

H = 9.2 + (5.75/2) + 4 = 16.1 ft

Design Example – Double Post

Given:

Sign 12 ft wide, 4 ft high; 10-ft shoulder with 2% slope; 6H:1V embankment; W = 25 ft; V = 7 ft

Solution:

X = 12 ft; Y = 4 ft

A = (0.02)(10) = 0.2

B = [(W-10) + (0.6X)]/6 = [(25-10) + (0.6)(12)]/6 = 3.7

C = (0.6)(12)/6 = 1.2

Z = Y/2 + V + A + B = 4/2 + 7 + 0.2 + 3.7 = 12.9 ft

(X)(Y)(Z) = (12)(4)(12.9) = 619 ft³

Since 619 ft³ < 695 ft³, select two 6x8 posts.

H₂ = Y/2 + Z + D = 4/2 + 12.9 + 5 = 19.9 ft

H₁ = H₂ - C = 19.9 - 1.2 = 18.7 ft

Note: 6x6 and larger posts require 7-ft spacing. Sign may be installed within the Design Clear Zone.

Exhibit 1020-3 Wide Flange Steel Posts

- X & Y = Single sign or back-to-back signs: Overall dimensions of the sign
- Multiple signs: Dimensions of the area within the perimeter of a rectangle enclosing the extremities of the signs
- Z = Height from the base connection (2½ inches above the post foundation for wide flange beams) to the midheight of the sign at the centerline of the longest post
- H = Post length
- V = Vertical clearance from the edge of traveled way
- W = Distance from the edge of traveled way to the centerline of the longest post nearest the roadway

Design Example – Steel Post Selection

Given:

Sign 22 ft wide, 12 ft high; 10 ft shoulder with 2% slope; 3H:1V embankment; W = 32 ft; V = 7ft.

Solution:

X = 22

Y = 12

A = (0.02)(10) = 0.2

B = [(W-10) + (0.7)(X/3)] = [(32-10) + (0.7x22)]/3 = 12.5

C = (0.35)(22)/3 = 2.6

Z = Y/2 + V + A + B-0.21
 = 12/2 + 7 + 0.2 + 12.5-0.21 = 25.5 ft

(X)(Y)(Z) = (22)(12)(25.5) = 6729 ft³

Since 6729 ft³ < 9480 ft³, select three W10x26 (ASTM A36) or W10x22 (ASTM A992) (see the [Standard Plans](#))

H3 = 12/2 + 25.5 = 31.5 ft

H2 = H3-C = 31.5-2.6 = 28.9 ft

H1 = H2-C = 28.9-2.6 = 26.3 ft

Table 1 Wide Flange Steel Post Selection

Wide Flange Beam			
Post Size		(X)(Y)(Z) (ft ³)	
		Number of Posts	
ASTM A992	ASTM A36	2	3
W6x9	W6x12	1570	2355
W6x12	W6x16	2340	3510
W8x18	W8x21	4120	6180
W10x22	W10x26	6320	9480
W12x26	W12x30	8700	---

Table 2 Wide Flange Beam Weights

Beam Size	Weight lbs/ft	Beam Size	Weight lbs/ft
W6x9	9	W8x21	21
W6x12	12	W10x22	22
W6x16	16	W10x26	26
W8x18	18	W12x26	26
		W10x30	30

Notes:

- Values shown in Table 1 are the maximum permitted.
- A single-wide flange post installation is not allowed.
- Consider using one of the following: perforated square steel tube posts, solid steel tube posts, or round steel posts.
- For post selection for other than wide flange beam supports and a single-post assembly, see the [Standard Plans](#). To determine post sizes for these types of posts, use the wind load charts at: www.wsdot.wa.gov/design/traffic/signing

(See the [Standard Plans](#) for additional information.)

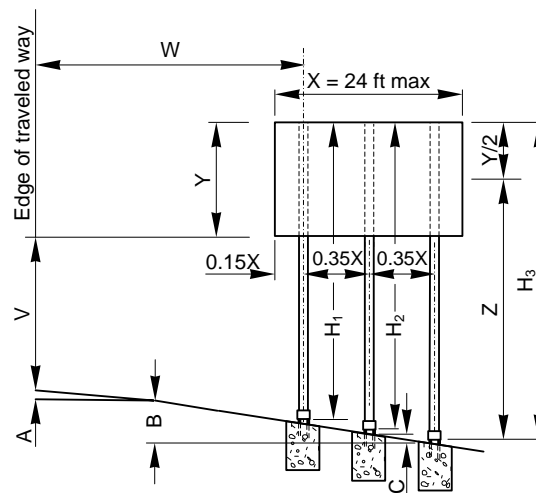
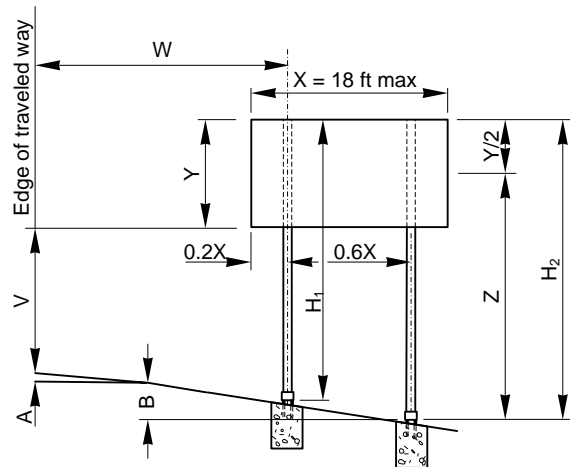
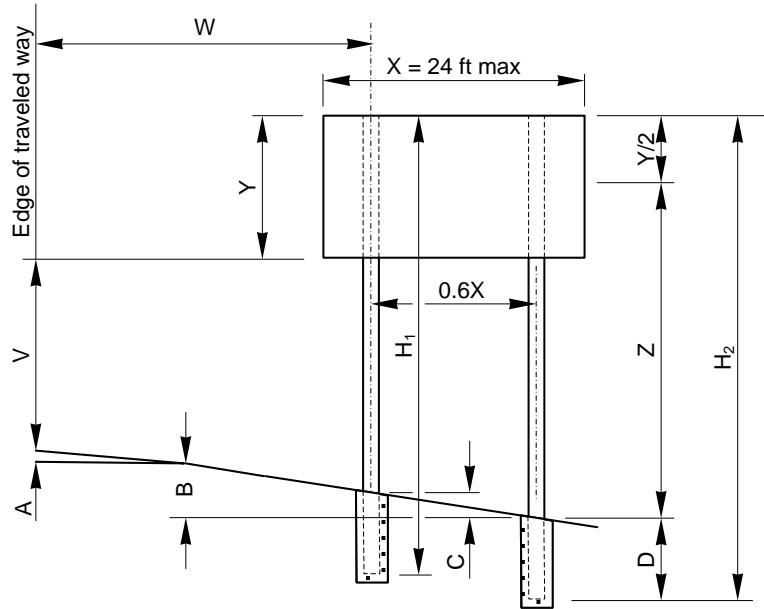

Exhibit 1020-4 Laminated Wood Box Posts



X & Y = Single sign or back-to-back signs:
 Overall dimensions of the sign
 Multiple signs: Dimensions of the area within the perimeter of a rectangle enclosing the extremities of the signs
 Z = Height from ground line to the midheight of the sign at the centerline of the longest post
 D = Embedment depth
 H = Post length
 V = Vertical clearance from edge of traveled way
 W = Distance from edge of traveled way to the centerline of the post nearest the roadway (see the *Standard Plans*)

Table 1 Laminated Wood Box Post Selection

Post Type	Size (in)	Z (ft)	(X)(Y)(Z) ft ³
M	7 7/8 x 7 7/8	15 < Z ≤ 26	1329
M	7 7/8 x 7 7/8	Z ≤ 15	1661
L	7 7/8 x 14 7/8	15 < Z ≤ 26	3502
L	7 7/8 x 14 7/8	Z < 15	4378

Table 2 Embedment Depth (D)

Z (ft)	Sign Area ft ²					
	Up to 50	51 to 100	101 to 150	151 to 200	201 to 250	251 to 290
9 to 12	6	6	7	8	9	10
13 to 15	6	6	7.5	9	10	
16 to 18	7	7.5	9			
19 to 22	7	8	10			
23 to 26	7.5	8.5				

Design Example – M Post Selection

Given:

Two-post assembly sign 16 ft wide, 6 ft high; 10 ft shoulder with 2% slope; 6H:1V embankment; W = 25 ft; V = 7 ft

Solution:

X = 16
 Y = 6
 A = (0.02)(10) = 0.2
 B = [(W-10) + 0.6X]/6 = [(25-10) + (0.6)(16)]/6 = 4.1
 C = (0.6X)/6 = (0.6)(16)/6 = 1.6
 Z = Y/2 + V + A + B = 6/2 + 7 + 0.2 + 4.1 = 14.3 ft
 (X)(Y)(Z) = (16)(6)(14.3) = 1373 ft³
 Since 1373 ft³ < 1661 ft³, select a post type M from Table 1.
 H₂ = Y/2 + Z + D = 6/2 + 14.3 + 6 = 23.3 ft
 H₁ = H₂ - C = 23.3 - 1.6 = 21.7 ft

Design Example – L Post Selection

Given:

Two-post assembly sign 18 ft wide, 8 ft high; 10 ft shoulder with 2% slope; 6H:1V embankment W = 25 ft; V = 7 ft

Solution:

X = 18
 Y = 8
 A = (0.02)(10) = 0.2
 B = [(W-10) + (0.6X)]/6 = [(25-10) + (0.6)(18)]/6 = 4.3
 C = 0.6X/6 = (0.6)(18)/6 = 1.8
 Z = Y/2 + V + A + B = 8/2 + 7 + 0.2 + 4.3 = 15.5 ft
 (X)(Y)(Z) = (18)(8)(15.5) = 2232 ft³
 Since 2232 ft³ < 3502 ft³, select a post type L from Table 1.
 H₂ = Y/2 + Z + D = 8/2 + 15.5 + 9 = 28.5 ft
 H₁ = H₂ - C = 28.5 - 1.8 = 26.7 ft

- 1030.01 General
- 1030.02 References
- 1030.03 Definitions
- 1030.04 Pavement Markings
- 1030.05 Guideposts
- 1030.06 Barrier Delineation
- 1030.07 Object Markers
- 1030.08 Wildlife Warning Reflectors
- 1030.09 Documentation

1030.01 General

The primary function of delineation is to provide the visual information needed by a driver to operate a vehicle in a variety of situations. Delineation includes the marking of highways with painted or more durable pavement marking lines and symbols, guideposts, and other devices such as curbs (see [Chapter 1230](#)). These devices use retroreflectance, which is the reflecting of light from a vehicle's headlights back to the driver, to enhance an object's visibility at nighttime. It is important to maintain an adequate level of retroreflectivity for both traffic signs and traffic markings for motorists during hours of darkness and during adverse weather conditions.

Delineation is a required safety item of work and is addressed on all projects.

A decision to omit delineation work can only be justified if the existing delineation is unaffected by construction and an evaluation of crash rates clearly shows that delineation is not a contributing factor. The Washington State Department of Transportation (WSDOT) uses the latest edition of the MUTCD as a guide for the design, location, and application of delineation.

Consult with the region Traffic Office early in the design process to ensure the proposed delineation is compatible with WSDOT policy and region preference. These policies and preferences address both the type of markings and the material selection.

1030.02 References

(1) *Federal/State Laws and Codes*

Manual on Uniform Traffic Control Devices for Streets and Highways, USDOT, FHWA; as adopted and modified by Chapter [468-95 WAC](#) "Manual on uniform traffic control devices for streets and highways" (MUTCD)

(2) Design Guidance

Roadway Delineation Practices Handbook, FHWA report, Washington, DC, 1994

Sign Fabrication Manual, M 55-05, WSDOT

Standard Plans for Road, Bridge, and Municipal Construction (Standard Plans), M 21-01, WSDOT

Standard Specifications for Road, Bridge, and Municipal Construction (Standard Specifications), M 41-10, WSDOT

(3) Supporting Information

Long-Term Pavement Practices, NCHRP Synthesis 306, Transportation Research Board

1030.03 Definitions

coefficient of retroreflection (R_L) A measure of retroreflection.

delineation Any method of defining the roadway operating area for the driver.

durability A measure of a traffic line's resistance to the wear and deterioration associated with abrasion and chipping.

extrude A procedure for applying marking material to a surface by forcing the material through a die to give it a certain shape.

glass beads Small glass spheres used in highway pavement markings to provide the necessary retroreflectivity.

mcd/m²/lux Pavement marking retroreflectivity is represented by the coefficient of retroreflected luminance (R_L) measured in millicandelas per square meter.

mil Unit of measurement equivalent to 0.001 inches.

MUTCD *Manual on Uniform Traffic Control Devices*.

pavement marking A colored marking applied to the pavement to provide drivers with guidance and other information.

retroreflection The phenomenon of light rays striking a surface and being returned directly back to the source of light.

retroreflectometer An instrument used to measure retroreflectivity.

spraying A procedure for applying marking material to a surface as a jet of fine liquid particles.

service life The service life of a pavement marking is the time or number of traffic passages required for its retroreflectivity to decrease from its initial value to a minimum threshold value indicating that the marking needs to be refurbished or replaced.

traffic paint A pavement marking material that consists mainly of a binder and a solvent. The material is kept in liquid form by the solvent, which evaporates upon application to the pavement, leaving the binder to form a hard film.

wet film thickness Thickness of a pavement marking at the time of application without glass beads.

(a) Application Types

The five application types for pavement markings are:

1. Flat Lines

Flat lines are pavement marking lines with a flat surface.

2. Profiled Marking

A profiled pavement marking consists of a baseline thickness and a profiled thickness, which is a portion of the pavement marking line that is applied at a greater thickness than the baseline thickness. Profiles are applied using the extruded method in the same application as the baseline. The profiles may be slightly rounded if the minimum profile thickness is provided for the entire length of the profile. (See the *Standard Plans* for the construction details.)

3. Embossed Plastic Line

Embossed plastic lines consist of a flat line with transverse grooves. An embossed plastic line may also have profiles. (See the *Standard Plans* for the construction details.)

4. Inlaid Plastic Line

Inlaid plastic line is constructed by rolling Type C tape into hot mix asphalt (HMA) with the finish roller. This application is used infrequently by WSDOT and is not in the *Standard Specifications*.

5. Grooved Plastic Line

Grooved plastic line is constructed by cutting a groove into the pavement surface and spraying, extruding, or gluing pavement marking material into the groove. The groove depth is dependent upon the material used, the pavement surface, and the location. The groove is typically in the range of 20 to 250 mils deep and 4 inches wide. Coordinate with the region Traffic Office on the use and dimensions of grooved plastic line marking.

(4) Raised Pavement Markers

Raised pavement markers (RPMs) are installed as positioning guides with long line pavement markings. They can also be installed as a complete substitution for certain long line markings. RPMs have a service life of two years, and they provide good wet night visibility and a rumble effect. RPMs are made from plastic materials and are available in three different types:

- **Type 1** markers are 4 inches in diameter, $\frac{3}{4}$ inch high, and nonreflectorized.
- **Type 2** markers are 4 inches wide, $2\frac{1}{2}$ to 4 inches long, $\frac{3}{4}$ inch high, and reflectorized.
- **Type 3** markers are 6, 8, 10, or 12 inches wide, 4 inches long, $\frac{3}{4}$ inch high, and nonreflectorized.

Type 2 RPMs are not used as a substitute for right edge lines. They can only be used to supplement the right edge line markings at lane reductions, at sections with reduced lane widths such as narrow structures, and at the gore of exit ramps. All other applications supplementing right edge line markings require the approval of

the region Traffic Engineer. Type 3 RPMs are used in locations where additional emphasis is desired, including vehicle separations and islands. Approval by the region Traffic Engineer is required for all installations of Type 3 RPMs.

Reflectorized RPMs are not required for centerline and lane line applications in continuously illuminated sections of highway. However, if reflectorized RPMs are used at an intersection within an illuminated section, they are also provided throughout that section.

For raised pavement marker application details, see the *Standard Plans*.

(5) Recessed Raised Pavement Markers

Recessed raised pavement markers (RRPMs) are raised pavement markers (RPMs) installed in a groove ground into the pavement in accordance with the *Standard Plans*. RRPMs provide guidance similar to RPMs in ice chisel and steel blade snow-removal areas. RRPMs can also be used in rubber blade snow-removal areas in accordance with region policy.

Designer should be aware that the performance of RRPMs can be compromised, especially on curves, because the groove can block motorists' view of the markers. Also, the groove for RRPMs installed on flat grades can fill with water during rainstorms and cause the RRPM to be nonreflective.

RRPMs, when specified, are installed at the locations shown in the *Standard Plans* for Type 2W RPMs on multilane one-way roadways and Type 2YY RPMs on two-lane two-way roadways.

Do not recess side-to-side RPMs on wide dotted lane lines.

For recessed pavement marker application details, see the *Standard Plans*.

1030.05 Guideposts

(1) General

Guideposts are retroreflective devices mounted to a support post installed at the side of the roadway to indicate alignment. They are considered to be guidance devices rather than warning devices. Guideposts are used as an aid to nighttime driving primarily on horizontal curves; multilane divided highways; ramps; tangent sections where they can be justified due to snow, fog, or other reduced-visibility conditions; and at intersections without illumination.

(a) Types of Guideposts

The retroreflective device may be mounted on either a white or brown post. The types of guideposts and their application are as follows:

1. Type W

Type W guideposts have silver-white reflective sheeting, are facing traffic, and are used on the right side of divided highways, ramps, right-hand acceleration and deceleration lanes, intersections, and ramp terminals.

2. Type WW

Type WW guideposts have silver-white reflective sheeting on both sides and are used on the outside of horizontal curves on two-way undivided highways.

3. Type Y

Type Y guideposts have yellow reflective sheeting, are facing traffic, and are used on the left side of ramps, left-hand acceleration and deceleration lanes, ramp terminals, intersections on divided highways, median crossovers, and horizontal curves on divided highways.

4. Type YY

Type YY guideposts have yellow reflective sheeting on both sides and are used in the median on divided highways.

5. Type G1

Type G1 guideposts have silver-white reflective sheeting on both sides and green reflective sheeting below the silver-white sheeting on the side facing traffic. They are used at intersections of undivided highways without illumination.

6. Type G2

Type G2 guideposts have silver-white reflective sheeting on both sides and green reflective sheeting below the silver-white reflective sheeting on the back side. They are used at intersections of undivided highways without illumination.

(2) Placement and Spacing

Guideposts are placed not less than 2 feet and not more than 8 feet outside the outer edge of the shoulder. Place guideposts at a constant distance from the edge of the roadway. When an obstruction intrudes into this space, position the guideposts to smoothly transition to the inside of the obstruction. Guideposts are not required along continuously illuminated divided or undivided highways. (See [Exhibit 1030-2](#) for guidepost placement requirements and the *Standard Plans* for information on the different types and placement of guideposts.)

1030.06 Barrier Delineation

Traffic barriers are delineated where guideposts are required, such as bridge approaches, ramps, and other locations on unilluminated roadways (see [Exhibit 1030-2](#)). At these locations, the barrier delineation has the same spacing as that of guideposts. Barrier delineation is also required when the traffic barrier is 4 feet or less from the traveled way. Use a delineator spacing of no more than 40 feet at these locations.

Beam guardrail is delineated by either mounting flexible guideposts behind the rail or by attaching shorter flexible guideposts to the wood guardrail posts.

Concrete barrier is delineated by placing retroreflective devices on the face of the barrier about 6 inches down from the top. Consider mounting these devices on the top of the barrier at locations where mud or snow accumulates against the face of the barrier.

1030.07 Object Markers

Object markers are used to mark obstructions within or adjacent to the roadway. The MUTCD details three types of object markers. The Type 3 object marker with yellow and black sloping stripes is the most commonly used object marker.

The MUTCD contains criteria for the use of object markers to mark objects in the roadway and adjacent to the roadway. These criteria are to be followed in project design.

The terminal ends of impact attenuators are delineated with modified Type 3 object markers. These are the impact attenuator markers in the *Sign Fabrication Manual*. When the impact attenuator is used in a roadside condition, the marker with diagonal stripes pointing downward toward the roadway is used. When the attenuator is used in a gore where traffic will pass on either side, the marker with chevron stripes is used.

End of Roadway markers are similar to Type 1 object markers and are detailed in the MUTCD. They are used to alert users about the end of the roadway. The MUTCD criteria are to be followed in project design.

1030.08 Wildlife Warning Reflectors

Studies show that wildlife warning reflectors are ineffective at reducing the accident potential for motor vehicle/wildlife crashes. WSDOT policy is to no longer design, place, or maintain wildlife warning reflectors.

1030.09 Documentation

Refer to [Chapter 300](#) for design documentation requirements.

- Runs of conduit with associated junction boxes leading to each luminaire.
- Conductors routed from the service cabinet breaker to each luminaire.
- A concrete light standard foundation.
- A light standard with a slip base or a fixed base.
- A luminaire (light) over or near the roadway edge line.

There are design considerations that need to be addressed when performing even the most minimal work on an existing illumination system. An existing electrical system is acceptable for use under the design requirements and National Electric Code (NEC) rules that were in effect at the time of installation. When modifying an existing electrical service or transformer, the designer is responsible for bringing the whole system up to current NEC design standards. Retrofitting an existing fixed base light standard with a slip base feature requires the installation of quick disconnect fittings and fuses in the circuit, at the luminaire only. The existing conductor configuration for a fixed base luminaire is not acceptable for use on a breakaway (slip base) installation. Existing conductors and components that no longer meet current NEC requirements are to be replaced and the whole circuit is to be designed to current standards. This may mean replacing the whole circuit back to the nearest overcurrent protection device (circuit breaker). Address the following when modifying an existing illumination system:

- Whether the existing circuit is in compliance with current NEC standards (deficient electrical component).
- Whether existing luminaire system components, such as conductors, conduit, junction boxes, foundation, and pole comply with current standards.
- Whether conductors meet NEC requirements for temperature rating (deficient electrical component).
- Conductor material: aluminum conductors or copper conductors (deficient electrical component).
- Whether the existing bonding and grounding system is adequate: cabinets, poles, junction boxes, including lids, and other appurtenances are bonded and grounded per NEC requirements.
- The condition and adequacy of the existing conduit running between the luminaire and the nearest junction box (deficient electrical component).
- The condition of the junction box next to the luminaire (deficient electrical component).
- The suitability of the existing foundation to meet current design requirements.
- The suitability of the location to meet current design standards for illumination.
- The location and bolt pattern of the existing foundation to meet current design standards.
- The design life remaining for the existing light standard (deficient electrical component).
- The condition of the existing light standard (deficient electrical component).
- Maintenance personnel assessment of the electrical safety of the installation.

Involve appropriate Headquarters (HQ) and region Traffic Office design personnel early in the process. Ensure potential system deficiencies are reflected in the estimate of work.

Maintain required illumination during all construction activities, except when shutdown is permitted to allow for alterations or final removal of the system per the Engineer. Site preparation, widening, drainage, guardrail installation, or other work can easily impact existing conduit runs or luminaire locations. Also, changed conditions such as merging, weaving, or unusual alignment due to traffic control often require additional temporary illumination.

Note: The same lighting requirements apply whether a condition is temporary or permanent.

Illumination is not required for minor operational enhancement projects, unless that is the specific reasoning for the project.

1040.05 Required Illumination

The following items are to be considered for each project:

- Replace standard duty junction boxes that are located in paved areas with heavy-duty junction boxes, and bring electrical components to current standards. Relocate/remove junction boxes that are located in the travel way when practical.
- Review the age of the equipment as listed in SIMMS and consider replacing components that have reached the end of their design life. Replace poles, foundations, heads, and other equipment, that have reached their design life.
- Locate components so that they can be safely accessed from the right of way.
- Ensure existing slip base features are in accordance with current design standards.
- Consider additional illumination in accordance with [1040.06](#), if warranted, or design additional illumination if it is called for in the Project Definition.
- When it is necessary to relocate existing light standard foundations, evaluate the entire conduit run serving those light standards and replace deficient components to current (NEC) standards.

Exhibits [1040-1a](#) through [1040-24](#) show examples of illumination for roadway, transit flyer stops, parking lots, truck weigh stations, tunnels, bridges, work zones, and detour applications.

A minimum of two light standards of standard pole height are required at all design areas, with the exception of ramp terminals and entrance/exit points at minor parking lots.

1040.05(1) Freeway Off-Ramps and On-Ramps

Provide the necessary illumination for the design area of all freeway off-ramp gore areas and on-ramp acceleration tapers (see [1040.07\(2\)](#) and Exhibits [1040-1a](#), [1b](#), and [1c](#)).

1040.05(2) Freeway Ramp Terminals

Provide the necessary illumination for the design area (see [Exhibit 1040-2](#)).

1040.05(3) Freeway On-Ramps With Ramp Meter Signals

Provide the necessary number of light standards to illuminate freeway on-ramps with ramp meters, from 150' before the ramp meter stop bar to 50' past the ramp meter stop bar. When there is an HOV bypass lane or a two-lane merge beyond the ramp meter, then also provide illumination from the point where the merging lane width is 10' to 200' downstream of that point (see [Exhibit 1040-3](#)). Illumination for the ramp merge with mainline is to be done per [Exhibit 1040-1b](#).

1040.06(8) Work Zones and Detours

Consider temporary illumination of the highway through work zones and detours when changes to the highway alignment or grade remain in place during nighttime hours and when the following conditions may be present (see [Exhibit 1040-24](#)):

- Nonstandard roadway features such as narrow lanes, narrow shoulders, or substandard shy distance to barriers or structures.
- The temporary alignment includes abrupt changes in highway direction or lane shifts with substandard lane shift tapers.
- Other unusual highway features such as abrupt lane edge drop-offs, sudden changes in pavement conditions, or temporary excavation or trenching covers.
- There is an anticipation of heavy construction truck traffic, possibly requiring flaggers, entering and exiting the highway during nighttime hours.

For further information on work zones, see [Chapter 1010](#).

1040.06(9) Transit Stops

The responsibility for lighting at transit stops is shared with the transit agency. Consider illuminating transit stops with shelters as they usually indicate greater passenger usage. Negotiation with the transit agencies is required for the funding and maintenance of this illumination. Negotiating a memorandum of understanding (MOU) with each transit agency is preferred over spot negotiations. If the transit agency is unable or unwilling to participate in the funding and maintenance of the illumination, consider a single light standard positioned to illuminate both the transit pullout area and the loading area.

1040.06(10) Bridges

Justification for illuminating the roadway/sidewalk portion of bridges is the same as that for highways on either end of the bridge with or without full limited access control, as applicable. Justification for illuminating the architectural features of a bridge structure requires the approval of the State Traffic Engineer. For justification for illuminating pedestrian walkways or bicycle trails under a bridge, see [1040.06\(12\)](#).

1040.06(11) Railroad Crossing Without Gates or Signals

Consider the illumination of railroad crossings without gates or signals when:

- The crash history indicates that motorists experience difficulty in seeing trains or control devices.
- There are a substantial number of rail operations conducted during nighttime hours.
- The crossing is blocked for long periods due to low train speeds.
- The crossing is blocked for long periods during the nighttime.

For further information, see the [MUTCD](#).

1040.06(12) Sidewalks, Walkways, and Shared-Use Paths

Consider illumination of a pedestrian walkway if the walkway is a connection between two highway facilities. This could be between parking areas and rest room buildings at rest areas; between drop-off/pick-up points and bus loading areas at flyer stops; or between parking areas and bus loading areas or ferry loading zones. Consider illuminating existing sidewalks, walkways, and shared-use paths if security problems have been reported or are anticipated. Under these conditions, these facilities are illuminated to the level shown in [Exhibit 1040-25](#).

1040.07 Design Criteria

1040.07(1) Light Levels

Light levels vary with the functional classification of the highway, the development of the adjacent area, and the level of nighttime activity. Light level requirements for highways and other facilities are shown in [Exhibit 1040-25](#). These levels are the minimum average light levels required for a design area at the end of rated lamp life for applications requiring a spacing calculation. Light level requirements are not applicable for single light standards or security lighting installations where:

- The light level is reduced to approximately 25% of the required light level in parking lots and parking lot loading areas during periods of low usage at night.
- Walkway or path illumination is installed only at areas where shadows and horizontal and vertical geometry obstruct a pedestrian's view.

Light level requirements are applicable when:

- The complete walkway or path is to be illuminated for public safety.

The access areas used for interior inspection of floating bridges or steel box/concrete box girder bridges are exempt from lighting level and lighting ratio design requirements.

For functional classifications of highways, see:

www.wsdot.wa.gov/mapsdata/travel/hpms/functionalclass.htm

1040.07(1)(a) Activity Areas

The types of activity areas (shown below) are related to the number of pedestrian crossings through the design area. These crossings need not occur within a single crosswalk and can be at several locations along the roadway in an area with pedestrian generators. Land use and activity classifications are as follows:

1040.07(1)(a)(1) High Activity

Areas with over 100 pedestrian crossings during nighttime peak hour pedestrian usage. Examples include downtown retail areas; near outdoor stage theaters, concert halls, stadiums, and transit terminals; and parking areas adjacent to these facilities.

1040.07(1)(a)(2) Medium Activity

Areas with pedestrian crossings that number between 11 and 100 during nighttime peak hour pedestrian usage. Examples include downtown office areas; blocks with libraries, movie theaters, apartments, neighborhood shopping, industrial buildings, and older city areas; and streets with transit lines.

1100.01	General
1100.02	Practical Design Procedure
1100.03	Community Engagement
1100.04	Multiagency and Interdisciplinary Advisory Team
1100.05	Need and Performance Identification
1100.06	Context Identification
1100.07	Design Control Selection
1100.08	Alternative Formulation and Evaluation
1100.09	Design Element Selection and Dimensions
1100.10	Documentation Tools
1100.11	References

1100.01 General

The Washington State Department of Transportation (WSDOT) has adopted practical design as an approach to making project decisions. This chapter provides a process and informational overview of practical design and implementation expectations with this approach. This chapter will introduce terminology, general information, and a procedural process overview, while the remaining chapters in Division 11 provide specific design policy details for each procedural step. WSDOT's practical design approach is based on context sensitive solutions and performance-based design, which utilize a collaborative approach, design flexibility, and a high likelihood of variable solutions. As a result, WSDOT's practical design finds consistency through the procedural process applied rather than specific project-type outcomes.

This chapter provides:

- An overview and description of the WSDOT Practical Solutions initiative.
- An overview of the practical design process and the relevant chapter information necessary to complete each process step.
- Information regarding the importance of design control selection.

1100.01(1) *Practical Solutions*

Practical Solutions is a two-part strategy that includes least cost planning and practical design, which WSDOT defines in [Executive Order \(EO\) E 1090](#).

WSDOT deploys this strategy to enable more flexible and sustainable transportation investment decisions. It encourages this by: (1) increasing the focus on addressing identified performance needs throughout all phases of development, and (2) engaging local partners and stakeholders at the earliest stages of scope definition to account for their input at the right stage of the development process. Practical Solutions includes one or a combination of strategies, including, but not limited to, operational improvements, off-system solutions, transportation demand management, and incremental strategic capital solutions.

1100.01(1)(a) **Least Cost Planning**

Least cost planning is an approach to making planning decisions that consider a variety of conceptual strategies to achieve the desired system performance targets for the least cost.

Central to least cost planning is a process that identifies regional and corridor performance areas, engages communities to ascertain local contexts and needs, and applies methods to evaluate and implement short- and long-term solutions.

The outcome of least cost planning is a recommended set of multimodal strategies that are cost-effective and balance the goals and objectives of state and local needs. This approach informs practical design solutions by providing the following potential outcomes:

- Identify performance gaps for a corridor segment now and in the future.
- Integrate inputs from partners that support corridor segment performance.
- Define what is known about context and what may happen on and around a corridor.
- Identify sets of potential strategies to address the gaps at certain time frames.
- Reduce the need for higher-cost mobility capital solutions by first identifying and ranking operational improvements and demand management strategies.

[E 1090](#) instructs that the solution may or may not be on a state corridor.

1100.01(1)(b) Practical Design

Practical design is an approach to making project decisions that focuses on the specific problem the project intends to address. This performance-based approach looks for lower-cost solutions that meet outcomes that WSDOT, partnering agencies, communities, and stakeholders have identified. Practical design is a fundamental component to the Vision, Mission, Values, Goals, and Reforms identified in [Results WSDOT](#), the department's Strategic Plan. The primary objectives of the practical design approach are: (1) focusing on project need, and (2) seeking the most reasonable low-cost solution to meet that need.

Practical design allows flexibility and freedom to innovate, and considers incremental solutions to address uncertainties in future scenarios. Practical design can be applied at all phases of project development; however, it is most effective at the scoping level or earlier, where key decisions are made as to what design controls and elements are affected by alternatives and how they can best be configured to meet the project and contextual needs.

With practical design, decision-making focuses on the maximum benefit to the system, rather than the maximum benefit to the project. Practitioners are to “design up,” starting with minimal design element dimensions and increasing those values until acceptable cost-effective performance is obtained. Focusing on the specific project need minimizes the scope of work for each project so that systemwide needs can be optimized through individual project savings.

1100.02 Practical Design Procedure

Practical design, despite its name, is not always fully confined to the conventional design phase. It begins when a location under evaluation moves from a discussion of strategies to one of potential solutions within those strategies. The practical design procedures apply when a location under evaluation in planning moves from a discussion of strategies to one of potential solutions within those strategies, when scoping phase requires a Basis of Design, or when the preliminary engineering phase for a funded project is initiated. In each of these situations, practical design procedures apply whether or not least cost planning has occurred. [Exhibit 1100-1](#) provides a flowchart for the practical design procedures. [Exhibit 1100-2](#) shows the documentation needs correlated to individual procedural steps.

WSDOT's practical design process consists of seven primary procedural steps:

1. Assemble a Multiagency, Interdisciplinary and Stakeholder Advisory (MAISA) Team (see [1100.04](#)).
2. Clearly identify the baseline need, in terms of performance, contributing factors, and underlying reasons for the baseline need (see [Chapter 1101](#)).
3. Identify the land use and transportation context (which includes environmental use and constraints) for the location (see [Chapter 1102](#)).
4. Select design controls compatible with the context (see [Chapter 1103](#)).
5. Formulate and evaluate potential alternatives that resolve the baseline need and are bound by the selected context and design controls (see [Chapter 1104](#)).
6. Select design elements employed and/or changed by the selected alternative (see [Chapter 1105](#)).
7. Determine design element dimensions consistent with the alternatives performance needs, context, and design controls (see [Chapter 1106](#)).

The Basis of Design (BOD) is used to document the outcomes of applying these procedural steps. It also serves as a management tool throughout the design phase, to keep a project team focused on the baseline performance need and agreed performance trade-offs in order to prevent scope creep. A BOD is required on all projects, unless design elements are not employed or changed (see [Chapter 1105](#)). A BOD is only required on scoping projects as determined by the Capital Program Development and Management (CPDM) Office. See [1100.10\(1\)](#) for further information about the BOD.

Exhibit 1100-1 Practical Design Procedural Flowchart Where Basis of Design is Needed

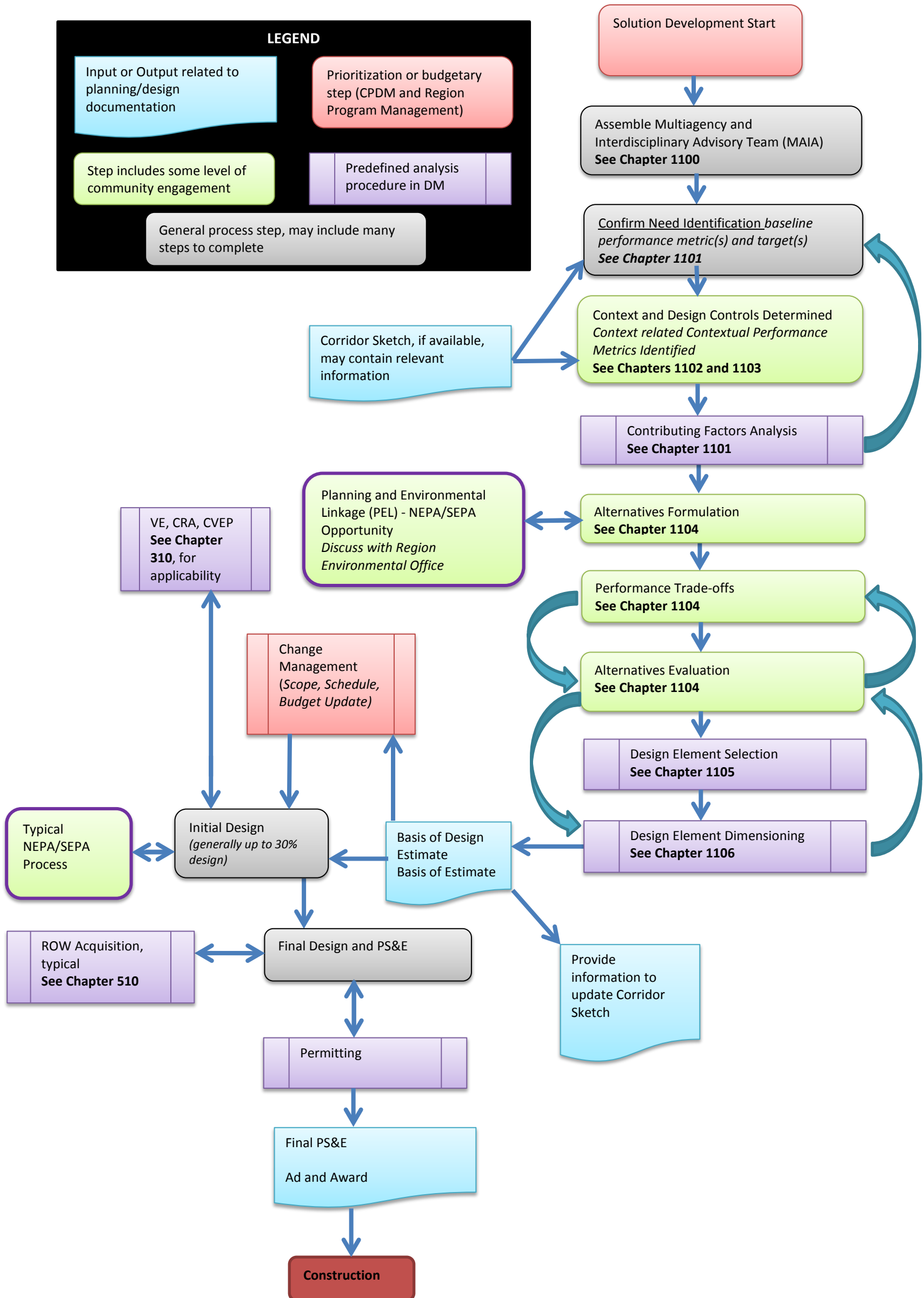

1100.03 Community Engagement

WSDOT has a strategic goal of engaging the community in order to strengthen partnerships, increase credibility, drive priorities, and inform decision-making. Involving the community is essential to fully understand the performance gaps, context identification (see [Chapter 1102](#)), local environmental issues, and modal needs and priorities.

WSDOT encourages recognition of individual community contexts, values, and needs. WSDOT uses best practices and the flexibility available to engage communities in developing transportation solutions. We will do so in order to enhance public trust and develop targeted designs that provide for the performance needs of the state, regional, and local transportation systems. – Executive Order 1096

Use the [WSDOT Community Engagement Plan](#) and document the findings of community engagement efforts (see [1100.10\(6\)](#)).

1100.04 Multiagency, Interdisciplinary, and Stakeholder Advisory Team

Collaborative decisions contribute to success in project delivery, and are emphasized through the context sensitive design approach in WSDOT's practical design policies. Provide for consent-based outcomes early in the project development timeline as indicated in WSDOT [Executive Order 1096 - WSDOT 2015-17: Agency Emphasis and Expectations](#) and [Executive Order 1028 – Context Sensitive Solutions](#). Convening a Multiagency, Interdisciplinary and Stakeholder Advisory Team (MAISA) Team is an accepted approach to meet the intent of these policies. The MAISA Team is a collaborative body that provides recommendations to the WSDOT project manager and engineer of record, specifically in these areas:

- Need Identification
- Context Identification
- Design Control Selection
- Alternative Formulation
- Performance Trade-off Decision Preferences (including weighing environmental constraints and regulatory issues)
- Alternative Evaluation

The Engineer of Record or project manager convenes the MAISA Team, basing its membership on the kind of skills, knowledge, and responsibilities indicated by the issues pertinent to design decision making; including planning, project development, environment, modally oriented designs, and context sensitive design. In addition, include WSDOT members on the MAISA team who have positional or delegated authority to make decisions associated with the areas outlined in this chapter. Key decisions made by the engineer of record are based on recommendations made by the MAISA Team. These recommendations and decisions are documented in the appropriate sections of the Basis of Design, and provide fundamental boundaries for the project team to work within as design concepts move forward. The justification for whether or not each MAISA Team recommendation will be incorporated into the project are also provided in writing separately to the MAISA Team, in order to provide the Team an opportunity for feedback, and attached to the Basis of Design prior to its approval.

For more information on potential methods for organizing, managing, and collaborating with the MAISA teams, see the WSDOT Project Management Online Guide:

www.wsdot.wa.gov/projects/projectmgmt/onlineguide/preconstructioninitiatealign

For additional guidance regarding MAISA teams, see the guidance document *Multiagency, Interdisciplinary, and Stakeholder Advisory Team*

<http://www.wsdot.wa.gov/Design/Support.htm>.

1100.05 Need and Performance Identification

The most fundamental function of practical design is to focus on the primary reason a location is under evaluation. Ask why there is a project under consideration at this location, and identify the specific need. If it is a mobility project; why is there a mobility need and what is specifically contributing to that need? WSDOT's practical design approach requires that the need be translated into specific performance metrics and that targets be selected to be achieved by the design. A contributing factors analysis (see [Chapter 1101](#)) is used to better define what to focus on in order to resolve the specific performance problem, helping to define the potential scope of project alternatives.

[Chapter 1101](#) provides details on how performance needs are identified and utilized in practical design. However, understanding performance and associated performance terms is critical to the application of [Chapter 1101](#). It is recommended that various teams and partners collaborating on the project view the guidance document *Performance Based Design* (see <http://www.wsdot.wa.gov/Design/Support.htm>) before proceeding with application of [Chapter 1101](#).

1100.06 Context Identification

Context identification refers to understanding the characteristics, activities, and functions within a geographical area. WSDOT is committed to providing context sensitive solutions (see [E 1028](#)), and context identification is a key component required to implement practical design. WSDOT's context identification process requires that two interrelated context facets be identified: land use and transportation. It also requires that a context condition be selected for design—either existing, future, or transition between existing and future contexts. [Chapter 1102](#) provides the context identification information.

1100.07 Design Control Selection

Design controls are specific design elements that create significant boundaries and influence on all other design elements. WSDOT has identified four primary design controls:

1. Design Year
2. Terrain Classification
3. Modal Priority
4. Access Control
5. Target Speed

[Chapter 1103](#) presents more information related to these design controls.

1100.08 Alternative Formulation and Evaluation

Under practical design, the goal is to develop a solution for the baseline need at the least cost. However, it is critical to understand how the solution affects other known or identified needs, termed “contextual needs.” Chapter 1101 provides a discussion on baseline and contextual performance needs, and Chapter 1104 discusses how these needs are utilized to develop and evaluate alternatives.

WSDOT’s Practical Solutions approach requires that operational and demand management strategies are considered prior to implementing a capital strategy. The intent is to account for low-cost solutions being applied before making large capital investments.

In some cases, the planning phase will have identified a strategy based on least cost planning analysis. Focusing on the preferred strategy can help guide the development of alternative solutions. The guidance document *Alternative Strategies and Solutions* (<http://www.wsdot.wa.gov/Design/Support.htm>) discusses the three primary strategies and examples of solutions within those strategies.



1100.09 Design Element Selection and Dimensions

Design element selection is based entirely on the alternative selected to resolve the baseline need and balance performance trade-offs. Chapter 1105 provides instruction for design element selection. Chapter 1106 provides information related to choosing dimensions for design elements.

1100.10 Documentation Tools

Basis of Design (BOD), Basis of Estimate (BOE), Design Parameter Sheets, Alternative Comparison Tables, and Performance Target Refinement Form are all documentation tools used to record decisions and analyses needed in development of a solution that is consistent with WSDOT’s practical design approach.

1100.10(1) Basis of Design

The BOD is organized around the practical design procedural steps (see 1100.02) necessary to support WSDOT’s practical design approach. It provides a template for documenting each step in the process. The BOD includes the following base information and sections:

- Planning Document Summary
- General Project Information
- Section 1 – Project Need
- Section 2 – Context
- Section 3 – Design Controls
- Section 4 – Alternative Analysis
- Section 5 – Design Element Selection

[Exhibit 1100-2](#) shows how the Basis of Design document correlates with the practical design procedural steps and Design Manual chapters. A BOD is required on all projects, unless design elements are not employed and/or changed (see [Chapter 1105](#)). For example, a pavement preservation project that is not modifying lane or shoulder widths will not normally require a BOD; in this case, information provided in the Project Summary and within [Washington State Pavement Management System \(WSPMS\)](#) are sufficient documentation of the design decisions in this example.

Project teams are encouraged to complete a BOD at the earliest stages possible. If the BOD can be partially completed in the planning phase (meaning only some sections are completed), then there can be benefits. Benefits of utilizing a BOD in planning may result in better consistency between strategies developed in planning and solutions developed in design. Derive BOD decisions from MAISA team recommendations. If the BOD is used in planning, whether completely or partially, account for procedures in [1100.04](#).

Contact Region Program Management Office for determining use of BOD in the scoping phase. In most situations, the BOD will be initiated within the design phase. BOD approval will occur with Design Approval (see [Chapter 300](#)).

The Basis of Design can be downloaded at:

 <http://www.wsdot.wa.gov/Design/Support.htm>.

Exhibit 1100-2 Basis of Design Flowchart

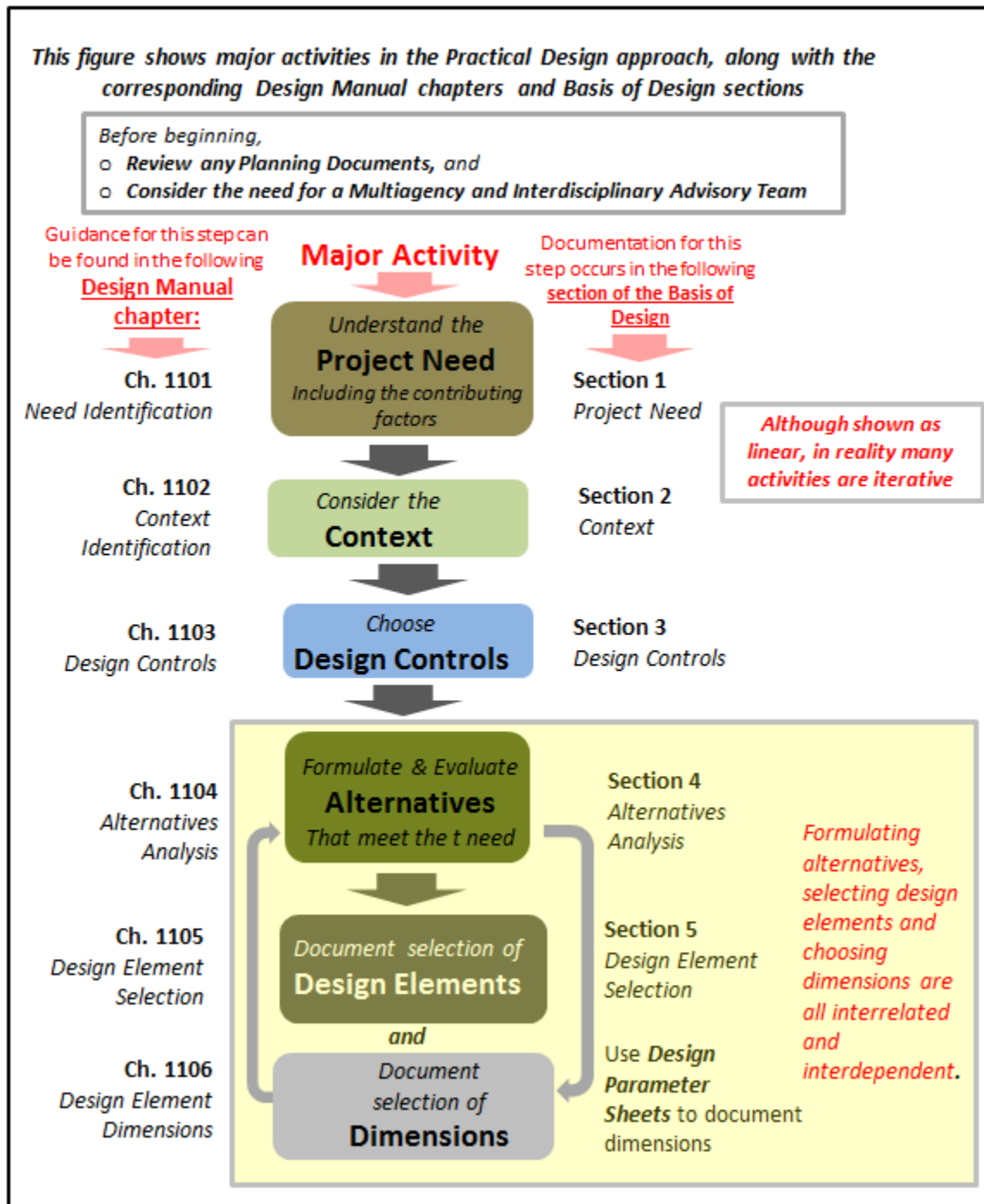

1100.10(2) Basis of Estimate

A Basis of Estimate will always be required, and it should be updated throughout all phases of development. Refer to the *Cost Estimating Manual for WSDOT Projects* for additional information on estimating and the Basis of Estimate.

1100.10(3) Alternative Comparison Table

The Alternative Comparison Table (ACT) is designed to provide solutions evaluated in accordance with WSDOT's Practical Solutions approach. This table is used to evaluate solutions accounting for the resolution of the baseline performance need at the least cost, with an understanding of the effects on other contextual performance metrics. The table also enables discussions to occur around performance trade-offs that may be necessary depending on the range of potential solutions being considered and their benefits or impacts across all performance metrics identified. The Alternative Comparison Table is supplemental documentation for Section 4 of the BOD, and can also be used to document the need to refine performance targets (see [Chapter 1106](#)). The ACT can be downloaded from:

<http://www.wsdot.wa.gov/Design/Support.htm>.

1100.10(4) Design Parameter Sheets

While a primary function of the BOD is to select the design elements that will be employed or changed in a project (see [Chapter 1105](#)), a primary function of the design parameter sheets is to document the dimensions selected for the various design elements selected and noted in Section 5 of the Basis of Design. A design parameter sheet template can be found at the following link:

<http://www.wsdot.wa.gov/Design/Support.htm>.

1100.10(5) Performance Target Refinement Form

The BOD is approved at design approval, which may be a relatively early stage of design development. There are situations where additional design iterations and increased project knowledge will change the performance tradeoffs or identify additional environmental constraints to consider. The Performance Target Refinement Form provides an opportunity to refine performance targets for metrics after the BOD is approved, and always used to refine baseline safety performance targets for mobility and economic performance category projects (whether or not the BOD is approved). The Performance Target Refinement Form can be found at the following link:

<http://www.wsdot.wa.gov/Design/Support.htm>.

1100.10(6) Documenting Community Engagement

Community engagement is a fundamental component of WSDOT's Practical Solutions strategy, and key to practical design implementation. Community engagement will be consistent with the WSDOT Community Engagement Plan (<http://www.wsdot.wa.gov/planning/>).

In order to be consistent with the Community Engagement Plan, as well as to provide source documentation for teams working on the project, a Community Engagement Documentation Package (CEDP) is suggested for use. Note that there is no strict format for the CEDP. The general elements for the CEDP package can be found in the guidance document *Documenting Community Engagement* (<http://www.wsdot.wa.gov/Design/Support.htm>).

1100.11 References

1100.11(1) *Federal/State Directives, Laws, and Codes*

Revised Code of Washington (RCW) 47.04.280 – Transportation system policy goals

 <http://apps.leg.wa.gov/rcw/default.aspx?cite=47.04.280>

Revised Code of Washington (RCW) 47.05.010 – The statement of purpose for priority programming of transportation projects

 <http://apps.leg.wa.gov/RCW/default.aspx?cite=47.05.010>

Engrossed Substitute House Bill 2012 (Passed Legislation amending RCW 47.01 for Practical Design – link not available by publication)

Secretary's Executive Order 1090 – Moving Washington Forward: Practical Solutions

 <http://wwwi.wsdot.wa.gov/publications/policies/fulltext/1090.pdf>

Secretary's Executive Order 1096 – WSDOT 2015-17: Agency Emphasis and Expectations

 <http://wwwi.wsdot.wa.gov/publications/policies/fulltext/1096.pdf>

Secretary's Executive Order 1028 – Context Sensitive Solution

 <http://wwwi.wsdot.wa.gov/publications/policies/fulltext/1028.pdf>

1101.01	General
1101.02	Baseline Needs
1101.03	Contextual Needs
1101.04	Contributing Factors Analysis
1101.05	Project Need Statement
1101.06	Documentation
1101.07	References

1101.01 General

Practical design starts with identification of issues or “problems” associated with the performance of a transportation facility. First, one or more project needs (either baseline or contextual) associated with these issues are identified. These project needs represent the gap in performance between the existing and desired state. Once they are identified, a project need statement is then developed which expresses only the most fundamental causes of these performance gaps.

This chapter provides:

- Instruction on different types of needs—baseline and contextual—used in WSDOT’s practical design procedures for design element selection and dimensioning.
- A method to diagnose and analyze the contributing factors of the identified need.
 - Baseline and contextual needs are relative to the existing state. Contributing Factors Analysis (CFA) (see [1101.04](#)) helps identify the underlying reasons why needs currently exist so that solutions can strategically target the “root” of a need.
- Instruction on how to determine performance metrics and targets for each of the identified needs based on performance thresholds and other relevant information.
 - Performance targets are related to the desired state. The possible alternatives are how the desired state could be obtained. The preferred alternative is the plan to achieve the desired state.
- How to develop project need statements.

1101.02 Baseline Needs

A baseline need is the primary reason a project has been proposed at a location. The baseline need usually evolves from a WSDOT planning and/or priority array process which examines the issues to be addressed at a location or through a program. There can be more than one baseline need derived from the planning and/or priority array process, or where an agency partners with WSDOT on a project and the partners need becomes another baseline need of the overall project.

Example: A local agency desires to fund a revitalization project for a community bordering a state highway. The local agency’s baseline need in this case is the local land use’s economic vitality. If WSDOT also happens to have a prioritized and funded baseline need at the same location, and the two parties decide to partner in a combined

project, that project will have at least two baseline needs. The two parties will work to develop solutions compatible for both baseline needs.

Practical design requires that designers refrain from overdesigning the project by focusing the solution on the baseline need or needs. In doing so, opportunities are provided by projects to address other needs that may be identified through community engagement and/or increased project knowledge and understanding. These other needs are classified as “contextual needs” (see [1101.03](#)).

To determine, develop, and refine the project’s baseline need(s), examine the conditions surrounding the original project identification, which was completed in the priority programming phase.

After developing and refining the baseline need(s), define the baseline performance metrics. The baseline performance metrics (see [1101.02\(1\)](#)) are the primary means of comparing alternatives and measuring the ultimate success of the final built alternative. Determine the baseline need targets (see [1101.02\(2\)](#)) that will comprise the proposed desired state (post project) of the location. Baseline performance metric(s) and target(s) are used as both the starting point to compare alternatives and the goal that measures the success of the finished product.

1101.02(1) Baseline Performance Metrics of the Baseline Need(s)

Baseline performance metrics are those “measurables” used to check that the project satisfies the need(s). Project alternatives must address the identified baseline performance metric(s). Baseline performance metrics are also used in the development of the project need statement.

Threshold performance metrics are used in the priority array programming process to screen the full state network under each performance category and search for potential need locations (for further information on threshold performance metrics and performance categories, see the guidance document *Performance-Based Design*: www.wsdot.wa.gov/Design/Support.htm). The baseline performance metric for preservation category projects is predetermined, and is the same as the threshold performance metrics determined by Subject Matter Experts (SMEs) and HQ Capital Program Development and Management (CPDM) Office. The baseline performance metrics for a mobility or economic vitality category project may be different from the threshold performance metrics. However, the baseline metric chosen is to be consistent with the priority array performance category that identified the location to be evaluated. Baseline performance metrics used to design alternatives considers the context (see [Chapter 1102](#)) and modal priority (see [Chapter 1103](#)).

Example: A routinely congested corridor has been identified for project scoping using a threshold performance metric of estimated operations at 70% of posted speed during the peak hour. After considering the context of the location, and the relevance of the threshold performance metric to the site specific conditions and operations, the interdisciplinary team recommends that travel time reliability is a more appropriate metric for the location.

WSDOT’s practical design procedure is committed to multimodal safety as identified in Washington State’s Strategic Safety Plan (see www.targetzero.com/plan.htm). To meet this commitment, projects are required to include a baseline performance metric for evaluating the number of fatal and serious injury crashes in safety, mobility and economic vitality category

projects. Other safety metrics to address the specific community or partnering agency needs may be included as contextual needs.

Safety-specific projects are expected to continue project development as directed by the Multimodal Safety Executive Committee (MSEC), and described in the [Safety Scoping Flowchart](#) and [Chapter 321](#). Non-safety performance category projects are to coordinate up front with the HQ Safety Technical Group to determine the scale and scope of crash risk analysis appropriate for different types and sizes of projects. For additional information on sustainable safety at WSDOT, see [Chapter 321](#).

1101.02(2) Baseline Performance Target

Performance targets are the outcome (or desired state) intended for a project. Use baseline performance targets to compare alternative designs based on how well the alternative meets the selected targets relative to their costs and ability to balance performance outcomes. Targets can be a single value or range of values.

As alternatives are analyzed for their ability to meet performance targets for the various metrics selected, there may be situations where the targets cannot practicably be met by any alternative or where there are unacceptable performance trade-offs in other performance categories. In these situations it may be appropriate to accept performance trade-offs, in one of the other categories during the alternatives evaluation (see [Chapter 1104](#)), in order to balance competing needs and outcomes. In other situations, it may be appropriate to refine the performance target under consideration (see [Chapter 1106](#)).

1101.03 Contextual Needs

While a project is to address the baseline performance need(s), it is also important to recognize the effects that project alternatives may have on other community and transportation interests. Additional needs (other than the baseline needs), that warrant consideration, may be identified throughout the course of project development. These needs are referred to as contextual needs. A contextual need is any potential need that is identified, but is not a baseline need. Potential sources of contextual needs include:

- Contextual performance identified through the priority array network screening, that did not prioritize under a statewide biennial prioritization and budget exercise, but still exist at the project location.
- Contextual performance needs identified through community engagement or identified by a partnering agency.
- Contextual performance needs based on identified environmental regulations and constraints.
- Contextual performance needs identified through the responsible maintenance jurisdiction(s) (see [Chapter 301](#) for additional information).
- Contextual performance needs identified through increased knowledge of the project site and context.

Develop metrics (ways of measuring) for contextual needs to compare alternatives and measure potential outcomes. Interpret and translate each issue into a statement that is measurable, to the extent feasible. Contextual needs are quantifiable based on either quantitative or qualitative understanding of outcomes.

1101.03(1) Use in Alternative Formulation and Evaluation

Contextual needs serve a slightly different role than baseline needs. Contextual needs exist to account for alternatives that unnecessarily and unknowingly adversely impact performance issues of interest to WSDOT, other agencies, or the community while keeping focus on the baseline need. Baseline needs primarily influence alternatives developed, but contextual needs are important for the performance trade-offs discussion (see [Chapter 1104](#)) when choosing alternatives. Not all contextual needs identified need to be addressed by a project. Contextual needs inform the project about opportunities for optimizing design, provide for partnerships and modes, and ultimately determine the most optimal project alternative (in conjunction with SEPA/NEPA processes as discussed in [Chapter 1104](#)).

Whether a design alternative achieves a particular contextual performance target is a consideration during the tradeoffs analysis. When no alternative adequately balances performance, low-cost countermeasures can be employed to help offset or mitigate performance issues and improve the viability of alternatives. Modifications to one or more design controls are another approach that can be used to achieve contextual performance targets (see [Chapter 1103](#)), without significantly burdening the alternative with additional cost. If all alternatives fail to find an acceptable performance balance after the BOD is approved, then targets may be refined using procedures in Chapter 1106.

1101.04 Contributing Factors Analysis

Contributing factors analysis (CFA) is a process by which an interdisciplinary team evaluates the contributing factors associated with performance gaps in order to identify the common root reasons for each gap. In the transportation field, contributing factors are any geometric, operational, context-based, or human factor that can reasonably be attributed to a performance need through data analysis and engineering judgment.

Practical design relies on CFA to find the root reason(s) a need exists, rather than focusing on a symptom that may only temporarily or partially resolve the need. (This is analogous to providing medical treatment for pain, rather than identifying and addressing the underlying reason for the pain.)

Note: It is recognized that completely solving a problem may not be possible by a single corrective action due to the number of contributing factors or because of constraints.

The CFA method will:

- Organize and identify multiple contributing factors and underlying root reasons.
- Formulate a number of potential countermeasures, a subset of which will solve the need as thoroughly and efficiently as possible.

Diagnosis of contributing factors yields the best results when data is available for the analysis. Comprehensive available crash data, organized by travel mode, will yield the strongest and most quantitative evidence about contributing factors with respect to performance metrics under the safety performance category. Performance metrics in other categories, where quantitative data may be scarce or not obtained within a reasonable time frame or cost, can rely on qualitative analysis to reveal the underlying contributing factor(s).

Contributing factor analysis is only required for evaluation of baseline performance needs. However, it may be relevant to perform CFA for some or all of a project's contextual

performance metrics depending on either: the complexity of the need(s), or the initial assumptions about the potential interrelationships between the baseline and contextual performance metrics.

Diagnosing contributing factors using CFA is not necessarily a simple linear process. It's possible to find that a contributing factor identified by one discipline is the root cause of another discipline's contributing factor. In some cases, mapping the contributing factors in a network or fishbone diagram can help identify these relationships more clearly (see the guidance document *Contributing Factors Analysis*: www.wsdot.wa.gov/Design/Support.htm).

1101.05 Project Need Statement

A project need statement (or statement of need) uses the baseline needs (see [1101.02](#)) and results of contributing factors analysis to succinctly describe the real root project need(s). The objective is to provide a clear, accurate plain talk description of the root needs that will facilitate the development of efficient, focused project alternatives. A need statement should:

- Identify the objective, in simple, direct terms.
- Identify the performance metric(s) involved.
- Include one or more quantifiable statements.
- Exclude any description or discussion of potential solutions.

For more information and examples of need statements, see the guidance document *Writing Effective Needs Statement*: www.wsdot.wa.gov/Design/Support.htm

1101.06 Documentation

Use the Basis of Design, Section 1, to document decision-making and conclusions associated with project need identification.

Download The BOD here: www.wsdot.wa.gov/Design/Support.htm

1101.07 References

Contributing Factors Analysis, WSDOT Guidance Document:

www.wsdot.wa.gov/Design/Support.htm

Performance-Based Design, WSDOT Guidance Document:

www.wsdot.wa.gov/Design/Support.htm

Writing Effective Needs Statement, WSDOT Guidance Document:

www.wsdot.wa.gov/Design/Support.htm

Washington State's Strategic Safety Plan:

www.targetzero.com/plan.htm

WSDOT Safety Scoping Flowchart:

wwwi.wsdot.wa.gov/ppsc/pgmmgt/wwwi/PlanProg/Scoping/SafetyScopingProcessFlowChart.pdf

- 1102.01 General Overview
- 1102.02 Context Identification Procedures
- 1102.03 Context Information Sources
- 1102.04 Context Types, Relationships and Key Characteristics
- 1102.05 Future Context Identification and Context Transitions
- 1102.06 Additional Context Considerations
- 1102.07 Documentation
- 1102.08 References

1102.01 General Overview

Context refers to the environmental, economic, and social features that influence livability and travel characteristics. Context characteristics provide insight for the designer into the activities, functions, and performance that can be either reinforced or discouraged by the roadway design. For the purposes of transportation planning and design, WSDOT divides context into two categories: land use context and transportation context.

Ideally, a corridor sketch plan is how WSDOT and its partners capture information about both transportation and land use context. If not, gather and process context information as soon as practicable in the project development process. Land use and transportation contexts have an existing (current) and future (vision) condition. In some cases, existing and future contexts and/or land use and transportation contexts will align; while in other cases, there will be differences that need to be reconciled through planning and design efforts.

Land use context describes the built, natural or resource lands immediately adjacent to and surrounding a facility. Existing land use context is found through structured observation and recording of existing conditions. Future land use context is documented as part of a community vision that describes how a local agency and/or community envisions land uses will develop over time (see [1102.05\(2\)](#)). Transportation context is a description of the facility function, type, and how the facility is used in terms of modes and type of trips being made. Future transportation context is represented by a regionally oriented corridor vision (see [1102.05\(1\)](#)).

Context and need identification (see [Chapter 1101](#)) are the foundation for practical design at WSDOT, and design controls (see [Chapter 1103](#)) are boundaries for alternative formulation (see [Chapter 1104](#)). Context identification guides the selection of design controls, and can directly or indirectly effect the relevance of certain design elements (see [Chapter 1105](#)) and their dimensions (see [Chapter 1106](#)). The performance attributed to design elements and their dimensions can change depending on context. Use contributing factors analysis (see [Chapter 1101](#)), informed by context, to determine which design elements will have the greatest impact on the performance categories under evaluation. See also the guidance document *Effects of Different Design Elements on Performance* <http://www.wsdot.wa.gov/Design/Support.htm> for general information that may assist with identification of potential geometric contributing factors.

This chapter provides:

- Procedures for project teams to gather information.
- Procedures for project teams to use when engaging subject matter experts in a land use context identification.
- General information regarding the context characteristics that can influence the selection of design controls.
- Transportation contexts and suggestions for specific design control selections associated with those contexts.

1102.02 Context Identification Procedures

Context identification should occur as early as possible and preferably prior to the design phase. However, context identification should occur no later than the need identification step in the design process (see [Chapter 1101](#)). Context characteristics can contribute to a performance need under evaluation, or help identify misaligned design controls with respect to either the land use or transportation context. Making a determination about whether to design for an existing, future or transitional context is required, and will likely affect the types of alternatives formulated and evaluated (see [Chapter 1104](#)). Exhibit 1102-1 shows an overall procedure for context identification and the following subsections provide process step recommendations for determining components of the overall procedure.

Exhibit 1102-1 Context Identification Procedures

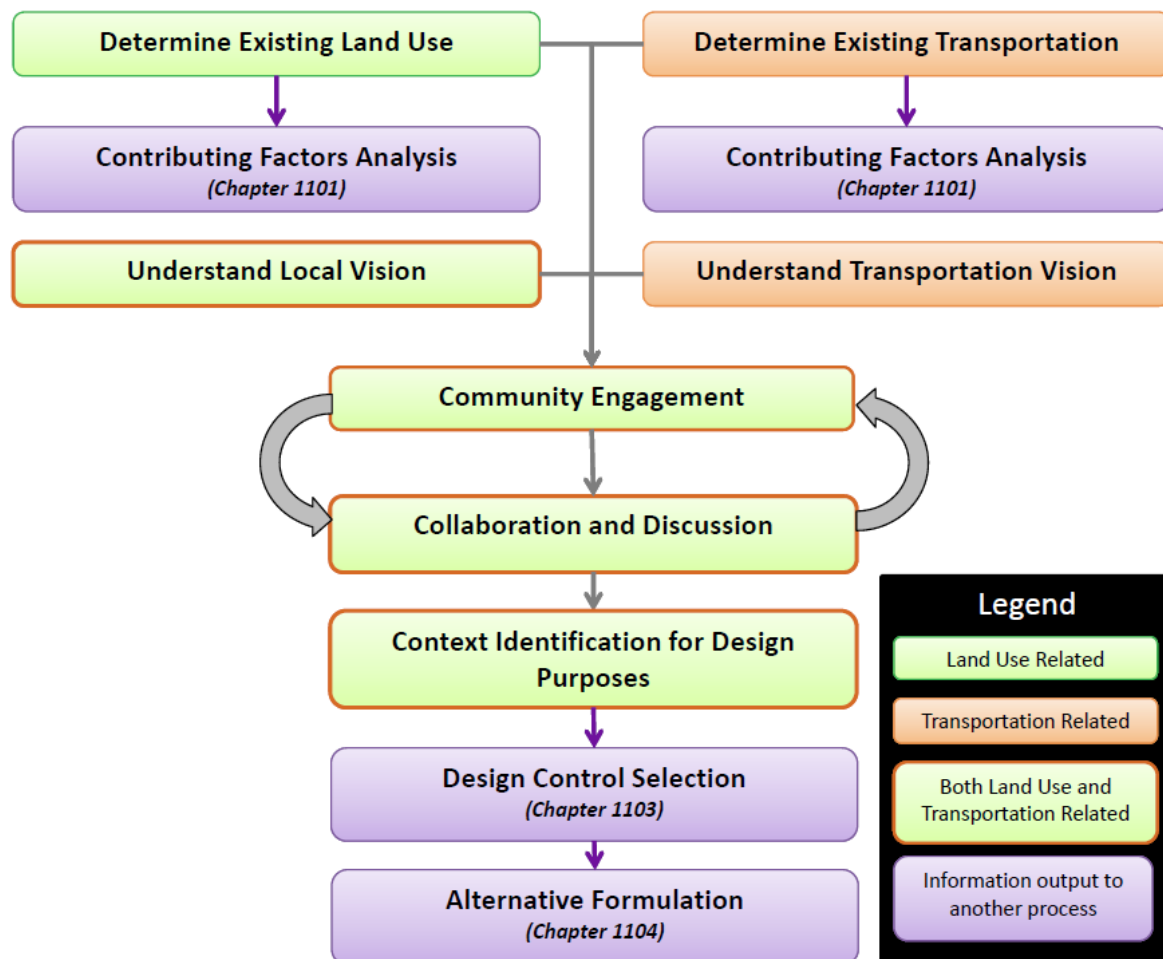

1102.02(1) Land Use Context Identification Procedures

Land use identification is typically carried out by, or in close collaboration with, WSDOT region planning staff and local planners, and not independently by project design teams. The level of engagement and who to engage will depend on the availability of existing information and the complexity of the land uses found within or in close proximity to the project limits. Where an existing vision is not provided or is insufficient in detail to inform decisions about design controls or alternatives selection, community and stakeholder planning exercises may be useful in informing both the future land use and transportation context.

The following sources are commonly used to establish land use context:

- The Corridor Sketch Database (see [1102.03\(4\)](#))
- Maps and data depicting existing land uses: natural, built and resource lands
- Planning documents (comprehensive plans, corridor plans, sub-area plans, etc.)
- Aerial images and zoning information
- Engagement with local and regional agency planning staff

The type of information sought through the above sources includes:

- Land uses (see [1102.04\(1\)](#)) occurring within and in close proximity to the project limits
- The general form (site design – see [1102.04\(1\)\(a\)](#)) of the built environment
- How the type and form of land uses may vary or transition along a segment
- Regional and local land use goals
- Contextual needs (see [Chapter 1101](#))
- Freight oriented or dependent land uses (see [1102.03\(1\)](#))
- Resource lands and their associated activities and functions
- Lands important to the natural environment (see [1102.02\(3\)\(a\)](#))
- Existing land use characteristics that affect travel and transportation design choices (see [1102.04\(1\)\(a\)](#)).
- Future (or community vision) land use characteristics that affect travel and transportation design choices (see [1102.05\(2\)](#))

1102.02(2) Transportation Context Identification Procedures

Transportation context is comprised of two components in most situations: local and regional travel. Determining the regional and local functions occurring on an existing facility supports performance trade-off decisions and helps in determining how to weight performance trade-offs later in alternative evaluation (see [Chapter 1104](#)). As with land use, transportation context identification relies on close collaboration with WSDOT and local agency planning staff.

The following sources are commonly used to establish land use context:

- The Corridor Sketch Database (see [1102.03\(4\)](#))
- Maps and GIS data depicting the transportation function or characteristics of the existing transportation network
- Transportation and land use plans (Washington Transportation Plan, bicycle plan, transit plans, pedestrian plans, comprehensive plans, limited and managed access plans, etc) that provides information about the transportation function or characteristics of the future transportation network.
- WSDOT Freight Office (see [1102.03\(1\)](#))
- Engagement with local and/or transit agency bike, pedestrian and transit planners and coordinators

The type of information sought through the above steps includes:

- Average trip length, if possible.
- Intermodal connections (Transfer stations, bus stops, ferry terminals, park and ride lots, etc.)
- Aerial images and existing transportation networks
- Type (local or regional) of trips being made and average trip length, when possible
- Existing access connection/approach densities, planned WSDOT access control, and planned local agency access needs
- Existing intersection and street network density
- Local travel mode specific networks
- Freight and Goods Transportation System (FGTS) classification (see [1102.03\(1\)](#) and <http://www.wsdot.wa.gov/Freight/FGTS/default.htm>.)
- Regional and local transportation goals
- Contextual needs (See [Chapter 1101](#))
- Existing transportation characteristics that affect travel and design choices
- Future (and/or corridor vision) transportation characteristics that affect travel and design choices

1102.02(3) Engagement, Collaboration, Recommendations, and Decisions

Ultimately, planning and design efforts both seek to achieve a transportation facility which supports the combined transportation and land use context. The challenge is finding alignment between these two context environments, either for the near-term or future condition. Assist alignment of contexts by employing design elements (see [Chapter 1105](#)) in alternatives (see also [1102.05](#)). Many planning efforts, such as the Washington Transportation Plan ([1102.03\(2\)](#)) and comprehensive plans ([1102.03\(3\)](#)) are intended to help align transportation facilities with their context environments, and should be reviewed during the context identification procedural steps ([1102.02\(1\)](#) and [1102.02\(2\)](#)). Confirm or adjust findings from the procedural steps by learning from prior documented outreach efforts and using community engagement and (see [Chapter 1100](#) and [1102.02\(3\)\(b\)](#)).

Use a consent-based process (see [Chapter 1100](#)), such as a Multiagency, Interdisciplinary and Stakeholder (MAISA) Team to determine whether the existing, transitional, or future context will

be used in design. In some cases, the local agency's plans to transition land uses over time are not fully funded or planned out. In other cases, the baseline need for the project refers to an immediate situation, and is closely related to the existing context conditions. When these situations exist, it may be appropriate to make an early decision to design for the existing context, and focus community engagement on the existing context and contextual needs rather than expending time on a future context.

1102.02(3)(a) Environmental Context and Needs

Discuss the resource lands, built environment, and natural environment with the Region Environmental Office. Environmental constraints are essential components of the project context, are to be included in the Basis of Design under Section 2 as contextual performance needs (see [Chapter 1101](#)). Translate what is known about the environmental conditions or constraints that affect the project using information in the Environmental Review Summary, existing data, agency goals, local policies into contextual needs. Use this information to inform community engagement activities ([1102.02\(3\)\(b\)](#)).

Consideration of both the natural and human environment is required by the National Environmental Policy Act (NEPA) for projects with a Federal Nexus and by the State Environmental Policy Act (SEPA). Disclosure of the potential environmental impacts of a project prior to alternative selection is required to ensure that transportation decision makers have adequately and appropriately considered the consequences. The environmental documentation process and requirements are described in the *Environmental Manual* and supporting web pages (<http://www.wsdot.wa.gov/Environment/sitemap.htm>). A preliminary estimate of the potential impacts begins in Scoping. Documentation of actual impacts is conducted during design and may be iterative as design options to avoid, minimize and mitigate impacts are developed. Environmental permitting addresses unavoidable impacts, including mitigation and best management practices.

1102.02(3)(b) Community Engagement and Context Identification

Engage the public with the findings from the context identification procedural steps, including information about both existing and future conditions, and provide an opportunity for feedback. Consult the region planning office and review WSDOT's Community Engagement (<http://www.wsdot.wa.gov/planning/>) when planning and conducting community engagement activities and document efforts as described in [Chapter 1100](#).

Describe what is currently understood about the context, and engage the community in exercises that will assist in learning more about the existing context and community vision. Most of the initial efforts are intended to fill in gaps about the project teams understanding of the existing context, for completing need identification (see [Chapter 1101](#)).

Comprehensive planning efforts have a legal requirement for engaging and receiving comments from the public, so what is known about the future context should be familiar to the community. However, the future context can also be vague, dominated by overarching policy goals that need to be further interpreted and refined to be useful to designers. In some cases, comprehensive plans will suggest no change from the existing context identification, a determination which should be addressed and confirmed by the project during community engagement. In some cases it will be necessary to establish a local community vision ([1102.05\(2\)](#)) to supplement existing sources of information about future context. Some key outputs from this engagement effort are:

- Validation of the existing and future contexts identified
- Identification of contextual needs (for both the existing and future context, as appropriate(1102.02(3))
- Confirmation of the multimodal network surrounding the project location

1102.02(3)(c) Context Decisions

Provide for consent-based outcomes when determining the land use and transportation context for the project (see [Chapter 1100](#)). When designing for a future context, mitigate uncertainty about the future condition by employing design elements and treatments to the alternatives to align context visions, improving detail in the forecast model, or by working with the local agency to incorporate revisions to land use plans (policies, codes, zoning changes, planned projects within the STIP, etc.) in order to improve confidence in the performance of the outcome. Based on the project's ability or capacity to mitigate it may be reasonable to choose to design closer to the existing context to improve certainty. On Projects of Division Interest (PoDi) and projects on Interstate highways, decisions about context may involve additional approvals (see [Chapter 300](#)).

The decision for what context to design is closely related to design year selection (see [Chapter 1103](#)). Decisions about context and design year are documented on the Basis of Design (see [Chapter 1100](#)).

1102.03 Common Context Information Sources

There are many information sources that planning professionals rely on and will be utilized throughout the context identification phase. Headquarters, regional and local planners have a wide variety of data collection practices, database tools and information resources that are valuable for context identification. Coordination and engagement with planning practitioners is expected, however, the following subsections include a few resources commonly encountered and are relevant to guide a design product.

1102.03(1) Freight and Goods Transportation System

The Freight and Goods Transportation System (FGTS) has a specific classification that can further inform an understanding of context and the selection of modal design controls. This classification is based on the average annual gross tonnage carried. Roadways are classified into five categories:

- T-1 – More than 10 million tons per year
- T-2 – 4 million to 10 million tons per year
- T-3 – 300,000 to 4 million tons per year
- T-4 – 100,000 to 300,000 tons per year
- T-5 – At least 20,000 tons in 60 days

The WSDOT Freight Map (<http://wwwi.wsdot.wa.gov/freight/>) provides FGTS classes. It also provides preliminary information about how freight and land use interactions, including connector freight corridors and the location of specific freight oriented land uses. Understand whether freight vehicles are making turning movements at the nodes along a segment, or whether the majority of freight vehicles are passing through a segment (see [Chapter 1103](#), Intersection Design Vehicle). The freight map also provides information regarding existing mobility performance of the FGTS.

1102.03(2) Washington Transportation Plan

The Washington Transportation Plan (WTP) provides guidance for the development, maintenance, and operation of a comprehensive and balanced multimodal transportation system. The overall direction of the WTP, prepared pursuant to [RCW 47.06](#), is provided by the Washington State Transportation Commission. The WTP covers all major transportation modes and includes:

- Meeting federal requirements.
- Critical factors affecting transportation.
- Important issues concerning each mode and strategies to solve problems or improve function.
- Plans for development and integration of the various modes of transportation.
- Major improvements in facilities and services to meet transportation needs.
- Financial resources required to implement recommendations.

Additional information about the WTP can be found here: <http://www.wstc.wa.gov/wtp/>.

1102.03(2)(a) State Highway System Plan

The State Highway System Plan (HSP) is the highway component of the WTP. The HSP defines service objectives, action strategies, and costs to plan for, maintain, operate, preserve, and improve the state highway system for a duration of 20 years. The HSP is updated every two years, in coordination with local plan updates, to reflect completed work and changing transportation needs, policies, and revenues.

Additional information about the HSP can be found here:

<http://wsdot.wa.gov/planning/HSP>

1102.03(3) Growth Management Act and Comprehensive Plans

Enacted in March 1990, the state's Growth Management Act ([RCW 36.70A](#)) requires cities and counties that meet certain population or growth-rate thresholds to adopt comprehensive plans. Jurisdictions that are required to or choose to plan under the GMA must also adopt and enforce ordinances that implement the policies adopted in the comprehensive plans. Under the GMA, comprehensive plans carry the force of law and require full public participation in their development.

A comprehensive plan is a series of coordinated policy statements and formal plans that direct growth and articulate how a community will be developed in the future. They include elements that address housing, utilities, capital facilities, economic development, land use, and

transportation. GMA planning requires that the transportation element be consistent with and support the land use elements in comprehensive plans.

Continuous coordination and open discussion during the development of local comprehensive plans are key to developing valid plans that direct the growth of a community. Representatives from neighboring jurisdictions, special purpose districts, WSDOT, and others with an interest in future development must be involved at the beginning and throughout the planning process. This is to ensure comprehensive plans are consistent with all other state and local plans.

Local comprehensive plans are important to WSDOT because they influence how state facilities not classified as transportation facilities of statewide significance should be addressed, how state highways will be impacted by local land use, and how access requirements will be met or maintained.

WSDOT seeks to work in partnership with local governments as they develop comprehensive plans to help create a balance between mobility and access needs, while emphasizing design components that improve or maintain community livability. It is also WSDOT's responsibility to review and comment on local comprehensive plans and amendments.

1102.03(4) Corridor Sketch Database

Much of the information needs discussed in [1102.02](#) may be accessed through WSDOT's Corridor Sketch Database. Corridor Sketches have or will be created for identified state highway corridor segments (contact region planning office for more information). The corridor sketches provide a means to catalog information related to planning, operations, modal influences, and past community engagement activities, among many other informational assets. If information is not available or needs to be generated for a specific corridor segment, contact the region planning office.

The outcome of applying practical design procedures may produce changes or more current information relevant to the corridor sketches. Include and update region planning office when applying practical design procedures. Provide a copy of the Basis of Design (BOD) and the community engagement documentation package (see [Chapter 1100](#)) to the region planning office.

1102.03(4)(a) Corridor Sketch Planning

The corridor sketch database has the capacity to not only capture and catalogue existing information, but also may contain some resolution for context identification that may have occurred prior to the design phase. There may be information related to how a local agency plans to alter context overtime, completed community engagement efforts, contextual needs (see [Chapter 1101](#)), strategies (see [Chapter 1100](#)) for the location, and many other types of information.

1102.04 Context Types, Relationships and Key Characteristics

Land use and transportation contexts are interrelated, and when aligned they create the optimal conditions to address the needs of those who use or are affected by the transportation facility. In general, the more urban a location, the more complex and challenging it can be to determine interrelationships and achieve a balance in performance. The following subsections discuss key characteristics and their impact on design control selection (see [Chapter 1103](#)).

1102.04(1) Land Use Types

Land use is correlated to the types of activities and functions that occur within an area (including environmental functions). The eight land use contexts presented in Chapter II-1 of *Understanding Flexibility in Design – Washington* are a starting point for the work described in this chapter, and are:

- Urban Centers
- Urban Corridors
- Suburban Corridors
- Industrial and Manufacturing
- Rural Town Centers
- Rural Corridors
- Residential Areas
- Transitional Areas

Indications for modal and speed compatibility are identified in *Understanding Flexibility in Design – Washington*. Additional speed compatibility is derived from access and intersection spacing within different contexts (see [Chapter 540](#)).

Other land use context descriptions or categorization systems may be used for context identification (for additional information see the guidance document *Context Identification* <http://www.wsdot.wa.gov/Design/Support.htm>.)

Once the land use is described, evaluate the key characteristics, activities, functions, and contextual performance needs. Land use contexts are often complex, involve region planning subject matter experts and local agency partners responsible for jurisdiction of the land use in context identification.

1102.04(1)(a) Key Land Use Characteristics

[Exhibit 1102-2](#) lists key characteristics found in recent research that can affect transportation design decisions. The following subsections provide some additional information related to characteristics shown within [Exhibit 1102-2](#).

1102.04(1)(a)(1) Land Use Centeredness

Centeredness is a land use characteristic that describes the density of employment and residences within a particular area. High employment and residential densities indicate the need to prioritize pedestrian, bicycle, and transit modes in addition to characteristics identified in [Chapter 1103](#).

1102.04(1)(a)(2) Site Design

Site design refers to the configuration and form of the built environment. Site design can affect the perception and behavior of design users traversing an environment, and is an indicator of the type of context. Site design directly affects the accessibility and economic vitality of a location. These performance categories are addressed differently between modes and land uses. For additional general information regarding site design characteristics, see *Understanding Flexibility in Design – Washington*, Division II.

Activity centers are specific site features in the land use. They include public or private land uses developed for recreational or community gathering purposes. Schools, parks, malls, gymnasiums, and senior/community centers, and main streets can also be described as activity centers. The presence of an activity center increases the likelihood of intermodal activity. Even if the activity center is not directly adjacent to the transportation facility being evaluated, it can still have a significant influence on travel and access characteristics of that facility.

Exhibit 1102-2 Key Land Use Characteristics

Characteristic	Design Control	Type of Impact
Residential Density	Modal Compatibility	Higher residential densities indicate an environment that is likely more compatible with transit, bicycle and pedestrian mode choices.
Employment Density	Modal Compatibility	Higher employment densities alone indicate an environment that is likely more compatible with transit services.
Centeredness	Modal Compatibility	The combination of residential and employment density. High degree of centeredness is likely to generate shorter and more frequent trips and compatibility with transit, bicycle and pedestrian modes.
Site Design – Building Scale	Modal Compatibility	The building height-to-width ratio can effects behavior and perception of modal users. The scale of the environment can impact modal compatibility.
	Design Speed	The behavior of drivers is altered in confining environments and will affect the design speed selection. Open environments are more likely to correlate with intermediate or high operating speeds. Sometimes, this condition is inconsistent with needs; see Chapter 1103 for speed management guidance.
Site Design – Setbacks	Modal Compatibility	Building setbacks affect how destinations are accessed and can impact modal compatibility. A built environment with close setbacks is more compatible with the pedestrian mode, and can affect decisions about parking and freight delivery vehicle design. Confined environments with close setbacks also tend to be more compatible with low design speeds.
	Design Speed	
Site Design – Block Lengths (related to network connectivity and density)	Modal Compatibility	Short block lengths are more compatible with the pedestrian and bike modes. Shorter block lengths within a network grid present a variety of routing options and choices, generally resulting in shorter trip lengths.
	Design Speed	Short block lengths (200 to 600 feet spacing) also create more nodes and complexity within the environment, and tend to be more compatible with low design speeds.
	Access Control	Access control will respond to the block lengths for managed access facilities in terms of intersection spacing (see Chapter 540).
Site Design – Streetside/ Roadside	Modal Compatibility	The presence of streetside zones and its configuration can affect modal compatibility. Larger streetside zones environments indicate a higher compatibility with pedestrian and transit modes.
	Design Speed	Whether there is a streetside or roadside (see Chapter 1230) may indicate a consideration for design speed. Streetside and its design features can demonstrate a higher compatibility with low speeds. Where the presence of a roadside environment may be more compatible with intermediate and high motor vehicle speeds.
Site Design – Proximity to Activity Centers	Modal Compatibility Design Speed	The number, type, and distance to the various activity centers can affect the modal compatibility. An increase in the number and decrease in distance to these valued destinations can indicate a higher compatibility with either the transit, bicycle, and pedestrian modes. The type of activity centers can indicate potential vulnerable users and influence decisions regarding design speed selection.

1102.04(2) **Transportation Context Types**

The transportation context is defined by the regional and local trip functions served for a given segment. State highways serve multiple purposes, and may have greater significance to local, regional, or statewide performance needs, depending on numerous characteristics. The six transportation contexts presented in the guidance document – *Context Identification* (see <http://www.wsdot.wa.gov/Design/Support.htm>) are a starting point for the work described in this chapter, and are:

- Interstate
- Freeway
- Expressway
- Arterial
- Collector
- Local

Most of the primary transportation contexts listed above are familiar terms used in the state and federal functional classification systems. However, the characteristics used to define functional classification differ, and are not to be used for the purposes of context identification described in this chapter. Additional information regarding the six primary contexts, including variations on these contexts for more specificity and suggestions for modal and speed compatibility is provided for in the guidance document – *Context Identification*.

1102.04(2)(a) **Key Transportation Context Characteristics**

[Exhibit 1102-3](#) lists key characteristics found in recent research that can affect transportation design decisions. The following subsections provide some additional information related to characteristics shown within [Exhibit 1102-3](#).

Exhibit 1102-3 Key Transportation Characteristics

Characteristic	Design Control	Type of Impact
Network Connectivity	Modal Compatibility	The more connected the multimodal network (the higher the intersection and network densities) the more compatible the environment is for transit, pedestrian and bicycle modes.
	Design Speed	The more closely spaced intersections are, the larger the impact on potential operating speeds and ultimately what is reasonable for design speeds. The denser and closely spaced intersections lower the design speed.
	Access Control	The spacing of access connections/approaches and intersections will impact access control selection (see chapters 530, 540, and 1103).
Proximity to Transit Stops/Centers	Modal Compatibility	Close proximity to transit stop and transfer stations, the more likelihood there is for compatibility with transit, pedestrian and bicycle modes. Depending on the orientation of the transit stops with residential and employment land uses, it could affect the design speed selection of a state route to increase the mobility and safety performance of the pedestrian and bicycle modes crossing or traveling along the route to access the transit stop.
	Design Speed	If the state route is also the transit route, then there is a high compatibility with transit, pedestrian and bicycle modes and low speeds.
Established Limited Access (Full, Partial and sometimes Modified)	Modal Compatibility (Full limited access)	Established full and partial limited access routes are usually maintained for the near exclusive function of regional trips, and are more compatible with motorized vehicle modes (passenger cars, freight and transit modes). These locations are compatible with high speeds, although urban and routinely congested corridors may use dynamic speed limits to adjust operating condition by time of day.
	Design Speed	Established modified limited access locations have simply locked in the existing access controls, and may require use of other characteristics to determine compatibility with design controls. If a location is planned for limited access, verify the limited access plan is consistent with the future land use and transportation contexts, and document on the Basis of Design.
Established Bike Routes	Modal Compatibility	State routes that are also designated as bike routes will have increase compatibility with the bicycle mode. Depending on land use context and travel function of the transportation facility, design speed choices will vary.
Access Connections / Approaches (number and type)	Design Speed	The higher the number and frequency of access connections/approaches, the more compatible the location is with lower speeds (see chapters 530 and 540 for the recommended speeds associated with the type of access control)

1102.04(2)(a)(1) Network Connectivity

Network connectivity describes how the various multimodal facilities within a given area interconnect. Network connectivity is associated with the land use characteristic of block lengths, but is a broader view incorporating the blocks surrounding facility and how modal travel interconnects. The data metrics, street network density, intersection density and proximity to transit stops, can be used to describe the network connectivity as a larger performance measure within a given area, however, in the absence of these metrics intersection spacing can be used.

Most urban places, depending on when development originally occurred (see guidance document *Context Identification* <http://www.wsdot.wa.gov/Design/Support.htm> for more information), have a well-established grid system that enables multiple routing options for all users. This can shorten trip lengths between primary commute destinations and provide more viable travel mode options. The presence of a grid system will benefit both the non-motorized and transit transportation modes, as well as local land use accessibility performance.

Grid systems also allow motorized vehicular traffic to be dispersed across the larger network, rather than forcing all traffic to converge along a single roadway segment. The spacing of block lengths within a grid system can directly affect the mobility performance for the pedestrian and bicyclist modes. However, short block lengths may also impede regional mobility performance depending on intersection control types (see [Chapter 1300](#)) and orientation of the primary regional routes. Discuss the performance trade-offs to best balance the combined modal performance outcomes most compatible with the context identified.

[Exhibit 1102-4](#) shows a well-defined grid system with relatively high network connectivity, and a poorly developed network grid that requires users to converge toward a single roadway segment. A well-defined grid system is likely more compatible with transit, pedestrian and bicycle modes and low motor vehicle speeds. When transit, pedestrian or bicycle modes are not present or planned on the facility under design, it is important to recognize their high compatibility for mobility and safety performance crossing the design facility. Also note that some cities are recognizing the benefits and adaptability of more traditional urban design and may be planning to convert the existing network into a grid, take this into consideration when deciding to design for a transitional or future context, because it may impact the modal priority, design speed and access control selections.

1102.04(2)(a)(2) Established Limited Access Facilities

Access control selection, while a transportation decision, greatly effects how the land use can be developed. Many state highway segments predate land use development expansion, but limited access control was not established to preserve original regional travel function. Highway segments where limited access has not already been established, but is planned, may be at risk of unaligned transportation and land use contexts. For many routes, the plan for limited access was set by Washington State Transportation Commission resolutions in the 1970's. In addition, permitted access connections over time may have changed the access and intersection spacing altering the current managed access classification (see [Chapter 540](#)). These are factors to consider when selecting design speed and access control (see [Chapter 1103](#)).

Established full or partial limited access facilities create a significant context characteristic compatible with high design speeds and motorized vehicle travel modes. Established modified limited access facilities can vary in access and intersection spacing and need to be evaluated for compatibility with design speed and travel modes (see [Chapter 530](#) for more information on limited access control).

Exhibit 1102-4 Network Connectivity Comparison



City of Davenport, WA – Well-established local network connectivity

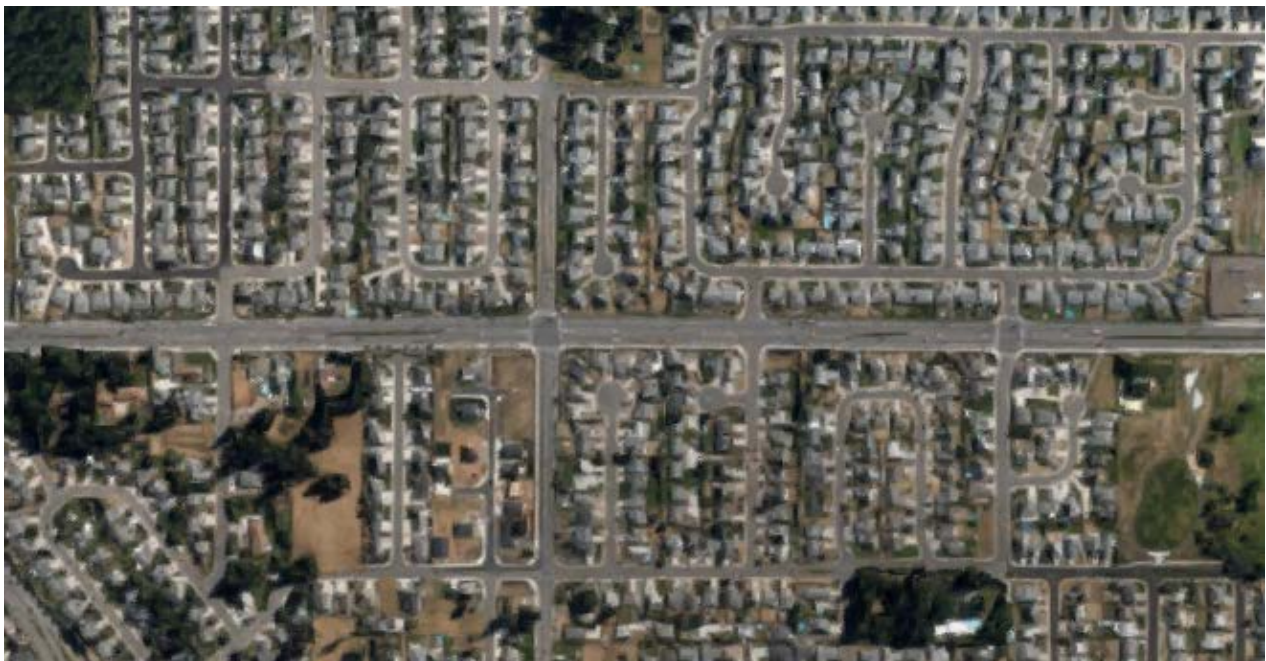

City of Orchards, WA – Poorly established local network connectivity

1102.05 Future Context Identification and Context Transition

Identify the existing and future environments for both land use and transportation contexts. Use this information as a consideration for design year, modal priority, design speed and access control selections (see [Chapter 1103](#)), and to determine the contextual performance needs that will apply to decision-making during alternative formulation and evaluation (see chapters [1101](#) and [1104](#)). Corridor and community visions may not always align, even if the visions are well defined and established, and may need to be balanced through an understanding of acceptable performance trade-offs and use of countermeasure or other treatments. When designing for a future context that differs from the existing context, provide for a transition of design features compatible with both existing and future contexts considerations. In some cases, consider employing streetside design elements and speed management treatments (see [Chapter 1103](#)) to mitigate for the current absence of future site design features in order to achieve desired geometric design outcomes to help support the land use context transition.

The relative merits of project alternatives are measured in comparison to the corridor and community visions, when designing for the future context. When the land use and transportation contexts are not aligned, there is a sustainability risk for the alternatives and possibly unintended performance outcomes..

1102.05(1) Corridor Vision

The corridor vision is the future transportation context from a regional perspective. A corridor vision is not focused on the specific details of a smaller project segment within the corridor, but considers interconnections to multiple jurisdictions and regional highway contextual performance needs. However, the regional contextual needs and location-based contextual needs resulting from a community vision (see [1102.02\(1\)](#)) are useful in performance trade-offs analysis that supports alternative formulation and evaluation (see [Chapter 1104](#)).

Many initial corridor visions have been developed and are represented within the corridor sketch database (see [1102.02\(2\)](#)). Work with the regional planning office, MPO's, RTPPO's and local agencies to confirm the shared understanding of existing corridor vision. Collaborate with partners to engage the community about the corridor vision (this can occur separately or combined with community visioning exercises, if conducted).

1102.05(2) Community Vision

The community vision describes the future land use and may contain aspects about the transportation context. Establishing the vision helps build consensus and leads to enhanced project decision-making. Determine the community plan in sufficient detail such that the design process can reasonably proceed with the formulation and evaluation of alternatives based on contextual needs (see [Chapter 1101](#)) identified by a community plan. Use WSDOT and local agency partnerships to conduct community planning exercises can improve an understanding of how to optimize operation of the existing system, and how to implement operational, off-system and demand management strategies by maximizing the shared network and funding needed for implementation.

Funding limitations may constrain the ability to construct the ultimate vision. Partners should discuss and plan for interim phasing solutions to address fiscal constraints, ultimately adapting the vision incrementally and over time. The resulting partnership funding plans will assist with phasing the ultimate vision, and can use lower-cost retrofit design options such as striping new

“curb” locations inward (See [Chapter 1230](#) for additional discussion on retrofit options). Discuss and develop an understanding of shared maintenance responsibilities with partners, especially when phased and/or retrofit design options (see [Chapter 301](#)) are considered in alternative formulation (see [Chapter 1104](#)).

Comprehensive, subarea, and neighborhood plans as well as local complete streets policies are examples of documents that will provide value in determining the vision. Depending on the route and focus of these plans, the detail of provided information may vary. It is important to understand the complete network, where multimodal emphasis areas may be including intermodal connections and designated routes to those connections. There could be specific route visioning or, at a minimum, broader visioning statements for the local agency as a whole found within various planning documents. Note that information in these plans and policies will also contribute to establishing the future transportation context (see [1102.05\(1\)](#)).

For some projects, the community’s vision for the street segment may not have been established by prior planning activities or through legislative action. Where this is the case and when the future context is being considered for design, a community vision may be identified before or during the design phase of project development with the community. Work the regional local programs office and/or planning office, and consider the following steps (summarized from *How can Cities and Counties Plan for all Transportation Modes?* <http://www.wsdot.wa.gov/planning/community/GMA.htm>) when working to establish a vision:

1. Invite Partners – Include both jurisdictional agencies and stakeholders
2. Adopt Goals – Develop goals regarding the complete multimodal network
3. Select Performance Metrics – Choose metrics that balance the goals and help guide investment decisions, these will be used as baseline or contextual needs depending on the nature of the project (see [Chapter 1101](#))
4. Map Existing Infrastructure and Collect Data
5. Identify strategies

1102.06 Additional Context Considerations

A number of other context characteristics exist that can influence the selection of design controls. The following list of characteristics provide explicit information to consider when selecting subsequent design controls:

- **Main Streets:** Specific highway segments that serve the aesthetic, social, economic, and environmental values in a larger community setting in addition to transportation.
- **Additional Freight Considerations:** Specific highway and local segments may have special freight needs that are indications of the type of context.
- **Right of Way:** The available or reasonably obtainable width of publicly owned space.
- **Emergency Service Centers and Routes:** The presences of emergency services and their identified routes may create a special modal compatibility along the state route or at nodes.

- **Jurisdictional Responsibilities:** When a state route passes through a city, WSDOT typically holds jurisdictional authority on the traveled way, between and including the curbs. The local agency holds jurisdictional authority over the streetside, from the back of curb outward (including between curbed median areas). See chapters [1230](#) and [1600](#) for more information.

1102.06(1) State Highway Main Streets

State highways that also function as city streets are challenged to provide important local functions while balancing the appropriate regional mobility performance. State highway main streets are a specific variation of state highways that function as city streets. State highway main streets are common within rural town centers, but are also found in suburban and urban settings. A main street segment is typically several blocks in length but not more than a mile, and often referred to as the “heart” of a community emphasizing livability performance. State Highway Main Streets are typically a social and retail center of a community. These locations have a high compatibility with the pedestrian mode, and target a 25 mph speed.

1102.06(2) Additional Freight Considerations

Routes that routinely carry over-height and/or overweight (OHOW) vehicles, and where the transport of hazardous materials is permitted, may need additional geometric design considerations not only at intersections, but along segments. Identification of these specific user groups may affect design element and dimensioning choices later in design (see chapters [1105](#) and [1106](#)) to meet modal performance needs. Identify routes used to transport OHOW and hazardous materials and identify these vehicles as specific design users (see [Chapter 1103](#)), and coordinate with HQ Freight Office to determine the performance needs for these user types.

Freight accessibility to the land use it serves is a complex activity to consider within the geometric cross section (see [Chapter 1230](#)). This is of particular importance in urban centers, suburban commercial, rural commercial and rural town center land uses. Loading and unloading freight deliveries can occur differently depending on the type of truck. Work with business and freight carriers to ascertain loading and unloading needs, if possible. Whether a delivery vehicle loads from the side or back can alter the configuration or size of the loading zone and placement of streetside features.

1102.06(3) Right of Way

Right of way can be a significant concern in designing the facility and in the selection and sizing of design elements. Generally, right of way becomes much more of a controlling factor within urban- and suburban-type land use contexts, where either space constraints, community impacts, or the cost of land acquisition and access rights is prohibitive. Consider the interaction between geometric design elements and design speeds, and how selection between either can influence performance outcomes relative to the cost of right of way acquisition.

Avoiding acquisition of right of way generally provides a benefit to both the cost and schedule of alternatives. Provide a right of way width sufficient to accommodate roadway elements and appurtenances for the proposed alternative. Consider the needs of maintenance and construction activities. See [Chapter 510](#) for more information on right of way considerations and [Chapter 301](#) for additional maintenance considerations.

1102.06(4) Emergency Service Centers and Routes

Hospitals, fire stations and other emergency services have unique needs to provide timely services to their customers. Coordinate with EMS providers on all projects. Identify current routes and critical service needs and analyze the impacts or benefits. If necessary, work with EMS providers to determine contextual needs and explore additional improvements that will maintain or enhance the service times or other contextual performance needs.

1102.07 Documentation

Capture decisions made within the Basis of Design (BOD) in Section 2 to document decision-making and conclusions associated with context identification.

1102.08 References

1102.08(1) Federal/State Directives, Laws, and Codes

23 Code of Federal Regulations (CFR) 450, Subpart B, Statewide Transportation Planning

23 CFR 450, Subpart C, Metropolitan Transportation Planning and Programming

23 United States Code (USC) 134, Metropolitan Planning

23 USC 135, Statewide Planning

[Revised Code of Washington \(RCW\) 35.58.2795](#), Public transportation systems – Six-year transit plans

[RCW 35.77.010\(2\)](#) and [RCW 36.81.121\(2\)](#), Perpetual advanced six-year plans for coordinated transportation program expenditures – Nonmotorized transportation – Railroad right-of-way

[RCW 36.70A](#), Growth management – Planning by selected counties and cities

[RCW 43.21C](#), State environmental policy

[RCW 47.05](#), Priority programming for highway development

[RCW 47.06](#), Statewide transportation planning

[RCW 47.06B](#), Coordinating special needs transportation

[Secretary's Executive Order 1028](#) – Context Sensitive Solutions

[Secretary's Executive Order 1090](#) – Moving Washington Forward: Practical Solutions

[Secretary's Executive Order 1096](#) – WSDOT 2015-17: Agency Emphasis and Expectations

1102.08(2) Supporting Information

Understanding Flexibility in Transportation Design – Washington, WA-RD 638.1, WSDOT, 2005
🔗 <http://www.wsdot.wa.gov/research/reports/600/638.1.htm>

Smart Transportation Guidebook, New Jersey Department of Transportation and Pennsylvania Department of Transportation, 2008.
🔗 <http://www.state.nj.us/transportation/community/mobility/pdf/smarttransportationguidebook2008.pdf>

Measuring Sprawl 2014, Smart Growth America, Washington D.C., 2014
🔗 <http://www.smartgrowthamerica.org/measuring-sprawl>

The Innovative DOT: A Handbook of Policy and Practice, Smart Growth America, Washington D.C., 2015 🔗 <http://www.smartgrowthamerica.org/the-innovative-dot>

Land Use and Regional Planning: Achieving Integration Between Transport and Land Use, European Commission, 2006
🔗 http://www.transport-research.info/Upload/Documents/200608/20060831_102457_87241_Land_use.pdf

Urban Street Design Guide, National Association of City Transportation Officials, New York, NY, 2013 🔗 <http://nacto.org/>

Designing Walkable Thoroughfares: A Context Sensitive Approach, Institute of Transportation Engineers, Washington D.C., 2010
🔗 <http://ecommerce.ite.org/IMIS/ItemDetail?iProductCode=RP-036A-E>

Livability in Transportation Guidebook: Planning Approaches that Promote Livability, FHWA, 2010 🔗 http://www.fhwa.dot.gov/livability/case_studies/guidebook/

Evaluating Transportation Land Use Impacts, Victoria Transport Policy Institute, 2015
🔗 <http://www.vtpi.org/landuse.pdf>

1103.01	General Overview
1103.02	Control: Design Year
1103.03	Control: Modal Priority
1103.04	Control: Access Control
1103.05	Control: Design Speed
1103.06	Control: Terrain Classification
1103.07	Documentation
1103.08	References

1103.01 General Overview

Design controls are specific design elements that directly influence or are used to assist in the selection of most other design elements and their dimensions. As such, design controls establish fundamental boundaries for design alternatives. This chapter provides guidance on the selection of design controls for state routes.

The five WSDOT design controls include:

- Design year
- Modal priority
- Access control
- Design speed
- Terrain Classification

Exhibit 1103-1 shows reciprocal connections between design controls and land use and transportation contexts.

Exhibit 1103-1 WSDOT Design Controls

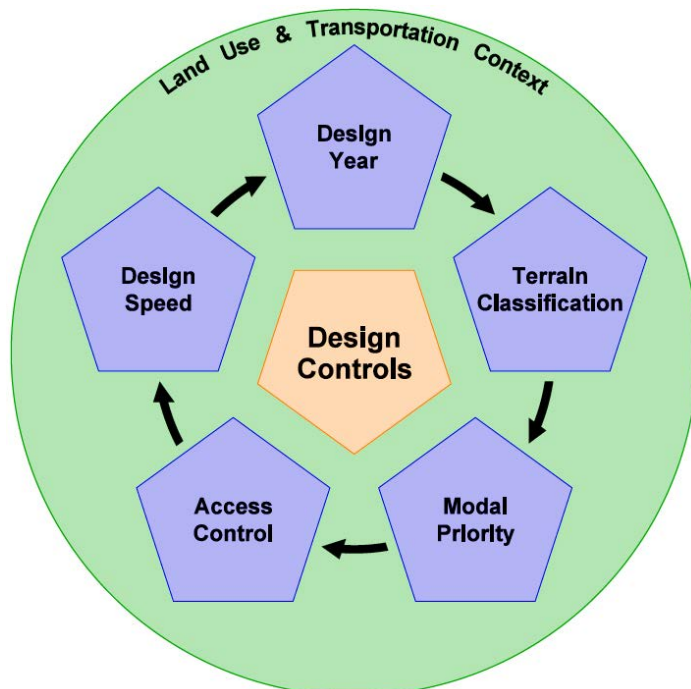

1103.02 Control: Design Year

The **horizon year** for planning and design is typically considered to be 20 years from the year construction is scheduled to begin.

Design year is the forecast year used for design. Design year selection is dependent on a decision to design for the current or future context (see [Chapter 1102](#)). The specific baseline performance metric(s) being considered can also affect the design year selection. Design year can be any interim year selected between the current year up to the horizon year. Environmental documentation or federal-aid projects may require horizon year analysis of an alternative regardless of the selected design year.

Future scenarios are typically developed from predictive travel demand models. When evaluating future scenarios, verify that the modeling assumptions are reflective of planned land use, operations, and facility needs at the forecast year. Sensitivity analysis is sometimes used to test a range of assumptions, their values, and the model limitations. The decision to include or exclude horizon year alternatives and analyses for other transportation contexts other than those described in [1103.02\(1\)](#) is documented through the Basis of Design (see [Chapter 1100](#)) document.

1103.02(1) Interstate Projects and Projects of Division Interest

All Interstate highway projects incorporating new construction are to evaluate alternatives for the horizon year to be compliant with [23 USC § 109](#). These Interstate projects are expected to provide satisfactory performance for the identified performance metric(s) in the horizon year. However, modification or reconstruction of the Interstate does not necessarily drive the need to evaluate alternatives for the horizon year, if the appropriate approvals have been obtained. For Interstate new and reconstruction projects or those deemed Projects of Division Interest (PoDI), obtain FHWA approval for design controls using the Basis of Design (see [Chapter 1100](#)) form. See [Chapter 300](#) for guidance related to FHWA oversight and approvals.

1103.03 Control: Modal Priority

Modal priority is the recognition of multimodal capacity in relation to context. It acknowledges and incorporates modal compatibilities, design users, and intersection design vehicles. These are each discussed further below. Modal priorities are primarily selected based on the outputs from the modal compatibility assessment (see [1103.03\(3\)](#)), the baseline and contextual performance need(s), community engagement, and identified planning strategies. This collaborative decision is an important milestone and is necessary to support the subsequent design control and design element analysis decisions. More than one modal priority may exist for a project based on variation in context.

A project's legislative intent may override modal priority selection when it differs from modal compatibility (see [1103.03\(3\)](#)) outputs. However, project teams are encouraged to work with program management staff if when there is a difference between modal priority outputs and legislative intent to explore change management opportunities.

1103.03(1) Design Users

"Design users" refers to users of all modes that may use and are legally permitted on a highway segment or node. The intent in identifying design users is to highlight all user needs, recognize

modal interactions, and develop an integrated system for all users. List design users with sufficient descriptive detail, such as “commuter” and/or “recreational bicyclists” rather than just listing “bicyclists.”

Division III of the document Understanding Flexibility in Transportation Design – Washington (www.wsdot.wa.gov/research/reports/600/638.1.htm) is a key resource for understanding the needs and characteristics of various design users. This document also provides conceptual guidance for the application of context sensitive solutions in the project development process, and provides a compilation of issues for evaluation in highway design. The intent is to offer information and tools to increase understanding of how the different user issues are interrelated, and how understanding this interrelationship leads to better decision-making during the evaluation and optimization of trade-offs.

1103.03(2) Intersection Design Vehicle

An intersection design vehicle is a specific selection made at each intersection. The intent in selecting an intersection design vehicle is to allow the largest vehicles commonly encountered to adequately complete a required turning maneuver. Frequency of the design vehicle, impacts to other design users, and specifically pedestrian crossing distance and times are also considered. The objective is not necessarily to size the specific intersection curb radius (unless there is a baseline need associated with the larger vehicles), but rather to account for a reasonable path to accommodate the large vehicle turning maneuver. Use turn simulation software (such as AutoTURN®) to analyze and decide on what is necessary to support turning movements.

Example: An intersection at a location identified as a pedestrian mode priority may experience infrequent turning movements by a WB-67. Because of the pedestrian priority and needs, a smaller curb radius would provide benefit with shorter crossing times and reduced exposure to vehicles. Using turn simulation software, a graphical display of the various turning movements is created. Based upon those turning movements, a practicable path for the larger vehicle can be identified, even though intrusion into the second same direction lane or painted median may be necessary. The infrequency of use by a WB-67 indicates that the intersection design may be appropriate given the pedestrian benefit.

Conversely, if the crossroad was identified as a Connecting Freight Corridor, with frequent turning movements from larger vehicles, then it would be appropriate to size the intersection to prevent the second lane incursion.

It is important to determine the local origins and destinations of large vehicles to strategically plan to accommodate their uses at specific intersection locations, and also to consider alternatives that may help lower turning speeds and pedestrian exposure. Planners and designers need to work with stakeholders, businesses, and service providers to understand their needs (like school bus and emergency vehicle movements) in order to define the frequency of use at specific intersections. Municipalities may have established truck routes or specific restrictions that govern local freight patterns or time of day delivery narrowing the possible locations that will focus on larger intersection design vehicles. The purpose of providing flexibility related to the intersection design vehicle is to balance the design for the users and modes of the corridor, as well as to avoid the unnecessary expense of oversizing intersections.

1103.03(3) Modal Compatibility

Modal compatibility is the identification of modes most compatible within an identified context environment. Compatibility is a function of the combination of land use and transportation characteristics, as well as an understanding of the performance needs at a location. Exhibit 1103-2 shows the association of context characteristics with different design user groups.

Exhibit 1103-2 Key Context Characteristics and Modal Compatibility

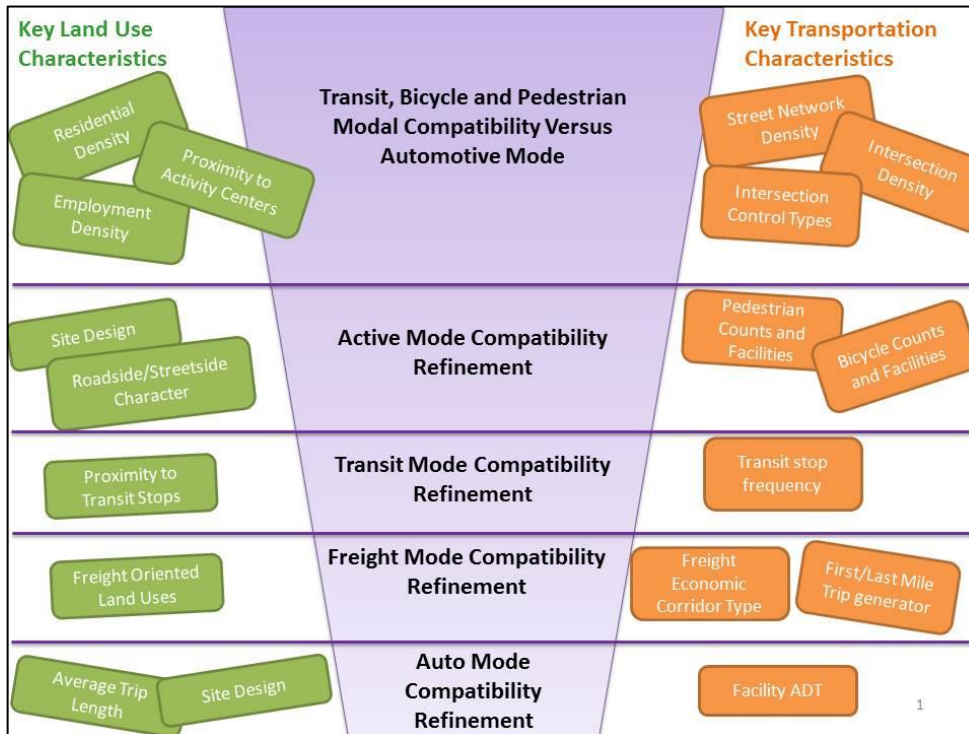

Modal compatibility is not only determined based on the volume of a given modal user group existing on a corridor segment. Modal compatibility may change over time, as land use and transportation characteristics change, so it is critical to identify whether the existing context or a future vision of that context is the basis for the design.

WSDOT’s goal is to optimize existing system capacity through better interconnectivity of all transportation modes. Consideration of modal compatibility over time allows different investment scenarios in a particular mode for a given context to be evaluated. Exhibit 1103-3 is an example of a modal compatibility assessment for a specific context.

Exhibit 1103-3 Modal Compatibility Assessment Example

Land Use Characteristic	Modal Compatibility
High proximity to activity centers	Pedestrian, Transit, Bicycle
Large number of industrial and commercial land uses in surrounding area	Freight
High densities of both residential and employment	Bicycle, Pedestrian, Transit
No or minimal building setbacks adjacent to roadway	Pedestrian
Human scale architecture present	Pedestrian, Transit
Transportation Characteristic	Modal Compatibility
Large number of accesses	Auto
Well-established grid network	Bicycle, Pedestrian, Transit, Auto
T-2 freight route	Freight
Streetside elements present	Pedestrian, Transit
Frequent signalized intersections along route	Auto, Transit, Pedestrian

1103.04 Control: Access Control

Access is a critical component informed by an understanding of the contextual characteristics. Access is the primary connection between the land use and transportation contexts. The type of access control selected (see [Chapter 520](#)) affects accessibility and impacts the types of activities and functions that can occur on a segment. It is important for mobility and economic vitality projects to consider whether the current access classification and/or planned access classification conforms to the context selected for design (see [Chapter 1102](#)).

During development of the state highway system, access management functioned to preserve the safety and efficiency of regional highways. However, the level of access management can also significantly affect accessibility to land uses and, in turn, the various modal mobility needs and economic vitality of a place. It is necessary to select the appropriate type of access during planning and design. However, if access control has been established by purchase of access rights, this evaluation and selection is not necessary.

A choice to change the current or planned access control is a major decision and is to be consistent with the contextual information, desired performance targets, and modal priorities for a location.

Example: A managed access Class 2 route has incurred significant development in adjacent and surrounding parcel uses, increasing the number of local trips made on a segment of the route. Over time, additional intersections and access connection permits were granted. In this situation, it may be more appropriate to consider selecting managed access Class 4 or 5 because of the alteration in functions and activities along that segment over time.

Conversely, a route may have a need oriented around improving motor vehicle travel time performance, and managed access Class 1 is selected to assist in achieving that modal priority performance need. In this situation, the access helps to control features within the design consistent with the need, context, and modal priority.

If an alteration to current or planned access is determined necessary, consult the Development Services and Access Manager for preliminary approval for the selection, and document on the Basis of Design form (see [Chapter 1100](#)). For additional information on access control and access management, see Chapters [520](#), [530](#), and [540](#).

1103.05 Control: Design Speed

WSDOT uses a target speed approach for determining design speed. The objective of the target speed approach is to establish the design speed at the desired operating speed. The target speed selection is derived from all other design controls presented within this chapter, as well as transportation and land use context characteristics. The target speed approach exercises the connection that's been found in research and through experience between operating speed, design controls, and context characteristics.

Engage the public and local agency staff and officials prior to selecting the target speed. Once the target speed is selected, it becomes the design speed for the project. The goal of the target speed approach is that the speed ultimately posted on the completed project is the same as the design and ultimately the operating speed. In order to achieve this outcome, consider the impact of existing or proposed contextual characteristics, modal priorities, access control selection, performance need(s), and contributing factors analyses that have been developed for the project (see [1103.03\(3\)](#), [1103.04](#), and Chapters [1101](#), [1102](#), and either [530](#) or [540](#), as appropriate).

When selecting a target speed that is lower than the existing posted speed, or where excessive operating speeds were identified from contributing factors analysis of the baseline performance need, consider the use of roadway treatments that will help achieve the selected target speed (see [1103.05\(2\)](#)) during alternatives formulation. When selecting a target speed in excess of the existing posted speed, measures such as greater restriction of access control and segregation of modes may be necessary to reduce conflicts in activities and modal uses. Use caution when basing a target speed on one or more contextual characteristics that are proposed to take place after project opening, as the goal of ending up with a posted speed equal to the design speed at opening may be jeopardized.

Concurrence of the Region Traffic Engineer is required when speed management treatments are proposed to accomplish a desired target speed operation. When a design speed is proposed and assumed for a project or project segment that is lower than the existing posted speed, the approval of the State Traffic Engineer is also required.

The region Traffic Engineer is responsible for setting the posted speed on the highway once the project is completed. Because target speed is only one of the considerations used when establishing posted speed, and achieving a posted speed that is equal to the design speed is critical to project success, engage and include the region Traffic Engineer and Traffic Office staff in key decision-making that will affect the design speed selection.

1103.05(1) *Low, Intermediate, and High Speeds*

To provide a general basis of reference between target speed and geometric design, three classifications of target speed have been established:

1. **Low Speed is 35 mph and below.** A low target speed selection is ideal for pedestrian and bicycle modal oriented environments. Transportation contexts that include frequent transit stops, intermodal connections, moderate to high intersection density, or moderate to high

access densities may also benefit from lower speed environments. Land use contexts compatible with these modes or serving commercial and/or residential densities may also benefit from a low target speed selection.

2. **Intermediate Speeds are 40 mph and 45 mph.** Intermediate target speed selection is ideal for speed transitions between high and low target speed environments. Transportation environments with low access densities and few at-grade intersections are also examples of where intermediate speed may be appropriate. Consider a higher degree of modal segregation between non-motorized and motorized modes.

Example: Separated buffer between the traveled way and bicycle lanes. Land use contexts such as rural commercial or suburban connector contexts may benefit from intermediate speed selection, whereas higher-density suburban residential or commercial contexts may not be appropriate for intermediate target speeds.

3. **High Speed is 50 mph and above.** High-speed environments are ideal for Interstate and expressway transportation contexts oriented to motorized vehicular modes, and regional or longer-distance local trips. Consider the highest level of segregation and protection between motorized and non-motorized modal users in multimodal environments with a high target speed selection. Rural connector land use contexts with infrequent farm or residential accesses are consistent with the use of high target speeds.

Corridors with inconsistent land uses occurring in close succession may benefit from selecting a single target speed that will limit the speed variance between vehicles, providing for reliable, adequate mobility while limiting potential undesirable impacts to other modes. Selection of target speed provides for optimization of different modes of travel while providing adequate mobility throughout a given location. This selection will avoid repeated changes to driver expectations and multiple speed transition segments in close succession. Speed management treatments may be necessary to provide driver information that maintains a constant target speed within these corridors.

1103.05(2) *Speed Management*

Speed management is necessary within many highways to achieve an optimal multimodal transportation environment that will support the land use and transportation contexts. Speed management may also be necessary to maintain consistent or desired speeds between adjacent roadway segments. Design speed transition segment(s) as necessary to achieve desired speeds. Identify the appropriate milepost limits that include potential speed transition segments when scoping the project.

1103.05(2)(a) *Speed Transition Segments*

Include a speed transition segment where there is a need to obtain a target speed lower than the existing operating speed. A speed transition segment is not needed where existing operating speeds are within 5 mph of the target speed for a given location. Carefully locate the speed transition segment. The transition segment may not always directly precede the speed zone segment as shown in [Exhibit 1103-4](#).

Example: A residential segment could benefit from introducing a speed transition segment farther upstream to increase the likelihood that approaching vehicles operate at the desired speed, for both segments.

The speed transition segment may incorporate a variety of treatments that alert motorists to a changing roadway environment. These treatments are intended to narrow driver focus and/or affect driver decision-making on that segment. Consider the transition segment location and length when providing multiple treatments in a short distance.

Exhibit 1103-4 Speed Transition Segment Example

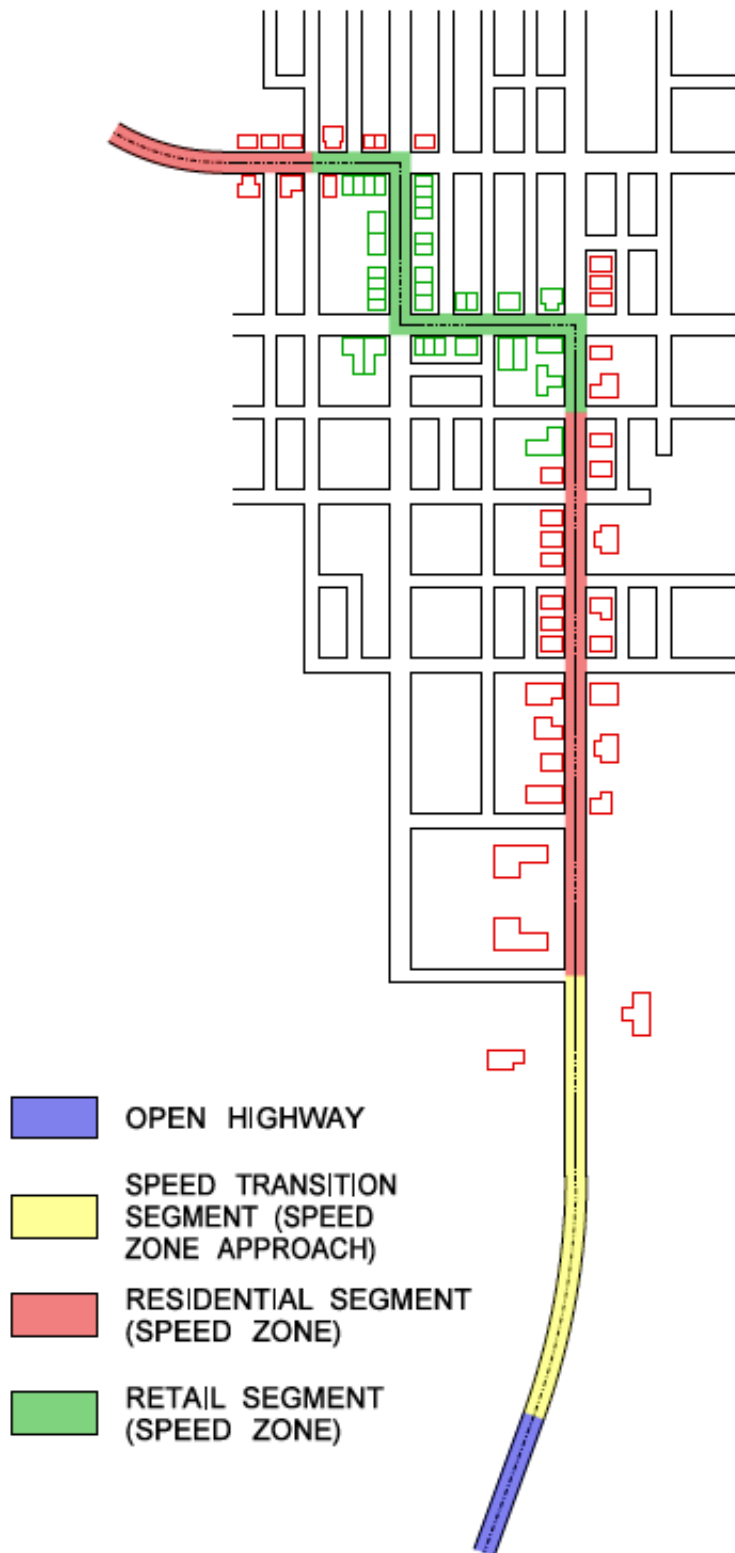

1103.05(2)(b) Speed Reduction Traffic Calming Treatments

Traffic calming treatments can serve a variety of purposes, from deterring higher volumes of motorized traffic to providing speed management. This section presents traffic calming treatment options to increase the reliability of reducing vehicular speed. Speed reduction traffic calming treatments applied independently or in combination may be beneficial depending on the type and use of the treatments. Many speed management treatments have demonstrated varied effectiveness for single applications. Multiple treatments in series and parallel that build upon the context characteristics are more effective. Contact the Headquarters Design and Traffic offices for any project implementing a speed transition segment, for assistance on selection and monitoring of treatments.

Speed management techniques vary and have different results depending on the speed and types of users at a given location. The following subsections present different options for speed-reducing traffic calming treatments.

1103.05(2)(b)(1) Geometric Treatments

Geometric treatments can include overall changes of the horizontal or vertical geometry to introduce features that will support maintaining the targeted speed. Exhibit 1103-5 shows geometric traffic calming treatments and potential considerations when selecting these types of treatments.

1103.05(2)(b)(2) Roadside and Pavement Treatments

There are a number of treatments that create an environment that influences human factors and perception. Many successful roadside treatments use landscaping in an attempt to achieve the desired behavioral effect. It is important to coordinate with project partners to evaluate landscaping features and provide for traveled way operations and sight lines. The introduction of roadside features like trees, parking, and/or bicycle lanes to alert travelers to a change in conditions may be appropriate. Applying features like vegetated medians or trees is appropriate at some locations and contexts. In landscaping discussions, include Traffic Engineers, Maintenance, Urban Forestry, Landscape Architects, and Human Factors and Safety Experts. If the landscaping proposed is in a managed access segment with local jurisdiction responsibility for the roadside, coordinate to understand the jurisdictions' capabilities to sustain the landscaping and that it meets their clear zone goals.

Pavement-related treatments can also produce undesirable impacts on other users. For pavement treatments, include Materials Engineers, Maintenance, and ADA Compliance Experts to review what sustainable and effective treatments can be employed.

[Exhibit 1103-6](#) lists roadside and pavement-oriented traffic calming treatments and considerations to evaluate when selecting the appropriate treatments.

Exhibit 1103-5 Geometric Traffic Calming Treatments and Considerations

Treatment	Considerations
Taper for Narrow Lanes	Narrowing the lane width can be achieved by restriping lane lines. A decision to taper in or out may depend on other treatments planned, such as introducing a median or chicanes. Base taper rates on the target speed entering the context or speed transition segment, as appropriate. It is recommended that this be the first treatment employed.
Chicanes/Lane Shifts	This treatment may be achieved with curbed features, like planter strips or striping combined with additional fixed delineators. These treatment types are more appropriate when reducing speeds from an initial intermediate speed or less. When introducing this treatment with initial high speeds, the treatment should utilize paint striping, in addition to using other treatments preceding the chicane/lane shift, rather than constructing hardscape features.
Pinch Points	Applies on intermediate to low target speed situations unless completed with striping or other pavement markings. This treatment uses striping, roadside features, or curb extensions to temporarily narrow the vehicle lane. It is likely more appropriate for maintaining a desired target speed within a segment than as part of a speed transition segment. Pinch points are not appropriate for high-speed segments. Use of pinch-point treatments on intermediate speed segments requires concurrence from the Region Traffic Engineer.
Speed Cushion/Humps/Tables	On state highways, this treatment will likely have limited application, but should not be excluded from consideration. Impacts to freight, transit, and emergency service vehicles need to be evaluated prior to selecting these vertical types of treatments. These treatments may only be used when maintaining a 25 mph target speed within a segment.
Raised Intersections	Raised intersections, similar to other vertical treatments, will have limited application on state highways. This treatment typically has higher costs to construct due to the pavement needs. This treatment may be a good option when a roundabout cannot be accommodated at a narrow intersection. It can also be considered where there is a need to improve visibility of the intersection and modal conflicts, especially at problematic stop control intersections planned to remain in place. This treatment may only be used when maintaining a 25 mph target speed within a segment.
Roundabouts	Roundabouts can be a unique feature, providing reduced serious injury collision potential, traffic calming, and gateway functions. (See Chapter 1320 and the <i>Roadside Policy Manual</i> for details on roundabout design,) Roundabouts are effective from a collision reduction and operational perspective, and they provide reduced driver workload, lower speeds, and limited conflict points. They can assist with access management or when turning movements are limited or restricted on a segment. To determine if a roundabout is appropriate at a specific location, follow the Intersection Control Analysis process described in Chapter 1300 .

Exhibit 1103-6 Roadside, Streetside, and Pavement-Oriented Traffic Calming Treatments

Treatment	Considerations
Landscaping	Landscaping can be used in conjunction with other treatments to reinforce the surrounding context and the driver's perception of the context. It can also provide width for modal separation. Annual maintenance impacts need to be considered, weighed, and documented prior to selecting types of vegetation to be included.
Raised Vegetated Medians	Introduce a raised vegetated median following other treatments that prepare the driver for this feature. Appropriate for low to intermediate target speed locations and transition segments.
Transverse Rumble Strips	These in-lane rumble strips are intended to alert drivers to a condition change. They are likely placed in conjunction with and prior to traffic signing revisions or in advance of other speed-reducing traffic calming treatments. Appropriate for high, intermediate, or low target speed locations and transition segments.
Optical Speed Markings	This treatment is intended to influence a driver's perception. The treatment consists of 8-inch transverse paint strips within the vehicular lane extending from lane markings (or curb). The striping intervals sequentially decrease, providing the perception of increasing speed, an indication to drivers to slow their operating speed. Optical Speed Markings are ideal for speed transition segments, and are recommended to be applied in conjunction with lane narrowing. Appropriate for high or intermediate target speed locations and transition segments.
Dynamic Warning Systems	This treatment consists of actively alerting motorists about their operating speed. There are many different systems that accomplish this, including portable radar trailers and post-mounted systems. These can be either permanent or temporary installations. Appropriate for all speeds.
Gateways	The intent of a gateway feature is to alert travelers to a context change. A gateway feature is typically found on the edge of cities or towns, but can be used to highlight specific segments within cities or towns. The gateway can be anything from a banner/structure spanning the facility, to artistic work, landscaping, and/or a roundabout at the first intersection approaching a defined environment context. The gateway feature should be developed by the community. It may be of interest to design a gateway feature fitting the cultural and historic character of the location. Consideration for potential fixed object collisions is an important aspect of gateway design. Gateway features that span or are placed within state right of way will need specific approvals, as identified in Chapter 950 . Appropriate for low to intermediate target speed locations and transition segments.

1103.06 Control: Terrain Classification

Terrain may limit operational and safety performance for particular modes. While terrain impacts may be addressed at specific locations, it is not cost beneficial to modify terrain continually throughout a corridor. The type of terrain, context, and speed influence the potential operating conditions of the highway, and should be a consideration when selecting mobility performance targets (See [Chapter 1101](#)). For more information on grades, see [Chapter 1220](#).

To provide a general reference between terrain and geometric design, three classifications of terrain have been established:

1. **Level:** Level to moderately rolling, this terrain offers few or no obstacles to the construction of a highway having continuously unrestricted horizontal and vertical alignment.
2. **Rolling:** Hills and foothills, with slopes that rise and fall gently; however, occasional steep slopes might offer some restriction to horizontal and vertical alignment.
3. **Mountainous:** Rugged foothills; high, steep drainage divides; and mountain ranges.

Designate terrain as it pertains to the general character along the alignment of a corridor. Roadways in valleys or passes in mountainous areas might have the characteristics of roads traversing level or rolling terrain and are usually classified as level or rolling, rather than mountainous. See the [Highway Log](#) for terrain classification.

1103.07 Documentation

Document selections for design controls in Section 3 of the Basis of Design (BOD). For interstate new/reconstruction projects or Projects of Division Interest (PoDI), obtain FHWA approval on the Basis of Design, in addition to other approvals noted in [Chapter 300](#).

1103.08 References

1103.08(1) Federal/State Directives, Laws, and Codes

[Secretary's Executive Order 1090](#) – Moving Washington Forward: Practical Solutions

[Secretary's Executive Order 1096](#) – WSDOT 2015-17: Agency Emphasis and Expectations

[Secretary's Executive Order 1028](#) – Context Sensitive Solutions

1103.08(2) Supporting Information

Designing Walkable Thoroughfares: A Context Sensitive Approach, Institute of Transportation Engineers, Washington D.C., 2010 www.ite.org

A Policy on Geometric Design of Highways and Streets (Green Book), AASHTO, Washington, D.C., Current Edition www.transportation.org/Pages/Default.aspx

Urban Street Design Guide, National Association of City Transportation Officials, New York, NY, 2013 www.nacto.org

Understanding Flexibility in Transportation Design – Washington, WA-RD 638.1, Washington State Department of Transportation, 2005

www.wsdot.wa.gov/research/reports/fullreports/638.1.pdf

NCHRP Report 613 – Guidelines for Selection of Speed Reduction Treatments at High Speed Intersections, Transportation Research Board, Washington D.C., 2008

🔗 http://onlinepubs.trb.org/onlinepubs/nchrp/nchrp_rpt_613.pdf

NCHRP Report 737 – Design Guidance for High-Speed to Low Speed Transition Zones for Rural Highways, Transportation Research Board, Washington D.C., 2012

🔗 http://onlinepubs.trb.org/onlinepubs/nchrp/nchrp_rpt_737.pdf

NCHRP Report 600 – Human Factors Guidelines for Road Systems, 2nd Edition, Transportation Research Board, Washington D.C., 2012

🔗 http://onlinepubs.trb.org/onlinepubs/nchrp/nchrp_rpt_600Second.pdf

NCHRP Synthesis 443 – Practical Highway Design Solutions, Transportation Research Board, Washington D.C., 2012

🔗 http://onlinepubs.trb.org/onlinepubs/nchrp/nchrp_syn_443.pdf

Measuring Sprawl 2014, Smart Growth America, Washington D.C., 2014

🔗 <http://www.smartgrowthamerica.org/measuring-sprawl>

1104.01	General
1104.02	Alternative Solution Formulation
1104.03	Alternative Solution Evaluation
1104.04	Documentation
1104.05	References

1104.01 General

Washington State Department of Transportation's (WSDOT's) practical design approach requires that alternatives are formulated and evaluated while considering acceptable performance trade-offs to meet the need(s) of a project at the lowest level of investment. This chapter discusses how:

- Information determined from planning phases and Chapters [1101](#), [1102](#), and [1103](#) is utilized in alternative solution formation.
- To evaluate the alternative solutions developed.

This chapter presents methods for developing alternatives. For projects requiring an Environmental Assessment (EA) or an Environmental Impact Statement (EIS), a final proposed alternative may only be determined through the National Environmental Policy Act (NEPA) process and/or the State Environmental Policy Act (SEPA) process (see Chapter 400 of the [Environmental Manual](#) for more information). If an EA or EIS has not been initiated under NEPA/SEPA, follow the procedures in this chapter. To help advance the project, account for appropriate NEPA/SEPA terminology is considered and used, that public and agency outreach is appropriately detailed, and that all information regarding alternatives development is documented for use later in the NEPA/SEPA process, according to [23 CFR 168\(d\)](#). Terminology used in this chapter assumes that NEPA/SEPA have not been initiated. In the event that the NEPA/SEPA process has been initiated and an EA or EIS will be required, coordinate with the region Environmental Office staff to make sure that this alternative formulation and evaluation is performed in accordance with NEPA/SEPA guidance.

1104.02 Alternative Solution Formulation

An important function of alternative solution formulation is to identify alternatives that address the baseline need while balancing the performance trade-offs identified in the process. Need identification and contributing factor analysis (CFA) are critical to alternative solution formulation (see [Chapter 1101](#) and guidance document [Contributing Factors Analysis](#) for more information). The baseline performance metric(s) aid in focusing on the most basic need that any alternative solution must address, while preventing potential scope creep for perceived peripheral needs. CFA identifies the contributing factors and underlying reason(s) the baseline need exists, forming the basis of what constitutes a strategic investment. Alternative solutions formulation will be conducted according to the following principles:

- Form solutions around contributing factors or the underlying root reason(s) identified from CFA. Address the underlying root reason(s) determined from CFA in at least one alternative.
- The relative benefit between each alternative is evaluated against the baseline and contextual performance metrics to determine the most appropriate solution for the

least cost. (See [1104.03\(3\)](#) for information on calculating the benefit/cost of alternatives.) The selected context and design controls are boundaries for design to work within. Formulate alternatives compatible with context and design controls in order to obtain the most reasonable and acceptable outcomes.

- The same type of baseline performance need in different contexts, and with different controls, may yield different alternatives.

Planning phase corridor sketches or studies may identify WSDOT's strategy for the corridor. (See the guidance document *Alternative Strategies and Solutions* for more information regarding different strategies that may be considered.) If this has occurred, at least one alternative based on that identified strategy is to be developed and carried into the alternative evaluation process (see 1104.03). In some cases, planning studies may have developed specific alternatives to resolve the identified baseline need(s). It is the responsibility of the design phase to carry planning phase alternatives into the alternative evaluation process, unless planning phase alternatives are considered obsolete. In some cases, an alternative developed in the planning phase may present opportunities for phased implementation not previously considered, which could be refined during the alternative formulation and evaluation process in the scoping or design phases.

1104.03 Alternative Solution Evaluation

Alternative solution evaluation involves an understanding of the performance benefits obtained from alternative solutions in relation to the selected design year and cost. It is the intent of the alternative solution evaluation process to:

- Compare solutions that resolve the baseline need(s) in consideration with the benefits or impacts associated with the contextual performance needs.
- Analyze the relative value of each alternative and what performance trade-offs may be necessary to accept, or if trade-offs are deemed unacceptable, what performance trade-offs to mitigate with low-cost countermeasures.
- Mitigate unacceptable performance trade-offs with the proven countermeasures or the identification and planned implementation of a future phase by WSDOT or a partner.
- Refine targets (see 1104.03(2) and [Chapter 1106](#)) if mitigation measures applied to the formulated alternatives continues to yield unacceptable performance trade-offs.

1104.03(1) Alternatives Comparison

Comparing alternatives has always been fundamental to the design process and has been conducted by a number of methods. WSDOT's alternatives comparison process is intended to align with performance-based decision-making complementary with a practical design approach. The process centers around ensuring the basic performance need is addressed while understanding the potential effects to other performance areas. A solution that meets the baseline need but creates another performance need, or a solution where performance trade-offs are not conscientiously and collaboratively accepted, is not considered practical.

An Alternative Comparison Table (ACT) has been developed to assist in evaluating alternatives against the effects to both the baseline and contextual performance metrics identified. Effects can be positive, neutral, or negative and include benefits and drawbacks. The intent of comparing alternatives is to:

- Obtain an alternative solution for the least cost while understanding and accepting the performance trade-offs that may be inherently necessary depending on the performance metrics under evaluation.
- Compare alternatives against their ability to accomplish the baseline need.
- Evaluate alternatives against their relative effects on contextual needs.
- Provide the opportunity to explore and incorporate mitigation or countermeasures to address identified contextual needs that would otherwise not be treated when performance trade-offs are not considered acceptable.
- Provide the documented alternative formulation and evaluation outcomes that are consistent with the environmental process and expectations.

Note that if there are a large number of contextual needs under consideration, it may be beneficial to prioritize or use a weighted evaluation of the contextual needs in order to expedite the alternative evaluation.

As discussed in 1104.02, at least one alternative based on the outcome of Contributing Factors Analysis should be compared against other alternatives.

The Alternative Comparison Table template and examples can be found at:

www.wsdot.wa.gov/Design/Support.htm

1104.03(2) Performance Trade-off Decisions

In performance trade-off decisions the intent is to give priority to the project's baseline need. However, there will be situations where evaluations reveal that trade-offs are too significant, and there is an inability to adequately resolve them with low-cost countermeasures, phased solutions, or general acceptance of the performance trade-off. In these situations, it is appropriate to consider alternatives that still optimize the baseline performance metric, but do not necessarily obtain initial performance targets selected for design (See [Chapter 1101](#)), in order to arrive at an acceptable performance balance. When this is the case, see [Chapter 1106](#) for when and how to refine a performance target.

If the baseline performance target was an output of least cost planning, it is critical to review the alternative analysis outcome with the region Planning Office. Based on the analysis outcome, consider refining the performance target(s) initially established for both baseline and contextual performance metrics in the corridor sketch database before finalizing the BOD. If a target is refined before the BOD is approved or later in the design process through the performance target refinement procedure (see [Chapter 1106](#)), inform region planning office of the change and update the associated corridor sketch plan. Otherwise, this location may continue to be identified through either least cost planning or priority array procedures in future funding cycles.

1104.03(3) Benefit/Cost Analysis

Inherent with understanding the performance trade-offs being made, is the overall benefit/cost for the alternatives proposed. In some cases, decisions will be made based on life cycle cost for maintenance items, as discussed in [Chapter 301](#). In other cases, perceived benefits are a challenge to quantify and will need analysis such as that discussed in *NCHRP Report 642: Quantifying the Benefits of Context Sensitive Solutions*:

www.trb.org/Publications/Blurbs/162282.aspx

1104.04 Documentation

The [Alternative Comparison Table](#) (ACT) is used to assist in evaluating alternatives. Summarize the alternatives evaluated with the ACT in Section 4 of the Basis of Design (BOD). Alternative formulation and evaluation will also be documented through the NEPA process. Environmental staff will help account for consistency with the environmental process, expectations and requirements throughout any alternative formulation and evaluation that occurs within project development.

1104.05 References

1104.05(1) *Federal/State Directives, Laws, and Codes*

[42 United States Code \(USC\) 4321](#), National Environmental Policy Act of 1969 (NEPA)

[Chapter 43.21C](#) Revised Code of Washington (RCW), State Environmental Policy Act (SEPA)

[Chapter 468-12](#) Washington Administrative Code (WAC), WSDOT SEPA Rules

[Secretary's Executive Order 1090](#) – Moving Washington Forward: Practical Solutions

[Secretary's Executive Order 1096](#) – WSDOT 2015-17: Agency Emphasis and Expectations

[Secretary's Executive Order 1028](#) – Context Sensitive Solutions

[Secretary's Executive Order 1018](#) – Environmental Policy Statement

1104.05(2) *Guidance and Resources*

[Environmental Manual](#), M 31-11, WSDOT

[Standard Plans for Road, Bridge, and Municipal Construction](#) (Standard Plans), M 21-01, WSDOT

[Understanding Flexibility in Transportation Design – Washington](#), WA-RD 638.1, Washington State Department of Transportation, 2005 www.wsdot.wa.gov/research/reports/fullreports/638.1.pdf

1104.05(3) *Supporting Information*

[Designing Walkable Thoroughfares: A Context Sensitive Approach](#), Institute of Transportation Engineers, Washington D.C., 2010.

www.ite.org

[NCHRP Report 642 – Guidelines for Quantifying the Benefits of Context Sensitive Solutions](#), Transportation Research Board, Washington D.C., 2014

<http://www.trb.org/Publications/Blurbs/162282.aspx>

[NCHRP Synthesis 443 – Practical Highway Design Solutions](#), Transportation Research Board, Washington D.C., 2013

<http://www.trb.org/Main/Blurbs/168619.aspx>

- 1105.01 General
- 1105.02 Selecting Design Elements
- 1105.03 Related Elements
- 1105.04 Documentation
- 1105.05 References

1105.01 General

Design elements are specific components associated with roadway design, such as lane widths, shoulder widths, alignments, clear zone etc. Design controls (see [Chapter 1103](#)) are conscientiously chosen and used to determine the dimensions of design elements. The relative effect that a given design element will have on performance will depend on the selected design controls and context identification. For more information, see the guidance document [The Effects of Different Design Elements on Performance](#).

1105.02 Selecting Design Elements

Design elements that have been included in a project are documented on the [Basis of Design](#) form by the project team. Include the design elements that are **employed** and/or **changed** by the preferred alternative or strategy. (See [Chapter 1100](#) for more information about Basis of Design.)

- An element is **employed** if it has been chosen for inclusion in the preferred alternative because it contributes directly to meeting the project need(s). These design elements are the “building blocks” that are included in the preferred alternative because it’s been demonstrated that they contribute to resolving the project need or needs.
- An element is **changed** if one of the following applies:
 - o A new element is added
 - o An existing element is removed or relocated
 - o A dimension—such as a width—is modified
- A design element that is not changed or employed is not documented in the Basis of Design.

The next step after selecting design elements is to choose the appropriate dimension for each element. (See [Chapter 1106](#) for information on selecting design element dimensions.)

The following link provides examples that may help clarify how to select design elements:

www.wsdot.wa.gov/Design/Support.htm

1105.02(1) Required Design Elements and Criteria

In addition to the design element selection process described above, there are additional legal and policy-based considerations that require that the decision of whether or not to include certain design elements in the project also depends on the program or project conditions. See [Exhibit 1105-1](#) for additional information regarding whether or not to include these design elements in a project.

Exhibit 1105-1 Required Design Elements

Program or Sub-Program	Design Elements						
	ADA	Clear Zone [1]	Roadside Safety Hardware [3]	Signing & Delineation [4]	Illumination [7]	ITS [8]	Signal Hardware
I-1 Mobility I-3 Economic Initiative - Trunk System I-6 Sound Transit	Apply the content in Chapter 1510 (section 1510.05)	Apply the content in Chapter 1600	Apply the content in chapters 1600 , 1610 and 1620	Apply the content in Chapter 1020 for signing and Chapter 1030 for delineation	Apply the content in Chapter 1040	Apply the content in Chapter 1050	[5]
All Preservation (P-1, P-2, P-3)	Apply the content in Chapter 1120 (section 1120.03(2))	[2]	Apply the content in Chapter 1120 (section 1120.03(7))	[2] [6]	[2]	[2]	[5]
I-2 Safety I-4 Environmental Retrofit I-3 All Other	Apply the content in Chapter 1510 (section 1510.05)	[2]	[2]	[2] [6]	[2]	[2]	[5]

Notes:

[1] See [Chapter 1600](#)

[2] Only Include when changed or employed as described in [1105.02](#).

[3] Includes all roadside safety design elements in chapters [1600](#), [1610](#), and [1620](#).

[4] See [Chapter 1020](#) for signing and [Chapter 1030](#) for delineation

[5] Consult the Assistant State Design Engineer, HQ Traffic Office, and Capital Program Development and Management Office (CPDM) to determine policy requirements.

[6] Consult the HQ Traffic Office for policy requirements if the design element “delineation” is changed or employed in the design.

[7] See [Chapter 1040](#)

[8] See [Chapter 1050](#)

1105.03 Related Elements

Design elements can be interrelated. Even if a specific design element has not changed in accordance with the definition in [1105.02](#), consideration is to be given to whether or not the preferred alternative has changed the conditions in a way that may affect the performance of the unchanged element.

Example: A project team proposes to provide a two-way left-turn lane along a portion of their project by reducing the width of each highway shoulder, in order to address a baseline need related to safety for turning traffic. By reducing the shoulder width, they note that the traveled way is now closer to the roadside than in the existing condition. Project team discussions with their interdisciplinary team determine whether the project would adversely affect safety performance due to roadside conditions such as steep slopes or objects in the clear zone.

1105.04 Documentation

Document the design elements included in the preferred alternative in the [Basis of Design](#) (BOD) form, which is organized around six procedural steps. The BOD, Section 5, covers design element selection.

As a design alternative matures over time, it is likely that design elements may be added or dropped through the iterative process inherent with design. It is important to update the Basis of Design documentation with these changes at the various documentation milestones.

The Basis of Design is available to download here:

 www.wsdot.wa.gov/Design/Support.htm

1105.05 References

The Effects of Different Design Elements on Performance, WSDOT Guidance Document:

 www.wsdot.wa.gov/Design/Support.htm

- 1106.01 General
- 1106.02 Dimensioning Design Elements
- 1106.03 Dimensioning Iterations
- 1106.04 Documenting Dimensions
- 1106.05 References

1106.01 General

Practical design resolves the project need with the least investment, and relies on a “design-up” approach. A design-up approach means developing project alternatives utilizing the smallest dimensions that meet the need by providing the desired performance.

Flexibility in the choice of design element dimensions is primarily provided by designing for the appropriate context, design controls, and understanding the performance to obtain. This chapter outlines two methods that build upon the context, design controls, and performance selection in order to dimension elements: quantitative analysis method and criteria-based evaluation method.

1106.02 Dimensioning Design Elements

Context, design controls, and performance needs are significant factors when selecting design element dimensions. Context is critical, because many design element dimensions have a different relative importance to certain performance categories in different contexts. For additional information, see the examples below and the guidance document *Effects of Different Design Elements on Performance*:  <http://www.wsdot.wa.gov/Design/Support.htm>.

Example: Shoulder width in an urban context affects safety and mobility performance differently than when applied in a rural context.

Design controls, particularly target speed and access control selection, significantly influence many geometric design element dimensions.

Example: A high target speed selection results in larger horizontal turning radii versus a lower target speed selection. A high target speed may necessitate separating a bike lane with an outer separation, versus a lower target speed where that separation is not needed. Intersection densities associated with the selected access control will effect what is necessary for decision sight distance.

The selected baseline and contextual performance metrics and targets, and associated trade-offs, will impact many different design element dimensions.

Example: A prioritized bicycle mobility and safety performance target may result in reducing motor vehicle lane widths in order to provide a needed bike lane width, even though there is a known impact to motor vehicle mobility and safety performance.

Understanding boundaries established through the selected context identification, design controls, and performance needs enables projects to “design up” by testing the lower values first (see also [Chapter 300](#)).

Two methods are available when evaluating design element dimensions:

- Quantitative Analysis Method
- Criteria-Based Evaluation Method

Whenever viable, dimension design elements in *Design Manual* divisions 12 through 15 using quantitative methods and according to the context, design controls, and desired performance selected. Note: this does not apply to design elements related to Americans with Disabilities Act (ADA), which must apply ADA-related criteria presented in [Chapter 1510](#) to be compliant with state and federal ADA laws.

If quantitative tools cannot analyze the design elements, use the criteria-based evaluation method. Identify performance trade-offs that may result from the outcome of applying these methods, and update the Alternative Comparison Table (ACT), as appropriate. Dimensioning iterations are expected to occur as discussed in [1106.03](#).

1106.02(1) Element Dimensioning Using Quantitative Analysis Method

The use of quantitative engineering methods and tools is required whenever such tools are available. Some quantitative tools only address particular context and design elements related to a particular performance category under evaluation. Currently, two primary tools exist to quantitatively evaluate performance. These are the *Highway Safety Manual* (HSM) and the *Highway Capacity Manual* (HCM), which evaluate multimodal safety performance and traffic operational mobility performance, respectively.

Designers can use quantitative methods to readily input and verify the performance results of their design elements.

1106.02(1)(a) Highway Safety Manual and Safety Modeling

Safety is and always has been a primary performance category for WSDOT. Past design policy relied on the assumption that the application of design criteria equated to a desired level of safety performance for the expenditure. This anecdotal assumption may not have always been true for all locations, given their operational and geometric characteristics. The strict application of criteria to achieve safety performance is known as “nominal safety.” To achieve a more reliable safety performance, scientific estimation of crashes using site conditions is necessary and is termed “substantive safety.” A new understanding of safety performance, crash modification factors, and roadway functions has led to a growing body of knowledge about the relationship between roadway characteristics and safety performance.

The application of the *Highway Safety Manual* (HSM) and its companion tools allows for a judicious understanding of how a particular design can perform with respect to safety. This enables analysis of safety-specific performance metrics that may be more critical to address. The HSM covers multiple transportation road types and can be a valuable tool to analyze various geometric alternatives in any program type.

Washington State’s [Target Zero Strategic Safety Plan](#) identifies the department’s baseline performance metric for safety: reduce the risk of serious injury and fatal crashes. This baseline performance metric is to be evaluated at all locations resolving a mobility or economic vitality

category need, as discussed in [Chapter 1101](#). Projects in the I-2 safety program may also identify other specific baseline safety performance metrics, to further target crash types of concern and reduce the risk of serious injury and fatal crashes. Additionally, other locations may have identified specific safety performance metrics as either baseline or contextual performance metrics. In general, outside of the safety program, other specific safety performance metrics should be the result of the contributing factors analysis (see [Chapter 1101](#)). For more information on sustainable highway safety tools and analysis, see [Chapter 321](#).

1106.02(1)(b) Highway Capacity Manual and Traffic Modeling

The *Highway Capacity Manual* (HCM) provides quantitative methods for evaluating mobility operational performance. However, some quantitative outputs from some HCM methods are specific to free-flow speed operations or level of service, and may not be appropriate for use given the baseline mobility performance metric selected for a specific location. Traffic modeling software provides a more relevant method for understanding the mobility operational performance; however, the reliability of the outputs varies given the traffic forecasting for design years further in the future. Utilize traffic modeling to ascertain potential mobility operational performance whenever feasible.

1106.02(2) Element Dimensioning Using Criteria-Based Evaluation Method

The criteria-based evaluation method relies on applying criteria presented within the *Design Manual* chapters. The application of criteria-based evaluation requires engineering judgment regarding a specific criteria's relevance to a particular alternative under consideration or its direct or indirect effect on a particular performance outcome. The criteria-based evaluation method is intended to assist with a determination of common application and dimensioning of a particular design element. However, site-specific factors cannot always be accounted for within the design criteria, and it is therefore ultimately up to the Engineer of Record.

Variations to design element criteria provided in *Design Manual* chapters can be heavily influenced by the selected context and design controls. Use the context, design controls, and performance target(s) selected to inform engineering judgment in the application of criteria.

1106.03 Dimensioning Iterations

Dimensioning is a crucial part of alternatives formulation and evaluation. A project alternative will likely go through several iterations to identify design elements, select design element dimensions, and balance dimensions with the potential inclusion of countermeasures or treatments to offset an adverse performance impact.

1106.04 Documenting Dimensions

While a primary function of the Basis of Design is to document the design elements selected to be included in a project, a primary function of the Design Parameter sheets is to document the dimensions chosen for the various design elements included in a project. Document design element dimensions on the Design Parameter sheets.

Important Note: If the dimension for an existing design element doesn't change, no documentation is required on the Parameter sheets. A Parameter Sheet entry left blank means that the element was not selected to be included in the project. (See [Chapter 1105](#) for design

element selection guidance.) A Parameter Sheet template can be found here:

<http://www.wsdot.wa.gov/Design/Support.htm>.

1106.04(1) Performance Target Refinement Procedure

In some situations it may be necessary to refine performance targets for one or more metrics from the initial targets established and documented on the Basis of Design. When this occurs use the Performance Target Refinement Form (PTRF) for each individual metric and target under consideration. Refining a performance target occurs when the MAISA and/or Engineer of Record determines any of the following apply:

- All reasonable alternatives have been considered, and no alternative is able to meet the initial target established.
- An alternative can meet the initial target, but in doing so, unacceptable performance trade-offs result for other metrics, and the alternatives evaluated cannot mitigate for the performance gap with low cost countermeasures or treatments.

The PTRF is used for assessing the adequacy of the analysis of performance trade-offs and potential countermeasures, treatments, and/or design elements considered within the identified alternatives. Additional agreement is necessary for refinement of safety performance targets, as indicated on form. The PTRF can be downloaded here:

<http://www.wsdot.wa.gov/Design/Support.htm>.

1106.04(2) Design Analysis

A Design Analysis may be required if the quantitative analysis method has not been used in the process of determining the dimension or value of a design element. When the criteria-based evaluation method is used, a Design Analysis is needed when a design element is changed or employed, and the dimension chosen does not meet the guidance provided in the *Design Manual*. In the case of a shoulder width reduction at an existing bridge pier or abutment, the Design Parameter Sheet may be used instead of a Design Analysis to document the dimensioning decision for the shoulder at that location. See [Chapter 300](#) for guidance regarding Design Analysis content and approval.

A template is available to guide the development of the Design Analysis document here:

www.wsdot.wa.gov/design/support.htm.

1106.05 References

Effects of Different Design Elements on Performance, WSDOT guidance document

<http://www.wsdot.wa.gov/Design/Support.htm>

Highway Capacity Manual (HCM), latest edition, Transportation Research Board, National Research Council

Highway Safety Manual (HSM), AASHTO

Washington State's Target Zero Strategic Safety Plan

<http://www.targetzero.com/plan.htm>

1120.01	General
1120.02	Preservation Projects
1120.03	Preservation Project Features and Elements
1120.04	Documentation

1120.01 General

This chapter provides information specific to programmatic preservation project types. Pavement preservation work engages specific design elements and features that are necessary to addressing programmatic intent.

This chapter identifies those elements and features to be evaluated and potentially addressed during the course of a preservation project. The elements listed here may also be in addition to the project need identified in the Project Summary or Basis of Design (see [1120.04](#)).

1120.02 Preservation Projects

Preservation projects are funded in three program areas:

- **Pavement preservation projects** preserve pavement structure, extend pavement service life, and restore the roadway for reasonably safe operations. (See Roadway Preservation – P1 Scoping instructions.)
- **Structures preservation projects** preserve the state’s bridge network through cost effective actions. There are numerous types of bridge preservation actions including: deck rehabilitation, seismic retrofit, painting steel bridges, scour repair, and others. (See Structures Preservation – P2 scoping instructions.)
- **Preservation of other facilities** includes basic safety guardrail and signing, major drainage, major electrical, unstable slopes and other project types. (See Other Facilities – P3 Scoping instructions.)

The work described in this chapter may apply to projects in one or multiple program areas. See the following link for more information:

<http://wwwi.wsdot.wa.gov/Planning/CPDMO/PlanProgScoping.htm>

1120.03 Preservation Project Features and Elements

This section applies to features and design elements to be addressed on pavement preservation projects.

This section may also apply to other preservation projects. To determine which features and elements to address in these projects consult with region and headquarters subject matter experts.

See [1120.04](#) Documentation for instructions on using the Basis of Design to document design elements and adjusted features.

1120.03(1) Adjust existing features

- Adjust existing features such as monuments, catch basins, and access covers that are affected by resurfacing.
- Evaluate drainage grates and replace as needed to address bicycle safety (see Drainage Grates and Manhole Covers in [Chapter 1520](#)).
- For guidance on existing curb see [1230.05](#)

1120.03(2) ADA requirements

- Address ADA requirements according to WSDOT policy (see [Chapter 1510](#)).

1120.03(3) Cross slope lane

- Rebuild the cross slope to a minimum 1.5% when the existing cross slope is flatter than 1.5% and the steeper slope is needed to provide adequate highway runoff. See Chapters [1230](#) and [1250](#) for more information about cross slope..

1120.03(4) Cross slope shoulder

- When rebuilding the lane cross slope, evaluate shoulder cross slope in accordance with [Chapter 1230](#).

1120.03(5) Vertical clearance

- Paving projects, and seismic retrofit projects, may impact vertical clearances (see [Chapter 720](#)). If vertical clearance will be changed by the project document an analysis of this design element in the Basis of Design and the Design Parameters sheets.

1120.03(6) Delineation

- Install and replace delineation in accordance with [Chapter 1030](#) (this includes only pavement markings, guideposts, and barrier delineation).
- Replace rumble strips if their average depth is less than 3/8", unless there is a documented justification for their removal (see [Chapter 1600](#)).

1120.03(7) Barriers and terminals

- When the guardrail, terminal, and/or transition will be reduced to less than 26 inches from the ground to the top of the rail element, adjust the height to a minimum of 26 inches and a maximum of 28 inches, in accordance with [1610.04\(1\)](#) and [1610.04\(2\)\(a\)](#). A rail height of 28 inches is desirable to accommodate future overlays. This guardrail work may be programmed under a separate project except for crack, seat, and overlay projects.
- Evaluate the guardrail length of need for runs that need to be raised as a result of an HMA overlay in accordance with [Chapter 1610](#). Up to 250 feet of additional run length within each run is permissible in preservation projects.
- Note that removal is an option if guardrail is no longer needed based on validation of the original guardrail purpose from past project documentation and after consulting Chapters [1600](#) and [1610](#).
- When adjusting terminals that are equipped with CRT posts, the top-drilled holes in the posts need to remain at the surface of the ground.

- Pre-cast concrete barrier sections (either New Jersey or “F” shape) are normally installed at 32” height, which includes provision for up to 3” overlay. A 29” minimum height for this type of barrier must be maintained following an overlay.
- Single slope concrete barrier may be pre-cast or cast in place, and is installed new at a height of 42”, 48”, or 54”. A 30” minimum height must be maintained for this type of barrier following an overlay.

1120.03(8) Fill and Ditch Slopes

- See [Chapter 1230](#) for Fill and Ditch in-slopes steeper than 4H:1V on Interstate HMA Overlays and PCCP Single Lane Rehab projects.

1120.04 Documentation

Use the [Basis of Design](#) to document decisions when the project employs or changes one or more design elements that are not otherwise referenced in this chapter.

- 1210.01 General
- 1210.02 Horizontal Alignment
- 1210.03 Distribution Facilities
- 1210.04 Number of Lanes and Arrangement
- 1210.05 Pavement Transitions
- 1210.06 Procedures
- 1210.07 Documentation
- 1210.08 References

1210.01 General

This chapter provides guidance on the design of horizontal alignment, frontage roads, number of lanes, arrangement of lanes, and pavement transitions. For additional information, see the following chapters:

Chapter	Subject
1230	Lane and shoulder widths
1240	Lane widths on turning roadways for full design level
1250	Superelevation rate and transitions
1260	Sight distance
1310	Guidelines for islands
1360	Ramp lane and shoulder guidelines

1210.02 Horizontal Alignment

1210.02(1) General

Horizontal and vertical alignments (see [Chapter 1220](#)) are the primary controlling elements for highway design. It is important to coordinate these two elements with design speed, drainage, intersection design, and aesthetic principles in the early stages of design. How horizontal alignments are designed depends largely on the context and selected design controls. Lower-speed environments can be more forgiving than higher-speed environments.

1210.02(1)(a) Low-Speed Alignments

Consider the following when designing low-speed horizontal alignments:

- a. Determine whether sufficient contextual elements exist within the roadway cross section to indicate the desired low-speed environment (street trees, lack of building setbacks, streetside amenities, etc.).
- b. Determine whether horizontal geometric traffic calming treatments will be needed to maintain the selected design speed (see [Chapter 1103](#)).
- c. Avoid placing pedestrian midblock crossings within horizontal curves.

1210.02(1)(b) High-Speed Alignments

Horizontal alignments designed for high speed are likely to have modal priorities for freight and passenger vehicles, and it is necessary to strive for forgiving and predictable alignments within high-speed environments. Exhibits [1210-2a](#) through [1210-2c](#) show desirable and undesirable alignment examples for use with the following considerations:

- a. Make the highway alignment as direct as practicable and still blend with the topography while considering developed and undeveloped properties, community boundaries, and environmental concerns.
- b. Make highway alignment consistent by:
 - Using gentle curves at the end of long tangents.
 - Using a transition area of moderate curvature between the large radius curves of rural areas and the small radius curves of populated areas.
 - Making horizontal curves visible to approaching traffic.
- c. Avoid minimum radii and short curves unless:
 - Restrictive conditions are present and alternatives are not readily or economically avoidable.
 - On two-lane highways, minimum radii result in tangent sections long enough for needed passing.
- d. Avoid any abrupt change in alignment. Design reverse curves with an intervening tangent long enough for complete superelevation transition for both curves. (See [Chapter 1250](#) for more information on superelevation transitions.)
- e. Avoid the use of curves in the same direction connected by short tangents (broken back curves); substitute a single larger curve.
- f. Avoid compound curves on open highway alignment if a simple curve can be obtained. When compound curves are used, make the shorter radius at least two-thirds the longer radius. Make the total arc length of a compound curve not less than 500 feet.
- g. On divided multilane highways, take advantage of independent alignment to produce a flowing alignment along natural terrain.
- h. The desirable locations for bridges, interchanges, intersections, and temporary connections are on tangent sections in clear view of drivers.
- i. On two-lane two-way highways, strive for as much passing sight distance as possible (see [Chapter 1260](#)).

1210.02(2) Horizontal Curve Radii

Design speed is the governing variable of horizontal curves. For guidance regarding design speed selection, see [Chapter 1103](#), and see [Chapter 1360](#) for ramps.

Use the following factors to determine the radius for a curve:

- Low to intermediate design speed environments may need to utilize horizontal curves to maintain the desired operating speed. Horizontal curvature, more than any other design element or treatment, provides the best speed management results. (See [Chapter 1103](#) for more information on speed management.)
- Stopping sight distance where sight obstructions are on the inside of a curve. Median barriers, bridges, walls, cut slopes, wooded areas, buildings, and guardrails are examples of sight obstructions. (See [Chapter 1260](#) to check for stopping sight distance for the selected design speed.)
- Superelevation is the rotation or banking of the roadway cross section to overcome part of the centrifugal force that acts on a vehicle traversing a curve. Design information on the relationship between design speed, radius of curve, and superelevation is in [Chapter 1250](#).
- Coordinate vertical and horizontal alignment (see [Chapter 1220](#)).

Spiral curves, although no longer used on new highway construction or major realignment, still exist on Washington's highways. Spirals were used to transition between tangents and circular curves with the horizontal curvature rate increasing from tangent to the central curve and decreasing from curve to tangent. Spirals do not pose an operational concern and may remain in place. (See *A Policy on Geometric Design of Highways and Streets* for information on spirals.)

1210.02(3) Horizontal Curve Length

A curve is not required for small deflection angles. Exhibit 1210-1 gives the maximum allowable angle without a curve. (See [Chapter 1310](#) for guidance on angle points or short radii curves in the vicinity of intersections at grade.)

To avoid the appearance of a kink in the road, the desirable length of curve for deflection angles larger than given in Exhibit 1210-1 is at least 500 feet.

Exhibit 1210-1 Maximum Angle Without Curve

Design Speed (mph)	Maximum Angle Without Curve
25	2°17'
30	1°55'
35	1°38'
40	1°26'
45	1°16'
50	1°09'
55	1°03'
60	0°57'
65	0°53'
70	0°49'
75	0°46'
80	0°43'

1210.03 Distribution Facilities

1210.03(1) General

In addition to the main highway under consideration, other facilities can be used to distribute traffic to and from the highway and to provide access. Highway flexibility can be augmented by:

- Frontage roads
- Collector-distributor roads
- On and off connections
- Parallel arterial routes with connections between them and the main highway
- Loop highways around large metropolitan areas

A city or county may be asked to accept a proposed distribution facility as a city street or county road. Plan and design these facilities according to the applicable design values as city streets or county roads (see [Chapter 1230](#)).

1210.03(2) Frontage Roads

Frontage roads constructed as part of highway development may serve to:

- Reestablish continuity of an existing road severed by the highway.
- Provide service connections to adjacent property that would otherwise be isolated as a result of construction of the highway.
- Control access to the highway.
- Maintain circulation of traffic on each side of the highway.
- Segregate local traffic from the higher speed through traffic and intercept driveways of residences and commercial establishments along the highway.
- Relieve congestion on the arterial highway during periods of high use or in emergency situations.

Frontage roads are generally not permanent state facilities. They are usually turned back to the local jurisdiction. Plan and design frontage roads as city streets or county roads (see [Chapter 1230](#)). Initiate coordination with the local agency that will be the recipient of the facility early in the planning process, and continue through design and construction. (See [Chapter 530](#) for additional guidance on frontage roads and turnbacks.)

Outer separations function as buffers between the through traffic on the highway and the local traffic on the frontage road. The width is governed by requirements for grading, signing, barriers, aesthetics, headlight glare, and ramps. Where possible, make the separation wide enough to allow for development on both sides of the frontage road. Wider separations also move the intersection with the frontage road and a crossroad farther from the intersection with the through roadway, and they can reduce the amount of limited access control rights to be acquired (see [Chapter 530](#)).

Where two-way frontage roads are provided, make the outer separation wide enough to minimize the effects of approaching traffic on the right, particularly the headlight glare. (See [Chapter 1600](#) for information on headlight glare considerations.) With one-way same-direction frontage roads, the outer separation need not be as wide as with two-way frontage roads.

Wide separations lend themselves to landscape treatment and can enhance the appearance of both the highway and the adjoining property.

A substantial width of outer separation is particularly advantageous at intersections with cross streets. The wider separation reduces conflicts with pedestrians and bicycles.

Where ramp connections are provided between the through roadway and the frontage road, the minimum outer separation width depends on design of the ramp termini.

1210.04 Number of Lanes and Arrangement

1210.04(1) General

The basic number of lanes is designated and maintained over a length of highway. The total number of lanes is the basic number of lanes plus any auxiliary lanes provided to meet:

- Level of service (volume-capacity)
- Lane balance
- Flexibility of operation

1210.04(2) Basic Number of Lanes

In certain situations, it is appropriate to keep the basic number of lanes constant over a highway route, or a significant portion thereof, regardless of changes in traffic volume. However, this can lead to unnecessary property or environmental impacts that need to be balanced throughout a design. Consider the impacts, human factors, and traffic analysis before making decisions regarding basic number of lane consistency throughout a highway route.

Change the basic number of lanes for general changes in traffic volume over a substantial length of the route. The desirable location for a reduction in the basic number of lanes is on a tangent section between interchanges or intersections. However, there can be advantages in using dedicated turn lanes at intersections as a means to reduce the number of lanes.

To accommodate high traffic volumes for short distances, such as between adjacent interchanges, use auxiliary lanes. When auxiliary lanes are provided on consecutive sections between interchanges, consider increasing the basic number of lanes through the entire length.

1210.04(3) Auxiliary Lanes

Auxiliary lanes are added to the basic number of lanes to allow additional traffic movements on short segments. These added lanes are based primarily on volume-to-capacity relationships (see [Chapter 320](#)). For efficient operation of auxiliary lanes, see the following:

Chapter	Subject
1270	Truck climbing and passing lanes
1310	Left- and right-turn lanes and storage for turning
1360	Weaving and auxiliary lanes associated with interchanges

1210.05 Pavement Transitions

1210.05(1) Lane Transitions

1210.05(1)(a) Change Lane Width

For lane width changes that create an angle point in an adjacent lane, the maximum angle is given in [Exhibit 1210-1](#). When a lane width change does not create an angle point in an adjacent lane, a 25:1 taper is sufficient.

1210.05(1)(b) Reduce Number of Lanes

To reduce the number of lanes, provide a transition with the following guidelines:

- Locate transitions where decision sight distance exists, desirably on a tangent section and on the approach side of any crest vertical curve, except the end of climbing lanes, which are transitioned in accordance with [Chapter 1270](#).
- Supplement the transition with traffic control devices.
- Reduce the number of lanes by dropping only one at a time from the right side in the direction of travel. (See the [MUTCD](#) when dropping more than one lane in a single direction.)
- Use the following formula to determine the minimum length of the lane transition for speeds \geq 45 mph or more:

$L = VT$
Where:
L = Length of transition (ft)
V = Design speed (mph)
T = Tangential offset width (ft)

- Use the following formula to determine the minimum length of the lane transition for speeds \leq 45 mph:

$L = \frac{TV^2}{60}$
Where:
L = Length of transition (ft)
V = Design speed (mph)
T = Tangential offset width (ft)

1210.05(1)(c) Increase Number of Lanes

To increase the number of lanes, a tangential rate of change in the range of 1:4 to 1:15 is sufficient. Aesthetics are the main consideration.

1210.05(1)(d) Turning Roadway

For turning roadway widening width transitions, see [Chapter 1240](#).

1210.05(2) Median Width Transitions

Whenever two abutting sections have different median widths, use long, smooth transitions ($L = VT$ or flatter). When horizontal curves are present, this can be accomplished by providing the transition throughout the length of the curve. For transitions on tangent sections, the transitions may be applied symmetrically about the centerline or on only one side of the median based on whether or not the abutting existing section is programmed for the wider median in the future. For aesthetics, make the transition length as long as feasible.

1210.06 Procedures

When the project realigns the roadway, develop horizontal alignment plans for inclusion in the Plans, Specifications & Estimates. Show the following as needed to maintain clarity and provide necessary information:

- Horizontal alignment details (tangent bearing, curve radius, and superelevation rate)
- Stationing
- Number of lanes
- Intersections, road approaches, railroad crossings, and interchanges (see Chapters [1310](#), [1340](#), [1350](#), and [1360](#))
- Existing roadways and features affecting or affected by the project

For additional plan guidance, see the [Plans Preparation Manual](#).

Justify any realignment of the roadway. Include the reasons for the realignment, profile considerations, and alternatives considered, and the reasons the selected alignment was chosen.

When the project changes the number of lanes, include a capacity analysis supporting the number selected (see [Chapter 320](#)) with the justification for the number of lanes.

Include with the justification for a frontage road any traffic analyses performed; the social, environmental, and economic considerations; the options considered; and the reasons for the final decision.

1210.07 Documentation

Refer to [Chapter 300](#) for design documentation requirements.

1210.08 References

1210.08(1) Federal/State Laws and Codes

[Washington Administrative Code \(WAC\) 468-18-040](#), Design standards for rearranged county roads, frontage roads, access roads, intersections, ramps and crossings

1210.08(2) Design Guidance

Local Agency Guidelines (LAG), M 36-63, WSDOT

Manual on Uniform Traffic Control Devices for Streets and Highways, USDOT, FHWA; as adopted and modified by [Chapter 468-95 WAC](#) "Manual on uniform traffic control devices for streets and highways" (MUTCD)

Plans Preparation Manual, M 22-31, WSDOT

Right of Way Manual, M 26-01, WSDOT

Utilities Manual, M 22-87, WSDOT

1210.08(3) Supporting Information

A Policy on Geometric Design of Highways and Streets (Green Book), AASHTO, current edition

Exhibit 1210-2a Alignment Examples

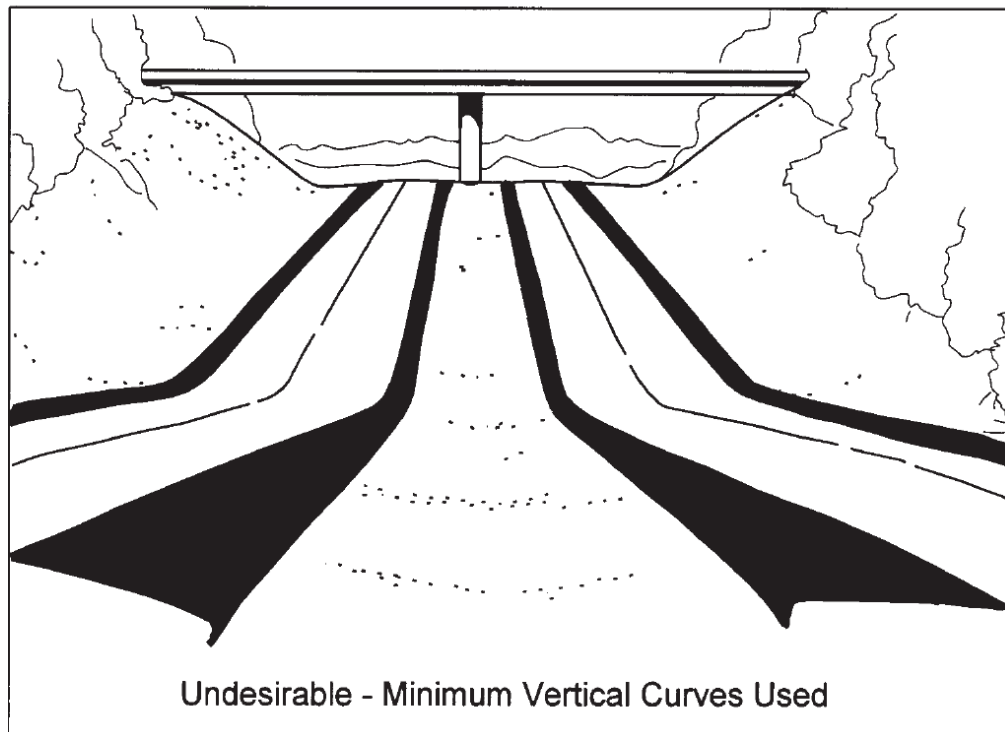
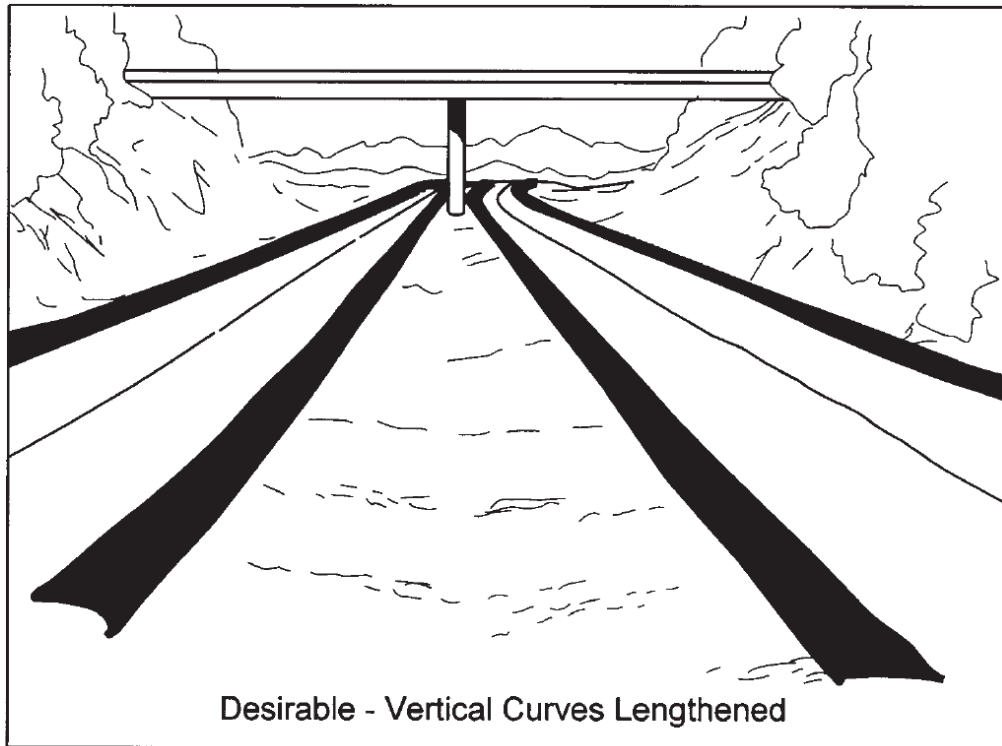

Exhibit 1210-2b Alignment Examples

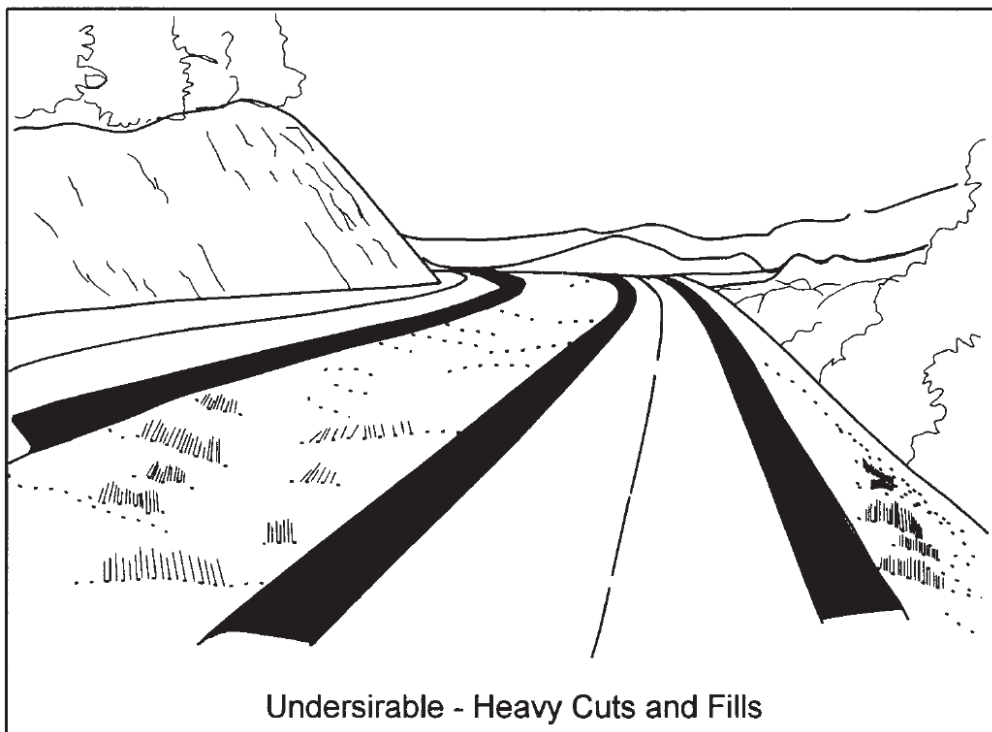
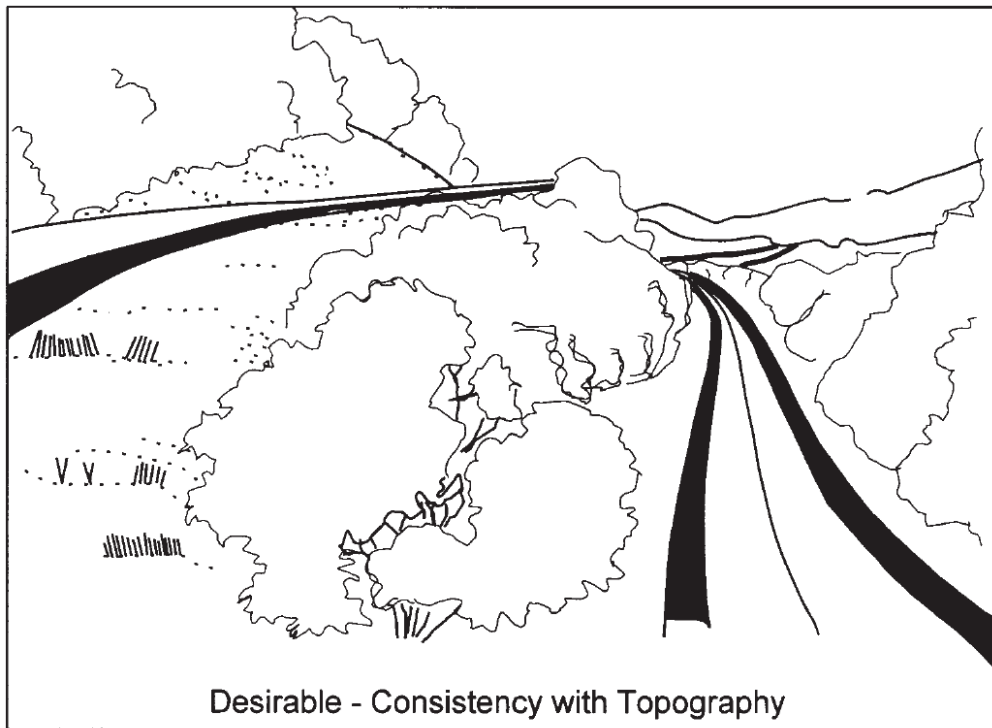
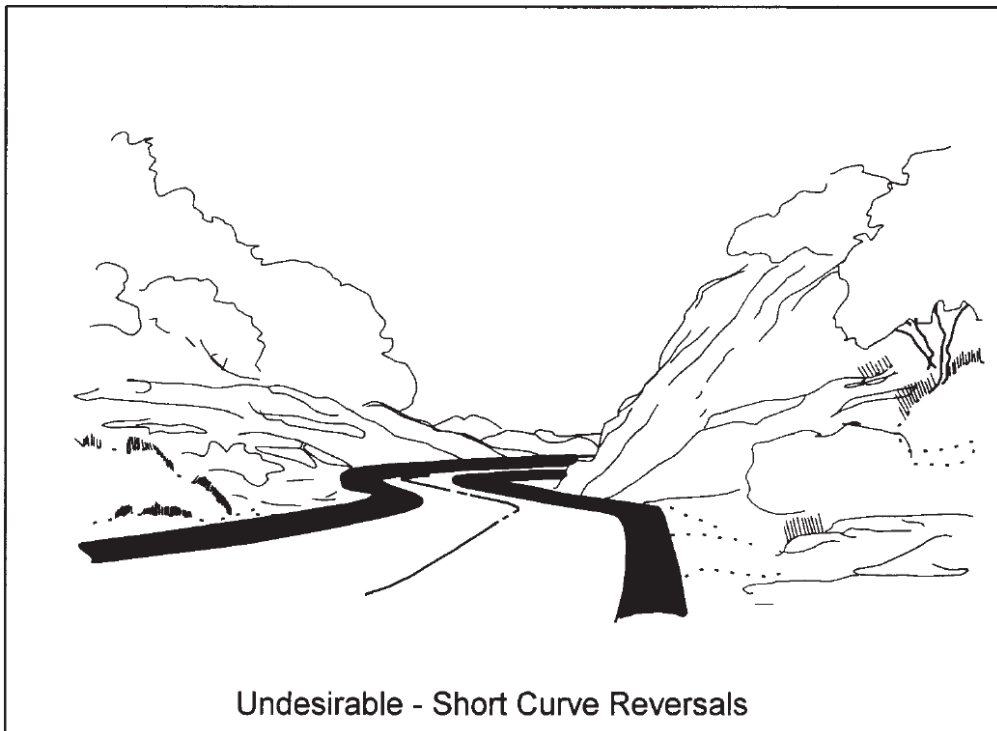
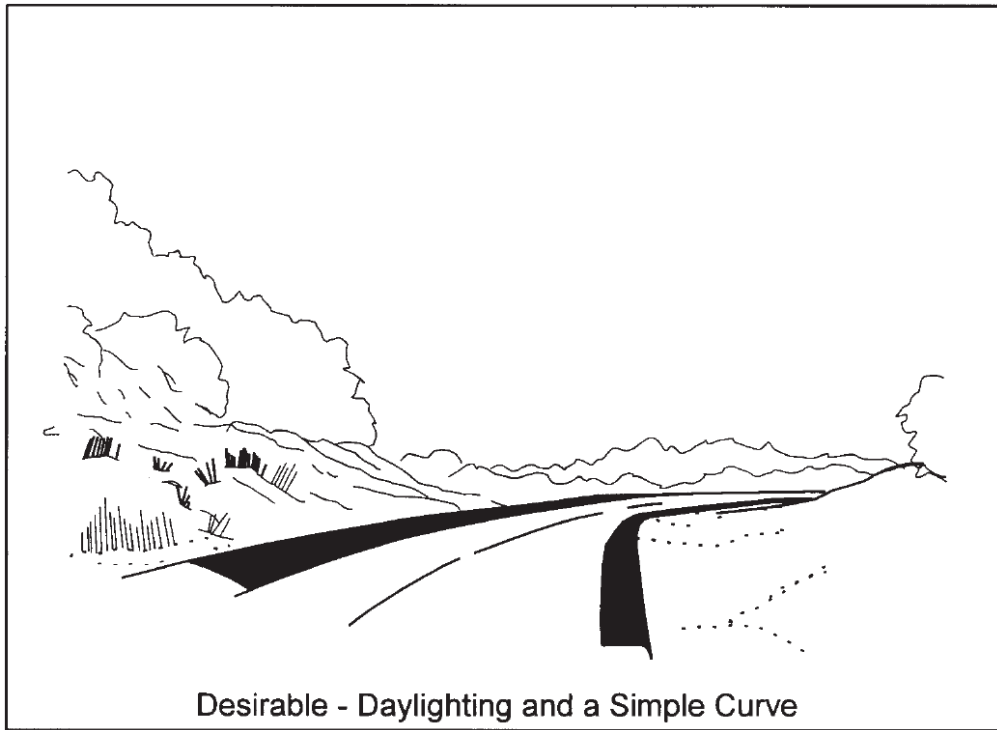

Exhibit 1210-2c Alignment Examples



- [1220.01 General](#)
- [1220.02 Vertical Alignment](#)
- [1220.03 Coordination of Vertical and Horizontal Alignments](#)
- [1220.04 Airport Clearance](#)
- [1220.05 Railroad Crossings](#)
- [1220.06 Procedures](#)
- [1220.07 Documentation](#)
- [1220.08 References](#)

1220.01 General

Vertical alignment (roadway profile) consists of a series of gradients connected by vertical curves. It is mainly controlled by the following:

- Topography
- Class of highway
- Horizontal alignment
- Safety
- Sight distance
- Construction costs
- Drainage
- Adjacent land use
- Vehicular characteristics
- Aesthetics

This chapter provides guidance for the design of vertical alignment. For additional information, see the following chapters:

Chapter	Subject
1103	Design controls, terrain
1210	Horizontal alignment
1260	Sight distance
1310	Grades at intersections
1360	Maximum grade for ramps

1220.02 Vertical Alignment

1220.02(1) *Design Principles*

The following are general principles for developing vertical alignment (also see Exhibits [1220-2a](#) through [2c](#)):

- Use a smooth grade line with gradual changes, consistent with the context identification and character of terrain. Avoid numerous breaks and short grades.

- Avoid “roller coaster” or “hidden dip” profiles by use of gradual grades made possible by heavier cuts and fills or by introducing some horizontal curvature in conjunction with the vertical curvature.
- Avoid grades that affect truck speeds and, therefore, traffic operations.
- Avoid broken back grade lines with short tangents between two vertical curves.
- Use long vertical curves to flatten grades near the top of long, steep grades.
- Where at-grade intersections occur on roadways with moderate to steep grades, it is desirable to flatten or reduce the grade through the intersection.
- Establish the subgrade at least 1 foot above the high water table (real or potential), or as recommended by the Region Materials Engineer. Consider the low side of superelevated roadways.
- When a vertical curve takes place partly or wholly in a horizontal curve, coordinate the two as discussed in [1220.03](#).

1220.02(2) *Minimum Length of Vertical Curves*

The minimum length of a vertical curve is controlled by design speed, stopping sight distance, and the change in grade. Make the length of a vertical curve, in feet, not less than three times the design speed, in miles per hour. (See [Chapter 1260](#) to design vertical curves to meet stopping sight distance criteria.) For aesthetics, the desirable length of a vertical curve is two to three times the length to provide stopping sight distance.

Sag vertical curves may have a length less than required for stopping sight distance when all three of the following are provided:

- An [analysis](#) to justify the length reduction.
- Continuous illumination.
- Design for the comfort of the vehicle occupants. For comfort, use:

$L = \frac{AV^2}{46.5}$
<p>Where: L = Curve length (ft) A = Change in grade (%) V = Design speed (mph)</p>

The sag vertical curve lengths designed for comfort are about 50% of those for sight distance.

1220.02(3) *Maximum Grades*

Analyze grades for their effect on traffic operation because they may result in undesirable truck speeds. Maximum grades are controlled by terrain type and design speed (see [Grade and Speed Considerations below](#) and Chapters [1103](#) and [1360](#)).

1220.02(4) Minimum Grades

Minimum grades are used to meet drainage requirements. Avoid selecting a “roller coaster” or “hidden dip” profile merely to accommodate drainage.

Minimum ditch gradients of 0.3% on paved materials and 0.5% on earth can be obtained independently of roadway grade. Medians, long sag vertical curves, and relatively flat terrain are examples of areas where independent ditch design may be justified. A closed drainage system may be needed as part of an independent ditch design.

1220.02(5) Length of Grade

The desirable maximum length of grade is the maximum length on an upgrade at which a loaded truck will operate without a 10 mph reduction. Exhibit 1220-1 gives the desirable maximum length for a given percent of grade. When grades longer than the desirable maximum are unavoidable, consider an auxiliary climbing lane (see [Chapter 1270](#)). For grades that are not at a constant percent, use the average.

When long, steep downgrades are unavoidable, consider an emergency escape ramp, and for grades longer than indicated, consider an auxiliary climbing lane (see [Chapter 1270](#)).

Exhibit 1220-1 Grade Length

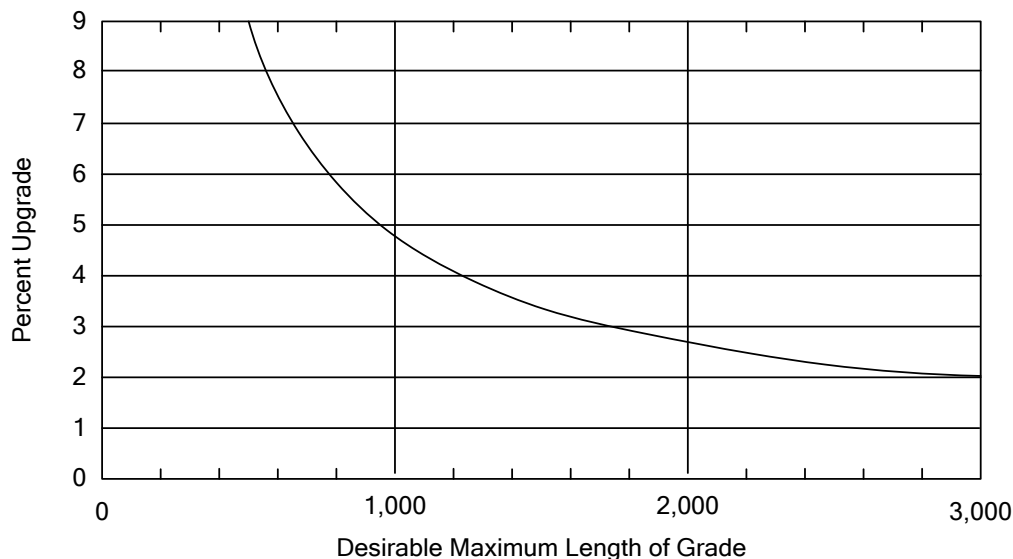

For grades longer than indicated, consider an auxiliary climbing lane (see [Chapter 1270](#)).

1220.02(6) Grade and Speed Considerations

Grades can affect the operating performance of the vehicles negotiating them. The bicycle, transit, and freight modes are most affected by grades, while passenger cars can readily negotiate grades as steep as 5% without appreciable loss of operating speed. Steep downgrades can also impact operating speeds, particularly for heavy trucks, which display up to a 5% increase in speed on downgrades. Consider the selected performance for a location and corridor before making a determination on grade selection, to avoid unnecessary cuts or fills required for a vertical alignment. The following tables provide suggestions for determining maximum grades based on the context, terrain classification, and targeted speed. However, these grades may vary from these values depending on the performance targeted for a location.

Table 1 Maximum Grades for Rural Contexts

Type of Terrain	Design Speed (mph)											
	25	30	35	40	45	50	55	60	65	70	75	80
Level	6-7	6-7	6-7	5-7	5-7	4-6	4-6	3-5	3-5	3-4	3	3
Rolling	8-10	7-9	7-9	6-8	6-8	5-7	5-7	4-6	4-6	4-5	4	4
Mountainous	9-11	8-10	8-10	8-10	7-10	7-9	6-9	6-8	5-8	5-6	5	5

Table 2 Maximum Grades for Suburban and Urban Contexts

Type of Terrain	Design Speed (mph)									
	20	25	30	35	40	45	50	55	60	
Level	8-9	8-9	8-9	7-9	7-9	6-8	6-7	5-7	5-6	
Rolling	11-12	11-12	9-11	8-10	8-10	7-9	7-8	6-8	6-7	
Mountainous	13-14	12-13	11-12	10-12	10-12	9-11	9-10	8-10	8-9	

Table 3 Maximum Grades for Interstate and Full Limited Access Control Facilities

Type of Terrain	Design Speed (mph)						
	50	55	60	65	70	75	80
Level	4	4	3	3	3	3	3
Rolling	5	5	4	4	4	4	4
Mountainous	6-7	6-7	6-7	6-7	5-6	5-6	5-6

1220.02(6) Alignment on Structures

Where practicable, avoid high skew, vertical curvature, horizontal curvature, and superelevation on structures, but do not sacrifice safe roadway alignment to achieve this.

1220.03 Coordination of Vertical and Horizontal Alignments

Do not design horizontal and vertical alignments independently. Coordinate them to obtain uniform speed, pleasing appearance, and efficient traffic operation. Coordination can be achieved by plotting the location of the horizontal curves on the working profile to help visualize the highway in three dimensions. Perspective plots will also give a view of the proposed alignment. Exhibits 1220-2a and 2b show sketches of desirable and undesirable coordination of horizontal and vertical alignment.

Guides for the coordination of the vertical and horizontal alignment are as follows:

- Balance curvature and grades. Using steep grades to achieve long tangents and flat curves or excessive curvature to achieve flat grades are both poor designs.
- Vertical curvature superimposed on horizontal curvature generally results in a more pleasing facility. Successive changes in profile not in combination with horizontal curvature may result in a series of dips not visible to the driver.
- Do not begin or end a horizontal curve at or near the top of a crest vertical curve. A driver may not recognize the beginning or ending of the horizontal curve, especially at night. An alignment where the horizontal curve leads the vertical curve and is longer than the vertical curve in both directions is desirable.

- To maintain drainage, design vertical and horizontal curves so that the flat profile of a vertical curve is not located near the flat cross slope of the superelevation transition.
- Do not introduce a sharp horizontal curve at or near the low point of a pronounced sag vertical curve. The road ahead is foreshortened and any horizontal curve that is not flat assumes an undesirably distorted appearance. Further, vehicular speeds, particularly of trucks, often are high at the bottom of grades and erratic operation may result, especially at night.
- On two-lane roads, the need for passing sections (at frequent intervals and for an appreciable percentage of the length of the roadway) often supersedes the general desirability for the combination of horizontal and vertical alignment. Work toward long tangent sections to secure sufficient passing sight distance.
- On divided highways, consider variation in the width of medians and the use of independent alignments to derive the design and operational advantages of one-way roadways.
- Make the horizontal curvature and profile as flat as practicable at intersections where sight distance along both roads is important and vehicles may have to slow or stop.
- In residential areas, design the alignment to minimize nuisance factors to the neighborhood. Generally, a depressed facility makes a highway less visible and less noisy to adjacent residents. Minor horizontal adjustments can sometimes be made to increase the buffer zone between the highway and clusters of homes.
- Design the alignment to enhance attractive scenic views of the natural and constructed environment, such as rivers, rock formations, parks, and outstanding buildings.

When superelevation transitions fall within the limits of a vertical curve, plot profiles of the edges of pavement and check for smooth transitions.

1220.04 Airport Clearance

Contact the airport authorities early for proposed highway construction or alteration in the vicinity of a public or military airport, so that advance planning and design work can proceed within the required Federal Aviation Administration (FAA) regulations (see the [Environmental Manual](#)).

1220.05 Railroad Crossings

When a highway crosses a railroad at grade, design the highway grade to prevent low-hung vehicles from damaging the rails or getting hung up on the tracks. [Exhibit 1220-3](#) gives guidance on designing highway grades at railroad crossings. For more information on railroad-highway crossings, see [Chapter 1350](#).

1220.06 Procedures

When the project modifies the vertical alignment, develop vertical alignment plans for inclusion in the Plans, Specifications, and Estimates (PS&E) to a scale suitable for showing vertical alignment for all proposed roadways, including ground line, grades, vertical curves, and superelevation. (See the [Plans Preparation Manual](#) for guidance.)

When justifying any modification to the vertical alignment, include the reasons for the change, alternatives addressed (if any) and why the selected alternative was chosen. When the profile is a result of new horizontal alignment, develop vertical and horizontal alignments together, and include the profile with the horizontal alignment justification.

1220.07 Documentation

Refer to [Chapter 300](#) for design documentation requirements.

1220.08 References

1220.08(1) Federal/State Laws and Codes

[Washington Administrative Code \(WAC\) 468-18-040](#), Design standards for rearranged county roads, frontage roads, access roads, intersections, ramps and crossings

1220.08(2) Design Guidance

[Local Agency Guidelines](#) (LAG), M 36-63, WSDOT

[Manual on Uniform Traffic Control Devices for Streets and Highways](#), USDOT, FHWA; as adopted and modified by Chapter [468-95 WAC](#) "Manual on uniform traffic control devices for streets and highways" (MUTCD)

[Plans Preparation Manual](#), M 22-31, WSDOT

1220.08(3) Supporting Information

[A Policy on Geometric Design of Highways and Streets](#) (Green Book), AASHTO, current edition

Exhibit 1220-2a Coordination of Horizontal and Vertical Alignments

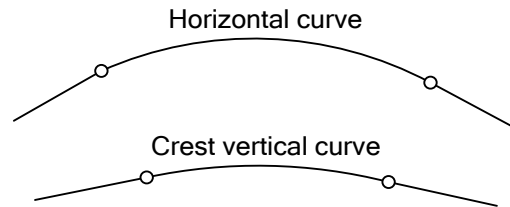
**Coinciding Horizontal and Crest Vertical Curves**

When horizontal and crest vertical curves coincide, a satisfactory appearance results.

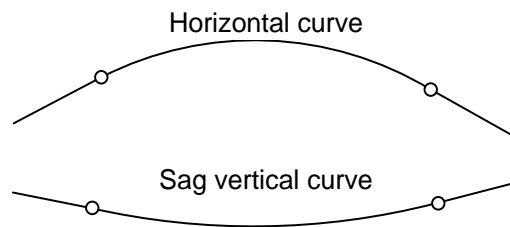
**Coinciding Horizontal and Sag Vertical Curves**

When horizontal and sag vertical curves coincide, a satisfactory appearance results.

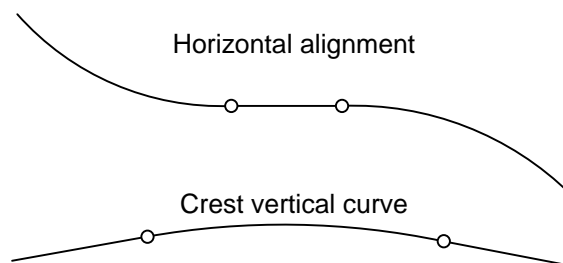
**Short Tangent on a Crest Between Two Horizontal Curves**

This combination is deficient for several reasons:

- The curve reversal is on a crest, making the second curve less visible.
- The tangent is too short for the superelevation transition.
- The flat area of the superelevation transition will be near the flat grade in the crest.

Exhibit 1220-2b Coordination of Horizontal and Vertical Alignments

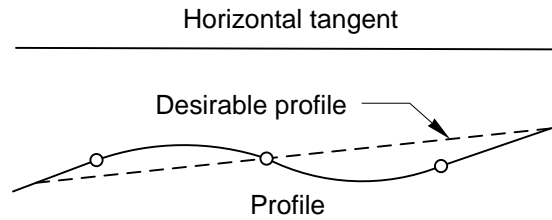

Profile With Tangent Alignment

Avoid designing dips on an otherwise long uniform grade.

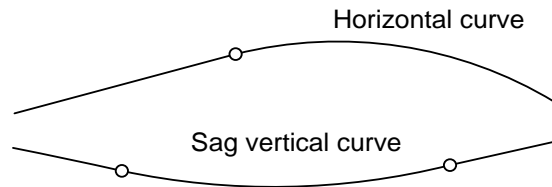

Sharp Angle Appearance

This combination presents a poor appearance. The horizontal curve looks like a sharp angle.

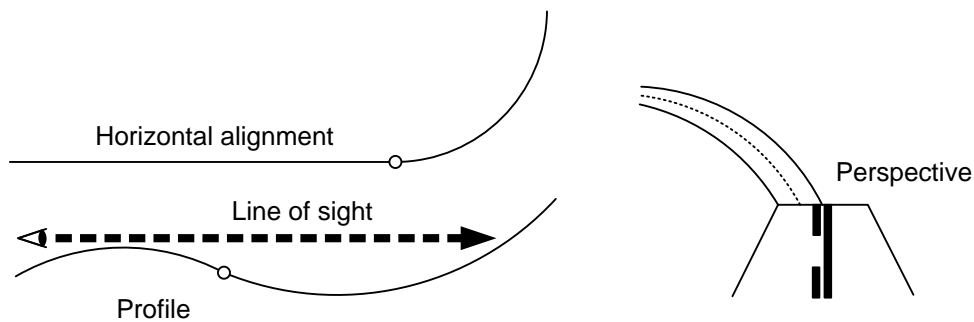

Disjointed Effect

A disjointed effect occurs when the beginning of a horizontal curve is hidden by an intervening crest while the continuation of the curve is visible in the distance beyond the intervening crest.

Exhibit 1220-2c Coordination of Horizontal and Vertical Alignments

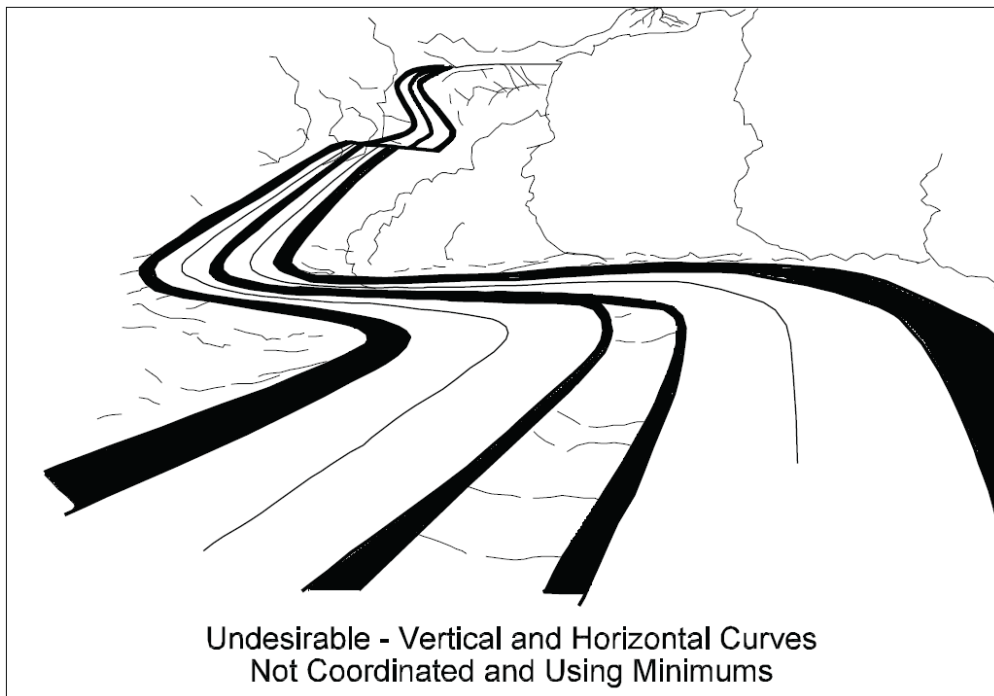
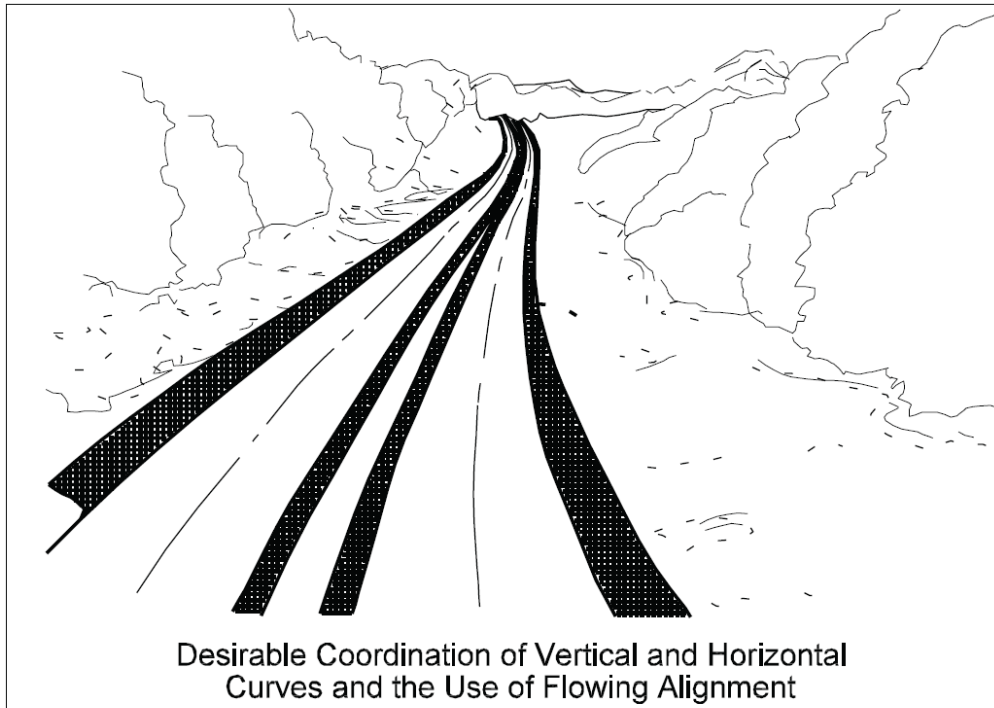
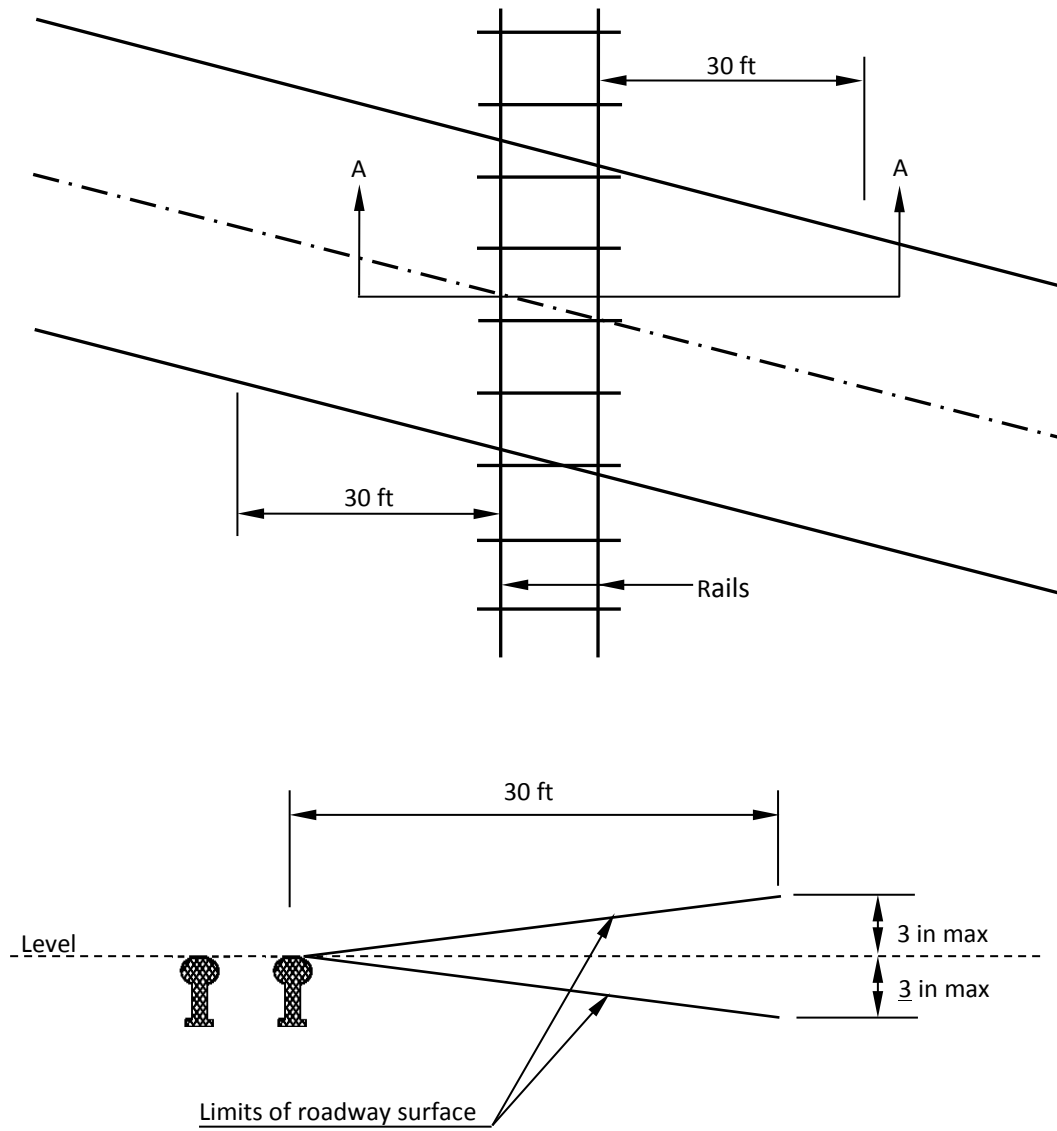

Exhibit 1220-3 Grading at Railroad Crossings



1230.01	General
1230.02	Context and Modally Integrated Cross Sections
1230.03	Cross Section Zones and Elements
1230.04	Medians and Outer Separations
1230.05	Curbs
1230.06	Cross Slope
1230.07	Structure Width
1230.08	Documentation
1230.09	References

1230.01 General

Geometric cross sections for state highways are governed by the need to balance identified performance metrics (see [Chapters 1101](#) and [1104](#)), the context (see [Chapter 1102](#)) and selected design controls (see [Chapter 1103](#)). The objective is to optimize the use of available public space and/or reasonable investment in right of way acquisition. The geometric cross section is composed of multiple lateral design elements such as lanes, shoulders, medians, bike facilities, and sidewalks. The design task is to select and size these elements according to, designated performance target(s), design controls, and context. There is flexibility in the selection of design elements, dimensioning (see [Chapter 1106](#)), and configurations to obtain the desired level of performance for a given mode and/or context.

1230.02 Context and Modally Integrated Cross Sections

The geometric cross section of a roadway is composed of different zones. The cross-section examples shown in [Exhibits 1230-2a](#) through [1230-6d](#) depict various configurations that may be included in a cross section. The examples are included to stimulate designer creativity and awareness of modal accommodations, and are not intended to be standard cross sections to be reproduced for a given modal orientation. The cross section examples show what is possible for specific contexts and performance needs. It is expected that project alternatives will innovative diverse configurations to best balance baseline and contextual needs (see [Chapter 1101](#)) for the modes and contexts represented. The cross section examples present ranges to achieve different performance needs.

The cross section configurations also provide a range of dimensions for different design elements that are the basis of dimensioning an element (see [1230.03](#)). For a more detailed explanation of each cross section zone or element that makes up a cross section, see [1230.04](#). Higher-range values are presented as boundaries to consider for cost; however, exceeding those ranges in median, streetside, and roadside design is acceptable and encouraged in some contexts and is situationally dependent.

1230.02(1) Jurisdictional Design and Maintenance

On all state highways in rural locations outside of cities or towns or limited access design areas, geometric design is to be consistent with this *Design Manual*.

On state highways within an incorporated city or town, develop design features in cooperation with the local agency. For NHS routes, use the *Design Manual*. For non-NHS routes, the [Local](#)

Agency Guidelines may be used for dimensioning design elements using the Criteria Based Method. However, use of Quantitative Methods for dimensioning design elements may provide additional flexibility and is recommended (see [Chapter 1106](#) for additional information about the dimensioning methods).

Cross-sectional design within incorporated cities or towns can get complicated due to the joint-jurisdictional authority. WSDOT typically has jurisdiction of the traveled way zone, and cities typically have jurisdiction of the streetside zones (see [Exhibit 1230-1](#)). When no curb is present, the city or town holds responsibility for the roadside beyond the paved shoulder. Despite the jurisdictional differences, it is extremely important to cooperatively determine a cross-sectional design. Design elements within the streetside or roadside zones are necessary to emphasize the traveled way zone design, and vice-versa.

Refer to [Chapter 301](#) for additional information on jurisdictional maintenance responsibilities and considerations for maintenance agreements

Exhibit 1230-1 State and City Jurisdictional Responsibilities

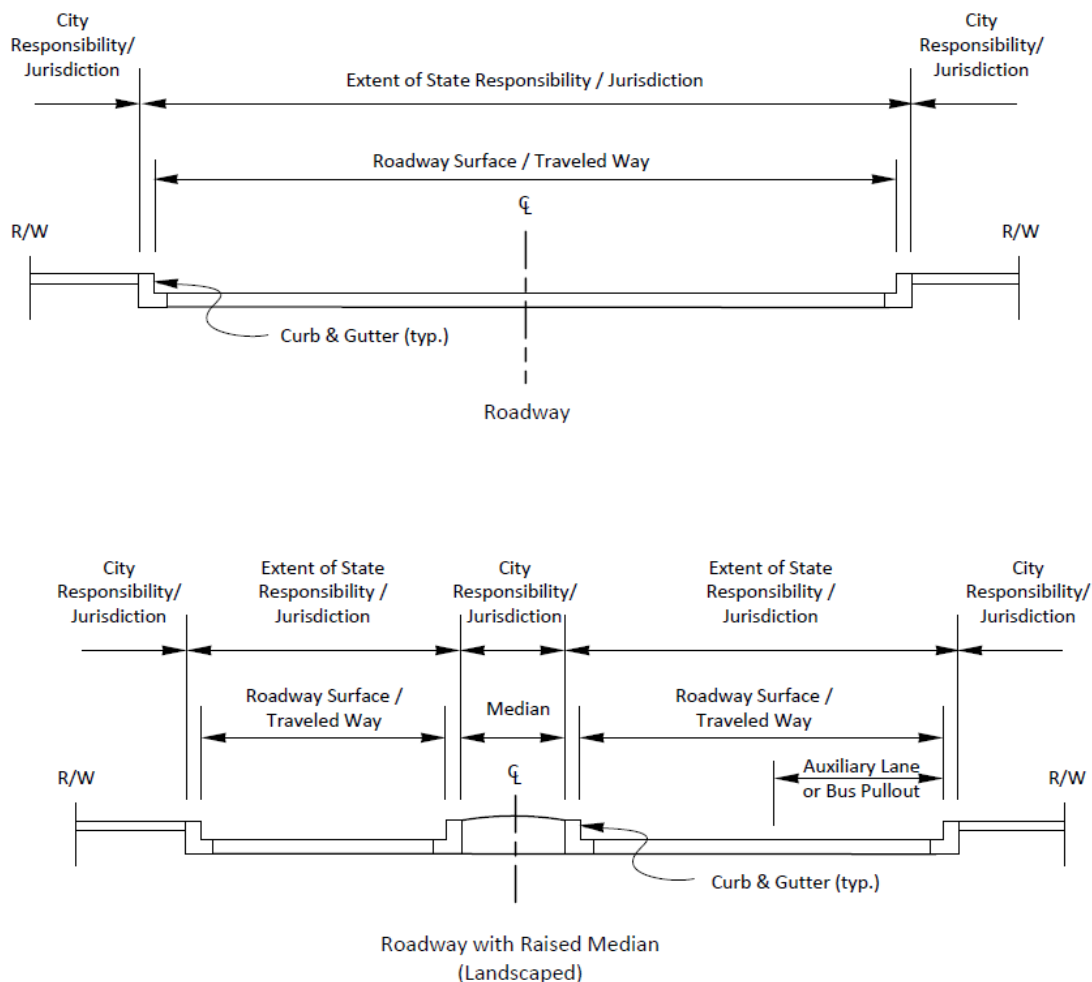

1230.02(2) Pedestrian-Oriented Cross Sections

Exhibits [1230-2a](#) and [1230-2b](#) are cross-section examples prioritized for pedestrian mode. The pedestrian mode is a vital transportation mode, since for most people nearly every trip at least begins and ends by walking. Roadway facilities prioritized for pedestrians emphasize streetside zone elements. The objective is to achieve the Pedestrian Circulation Path (PCP) necessary to support the mobility, socioeconomic, and accessibility needs for the mode and context, and/or the pedestrian needs necessary for mobility, safety, and accessibility to intermodal connections. The configuration and dimension of streetside zone elements varies significantly depending on the performance metrics being addressed. (See [Chapter 1510](#) for additional pedestrian design requirements and considerations.)

1230.02(3) Bicycle-Oriented Cross Sections

[Exhibit 1230-3a](#) is an example cross section oriented for bicyclists on an intermediate-speed location. The decision on where to place the bike lane within the cross section depends largely on the type of land use and how cyclists will interact with the land use and potential modal conflicts. Locating bike lanes on the outside of the motor vehicle lanes can better enable meeting accessibility performance needs. If cyclist mobility performance is a primary concern or intermodal conflicts (such as transit stop locations) are present, locating bike facilities in

the center of the roadway may be more appropriate. Whether or not a bike lane buffer is needed depends mostly on the target speed and average daily traffic (ADT) of the facility; the intent of bike buffers or other protected bike facilities is to address safety performance for cyclists. Buffers and other means of modal segregation also benefit motor vehicle drivers and pedestrians by showing allocated spaces. Both roadway bike lane configurations and bike facility selection are discussed in more detail in [Chapter 1520](#); some considerations are also provided in [Exhibit 1230-3b](#).

1230.02(4) Transit-Oriented Cross Sections

Exhibits [1230-4a](#) through [1230-4c](#) provide examples of different potential configurations oriented for the transit mode. Cross section design for the transit mode relies on managing multiple modal conflicts and competing performance with other modes. Ultimately, transit providers must determine their ability to operate within a given cross-sectional arrangement. In general, transit configurations can be oriented toward the side or center of a roadway section. This is true for many different forms of transit vehicles (such as various fixed guideway transit vehicles and bus types). Either side or center configurations can be implemented with medians or outer separations to improve safety performance for intermodal connections or mobility performance for the transit service.

[Exhibit 1230-4a](#) shows a central configuration for transit service that provides a separated bus-only lanes cross section for transit operations. Other transit vehicle types may require different widths and may also require other center cross section configurations for passenger loading. Consider increasing lane widths on turning roadways (see [Chapter 1240](#)). [Exhibit 1230-4b](#) shows a side configuration where transit vehicles occupy the outside lane, this example can also be configured as business access and transit [BAT] lanes like those found in the Seattle area. Note the importance of streetside zone elements to assist with intermodal connections. [Exhibit 1230-4c](#) is an example of a type of special use lane for high-speed and routinely congested routes. In this example, the shoulder allows the restricted use for buses. This configuration requires

additional treatments at on-/off-ramps and/or intersections, and other operational and maintenance considerations.

1230.02(5) Freight- and Auto-Oriented Cross Sections

Exhibits [1230-5a](#) through [1230-5c](#) are examples of a motorized vehicle-oriented design. Motorized vehicles come in a variety of types, which cohabitate on many vehicle lanes and parking zone areas. The performance needs of freight and other automotive vehicle types are often similar. However, certain truck vehicle types may require additional turning roadway width for off-tracking (see [Chapter 1240](#)), or at other locations a truck climbing lane may be needed to facilitate mobility performance (see [Chapter 1270](#)). Generally, lane width within suburban and urban contexts is less critical for mobility and safety performance than in rural and high-speed contexts. An understanding of the needs of the type of freight truck should be vetted when designing for freight accessibility performance for more urban land uses. Generally, within urban areas, placement of and sizing for loading areas within the parking zone can depend on the freight vehicle type.

1230.02(6) Complete Street Cross Sections

Complete street configurations attempt to balance the performance needs of all users, regardless of age, ability, or mode. The general intent is to provide designs that enable the safe access for all design users with respect to context. In this way, many rural two-lane highways with wide shoulders for auto emergency use, as well as pedestrian and bicycle use, are considered complete streets; just as an urban section with vehicle lanes, bike lanes, bus lanes, and sidewalks would be considered a complete street. There are many different potential configurations for complete streets that provide equity to the design users present. In some cases, achieving a complete street is as simple as retrofitting the street to clearly mark and sign a shared-use lane. In other more complex environments with distinctive modal compatibilities, it may take the form of actually converting the roadway using a “road diet” application (see [1230.02\(6\)\(a\)](#)), reconfiguring the roadway cross section, or installing additional pedestrian crossings with greater frequency; see below for more detail on various configurations.

Utilizing different road types is one way to implement complete streets. [Exhibit 1230-6c](#) shows a multiway boulevard road type cross section, defined by the outer separation between the vehicle lanes and shared-use service lane. The service lane in this configuration enables land use accessibility and motor vehicle mobility by segregating the lanes. In this example, transit and bike conflicts are removed, and land use accessibility performance is provided by use of the service lane. It is important to recognize intermodal connectivity and conflicts that may occur with complete street configurations, particularly at nodes and/or transit stop locations.

Exhibit 1230-2a Pedestrian-Oriented Example Cross Section

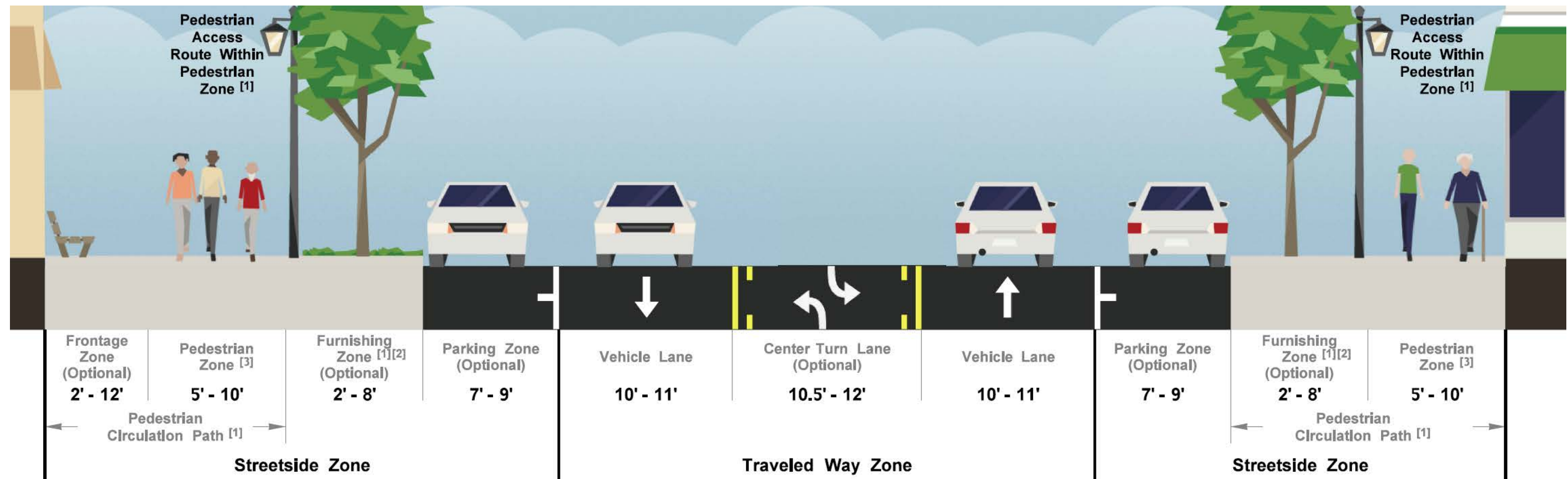
**Notes:**

These notes are repeated on Exhibits 1230-2a through 1230-6d. Locate notes on each drawing for applicability.

[1] See [Chapter 1510](#)

[2] Minimum width specified is exclusive of the curb width

[3] If no furnishing zone is provided, minimum width is exclusive of the curb width

[4] See [Chapter 1520](#) for bike facility selection and different configurations

[5] Verify width needs with transit provider, and see [Chapter 1430](#)

[6] Overall median width and design will vary depending on alignment design, available right of way, median function and other constraints.

[7] When using criteria-based dimensioning method (see [Chapter 1106](#)) on high speed (see [Chapter 1103](#)) facilities, lane widths are 12 feet minimum. Two-lane high speed highways may have an 11ft minimum lane width.

[8] When the criteria-based dimensioning method (see [Chapter 1106](#)) is used for high-speed (see [Chapter 1103](#)) facilities, inside shoulders must be 4ft minimum on facilities up to 4 lanes, and 10 ft minimum on 6 lane facilities. In mountainous terrain, inside shoulder may be reduced to 4ft on facilities up to 6 lanes.

[9] When the criteria-based dimensioning method (see [Chapter 1106](#)) is used for high-speed (see [Chapter 1103](#)) facilities, outside shoulders must be 10ft minimum. In mountainous terrain, outside shoulder may be reduced to 8ft on facilities up to 6 lanes. Two-lane high speed highways may have an 8ft minimum outside shoulder, and may be reduced to 4ft with justification.

Exhibit 1230-2b Pedestrian-Oriented Example Cross Section

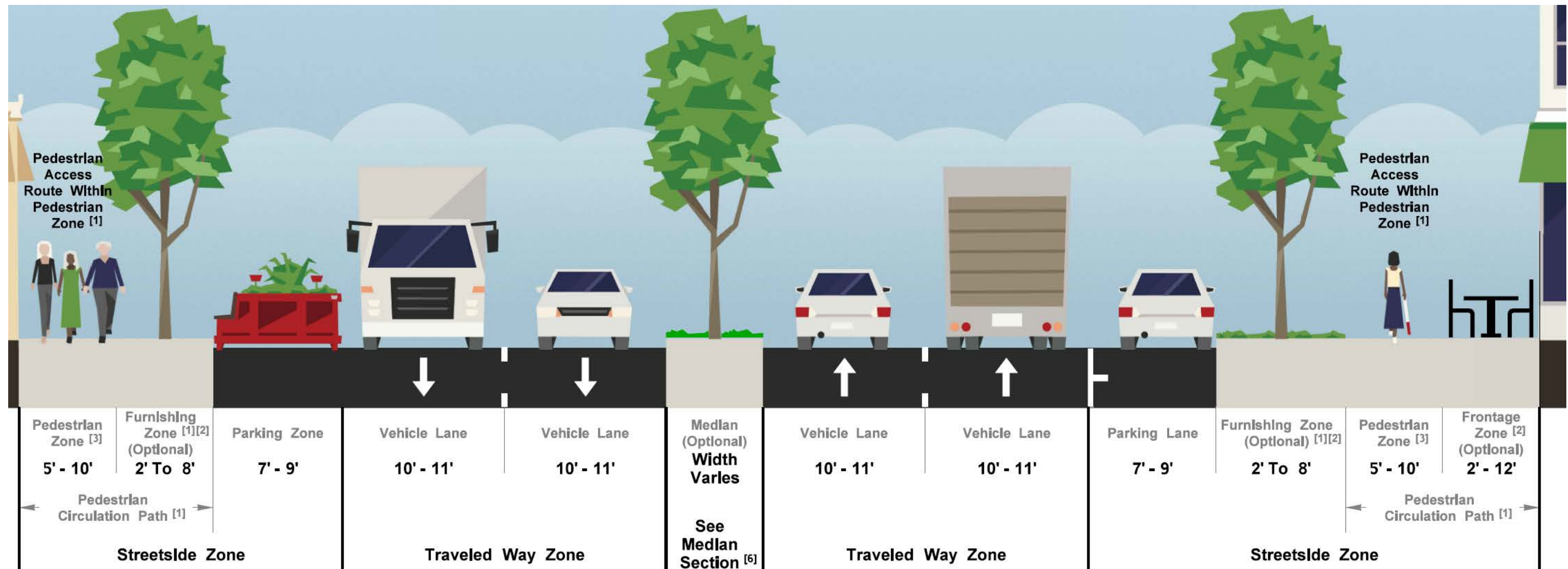

Notes:

These notes are repeated on Exhibits 1230-2a through 1230-6d. Locate notes on each drawing for applicability.

[1] See [Chapter 1510](#)

[2] Minimum width specified is exclusive of the curb width

[3] If no furnishing zone is provided, minimum width is exclusive of the curb width

[4] See [Chapter 1520](#) for bike facility selection and different configurations

[5] Verify width needs with transit provider, and see [Chapter 1430](#)

[6] Overall median width and design will vary depending on alignment design, available right of way, median function and other constraints.

[7] When using criteria-based dimensioning method (see [Chapter 1106](#)) on high speed (see [Chapter 1103](#)) facilities, lane widths are 12 feet minimum. Two-lane high speed highways may have an 11ft minimum lane width.

[8] When the criteria-based dimensioning method (see [Chapter 1106](#)) is used for high-speed (see [Chapter 1103](#)) facilities, inside shoulders must be 4ft minimum on facilities up to 4 lanes, and 10 ft minimum on 6 lane facilities. In mountainous terrain, inside shoulder may be reduced to 4ft on facilities up to 6 lanes.

[9] When the criteria-based dimensioning method (see [Chapter 1106](#)) is used for high-speed (see [Chapter 1103](#)) facilities, outside shoulders must be 10ft minimum. In mountainous terrain, outside shoulder may be reduced to 8ft on facilities up to 6 lanes. Two-lane high speed highways may have an 8ft minimum outside shoulder, and may be reduced to 4ft with justification.

Exhibit 1230-3a Bicycle-Oriented Example Cross Section for Intermediate-Speed Locations

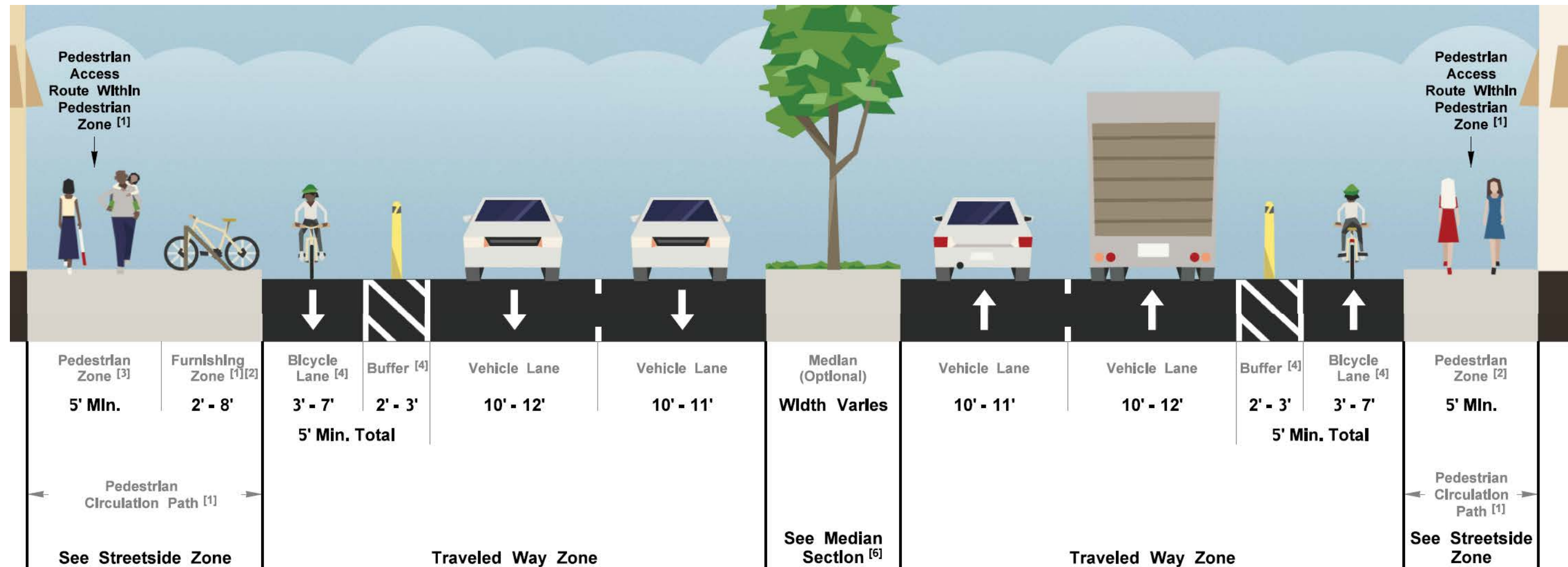

Notes:

These notes are repeated on Exhibits 1230-2a through 1230-6d. Locate notes on each drawing for applicability.

- [1] See [Chapter 1510](#)
- [2] Minimum width specified is exclusive of the curb width
- [3] If no furnishing zone is provided, minimum width is exclusive of the curb width
- [4] See [Chapter 1520](#) for bike facility selection and different configurations
- [5] Verify width needs with transit provider, and see [Chapter 1430](#)
- [6] Overall median width and design will vary depending on alignment design, available right of way, median function and other constraints.
- [7] When using criteria-based dimensioning method (see [Chapter 1106](#)) on high speed (see [Chapter 1103](#)) facilities, lane widths are 12 feet minimum. Two-lane high speed highways may have an 11ft minimum lane width.
- [8] When the criteria-based dimensioning method (see [Chapter 1106](#)) is used for high-speed (see [Chapter 1103](#)) facilities, inside shoulders must be 4ft minimum on facilities up to 4 lanes, and 10 ft minimum on 6 lane facilities. In mountainous terrain, inside shoulder may be reduced to 4ft on facilities up to 6 lanes.
- [9] When the criteria-based dimensioning method (see [Chapter 1106](#)) is used for high-speed (see [Chapter 1103](#)) facilities, outside shoulders must be 10ft minimum. In mountainous terrain, outside shoulder may be reduced to 8ft on facilities up to 6 lanes. Two-lane high speed highways may have an 8ft minimum outside shoulder, and may be reduced to 4ft with justification.

Exhibit 1230-3b Bicycle-Oriented Example Cross Section for Low-Speed Location

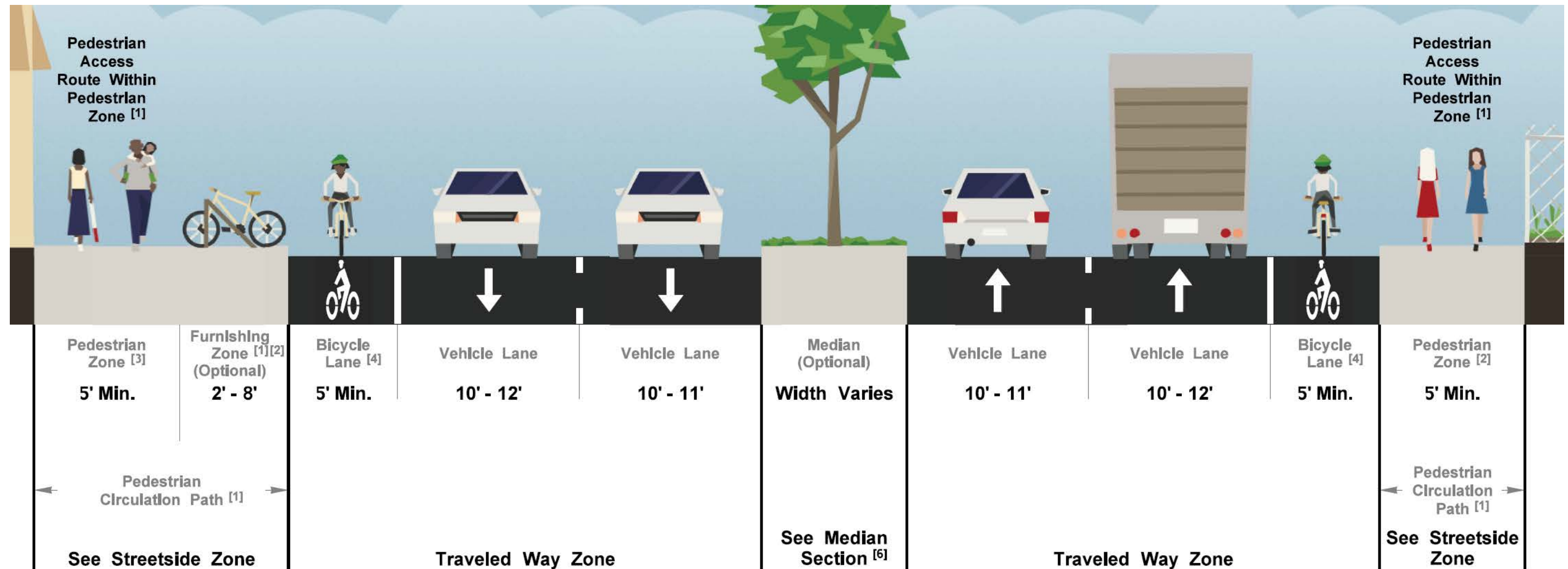

Notes:

These notes are repeated on Exhibits 1230-2a through 1230-6d. Locate notes on each drawing for applicability.

[1] See Chapter 1510

[2] Minimum width specified is exclusive of the curb width

[3] If no furnishing zone is provided, minimum width is exclusive of the curb width

[4] See Chapter 1520 for bike facility selection and different configurations

[5] Verify width needs with transit provider, and see Chapter 1430

[6] Overall median width and design will vary depending on alignment design, available right of way, median function and other constraints.

[7] When using criteria-based dimensioning method (see Chapter 1106) on high speed (see Chapter 1103) facilities, lane widths are 12 feet minimum. Two-lane high speed highways may have an 11ft minimum lane width.

[8] When the criteria-based dimensioning method (see Chapter 1106) is used for high-speed (see Chapter 1103) facilities, inside shoulders must be 4ft minimum on facilities up to 4 lanes, and 10 ft minimum on 6 lane facilities. In mountainous terrain, inside shoulder may be reduced to 4ft on facilities up to 6 lanes.

[9] When the criteria-based dimensioning method (see Chapter 1106) is used for high-speed (see Chapter 1103) facilities, outside shoulders must be 10ft minimum. In mountainous terrain, outside shoulder may be reduced to 8ft on facilities up to 6 lanes. Two-lane high speed highways may have an 8ft minimum outside shoulder, and may be reduced to 4ft with justification.

Exhibit 1230-4a Transit-Oriented Cross Section Transit Boulevard

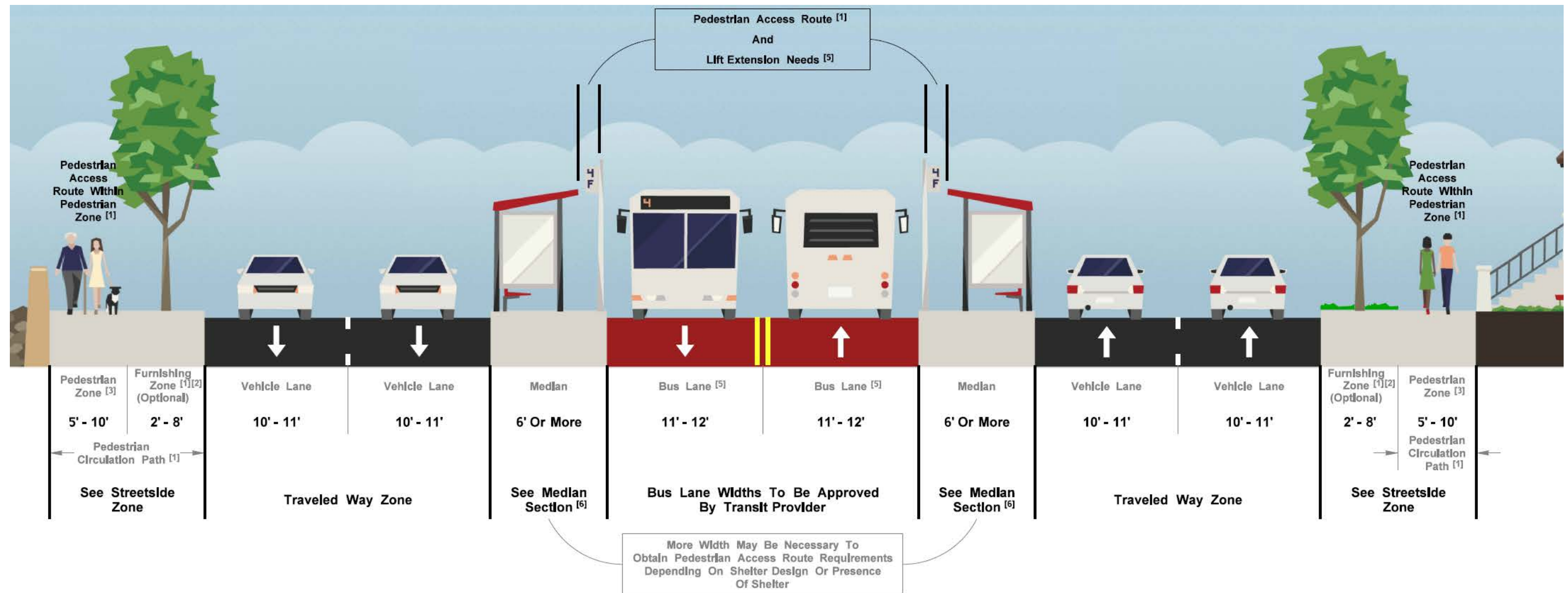

Notes:

These notes are repeated on Exhibits 1230-2a through 1230-6d. Locate notes on each drawing for applicability.

- [1] See [Chapter 1510](#)
- [2] Minimum width specified is exclusive of the curb width
- [3] If no furnishing zone is provided, minimum width is exclusive of the curb width
- [4] See [Chapter 1520](#) for bike facility selection and different configurations
- [5] Verify width needs with transit provider, and see [Chapter 1430](#)
- [6] Overall median width and design will vary depending on alignment design, available right of way, median function and other constraints.
- [7] When using criteria-based dimensioning method (see [Chapter 1106](#)) on high speed (see [Chapter 1103](#)) facilities, lane widths are 12 feet minimum. Two-lane high speed highways may have an 11ft minimum lane width.
- [8] When the criteria-based dimensioning method (see [Chapter 1106](#)) is used for high-speed (see [Chapter 1103](#)) facilities, inside shoulders must be 4ft minimum on facilities up to 4 lanes, and 10 ft minimum on 6 lane facilities. In mountainous terrain, inside shoulder may be reduced to 4ft on facilities up to 6 lanes.
- [9] When the criteria-based dimensioning method (see [Chapter 1106](#)) is used for high-speed (see [Chapter 1103](#)) facilities, outside shoulders must be 10ft minimum. In mountainous terrain, outside shoulder may be reduced to 8ft on facilities up to 6 lanes. Two-lane high speed highways may have an 8ft minimum outside shoulder, and may be reduced to 4ft with justification.

Exhibit 1230-4b Transit-Oriented Cross Section

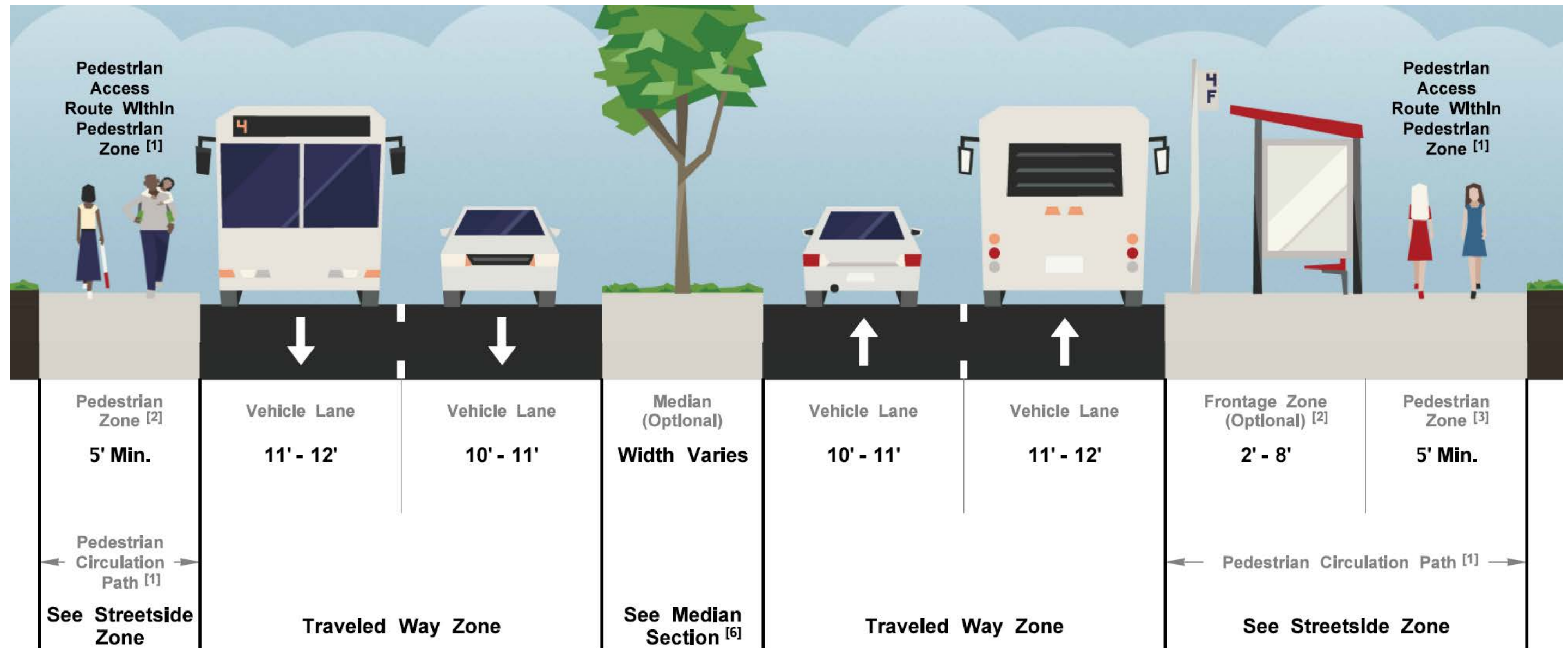

Notes:

These notes are repeated on Exhibits 1230-2a through 1230-6d. Locate notes on each drawing for applicability.

- [1] See [Chapter 1510](#)
- [2] Minimum width specified is exclusive of the curb width
- [3] If no furnishing zone is provided, minimum width is exclusive of the curb width
- [4] See [Chapter 1520](#) for bike facility selection and different configurations
- [5] Verify width needs with transit provider, and see [Chapter 1430](#)
- [6] Overall median width and design will vary depending on alignment design, available right of way, median function and other constraints.
- [7] When using criteria-based dimensioning method (see [Chapter 1106](#)) on high speed (see [Chapter 1103](#)) facilities, lane widths are 12 feet minimum. Two-lane high speed highways may have an 11ft minimum lane width.
- [8] When the criteria-based dimensioning method (see [Chapter 1106](#)) is used for high-speed (see [Chapter 1103](#)) facilities, inside shoulders must be 4ft minimum on facilities up to 4 lanes, and 10 ft minimum on 6 lane facilities. In mountainous terrain, inside shoulder may be reduced to 4ft on facilities up to 6 lanes.
- [9] When the criteria-based dimensioning method (see [Chapter 1106](#)) is used for high-speed (see [Chapter 1103](#)) facilities, outside shoulders must be 10ft minimum. In mountainous terrain, outside shoulder may be reduced to 8ft on facilities up to 6 lanes. Two-lane high speed highways may have an 8ft minimum outside shoulder, and may be reduced to 4ft with justification.

Exhibit 1230-4c Transit-Oriented Cross Section Hard Running Shoulder

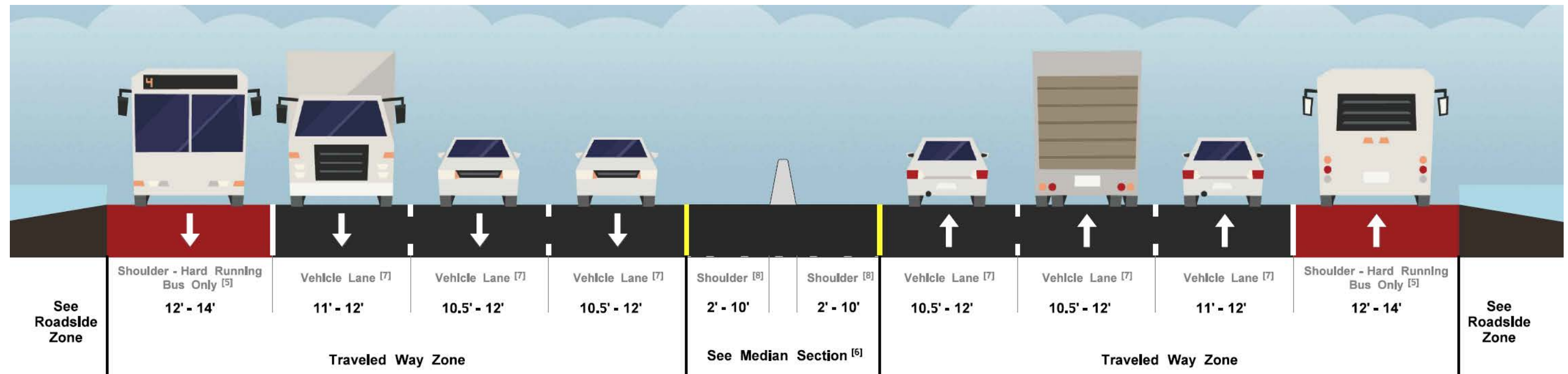
**Notes:**

These notes are repeated on Exhibits 1230-2a through 1230-6d. Locate notes on each drawing for applicability.

- [1] See [Chapter 1510](#)
- [2] Minimum width specified is exclusive of the curb width
- [3] If no furnishing zone is provided, minimum width is exclusive of the curb width
- [4] See [Chapter 1520](#) for bike facility selection and different configurations
- [5] Verify width needs with transit provider, and see [Chapter 1430](#)
- [6] Overall median width and design will vary depending on alignment design, available right of way, median function and other constraints.
- [7] When using criteria-based dimensioning method (see [Chapter 1106](#)) on high speed (see [Chapter 1103](#)) facilities, lane widths are 12 feet minimum. Two-lane high speed highways may have an 11ft minimum lane width.
- [8] When the criteria-based dimensioning method (see [Chapter 1106](#)) is used for high-speed (see [Chapter 1103](#)) facilities, inside shoulders must be 4ft minimum on facilities up to 4 lanes, and 10 ft minimum on 6 lane facilities. In mountainous terrain, inside shoulder may be reduced to 4ft on facilities up to 6 lanes.
- [9] When the criteria-based dimensioning method (see [Chapter 1106](#)) is used for high-speed (see [Chapter 1103](#)) facilities, outside shoulders must be 10ft minimum. In mountainous terrain, outside shoulder may be reduced to 8ft on facilities up to 6 lanes. Two-lane high speed highways may have an 8ft minimum outside shoulder, and may be reduced to 4ft with justification.

Exhibit 1230-5a Motorized Vehicle-Oriented Cross Section

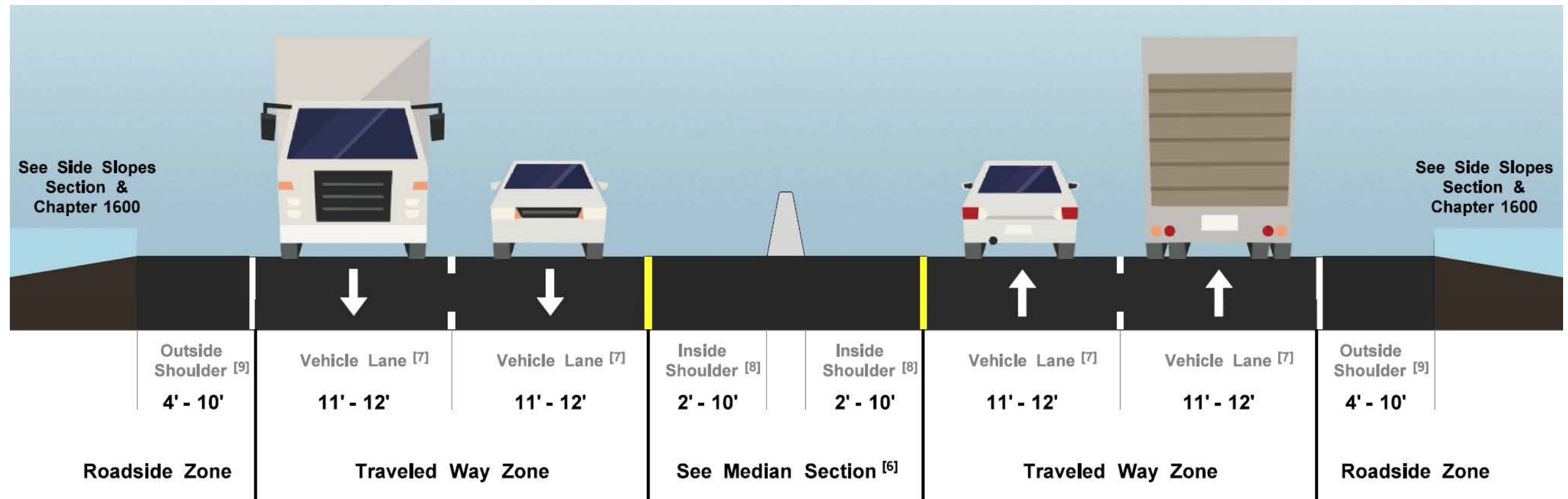

Notes:

These notes are repeated on Exhibits 1230-2a through 1230-6d. Locate notes on each drawing for applicability.

- [1] See [Chapter 1510](#)
- [2] Minimum width specified is exclusive of the curb width
- [3] If no furnishing zone is provided, minimum width is exclusive of the curb width
- [4] See [Chapter 1520](#) for bike facility selection and different configurations
- [5] Verify width needs with transit provider, and see [Chapter 1430](#)
- [6] Overall median width and design will vary depending on alignment design, available right of way, median function and other constraints.
- [7] When using criteria-based dimensioning method (see [Chapter 1106](#)) on high speed (see [Chapter 1103](#)) facilities, lane widths are 12 feet minimum. Two-lane high speed highways may have an 11ft minimum lane width.
- [8] When the criteria-based dimensioning method (see [Chapter 1106](#)) is used for high-speed (see [Chapter 1103](#)) facilities, inside shoulders must be 4ft minimum on facilities up to 4 lanes, and 10 ft minimum on 6 lane facilities. In mountainous terrain, inside shoulder may be reduced to 4ft on facilities up to 6 lanes.
- [9] When the criteria-based dimensioning method (see [Chapter 1106](#)) is used for high-speed (see [Chapter 1103](#)) facilities, outside shoulders must be 10ft minimum. In mountainous terrain, outside shoulder may be reduced to 8ft on facilities up to 6 lanes. Two-lane high speed highways may have an 8ft minimum outside shoulder, and may be reduced to 4ft with justification.

Exhibit 1230-5b Motorized Vehicle-Oriented Cross Section

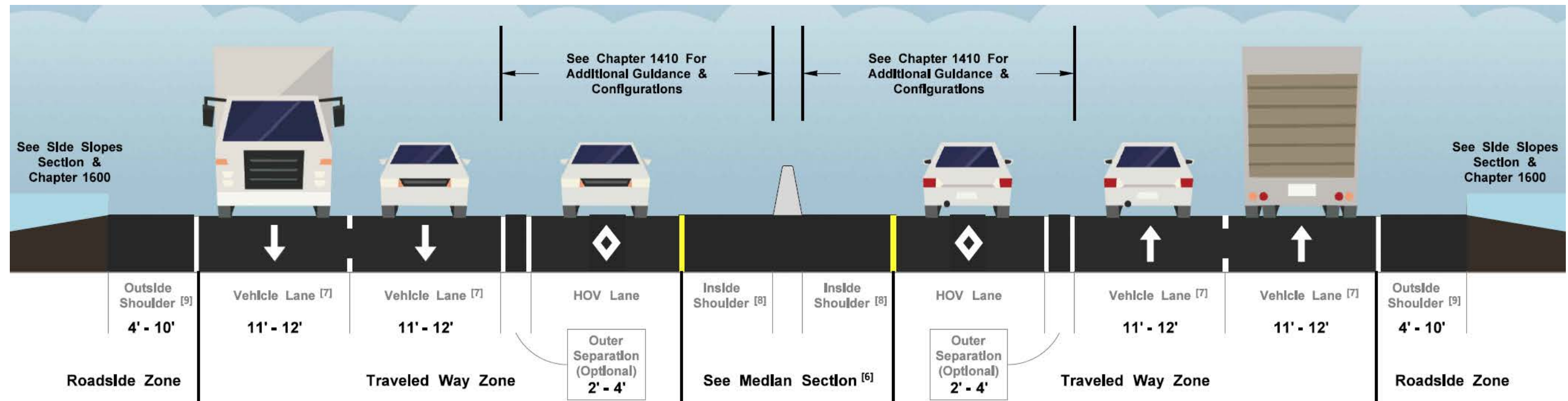
**Notes:**

These notes are repeated on Exhibits 1230-2a through 1230-6d. Locate notes on each drawing for applicability.

- [1] See [Chapter 1510](#)
- [2] Minimum width specified is exclusive of the curb width
- [3] If no furnishing zone is provided, minimum width is exclusive of the curb width
- [4] See [Chapter 1520](#) for bike facility selection and different configurations
- [5] Verify width needs with transit provider, and see [Chapter 1430](#)
- [6] Overall median width and design will vary depending on alignment design, available right of way, median function and other constraints.
- [7] When using criteria-based dimensioning method (see [Chapter 1106](#)) on high speed (see [Chapter 1103](#)) facilities, lane widths are 12 feet minimum. Two-lane high speed highways may have an 11ft minimum lane width.
- [8] When the criteria-based dimensioning method (see [Chapter 1106](#)) is used for high-speed (see [Chapter 1103](#)) facilities, inside shoulders must be 4ft minimum on facilities up to 4 lanes, and 10 ft minimum on 6 lane facilities. In mountainous terrain, inside shoulder may be reduced to 4ft on facilities up to 6 lanes.
- [9] When the criteria-based dimensioning method (see [Chapter 1106](#)) is used for high-speed (see [Chapter 1103](#)) facilities, outside shoulders must be 10ft minimum. In mountainous terrain, outside shoulder may be reduced to 8ft on facilities up to 6 lanes. Two-lane high speed highways may have an 8ft minimum outside shoulder, and may be reduced to 4ft with justification.

Exhibit 1230-5c Motorized Vehicle-Oriented Cross Section

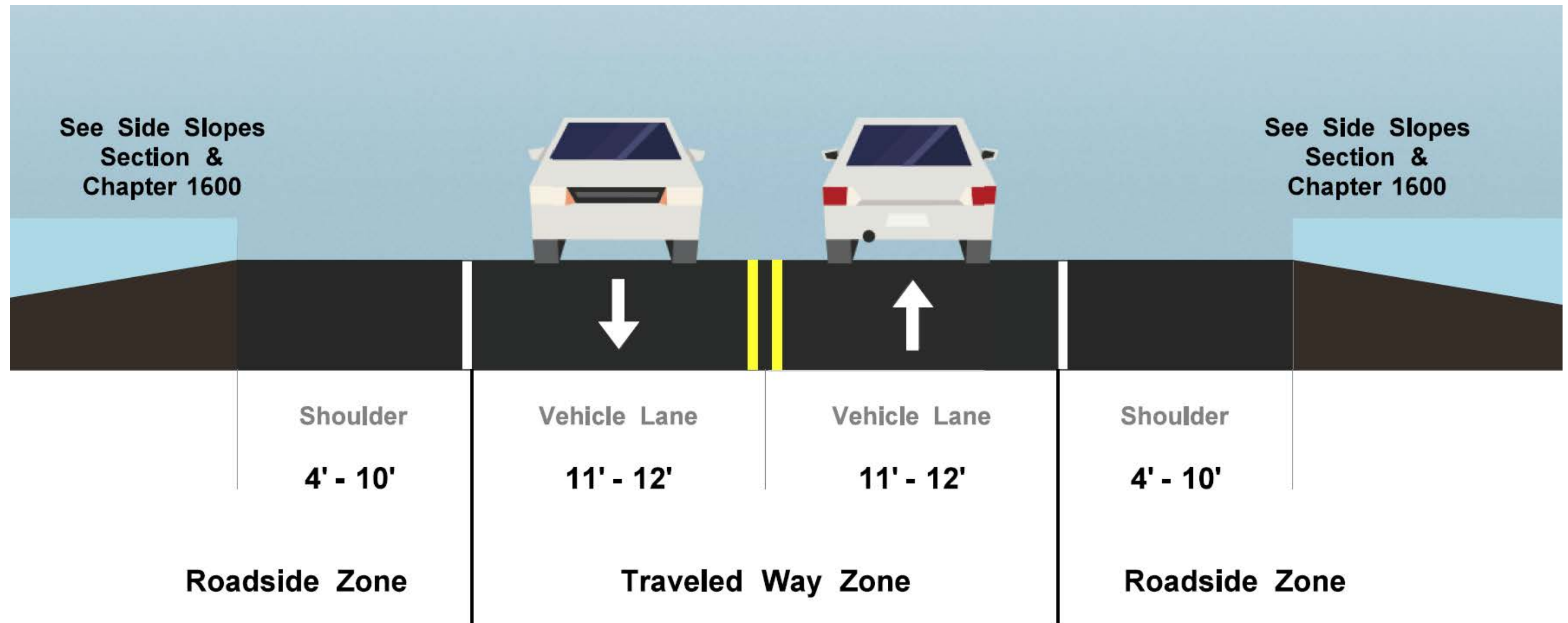

Notes:

These notes are repeated on Exhibits 1230-2a through 1230-6d. Locate notes on each drawing for applicability.

- [1] See [Chapter 1510](#)
- [2] Minimum width specified is exclusive of the curb width
- [3] If no furnishing zone is provided, minimum width is exclusive of the curb width
- [4] See [Chapter 1520](#) for bike facility selection and different configurations
- [5] Verify width needs with transit provider, and see [Chapter 1430](#)
- [6] Overall median width and design will vary depending on alignment design, available right of way, median function and other constraints.
- [7] When using criteria-based dimensioning method (see [Chapter 1106](#)) on high speed (see [Chapter 1103](#)) facilities, lane widths are 12 feet minimum. Two-lane high speed highways may have an 11ft minimum lane width.
- [8] When the criteria-based dimensioning method (see [Chapter 1106](#)) is used for high-speed (see [Chapter 1103](#)) facilities, inside shoulders must be 4ft minimum on facilities up to 4 lanes, and 10 ft minimum on 6 lane facilities. In mountainous terrain, inside shoulder may be reduced to 4ft on facilities up to 6 lanes.
- [9] When the criteria-based dimensioning method (see [Chapter 1106](#)) is used for high-speed (see [Chapter 1103](#)) facilities, outside shoulders must be 10ft minimum. In mountainous terrain, outside shoulder may be reduced to 8ft on facilities up to 6 lanes. Two-lane high speed highways may have an 8ft minimum outside shoulder, and may be reduced to 4ft with justification.

Exhibit 1230-6a Complete Street – High-Speed Example Cross Section

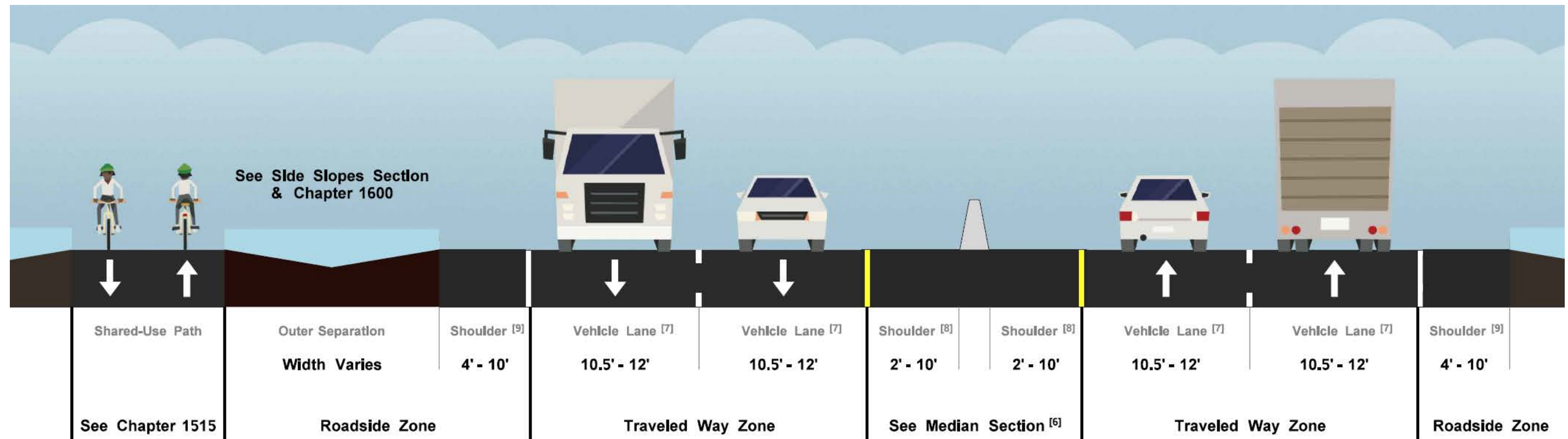

Notes:

These notes are repeated on Exhibits 1230-2a through 1230-6d. Locate notes on each drawing for applicability.

- [1] See [Chapter 1510](#)
- [2] Minimum width specified is exclusive of the curb width
- [3] If no furnishing zone is provided, minimum width is exclusive of the curb width
- [4] See [Chapter 1520](#) for bike facility selection and different configurations
- [5] Verify width needs with transit provider, and see [Chapter 1430](#)
- [6] Overall median width and design will vary depending on alignment design, available right of way, median function and other constraints.
- [7] When using criteria-based dimensioning method (see [Chapter 1106](#)) on high speed (see [Chapter 1103](#)) facilities, lane widths are 12 feet minimum. Two-lane high speed highways may have an 11ft minimum lane width.
- [8] When the criteria-based dimensioning method (see [Chapter 1106](#)) is used for high-speed (see [Chapter 1103](#)) facilities, inside shoulders must be 4ft minimum on facilities up to 4 lanes, and 10 ft minimum on 6 lane facilities. In mountainous terrain, inside shoulder may be reduced to 4ft on facilities up to 6 lanes.
- [9] When the criteria-based dimensioning method (see [Chapter 1106](#)) is used for high-speed (see [Chapter 1103](#)) facilities, outside shoulders must be 10ft minimum. In mountainous terrain, outside shoulder may be reduced to 8ft on facilities up to 6 lanes. Two-lane high speed highways may have an 8ft minimum outside shoulder, and may be reduced to 4ft with justification.

Exhibit 1230-6b Complete Street – Intermediate-Speed Example Cross Section

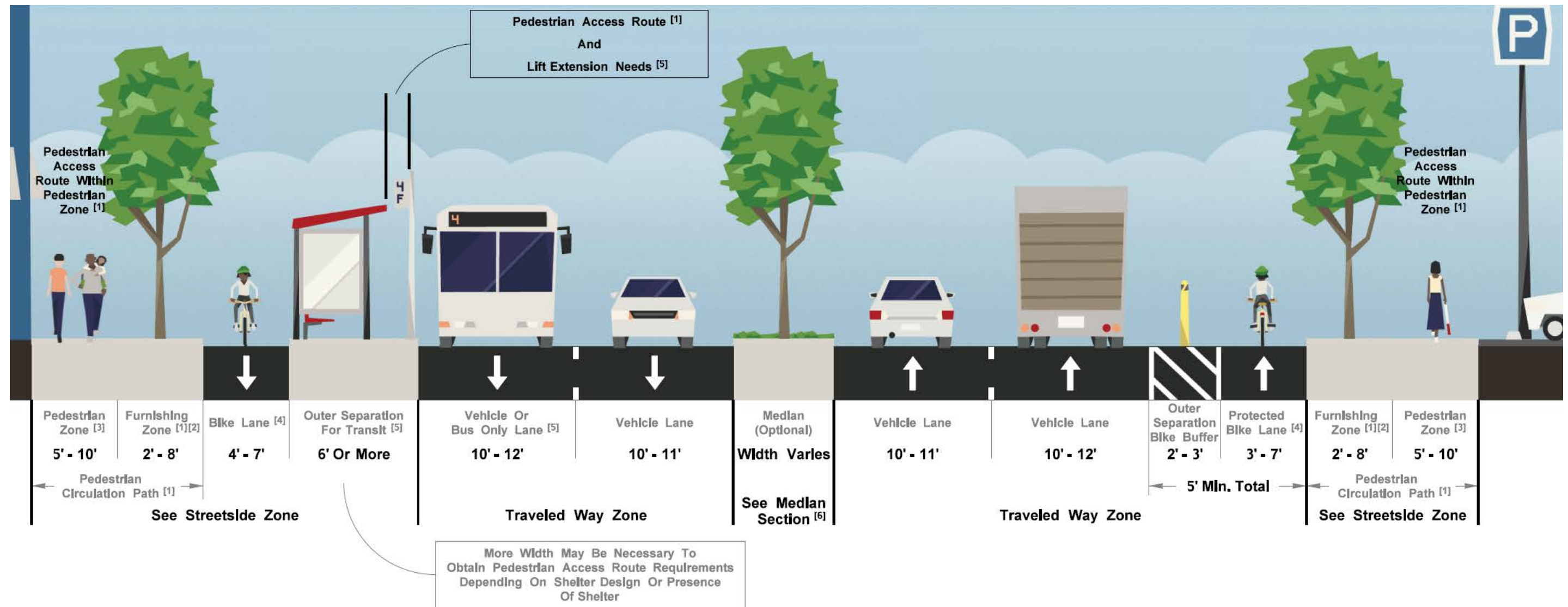

Notes:

These notes are repeated on Exhibits 1230-2a through 1230-6d. Locate notes on each drawing for applicability.

- [1] See [Chapter 1510](#)
- [2] Minimum width specified is exclusive of the curb width
- [3] If no furnishing zone is provided, minimum width is exclusive of the curb width
- [4] See [Chapter 1520](#) for bike facility selection and different configurations
- [5] Verify width needs with transit provider, and see [Chapter 1430](#)
- [6] Overall median width and design will vary depending on alignment design, available right of way, median function and other constraints.
- [7] When using criteria-based dimensioning method (see [Chapter 1106](#)) on high speed (see [Chapter 1103](#)) facilities, lane widths are 12 feet minimum. Two-lane high speed highways may have an 11ft minimum lane width.
- [8] When the criteria-based dimensioning method (see [Chapter 1106](#)) is used for high-speed (see [Chapter 1103](#)) facilities, inside shoulders must be 4ft minimum on facilities up to 4 lanes, and 10 ft minimum on 6 lane facilities. In mountainous terrain, inside shoulder may be reduced to 4ft on facilities up to 6 lanes.
- [9] When the criteria-based dimensioning method (see [Chapter 1106](#)) is used for high-speed (see [Chapter 1103](#)) facilities, outside shoulders must be 10ft minimum. In mountainous terrain, outside shoulder may be reduced to 8ft on facilities up to 6 lanes. Two-lane high speed highways may have an 8ft minimum outside shoulder, and may be reduced to 4ft with justification.

Exhibit 1230-6c Complete Street – Low- to Intermediate-Speed Multiway Boulevard Example Cross Section

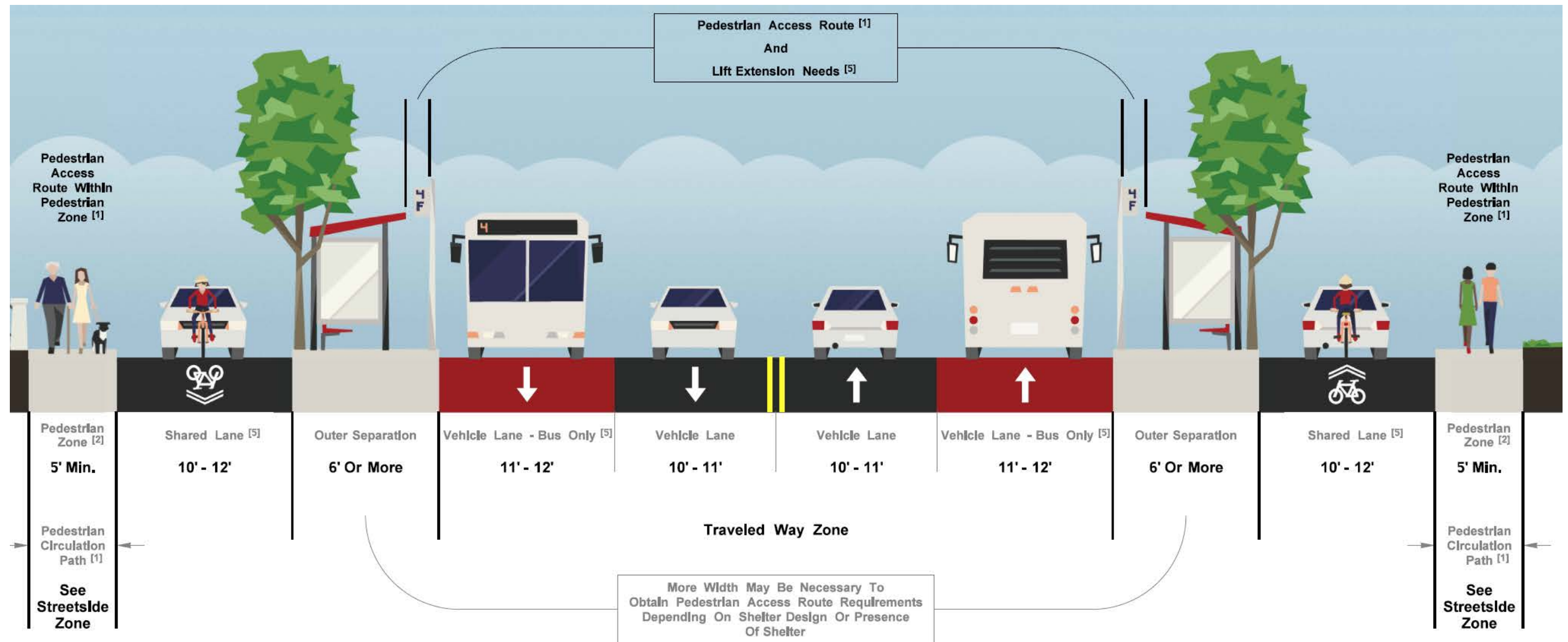
**Notes:**

These notes are repeated on Exhibits 1230-2a through 1230-6d. Locate notes on each drawing for applicability.

[1] See [Chapter 1510](#)

[2] Minimum width specified is exclusive of the curb width

[3] If no furnishing zone is provided, minimum width is exclusive of the curb width

[4] See [Chapter 1520](#) for bike facility selection and different configurations

[5] Verify width needs with transit provider, and see [Chapter 1430](#)

[6] Overall median width and design will vary depending on alignment design, available right of way, median function and other constraints.

[7] When using criteria-based dimensioning method (see [Chapter 1106](#)) on high speed (see [Chapter 1103](#)) facilities, lane widths are 12 feet minimum. Two-lane high speed highways may have an 11ft minimum lane width.

[8] When the criteria-based dimensioning method (see [Chapter 1106](#)) is used for high-speed (see [Chapter 1103](#)) facilities, inside shoulders must be 4ft minimum on facilities up to 4 lanes, and 10 ft minimum on 6 lane facilities. In mountainous terrain, inside shoulder may be reduced to 4ft on facilities up to 6 lanes.

[9] When the criteria-based dimensioning method (see [Chapter 1106](#)) is used for high-speed (see [Chapter 1103](#)) facilities, outside shoulders must be 10ft minimum. In mountainous terrain, outside shoulder may be reduced to 8ft on facilities up to 6 lanes. Two-lane high speed highways may have an 8ft minimum outside shoulder, and may be reduced to 4ft with justification.

Exhibit 1230-6d Complete Street – Low-Speed Main Street Example Cross Section

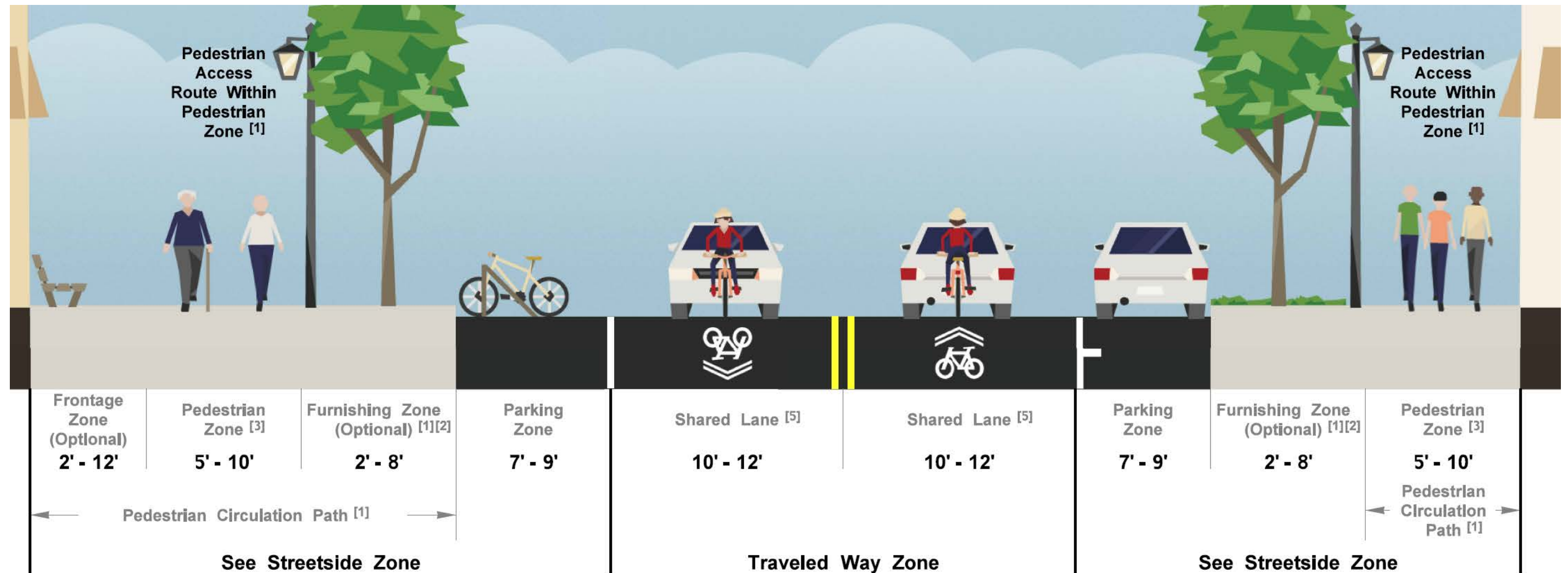

Notes:

These notes are repeated on Exhibits 1230-2a through 1230-6d. Locate notes on each drawing for applicability.

[1] See [Chapter 1510](#)

[2] Minimum width specified is exclusive of the curb width

[3] If no furnishing zone is provided, minimum width is exclusive of the curb width

[4] See [Chapter 1520](#) for bike facility selection and different configurations

[5] Verify width needs with transit provider, and see [Chapter 1430](#)

[6] Overall median width and design will vary depending on alignment design, available right of way, median function and other constraints.

[7] When using criteria-based dimensioning method (see [Chapter 1106](#)) on high speed (see [Chapter 1103](#)) facilities, lane widths are 12 feet minimum. Two-lane high speed highways may have an 11ft minimum lane width.

[8] When the criteria-based dimensioning method (see [Chapter 1106](#)) is used for high-speed (see [Chapter 1103](#)) facilities, inside shoulders must be 4ft minimum on facilities up to 4 lanes, and 10 ft minimum on 6 lane facilities. In mountainous terrain, inside shoulder may be reduced to 4ft on facilities up to 6 lanes.

[9] When the criteria-based dimensioning method (see [Chapter 1106](#)) is used for high-speed (see [Chapter 1103](#)) facilities, outside shoulders must be 10ft minimum. In mountainous terrain, outside shoulder may be reduced to 8ft on facilities up to 6 lanes. Two-lane high speed highways may have an 8ft minimum outside shoulder, and may be reduced to 4ft with justification.

1230.02(6)(a) Road Diets

Generally, road diets refer to converting four-lane undivided highways to three lanes with the center lane for left turning movements and the remaining outside space repurposed for bicyclists or other function. The center lane can consist of a two-way left-turn lane (TWLTL) or can be dedicated for directional left turns either by paint or median treatments. The choice of how to configure the center lane depends largely on balancing the resulting safety and accessibility performance of different modes and land uses.

The application of road diets also has the benefit of reallocating existing space within a cross section, which provides distinct opportunities to improve roadway bicycle facilities and/or elements of the streetside or roadside zones. At nodes and access points, a road diet can improve intersection sight distance, and in some cases improve mobility performance, for motorists.

The success of road diet implementation varies due to a number of factors such as signal spacing and timing, access connection density, modal priority, and average daily traffic (ADT). ADT is a reasonable indicator for implementation. FHWA recommends limiting road diet applications to roadways of 20,000 ADT or less, although road diets have been successful at locations with 25,000 ADT in various parts of the country. Motor vehicle mobility performance is most likely deemed the primary measure of success for the road diet configurations with higher ADT values described. However, locations with a different modal priority and higher ADT may still be candidates for road diets. The Region Traffic Engineer must approve road diet applications on state highways.

1230.02(6)(b) Retrofit Options

Retrofit options refer to the application of lower-cost treatments that utilize paint and other delineation devices rather than hardscape features. Retrofit applications are particularly useful when:

- Construction will occur in phases over a timeline greater than one year between phases where overlapping areas of work occur, or when elements or features are funded by a partnering agency.
- Implementing speed management treatments (see [Chapter 1103](#)) that, after evaluating their effectiveness, may need to be reconfigured.
- Funding is unable to adequately accomplish the identified scope of work.

Applied retrofit options may require additional maintenance over long-duration applications. Coordination with maintenance jurisdictions as described in [Chapter 301](#) is critical to evaluating the potential maintenance outcomes for retrofit options being considered. The retrofit options discussed within the following subsections, are more likely to be applied in urban context settings. Note that cities over 25,000 population will have the responsibility of maintaining any retrofit delineation, and it will be critical to ensure they have the resources to maintain striped retrofit features.

The following subsections describe several common applications of retrofit options.

1230.02(6)(b)(1) Relocate Curbs

Changes to the geometric cross section may involve relocating the existing curb. While installing a new curb may be preferred, there are a number of additional considerations (like stormwater conveyance) that make relocating curb lines cost-prohibitive. However, there are multiple retrofit solutions that can provide effective accommodation including, but not limited to:

- Striping combined with MUTCD-approved channelization devices.
- Curb extensions offset from the original curb. Depending on the use of the new curbed section, retrofit designs may include slotted grates tying the existing curb and new curb together, while maintaining the original stormwater conveyance system.
- Colorized pavement to delineate a change of use.

Use retrofit features as a low-cost solution to create wider sidewalk areas, curb extensions, bicycle parking areas, parklet areas, and/or green street low-impact development solutions.



Downtown City of Olympia 5th Avenue Curb Retrofit. Note that retrofits like this must comply with [1510.07\(1\)\(c\)](#), see [Chapter 1510](#).



“Moving the Curb” Photo courtesy of NACTO.org

1230.02(6)(b)(2) Parklets and Plazas

Parklets and plazas reuse existing right of way in urban and rural town centers, providing public space to support the economic vitality and social livability performance of a particular context. As geometric cross sections are reconfigured, spaces may become available at nodes or where repurposing a parking zone area into either plazas or parklets. The primary intent of presenting these treatments is for low-speed roadways or main streets with volumes at or below 20,000 ADT. However, there are many potential constraints external to the engineering design that may need resolution before application. Consult with Real Estate Services to discuss the specific property management-related concerns and any potential lease and/or economic payment considerations proportionally appropriate for utilization of the highway space in this manner, as further detailed in [RCW 47.24.020\(15\)](#).

A parklet specifically uses the parking zone to create a space for pedestrians. A common application provides seating accommodations to support local restaurants and shops. Parklet designs will vary depending on local jurisdiction regulations, but they typically include railing and/or planter boxes to provide a separation of uses between people and traffic. Parklet design should not cover catch basins or other features that may require frequent maintenance. Parklets interact with motorized vehicle traffic best when placed on tangent alignments.

Plazas can reuse right of way to define a relatively large common public space. Plazas are typically associated with a central gathering location for special events, and will likely have limited application on Washington state highways.





1230.03 Cross Section Zones and Elements

The geometric cross section of a roadway is comprised of different zones. Examples are shown in Exhibits [1230-2a](#) through [1230-6d](#), but these examples are not the only cross-sectional options available. Which zones to apply depends on the performance needs, context (see [Chapter 1102](#)) and design controls (see [Chapter 1103](#)) determined for a particular location. Which zonal design elements apply, and how they are configured within each zone, depends largely on the balance of performance needs determined and the context identified. The following subsection list the cross-sectional zones and their design elements.

Maintaining the continuity of a roadway is an important consideration in alternative formulation, particularly for limited access and other high-speed highways. However, it is also appropriate to intentionally change continuity in response to obvious changes in context, in order to impact driver behavior. When designing intentional changes to the continuity of the geometric cross section, it is important to consider what is needed to enable the transition. High-speed to low-speed changes will need to transition the geometric cross section over a distance utilizing a speed transition segment (see [Chapter 1103](#)). At other locations where low target speeds are already established, roadway changes can be more oriented around maintaining speed and operations..

1230.03(1) Traveled Way Zone

The traveled way zone refers to any lanes or buffers contained within either the edge lines or curbing when stripes are not provided, excluding any parking areas that may be present. The traveled way zone is typically only provided for motorized vehicles and bicycle modes. The traveled way zone includes all auxiliary and special-use lanes, and is therefore different from the term traveled way, which is used in other applications of roadway design.

1230.03(1)(a) Vehicle Lanes

There are many types of lanes that may exist in a cross section and each has its own purpose and sizing needs. General-purpose traffic lanes need to accommodate a variety of vehicle types, including buses, freight vehicles, personal automotive vehicles, and in some cases bicycles. The target speed, modal priority, balance of performance needs, and transportation context are all considerations when determining size, type, and number of lanes. In addition, see [Chapter 1106](#) for design element dimensioning methods. Note that if the criteria-based dimensioning method is used for determining lane widths on high speed (see [Chapter 1103](#)) National Highway System (NHS) facilities then the following apply:

- Lane widths are to be 12ft minimum.
- Two-lane highways may have an 11ft lane width.

1230.03(1)(a)(1) Turn Lanes

Dedicated turn lanes provide storage for turning vehicles waiting for a signal or gap in opposing traffic, separated from the through lanes. There are a number of different types of turn lanes, which are discussed in detail in [Chapter 1310](#). Turn lanes are critical to meet mobility and accessibility performance for motorized and bicycle modes. Traffic analysis determines the type and number of turn lanes that are needed to achieve the balance of multimodal performance needs.

Turn lanes present potential conflicts, particularly with bicyclists and pedestrians. (See [Chapters 1510](#) and [1520](#) for additional discussion on ways to mitigate for these conflicts.)

1230.03(1)(a)(2) Bicycle Lane

There are several different types of bicycle lanes and many different ways to arrange bike lanes within the geometric cross section. (See [Chapter 1520](#) for different bike lane types.) In general, the minimum total width for a single-direction bike lane within the traveled way zone is 5 feet, including buffer width that may be applied. Two-way bike lane facilities require a minimum width of 8 feet, excluding a minimum 2-foot buffer when adjacent to traffic or parking lanes.

Shoulders designed to function for bikes are not considered bike lanes. (See [1230.03\(2\)\(b\)\(1\)](#) and [Chapter 1520](#) for additional information.)

1230.03(1)(a)(3) Transit-Only Lane

Transit-only lanes are ideal for improving transit mobility performance and segregating heavily used or complex intermodal connections. There are many different ways to configure these within a geometric cross section. Some configurations are limited based on the type of transit vehicle due to passenger loading needs for both the vehicle type and at the stop locations. Develop widths for transit only lanes with the partnering transit agency. (See [Chapter 1430](#) for additional information on Transit Facility considerations.)

1230.03(1)(a)(4) Managed and Shared Lane

There are many different types of managed and shared lanes. Some examples of managed lanes include:

- High occupancy vehicle (HOV) lanes (see [Chapter 1410](#))
- High occupancy toll lanes (discuss with Tolling Division and see [Chapter 1410](#))
- Hard-running shoulder (see [Exhibit 1230-4c](#))
- Peak hour use

Shared lanes consist of mixing modes and are designed to address specific performance outcomes. Examples include:

- Bicycle shared lane (see [Chapter 1520](#))
- Business access and transit (BAT) lane

1230.03(1)(a)(5) Auxiliary Lanes

Auxiliary lanes assist with obtaining mobility performance for motor vehicle modes. They include many types of functions that depend on the transportation context or environmental conditions at a specific location. (See [Chapter 1270](#) for a detailed discussion on the types of and design guidance for auxiliary lanes.)

1230.03(1)(b) Service Lanes, Frontage Roads, and Collector-Distributor Roads

On some road and street types, a service lane is utilized to separate the throughput and local accessibility needs. The service lane will generally target no more than a 25 mph operating speed. The service lane is generally separated from the main line by an outer separation median (see examples in Exhibits [1230-6a](#) through [1230-6d](#) and [1230.04](#)). This service lane design segregates it from the functions of the main line, making it an ideal location for on-street parking, freight-loading areas, and potentially shared vehicle and bicycle lanes. Depending on how the service lane is treated at the intersections, it may be appropriate for transit services. The service lane presents an ideal opportunity for managing access, allowing minor side streets to intersect with the service lane rather than complicating the main line through movement. These intersection designs can potentially benefit main line operations by prioritizing which crossroads have fully directional intersections.

On higher-speed facilities in more rural environments, frontage roads provide the same functional accessibility purpose as a service lane in a city, but usually target higher operating speeds consistent with the context environment.

The primary purpose for city service lanes and rural frontage roads is to respond to local land use performance needs. Designs that support service lanes or frontage roads are recommended to include those roadways as part of a turnback agreement, or within a maintenance agreement (see [Chapter 301](#)), to clarify or further define jurisdictional responsibilities associated with the service lane, frontage road, and any associated outer separations.

Collector-distributor (C-D) roads serve a similar function as service lanes and frontage roads. Instead of providing for local land use access, C-D roads enable mobility and access performance between transportation facilities and are used exclusively on freeway applications. WSDOT maintains ownership of C-D roads. (See [Chapter 1360](#) for more information.)

1230.03(2) Streetside and Roadside Zones

The decision to design for either a streetside or roadside zone outside the traveled way zone largely depends on the land use and transportation contexts. In general, streetside zones are used in low to intermediate target speed locations and typically within suburban or urban land use areas and rural towns. Roadside zones are typically used for intermediate- to high-speed roadways in rural areas outside of towns, on full and partial limited access facilities, or on some managed access class 1 and 2 roadways.

1230.03(2)(a) Streetside Zones

The streetside zone can be used to meet the performance needs of the pedestrian mode and land use. A robust streetside design may allocate much of the available public space as both a pedestrian thoroughfare and a destination, which is desirable in many urban core and main street contexts to help promote economic vitality. In other contexts, the streetside configuration may assist with reinforcing the target speed and still provide for a minimal pedestrian thoroughfare.

WSDOT uses terminology to describe four streetside zones: frontage zone, pedestrian zone, furnishing zone, and parking zone. Information about each zone is provided below. Note, when partnering with some local agencies, they may identify more streetside zones that have specific functions according to their policy. In these cases, it is appropriate to identify the zones recognized by the partnering agency. The pedestrian zone will always be present in streetside design, but other zones are optional depending on the modal and contextual performance needs and desired balance of performance needs within the available right of way.

The Americans with Disabilities Act (ADA) requires specific design element dimensions for streetside zones, depending on configuration. In general, the pedestrian zone and frontage zone will always be part of the pedestrian circulation path (PCP). The furnishing zone may or may not be part of the PCP, depending on how it is designed. (See [Chapter 1510](#) for detailed accessibility criteria and design guidance for pedestrian facilities.)

1230.03(2)(a)(1) Frontage Zone

The frontage zone serves the retail functions found within certain contexts. The primary purpose is access to retail space without interfering with the required pedestrian access route (PAR) within the pedestrian zone. If there is not a retail or residential access need immediately adjacent to the streetside zone, then it may not be prudent to utilize the cross-sectional width for a frontage zone purpose. The frontage zone may also provide space for temporary retail product displays, advertisements, and/or outdoor seating for customers. If no frontage zone exists by private ownership or is required by municipal codes, discuss how frontage zone uses and features may be accommodated within the public right of way and any documentation that may be necessary with Real Estate Services.

1230.03(2)(a)(2) Pedestrian Zone

The pedestrian zone is completely within the PCP and is the streetside zone within which a PAR must be provided. Consider meeting PAR criteria within the entire width of the pedestrian zone when feasible. Also consider exceeding minimum width values for the pedestrian zone elements depending on the land use and transportation context needs. A generous pedestrian zone width promotes the necessary mobility and accessibility typically

anticipated within some urban and suburban contexts. (See Chapter 1510 for detailed accessibility criteria and design guidance for pedestrian facilities.)

1230.03(2)(a)(3) Furnishing Zone

The furnishing zone provides area for multiple functions. It is commonly used to promote environmental and aesthetic features that improve people's experience—like street trees, benches, planter boxes, and artwork—while providing for the safe travel of the various modes through modal segregation or clearance to obstructions. Involve the local agency, regional Landscape Architect, responsible maintenance jurisdiction(s), urban forestry experts, human factors experts, and safety professionals to consider and determine what constitutes optimal vegetation types in terms of plant and road maintenance, operations, landscape, roadway, roadside, and potential modal interactions within the furnishing zone to ensure vegetation aspects are well planned.

Traffic signs, parking meters, transit shelters/stops, and bike racks are also generally found within this zone. Other width accommodations for on-street parking may be needed for vehicle overhang or entering/exiting movements when a parking zone is applied. Coordinate with Region Program Management to understand potential funding limitations for furnishing zone features described within this section. Partnerships or grants may be necessary to complete all desired features within the furnishing zone.

1230.03(2)(a)(4) Parking Zone

The parking zone allows width for on-street parking typically provided in urban design areas and rural town center context segments, but is not necessarily required. On-street parking can help to visually narrow the street in places to assist in conveying the surrounding context for the segment. Refer to municipal codes regarding parking requirements, and coordinate with the municipality involved. Also, if on-street parking will be either delineated or metered, the ADA has requirements on the number and configuration of parking stalls for people with disabilities. Consult with a regional ADA subject matter expert. On-street parking can be either parallel or angled. However, angled parking on any state route requires approval from the State Traffic Engineer.

If angled parking is part of an alternative, request approval through the region Traffic Office. Provide an engineering study, to be approved by the State Traffic Engineer, with the request documenting that the parking will not unduly reduce safety and that the roadway is of sufficient width that parking will not interfere with the normal movement of traffic. If angled parking is approved, provide for vehicle overhang within the furnishing zone. Consider back-in angled parking if bike lanes are present to improve conflict management through increased visibility.

When designing for the parking zone locations for freight loading areas, it is important to consider both the delivery vehicle size and how the vehicle loading/unloading is done. Consult with business owners and freight carriers to locate and configure the freight loading areas throughout the alignment.

1230.03(2)(b) Roadside Zones

Roadside zones are typically applied to limited access facilities designed for intermediate to high target speeds, some managed access class 1 and 2 facilities, or rural highways. The roadside

zone is composed of shoulders and side slopes designed with considerations for clear zone or mitigation features.

1230.03(2)(b)(1) Shoulders

Shoulders are typically considered for high- or intermediate-speed limited access facilities, some rural contexts, as well as intermediate-speed locations that do not have streetside zones. Intermediate-speed locations in suburban and urban contexts that utilize streetside zones do not need to include a shoulder, unless determined to be necessary by safety performance analysis or engineering judgment. If the criteria-based dimensioning method (see [Chapter 1106](#)) is used to determine shoulder widths the following must be applied for high speed NHS facilities (See [Chapter 1103](#)):

- Inside shoulders are to be 4ft minimum on facilities up to 4 lanes, and 10 ft minimum on 6 lane facilities. In mountainous terrain, inside shoulder may be reduced to 4ft on facilities up to 6 lanes.
- Outside shoulders are to be 10ft minimum. In mountainous terrain, outside shoulder may be reduced to 8ft on facilities up to 6 lanes. Two-lane high speed highways may have an 8ft minimum outside shoulder, and may be reduced to 4ft with justification.

In other situations the shoulder width is controlled by its intended functional use and its contribution to achieving the desired safety performance when balanced with other design elements. Functional uses and recommended shoulder widths are given in [Exhibit 1230-7](#). In addition to the functions in [Exhibit 1230-7](#), shoulders also:

- Provide space to escape potential collisions or reduce their severity.
- Provide a sense of openness, contributing to driver ease at higher speeds.
- Reduce seepage adjacent to the traveled way by discharging stormwater farther away.

Exhibit 1230-7 Shoulder Functional Uses and Width Considerations

Shoulder Function	Shoulder Width Guidance
Stopping out of the traffic lanes	8 ft – 12 ft ^[1]
Minimum lateral clearance	2 ft ^[2]
Hard-running shoulder	11 ft to 14 ft ^[6]
Bicycle use	4 ft ^[3]
Pedestrian use	4 ft ^[3]
Large-vehicle off-tracking on curves	See Chapter 1240
U-turn turnouts	Varies – See Chapter 1310
Maintenance operations	Varies ^[4]
Law enforcement	8 ft ^[5]
Bus stops	See Chapter 1430
Slow-vehicle turnouts and shoulder driving	See Chapter 1270
Ramp meter storage	8 – 12ft ^[1]
HOV bypass	10 – 14ft ^[6]
Ferry holding	8 ft – 12ft
For use as a lane during reconstruction of the through lanes	8 ft – 12ft
Structural support of pavement	2 ft
Improve sight distance in cut sections	See Chapter 1260
Notes:	
[1] 10-ft minimum recommended for freight or transit vehicles.	
[2] See Chapters 1600 and 1610 .	
[3] Minimum usable shoulder width for bicycles, additional width is recommended when combined with shoulder rumble strips, curb, or barrier (see Chapter 1600 and the <i>Standard Plans</i>). For guidance, see Chapter 1520 for accommodating bicycles and Chapter 1510 for accommodating pedestrians.	
[4] 10-ft usable width to park a maintenance truck out of the through lane; 12-ft width (14-ft preferred) for equipment with outriggers to work out of traffic.	
[5] For additional information, see Chapters 1410 and 1720 .	
[6] Selected width should be determined with transit provider, and consider any lateral clearance concerns.	

Contact the Area Maintenance Superintendent to determine the shoulder width for maintenance operations. In some cases, a continuous width is not necessary; instead, the focus is placing the shoulder width near assets with high-frequency maintenance needs. Compare the added cost of the wider shoulders to the added benefits to maintenance operations as well as other benefits that may be derived (see [Chapter 301](#)).

The usable shoulder is the width necessary for a vehicle to stop out of traffic. Usable shoulder width is less than the constructed shoulder width when vertical features (such as traffic barrier or walls) are at the edge of the shoulder. This is because drivers tend to shy away from the vertical feature. For traffic barrier shy distance widening, see [Chapter 1610](#).

Shoulder widths greater than 10 feet may encourage use as a travel lane. Therefore, use shoulders wider than this only to meet one of the listed functions (see [Exhibit 1230-7](#)).

When walls are placed adjacent to shoulders, see [Chapter 730](#) for barrier guidance.

Exhibit 1230-8a Shoulder Details

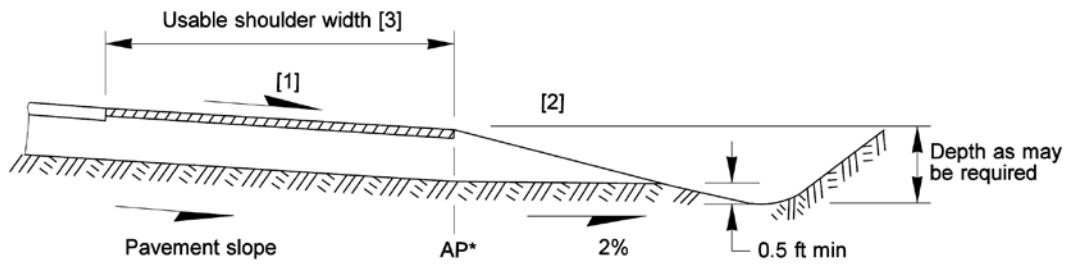

Shoulder Design on the Low Side of the Roadway for Cross Slopes Greater Than 2%

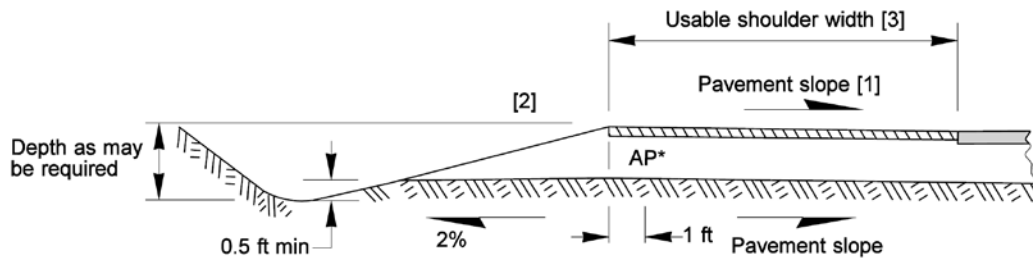

Shoulder Design on the High Side of the Roadway on Curves and Divided Roadways Shoulder Slopes With Roadway

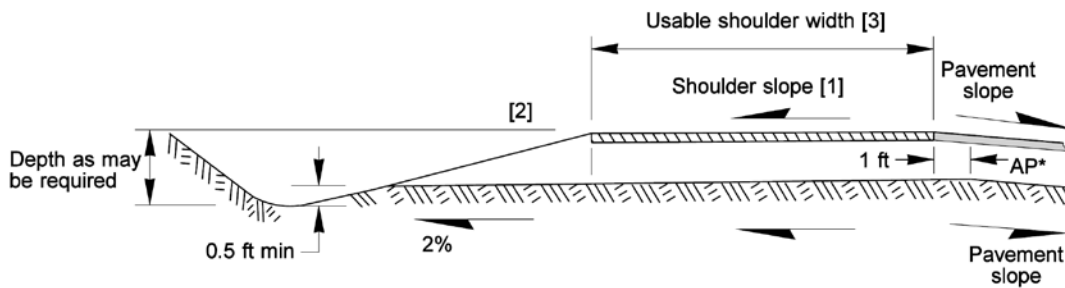

Shoulder Design on the High Side of the Roadway on Curves and Divided Roadways Shoulder Slopes Away From Roadway

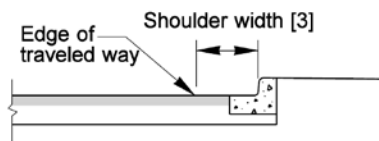

Shoulder Design with Curb^[4] ^[5]

*AP = Angle point in the subgrade

Note:

For applicable notes, see [Exhibit 1230-8b](#).

Exhibit 1230-8b Shoulder Details

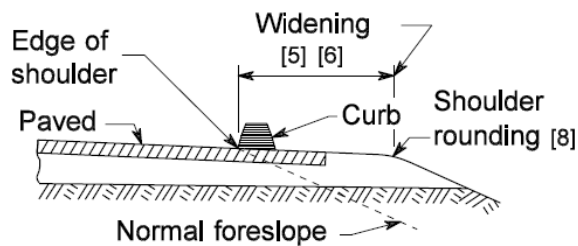

Asphalt Concrete Curb Placement

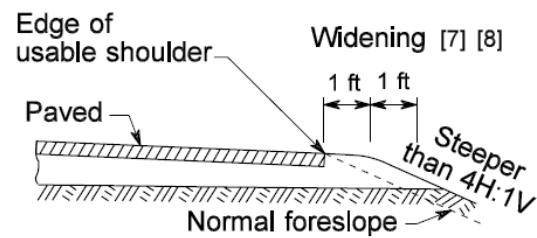

Shoulder Rounding [2]

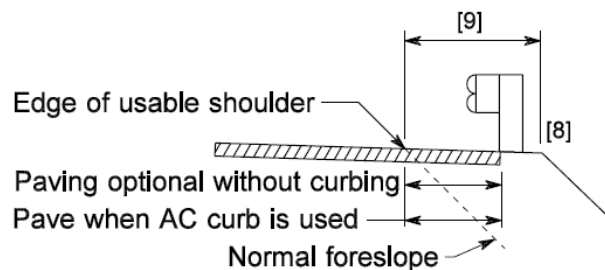

Shoulder Widening for Guardrail

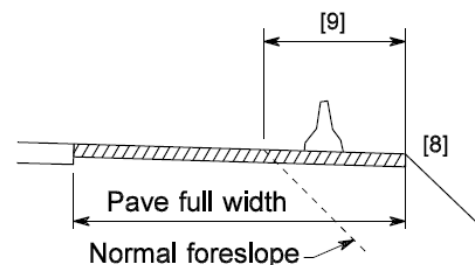

Shoulder Widening for Barrier

Notes:

- [1] Shoulder cross slopes are normally the same as the cross slopes for adjacent lanes. (For examples and additional information for locations where it may be desirable to have a shoulder cross slope different than the adjacent lane, see [1230.06\(1\)](#).)
- [2] Provide widening and slope rounding outside the usable shoulder when foreslope is steeper than 4H:1V.
- [3] For shoulder width, see [Exhibit 1230-7](#) and Chapters [1360](#) and [1520](#).
- [4] For additional requirements for sidewalks, see [Chapter 1510](#).
- [5] See [1230.05](#) for curb design guidance.
- [6] Provide paved shoulders wherever extruded curb is placed. (See the [Standard Plans](#) for additional details and dimensions.)
- [7] When rounding is provided, consider uniform application on all ramps and crossroads, as well as the main roadway. End rounding on the crossroad just beyond the ramp terminals and at a similar location where only a grade separation is involved.
- [8] When widening beyond the edge of usable shoulder for curb, barrier, or other purposes, additional widening for slope rounding may be omitted.
- [9] For widening guidelines for guardrail and concrete barrier, see [Chapter 1610](#).

General:

On divided multilane highways, see Exhibits [1230-14a](#) through [1230-14c](#) for additional details for median shoulders.

1230.03(2)(b)(2) Side Slopes

The design for side slopes can affect shoulder design, clear zone requirements, and whether or not traffic barrier is necessary. Side slopes are more commonly encountered in high-speed and/or rural contexts. The following guidance may not apply to cross section design if streetside elements are present or employed in the design (See [1230.03\(2\)\(a\)](#) and [Chapter 1510](#) for further information). After the foreslope has been determined, use the guidance in [Chapter 1600](#) to determine the need for a traffic barrier.

When designing side slopes, attempt to fit the slope selected for any cut or fill into the existing terrain to give a smooth transitional blend from the construction to the existing landscape when practicable. Flatter slopes are desirable, especially with higher posted speeds and when the associated cost does not significantly exceed other design options. Side slopes not steeper than 4H:1V, with smooth transitions where the slope changes, will provide a reasonable opportunity to recover control of an errant vehicle. Side slopes designed to 4H:1V or flatter are preferred. Provide widening and slope rounding outside the usable shoulder when foreslope is steeper than 4H:1V. Do not disturb existing stable cut slopes just to meet the a 4H:1V side slope preference. When an existing slope is to be revised, document the reason for the change.

3H:1V side slopes are traversable, but not necessarily recoverable. If providing 3H:1V slopes, consider placement of a flat area extending from the toe of the cut slope for errant vehicle recovery (see [Chapter 1600](#)). Where mowing is contemplated, provide slopes not steeper than 3H:1V to allow for mowing. If there will be continuous traffic barrier on a fill slope, and mowing is not contemplated, the slope may be steeper than 3H:1V. When providing side slopes steeper than 3H:1V, document the reason for the decision.

Where unusual geological features or soil conditions exist, treatment of the slopes depends upon results of a review of the location by the Region Materials Engineer (RME).

Do not install traffic barrier unless an object or condition is present that calls for mitigation in accordance with [Chapter 1600](#) criteria. The steepest slope is determined by the soil conditions. Where favorable soil conditions exist, higher fill slopes may be as steep as 1½H:1V. (See [Chapter 1600](#) for clear zone and barrier criteria.)

If borrow is necessary, consider obtaining it by flattening cut slopes uniformly on one or both sides of the highway. Where considering wasting excess material on an existing side slope, consult the RME to verify that the foundation soil will support the additional material.

Provide for drainage from the roadway surface and drainage in ditches (see [Chapter 800](#)). For drainage ditches, see [1230.03\(2\)\(b\)\(5\)](#). At locations where vegetated filter areas or detention facilities will be established to improve highway runoff water quality, provide appropriate slope, space, and soil conditions for that purpose. (See the [Highway Runoff Manual](#) for design criteria and additional guidance.)

Except under guardrail installations, it is desirable to plant and establish low-growing vegetation on nonpaved roadsides. This type of treatment relies on the placement of a lift of compost or topsoil over base course material in the roadway cross section. Consult with the area Maintenance Superintendent and the region Landscape Architect to determine the appropriate configuration of the roadway cross section and soil and plant specifications.

Flatten crossroad and road approach foreslopes to 6H:1V, where feasible, and consider at least to 4H:1V. Provide smooth transitions between the main line foreslopes and the crossroad or road approach foreslopes. Where possible, move the crossroad or road approach drainage away from the main line. This can locate the pipe outside the Design Clear Zone and reduce the length of pipe.

Provide slope treatment as shown in the *Standard Plans* at the top of roadway cut slopes except for cuts in solid rock. Unless Class B slope treatment is called for, Class A slope treatment is used. Call for Class B slope treatment where space is limited, such as where right of way is restricted.

1230.03(2)(b)(3) Roadway Sections in Rock Cuts

Typical sections for rock cuts, illustrated in Exhibits [1230-9a](#) and [1230-9b](#), are guides for the design and construction of roadways through rock cuts. Changes in slope or fallout area are recommended when justified. Base the selection of the appropriate sections on an engineering study and the recommendations of the RME and region Landscape Architect. Obtain concurrence from the Headquarters (HQ) Materials Lab.

There are two basic design treatments applicable to rock excavation (see Exhibits [1230-9a](#) and [1230-9b](#)). Design A applies to most rock cuts. Design B is a talus slope treatment.

a. Design A

This design is shown in stage development to aid the designer in selecting an appropriate section for site conditions in regard to backslope, probable rockfall, hardness of rock, and so on.

The following guidelines apply to the various stages shown in [Exhibit 1230-9a](#):

- **Stage 1** is used where the anticipated quantity of rockfall is small, adequate fallout width can be provided, and the rock slope is ½H:1V or steeper. Controlled blasting is recommended in conjunction with Stage 1 construction.
- **Stage 2** is used when a “rocks in the road” problem exists or is anticipated. Consider it on flat slopes where rocks are apt to roll rather than fall.
- **Stage 3** represents the full implementation of all protection and safety measures applicable to rock control. Use it when extreme rockfall conditions exist.

Show Stage 3 as the ultimate stage for future construction in the Plans, Specifications, and Estimates (PS&E) if there is any possibility that it will be needed.

The use of Stage 2 or Stage 3 alternatives (concrete barrier) is based on the designer’s analysis of the particular site. Considerations include maintenance; size and amount of rockfall; probable velocities; availability of materials; ditch capacity; adjacent traffic volumes; distance from traveled lane; and impact severity. Incorporate removable sections in the barrier at approximately 200-foot intervals. Provide appropriate terminal treatment (see [Chapter 1610](#)).

Occasionally, the existing ground above the top of the cut is on a slope approximating the design cut slope. The height (H) is to include the existing slope or that portion that can logically be considered part of the cut. Select cut slopes for a project that provide stability for the existing material.

Benches may be used to increase slope stability; however, the use of benches may alter the design given in [Exhibit 1230-9a](#).

The necessity for benches, as well as their width and vertical spacing, is established after an evaluation of slope stability. Make benches at least 20 feet wide. Provide access for maintenance equipment to the lowest bench and to the higher benches if feasible. Greater traffic benefits in the form of added safety, increased horizontal sight distance on curves, and other desirable attributes may be realized from widening a cut rather than benching.

b. Design B

A talus slope treatment is shown in [Exhibit 1230-9b](#). The rock protection fence is placed at any one of the three positions shown, but not in more than one position at a particular location. Consult with the RME for the placement of the rock protection fence in talus slope areas.

- **Fence position a** is used when the cliff generates boulders less than 0.25 yd³ in size and the length of the slope is greater than 350 feet.
- **Fence position b** is the preferred location for most applications.
- **Fence position c** is used when the cliff generates boulders greater than 0.25 yd³ in size regardless of the length of the slope. On short slopes, this may require placing the fence less than 100 feet from the base of the cliff.
- Use of gabions may be considered instead of the rock protection shown in fence position a. Because gabion treatment is considered similar to a wall, provide appropriate face and end protection (see Chapters [730](#) and [1610](#)).

Use of the alternate shoulder barrier is based on the designer's analysis of the particular site. Considerations similar to those given for Design A alternatives apply.

Evaluate the need for rock protection treatments other than those described above for cut slopes that have relatively uniform spalling surfaces (consult with the RME).

Exhibit 1230-9a Roadway Sections in Rock Cuts: Design A

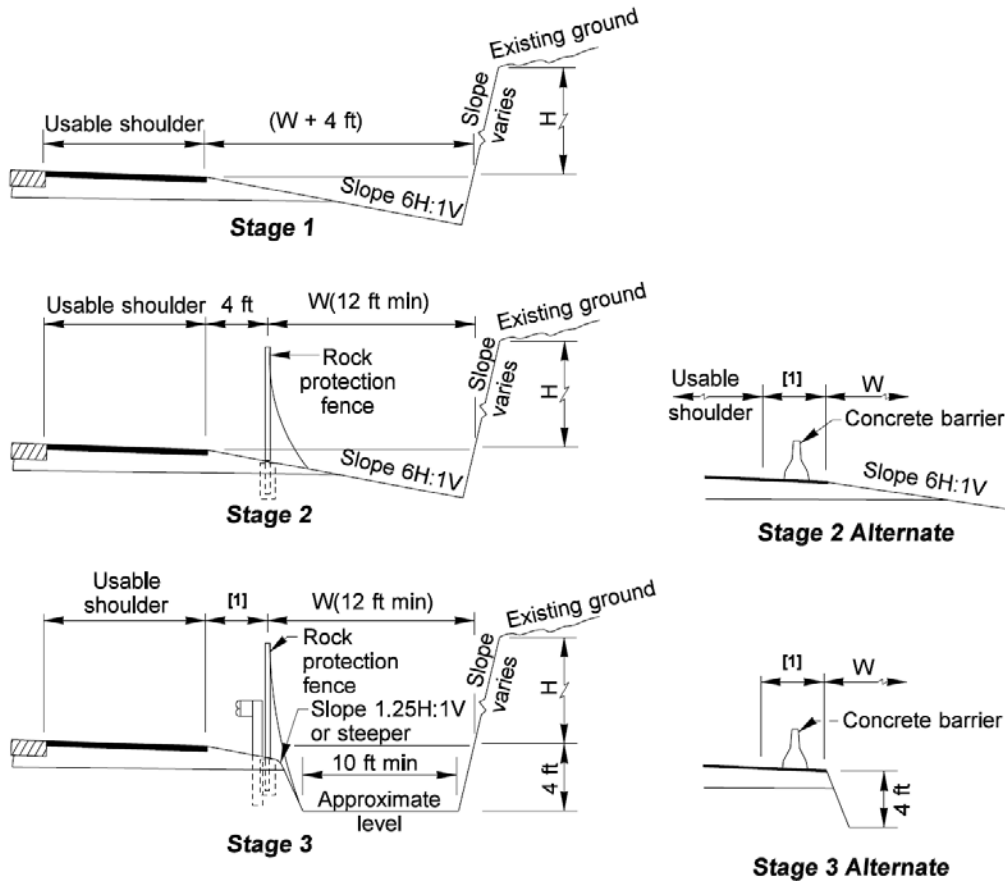

Rock Slope	H (ft)	W (ft)
Near Vertical	20 – 30	12
	30 – 60	15
	> 60	20
0.25H:1V through 0.50H:1V	20 – 30	12
	30 – 60	15
	60 – 100	20
	>100	25

Note:

[1] For widening for guardrail and concrete barrier, see [Chapter 1610](#).

General:

- Treat cut heights less than 20 feet as a normal roadway unless otherwise determined by the RME.
- Stage 2 and Stage 3 Alternates may be used when site conditions dictate.
- Fence may be used in conjunction with the Stage 3 Alternate. (See [Chapter 1600](#) for clear zone guidelines.)

Exhibit 1230-9b Roadway Sections in Rock Cuts: Design B

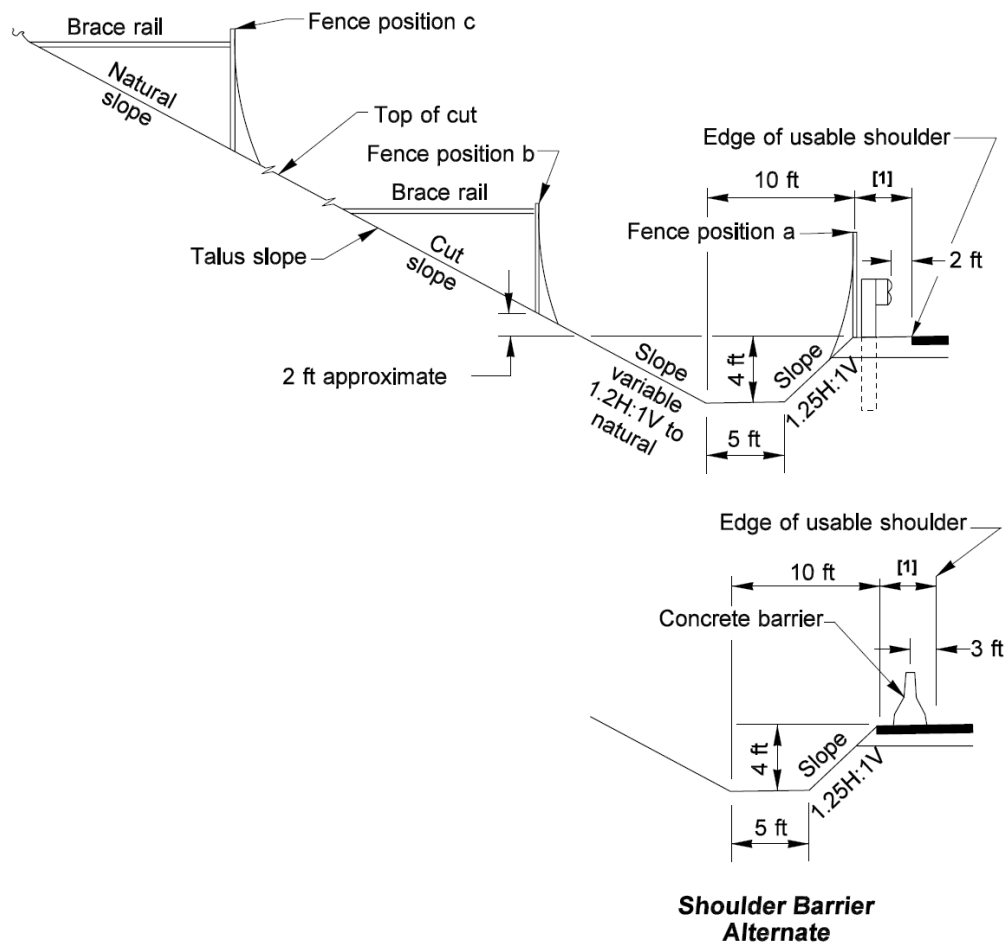
**Note:**

[1] For widening for guardrail and concrete barrier, see [Chapter 1610](#).

General:

- Ordinarily, place fence within a zone of 100 feet to 200 feet maximum from base of cliff, measured along the slope.
- Rock protection fence may be used in conjunction with the Shoulder Barrier Alternate when site conditions dictate.

1230.03(2)(b)(4) Stepped Slopes

Stepped slopes are a construction method intended to promote early establishment of vegetative cover on the slopes. They consist of a series of small horizontal steps or terraces on the face of the cut slope. Soil conditions dictate the feasibility and necessity of stepped slopes. They are to be considered on the recommendation of the RME (see [Chapter 610](#)). Consult the region landscape personnel for appropriate design and vegetative materials to be used. (See [Exhibit 1230-10](#) for stepped slope design details.)

Exhibit 1230-10 Stepped Slope Design

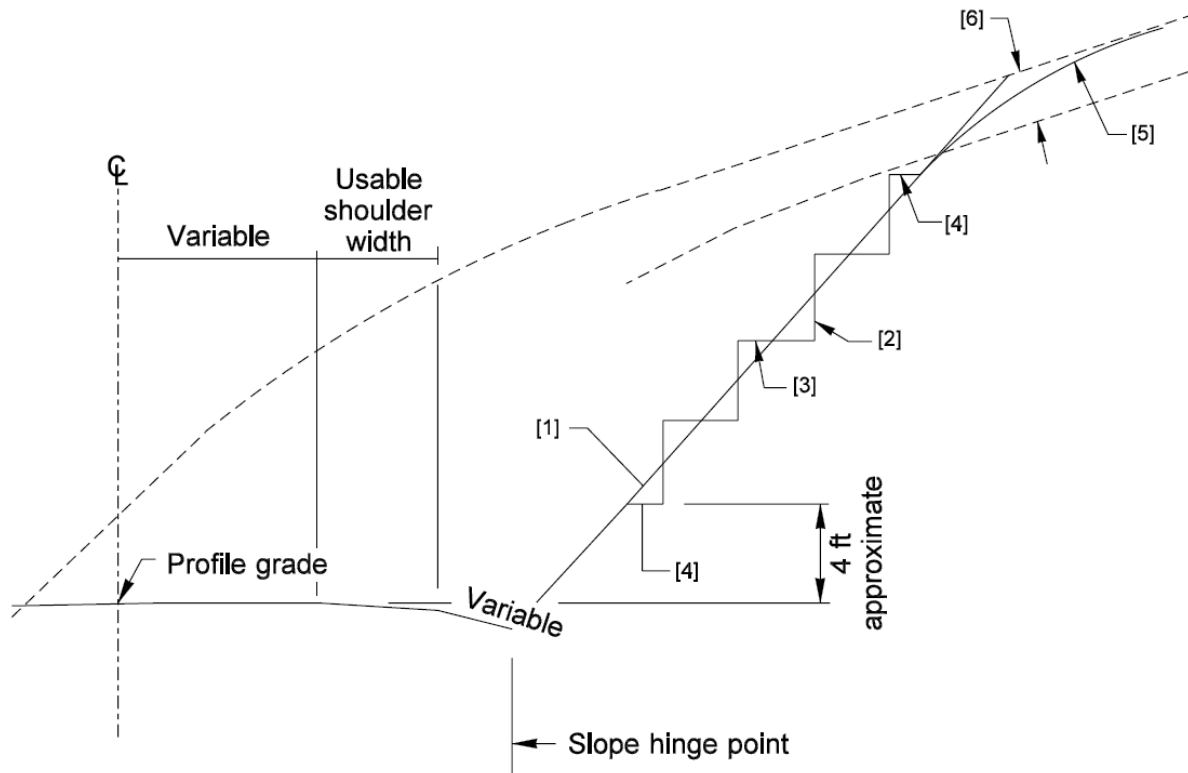

Notes:

- [1] Staked slope line: Maximum slope 1H:1V.
- [2] Step rise: Height variable 1 foot to 2 feet.
- [3] Step tread: Width = staked slope ratio x step rise.
- [4] Step termini: Width $\frac{1}{2}$ -step tread width.
- [5] Slope rounding.
- [6] Overburden area: Variable slope ratio.

1230.03(2)(b)(5) Drainage Ditches

[Exhibit 1230-11](#) provides general information regarding drainage ditch design. Where a drainage ditch is located adjacent to the toe of a side slope, consider the stability of the foreslope and backslope. A drainage ditch placed immediately adjacent to the toe of side slopes has the effect of increasing the height of the side slope by the depth of the ditch. In cases where the foundation soil is weak, the extra height could result in an side slope failure. As a general rule, the weaker the foundation and the higher the side slopes, the farther the ditch should be from the toe of slope. Consult the RME for the proper ditch location.

When topographic restrictions exist, consider an enclosed drainage system with appropriate inlets and outlets. Do not steepen slopes to provide lateral clearance from toe of slope to ditch location, thereby necessitating traffic barriers or other protective devices.

Maintenance operations are also facilitated by adequate width between the toe of the slope and an adjacent drainage ditch. Where this type of facility is anticipated, provide sufficient right of way for access to the facility and place the drainage ditch near the right of way line.

Provide for disposition of the drainage collected by ditches in regard to siltation of adjacent property, erosion, and other undesirable effects. This may also apply to the top of cut slope ditches.

Exhibit 1230-11 Drainage Ditch Detail

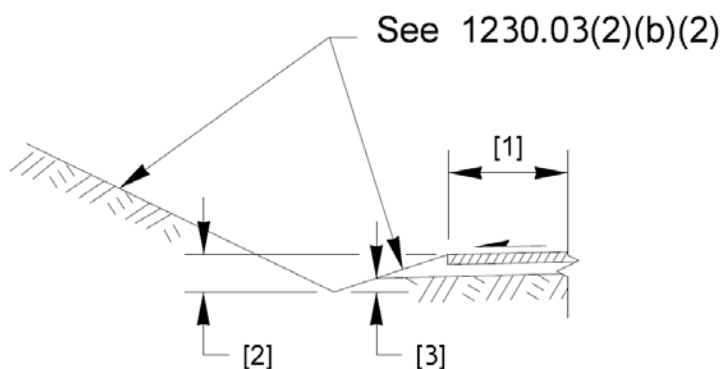

Notes:

- [1] Roadway width determined by various sections within this chapter, and by design element dimensioning (see [Chapter 1106](#)).
- [2] 1.5 ft minimum, unless otherwise determined by drainage design.
- [3] 0.5 ft minimum from bottom of subgrade or design water surface elevation.

1230.03(2)(b)(6) Bridge End Slopes

Bridge end slopes are determined by several factors, including context, fill height, depth of cut, soil stability, and horizontal and vertical alignment. Coordinate bridge end slope treatment with the HQ Bridge and Structures Office (see [Chapter 720](#)).

Early in the bridge plan development, determine preliminary bridge geometrics, end slope rates, and toe of slope treatments. [Exhibit 1230-12a](#) provides guidelines for use of slope rates and toe of slope treatments for overcrossings. [Exhibit 1230-12b](#) shows toe of slope treatments to be used on the various toe conditions.

Exhibit 1230-12a Bridge End Slopes

Bridge End Condition	Toe of Slope End Slope Rate		Lower Roadway Treatment ^[1]		Slope Rate
	Height	Rate	Posted speed of lower roadway	Treatment	
End Piers on Fill	≤ 35 ft	1¾H:1V	> 50 mph	Rounding	
	> 35 ft	2H:1V ^[2]	≤ 50 mph	No rounding	
End Piers in Cut	Match lower roadway slope ^[3]		No rounding, toe at centerline of the lower roadway ditch.		[4]
Lower Roadway in Cut	Match lower roadway slope ^[3]		No rounding, toe at centerline of the lower roadway ditch.		[4]
Ends in Partial Cut and Fill	When the cut depth is > 5 ft and length is > 100 ft, match cut slope of the lower roadway		When the cut depth is > 5 ft and length is > 100 ft, no rounding, toe at centerline of the lower roadway ditch		[4]
	When the cut depth is ≤ 5 ft or the length is ≤ 100 ft, it is designer's choice		When the cut depth is ≤ 5 ft or the length is ≤ 100 ft, it is designer's choice		[4]

Notes:

- [1] See [Exhibit 1230-12b](#).
 [2] Slope may be 1¾H:1V in special cases.
 [3] In interchange areas, continuity may require variations.
 [4] See [1230.03\(2\)\(b\)](#).

Exhibit 1230-12b Bridge Side Slope Details

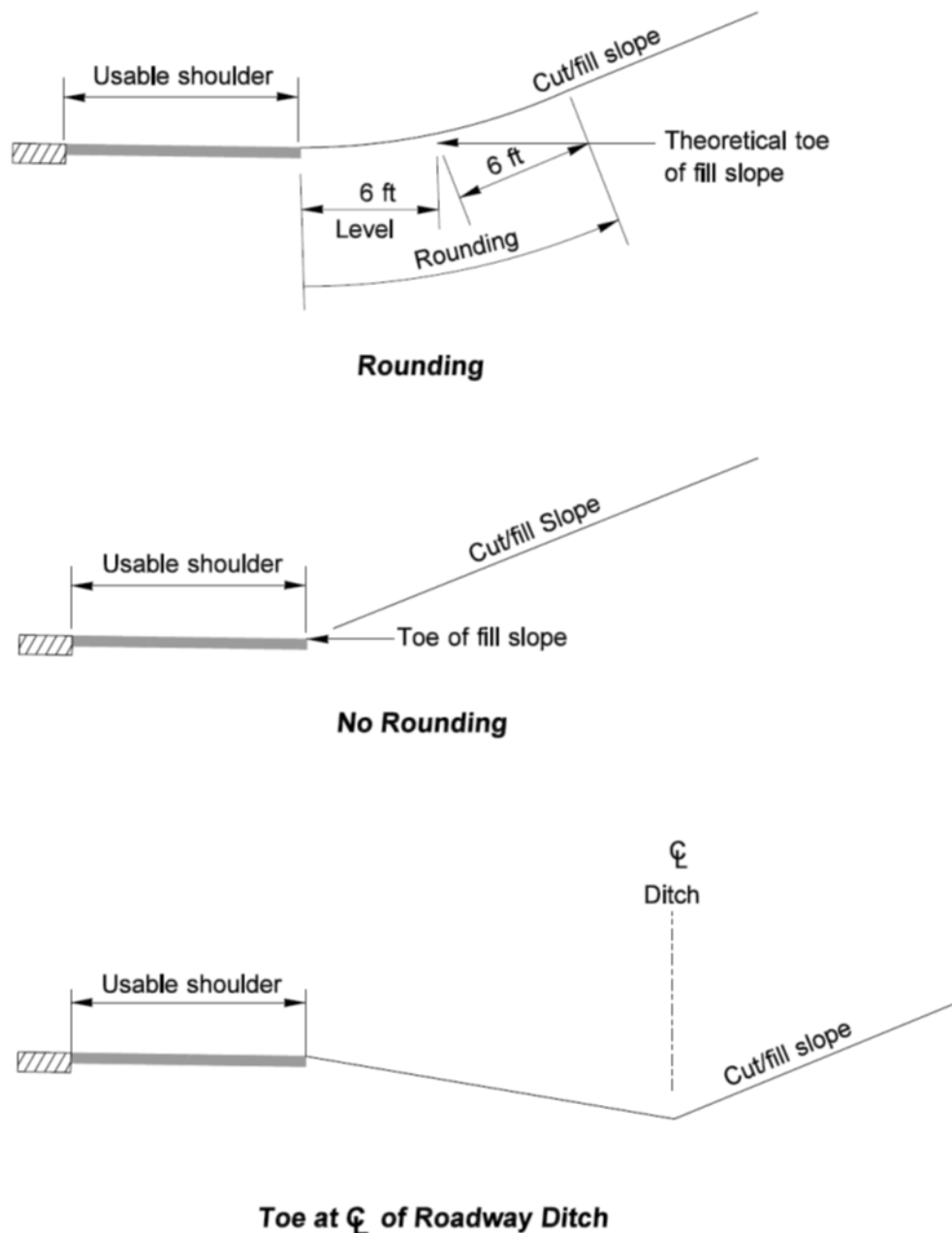

1230.04 Medians and Outer Separations

Medians are either restrictive or nonrestrictive. Restrictive medians limit motor vehicle encroachment physically, using raised curb, fixed delineators, vegetative strips, or vegetative depressions. Nonrestrictive medians limit motor vehicle encroachment legally, and use pavement markings to define locations where turns are permissible. The main function of an outer separation is to separate the main roadway from a frontage road, service lane, or for

modal segregation. Consider medians or outer separations to optimize the desired performance objective, such as safety, throughput operations, pedestrian mobility needs, etc.

The primary functions of a median or outer separation are to:

- Separate traffic (such as with HOT lanes) and/or modal users (such as bike buffers).
- Separate differing alignments on divided highways.
- Reduce head-on collisions.
- Manage speed.
- Provide an refuge area for emergency parking.
- Allow for future widening of a planned phase.
- Separate collector-distributor lanes, weight stations, or rest areas.
- Accommodate drainage facilities.
- Accommodate bridge piers at undercrossings.
- Provide vehicle storage space for crossing and left-turn movements at intersections.
- Accommodate headlight glare screens, including planted or natural foliage.
- Provide recovery areas for errant or disabled vehicles.
- Accommodate pedestrian refuge area at crossing locations.
- Provide storage space for snow and water from traffic lanes.
- Provide increased safety, comfort, and ease of operations for different modes.
- Control access.
- Provide enforcement areas.

The width of a median is measured from edge of traveled way to edge of traveled way and includes shoulder and shy (see [Chapter 1610](#)) width, if provided. Median widths can vary greatly based on the functional use of the median, target speed, and context. Guidance for median widths depending on their function and context is given in [Exhibits 1230-13](#) and [1230-15](#).

1230.04(1) Intermediate- to High-Speed Median Design

[Exhibit 1230-13](#) gives additional width considerations for median functions common on high-speed facilities. Depending on the context and performance needs, this guidance may also apply to intermediate speed facilities as well.

When the horizontal and vertical alignments of the two roadways of a divided highway are independent of one another, determine median side slopes in conformance with [1230.03\(2\)\(b\)\(2\)](#) and chapters [1600](#) and [1610](#). Independent horizontal and vertical alignment, rather than parallel alignment, allows for reduced grading or cut sections.

Considerable latitude in grading treatment is intended on wide, variable-width medians, provided the minimum performance needs are met or exceeded. Unnecessary clearing, grubbing, and grading are undesirable within wide medians. Use selective thinning and limited reshaping of the natural ground when feasible. For median clear zone criteria, see [Chapter 1600](#), and for slopes between the face of traffic barriers and the traveled way, see [Chapter 1610](#).

In areas where land is expensive, make an economic comparison of wide medians to narrow medians with barrier. Consider right of way, construction, maintenance, and collision costs. The widths of medians need not be uniform. Make the transition between median widths as long as practical. (See [Chapter 1210](#) for minimum taper lengths.)

When using concrete barriers in depressed medians or on curves, provide for surface drainage on both sides of the barrier. The transverse notches in the base of precast concrete barrier are not intended to be used as a drainage feature, but rather as pick-up points when placing the sections.

At locations where the median will be used to allow vehicles to make a U-turn, consider increasing the width to meet the needs of the selected design vehicles making the U-turn. (For information on U-turn locations, see [Chapter 1310](#).) Document the selected design vehicle and provide alternate route information for vehicles not serviced by the U-turn.

Where feasible widen medians at intersections on rural divided multilane highways. Provide sufficient width to store vehicles crossing the expressway or entering the expressway with a left turn.

When the median is to be landscaped or where rigid objects are to be placed in the median, see [Chapter 1600](#) for traffic barrier and clear zone guidance. When the median will transition for use as a left-turn lane, see [Chapter 1310](#) for left-turn lane design considerations.

Exhibit 1230-13 High- to Intermediate-Speed Median Functions and Guidance

Median Functional Use	Width Guidance
Separating opposing traffic	6 ft or more ^[1] and see Chapters 1600 and 1610
Separating alignments	Varies See 1230.03(2)(b)(2) and Chapters 1600 and 1610 ^[2]
Recovery/Refuge areas for errant vehicles	See 1230.03(2)(b)(2) and Chapter 1600
Median signing and illumination – Undivided highways and ramps	6 ft ^[1] or as recommended for signing and illumination design
Storage space for snow	Consult Region Maintenance
Enforcement areas	Consult with Washington State Patrol
Vehicle storage space for crossing at intersections	See Chapter 1310 , and consult with region traffic engineer
Median U-turn	See Chapter 1310
Outer separation for frontage or collector-distributor	6 ft – or more ^[1] and see Chapters 1600 and 1610
Transit use	Varies; discuss with Transit Agency ^[3]

Notes:

- [1] Conduct safety performance analysis and include potential countermeasures identified to obtain the desired safety performance. Consult with maintenance; additional width may be appropriate for unconstrained right of way locations, maintenance functions, or for divided highways on independent alignments.
- [2] Recommend an economic comparison of wide medians to narrow medians with barrier.
- [3] For planning and scoping purposes, 32 ft can be the assumed minimum for two-way transit operations or 22 ft for one-way transit operations.

Exhibit 1230-14a Divided Highway Median Sections

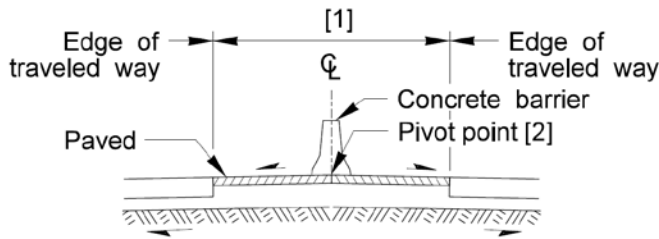

Design A: Crowned Median

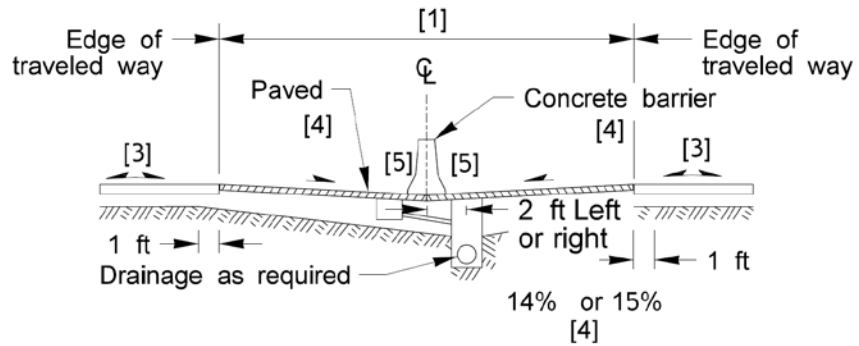

Design: B Depressed Median

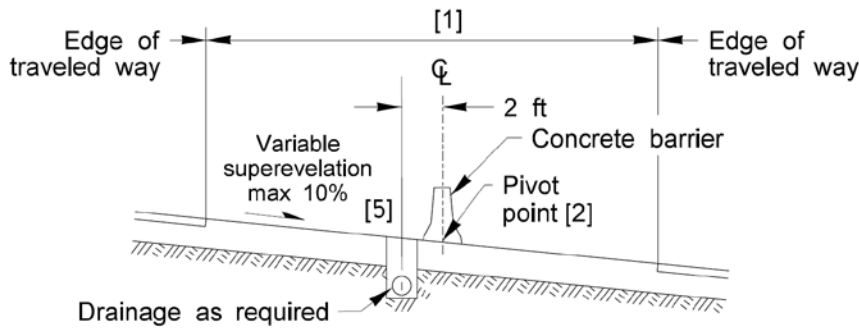

Alternate Design 1: Treatment on Curves

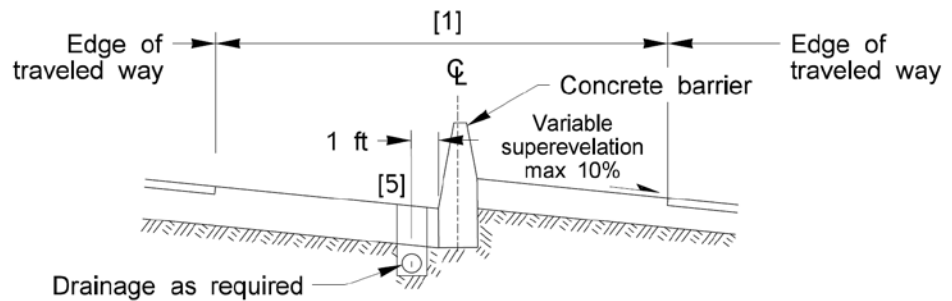

Alternate Design 2: No Fixed Pivot Point [2]

Note:

For applicable notes, see [Exhibit 1230-14c](#).

Exhibit 1230-14b Divided Highway Median Sections

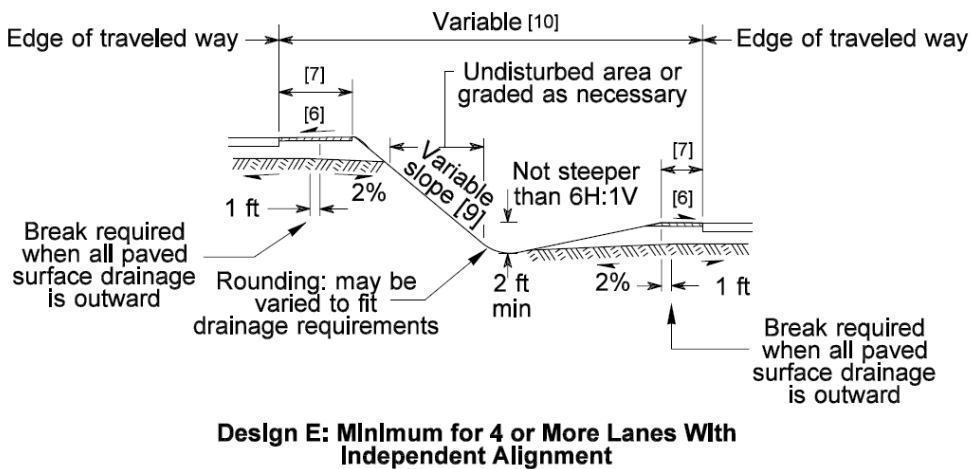
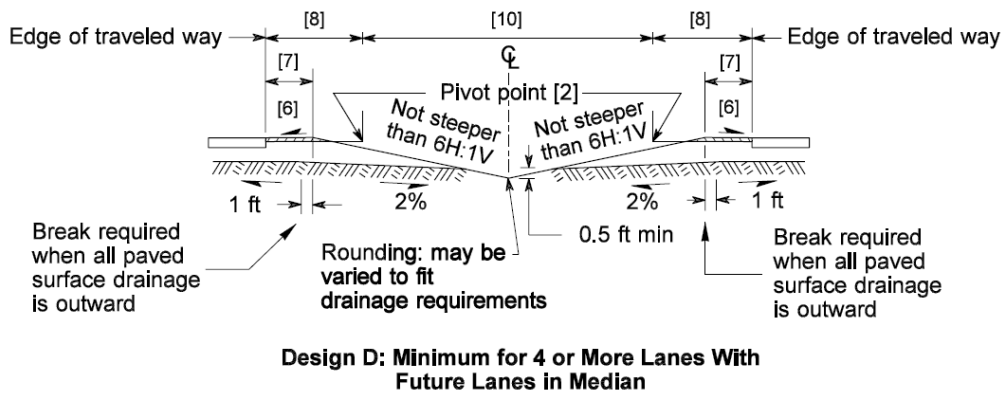
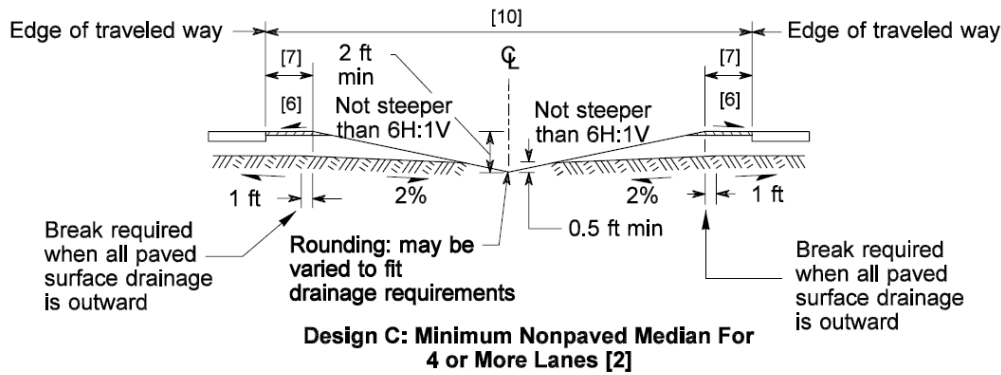

Note:

For applicable notes, see [Exhibit 1230-14c](#).

Exhibit 1230-14c Divided Highway Median Sections

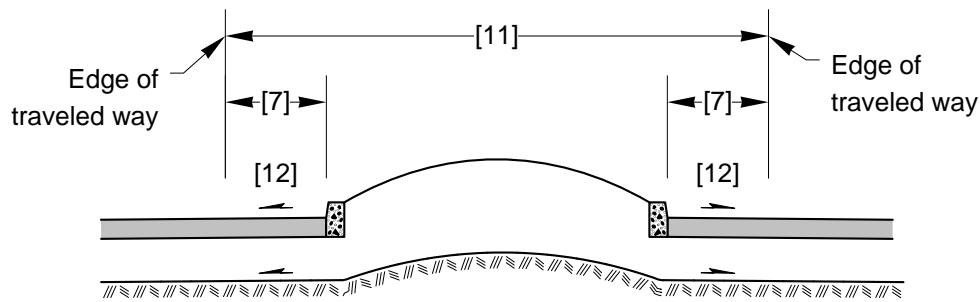
Design F: Raised Median^[13]**Notes:**

- [1] For minimum median width, see [Exhibit 1230-13](#).
- [2] Consider vertical clearances, drainage, and aesthetics when locating the pivot point.
- [3] Generally, slope pavement away from the median. When barrier is present and the roadway is in a superelevation, size the shoulder so that standing water is not in the travel lane. Where appropriate, a crowned roadway section may be used in conjunction with the depressed median.
- [4] Design B may be used uniformly on both tangents and horizontal curves. Use Alternate Design 1 or Alternate Design 2 when the "rollover" between the shoulder and the inside lane on the high side of a superelevated curve exceeds 8%. Provide suitable transitions at each end of the curve for the various conditions encountered in applying the alternate to the basic median design.
- [5] Method of drainage pickup to be determined by the designer.
- [6] Median shoulders normally slope in the same direction and rate as the adjacent through lane. (See [1230.06\(1\)](#) for examples and additional information for locations where it may be desirable to have a shoulder cross slope different than the adjacent lane.)
- [7] For minimum shoulder width, see [Exhibit 1230-7](#).
- [8] Future lane width of a planned phase.
- [9] Widen and round foreslopes steeper than 4H:1V, as shown in [Exhibit 1230-8b](#).
- [10] Designs C, D, and E are rural high-speed median designs. (See [Exhibit 1230-13](#) for recommended median widths.)
- [11] For minimum median width, see [Exhibit 1230-13](#). Raised medians may be paved or landscaped. For clear zone and barrier guidelines when fixed objects or trees are in the median, see [Chapter 1600](#).
- [12] Lane and shoulders normally slope away from raised medians. When they slope toward the median, provide for drainage.
- [13] See [1230.05](#) for curb design guidance.

1230.04(2) Low- to Intermediate-Speed Median Design

[Exhibit 1230-15](#) provides design guidance to consider for medians within low-speed transportation contexts. Depending on the context and performance needs, this guidance may also apply to intermediate speed facilities as well. In low-speed urban and suburban contexts, clear zone criteria (see [Chapter 1600](#)) is not required, but should be considered as a countermeasure to mitigate safety performance determined from quantitative safety analysis.

A common form of restrictive median on urban managed access highways is the raised median. For more information on traffic volume thresholds for restrictive medians on managed access highways, see [Chapter 540](#).

Exhibit 1230-15 Low- to Intermediate-Speed Median Functions and Guidance

Median Functional Use	Width Guidance
Access Control – Restrictive	Width of raised median feature ^[1] ^[2]
Access Control – Non-restrictive	1 ft minimum ^[3]
Pedestrian refuge for crossing locations	6 ft minimum, excluding curb width (see Chapter 1510)
Speed management and/or aesthetic design – Vegetated	Varies ^[2] ^[4] (see Chapter 1103)
Drainage or treatment facilities	Varies ^[5]
Bike buffer treatment	2 ft – 3 ft (see Chapter 1520)
Transit connection	5 ft – 10 ft ^[6] (see Chapter 1430)
Outer separation used for a pedestrian zone	9 ft – 16 ft ^[4] ^[7] ^[8]

Notes:

- [1] The width of a raised median can be minimized by using a dual-faced cement concrete traffic curb, a precast traffic curb, or an extruded curb.
- [2] Consider width necessary for lateral clearance.
- [3] 2 ft minimum if adjacent lane widths are less than 11 ft.
- [4] Consult Region Landscape Architect; width will depend on type of plantings. Over-excavation may be necessary to prepare soil for the selected plantings to ensure mature heights are obtained.
- [5] Consult Hydraulic Report for width necessary for drainage or treatment facilities.
- [6] Consult with the transit provider. If a transit shelter is planned, a minimum 5 ft clear area measured from the edge of shelter roofing to face of curb width, is necessary for pedestrians to move to and around the shelter and for lift extension (see [Chapter 1430](#)).
- [7] Consider width needed for plantings or street furniture to create the appropriate pedestrian zone segregation and environment.
- [8] See also [Chapter 1510](#)

1230.05 Curbs

Curbs are designated as either vertical or sloped. Vertical curbs have a face batter not flatter than 1H:3V. Sloped curbs have a sloping face that is more readily traversed.

Curbs can also be classified as mountable. Mountable curbs are sloped curb with a height of 6 inches or less; 4 inches or less is recommended. When the face slope is steeper than 1H:1V, the height of a mountable curb is limited to 4 inches or less.

- (a) Use vertical curbs with a height of 6 inches or more:
- To inhibit vehicles from leaving the roadway on low-speed roadways.
 - To discourage vehicles from leaving low- and intermediate-speed roadways.
 - For walkway and pedestrian refuge separations.
 - For raised islands on which a traffic signal or traffic signal hardware is located.
 - For expediting transfer times for transit partners on low- speed roadways in urban and suburban contexts (verify curb height needed with transit provider).
- (b) Consider vertical curbs with a height of 6 inches or more:
- To inhibit midblock left turns.
 - For divisional and channelizing islands.
 - For landscaped islands.
 - Stormwater conveyance
- (c) Provide sloped curbs where a curb is needed but vertical curb is not suitable.
- (d) Provide mountable curbs where a curb is needed and accommodation for specific design users makes it necessary.

In general, curbs are not recommended on high-speed facilities. Avoid using curbs if the same objective can be attained with pavement markings. However, 4-inch-high sloped curbs may be considered on high-speed facilities to control drainage or for access control. Locate sloped curb no closer to the traveled way than the outer edge of the shoulder. Provide sloping end treatments where the curb is introduced and terminated. 6-inch-high sloped curbs may be considered on high-speed urban and suburban contexts where streetside zones are provided or where traffic movements are to be restricted. Provide justification for the use of vertical curb when applied to high-speed facilities.

Intermediate speed facilities may use vertical or sloped curbs, however, consider sloped curbs for intermediate target speeds. Consider use of 12-inch to 18-inch vertical curb when analysis demonstrates a need to reduce lane departure concerns on intermediate-speed facilities. All curb types are appropriate for low-speed facilities.

Where curbing is to be provided, provide a design that collects the surface water at the curb and drains it without ponding or flowing across the roadway, as much as practicable to meet the safety and mobility performance needs for a project.

In some areas, curb may be needed to control runoff water until ground cover is attained to control erosion. Plan to remove the curb when the ground cover becomes adequate. Arrange for curb removal with region maintenance staff as part of the future maintenance plans (see Maintenance Owner's Manual guidance in [Chapter 301](#)). When curb is used in conjunction with

guardrail, see [Chapter 1610](#) for guidance. For existing curb, particularly on high-speed facilities, evaluate the continued need for the curb. Remove curbing that is no longer needed.

When an overlay will reduce the height of a curb, evaluate grinding (or replacing the curb) to maintain curb height if recommended by the pavement design. (See [1230.06\(1\)](#) for shoulder cross slope considerations.) To maintain or restore curb height, consider lowering the existing pavement level and improving cross slope by grinding before an asphalt overlay or as determined by the pavement design. The cross slope of the shoulder may be steepened to maximize curb height and minimize other related impacts.

Curbs can hamper snow-removal operations. In areas of heavy snowfall, get the Area Maintenance Superintendent's review for the use of curbing.

For curbs at traffic islands, see [Chapter 1310](#). For curbs at roundabouts, see [Chapter 1320](#) and the *Standard Plans*.

1230.06 Cross Slope

The cross slope on tangents and curves is a main element in roadway design. The cross slope or crown on tangent sections and large radius curves is complicated by the following two contradicting controls:

- Reasonably steep cross slopes aid in water runoff and minimize ponding as a result of pavement imperfections and unequal settlement.
- Steeper cross slopes are noticeable in steering, increase the tendency for vehicles to drift to the low side of the roadway, and increase the susceptibility of vehicles to slide to the side on icy or wet pavements.

A 2% cross slope is normally used for tangents and large-radius curves on high and intermediate pavement types, although cross slopes may vary from the target 2%.

The algebraic difference in cross slopes is an operational factor during a passing maneuver on a two-lane two-way roadway. Its influence increases when increased traffic volumes decrease the number and size of available passing opportunities.

On ramps with metering, consider how cross slopes can impact driver comfort within the queue. Additionally, larger cross slopes may present concerns about maintaining vehicle lateral position within the queue lane, depending on weather and resulting pavement conditions.

A somewhat steeper cross slope may be needed to facilitate recommended drainage design, even though this might be less desirable from an operational point of view. In such areas, consider not exceeding design cross slopes of 2.5% with an algebraic difference of 5%.

For a two-lane two-way roadway, provide an algebraic difference to meet the appropriate conditions stated above except when drainage design recommends otherwise.

1230.06(1) Shoulder Cross Slope

Shoulder cross slopes are normally the same as the cross slopes for adjacent lanes. With justification, shoulder slopes may be increased to 6%. On the high side of a roadway with a plane section, such as a turning roadway in superelevation, the shoulder may slope in the opposite direction from the adjacent lane. The maximum difference in slopes between the lane

and the shoulder is 8%. Locations where it may be desirable to have a shoulder slope different than the adjacent lane are:

- Where curbing is used.
- Where shoulder surface is bituminous, gravel, or crushed rock.
- Where overlays are planned and it is desirable to maintain the grade at the edge of the shoulder.
- On divided highways with depressed medians where it is desirable to drain the runoff into the median.
- On the high side of the superelevation on curves where it is desirable to drain stormwater or meltwater away from the roadway.

Where extruded curb is used, see the *Standard Plans* for placement (see [1230.05](#) for additional information on curbs). Widening is also normally provided where traffic barrier is installed (see [Chapter 1610](#) and the *Standard Plans*).

On ramps with metering, where the shoulder is or could be utilized for queuing, consider how the shoulder cross slope can impact driver comfort within the queue. Additionally, larger shoulder cross slopes may present concerns of maintaining vehicle lateral position within the queue lane, depending on weather and resulting pavement conditions.

Exhibits [1230-7](#) through [1230-8b](#) present shoulder details and guidelines.

1230.07 Structure Width

Provide a structure width necessary to achieve the desired safety and operational performance of the modal priorities (see [Chapter 1103](#)). While it is preferred not to alter the continuity of a roadway, there may be situations where providing a structure width more or less than the roadway approaching the structure is appropriate. For additional information regarding structures, see [Chapter 710](#).

1230.08 Documentation

Document selected design elements in Section 6 of the Basis of Design (BOD), when applicable (see [Chapters 1100](#) and [1105](#)), and document selected dimensions and dimensioning method utilized (see [Chapter 1106](#)) in the Design Parameter Sheets:

 www.wsdot.wa.gov/Design/Support.htm

1230.09 References

1230.09(1) Design Guidance

Highway Runoff Manual, M 31-16, WSDOT

Local Agency Guidelines (LAG), M 36-63, WSDOT

Plans Preparation Manual, M 22-31, WSDOT

Standard Plans for Road, Bridge, and Municipal Construction (*Standard Plans*), M 21-01, WSDOT

Standard Specifications for Road, Bridge, and Municipal Construction (Standard Specifications), M 41-10, WSDOT

1230.09(2) Supporting Information

FHWA Road Diet Informational Guide, FHWA, 2014
🔗 www.safety.fhwa.dot.gov/road_diets/info_guide/

Understanding Flexibility in Transportation Design – Washington, WA-RD 638.1, Washington State Department of Transportation, 2005
🔗 www.wsdot.wa.gov/research/reports/fullreports/638.1.pdf

Urban Bikeway Design Guide, National Association of City Transportation Officials, New York, NY, 2012 revised 2013
🔗 www.nacto.org

Urban Street Design Guide, National Association of City Transportation Officials, New York, NY, 2013 🔗 www.nacto.org

Designing Walkable Thoroughfares: A Context Sensitive Approach, Institute of Transportation Engineers, Washington D.C., 2010. 🔗 www.ite.org

Guide for Geometric Design of Transit Facilities on Highways and Streets, AASHTO, Washington, D.C., 2011 🔗 www.transportation.org/Pages/Default.aspx

A Policy on Geometric Design of Highways and Streets (Green Book), AASHTO, current edition
🔗 www.transportation.org/Pages/Default.aspx

A Policy on Design Standards Interstate System, AASHTO, 2005
🔗 www.transportation.org/Pages/Default.aspx

NCHRP Synthesis 443 – Practical Highway Design Solutions, Transportation Research Board, Washington D.C., 2013
🔗 <http://www.trb.org/Main/Blurbs/168619.aspx>

NCHRP Report 785 – Performance-Based Analysis of Geometric Design of Highways and Streets, Transportation Research Board, Washington D.C., 2014
🔗 www.trb.org/Main/Blurbs/171431.aspx

NCHRP Report 783 – Evaluation of the 13 Controlling Criteria for Geometric Design, Transportation Research Board, Washington D.C., 2014
🔗 www.trb.org/Main/Blurbs/171358.aspx

NCHRP Report 505 – Review of Truck Characteristics as Factors in Roadway Design, Transportation Research Board, Washington D.C., 2003
🔗 http://onlinepubs.trb.org/onlinepubs/nchrp/nchrp_rpt_505.pdf

- 1240.01 General
- 1240.02 Turning Roadway Widths
- 1240.03 Documentation
- 1240.04 References

1240.01 General

The roadway on a curve may need to be widened to make the operating conditions comparable to those on tangents. There are two main reasons to do this. One is the off-tracking of vehicles such as trucks and buses. The other is the increased difficulty drivers have in keeping their vehicles in the center of the lane. Apply turning roadway widths only when there is a need to optimize the operational or safety performance of a particular segment of roadway with larger volumes of trucks or when trucks are the identified modal priority. The application of turning roadway width is not applicable on managed access low-speed roadways or managed access intermediate-speed highways in suburban or urban contexts.

For additional information, see the following chapters:

Chapter	Subject
1230	Cross section design element widths
1250	Superelevation
1360	Lane and shoulder widths for ramps

1240.02 Turning Roadway Widths

1240.02(1) Two-Lane Two-Way Roadways

[Exhibit 1240-1a](#) shows the traveled way width (W) for two-lane two-way roadways. For values of [radius \(R\)](#) between those given, interpolate W and round up to the next foot.

Minimum traveled way width (W), based on the delta angle of the curve (shown in [Exhibit 1240-1b](#)), may be used. Document the reasons for using the minimum width. Round W to the nearest foot.

Widths given in Exhibits [1240-1a](#) and [1b](#) are for facilities with 12-foot lanes. When 11-foot lanes are [selected](#), width (W) may be reduced by 2 feet.

1240.02(2) Two-Lane One-Way Roadways

[Exhibit 1240-2a](#) shows the traveled way width (W) for two-lane one-way turning roadways, including two-lane ramps and four-lane highways. For values of [radius \(R\)](#) between those given, interpolate W and round up to the next foot. Treat each direction of travel on four-lane facilities as a one-way roadway.

Minimum traveled way width (W), based on the delta angle of the curve (shown in [Exhibit 1240-2b](#)), may be used. Document the reasons for using the minimum width. Round W to the nearest foot.

Widths given in Exhibits [1240-2a](#) and [2b](#) are for facilities with 12-foot lanes. When 11-foot lanes are selected, width (W) may be reduced by 2 feet.

To keep widths to a minimum, the traveled way widths for Exhibits [1240-2a](#) and [2b](#) were calculated using the WB-40 design vehicle. When volumes are high for trucks larger than the WB-40 and other traffic, consider using the widths from Exhibits [1240-1a](#) and [1b](#).

1240.02(3) One-Lane Roadways

[Exhibit 1240-3a](#) shows the traveled way width (W) for one-lane turning roadways. For values of R between those given, interpolate W and round up to the next foot. Exhibit 1240-3a applies to one-lane ramps only when the largest vehicles present demonstrate a safety or operational need based on frequency of use and shoulder pavement depths, and when turn simulation software shows that the total roadway width cannot accommodate the turning movement within the structural pavement section.

Minimum width (W), based on the delta angle of the curve for one-lane roadways, may be used. [Exhibit 1240-3b](#) gives W using the radius to the outer edge of the traveled way. [Exhibit 1240-3c](#) gives W using the radius on the inner edge of the traveled way. Document the reasons for using the minimum width. Round W to the nearest foot.

Build shoulder pavements at full depth for one-lane roadways. To keep widths to a minimum, traveled way widths were calculated using the WB-40 design vehicle, which may force larger vehicles to encroach on the shoulders. This also helps to maintain the integrity of the roadway structure during partial roadway closures.

1240.02(4) Other Roadways

For roadways where the traveled way is more than two lanes in any direction:

- For each lane in addition to two, additional width in excess of the selected lane width dimension (see Chapters [1230](#) and [1106](#)) is not needed.
- For three-lane ramps with HOV lanes, see [Chapter 1410](#).

1240.02(5) Total Roadway Width

Shoulder widths for the highway or ramp are added to the traveled way width to determine the total roadway width.

Small amounts of widening add to the cost with little added benefit. When the traveled way width for turning roadways results in widening less than 0.5 foot per lane, or a total widening of less than 2 feet on existing roadways that are to remain in place, it may be disregarded.

When widening the traveled way:

- Widening may be constructed on the inside of the traveled way or divided equally between the inside and outside. Do not construct widening only on the outside of a curve.
- Place final marked lane lines, and any longitudinal joints, at equal spacing between the edges of the widened traveled way.

- Provide widening throughout the curve length.
- For widening on the inside, make transitions on a tangent where possible.
- For widening on the outside, develop the widening by extending the tangent. This avoids the appearance of a reverse curve that a taper would create.
- For widening of 6 feet or less, use a 1:25 taper. For widths greater than 6 feet, use a 1:15 taper.

1240.03 Documentation

Refer to [Chapter 300](#) for design documentation requirements.

1240.04 References

1240.04(1) Design Guidance

[Standard Plans for Road, Bridge, and Municipal Construction \(Standard Plans\)](#), M 21-01, WSDOT

[Standard Specifications for Road, Bridge, and Municipal Construction \(Standard Specifications\)](#), M 41-10, WSDOT

1240.04(2) Supporting Information

A Policy on Geometric Design of Highways and Streets (Green Book), AASHTO, [current edition](#)

Exhibit 1240-1a Traveled Way Width for Two-Lane Two-Way Turning Roadways

Radius on Centerline of Traveled Way, R (ft)	Design Traveled Way Width, W (ft) ^[1]
3,000 to tangent	24
2,999	25
2,000	26
1,000	27
800	28
600	29
500	30
400	31
350	32
300	33
250	35
200	37
150	41

Note:

[1] Width (W) is based on:

- WB-67 design vehicle
- 3-ft clearance per lane (12-ft lanes)

When 11-ft lanes are selected, width may be reduced by 2 ft.

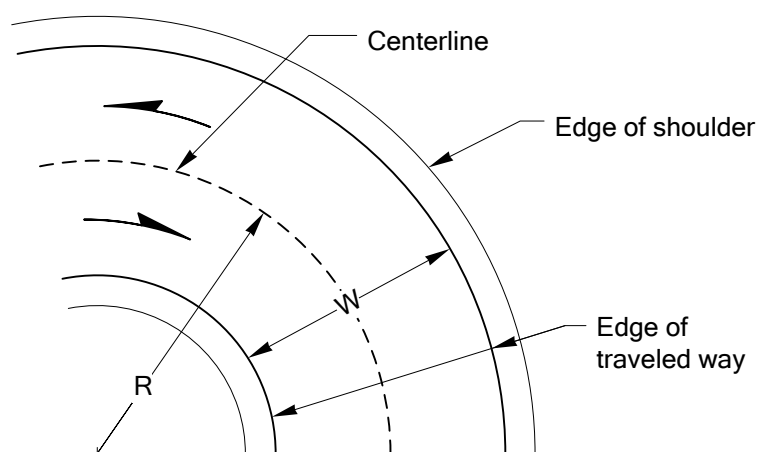
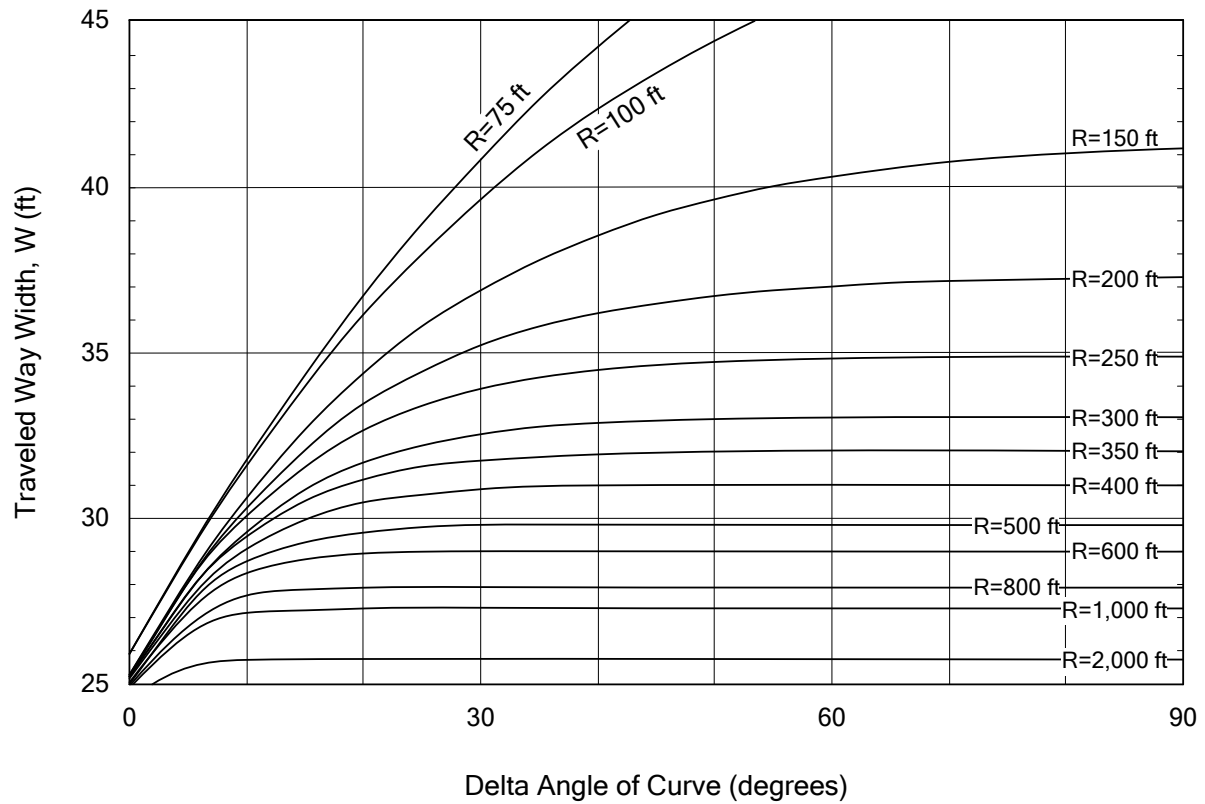

Exhibit 1240-1b Traveled Way Width for Two-Lane Two-Way Turning Roadways: Based on the Delta Angle

**Note:**

Width (W) is based on:

- WB-67 design vehicle
- 3-ft clearance per lane (12-ft lanes)

When 11-ft lanes are selected, width may be reduced by 2 ft.

Exhibit 1240-2a Traveled Way Width for Two-Lane One-Way Turning Roadway

Radius on Centerline of Traveled Way, R (ft)	Design Traveled Way Width, W (ft) ^[1]
3,000 to tangent	24
1,000 to 2,999	25
999	26
600	26
500	27
400	27
300	28
250	29
200	29
150	31
100	34

Note:

[1] Width (W) is based on:

- WB-40 design vehicle
- 3-ft clearance per lane (12-ft lanes)

When 11-ft lanes are selected, width may be reduced by 2 ft.

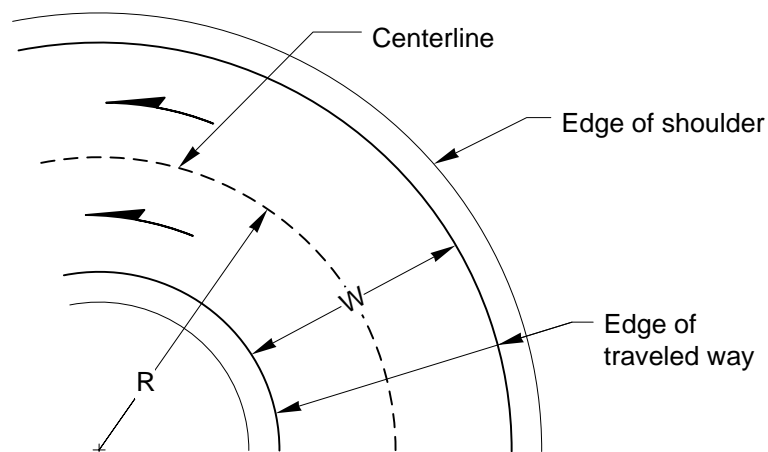
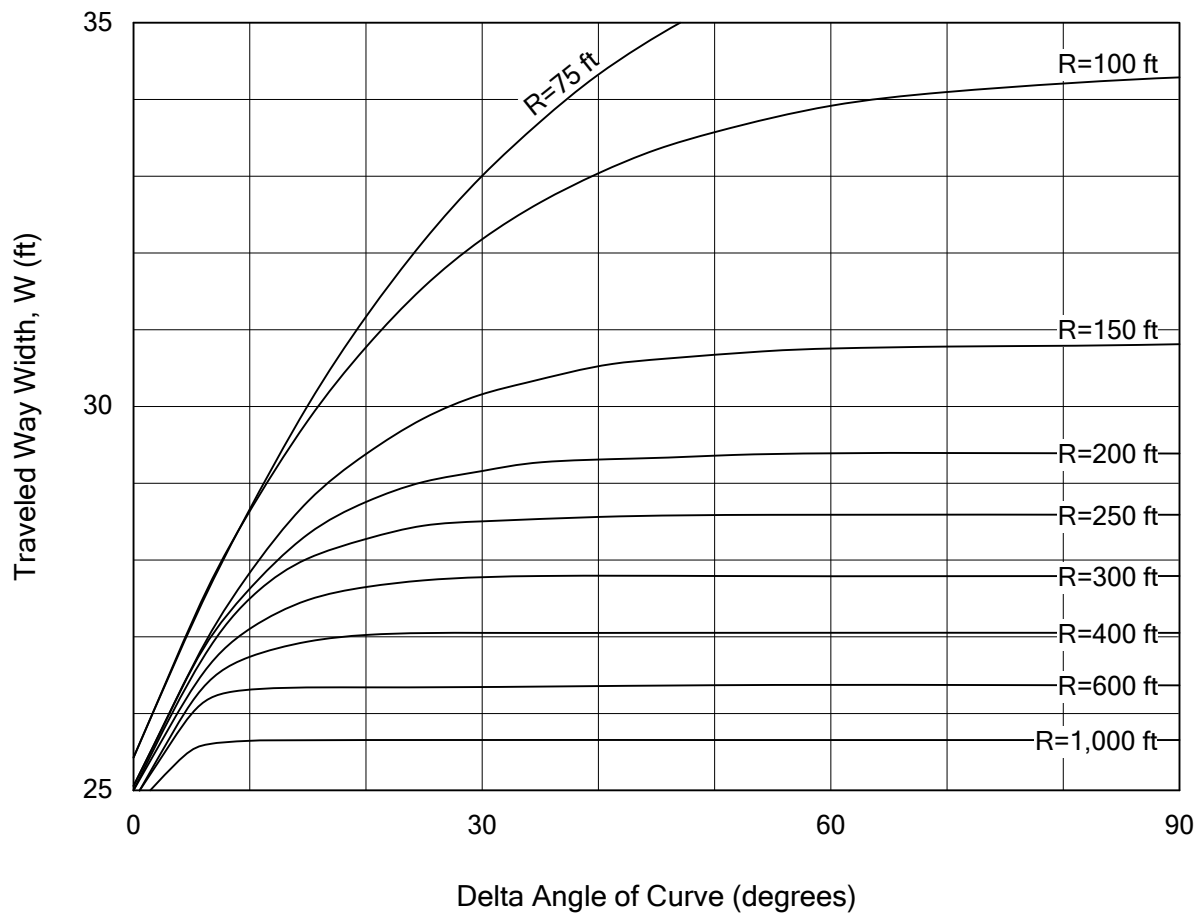

Exhibit 1240-2b Traveled Way Width for Two-Lane One-Way Turning Roadways: Based on the Delta Angle

**Note:**

Width (W) is based on:

- WB-40 design vehicle
- 3-ft clearance per lane (12-ft lanes)

When 11-ft lanes are selected, width may be reduced by 2 ft.

Exhibit 1240-3a Traveled Way Width for One-Lane Turning Roadways

Radius, R (ft)	Design Traveled Way Width, W (ft)	
	Radius on Outside Edge of Traveled Way	Radius on Inside Edge of Traveled Way
7,500 to tangent	13 ^[1]	13 ^[1]
1,600	14	14
300	15	15
250	16	16
200	17	17
150	17	17
100	19	18
75	21	19
50	26	22

Note:

[1] On tangents, the minimum lane width is selected based on Chapters [1230](#) and [1106](#).

Width (W) is based on:

- WB-40 design vehicle
- 4-ft clearance

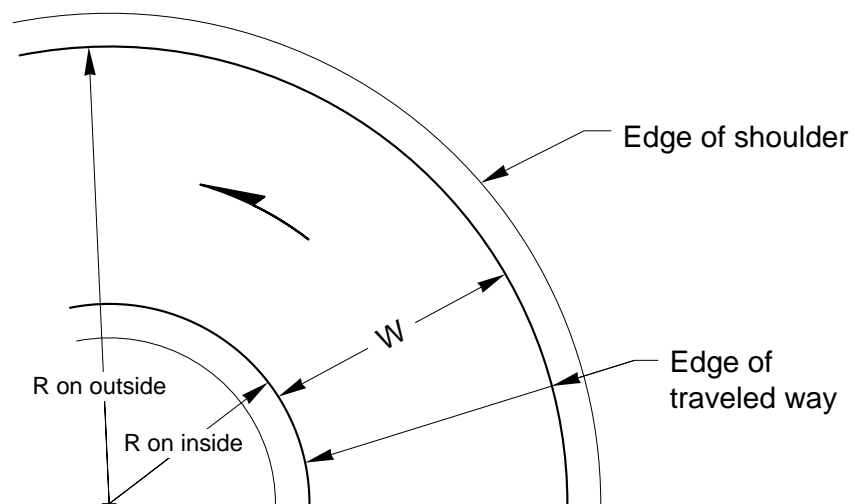
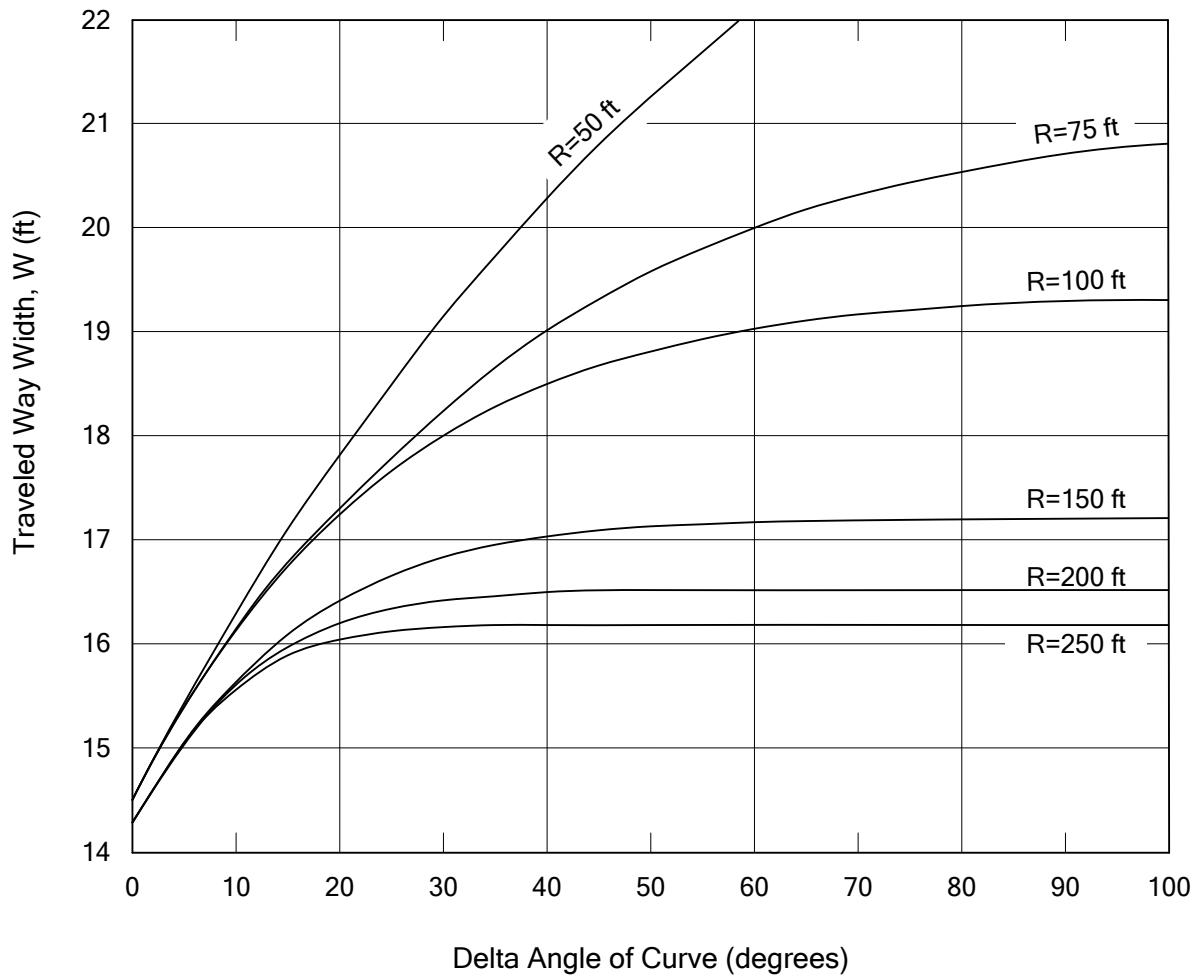

Exhibit 1240-3b Traveled Way Width for One-Lane Turning Roadways: Based on the Delta Angle, Radius on Outside Edge of Traveled Way



Note:

All radii are to the outside edge of traveled way.

Width (W) is based on:

- WB-40 design vehicle
- 4-ft clearance

Exhibit 1240-3c Traveled Way Width for One-Lane Turning Roadways: Based on the Delta Angle, Radius on Inside Edge of Traveled Way

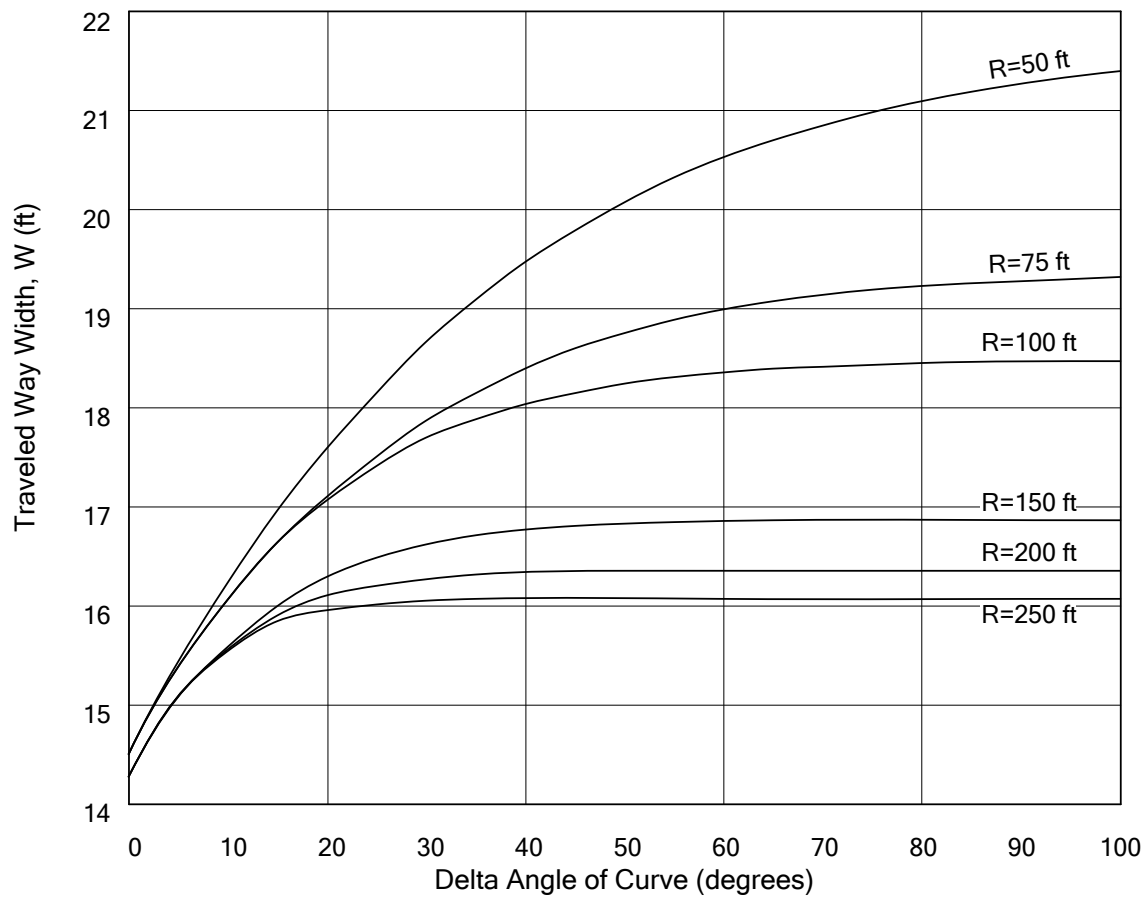

Note:

All radii are to the inside edge of traveled way.

Width (W) is based on:

- WB-40 design vehicle
- 4-ft clearance

- 1250.01 General
- 1250.02 Superelevation Rate Selection
- 1250.03 Existing Curves
- 1250.04 Turning Movements at Intersections
- 1250.05 Runoff for Highway Curves
- 1250.06 Runoff for Ramp Curves
- 1250.07 Documentation
- 1250.08 References

1250.01 General

To maintain the design speed, highway and ramp curves are usually superelevated to overcome part of the centrifugal force that acts on a vehicle.

For additional information, see the following chapters:

Chapter	Subject
1230	Roadway widths and cross slopes
1360	Lane and shoulder widths for ramps

1250.02 Superelevation Rate Selection

The maximum superelevation rate allowed is 10%.

Depending on design speed, construct large-radius curves with a normal crown section. The minimum radii for normal crown sections are shown in [Exhibit 1250-1](#). Superelevate curves with smaller radii as follows:

- [Exhibit 1250-4a](#) ($e_{\max}=10\%$) is desirable for all open highways, ramps, and long-term detours, especially when associated with a main line detour.
- [Exhibit 1250-4b](#) ($e_{\max}=8\%$) may be used for freeways in urban design areas and areas where the $e_{\max}=6\%$ rate is allowed but $e_{\max}=8\%$ is preferred.
- [Exhibit 1250-4c](#) ($e_{\max}=6\%$) may be used—with justification—for nonfreeways in urban design areas, in mountainous areas, and for short-term detours, which are generally implemented and removed in one construction season.
- [Exhibit 1250-5](#) may be used for turning roadways at intersections, urban managed access highways with a design speed of 40 mph or less, and—with justification—ramps in urban areas with a design speed of 40 mph or less.

When selecting superelevation for a curve, consider the existing curves on the corridor. To maintain route continuity and driver expectation on open highways, select the chart (see Exhibits [1250-4a](#), [4b](#), or [4c](#)) that best matches the superelevation on the existing curves.

In locations that experience regular accumulations of snow and ice, limit superelevation from the selected chart to 6% or less. In these areas, provide justification for superelevation rates greater than 6%. Vehicles moving at slow speeds or stopped on curves with supers greater than 6% tend to slide inward on the radius (downslope).

Round the selected superelevation rate to the nearest full percent.

Exhibit 1250-1 Minimum Radius for Normal Crown Section

Design Speed (mph)	Minimum Radius for Normal Crown Section (ft)
15	945
20	1,680
25	2,430
30	3,325
35	4,360
40	5,545
45	6,860
50	8,315
55	9,920
60	11,675
65	13,130
70	14,675
75	16,325
80	18,065

1250.03 Existing Curves

Evaluate the superelevation on an existing curve to determine its adequacy. Use the equation in Exhibit 1250-2 to determine the minimum radius for a given superelevation and design speed.

Exhibit 1250-2 Minimum Radius for Existing Curves

$$R = \frac{6.68V^2}{e + f}$$

Where:
R = The minimum allowable radius of the curve (ft)
V = Design speed (mph)
e = Superelevation rate (%)
f = Side friction factor from [Exhibit 1250-3](#)

For Preservation projects where the existing pavement is to remain in place, the superelevation on existing curves may be evaluated with a ball banking analysis.

Address superelevation when the existing radius is less than the minimum radius calculated using the equation or when the maximum speed determined by a ball banking analysis is less than the design speed. When modifying the superelevation of an existing curve, provide superelevation as given in [1250.02](#).

Exhibit 1250-3 Side Friction Factor

Design Speed (mph)	Side Friction Factor (f)
15	32
20	27
25	23
30	20
35	18
40	16
45	15
50	14
55	13
60	12
65	11
70	10
75	9
80	8

1250.04 Turning Movements at Intersections

Curves associated with the turning movements at intersections are superelevated using the rates for low-speed urban roadway curves. Use superelevation rates as high as practicable, consistent with curve length and climatic conditions. [Exhibit 1250-5](#) shows the minimum superelevation for the given design speed and radius. When using high superelevation rates on short curves, provide smooth transitions with merging ramps or roadways.

1250.05 Runoff for Highway Curves

Provide transitions for all superelevated highway curves as specified in Exhibits [1250-6a](#) through [6e](#). Which transition to use depends on the location of the pivot point, the direction of the curve, and the roadway cross slope. The length of the runoff is based on a maximum allowable difference between the grade at the pivot point and the grade at the outer edge of traveled way for one 12-foot lane.

Pay close attention to the profile of the edge of traveled way created by the superelevation runoff; do not let it appear distorted. The combination of superelevation transition and grade may result in a hump and/or dip in the profile of the edge of traveled way. When this happens, the transition may be lengthened to eliminate the hump and/or dip. If the hump and/or dip cannot be eliminated this way, pay special attention to drainage in the low areas to prevent ponding. Locate the pivot point at the centerline of the roadway to help minimize humps and dips at the edge of the traveled lane and reduce the superelevation runoff length.

When reverse curves are necessary, provide sufficient tangent length for complete superelevation runoff for both curves—that is, from full superelevation of the first curve, to level to full superelevation of the second curve. If tangent length is longer than this, but not sufficient to provide full super transitions—that is, from full superelevation of the first curve, to normal crown to full superelevation of the second curve—increase the superelevation runoff lengths until they abut. This provides one continuous transition, without a normal crown section, similar to Designs C2 and D2 in Exhibits 1250-6c and 6d, except that full super will be attained rather than the normal pavement slope as shown.

Superelevation runoff on structures is permissible but not desirable. Whenever practicable, strive for full super or normal crown slopes on structures.

1250.06 Runoff for Ramp Curves

Superelevation runoff for ramps use the same maximum relative slopes as the specific design speeds used for highway curves. Multilane ramps have a width similar to the width for highway lanes; therefore, Exhibits 1250-6a through 6e are used to determine the superelevation runoff for ramps. Superelevation transition lengths (LT) for single-lane ramps are given in Exhibits 1250-7a and 7b. Additional runoff length for turning roadway widening is not required.

1250.07 Documentation

Refer to [Chapter 300](#) for design documentation requirements.

1250.08 References

1250.08(1) Design Guidance

[Standard Plans for Road, Bridge, and Municipal Construction \(Standard Plans\)](#), M 21-01, WSDOT

[Standard Specifications for Road, Bridge, and Municipal Construction \(Standard Specifications\)](#), M 41-10, WSDOT

1250.08(2) Supporting Information

A Policy on Geometric Design of Highways and Streets (Green Book), AASHTO, current edition

Exhibit 1250-4a Superelevation Rates (10% Max)

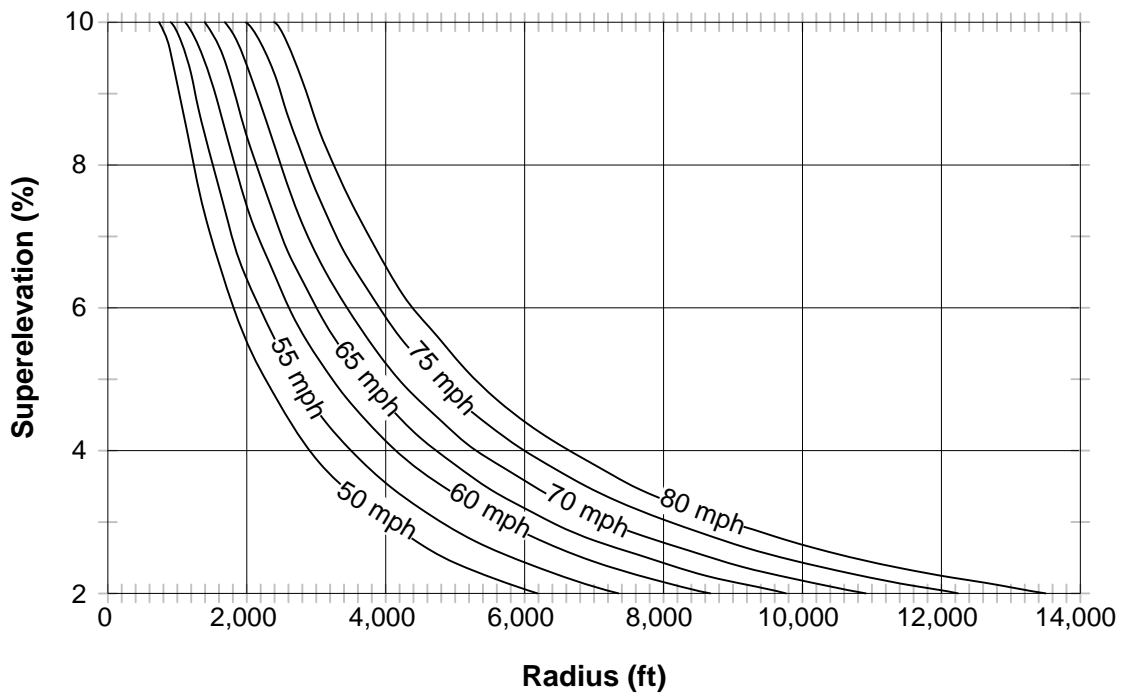
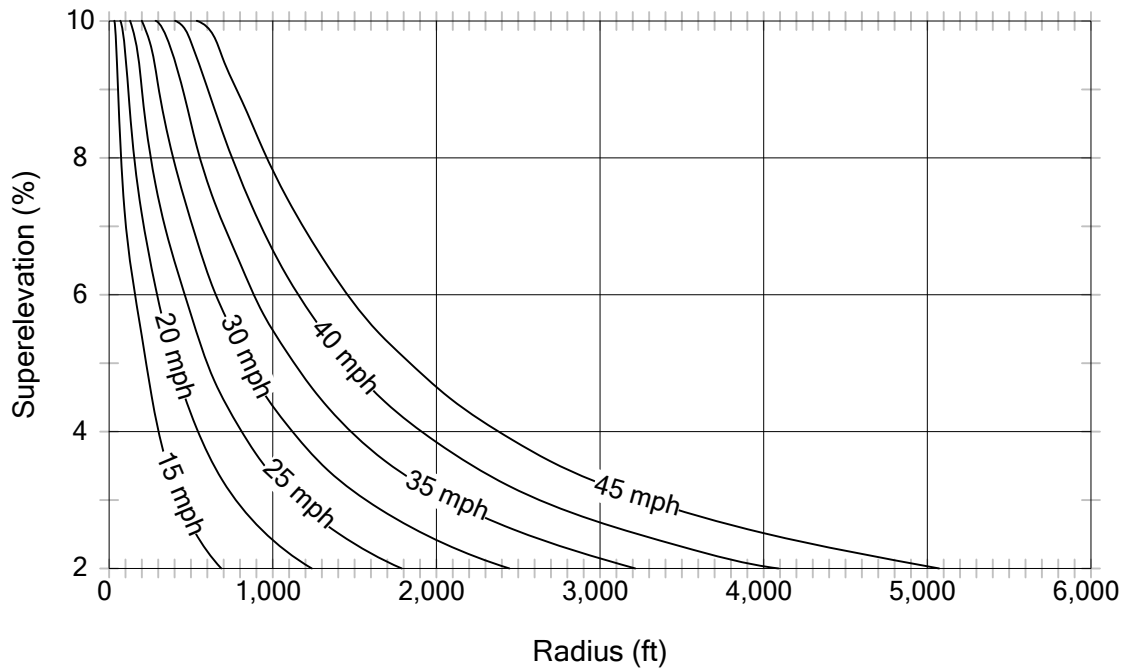

Design Speed (mph)	15	20	25	30	35	40	45	50	55	60	65	70	75	80
Minimum Radius (ft)	40	75	130	205	295	415	545	700	880	1,095	1,345	1,640	1,980	2,380

Exhibit 1250-4b Superelevation Rates (8% Max)

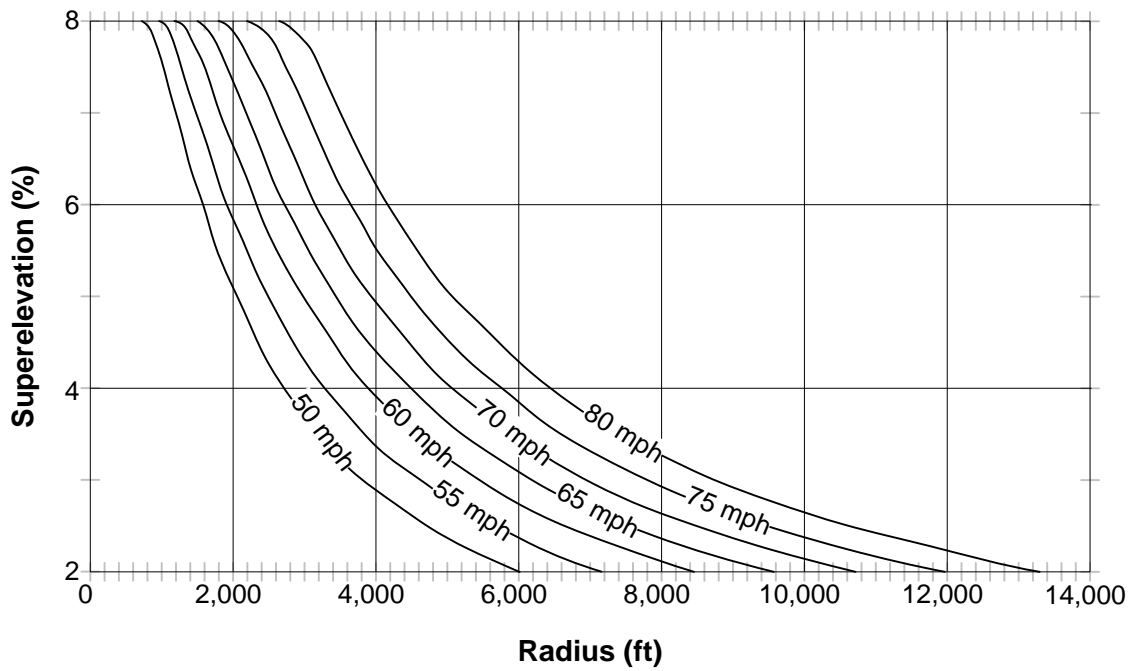
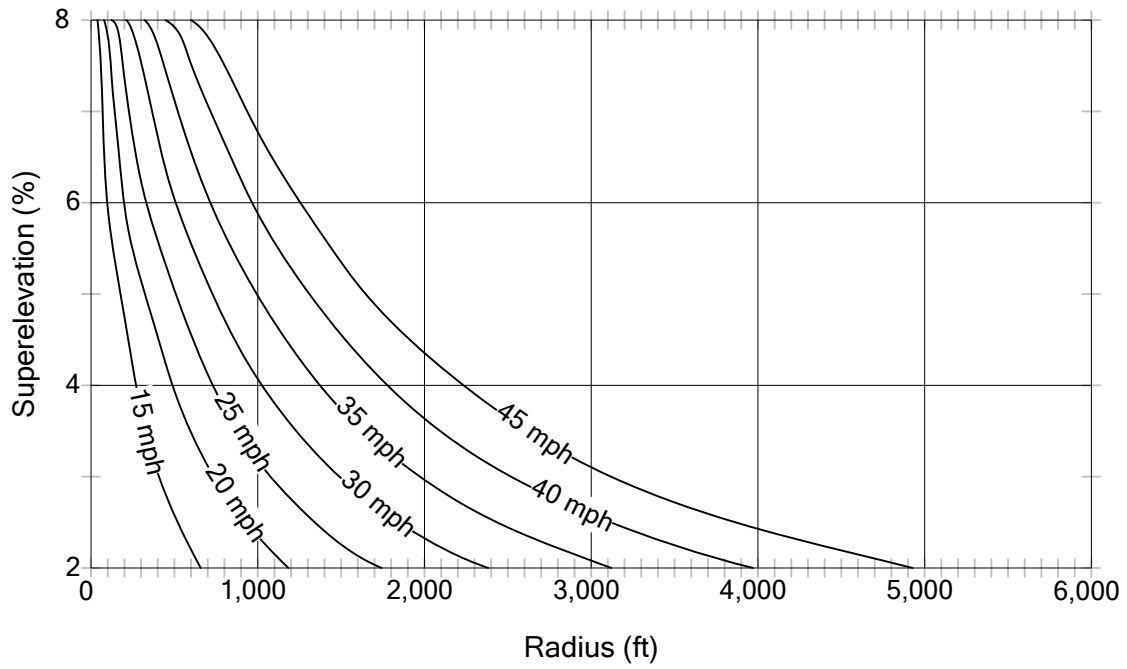

Design Speed (mph)	15	20	25	30	35	40	45	50	55	60	65	70	75	80
Minimum Radius (ft)	40	80	135	215	315	450	590	760	965	1,205	1,490	1,820	2,215	2,675

Exhibit 1250-4c Superelevation Rates (6% Max)

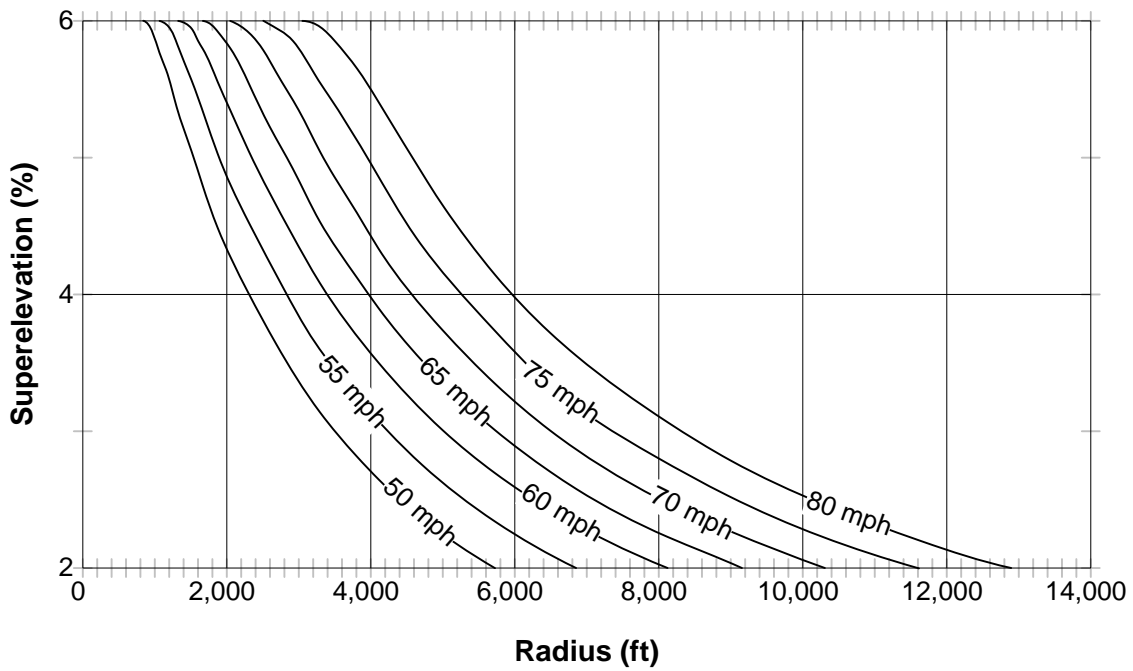
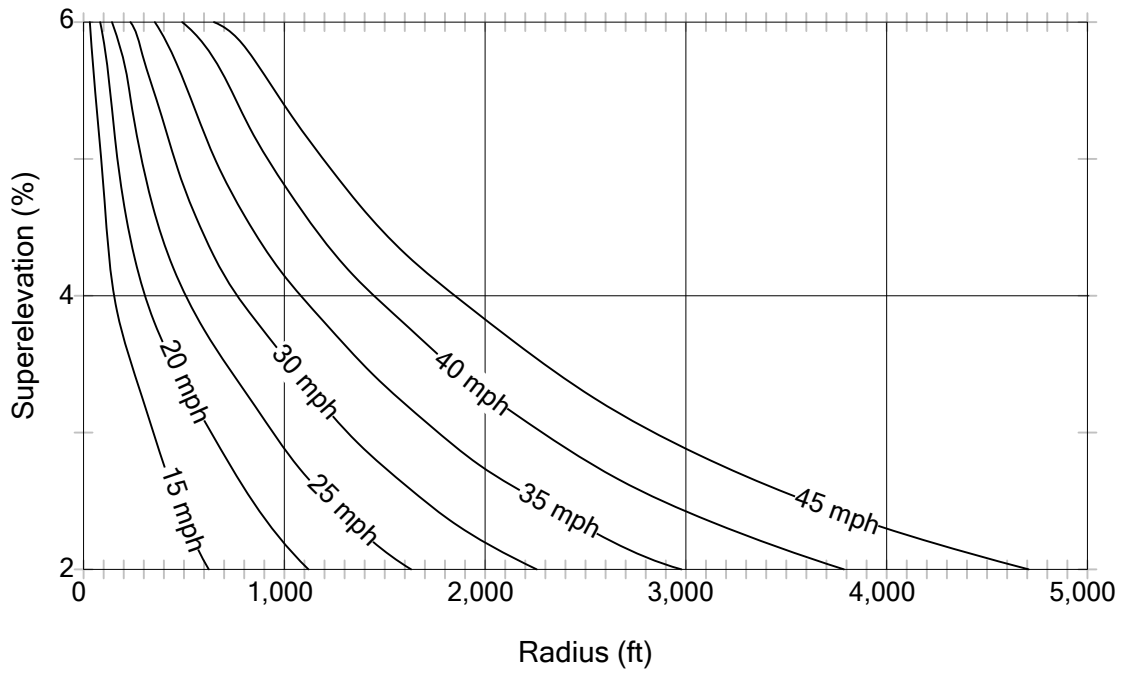

Design Speed (mph)	15	20	25	30	35	40	45	50	55	60	65	70	75	80
Minimum Radius (ft)	40	85	145	235	345	490	645	840	1,065	1,340	1,665	2,050	2,510	3,055

Exhibit 1250-5 Superelevation Rates for Intersections and Low-Speed Urban Roadways

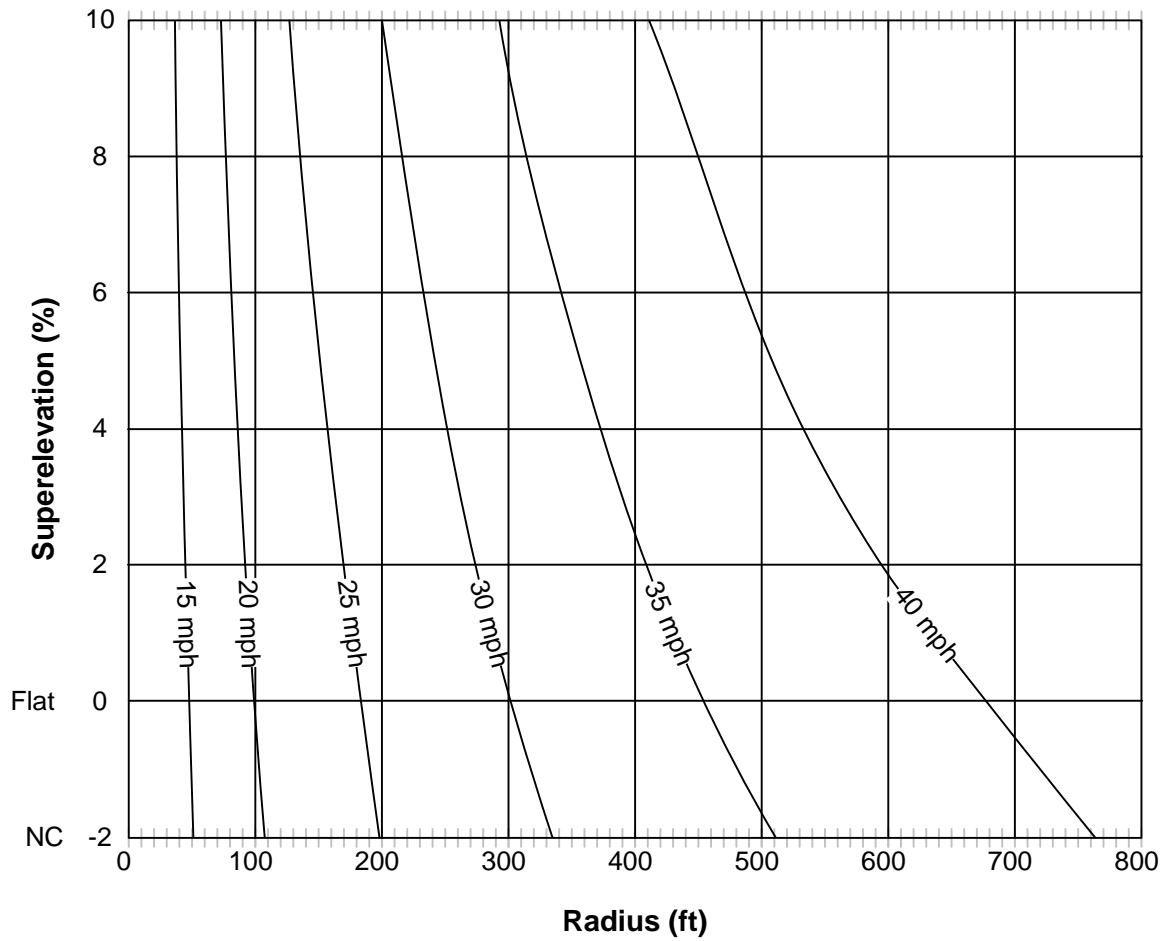

NC = Normal crown

Exhibit 1250-6a Superelevation Transitions for Highway Curves

e (%)	L _B =Basic Runoff in Feet for Design Speed*													
	15 mph	20 mph	25 mph	30 mph	35 mph	40 mph	45 mph	50 mph	55 mph	60 mph	65 mph	70 mph	75 mph	80 mph
2	30	30	35	35	40	40	45	50	50	55	55	60	65	70
3	45	50	50	55	60	60	65	70	75	80	85	90	95	105
4	60	65	70	75	75	85	90	95	100	105	110	120	125	135
5	75	80	85	90	95	105	110	120	130	135	140	150	160	170
6	90	95	105	110	115	125	135	145	155	160	170	180	190	205
7	110	115	120	130	135	145	155	170	180	185	195	210	220	240
8	125	130	135	145	155	165	180	190	205	215	225	240	250	275
9	140	145	155	165	175	185	200	215	230	240	250	270	285	310
10	155	160	170	180	195	205	220	240	255	265	280	300	315	345

*Based on one 12-ft lane between the pivot point and the edge of traveled way. When the distance exceeds 12 ft, use the following equation to obtain LR:

$$L_R = L_B(1 + 0.04167X)$$

Where:

X = The distance in excess of 12 ft between the pivot point and the farthest edge of traveled way, in ft.

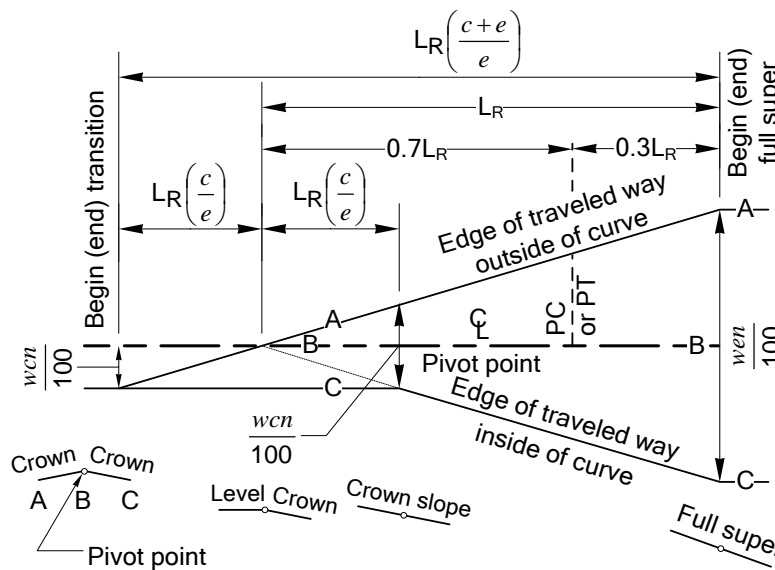

Design A – Pivot Point on Centerline Crown Section

c = Normal crown (%)

e = Superelevation rate (%)

n = Number of lanes between points

w = Width of lane

Exhibit 1250-6b Superelevation Transitions for Highway Curves

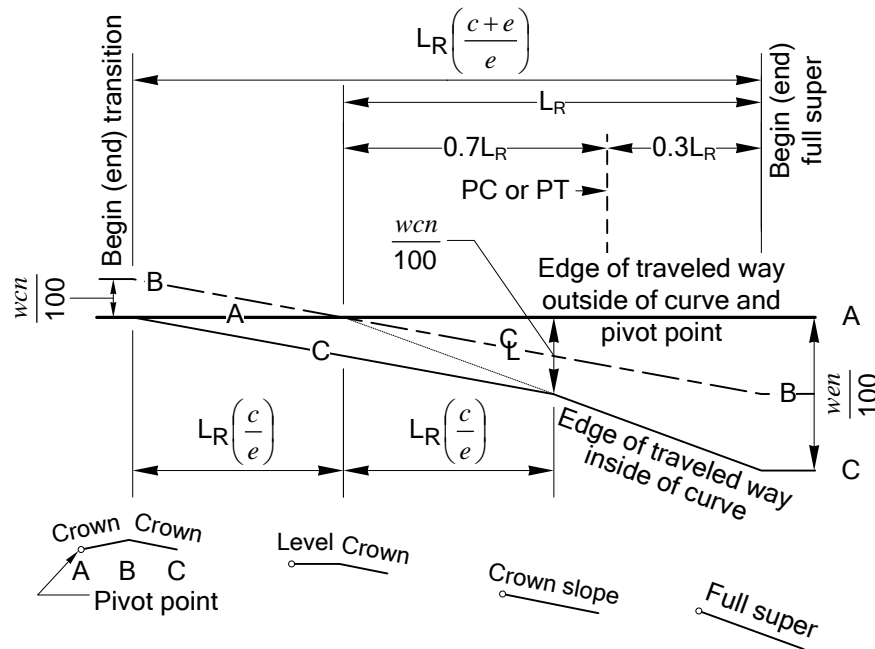

**Design B¹ – Pivot Point on Edge of Traveled Way:
Outside of Curve Crowned Section**

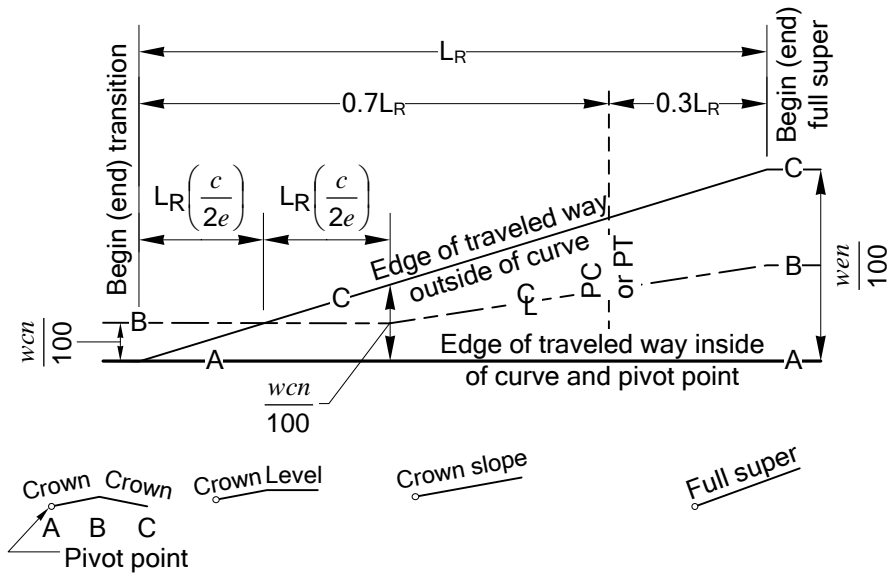

**Design B² – Pivot Point on Edge of Traveled Way:
Inside of Curve Crowned Section**

- c = Normal crown (%)
- e = Superelevation rate (%)
- n = Number of lanes between points
- w = Width of lane

Exhibit 1250-6c Superelevation Transitions for Highway Curves

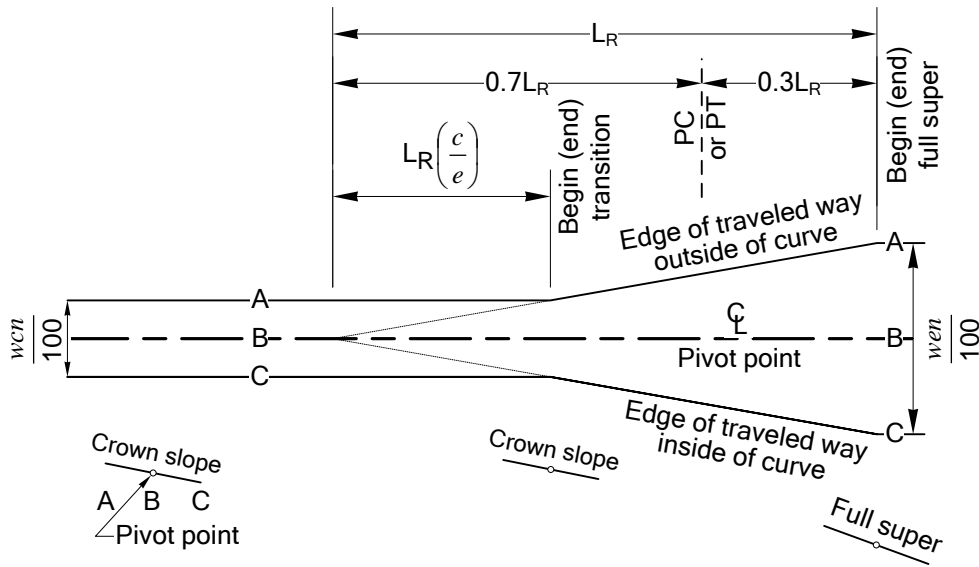

**Design C¹ – Pivot Point on Centerline Curve
in Direction of Normal Pavement Slope: Plane Section**

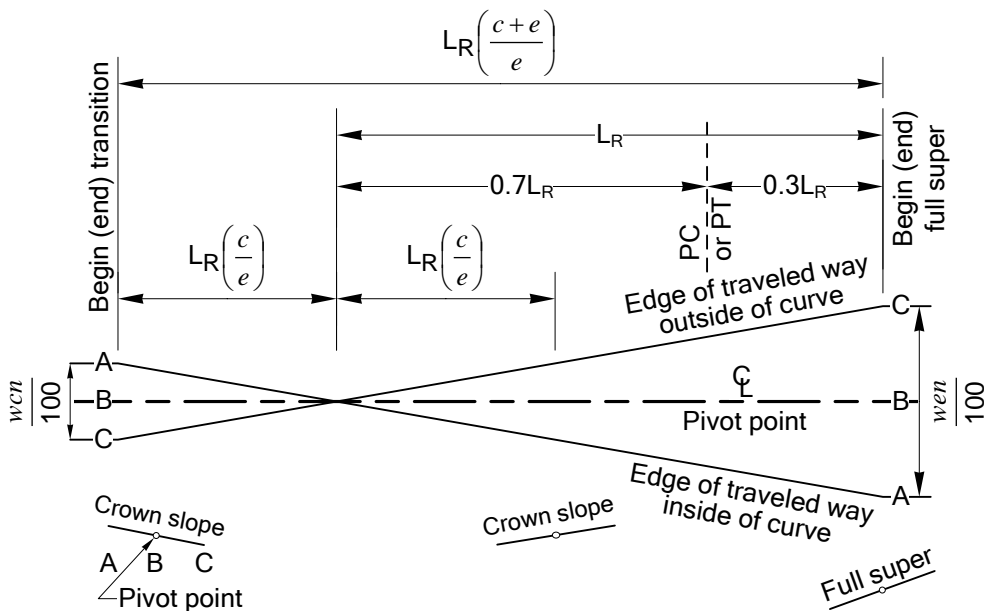

**Design C² – Pivot Point on Centerline Curve
Opposite to Normal Pavement Slope: Plane Section**

- c = Normal crown (%)
- e = Superelevation rate (%)
- n = Number of lanes between points
- w = Width of lane

Exhibit 1250-6d Superelevation Transitions for Highway Curves

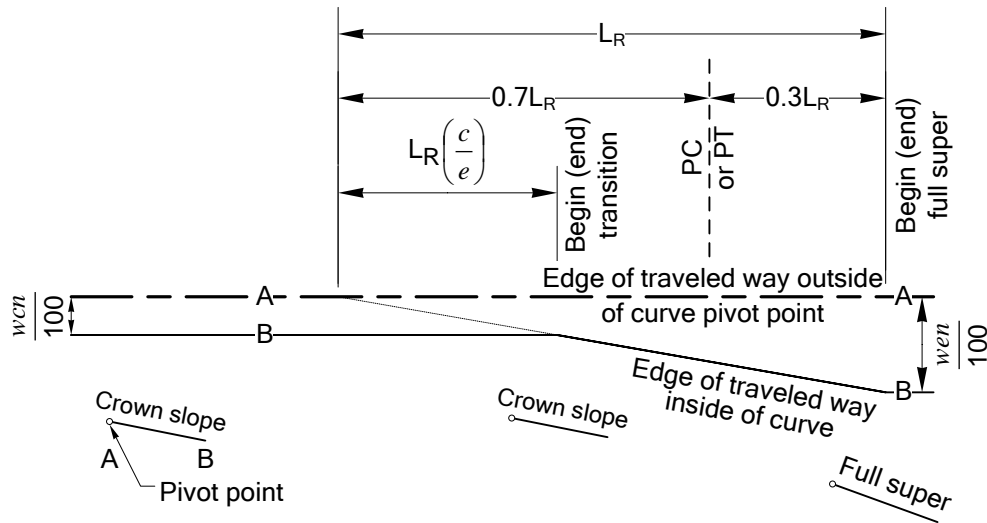

Design D¹ – Pivot Point on Edge of Traveled Way Curve in Direction of Normal Pavement Slope: Plane Section

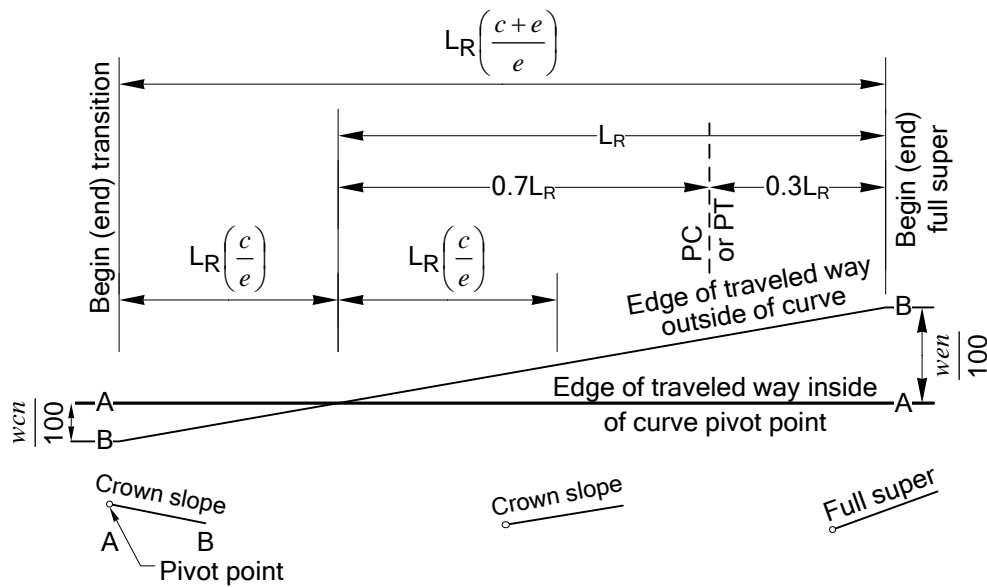

Design D² – Pivot Point on Edge of Traveled Way Curve Opposite to Normal Pavement Slope: Plane Section

- c = Normal crown (%)
- e = Superelevation rate (%)
- n = Number of lanes between points
- w = Width of lane

Exhibit 1250-6e Superelevation Transitions for Highway Curves

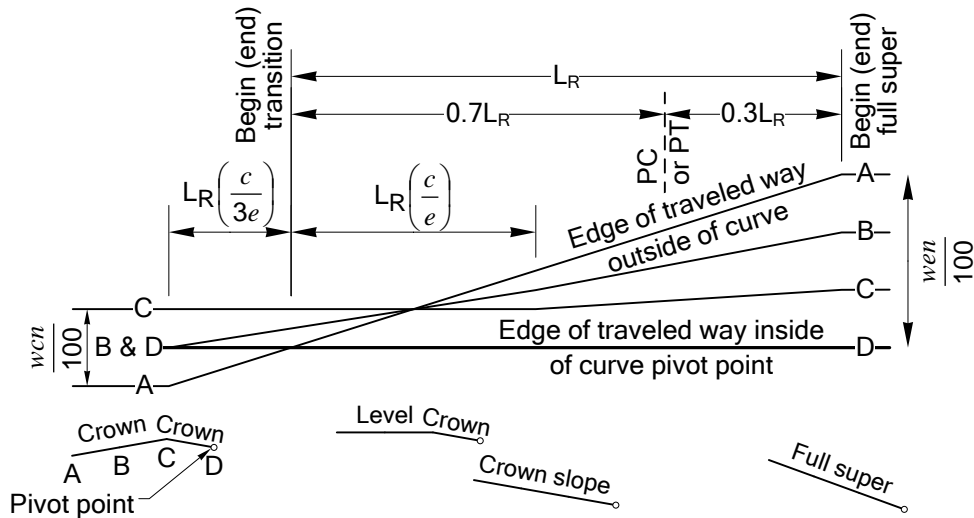

Design E¹ – Six-Lane With Median, Pivot Point on Edge of Traveled Way: Inside of Curve Crown Section

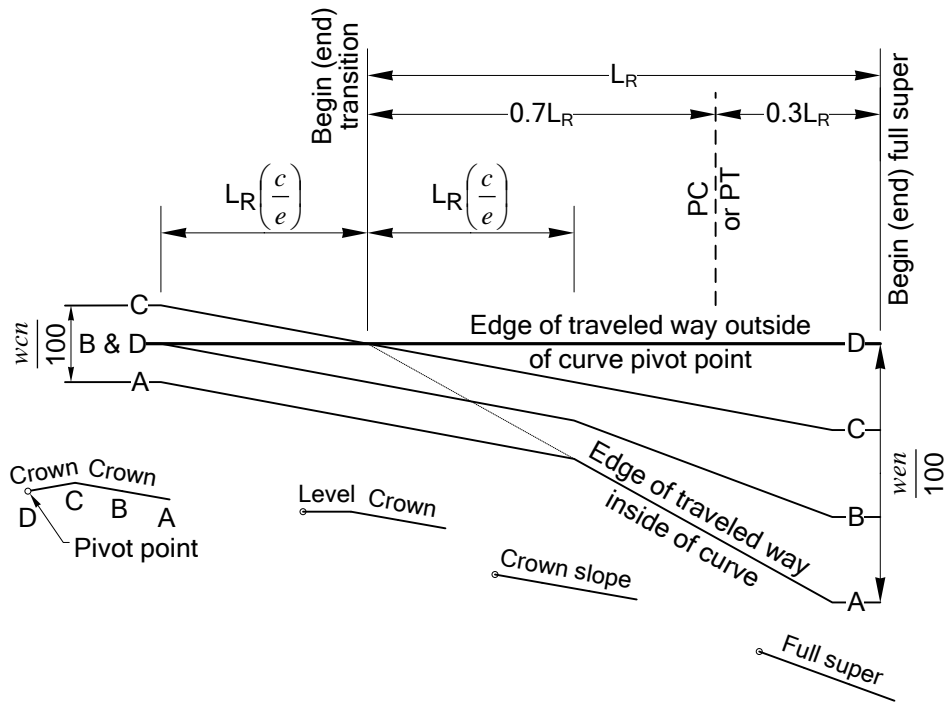

Design E² – Six-Lane With Median, Pivot Point on Edge of Traveled Way: Outside of Curve Crown Section

- c = Normal crown (%)
- e = Superelevation rate (%)
- n = Number of lanes between points
- w = Width of lane

Exhibit 1250-7a Superelevation Transitions for Ramp Curves

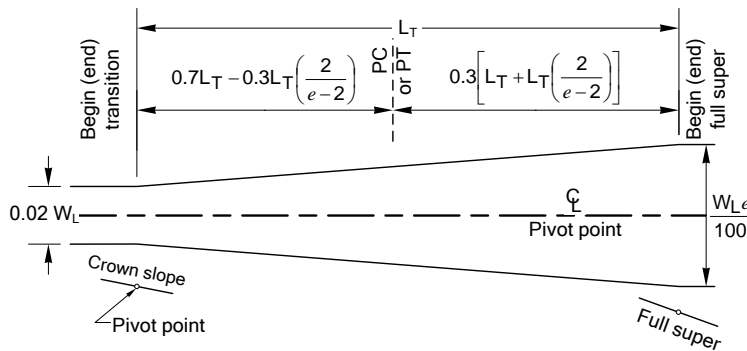

e (%)	Length of Transition in Feet for Design Speed							
	20 mph	25 mph	30 mph	35 mph	40 mph	45 mph	50 mph	55 mph
	L _T	L _T	L _T	L _T	L _T	L _T	L _T	L _T
3	10	15	15	15	15	15	15	15
4	20	25	25	25	25	30	30	35
5	30	35	35	35	40	45	45	50
6	40	45	45	50	55	55	60	65
7	50	55	55	60	65	70	75	80
8	60	65	70	75	80	85	90	95
9	70	75	80	85	95	100	105	110
10	80	85	90	100	105	115	120	130

Table 1 Pivot Point on Centerline: Curve in Direction of Normal Pavement Slope

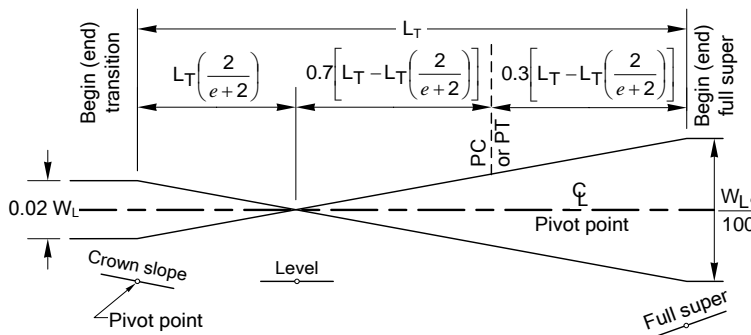

e (%)	Length of Transition in Feet for Design Speed							
	20 mph	25 mph	30 mph	35 mph	40 mph	45 mph	50 mph	55 mph
	L _T	L _T	L _T	L _T	L _T	L _T	L _T	L _T
2	40	40	45	50	55	55	60	65
3	50	55	55	60	65	70	75	80
4	60	65	70	75	80	85	90	95
5	70	75	80	85	90	100	105	110
6	80	85	90	95	105	115	120	130
7	90	95	100	110	120	125	135	145
8	100	105	115	120	130	140	150	160
9	110	120	125	135	145	155	165	175
10	120	130	135	145	160	170	180	190

Table 2 Pivot Point on Centerline: Curve in Direction Opposite to Normal Pavement Slope

W_L = Width of ramp lane

Exhibit 1250-7b Superelevation Transitions for Ramp Curves

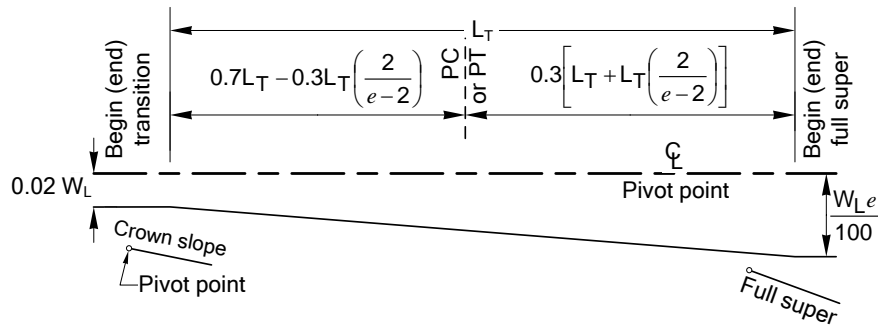

e (%)	Length of Transition in Feet for Design Speed							
	20 mph	25 mph	30 mph	35 mph	40 mph	45 mph	50 mph	55 mph
	L _T	L _T	L _T	L _T	L _T	L _T	L _T	L _T
3	20	25	25	25	25	30	30	35
4	40	45	45	50	55	55	60	65
5	60	65	70	75	80	85	90	95
6	80	85	90	100	105	115	120	130
7	100	105	115	120	130	140	150	160
8	120	130	135	145	160	170	180	190
9	140	150	160	170	185	195	210	225
10	160	170	180	195	210	225	240	255

Table 3 Pivot Point on Edge of Traveled Way: Curve in Direction of Normal Pavement Slope

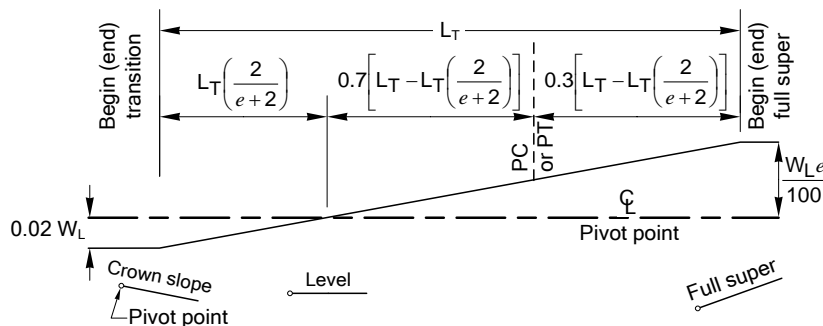

e (%)	Length of Transition in Feet for Design Speed							
	20 mph	25 mph	30 mph	35 mph	40 mph	45 mph	50 mph	55 mph
	L _T	L _T	L _T	L _T	L _T	L _T	L _T	L _T
2	80	85	90	100	105	115	120	130
3	100	105	115	120	130	140	150	160
4	120	130	135	145	160	170	180	190
5	140	150	160	170	185	195	210	225
6	160	170	180	195	210	225	240	255
7	180	190	205	220	235	255	270	290
8	200	210	225	245	265	280	300	320
9	220	235	250	265	290	310	330	350
10	240	255	270	290	315	340	360	385

Table 4 Pivot Point on Edge of Traveled Way: Curve in Direction Opposite to Normal Pavement Slope

W_L = Width of ramp lane

- 1260.01 General
- 1260.02 References
- 1260.03 Stopping Sight Distance (Eye height – 3.5 ft, Object height – 2.0 ft)
- 1260.04 Passing Sight Distance (Eye height – 3.5 ft, Object height – 3.5 ft)
- 1260.05 Decision Sight Distance (Eye height – 3.5 ft, Object height – 2.0 ft)
- 1260.06 Documentation

1260.01 General

Sight distance allows the driver to assess developing situations and take actions appropriate for the conditions. Sight distance relies on drivers being aware of and paying attention to their surroundings and driving appropriately for conditions presented. For the purposes of design, sight distance is considered in terms of stopping sight distance, passing sight distance, and decision sight distance.

For additional information, see the following chapters:

Chapter	Subject
1250	Sight distance at railroad crossings
1310	Sight distance at intersections at grade
1320	Sight distance at roundabouts
1340	Sight distance at driveways
1515	Sight distance for shared-use paths

1260.02 References

1260.02(1) Design Guidance

Manual on Uniform Traffic Control Devices for Streets and Highways, USDOT, FHWA; as adopted and modified by Chapter 468-95 WAC “Manual on uniform traffic control devices for streets and highways” (MUTCD)

1260.02(2) Supporting Information

A Policy on Geometric Design of Highways and Streets (Green Book), AASHTO

Passing Sight Distance Criteria, NCHRP 605

1260.03 Stopping Sight Distance (Eye height – 3.5 ft, Object height – 2.0 ft)

1260.03(1) Design Criteria

Stopping sight distance is provided when the sight distance available to a driver equals or exceeds the stopping distance for a passenger car traveling at the design speed.

Stopping distance for design is very conservatively calculated, with lower deceleration and slower perception reaction time than normally expected from the driver. Provide design stopping sight distance at all points on all highways and on all intersecting roadways, unless a design deviation is deemed appropriate.

1260.03(1)(a) Stopping Sight Distance

Stopping sight distance is the sum of two distances: the distance traveled during perception and reaction time and the distance to stop the vehicle. The perception and reaction distance used in design is the distance traveled in 2.5 seconds at the design speed.

The design stopping sight distance is calculated using the design speed and a constant deceleration rate of 11.2 feet/second². For stopping sight distances on grades less than 3%, see [Exhibit 1260-1](#); for grades 3% or greater, see [Exhibit 1260-2](#).

**1260.03(1)(b) Design Stopping Sight Distance**

[Exhibit 1260-1](#) gives the design stopping sight distances for grades less than 3%, the minimum curve length for a 1% grade change to provide the stopping sight distance for a crest (K_c) and sag (K_s) vertical curve, and the minimum length of vertical curve for the design speed (VCL_m). For stopping sight distances when the grade is 3% or greater, see [Exhibit 1260-2](#).

Design Speed (mph)	Design Stopping Sight Distance (ft)	K_c	K_s	VCL_m (ft)
25	155	<u>12</u>	<u>26</u>	75
30	200	<u>19</u>	<u>37</u>	90
35	250	<u>29</u>	49	105
40	305	<u>44</u>	<u>64</u>	120
45	360	<u>61</u>	<u>79</u>	135
50	425	<u>84</u>	96	150
55	495	<u>114</u>	115	165
60	570	<u>151</u>	136	180
65	645	<u>193</u>	157	195
70	730	<u>247</u>	<u>181</u>	210
75	820	<u>312</u>	206	225
80	910	<u>384</u>	231	240

Design Stopping Sight Distance
Exhibit 1260-1

1201.01	General	1270.06	Emergency Escape Ramps
1270.02	Climbing Lanes	1270.07	Chain-Up and Chain-Off Areas
1270.03	Passing Lanes	1270.08	Documentation
1270.04	Slow-Moving Vehicle Turnouts	1270.09	References
1270.05	Shoulder Driving for Slow Vehicles		

1270.01 General

Auxiliary lanes are used to comply with capacity demand; maintain lane balance; accommodate speed change, weaving, and maneuvering for entering and exiting traffic; and encourage carpools, vanpools, and the use of transit.

For signing and delineation of auxiliary lanes, see the *Standard Plans*, the *Traffic Manual*, and the *MUTCD*. Contact the region Traffic Engineer for guidance.

Although slow-vehicle turnouts, shoulder driving for slow vehicles, and chain-up areas are not auxiliary lanes, they are covered in this chapter because they perform a similar function.

For additional information, see the following chapters:

Chapter	Subject
1103	<u>Design controls, including speed</u>
1230	<u>Lane and shoulder dimensions</u>
1310	Turn lanes
1310	Speed change lanes at intersections
1360	Speed change lanes at interchanges
1360	Collector-distributor roads
1360	Weaving lanes
1410	High-occupancy vehicle lanes

1270.02 Climbing Lanes

Exhibit 1270-1 Climbing Lane Example



1270.02(1) General

Climbing lanes (see [Exhibit 1270-1](#)) are normally associated with truck traffic, but they may also be considered in recreational or other areas that are subject to slow-moving traffic. Climbing lanes are designed independently for each direction of travel.

1270.02(2) Climbing Lane Warrants

Generally, climbing lanes are provided when two warrants—speed reduction and level of service—are exceeded. Either warrant may be waived if, for example, slow-moving traffic is causing an identified collision trend or congestion that could be corrected by the addition of a climbing lane. However, under most conditions, climbing lanes are built when both warrants are satisfied.

1270.02(2)(a) Warrant No. 1: Speed Reduction

[Exhibit 1270-2a](#) shows how the percent and length of grade affect vehicle speeds. The data are based on a typical truck.

The maximum entrance speed, shown in the graphs, is 60 mph. This is the maximum value regardless of the posted speed of the highway. When the posted speed is above 60 mph, use 60 mph in place of the posted speed. Examine the profile at least $\frac{1}{4}$ mile preceding the grade to obtain a reasonable approach speed.

If a vertical curve makes up part of the length of grade, approximate the equivalent uniform grade length.

Whenever the gradient causes a 10 mph speed reduction below the posted speed limit for a typical truck for either two-lane or multilane highways, the speed reduction warrant is satisfied (see [Exhibit 1270-2b](#)).

1270.02(2)(b) Warrant No. 2: Level of Service (LOS)

The level of service warrant for two-lane highways is fulfilled when the upgrade traffic volume exceeds 200 vehicles per hour and the upgrade truck volume exceeds 20 vehicles per hour. On multilane highways, a climbing lane is warranted when a capacity analysis shows the need for more lanes on an upgrade than on a downgrade carrying the same traffic volume.

1270.02(3) Climbing Lane Design

When a climbing lane is justified, design it in accordance with [Exhibit 1270-3](#). Provide signing and delineation to identify the presence of the auxiliary lane. Begin climbing lanes at the point where the speed reduction warrant is met and end them where the warrant ends for multilane highways and 300 feet beyond for two-lane highways. Consider extending the auxiliary lane over the crest to improve vehicle acceleration and sight distance.

Design climbing lane width equal to that of the adjoining through lane and at the same cross slope as the adjoining lanes. Whenever possible, maintain the shoulder width. However, on two-way two-lane highways, the shoulder may be reduced to 4 feet unless determined otherwise for safety performance needs or specific shoulder functions (see [Chapter 1230](#)). Document changed or employed design elements using the Basis of Design and design parameters worksheets (see [Chapters 1105](#) and [1106](#)).

For signing of climbing lanes, see the [Standard Plans](#), the [Traffic Manual](#), and the [MUTCD](#).

Exhibit 1270-2a Speed Reduction Warrant: Performance for Trucks

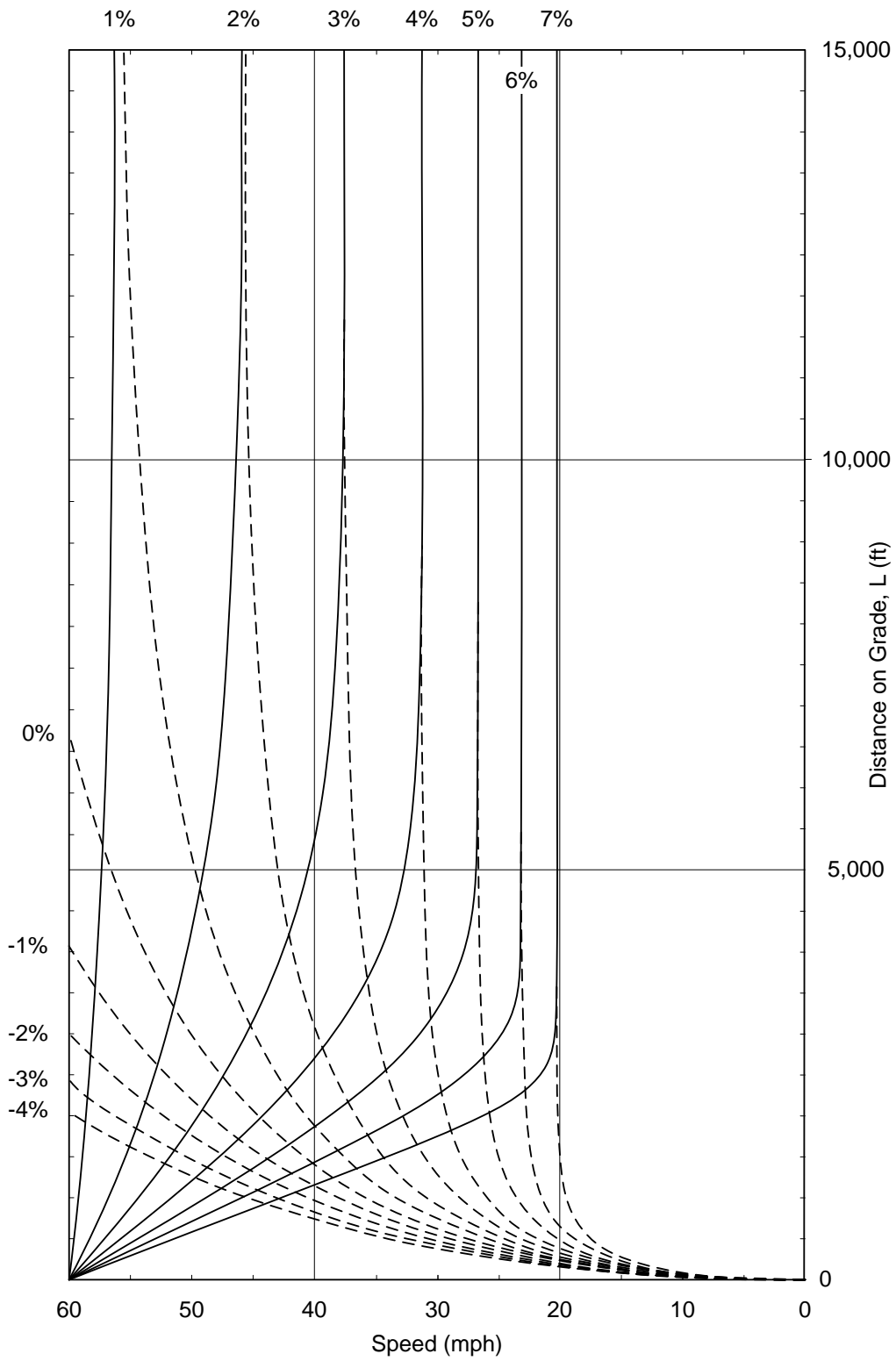
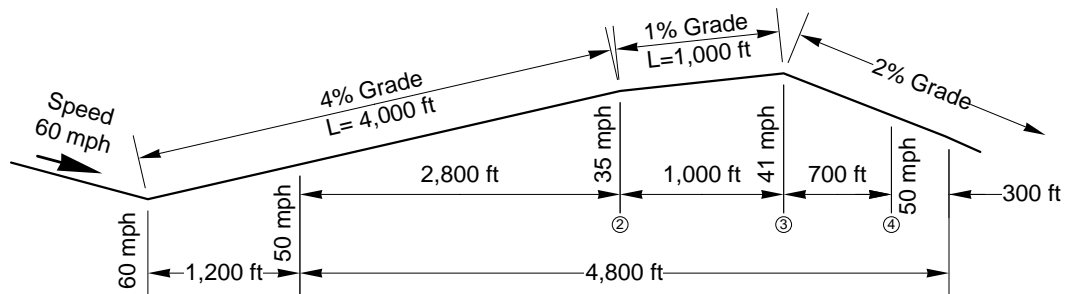
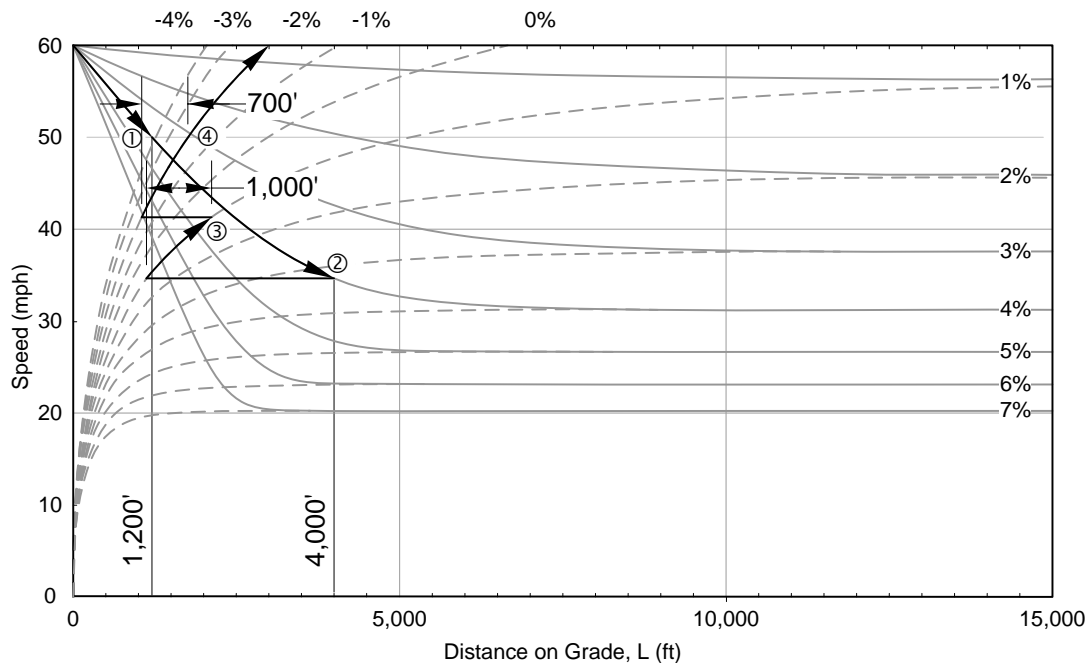

Exhibit 1270-2b Speed Reduction Warrant Example



Given:

A two-lane highway meeting the level of service warrant, with the above profile, and a 60 mph posted speed.

Determine:

Is the climbing lane warranted? If so, what is its length?

Solution:

1. Follow the 4% grade deceleration curve from a speed of 60 mph to a speed of 50 mph at 1,200 ft. The speed reduction warrant is met and a climbing lane is needed.
2. Continue on the 4% grade deceleration curve to 4,000 ft. Note that the speed at the end of the 4% grade is 35 mph.
3. Follow the 1% grade acceleration curve from a speed of 35 mph for 1,000 ft. Note that the speed at the end of the 1% grade is 41 mph.
4. Follow the -2% grade acceleration curve from a speed of 41 mph to a speed of 50 mph, ending the speed reduction warrant. Note that the distance is 700 ft.
5. The total auxiliary lane length is $(4,000-1,200)+1,000+700+300=4,800$ feet. 300 ft is added to the speed reduction warrant for a two-lane highway (see 1270.02(3) and Exhibit 1270-3).

Exhibit 1270-3 Auxiliary Climbing Lane

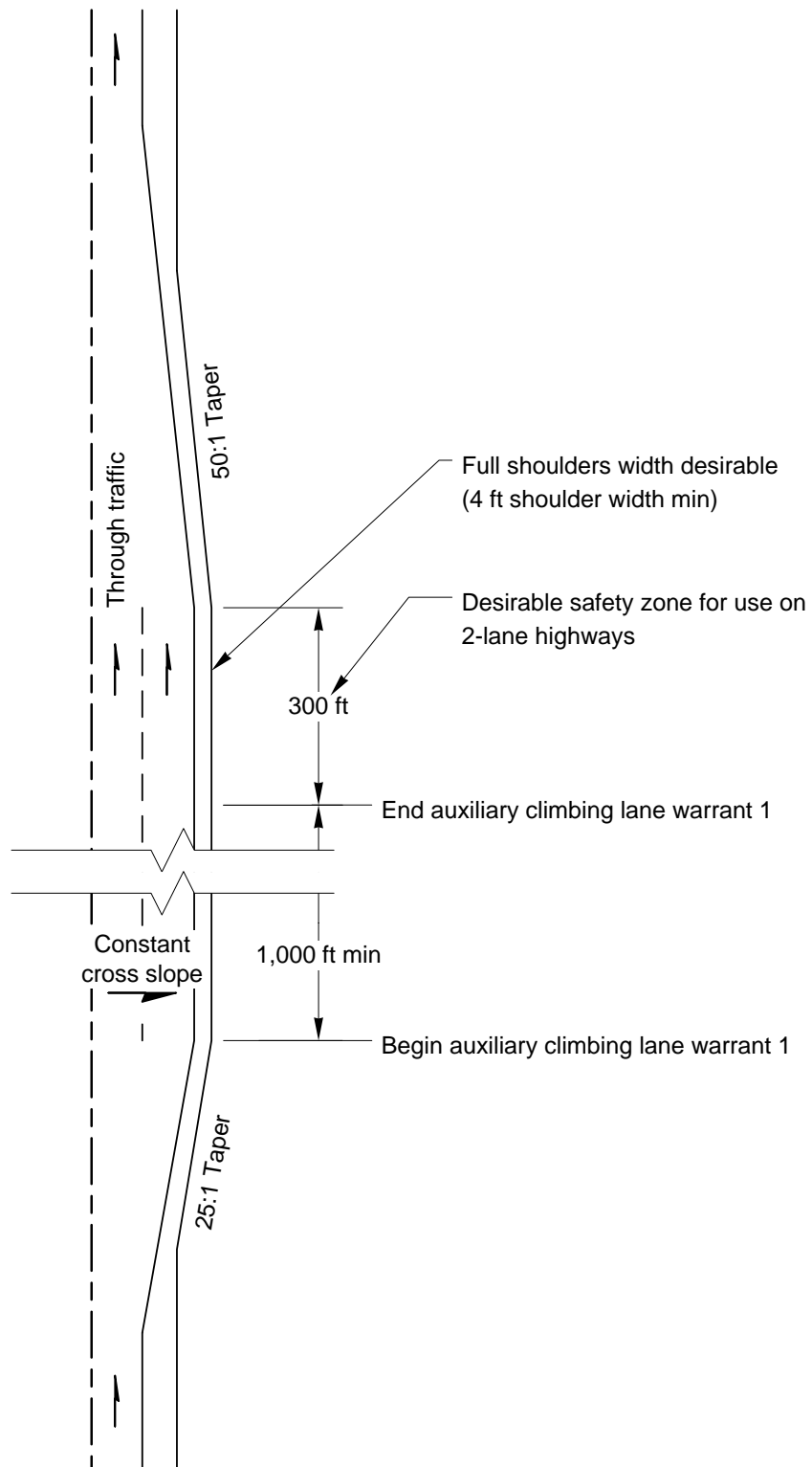

1270.03 Passing Lanes

Exhibit 1270-4 Passing Lane Example



1270.03(1) Passing Lane Benefits

A passing lane (see [Exhibit 1270-4](#)) is an auxiliary lane provided in one or both directions of travel on a two-lane highway to improve passing opportunities. They may be intermittent or continuous passing lanes in level or rolling terrain and short four-lane sections. The objectives of passing lanes are to:

- Improve overall traffic operations on two-lane highways by breaking up traffic platoons and reducing delays caused by inadequate passing opportunities over substantial lengths of highway.
- Increase average travel speed within the passing lane itself; the speed benefits of passing lanes continue downstream of the lane. Passing lanes typically reduce the percent time spent following within the passing lane itself. These “percent time spent following” benefits can continue for some distance downstream of the passing lane.
- Improve safety by providing assured passing opportunities without the need for the passing driver to use the opposing traffic lane. Safety evaluations have shown that passing lanes and short four-lane sections reduce collision rates and severity.

1270.03(2) Passing Lane Length

Design passing lanes long enough to provide a reduction in traffic platooning. To maximize the traffic operational efficiency of a passing lane in level or rolling terrain, its length can vary from 0.5 mile to 2.0 miles depending on the directional flow rate, as shown in [Exhibit 1270-5](#). Passing lanes longer than 2 miles can cause the driver to lose the sense that the highway is a two-lane facility. However, these lengths may vary for other reasons such as addressing safety-related issues. Passing lanes longer than 2.0 miles or shorter than 0.5 miles in length may be used depending on the identified need or other operational considerations within the design. Lengths shown do not include passing lane tapers at the beginning or end of the passing lane.

Exhibit 1270-5 Length of Passing Lanes

Directional Flow Rate (pc/h)	Passing Lane Length (mi)
100	≤0.50
200	>0.50-0.75
400	>0.75-1.00
≥700	>1.00-2.00

Source: Transportation Research Board, *Highway Capacity Manual*, 2000

For assistance in developing a passing lane length, see the following website for an example of a self-modeling spreadsheet. This spreadsheet develops passing lane lengths based primarily on vehicle speed differentials and is to be used in conjunction with traffic modeling efforts. Contact the Headquarters Design Office for assistance (www.wsdot.wa.gov/design/policy/default.htm).

1270.03(3) Passing Lane Location

A number of factors are considered when selecting an appropriate location for a passing lane, including the following:

- Locate passing lanes where decision sight distance (see [Chapter 1260](#)) at the approach to lane increase and lane decrease tapers can be provided.
- Avoid locating passing lanes near high-volume intersections, existing structures, railroad crossings, areas of dense development, and two-way left-turn lanes.
- Locate passing lanes where they appear logical to the driver.
- Carefully consider highway sections with low-speed curves (curves with superelevation less than required for the design speed) before installing a passing lane, since they may not be suitable for passing. For information on superelevation, see [Chapter 1250](#).
- Avoid other physical constraints, such as bridges and culverts, if they restrict the provision of a continuous shoulder.
- Consider the number, type, and location of intersections and road approaches.
- Consider grades when choosing the side on which to install the passing lane. Uphill grades are preferred but not mandatory.
- Preference for passing is normally given to the traffic departing a developed area such as a small town.

1270.03(3)(a) Traffic Operational Considerations

When passing lanes are provided at an isolated location, their typical objective is to reduce delays at a specific bottleneck; for example, climbing lanes (see [1270.02](#)). The location of the passing lane is dictated by the needs of the specific traffic operational problem encountered.

When passing lanes are provided to improve traffic operations over a length of road, there is flexibility in the choice of passing lane locations to maximize their operational effectiveness and minimize construction costs.

If delay problems on an upgrade are severe, the upgrade will usually be the preferred location for a passing lane.

Passing lanes at upgrades begin before speeds are reduced to unacceptable levels and, where possible, continue over the crest of the grade so that slower vehicles can regain some speed before merging.

1270.03(3)(b) Construction Cost Considerations

The cost of constructing a passing lane can vary substantially, depending on terrain, highway structures, shoulders, and adjacent development. Thus, the choice of a suitable location for a passing lane may be critical to its cost-effectiveness.

Generally, passing lanes in level and rolling terrain can be placed where they are least expensive to construct, avoiding locations with high cuts and fills and existing structures that would be expensive to widen.

1270.03(3)(c) Intersection-Related Considerations

Consider a corridor evaluation of potential passing lane locations for each direction, avoiding placement of passing lanes near intersections. Avoid or minimize turning movements on a road section where passing is encouraged.

Low-volume intersections and driveways are allowed within passing lanes, but not within the taper transition areas.

Where the presence of higher-volume intersections and driveways cannot be avoided, consider including provisions for turning vehicles, such as left-turn lanes.

Provide right- and left-turn lanes in passing lane sections where they would be provided on a conventional two-lane highway.

Left turns within the first 1,000 feet of a passing lane are undesirable. Strategies to address the turning movement could include left-turn lanes, right-in/right-out access, beginning the passing lane after the entrance, and so on.

1270.03(4) Passing Lane Design

Where a passing lane is planned, evaluate several possible configurations (see [1270.03\(4\)\(a\)](#)) that are consistent with the corridor and fit within the constraints of the specific location.

The recommended minimum transition distance between passing lanes in opposing directions is 500 feet for “tail-to-tail” and 1,500 feet for “head-to-head” (see [Exhibit 1270-7](#)).

Lane and shoulder widths for passing lanes are to be consistent with adjacent sections of two-lane highway unless reduced widths are determined from application of quantitative methods. (See Chapters [1106](#) and [1230](#) for lane and shoulder dimensions.)

Some separation between lanes in opposite directions of travel is desirable; however, passing lanes can operate effectively with no separation. In either situation, address pavement markings and centerline rumble strips as appropriate.

It is desirable to channelize the beginning of a passing lane to move traffic to the right lane in order to promote prompt usage of the right lane by platoon leaders and maximize passing lane efficiency.

For signing and striping of passing lanes, contact the region Traffic Engineer.

Widening symmetrically to maintain the roadway crown at the centerline is preferred, including in continuous passing lane configurations. However, the roadway crown may be placed in other locations as deemed appropriate.

1270.03(4)(a) Alternative Configurations

Where a passing lane will be provided, evaluate the configurations shown in [Exhibit 1270-6](#). In [the exhibit](#), general passing lane configurations and their typical applications are described in the following:

a. Isolated Passing Lane – Exhibit 1270-6 (a)

- Two-lane highway with passing lane provided at a spot location to dissipate queues.
- For isolated grades, consider climbing lanes (see [1270.02](#)).

b. Intermittent Passing Lanes, Separated – Exhibit 1270-6 (b)

- Often pairs are used at regular intervals along a two-lane highway.
- Frequency of passing lanes depends on desired level of service.
- The spacing between passing lanes and between pairs may be adjusted to fit the conditions along the route (see [1270.03\(3\)](#)).

c. Continuous Passing Lanes – Exhibit 1270-6 (c)

- Use only when constraints do not allow for the use of other configurations. The use of this configuration requires concurrence from the region traffic engineer. (See [Exhibit 1270-7](#) for additional information regarding buffer areas.)
- Appropriate for two-lane roadways carrying relatively high traffic volumes where nearly continuous passing lanes are needed to achieve the desired level of service.
- Particularly appropriate over an extended section of roadway where a wide pavement is already available.
- May be used as an interim stage for an ultimate four-lane highway.

d. Short Four-Lane Section – Exhibit 1270-6 (d)

- Sufficient length for adjoining passing lanes is not available.
- Particularly appropriate where the ultimate design for the highway is four lanes.

e. Intermittent Three-Lane Passing Lanes – Exhibit 1270-6 (e)

- Does not require the slow vehicle to change lanes to allow passing.
- Requires the widening to transition from one side of the existing roadway to the other.
- Eliminates the head-to-head tapers.

1270.03(4)(b) Geometric Aspects

Carefully design transitions between passing lanes in opposing directions. Intersections, bridges, other structures, two-way left-turn lanes, painted medians, or similar elements can be used to provide a buffer area between opposing passing lanes. The length of the buffer area between adjoining passing lanes depends on the configuration (see [Exhibit 1270-7](#)).

[Exhibit 1270-6 \(c\)](#) illustrates a continuous three-lane section with alternating passing lanes. Consider a four-lane cross section when volume demand exceeds the capacity of a continuous three-lane roadway.

Provide shoulder width in a passing lane section equal to the shoulder width on the adjacent sections of a two-lane highway. However, the shoulder may be reduced to 4 feet when shoulder rumble strips are present or as determined from quantitative methods (see [Chapter 1106](#)). Lane widths of 12 feet are preferable throughout the length of the passing lane. The minimum lane width is to be the same as the lane width on the adjacent sections of two-lane highway.

Provide a 25:1 or flatter taper rate to increase the width for a passing lane. When all traffic is directed to the right lane at the beginning of the passing lane, provide a taper rate of the posted speed:1. Provide a posted speed:1 taper rate for the merging taper at the end of a passing lane. (Refer to the Lane Transitions section in [Chapter 1210](#) for additional information on taper rates.) Consider a wide shoulder at the lane drop taper to provide a recovery area for drivers who encounter a merging conflict. Provide decision sight distance (see [Chapter 1260](#)) at the approach to lane increase and lane decrease tapers.

Provide signing and delineation to identify the presence of an auxiliary passing lane. Refer to the [Standard Plans](#), the [Traffic Manual](#), and the [MUTCD](#) for passing lane signing and marking guidance.

Exhibit 1270-6 Passing Lane Configurations

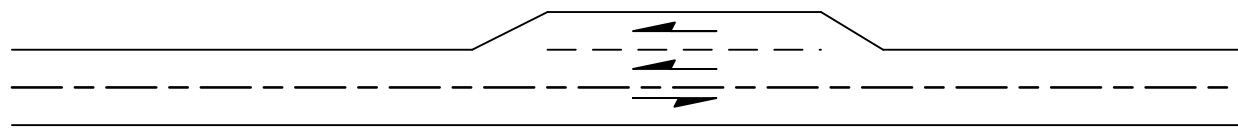

(a) Isolated Passing Lane

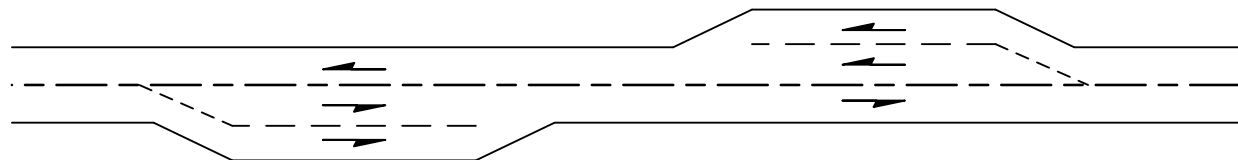

(b) Intermittent Passing Lane

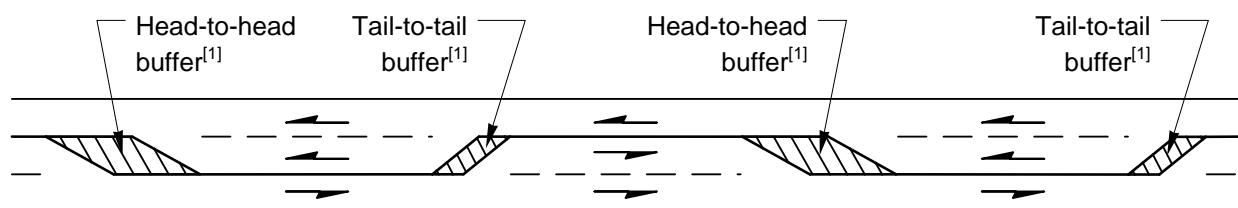

(c) Continuous Three-Lane Section

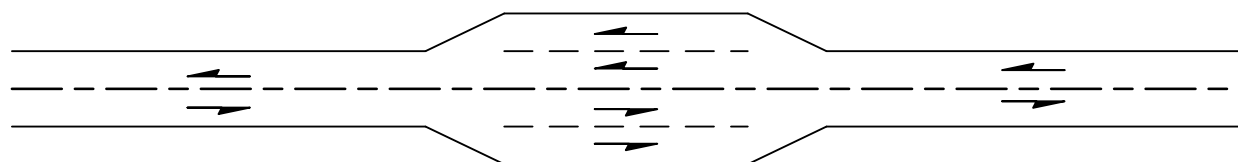

(d) Short Four-Lane Section

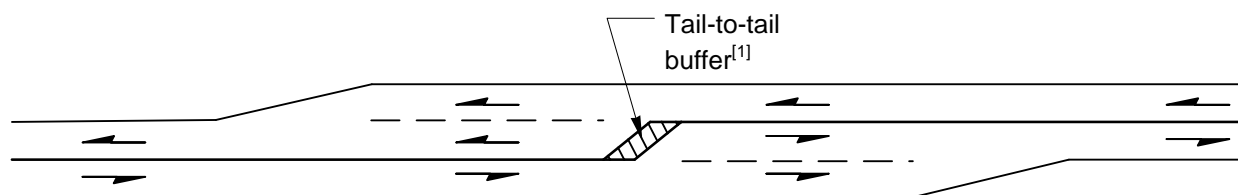

(e) Intermittent Three-Lane Passing Lanes

Note:

[1] See [Exhibit 1270-7](#) for buffer design.

Exhibit 1270-7 Buffer Between Opposing Passing Lanes

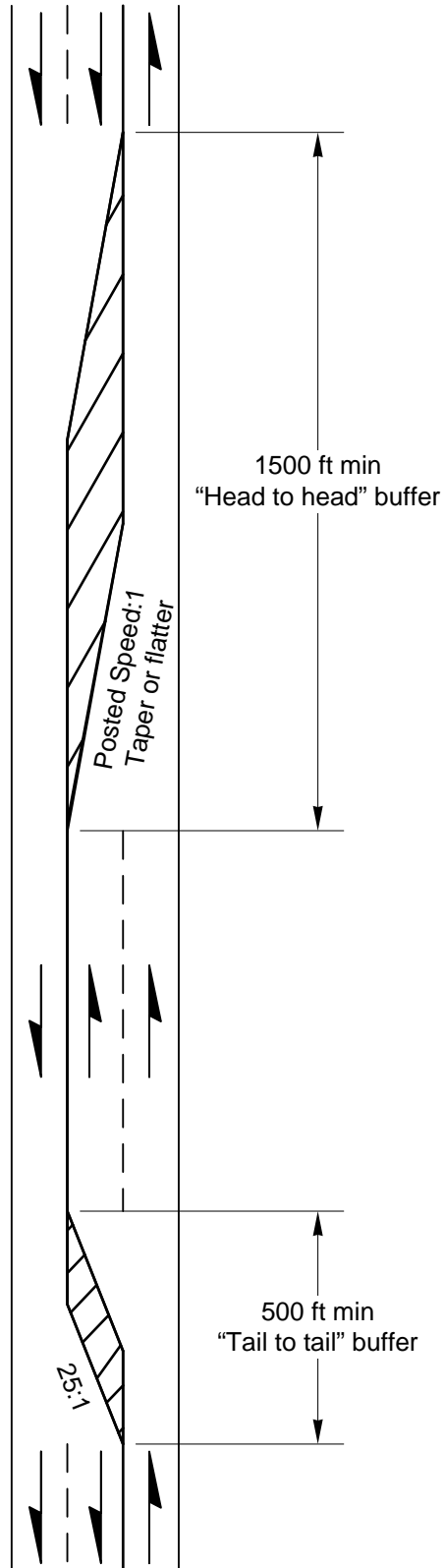
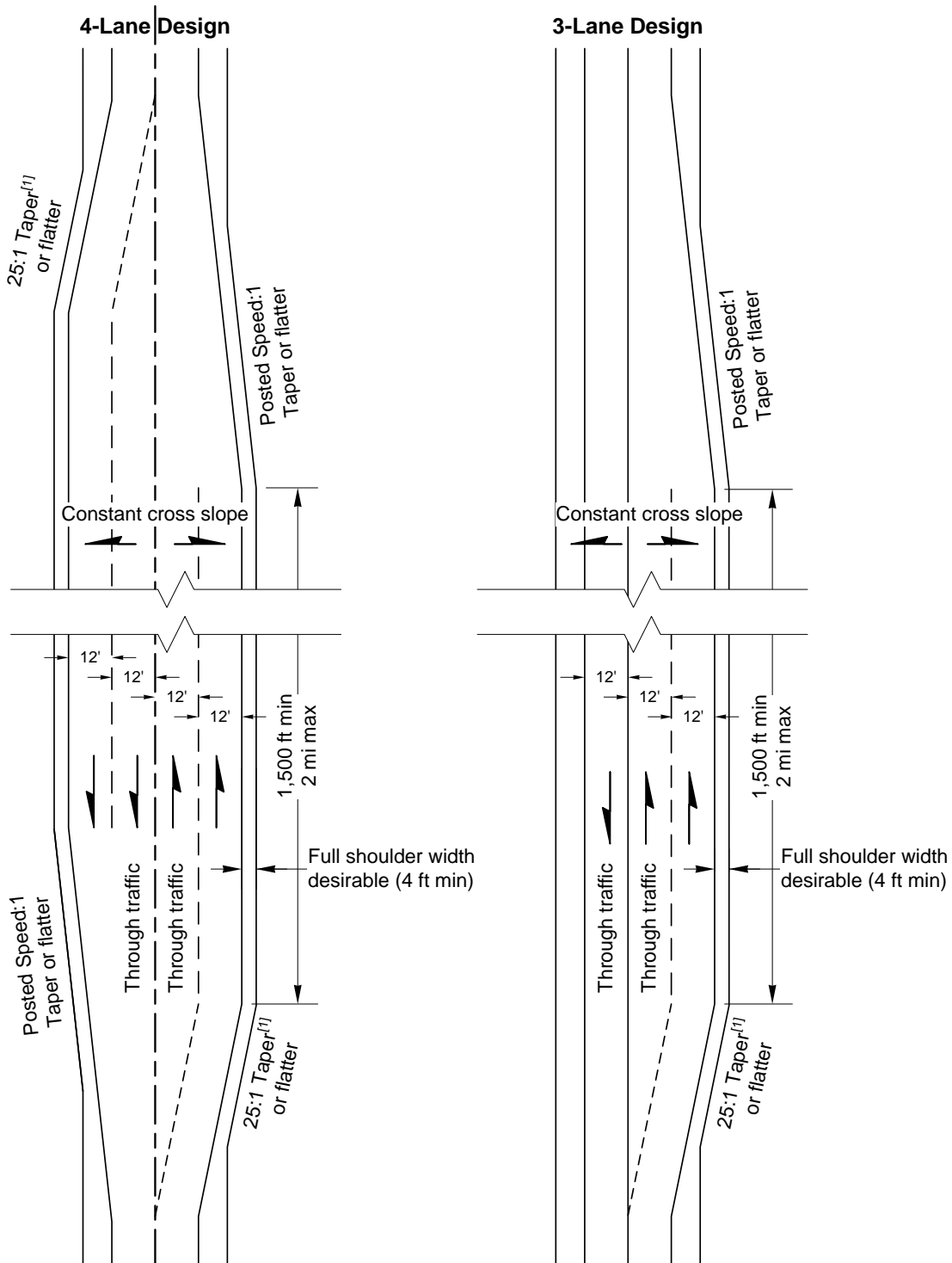

Exhibit 1270-8 Auxiliary Passing Lane



Note:

- [1] Provide a posted speed:1 taper when all traffic is directed to the right lane at the beginning of the passing lane.
- [2] Lane widths may vary as determined by design element dimensioning method (see [Chapter 1106](#)).

1270.04 Slow-Moving Vehicle Turnouts

1270.04(1) General

RCW 46.61.427 states:

On a two-lane highway where passing is unsafe ... a slow-moving vehicle, behind which five or more vehicles are formed in a line, shall turn off the roadway wherever sufficient area for a safe turn-out exists, in order to permit the vehicles following to proceed...

A slow-moving vehicle turnout is not an auxiliary lane. Its purpose is to provide sufficient room for a slow-moving vehicle to pull out of through traffic and stop if necessary, allow vehicles to pass, and then return to the through lane. Generally, a slow-moving vehicle turnout is provided on existing roadways where passing opportunities are limited, where slow-moving vehicles such as trucks and recreational vehicles are predominant, and where the cost to provide a full auxiliary lane would be prohibitive.

1270.04(2) Design

Base the design of a slow-moving vehicle turnout primarily on sound engineering judgment. Designs may vary from one location to another. Provide a length between 100 and 1,320 feet, excluding tapers. Select a width adequate for the vehicle type expected to use the turn-out, between 8 to 12 feet in width. Surface the turnouts with a stable, unyielding material (such as BST or HMA) with adequate structural strength to support the heavier traffic.

To improve the ability of a vehicle to safely reenter through traffic, locate slow-moving vehicle turnouts where decision sight distance (see [Chapter 1260](#)) is available. The minimum design range for slow-vehicle turnouts may be where at least design stopping sight distance is available.

Sign slow-moving vehicle turnouts to identify their presence. For guidance, see the [Standard Plans](#), the [Traffic Manual](#), and the [MUTCD](#).

1270.05 Shoulder Driving for Slow Vehicles

1270.05(1) General

Use of a shoulder driving section is an alternative means to meet the performance objectives provided by climbing or passing lanes.

Review the following when considering a shoulder driving section:

- Horizontal and vertical alignment
- Character of traffic
- Presence of bicycles
- Road approaches and intersections
- Clear zone (see [Chapter 1600](#))

1270.05(2) Design

When designing a shoulder for shoulder driving, locate where full design stopping sight distance (speed/path/direction decision sight distance is desirable) and a minimum length of 600 feet are available. Where practicable, avoid sharp horizontal curves. When barriers or other roadside objects are present, the minimum width is 12 feet. The shoulder width depends on the vehicles that will be using the shoulder. Where trucks will be the primary vehicle using the shoulder, use a 12-foot width; when passenger cars are the primary vehicle, a 10-foot width may be used.

Shoulder driving and bicycles are not compatible. When the route has been identified as a local, state, or regional significant bike route, shoulder driving for slow vehicles is undesirable. Reconstruct the shoulders to provide adequate structural strength for the anticipated traffic. Select locations where the side slope meets the criteria of [Chapter 1230](#). When providing a transition at the end of a shoulder driving section, use a 50:1 taper.

Signing for shoulder driving is required (see the [Standard Plans](#), the [Traffic Manual](#), and the [MUTCD](#)). Install guideposts when shoulder driving is to be permitted at night.

1270.06 Emergency Escape Ramps

1270.06(1) General

Consider an emergency escape ramp (see [Exhibit 1270-9](#)) whenever a long, steep downgrade is encountered. In this situation, the possibility exists of a truck losing its brakes and going out of control at a high speed. Consult local maintenance personnel and check traffic accident records to determine whether or not an escape ramp is justified.

Exhibit 1270-9 Emergency Escape Ramp Example



1270.06(2) Design

1270.06(2)(a) Types

Escape ramps include the following types:

- Gravity escape ramps are ascending grade ramps paralleling the traveled way. They are commonly built on old roadways. Their long length and steep grade can present the driver with control problems, not only in stopping, but with rollback after stopping. Gravity escape ramps are the least desirable design.
- Sand pile escape ramps are piles of loose, dry sand dumped at the ramp site, usually not more than 400 feet in length. The deceleration is usually high and the sand can be affected by weather conditions; therefore, they are less desirable than arrester beds. However, where space is limited, they may be suitable.
- Arrester beds are parallel ramps filled with smooth, free-draining gravel. They stop the out-of-control vehicle by increasing the rolling resistance and are the most desirable design. Arrester beds are commonly built on an upgrade to add the benefit of gravity to the rolling resistance. However, successful arrester beds have been built on a level or descending grade.
- The Dagnet Vehicle Arresting Barrier consists of chain link or fiber net that is attached to energy-absorbing units. (See [Chapter 1610](#) for additional information.)

1270.06(2)(b) Locations

The location of an escape ramp depends on terrain, length of grade, and roadway geometrics. Desirable locations include before a critical curve, near the bottom of a grade, or before a stop. It is desirable that the ramp leave the roadway on a tangent at least 3 miles from the beginning of the downgrade.

1270.06(2)(c) Lengths

The length of an escape ramp depends on speed, grade, and type of design used. The minimum length is 200 feet. Calculate the stopping length using the equation in [Exhibit 1270-10](#).

Exhibit 1270-10 Emergency Escape Ramp Length

$L = \frac{V^2}{0.3(R \pm G)}$
<p>Where:</p> <p>L = Stopping distance (ft)</p> <p>V = Entering speed (mph)</p> <p>R = Rolling resistance (see Exhibit 1270-11)</p> <p>G = Grade of the escape ramp (%)</p>

Speeds of out-of-control trucks rarely exceed 90 mph; therefore, the desirable entering speed is 90 mph. Other entry speeds may be used when justification and the method used to determine the speed are documented.

Exhibit 1270-11 Rolling Resistance (R)

Material	R
Roadway	1
Loose crushed aggregate	5
Loose noncrushed gravel	10
Sand	15
Pea gravel	25

1270.06(2)(d) Widths

The width of each escape ramp depends on the needs of the individual situation. It is desirable for the ramp to be wide enough to accommodate more than one vehicle. The *desirable* width of an escape ramp to accommodate two out-of-control vehicles is 40 feet and the *minimum* width is 26 feet.

The following items are additional considerations in the design of emergency escape ramps:

- If possible, at or near the summit, provide a pull-off brake check area. Also, include in this area informative signing about the upcoming escape ramp.
- Free-draining, smooth, noncrushed gravel is desirable for an arrester bed. To assist in smooth deceleration of the vehicle, taper the depth of the bed from 3 inches at the entry to a full depth of 18 to 30 inches in not less than 100 feet.
- Mark and sign in advance of the ramp. Discourage normal traffic from using or parking in the ramp. Sign escape ramps in accordance with the guidance contained in the [MUTCD](#) for runaway truck ramps.
- Provide drainage adequate to prevent the bed from freezing or compacting.
- Consider including an impact attenuator at the end of the ramp if space is limited.
- A surfaced service road adjacent to the arrester bed is needed for wreckers and maintenance vehicles to remove vehicles and make repairs to the arrester bed. Anchors are desirable at 300-foot intervals to secure the wrecker when removing vehicles from the bed.

Typical examples of arrester beds are shown in Exhibits [1270-9](#) and [1270-12](#).

Include justification, all calculations, and any other design considerations in the emergency escape ramp documentation.

Exhibit 1270-12 Typical Emergency Escape Ramp

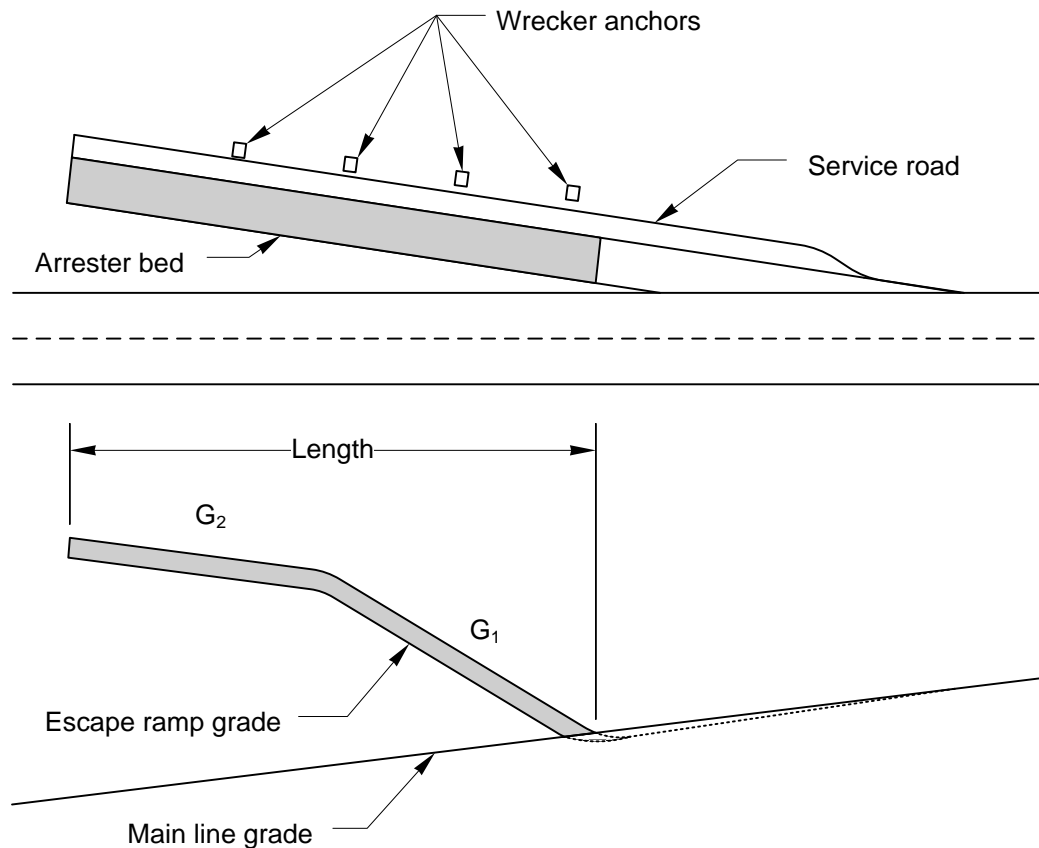

1270.07 Chain-Up and Chain-Off Areas

Provide chain-up areas to allow chains to be put on vehicles out of the through lanes at locations where traffic enters chain enforcement areas. Provide chain-off areas to remove chains out of the through lanes for traffic leaving chain enforcement areas.

Chain-up or chain-off areas are widened shoulders, designed as shown in [Exhibit 1270-13](#). Locate chain-up and chain-off areas where the grade is 6% or less and desirably on a tangent section.

Consider illumination for chain-up and chain-off areas on multilane highways. When deciding whether or not to install illumination, consider traffic volumes during the hours of darkness and the availability of power.

The wide shoulders at chain-up and chain-off areas may encourage parking. When parking is undesirable, consider parking restrictions.

Exhibit 1270-13 Chain-Up/Chain-Off Area

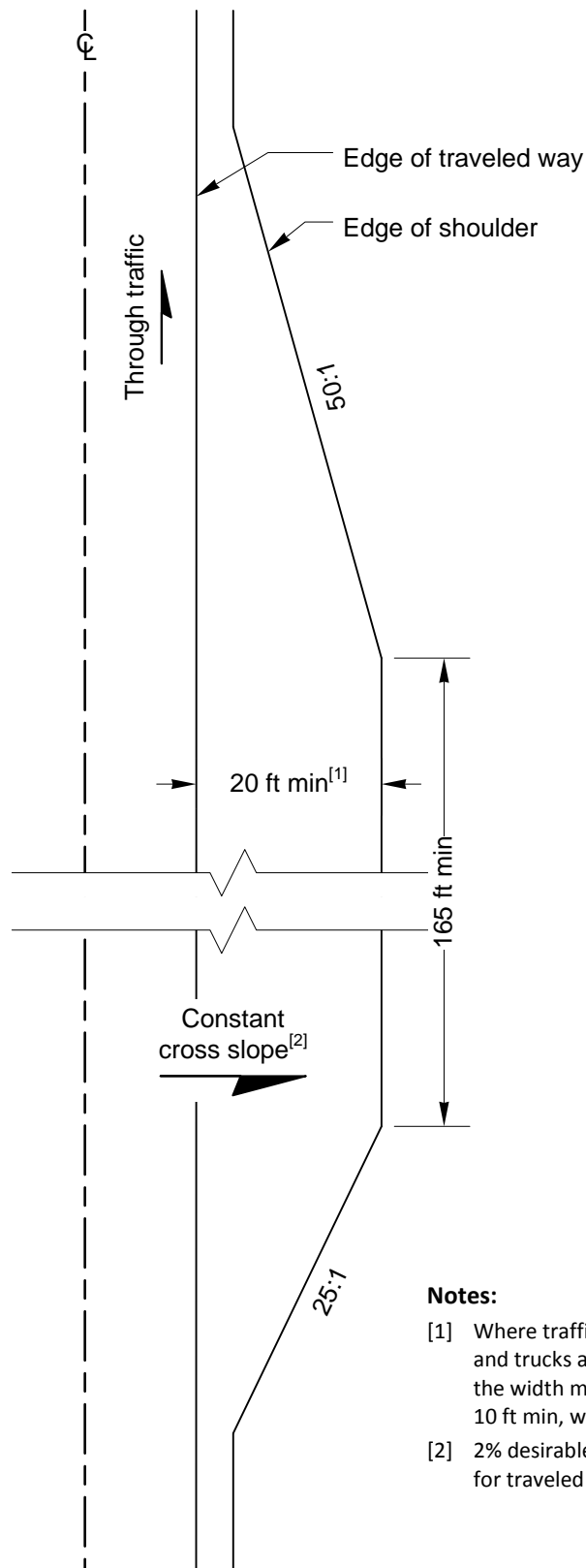
**Notes:**

- [1] Where traffic volumes are low and trucks are not a concern, the width may be reduced to 10 ft min, with 15 ft desirable.
- [2] 2% desirable. (See [Chapter 1230](#) for traveled way cross slope.)

1270.08 Documentation

Refer to [Chapter 300](#) for design documentation requirements.

1270.09 References

1270.09(1) Federal/State Laws and Codes

[Revised Code of Washington \(RCW\) 46.61](#), Rules of the road

1270.09(2) Design Guidance

[Manual on Uniform Traffic Control Devices for Streets and Highways](#), USDOT, FHWA; as adopted and modified by [Chapter 468-95 WAC](#) "Manual on uniform traffic control devices for streets and highways" (MUTCD)

[Standard Plans for Road, Bridge, and Municipal Construction \(Standard Plans\)](#), M 21-01, WSDOT

[Traffic Manual](#), M 51 02, WSDOT

1270.09(3) Supporting Information

[A Policy on Geometric Design of Highways and Streets \(Green Book\)](#), AASHTO, [current edition](#)

[Emergency Escape Ramps for Runaway Heavy Vehicles](#), FHWA-T5-79-201, March 1978

[Highway Capacity Manual](#), [latest edition](#), Transportation Research Board, [National Research Council](#)

[Truck Escape Ramps](#), NCHRP Synthesis 178, Transportation Research Board

- 1300.01 General
- 1300.02 Intersection Control Objectives
- 1300.03 Common Types of Intersection Control
- 1300.04 Modal Considerations
- 1300.05 Procedures
- 1300.06 Documentation
- 1300.07 References

1300.01 General

It is WSDOT practice to analyze potential intersection solutions at all intersection improvement locations in accordance with [E 1082 – Business Practices for Moving Washington](#) and [E 1090 – Moving Washington Forward: Practical Solutions](#). The objective is to provide the optimum solution within available limited resources. The analysis may be done for individual intersections, or on a corridor basis. This chapter provides guidance on preliminary intersection analysis and selection of control type. Intersection design is completed using [Chapter 1310](#) for the geometrics of intersections, [Chapter 1320](#) for roundabouts, and [Chapter 1330](#) for traffic signals. Use the aforementioned chapters in conjunction with chapters [1106](#), [1230](#), [1430](#), [1510](#), and [1520](#) to assist with dimensioning design elements.

Motorized traffic and driver characteristics, bicycle and pedestrian needs, physical features, and economics are considered in selecting traffic control that facilitates efficient multimodal traffic flow through intersections. Signs, signals, channelization, and physical geometric layout are the major tools used to establish intersection control.

Typically, potential project locations with safety performance needs will have been identified through the safety priority programming process described in [Chapter 321](#). Other performance category programs may identify intersection needs through the priority array programming process, but the influence of the intersection control with respect to specific performance category needs may not be fully understood until contributing factors analysis is completed (see [Chapter 1101](#)).

An Intersection Control Analysis (ICA) should be completed as early in the project development process as feasible. **The level of effort of the ICA should be scalable to the project;** for example, evaluation of adding a turn lane to an existing intersection control may take less effort than evaluating new intersection control. This may occur during planning or corridor studies, but should not be initiated later than the scoping stage of a project. Data-based knowledge and scientific evaluation provides the basis for performance based improvements.

When analysis determines that an at-grade intersection cannot provide adequate performance, consider a grade separation or an interchange. The ramp terminal intersections are subject to the analysis requirements of this chapter. See Chapters [1360](#) and [550](#) for additional guidance.

For additional information, see the following chapters:

Chapter	Subject
320	Traffic analysis
321	Sustainable Safety
530	Limited access control
540	Managed access control
550	Interchange Justification Report
1100	Practical Design
1101	Need Identification
1103	Design Controls
1106	Design Element Dimensioning
1230	Geometric Cross Section
1310	Intersections
1320	Roundabouts
1330	Traffic signals
1340	Road Approaches
1360	Interchanges
1510	Pedestrian facilities
1515	Shared-use paths
1520	Bicycle facilities

1300.02 Intersection Control Objectives

Intersections are an important part of highway design. They comprise only a small percentage of the overall highway system miles, yet they account for a high percentage of reported crashes and the majority of potential transportation conflict areas. Intersection control choice requires consideration of all potential users of the facility, including drivers of motorcycles, passenger cars, heavy vehicles of different classifications, public transit, and bicyclists and pedestrians.

Design users have varying skills and abilities. Young and elderly drivers in particular are subject to a variety of human factors that can influence elements of their driving ability. See [NCHRP Report 600 – Human Factors Guidelines for Road Systems: Second Edition](#) for additional information (<http://www.trb.org/Main/Blurbs/167909.aspx>). Bicyclists also have a variety of skill sets that can influence the effectiveness of bike facilities and intersection operational design (see [Chapter 1520](#) for additional information). Meeting the needs of one user group can result in compromising service to others. The selection process evaluates these competing needs, resulting in optimal balance of performance categories for all design users.

The intent of intersection control type analysis is not to design an intersection, but to evaluate the compatibility of different intersection control types with respect to context, modal priority, intersection design vehicle and the identified balance of performance needs. Four basic areas of intersection design shown in [Exhibit 1300-1](#) are to be considered in sustainable transportation practice, and can affect the consideration of intersection control types depending on the situation.

The objectives of the intersection control type analysis are to:

- Evaluate the operational performance of all design users for different intersection control types under consideration.
- Evaluate the multimodal performance trade-offs between different intersection control types with respect to the identified modal priority and intersection design vehicle (see [Chapter 1103](#)).
- Evaluate intersection control type with respect to potential operational effects with existing adjacent intersections.
- Understand the potential multimodal treatments that may need to augment typical control types, and their operational effect on other design users.
- Evaluate the intersection control types for potential sustainability, cost-effectiveness, and typical maintenance life cycle needs.
- Decide on the most compatible intersection controls types for that location and balance of performance needs that can be used in alternative formulation procedures (see [Chapter 1104](#)).

Exhibit 1300-1: Intersection Design Areas

Human Factors	
➤ Driving habits	➤ Conformance to natural paths of movement
➤ Driver workload	➤ Pedestrian use and habits
➤ Driver expectancy	➤ Bicycle traffic use and habits
➤ Driver error	➤ Visual recognition of roadway cues
➤ Perception-reaction time	➤ Demand for alternative mode choices
Traffic Considerations	
➤ Design users, modal priority, and intersection design vehicle	➤ Vehicle speeds
➤ Design and actual capacities	➤ Transit involvement
➤ Design-hour turning movements	➤ Crash experience
➤ Size and operating characteristics of vehicle	➤ Bicycle movements
➤ Variety of movements (diverging/merging/weaving/crossing)	➤ Pedestrian movements
Physical Elements	
➤ Character and use of abutting property	➤ Traffic control devices
➤ Vertical alignments at the intersection	➤ Illumination
➤ Sight distance	➤ Roadside design features
➤ Angle of the intersection	➤ Environmental factors
➤ Conflict area	➤ Crosswalks
➤ Speed-change lanes	➤ Driveways
➤ Accessible facilities	➤ Streetside design features
➤ Parking zone	➤ Pavement markings
➤ Geometric design features	➤ Access management treatments
Economic Factors	
➤ Cost of improvements, annual maintenance, and life cycle costs, and salvage value.	
➤ Effects of controlling right of way on abutting properties where channelization restricts or prohibits vehicular movements	
➤ Energy consumption	
➤ Compatibility with context characteristics	

1300.03 Common Types of Intersection Control

1300.03(1) Uncontrolled Intersections

- Uncontrolled intersections do not have signing, and the normal right of way rule ([RCW 46.61.180](#)) applies.
- Most uncontrolled intersections are found on local roads and streets where the volumes of the intersecting roadways are low and roughly equal, speeds are low, and there is little to no crash history.
- Uncontrolled intersections are generally not appropriate for intersections with state routes.



1300.03(2) Yield Control

- Intersections with yield control assign right of way without requiring a stop.
- It is mainly used at roundabouts, ramps, and wye (Y) intersections.

Refer to the [MUTCD](#) for information on the locations where yield control traffic control devices may be appropriate.

1300.03(3) Two-Way Stop Control

- Intersections with two-way stop control are a common, low-cost control, which require the traffic on the minor roadway to stop before entering the major roadway. It is used where application of the normal right of way rule ([RCW 46.61.180](#)) is not appropriate for certain approaches at the intersection.
- Where U-turn opportunities exist within a corridor, or are employed by an alternative, consider limiting access at two-way stops to “right-in, right-out only.”



1300.03(4) Multi-Way Stop Control

Intersections with multi-way stop control:

- Normally require all traffic to stop before entering the intersection.
- Increase traffic delays, fuel consumption, and air pollution.
- Are most effectively used on low-speed facilities with approximately equal volumes on all legs and total entering volumes not exceeding 1,400 vehicles during the peak hour.
- Are often used as an interim measure when a traffic signal is warranted and has been determined to be the best solution, but has yet to be installed.



Guidance for consideration of the application of multi-way stop control is provided in the [MUTCD](#).

Multilane facilities present more operational issues than on two-lane two-way facilities and multi-way stop control is not recommended on multilane state routes. Multi-way stop control is less desirable at intersections with very unbalanced directional traffic due to the delay introduced on the major-volume leg.

1300.03(5) Roundabouts

Roundabouts are traditionally near circular at-grade intersections, but can be a variety of shapes and sizes. Properly designed, located, and maintained roundabouts are an effective intersection type that normally offer the following:

- Fewer conflict points.
- Lower speeds.
- An alternative for areas where wrong-way driving is a concern.
- Reduced fatal- and severe-injury crashes.
- Reduced traffic delays.
- Traffic-calming.
- More capacity than a two-way or multi-way stop.
- More consistent delay relative to other intersection treatments.



- The ability to serve high turning volumes.
- Improved operations where space for queuing is limited.
- At ramp terminals where left-turn volumes are high, improved capacity without widening the structure.
- Facilitation of U-turn movements.

Roundabouts are site-specific solutions. There are no warranting conditions; each is justified on its own merits as the most appropriate choice. See [Chapter 1320](#) for more information on roundabout types and design. However, there is modeling software for roundabouts, making the comparison of intersection control types and justification possible from an operations perspective.

1300.03(6) **Traffic Control Signals**

Properly designed, located, operated, and maintained traffic control signals may offer the following:

- Allow for the orderly movement of traffic.
- Increase the traffic-handling capacity of the intersection.
- Reduce the frequency of severe crashes, especially right-angle crashes.
- Can be coordinated to provide for continuous or nearly continuous movement of traffic at a definite speed along a given corridor under favorable conditions.
- Can be used to interrupt heavy traffic at intervals to permit other traffic, vehicular or pedestrian, to cross.
- Can be preempted to allow emergency vehicle passage.

Traffic control signals are not the solution for all intersection traffic concerns. Indiscriminate installation of signals can adversely affect the safety and efficiency of vehicle, bicycle, and pedestrian traffic.

As a result, installation of a traffic control signal is to meet specific “warrants,” which are found in the [MUTCD](#). A signal warrant is a minimum condition in which a signal may be installed. Satisfying a signal warrant does not mandate the installation of a traffic signal; it only indicates that an engineering study, as described in this chapter, is needed to determine whether the signal is an appropriate traffic control solution.

Some crashes are usually not correctable with the installation of a traffic signal; in fact, the installation of a signal often increases rear-end crashes. These types of crashes are only used to satisfy the crash warrant in special circumstances. If they are used, include an explanation of the conditions that support using them to satisfy the crash experience warrant.

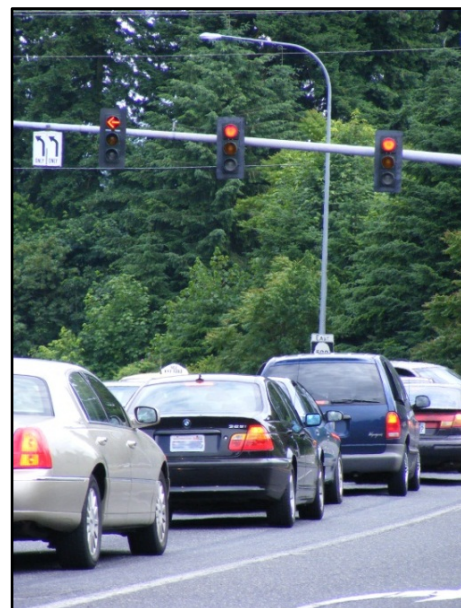

State statutes ([RCW 46.61.085](#)) require WSDOT approval for the design and location of all conventional traffic signals and for some types of beacons located on city streets forming parts of state highways. The Traffic Signal Permit ([DOT Form 242-014 EF](#)) is the formal record of the department's approval of the installation and type of signal. For traffic signal permit guidance, see [Chapter 1330](#).

1300.03(7) Alternative Intersections

A number of alternative intersections have been developed to reduce the delay to through traffic, the number of conflict points, and the number of signal phases for signalized intersections.

Alternative intersections work mainly by rerouting U and left turns, and/or separating movements. Alternative intersections include:

Median U-turn	Split intersection
Jug handle	Quadrant roadway intersection
Bowtie	Single quadrant interchange
Restricted crossing U-turn	Echelon
Continuous flow intersection	Center turn overpass
Continuous green tee (T)	

Like any intersection control solution, alternative intersection designs are site specific in how well they operate. Performance is to be addressed during the intersection control selection process prior to proceeding with the actual design. Trade-offs in selecting alternative intersections may include higher construction costs, driver education, longer left-turn travel distance, circuitous access to adjacent properties, and less direct pedestrian crossing.

Two types of alternative intersections are reviewed in the subsections below: Median U-Turn and Restricted Crossing U-Turn (Superstreets). For more information about these and other intersection design solutions, see the Federal Highway Administration (FHWA) *Alternative Intersections/Interchanges: Informational Report (AIIR)*:

<http://www.fhwa.dot.gov/publications/research/safety/09060/index.cfm>.

1300.03(7)(a) Median U-Turn

The Median U-Turn (MUT) intersection treatment is an approach to simplifying operations at an intersection by removing left-turning movements from the major and/or minor approaches. Left-turning drivers proceed straight through the at-grade intersection, and then execute a U-turn at some distance downstream from the intersection location in place of the traditional left-turning movement. The MUT intersection design is best applied in situations where:

- The intersection is failing due to congestion.
- There is an existing median (on at least one of the roadways) and/or sufficient or low-cost right of way needs can be accommodated.
- Minimal bicycle accommodations are needed.
- There is a need to improve pedestrian mobility.
- There is a need to reduce vehicle and pedestrian/vehicular conflict points.
- There is a need to shorten cycle lengths of signal timing or improve progression.

Refer to FHWA's [Alternative Intersection/Interchanges: Informational Report \(AIIR\)](#) for geometric design considerations and recommendations. (See [1310.05](#) for geometrics when designing the U-turn movement for the MUT intersection.)

1300.03(7)(b) Restricted Crossing U-Turn Intersection

Restricted crossing U-turn (RCUT) intersections, also known as superstreets, work by moving the minor road through and left-turning movements up- and downstream from the intersection location itself. ([Exhibit 1300-2](#) shows an example of an RCUT intersection.)

RCUT intersections:

- Operate by forcing drivers entering from the minor road to turn right onto the major road, and then make a U-turn maneuver at a one-way median opening downstream.
- Provide potential increased traffic safety advantages, due to the reduction of conflict points as compared to a more traditional intersection approach.
- May or may not warrant signalization due to traffic volumes, and those with signalization may require fewer phases and shorter cycles than a similar four-way intersection.

RCUT intersections are best applied in situations where:

- There is a rural expressway or urban arterial.
- There is partial control or managed access facilities.
- Major and minor traffic flows intersect.
- There is a high ratio of through movements to left turns on the main line.
- There are low through traffic volumes on the minor road.
- The major roadway is multilane.
- The major roadway contains sufficient median width, or total right of way width, to support the U turn movements.

Exhibit 1300-2 RCUT Intersection US23, North Carolina



Photo Credit: NCDOT

The RCUT intersection may be a competitive alternative compared to a grade-separated interchange, at locations meeting grade-separated considerations identified in 530.04(3). Refer to [Alternative Intersection/Interchanges: Informational Report \(AIIR\)](#) for geometric design considerations and recommendations. (See [1310.05](#) for geometrics when designing the U-turn movement for the RCUT.)

1300.04 Modal Considerations

When designing a multimodal intersection, consideration needs to be given to all design users at the intersection, the intersection design vehicle and selected modal priority (see [Chapter 1103](#)). While specific intersection control types do not exist for each mode, treatments that augment different control types do exist for different users. Some of these treatments are specific to certain control types while others can be provided for several intersection control types.

It is not appropriate to design for specific modal treatments on the outset of evaluating intersection control types. However, modally oriented intersection treatments may be necessary to enhance specific modal baseline or contextual performance needs (see [Chapter 1101](#)), and may influence the control type selection. Include a discussion of the potential modally oriented treatments relevant to the control types being analyzed and modal performance needs. Evaluate the potential effect of modal specific treatments on all design users relevant for the control types evaluated in the ICA (see [1300.06](#)).

1300.04(1) Pedestrian Considerations

Discuss the elements and/or treatments applicable for pedestrians (see chapters 1230 and 1510) to meet modal performance needs identified (see Chapter 1101). Additional information on emerging practices to address pedestrian performance needs for different intersection control types can be found at the Pedestrian and Bicycle Information Center (www.pedbikeinfo.org/)

1300.04(2) Bicycle Considerations

For consideration of bicycle needs at intersections and treatments that may have an operational effect on other design users, see chapters 1515 and 1520. Additional emerging practice information to address bicycle performance needs for different intersection control types can be found at the Pedestrian and Bicycle Information Center (www.pedbikeinfo.org/) and the *NACTO Urban Bikeway Design Guide* (<http://nacto.org/cities-for-cycling/design-guide/>).

1300.04(3) Transit Considerations

When transit vehicles are identified as a modal priority, consider treatments to meet the performance needs of the specific transit vehicle types and their effect on the performance of other design users (see Chapter 1103). Transit oriented treatments can vary significantly depending on the proximity of stop locations with respect to the intersection location and origin of the transit movement (see Chapter 1430 for bus stop placement guidelines), and the type of transit vehicle (such as a fixed guideway vehicle). Discuss treatment options and any operating restrictions the transit provider may have regarding different intersection control types.

1300.05 Procedures

For new intersections, determine and document traffic control according to the applicable procedures in this chapter.

For intersection improvement projects involving pavement construction and/or reconstruction, or signal replacement/rehabilitation, evaluate intersection control in accordance with this chapter unless there is documentation that this analysis has already been completed and is referenced in the Project Summary.

Control for existing intersections that are unaffected by the project (per the contributing factors analysis) or are receiving minor revisions such as signal phasing changes (as shown through the analysis) may remain in place without further evaluation. Document the impacts and recommended revisions to all intersections affected by the project.

1300.05(1) Intersection Control Analysis (ICA)

Use the following steps when screening intersection control alternatives for selection, or to support the need for modifications to existing intersection control:

- **Determine the right of way requirements and feasibility.** Discuss the right of way requirements and the feasibility of acquiring that right of way in the analysis. Include sketches or plan sheets with sufficient detail to identify topography (including utilities), environmental constraints, drainage, buildings, and other fixed objects. An economic evaluation will be useful if additional right of way is needed. Include the right of way costs in the benefit/cost analysis.

- **Check signal warrants.** Evaluate existing peak period counts to determine the need for additional count data. If these counts do not meet a warrant, obtaining 12- or 24-hour count information is likely unnecessary. In some cases, the project may alter traffic patterns at an existing signal enough that it may no longer meet a warrant. See the [MUTCD](#) for a list of the traffic signal warrants and information on how to apply them.

For new intersections, project hourly volumes, and movements using established methodology; see [Chapter 320](#).

If signal warrants are met, evaluate multi-way stop, roundabout, and signal. If warrants are not met, evaluate yield, two-way stop, multi-way stop, and roundabout. Please note, the evaluation of a roundabout option is always required by resolution of the Multimodal Safety Executive Committee (MSEC). This evaluation requirement is based on the measured performance benefits of roundabouts.

For more information about the benefits of roundabouts see:

<http://www.wsdot.wa.gov/Safety/roundabouts/benefits.htm>.

Alternative configurations are encouraged for consideration, especially if standard forms of control do not satisfy the performance needs identified.

- **Determine environmental impacts.** Evaluate the impacts and permit requirements of each intersection control option (see the [Environmental Manual](#)). Any environmental risks that may substantially increase the cost of the project should be identified early in the process. Risk impacts to each alternative should be quantified for comparison.
- **Identify modal treatments.** In some locations, given the modal priority and modal performance needs identified, it may be necessary to evaluate specific modal treatments applicable to the various intersection control types in the analysis. Understand common movements or travel patterns for the modes or future patterns assumed for the redesign. The objective is to provide visible, distinct, predictable and clear travel paths for the various modes, and understand the operational effect for all design users to meet these needs. See chapters [1430](#), [1510](#), [1515](#), and [1520](#) for additional information. The type and extent of multimodal treatments varies for each control type. Some control types require less additional multimodal treatments to meet multimodal performance needs depending on the configuration and use of the intersection. The extent to which treatments are applied to meet modal operational performance needs may have a significant influence on the control type selected at a location.
- **Analyze alternatives and document the selection.** In addition to documenting the screening process for selecting the alternatives to be analyzed, the Intersection Control Analysis should include the following information: existing conditions, delay analysis, operational considerations, including a crash risk analysis if appropriate (see [Chapter 321](#)), Benefit/Cost Analysis, Bicycle and Pedestrian Facilities, Context-Specific/Sustainable Design, and any Additional Information that is relevant. *The*

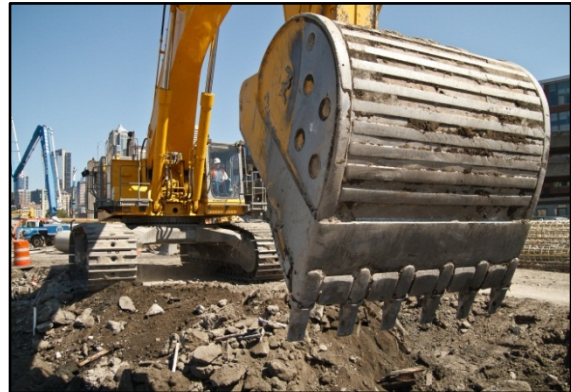

single-lane roundabout is the preferred alternative. If selected, no comparison with other alternatives is required.

1300.05(1)(a) Existing Conditions

The description should include, physical characteristics of the site, posted speed, traffic counts (Tuesday through Thursday average and peak hour manual counts), available sight distance(s), channelization, multmodal facilities, and modal priority.

Analyze the crash history and use current diagnostic tools described in [Chapter 321](#) to determine the expected and predicted crash rates are used to figure excess crashes for intersection performance in sustainable safety. Identify any conflict movements.

1300.05(1)(b) Delay Analysis

Since two or more traffic streams cross, converge, or diverge at intersections, the capacity of an intersection is normally less than the roadway between intersections. (See [Chapter 320](#) for additional details about traffic analysis.)

Provide a sketch of the intersection used for modeling. Include recommendations for channelization, turn lanes, multimodal treatments, as well as acceleration and deceleration lanes for the preferred option for each intersection. Turn prohibitions may be used to increase intersection capacity or enhance the performance of a specific mode (such as eliminating motorized vehicle turns to enhance safety performance for bicyclists). Analyze all relevant peak periods (with A.M. and P.M. as a minimum) for all intersection control alternatives. Holidays and special or seasonal events of short duration are generally not considered in the level of service (LOS) determination, although there are situations where a minor leg peak hour determines the hour used in analysis. Evaluating the 24-hour volumes may be necessary to maximize capacity and support the choice of intersection control that performs with the least overall delay.

Include the following in the delay analysis:

- Use the project's selected design year for analysis (see [Chapter 1103](#)). In some situations, it may also be appropriate to analyze the horizon year as well.
- Identify and justify any growth rate used for design year analyses.
- Provide turning-movement volumes for all scenarios.
- Discuss the steps taken to arrive at the peak hour volume determination and how it relates to design hourly volume (DHV).

There are several deterministic and microsimulation programs for analyzing delay and intersection performance. Traffic volumes and the proximity of the project to other access points will dictate the modeling effort required. Contact the region Traffic Office to determine the appropriate approved program. With each analysis iteration, account for agreement between the proposed intersection design and what is modeled. For example, in modeling signals, a free right turn affects timings and also removes those vehicles from consideration in warrant analysis.

1. Two-Way Stop Control

When the through roadway average daily traffic is 3,500 or less, delay analysis is not required except in cases where the higher-volume roadway is controlled or where channelization is proposed. This is because adequate LOS for channelization projects does not always correlate to operational safety.

2. Multi-Way Stop Control

Analyze according to the guidance provided in the [MUTCD](#).

3. Roundabouts

Provide a capacity analysis to estimate the entry capacity of each roundabout entry leg. Innovative capacity analysis is occasionally needed on projects where metering a heavy leg for short periods of the day allows the most efficient operation 24 hours a day. Contact the region Traffic Office for the specific calibration information to use.

4. Signals

When modeling signals, consider the phasing design criteria contained in [Chapter 1330](#). This may be guided by available opposing left-turn clearances at an intersection. Also, evaluate pedestrian movements and accommodate them in the proposed cycle lengths. Check the modeled signal phasing and timing for its ability to be programmed into the signal controller.

Progression of main line traffic is one reason given for using traffic signals; however, there are several reasons why progression may not realistically be obtained or sustained. Signal spacing, left-turn movements, speed, volume (particularly side street volume), and pedestrian movements can all affect the ability to achieve progression.

Consult the region Traffic Office for information on current signal operations practices. (See [Chapter 1310](#) for additional guidance on turn lane considerations.)

5. Alternative Intersections

Operational considerations for modeling depend on the intersection design in question. They may include the LOS for turning movements, weaving requirements, the need for vehicle storage, acceleration lanes, and the LOS at the merge points. The analyst and reviewer should agree on what measures of effectiveness will be used in addition to the performance metrics chosen for the project (see [Chapter 1101](#)).

1300.05(1)(c) Operational Considerations

The transportation network has a mix of intersection controls. Traditional delay analysis focuses on determining the peak-hour letter-graded LOS of an individual intersection. Operational analysis is a more encompassing review of the ability of the intersection to provide sufficient multimodal capacity and safety performance in the network, and includes consideration of the environment that users will encounter at all hours of the day.

Intersection control has an influence on approaches, other intersections, and multimodal operations, even at acceptable LOS. Increased delay affects route choice. A driver's willingness to accept delay depends on the current circumstances and the driver's knowledge of the transportation network. The arrival of in-vehicle guidance systems will only increase the tendency of drivers to seek out routes with shorter travel times. Thus, it is important to consider the effects of intersection control on the surrounding network. Document the existing and proposed design. Points that may need to be addressed include the following:

- Use access management alternatives such as rerouting traffic to an existing intersection with available capacity. Check with the WSDOT region Planning Office for future land use plans or comprehensive plans to provide for future growth accommodation. Discuss options and strategies that have been developed through a collaborative planning process with the local agency or, where appropriate, the regional or metropolitan transportation planning organization.
- Consider the volume to capacity (V/C) ratio, the delay, and the queue length of the legs. Roundabout V/C ratios above 0.92 may require additional sensitivity analysis to determine the impacts of small changes in volume and propose solutions. Discuss the results of the capacity analysis and the lanes necessary for each leg of the intersection.
- Compare the geometry/number of lanes required by different alternatives to achieve similar results.
- Consider the effect on other travel modes: rail, bus, pedestrian, and bicycle.
- Examine the effects of existing conditions. Discuss progression through nearby intersections (corridor and network analysis) and known risky or illegal driving maneuvers. Work with the region Traffic Office to verify the network area of influence.
- Determine how the proposed control will meet the objectives for intersection control (see [1300.04](#)) at all hours compared to other alternatives. This is particularly applicable when only the peak hour warrant is met for a signal, since it is used only in rare cases.
- Consider the possibility that traffic from other intersections with lower levels of service will divert to the new/revised intersection.
- Compare the predicted crash frequency of the alternatives using the tools described in [Chapter 321](#). Discuss how each proposed solution might affect safety performance and crash types.
- Identify the intersection design vehicle (see [Chapter 1103](#)). Include truck types and sizes (including oversized vehicles) that travel through the area both currently and consider future users. Include verification of turning movements based on turn simulation software (such as AutoTURN®).
- Examine queue lengths in areas where there are intersections or approaches in close proximity. When other intersections are affected, if needed, use a calibrated simulation to fully evaluate the operational effects of the proposed traffic control on the system.
- Evaluate sight distances (stopping, intersection, decision) for the proposed designs prior to selection of an alternative.

1300.05(1)(d) Benefit/Cost Analysis

Benefit/cost analysis compares the value of benefits against costs. There is considerable debate on what can and should be included in this analysis, particularly in the area of environmental and societal benefits and costs. Generally, and in keeping with the objectives of intersection control, the only societal costs/benefits WSDOT evaluates are those due to crashes and delay. Include the following in the analysis:

- Project costs related to design, right of way, and construction.
- Annual maintenance cost differences between the options. For signals, this also includes the cost to review the signal timings in accordance with current signal operations guidelines. This value can be obtained from the region Traffic Office.
- 24-hour travel time savings. Workbook and annual information can be found at: www.wsdot.wa.gov/mapsdata/travel/mobility.htm
- A predictive method to compare societal benefits or costs calculated from the change in crash severity and/or frequency using the tools described in [Chapter 321](#).
- Salvage value of right of way, grading and drainage, and structures.

While WSDOT benefit/cost analysis at intersections is restricted to only evaluate the mobility benefit for motorized vehicles in terms of delay, an intersection design that does not meet the identified performance trade-off balance (see [Chapter 1104](#)) on the project's Basis of Design (see [Chapter 1100](#)) will not be justified.

1300.05(1)(e) Context Sensitive/Sustainable Design

Context sensitive design is a model for transportation project development. A proposed transportation project is to be planned not only for its physical aspects as a facility serving specific transportation objectives, but also for its effects on the aesthetic, social, economic, and environmental values, needs, constraints, and opportunities in a larger community setting. Projects designed using this model:

- Optimize safety of the facility for both the user and the community.
- Promote multimodal solutions.
- Are in harmony with the community, and preserve the environmental, scenic, aesthetic, historic, and natural resource values of the area.
- Are designed and built with minimal disruption to the community.
- Involve efficient and effective use of the resources (time, budget, community) of all involved parties.



1300.05(1)(f) Additional Information

Discuss the following in the intersection analysis as needed to further support the selection (is it an item that will have a significant effect on the decision?):

- Information from the Route Development Plan or other approved corridor study.
- Review the corridor sketch plans and database with the regional planning office.
- Environmental permitting restrictions, such as the ones in place in scenic areas and other locations with similar restrictions.
- Current and future land use and whether or not the intersection control will reasonably accommodate future land use traffic changes.
- Current/proposed speed limits (changes in speed limits can affect signal warrants).
- Public meeting comments.
- Outside agency coordination and comments.
- Medians, lane widths, and parking.
- Effect on future local agency projects.
- Other elements considered in the selection of the intersection control.

1300.05(2) Community Engagement

Community engagement is a necessary element of project development. Technical, public, and political aspects must be considered. There is often unwarranted concern from communities regarding certain control types that may be under consideration. Education and outreach efforts, if necessary, are collaborative and are most useful during the analysis and early design stages. It is critical that community engagement efforts occur with preparation and well organized content regarding the performance data associated with different control types to inform communities of the distinct advantages of different control types with respect to the context, modes, safety and operations desired. Use contextual performance needs (see [Chapter 1101](#)) identified by the community to help support the options being considered at a given location.



Follow the guidelines of WSDOT's *Community Engagement Plan* (<http://www.wsdot.wa.gov/planning/>), and document the effort as indicated in [Chapter 1100](#).

1300.05(3) Approval

Refer to [Chapter 300](#) for additional information on approval authorities. Approval of intersection control type (to be completed no later than the scoping phase) requires the following:

- Traffic Engineer's Stamp and Seal
- HQ Traffic Approval
- Region Approval

1300.05(4) Local Agency or Developer-Initiated Intersections

[Chapter 320](#) provides guidance for preparation of a Traffic Impact Analysis (TIA). Early in the design process, local agencies and developers should coordinate with the region office to identify specific intersections for further analysis. The project initiator provides an Intersection Control Analysis (ICA) for approaches and intersections with state routes per [1300.05\(1\)](#), or references this information in the TIA. The project initiator documents the design considerations and submits the ICA and all documentation to the region for approval (per [1300.05\(1\)](#)). After the ICA is approved, finalize the intersection design and obtain approval per Chapters [300](#) (for documentation), [1310](#) (for intersections), [1320](#) (for roundabouts), and [1330](#) (for traffic signals).

State highway intersections in local agency projects are subject to the requirements of this chapter.

1300.06 Documentation

Refer to [Chapter 300](#) for design documentation requirements.

1300.07 References

1300.07(1) Federal/State Laws, Codes, and Policies

[Revised Code of Washington \(RCW\) 46.61](#), Rules of the road

[Washington Administrative Code \(WAC\) 468-52](#), Highway access management – access control classification system and standards

Intersection Control/Modification Process, Highway Safety Executive Committee (HSEC) Policy Paper, April 2012, WSDOT

[Secretary's Executive Order: E 1082](#), Business Practices for Moving Washington, August 2012, WSDOT

1300.07(2) Design Guidance

A Policy on Geometric Design of Highways and Streets (Green Book), AASHTO

Highway Capacity Manual (HCM), latest edition, Transportation Research Board, National Research Council

[Local Agency Guidelines](#) (LAG), M 36-63, WSDOT

[Manual on Uniform Traffic Control Devices for Streets and Highways](#), USDOT, FHWA; as adopted and modified by Chapter 468-95 WAC “Manual on uniform traffic control devices for streets and highways” (MUTCD)

[Standard Plans for Road, Bridge, and Municipal Construction](#) (Standard Plans), M 21-01, WSDOT

1300.07(3) Supporting Information

Highway Safety Manual (HSM), AASHTO

Roundabouts: An Informational Guide, FHWA-RD-00-067, USDOT, FHWA

Roundabouts: An Informational Guide, Second Edition, NCHRP Report 672, Transportation Research Board, 2010

A Review of the Signalized Intersections: Informational Guide. FHWA-HRT-04-092, USDOT, FHWA, APRIL 2004

🔗 www.fhwa.dot.gov/publications/research/safety/04092/

Choosing Intersection Control, IMSA Journal, Buckholz, Nov/Dec 2002.

🔗 www.imsasafety.org/journal/nd02/buckholz.pdf

Safety Effectiveness of Highway Design Features, Volume V: Intersections, Kuciemba, S. R., and J. A. Cirillo. Report No. FHWA-RD-91-048, Federal Highway Administration, November 1992.

A Comparison of a Roundabout to Two-way Stop Controlled Intersections with Low and High Traffic Volumes, Luttrell, Greg, Eugene R. Russell, and Margaret Rys, Kansas State University

Guidance for Implementation of the AASHTO Strategic Highway Safety Plan, Volume 5: A Guide for Addressing Unsignalized Intersection Collisions, NCHRP Report 500, Transportation Research Board, 2003

🔗 http://onlinepubs.trb.org/onlinepubs/nchrp/nchrp_rpt_500v5.pdf

Guidance for Implementation of the AASHTO Strategic Highway Safety Plan Volume 12: A Guide for Reducing Collisions at Signalized Intersections, NCHRP Report 500, Transportation Research Board, 2004

🔗 http://onlinepubs.trb.org/Onlinepubs/nchrp/nchrp_rpt_500v12.pdf

Synthesis of the Median U-Turn Intersection Treatment, Safety, and Operational Benefits, FHWA-HRT-07-033, USDOT, FHWA

Alternative Intersections/Interchanges: Informational Report (AIIR), FHWA-HRT-09-060, Hughes et al., USDOT, FHWA, 2010

Field Evaluation of a Restricted Crossing U-Turn Intersection, FHWA-HRT-12-037, USDOT, FHWA

Roundabouts and Sustainable Design, Ariniello et al., Green Streets and Highways – ASCE, 2011

Pedestrian and Bicycle Information Center

🔗 www.pedbikeinfo.org/

Community Engagement Plan, WSDOT

🔗 www.wsdot.wa.gov/planning/

- [1310.01 General](#)
- [1310.02 Design Considerations](#)
- [1310.03 Design Elements](#)
- [1310.04 U-Turns](#)
- [1310.05 Intersection Sight Distance](#)
- [1310.06 Signing and Delineation](#)
- [1310.07 Procedures](#)
- [1310.08 Documentation](#)
- [1310.09 References](#)

1310.01 General

Intersections are a critical part of Washington State Department of Transportation (WSDOT) highway design because of increased conflict potential. Traffic and driver characteristics, bicycle and pedestrian needs, physical features, and economics are considered during the scoping and design stages to develop channelization and traffic control to provide multimodal traffic flow through intersections.

See chapters in the 1100 series for instruction on multimodal practical design, including identifying project needs, context, design controls, modal performance, alternatives analysis, and design element dimensioning.

Some exhibits and text in this chapter include design element criteria such as dimensions for lane or shoulder widths. Use dimensioning methods described in Chapter 1106 and guidance in Chapter 1230 to determine lane and shoulder widths.

This chapter provides guidance for designing intersections, including ramp terminals. Refer to the following chapters for additional information:

Chapter	Subject
1103	Design controls
1106	Design element dimensions
1230	Geometric cross section
1300	Intersection control type
1320	Roundabouts
1330	Traffic signals
1340	Driveways
1360	Interchanges
1510	Pedestrian facilities
1520	Roadway bicycle facilities

For assistance with intersection design, contact the Headquarters (HQ) Design Office.

1310.02 Design Considerations

Consider all potential users of the facility in the design of an intersection. This involves addressing the needs of a diverse mix of user groups, including passenger cars, heavy vehicles of varying classifications, bicycles, and pedestrians. Often, meeting the needs of one user group results in a compromise in service to others. Intersection design balances these competing needs, resulting in appropriate levels of operation for all users.

In addition to reducing the number of conflicts, minimize the conflict area as much as possible while still providing for the design vehicle (see [Chapter 1300](#)). This is done to control the speed of turning vehicles and reduce the area of exposure for vehicles, bicycles, and pedestrians. For additional information on pedestrian needs, see [Chapter 1510](#). For intersections with shared-use paths, see [Chapter 1515](#). For bicycle considerations at intersections, see [Chapter 1520](#).

1310.02(1) Non-Geometric Considerations

Geometric design considerations, such as sight distance and intersection angle, are important. Equally important are perception, contrast, and a driver's age. Perception is a factor in the majority of [crashes](#). Regardless of the type of intersection, the function depends on the driver's ability to perceive what is happening with respect to the surroundings and other vehicles. When choosing an acceptable gap, the driver first identifies the approaching vehicle and then determines its speed. The driver uses visual clues provided by the immediate surroundings in making these decisions. Thus, given equal sight distance, it may be easier for the driver to judge a vehicle's oncoming speed when there are more objects to pass by in the driver's line of sight. Contrast allows drivers to discern one object from another.

1310.02(2) Intersection Angle and Roadway Alignment

An important intersection design characteristic is the intersection angle. The desirable intersection angle is 90°, with 60° to 120° allowed. Do not put angle points on the roadway alignments within intersection areas or on the through roadway alignment within 100 feet of the edge of traveled way of a crossroad. However, angle points within the intersection are allowed at intersections with a minor through movement, such as at a ramp terminal (see [Exhibit 1310-2](#)).

When feasible, locate intersections such that curves do not begin or end within the intersection area. It is desirable to locate the PC and PT 250 feet or more from the intersection so that a driver can settle into the curve before the gap in the striping for the intersection area. Do not locate short curves where both the PC and PT are within the intersection area.

1310.02(3) Lane Alignment

It is desirable that entering through traffic is aligned with the exit lanes. However, the entering and exit lanes may be offset up to 6 feet when the following conditions are met:

- Illumination is provided.
- The intersection is not within a horizontal curve, nor is it within a crest vertical curve.
- The taper rates provided in [Exhibit 1310-1](#) are used.
- There is a posted speed of 55 mph or less.

Consider dotted extension lines that continue through the intersection.

Exhibit 1310-1 Lane Alignment Taper Rate

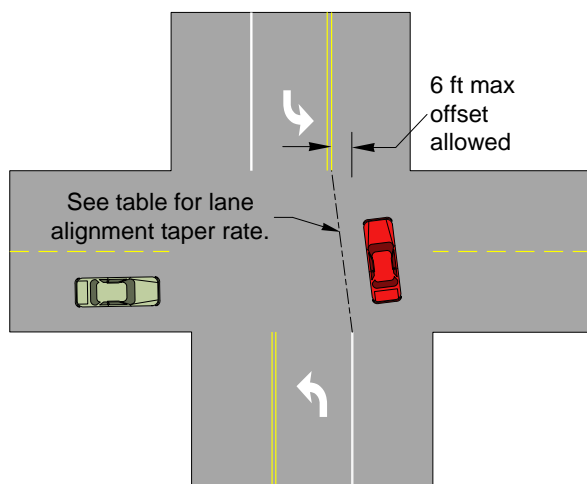

Posted Speed	Taper Rate
55 mph	55:1
50 mph	50:1
45 mph	45:1
40 mph	27:1
35 mph	21:1
30 mph	15:1
25 mph	11:1

1310.02(4) Intersection Spacing

Provide intersection spacing for efficient operation of the highway. The minimum design intersection spacing for highways with limited access control is covered in [Chapter 530](#). For other highways, the minimum design intersection spacing is dependent on the managed access highway class. (See [Chapter 540](#) for minimum intersection spacing on managed access highways.)

As a minimum, provide enough space between intersections for left-turn lanes and storage length. Space signalized intersections and intersections expected to be signalized to maintain efficient signal operation. Space intersections so that queues will not block an adjacent intersection.

Evaluate existing intersections that are spaced less than shown in Chapters 530 and 540. Also, evaluate closing or restricting movements at intersections with operational issues. Document the spacing of existing intersections that will remain in place and the effects of the spacing on operation, capacity, and circulation.

1310.02(5) Accommodating vs. Designing for Vehicles

Accommodating for a vehicle allows encroachment of other lanes, shoulders, or other elements to complete the required maneuver. Designing for a vehicle does not require encroachment on those elements.

There are competing design objectives when considering the crossing needs of pedestrians and the turning needs of larger vehicles. To design for large design vehicles, larger turn radii are used. This results in increased pavement areas, longer pedestrian crossing distances, and longer traffic signal arms. (See Chapter 1300 for design vehicle selection criteria.)

When appropriate, to reduce the intersection area, consider accommodating for large vehicles instead of designing for them. This reduces the potential for vehicle/pedestrian conflicts, decreases pedestrian crossing distance, and controls the speeds of turning vehicles. Use turn simulation software (such as AutoTURN®) to verify the design.

1310.02(6) Sight Distance

For stopping and decision sight distance criteria, see Chapter 1260. Intersection sight distance criteria are discussed in section 1310.05.

1310.02(7) Crossroads

When the crossroad is a city street or county road, design the crossroad beyond the intersection area in cooperation with the local agency.

When the crossroad is a state facility, design the crossroad according to the *Design Manual*. Continue the cross slope of the through roadway shoulder as the grade for the crossroad. Use a vertical curve that is at least 60 feet long to connect to the grade of the crossroad.

Evaluate the profile of the crossroad in the intersection area. The crown slope of the main line might need to be adjusted in the intersection area to improve the profile for the cross traffic.

Design the grade at the crosswalk to meet the requirements for accessibility. (See Chapter 1510 for additional crosswalk information.)

In areas that experience accumulations of snow and ice for all legs that require traffic to stop, design a maximum grade of $\pm 4\%$ for a length equal to the anticipated queue length for stopped vehicles.

1310.02(8) Rural Expressway At-Grade Intersections

Evaluate grade separations at all intersections on rural expressways.

Design high-speed at-grade intersections on rural expressways as indirect left turns, split intersections, or roundabouts.

The State Traffic Engineer's approval is required for any new intersection or signal on a rural expressway.

1310.02(9) Interchange Ramp Terminals

When stop control or traffic signal control is selected, the design to be used or modified is shown in [Exhibit 1310-2](#). Higher-volume intersections with multiple ramp lanes are designed individually. Provide ramp terminal designs consistent with the speed of the crossroad.

Where stop control or signal control is implemented, the intersection configuration criteria for ramp terminals are normally the same as for other intersections. One exception is that an angle point is allowed between an off-ramp and an on-ramp. This is because the through movement of traffic getting off the freeway, going through the intersection, and getting back on the freeway is minor.

Another exception is at ramp terminals where the through movement is eliminated (for example, at a single-point interchange). For ramp terminals that have two wye connections, one for right turns and the other for left turns, and no through movement, the intersection angle has little meaning and does not need to be considered.

Due to the probable development of large traffic generators adjacent to an interchange, width for a median on the local road is desirable whenever such development is expected. This allows for future left-turn channelization. Use median channelization when justified by capacity determination and analysis or by the need to provide a smooth traffic flow.

Adjust the alignment of the intersection legs to fit the traffic movements and to discourage wrong-way movements. Use the allowed intersecting angles of 60° to 120° in designing the best alignment for efficiency and intersection operations.

Exhibit 1310-2 Ramp Terminal Intersection Details

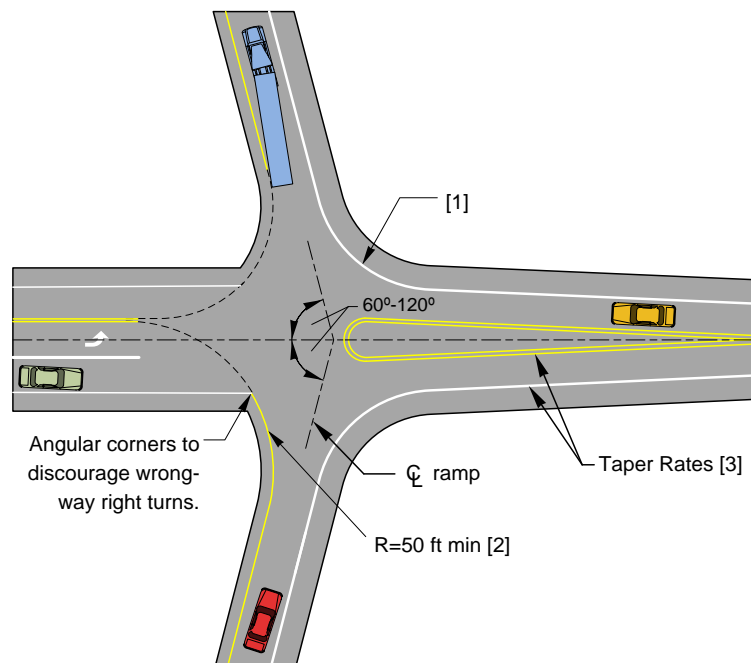

Notes:

- [1] For right-turn corner design, see [Exhibit 1310-6](#).
- [2] Use turn simulation software to verify that the design vehicle can make the turn.
- [3] For taper rates, see [Exhibit 1310-10a](#), Table 1.

1310.02(10) **Wrong-Way Movement Countermeasures**

Wrong-way crashes, though infrequent, have the potential to be more serious than other types of crashes, especially on high-speed facilities. Crash data show that impaired and older drivers are overrepresented and that a high percentage of these occurrences are at night. Washington State data show approximately equal numbers of crashes on the Interstate and multilane urban principal arterial highways. Discourage wrong-way maneuvers at all stages of design.

1310.02(10)(a) **Wrong-Way Driving Countermeasure Categories**

There are three categories of countermeasures to discourage wrong-way driving:

- Signing and delineation
- Intelligent transportation systems
- Geometric design

1310.02(10)(a)(1) **Signing and Delineation**

Signing and delineation countermeasures include:

- DO NOT ENTER and WRONG WAY signs.
- ONE WAY signs.
- Turn restriction signs.
- Red-backed raised pavement markers (RPMs).
- Directional pavement arrows.
- Yellow edge line on left and white edge line on right side of exit ramps.
- Pavement marking extension lines to direct drivers to the correct ramp.

Signing can be a more effective countermeasure when the signs are lowered. At night, lowered signs are better illuminated by low-beam headlights. Other improvements may include a second set of signs, supplemental sign placards, oversized signs, flashing beacons, internal illumination, overhead-mounted signs, red reflective tape on the back of signs, extra overhead lighting, and red-backed guideposts on each side of the ramp up to the WRONG WAY sign.

1310.02(10)(a)(2) **Intelligent Transportation Systems (ITS)**

Wrong-way ITS countermeasures are wrong-way detection and warning systems. Contact the region Traffic Office for assistance when considering an ITS wrong-way warning system.

1310.02(10)(a)(3) **Geometric Design**

Geometric countermeasures include separating wrong-way movements from other movements, discouraging wrong-way movements, encouraging right-way movements, and improving the visibility of the right-way movement.

a. Separate On- and Off-Ramp Terminals

Consider the separation of on- and off-ramp terminals, particularly at interchanges where the ramp terminals are closely spaced (for example, partial cloverleaf ramps combined with

other ramps). Wider medians between off- and on-ramp terminals provide room for signing and allow the median end to be shaped to help direct vehicles onto the correct roadway. The minimum width of the raised median is 7 feet, face of curb to face of curb, to accommodate a 36 inch sign.

Extend the raised median on a two-way ramp from the ramp terminal intersection to the split of the on- and off-ramps. The median outside of the intersection area may be reduced to the width of a dual-faced mountable curb. (See [Exhibit 1310-3](#) for an example of the minimum median at the terminal of a two-way ramp.)

Exhibit 1310-3 Median at Two-Way Ramp Terminal

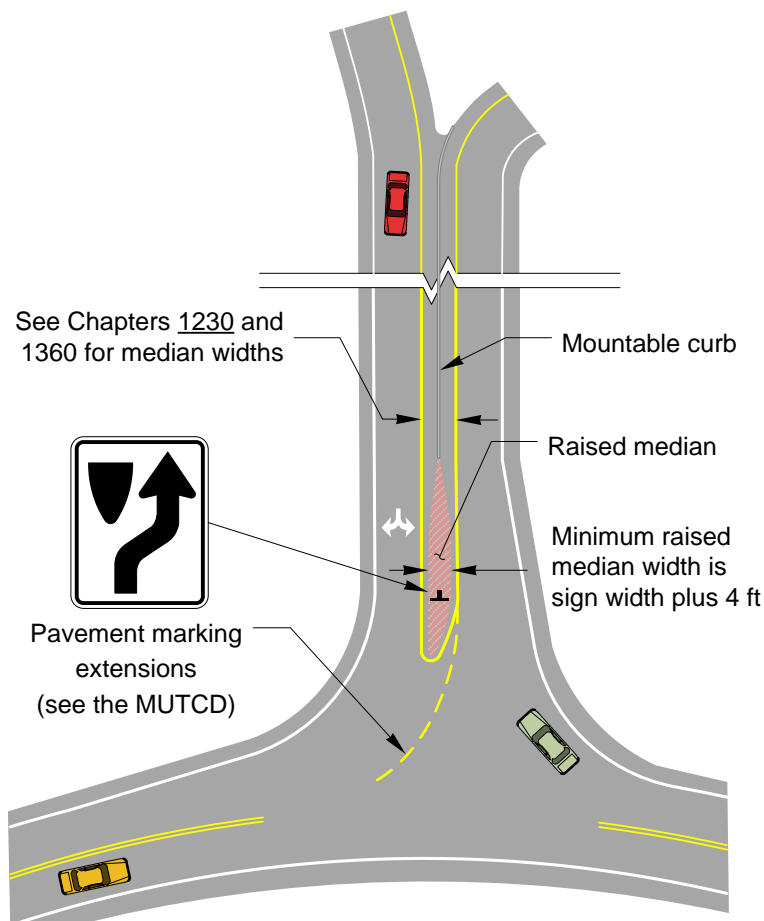

b. Reduced Off-Ramp Terminal Throat Width

Reducing the width of the off-ramp throat has been a successful method of discouraging wrong-way movements. A smaller opening makes the wrong-way entry less inviting, particularly for closely spaced ramps. When off-ramp terminals have right-turn lanes, a raised island will reduce the potential for a wrong-way movement.

c. Increased On-Ramp Terminal Throat Width

Increasing the width of the on-ramp throat can encourage right-way movements. A larger opening for the on-ramp makes it easier to turn into. To increase the throat width of on-ramps, use flat radii for left- and right-turning traffic and remove islands.

d. Intersection Balance

When drivers make a left turn, they are required to leave the intersection in the extreme left-hand lane lawfully available. As a result, left-turning drivers tend to head for a point between 50% and 60% of the way through the intersection.

At a two-way ramp terminal, the desirable throat width for the on-ramp roadway is not less than the off-ramp roadway width to accommodate this behavior (see [Exhibit 1310-4](#)). Much of this can be achieved by adjusting the stop bar position on the interchange cross street.

Exhibit 1310-4 Intersection Balance Example

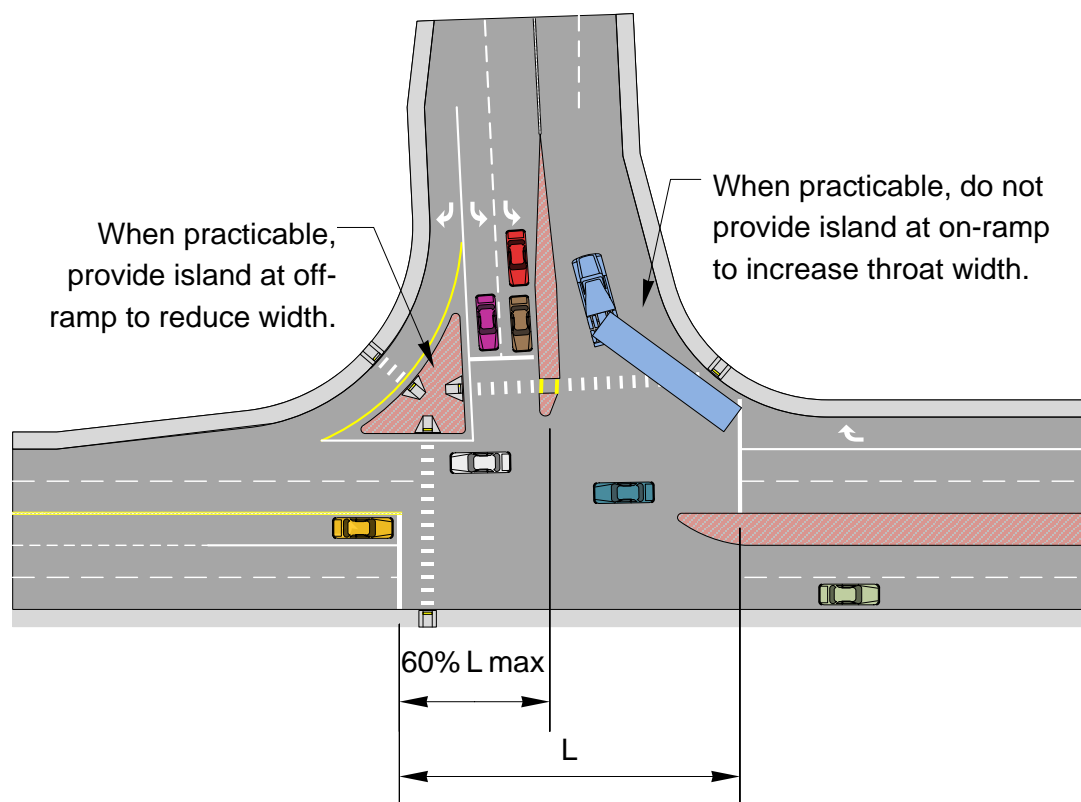

e. Visibility

When drivers can see and recognize the roadway they want to turn onto, they are less likely to make a mistake and turn onto the wrong roadway. For two-way ramps and divided multilane roadways with barrier in the median, end the barrier far enough from the intersection that a left-turning driver can see and recognize the roadway going the correct

direction. Drivers need to see the delineation pavement markings, curbs, or other elements to locate the correct roadway.

f. Angular Corners on the Left of Off-Ramp Terminals

Angular corners on the left side of off-ramp terminals will discourage wrong-way right turns. Provide a corner design as angular as feasible that will provide for the left turn from the off-ramp. Circular curves can look inviting for a wrong-way right turn onto the off-ramp (see [Exhibit 1310-2](#)).

1310.02(10)(b) Countermeasure Applications

Following are applications of wrong-way countermeasures for some common locations. For assistance with signing and delineation, contact the region Traffic Office.

1310.02(10)(1) All Ramps

Countermeasures that can be used on almost any ramp or intersection with potential wrong-way concerns include:

- Enlarged warning signs.
- Directional pavement arrows at ramp terminals.
- Redundant signing and pavement arrows.
- Roundabout ramp terminal intersections, where room is available.
- Red-backed RPMs.

1310.02(10)(2) One-Way Diamond Off-Ramp

Diamond interchanges are common, and although drivers are familiar with them, they can still get confused and go the wrong way. In addition to signing and pavement markings for these interchanges, provide:

- Angular corners to discourage wrong-way right turns.

1310.02(10)(3) Diamond Interchange With Advance Storage

Diamond interchanges with advance storage have left-turn storage lanes that extend from the on-ramp past the off-ramp (see [Exhibit 1310-5](#)). This allows for a potential early left turn onto the off-ramp. Following are additional countermeasures for interchanges with advanced left-turn storage:

- Provide a raised median to discourage the wrong-way left turn.
- Provide signing and directional arrows to direct traffic to the correct left-turn point.

Exhibit 1310-5 Diamond Interchange With Advance Storage

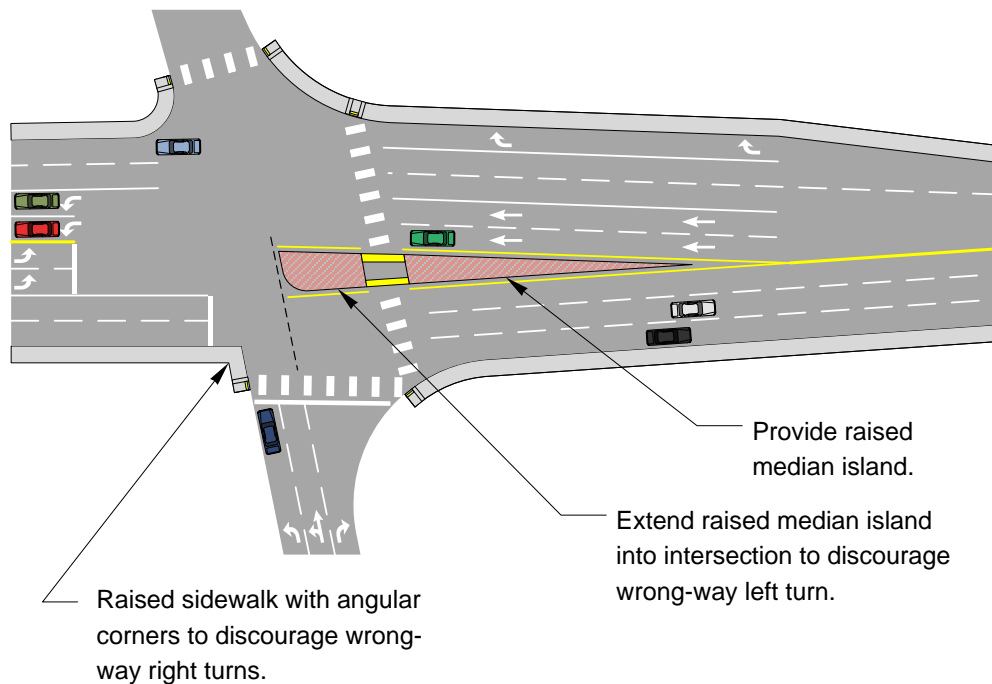
**1310.02(10)(4) Two-Way Ramps**

Two-way ramps have the on- and off-ramp adjacent to each other. They are used at partial cloverleaf, trumpet, and button hook interchanges. Because the on and off roadways are close to each other, they are more vulnerable to wrong-way driving. Also, when the separation between on and off traffic is striping only, the ramps are susceptible to drivers entering the correct roadway and inadvertently crossing to the wrong ramp. In addition to signing and delineation, the following are countermeasures for two-way ramps:

- Separate the on- and off-ramp terminals.
- Reduce off-ramp terminal throat width.
- Increase on-ramp terminal throat width.
- Maintain intersection balance.
- Improve on-ramp visibility.
- Provide a raised median or dual-faced curb from the ramp terminal intersection to the gore nose.

1310.02(10)(5) HOV Direct Access Ramps

HOV direct access ramps are two-way ramps in the median; therefore, the ability to provide separation between the on and off traffic is limited by the width of the median. An additional concern is that HOV direct access ramps are left-side ramps. Drivers normally enter the freeway using a right-side ramp and they may mistakenly travel the wrong way on

a left-side ramp. Review existing and proposed signing for inadvertent misdirection. (See [Chapter 1420](#) for HOV direct access and countermeasures for wrong-way driving at HOV direct access ramps.)

1310.02(10)(6) Multilane Divided Roadways

Wrong-way driving can also occur on multilane divided nonfreeway facilities. Wrong-way drivers may enter multilane divided facilities at driveways and at-grade intersections.

Countermeasures for wrong-way driving on nonfreeway multilane divided highways include:

- Wrong-way signing and delineation at the intersections.
- Right-in/right-out road approaches.

1310.03 Design Elements

When designing an intersection, identify and address the needs of all intersection users.

If pedestrian facilities are present, the design objective becomes one of reducing the potential for vehicle/pedestrian conflicts. This is done by minimizing pedestrian crossing distances and controlling the speeds of turning vehicles. Pedestrian refuge islands can be beneficial. They minimize the pedestrian crossing distance, reduce the conflict area, and minimize the impacts on vehicular traffic. When designing islands, speeds can be reduced by designing the turning roadway with a taper or large radius curve at the beginning of the turn and a small radius curve at the end. This allows larger islands while forcing the turning traffic to slow down. Use turn simulation software (such as AutoTURN[®]) to verify the design.

Channelization, the separation or regulation of traffic movements into delineated paths of travel, can facilitate the orderly movement of pedestrians, bicycles, and vehicles. Channelization includes left-turn lanes, right-turn lanes, speed change lanes (both acceleration and deceleration lanes), and islands.

1310.03(1) Right-Turn Corners

[Exhibit 1310-6](#) shows initial ranges for right-turn corner designs using a simple curve with a taper. These are considered approximate pavement areas to accommodate the design vehicles without encroachment on the adjacent lane at either leg of the curve.

Depending on the context of the roadway and right-turn corner (and whether the right-turn corner will be designed for or will accommodate a design vehicle), there may be several design considerations. Consider vehicle-pedestrian conflicts; vehicle encroachment on the shoulder or adjacent same-direction lane at the exit leg; capacity restrictions for right-turning vehicles or other degradation of intersection operations; and the effects on other traffic movements.

Other design considerations may include a combination of simple or compound curves, tapers at the beginning or end of the turn, and so on. Verify the design vehicle can make the turn using turn simulation software (such as AutoTURN[®]).

Exhibit 1310-6 Initial Ranges for Right-Turn Corner (Simple Curve-Taper)

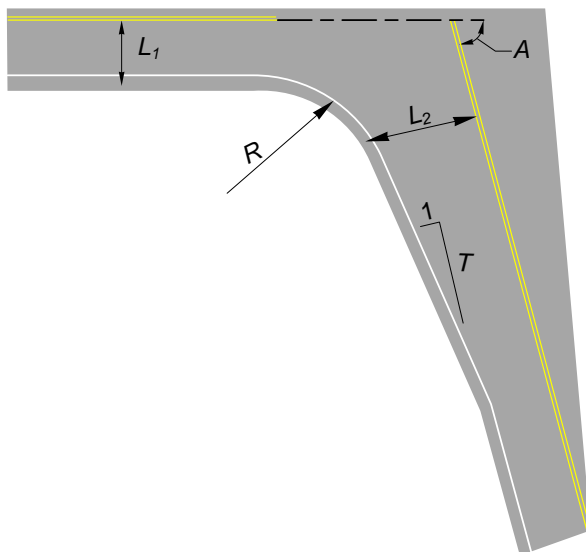

- L_1 = Available roadway width [2] that the vehicle is turning from
- L_2 = Available roadway width [2] for the vehicle leaving the intersection
- R = Radius to the edge of traveled way
- T = Taper rate (length per unit of width of widening)
- A = Delta angle of the turning vehicle

Vehicle	A	R	L_1 [1]	L_2 [2]	T
P	All	30	11	11	25
SU-30 & CITY-BUS	All	50	11	11	25
WB-40	All	55	11	15	7.5
WB-67	All	50-85	11	22-24	7

Notes:

- [1] When available roadway width is less than 11 ft, widen at 25:1.
- [2] Available roadway width includes the shoulder, less a 2-ft clearance to a curb, and all the same-direction lanes of the exit leg at signalized intersections.

General:

All distances given in feet and angles in degrees

1310.03(2) **Left-Turn Lanes and Turn Radii**

Left-turn lanes provide storage, separate from the through lanes, for left-turning vehicles waiting for a signal to change or for a gap in opposing traffic. (See [1310.03\(4\)](#) for a discussion on speed change lanes.)

Design left-turn channelization to provide sufficient operational flexibility to function under peak loads and adverse conditions.

1310.03(2)(a) **One-Way Left-Turn Lanes**

One-way left-turn lanes are separate storage lanes for vehicles turning left from one roadway onto another. One-way left-turn lanes may be an economical way to lessen delays and crash potential involving left-turning vehicles. In addition, they can allow deceleration clear of the through traffic lanes. Provide a minimum storage length of 100 feet for one-way left-turn lanes. When evaluating left-turn lanes, include impacts to all intersection movements and users.

At signalized intersections, use a traffic signal analysis to determine whether a left-turn lane is needed and the storage length. If the length determined is less than the 100-foot minimum, make it 100 feet (see [Chapter 1330](#)).

At unsignalized intersections, use the following as a guide to determine whether or not to provide one-way left-turn lanes:

- A traffic analysis indicates congestion reduction with a left-turn lane. On two-lane highways, use [Exhibit 1310-7a](#), based on total traffic volume (DHV) for both directions and percent left-turn traffic, to determine whether further investigation is needed. On four-lane highways, use [Exhibit 1310-7b](#) to determine whether a left-turn lane is recommended.
- A study indicates crash reduction with a left-turn lane.
- Restrictive geometrics require left-turning vehicles to slow greatly below the speed of the through traffic.
- There is less than decision sight distance for traffic approaching a vehicle stopped at the intersection to make a left turn.

A traffic analysis based on the *Highway Capacity Manual* (HCM) may also be used to determine whether left-turn lanes are needed to maintain the desired level of service.

Exhibit 1310-7a Left-Turn Storage Guidelines: Two-Lane, Unsignalized

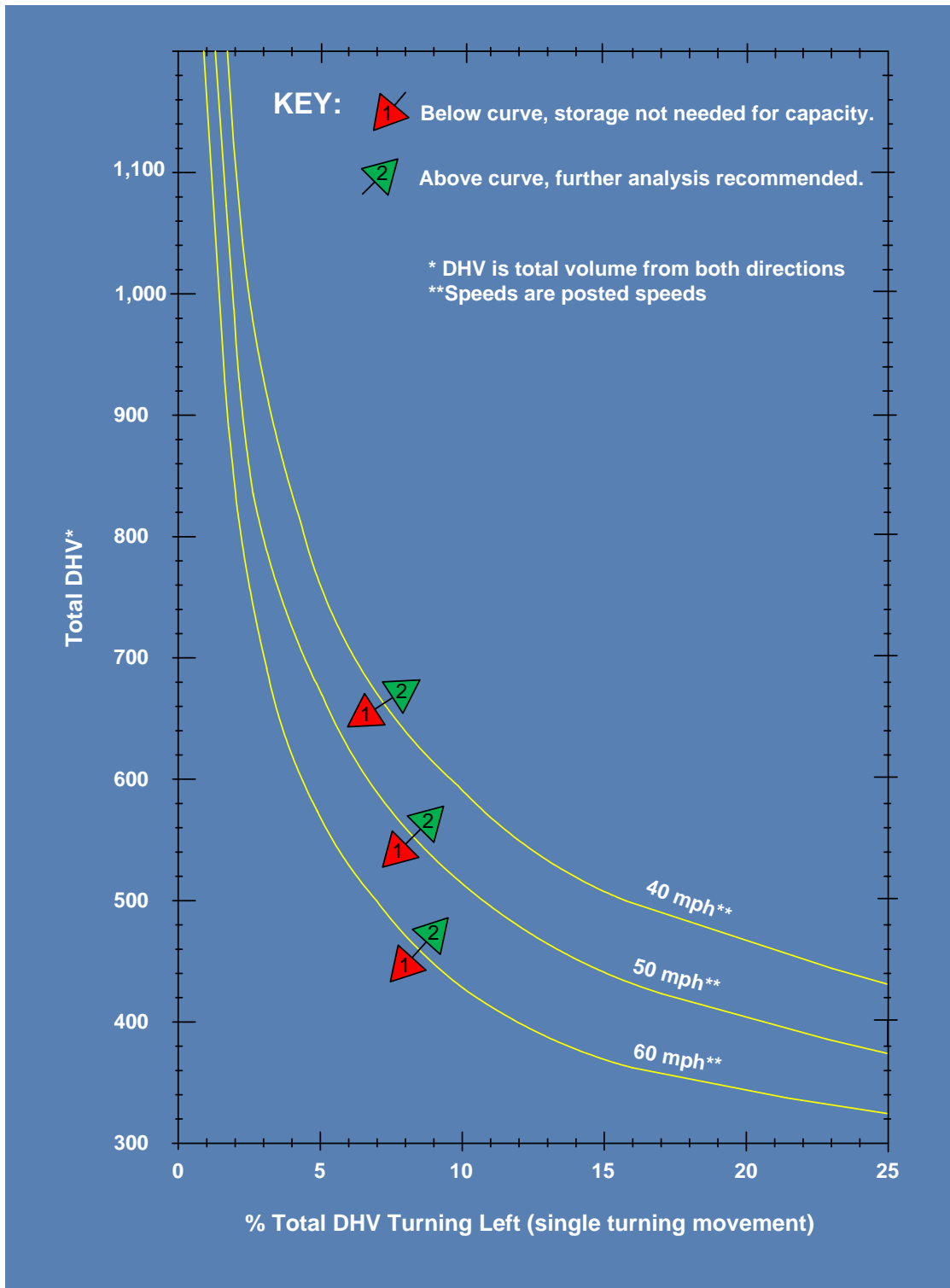
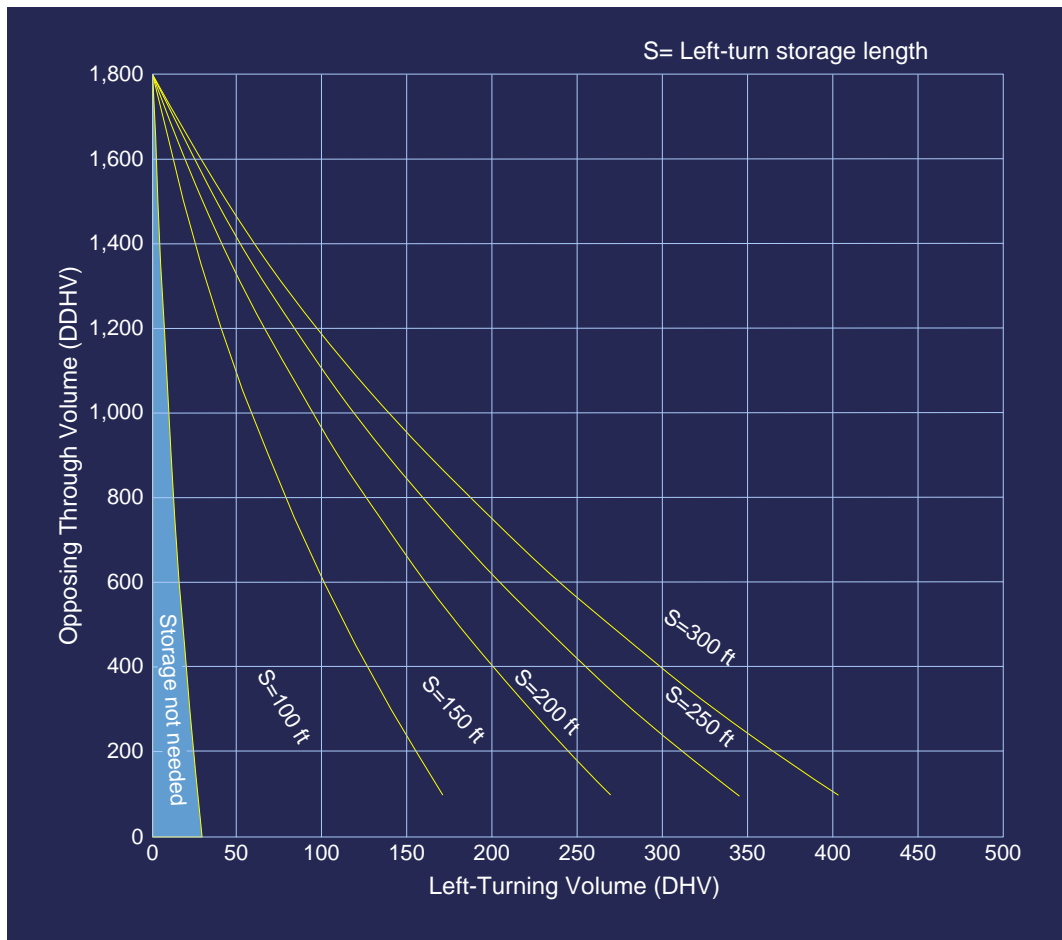

Exhibit 1310-7b Left-Turn Storage Guidelines: Four-Lane, Unsignalized



Determine the storage length on two-lane highways by using [Exhibits 1310-8a through 8c](#). On four-lane highways, use [Exhibit 1310-7b](#). These lengths do not consider trucks. Use [Exhibit 1310-9](#) for storage length when trucks are present.

Use turn simulation software (such as AutoTURN[®]) to verify that left-turn movements for the design vehicle(s) do not have conflicts. Design opposing left-turn design vehicle paths with a minimum 4-foot (12-foot desirable) clearance between opposing turning paths.

Where one-way left-turn channelization with curbing is to be provided, evaluate surface water runoff and design additional drainage facilities if needed to control the runoff.

Provide illumination at left-turn lanes in accordance with the guidelines in [Chapter 1040](#).

Exhibit 1310-8a Left-Turn Storage Length: Two-Lane, Unsignalized (40mph)

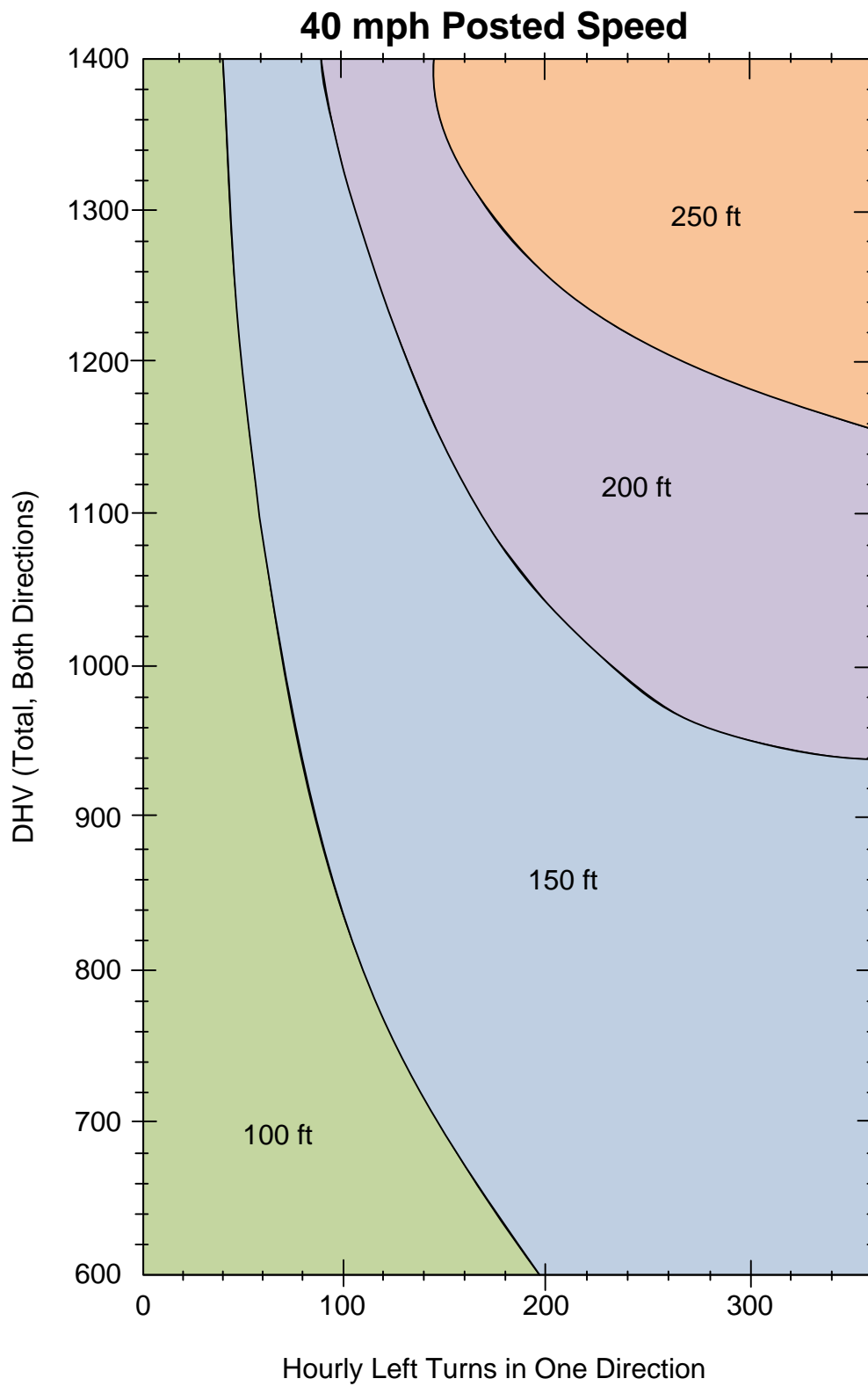

Exhibit 1310-8b Left-Turn Storage Length: Two-Lane, Unsignalized (50 mph)

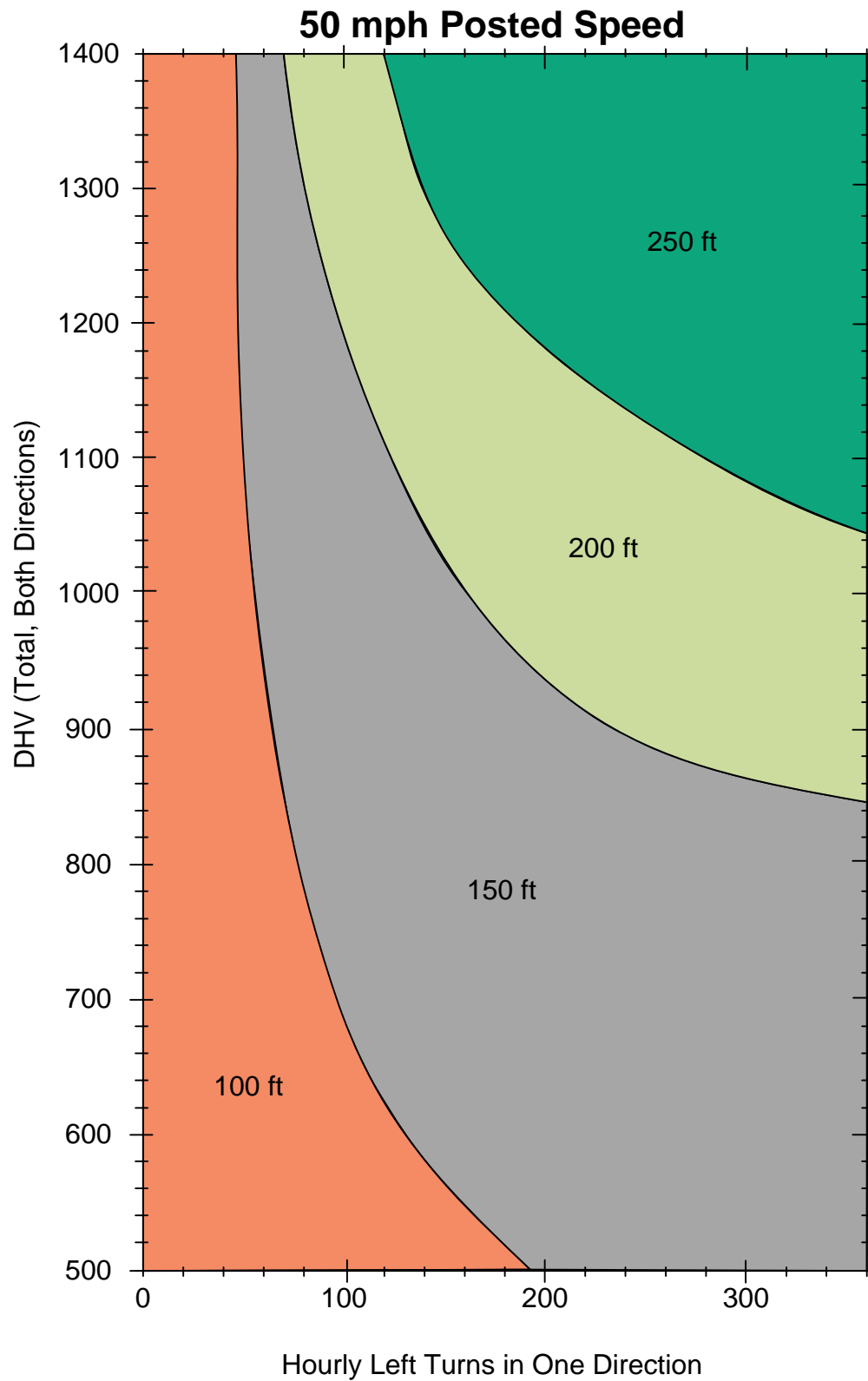

Exhibit 1310-8c Left-Turn Storage Length: Two-Lane, Unsignalized (60 mph)

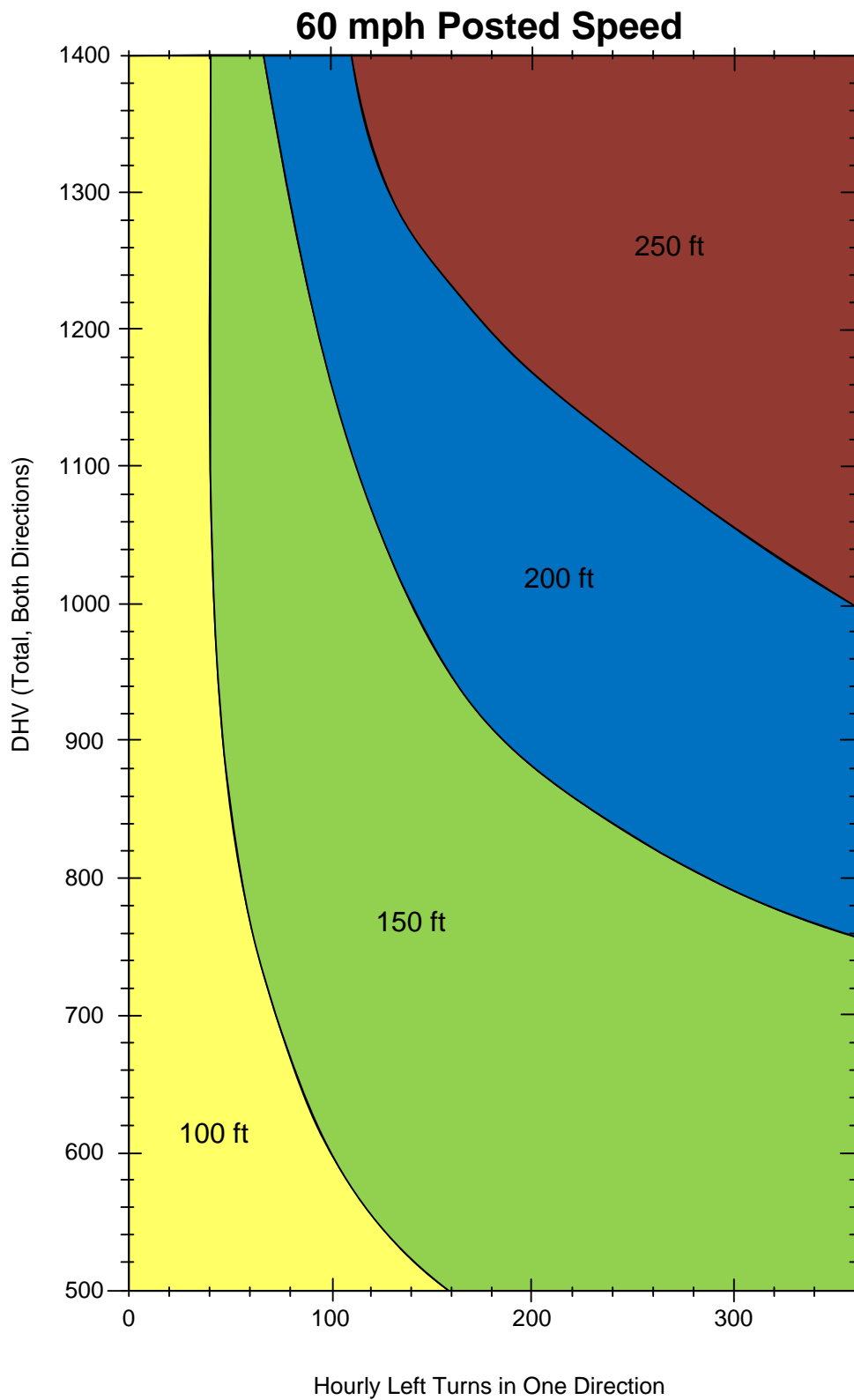

Exhibit 1310-9 Left-Turn Storage With Trucks (ft)

Storage Length* (ft)	% Trucks in Left-Turn Movement				
	10	20	30	40	50
100	125	125	150	150	150
150	175	200	200	200	200
200	225	250	275	300	300
250	275	300	325	350	375
300	350	375	400	400	400

*Length from Exhibits 1310-7b and 1310-8a, 8b, or 8c.

At signalized intersections with high left-turn volumes, double (or triple) left-turn lanes may be needed to maintain the desired level of service. For a double left-turn, a throat width of 30 to 36 feet is desirable on the exit leg of the turn to offset vehicle offtracking and the difficulty of two vehicles turning abreast. Use turn simulation software (such as AutoTURN®) to verify that the design vehicle can complete the turn. Where the design vehicle is a WB 40 or larger, it is desirable to provide for the design vehicle in the outside lane and an SU-30 vehicle turning abreast rather than two design vehicles turning abreast.

Exhibits 1310-10a through 10f show left-turn lane geometrics, which are described as follows:

1310.03(2)(a)(1) Widening

It is desirable that offsets and pavement widening (see Exhibit 1310-10a) be symmetrical about the centerline or baseline. Where right of way or topographic restrictions, crossroad alignments, or other circumstances preclude symmetrical widening, pavement widening may be on one side only.

1310.03(2)(a)(2) Divided Highways

Widening is not needed for left-turn lane channelization where medians are 11 feet wide or wider (see Exhibits 1310-10b through 10d). For medians between 13 feet and 23 feet or where the acceleration lane is not provided, it is desirable to design the left-turn lane adjacent to the opposing lane (see Exhibit 1310-10b) to improve sight distance and increase opposing left-turn clearances.

A median acceleration lane (see Exhibits 1310-10c and 10d) may be provided where the median is 23 feet or wider. The median acceleration lane might not be needed at a signalized intersection. When a median acceleration lane is to be used, design it in accordance with 1310.03(4), Speed Change Lanes. Where medians have sufficient width, provide a 2-foot shoulder adjacent to a left-turn lane.

1310.03(2)(a)(3) Minimum Protected Left Turn With a Median

At intersections on divided highways where channelized left-turn lanes are not provided, provide the minimum protected storage area (see Exhibit 1310-10e).

1310.03(2)(a)(4) Modifications to Left-Turn Designs

The left-turn lane designs discussed above and given in Exhibits 1310-10a through 10e may be modified when determined by design element dimensioning (see Chapter 1106.) Document the benefits and impacts of the modified design, including changes to vehicle-pedestrian conflicts; vehicle encroachment; deceleration length; capacity restrictions for turning vehicles or other degradation of intersection operations; and the effects on other traffic movements. Provide a modified design that is able to accommodate the design vehicle, and provide for the striping (see the Standard Plans and the MUTCD). Verify the design vehicle can make the turn using turn simulation software (such as AutoTURN®); include a plot of the design and verification.

Exhibit 1310-10a Median Channelization: Widening

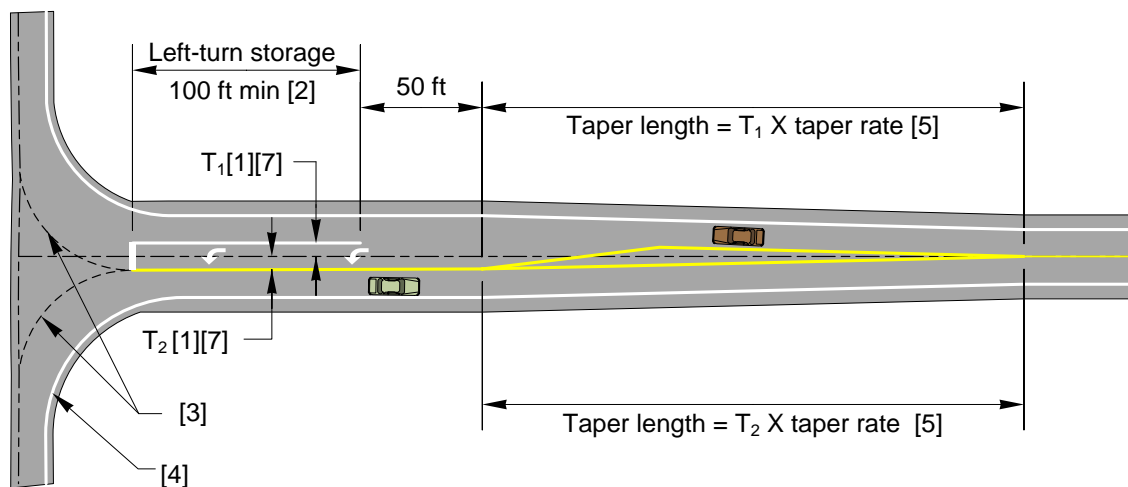

Notes:

- [1] The minimum width of the left-turn storage lane (T_1+T_2) is 11 ft.
- [2] For left-turn storage length, see Exhibits 1310-7b for 4-lane roadways or 1310-8a through 8c for 2-lane roadways.
- [3] Use turn simulation software (such as AutoTURN®) to verify the design vehicle can make the turn.
- [4] For right-turn corner design, see Exhibit 1310-6.
- [5] For desirable taper rates, see Table on this Exhibit. With justification, taper rates from the Table in Exhibit 1310-10c may be used.
- [6] For pavement marking details, see the Standard Plans and the MUTCD.
- [7] Where curb is provided, add the width of the curb and the shoulders to the left-turn lane width. For shoulder widths at curbs, see 1310.03(6) and Chapter 1230.

T_1 = Width of left-turn lane on approach side of centerline
 T_2 = Width of left-turn lane on departure side of centerline

Posted Speed	Desirable Taper Rate [6]
55 mph	55:1
50 mph	50:1
45 mph	45:1
40 mph	40:1
35 mph	35:1
30 mph	30:1
25 mph	25:1

Exhibit 1310-10b Median Channelization: Median Width 11 ft or More

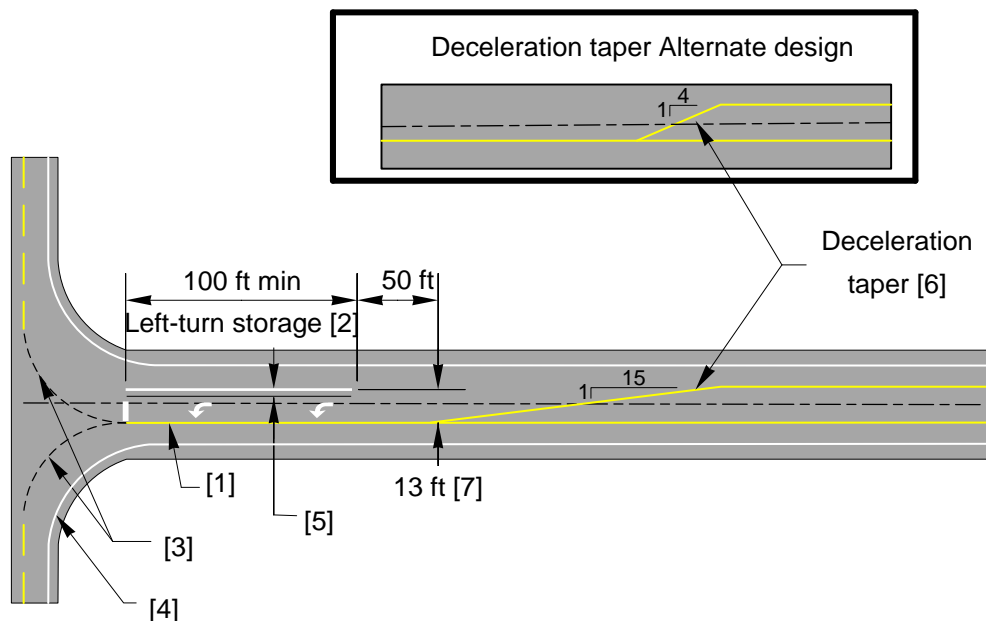
**Notes:**

- [1] Where curb is provided, add the width of the curb and the shoulders. For shoulder widths at curbs, see [1310.03\(6\)](#) and Chapter [1230](#).
- [2] For left-turn storage length, see Exhibits [1310-7b](#) for 4-lane roadways or [1310-8a](#) through [8c](#) for 2-lane roadways.
- [3] Verify the design vehicle can make the turn using turn simulation software (such as AutoTURN®).
- [4] For right-turn corner design, see [Exhibit 1310-6](#).
- [5] For median widths greater than 13 ft, it is desirable to locate the left-turn lane adjacent to the opposing through lane with excess median width between the same-direction through lane and the turn lane.
- [6] For increased storage capacity, the left-turn deceleration taper alternate design may be used.
- [7] Reduce to lane width for medians less than 13 ft wide.

General:

For pavement marking details, see the [Standard Plans](#) and the [MUTCD](#).

Exhibit 1310-10c Median Channelization: Median Width 23 ft to 26 ft

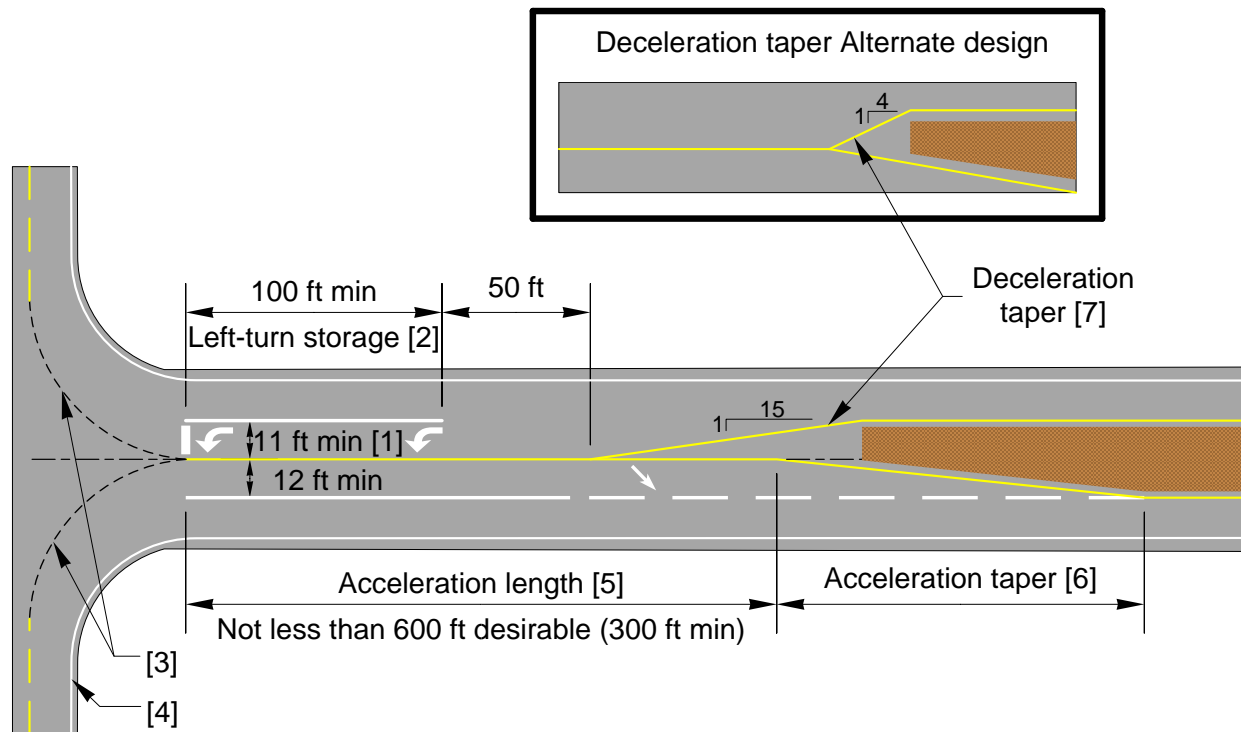

Notes:

- [1] When curb is provided, add the width of the curb.
- [2] For left-turn storage length, see Exhibits 1310 7b for 4-lane roadways or 1310-8a through 8c for 2-lane roadways.
- [3] Verify the design vehicle can make the turn using turn simulation software (such as AutoTURN®).
- [4] For right-turn corner design, see Exhibit 1310 6.
- [5] The minimum total length of the median acceleration lane is shown in Exhibit 1310-14.
- [6] For acceleration taper rate, see Table on this exhibit.
- [7] For increased storage capacity, the left-turn deceleration taper alternate design may be used.

Posted Speed	Taper Rate
55 mph	55:1
50 mph	50:1
45 mph	45:1
40 mph	27:1
35 mph	21:1
30 mph	15:1
25 mph	11:1

General:

For pavement marking details, see the *Standard Plans* and the *MUTCD*.

Exhibit 1310-10d Median Channelization: Median Width of More Than 26 ft

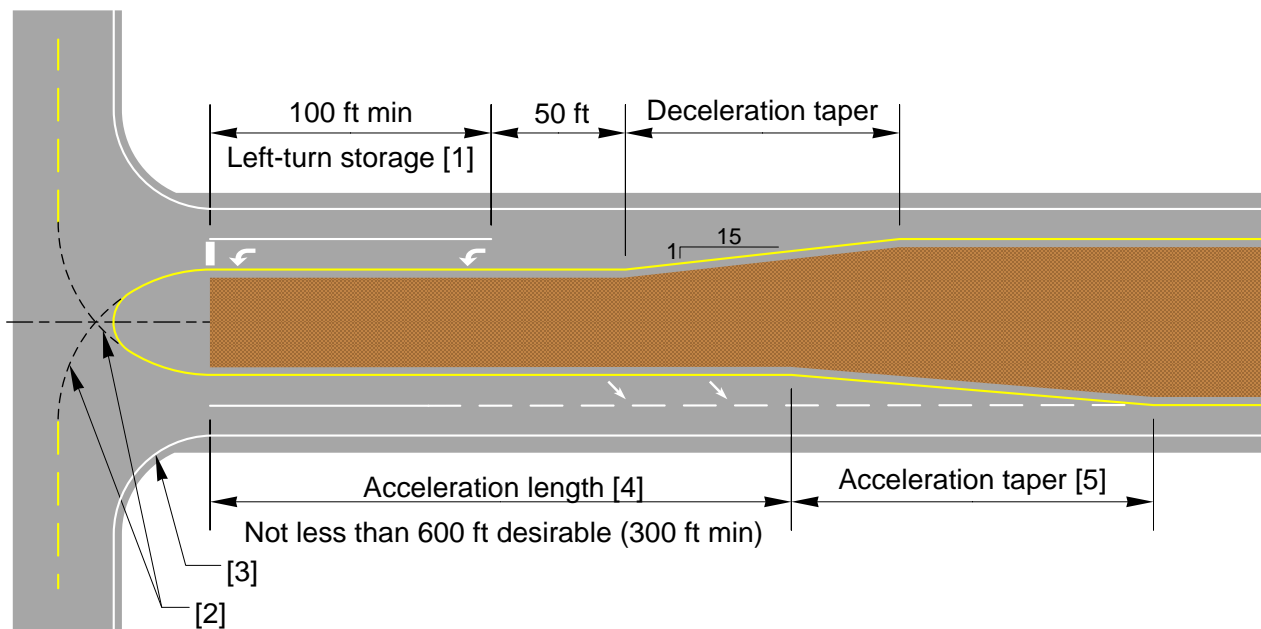
**Notes:**

- [1] For left-turn storage length, see Exhibits [1310-7b](#) for 4-lane roadways or [1310-8a](#) through [8c](#) for 2-lane roadways.
- [2] Verify the design vehicle can make the turn using turn simulation software (such as AutoTURN®).
- [3] For right-turn corner design, see [Exhibit 1310-6](#).
- [4] The minimum length of the median acceleration lane is shown in [Exhibit 1310-14](#).
- [5] For acceleration taper rate, see the Table on [Exhibit 1310-10c](#).

General:

For pavement marking details, see the [Standard Plans](#) and the [MUTCD](#).

Exhibit 1310-10e Median Channelization: Minimum Protected Storage

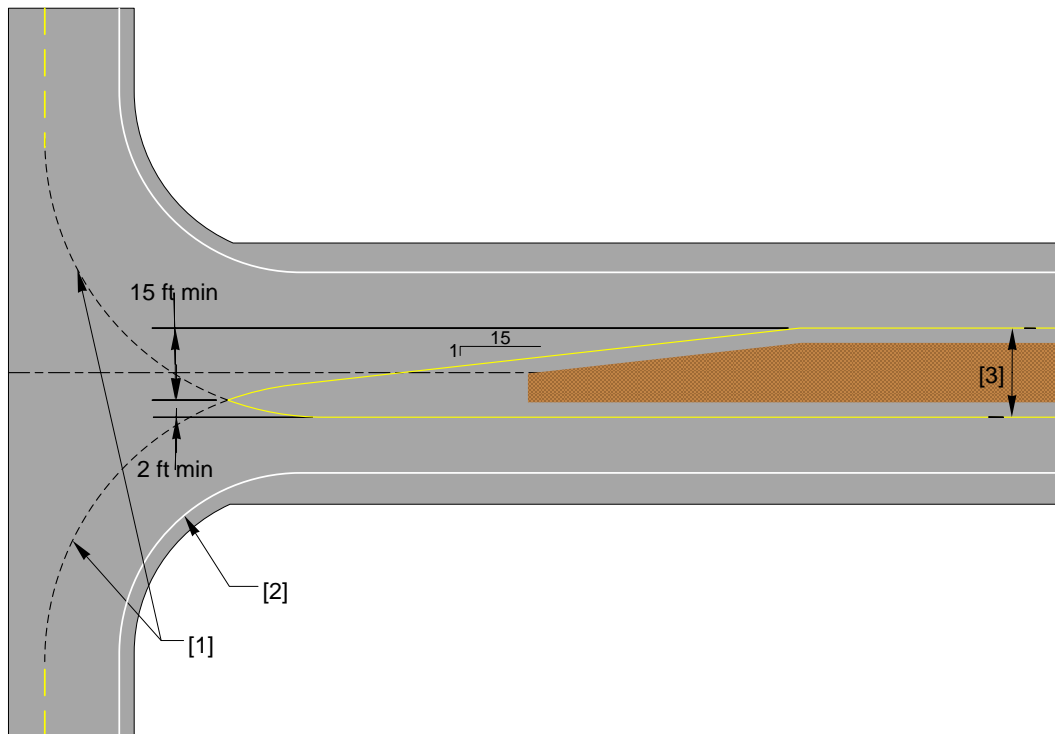
**Notes:**

- [1] Verify the design vehicle can make the turn using turn simulation software (such as AutoTURN®).
- [2] For right-turn corner design, see [Exhibit 1310-6](#).
- [3] For median width 17 ft or more. For median width less than 17 ft, widen to 17 ft. or use [Exhibit 1310-10b](#).

General:

For pavement marking details, see the [Standard Plans](#) and the [MUTCD](#).

1310.03(2)(b) Two-Way Left-Turn Lanes (TWLTL)

Two-way left-turn lanes are located between opposing lanes of traffic. They are used by vehicles making left turns from either direction, from or onto the roadway.

Use TWLTLs only on managed access highways where there are no more than two through lanes in each direction. Evaluate installation of TWLTLs where:

- A crash study indicates reduced crashes with a TWLTL.
- There are existing closely spaced access points or minor street intersections.
- There are unacceptable through traffic delays or capacity reductions because of left-turning vehicles.

TWLTs can reduce delays to through traffic, reduce rear-end crashes, and provide separation between opposing lanes of traffic. However, they do not provide refuge for pedestrians and can encourage strip development with additional closely spaced access points. Evaluate other alternatives (such as prohibiting midblock left turns and providing for U-turns) before using a TWLTL. (See [Chapter 540](#) for additional restrictions on the use of TWLTs, and [Chapter 1230](#) for discussion of road diets, which commonly employ a center turn lane.)

The basic design for a TWLTL is illustrated in [Exhibit 1310-10f](#). Additional criteria are as follows:

- The desirable length of a TWLTL is not less than 250 feet.
- Provide illumination in accordance with the guidelines in [Chapter 1040](#).
- Pavement markings, signs, and other traffic control devices must be in accordance with the [MUTCD](#) and the [Standard Plans](#).
- Provide clear channelization when changing from TWLTs to one-way left-turn lanes at an intersection.

Exhibit 1310-10f Median Channelization: Two-Way Left-Turn Lane

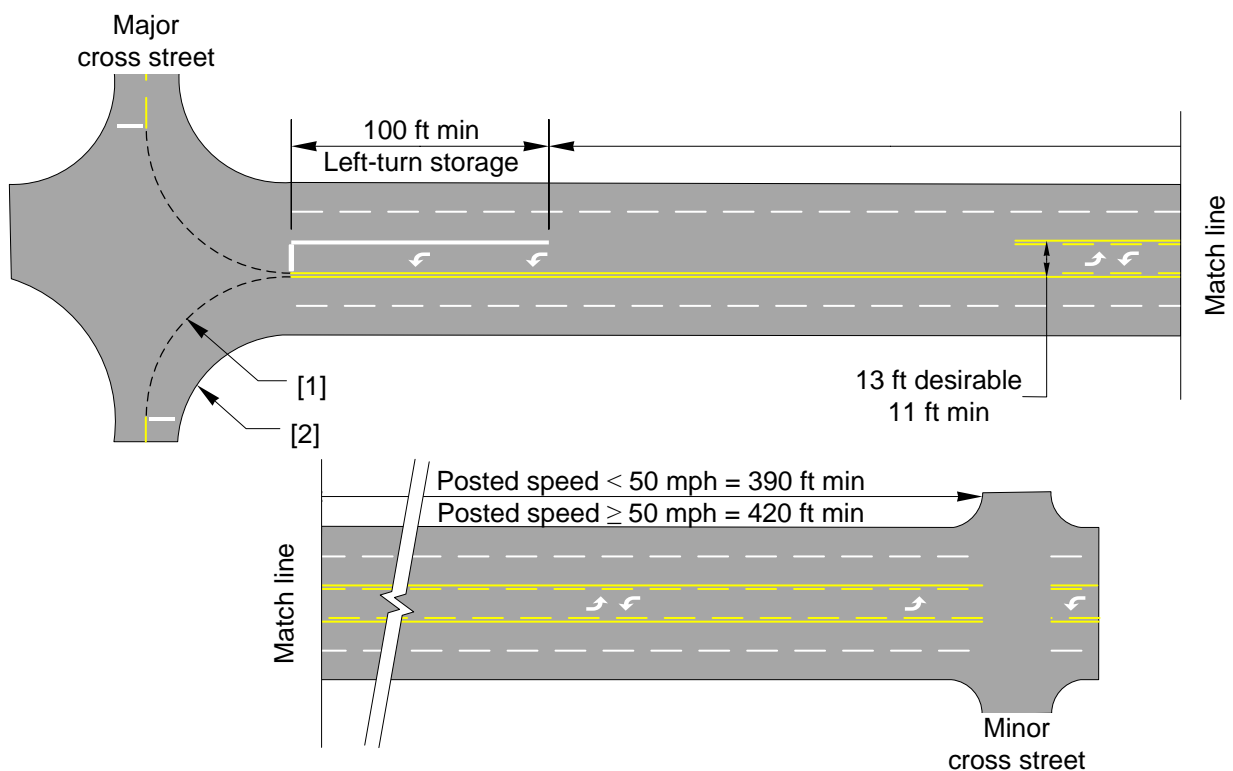

Notes:

- [1] Verify the design vehicle can make the turn using turn simulation software (such as AutoTURN®).
- [2] For right-turn corner design, see [Exhibit 1310-6](#).

General:

For pavement marking details and signing criteria, see the [Standard Plans](#) and the [MUTCD](#).

1310.03(3) *Right-Turn Lanes*

Right-turn movements influence intersection capacity even though there is no conflict between right-turning vehicles and opposing traffic. Right-turn lanes might be needed to maintain efficient intersection operation. Use the following to determine when to consider right-turn lanes at unsignalized intersections:

- For two-lane roadways and for multilane roadways with a posted speed of 45 mph or above, when recommended by [Exhibit 1310-11](#).
- A crash study indicates an overall crash reduction with a right-turn lane.
- The presence of pedestrians requires right-turning vehicles to stop.
- Restrictive geometrics require right-turning vehicles to slow greatly below the speed of the through traffic.
- There is less than decision sight distance for traffic approaching the intersection.
- For unsignalized intersections, see [1310.03\(4\)](#) for guidance on right-turn lane lengths. For signalized intersections, use a traffic signal analysis to determine whether a right-turn lane is needed and what the length is (see [Chapter 1330](#)).
- A capacity analysis may be used to determine whether right-turn lanes are needed to maintain the desired level of service.
- Where adequate right of way exists, providing right-turn lanes is relatively inexpensive and can provide increased operational efficiency.
- The right-turn pocket or the right-turn taper (see [Exhibit 1310-12](#)) may be used at any minor intersection where a right-turn lane is not provided. These designs reduce interference and delay to the through movement by offering an earlier exit to right-turning vehicles.
- If the right-turn pocket is used, [Exhibit 1310-12](#) shows taper lengths for various posted speeds.

Exhibit 1310-11 Right-Turn Lane Guidelines

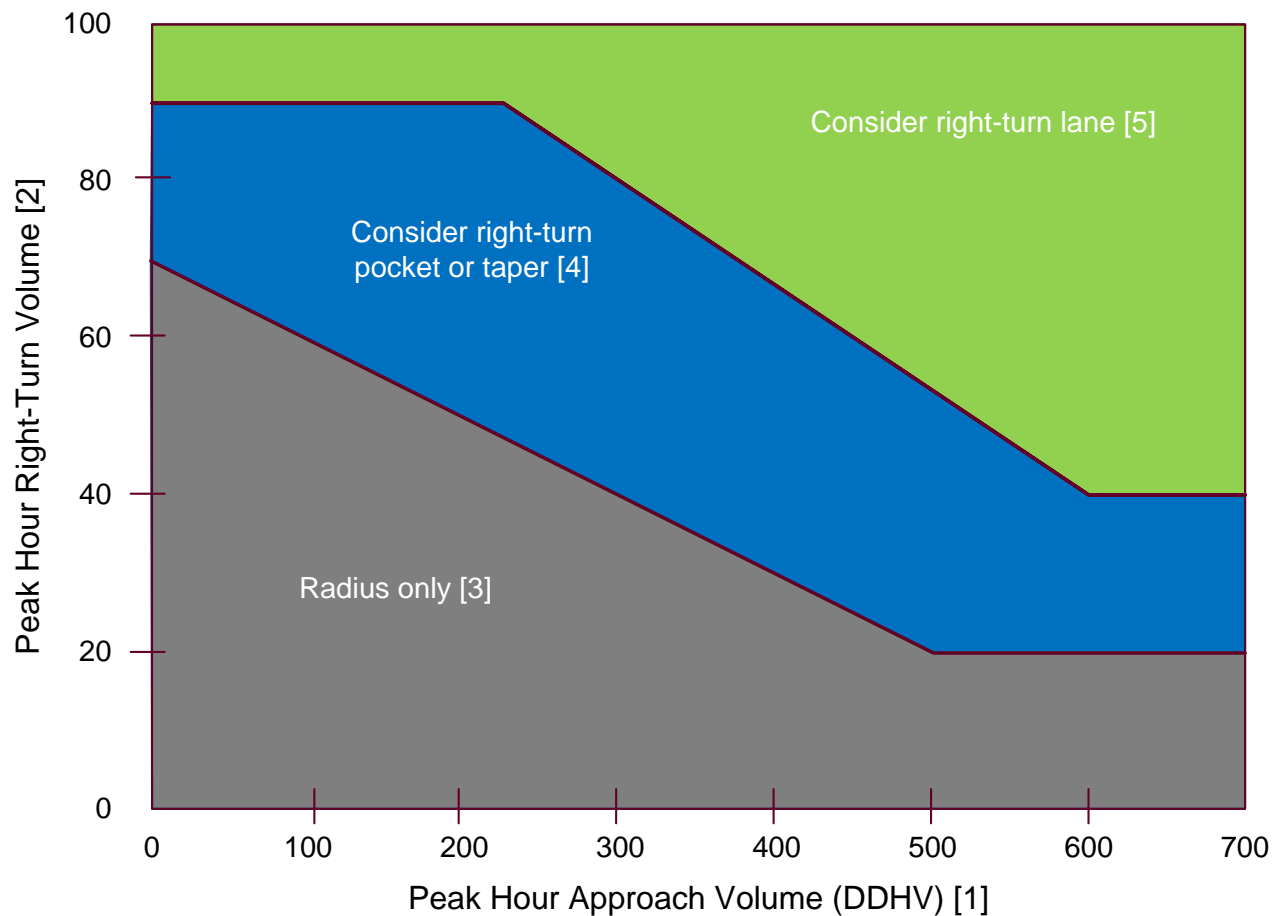
**Notes:**

- [1] For two-lane highways, use the peak hour DDHV (through + right-turn).
For multilane, high-speed highways (posted speed 45 mph or above), use the right-lane peak hour approach volume (through + right-turn).
- [2] When all three of the following conditions are met, reduce the right-turn DDHV by 20:
- The posted speed is 45 mph or below
 - The right-turn volume is greater than 40 VPH
 - The peak hour approach volume (DDHV) is less than 300 VPH
- [3] For right-turn corner design, see [Exhibit 1310-6](#).
- [4] For right-turn pocket or taper design, see [Exhibit 1310-12](#).
- [5] For right-turn lane design, see [Exhibit 1310-13](#).

Exhibit 1310-12 Right-Turn Pocket and Right-Turn Taper

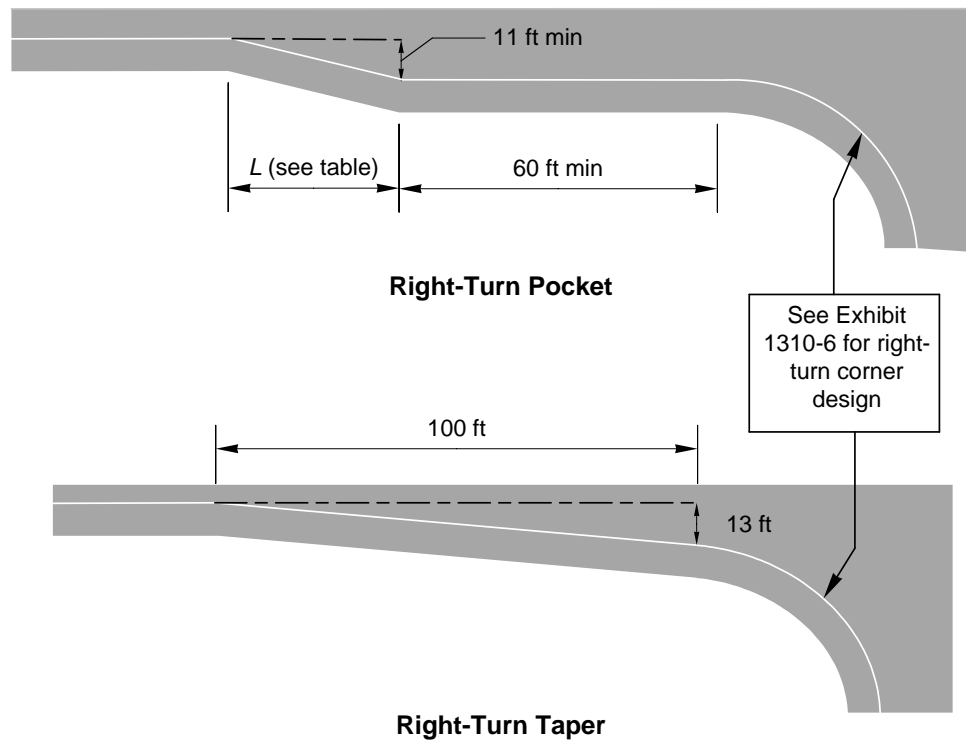

Posted Speed Limit	L
Below 40 mph	40 ft
40 mph or above	100 ft

1310.03(4) Speed Change Lanes

A speed change lane is an auxiliary lane primarily for the acceleration or deceleration of vehicles entering or leaving the through traveled way. Speed change lanes are normally provided for at-grade intersections on multilane divided highways with access control. Where roadside conditions and right of way allow, speed change lanes may be provided on other through roadways. Justification for a speed change lane depends on many factors, including speed; traffic volumes; capacity; type of highway; design and frequency of intersections and crash history

When either deceleration or acceleration lanes are to be used, design them in accordance with Exhibits 1310-13 and 1310-14. When the design speed of the turning traffic is greater than 20 mph, design the speed change lane as a ramp in accordance with Chapter 1360. When a deceleration lane is used with a left-turn lane, add the deceleration length to the storage length.

A dedicated deceleration lane (see Exhibit 1310-13) is advantageous because it removes slowing vehicles from the through lane.

An acceleration lane (see Exhibit 1310-14) is not as advantageous because entering drivers can wait for an opportunity to merge without disrupting through traffic. However, acceleration lanes for left-turning vehicles provide a benefit by allowing the turn to be made in two movements.

Exhibit 1310-13 Right-Turn Lane

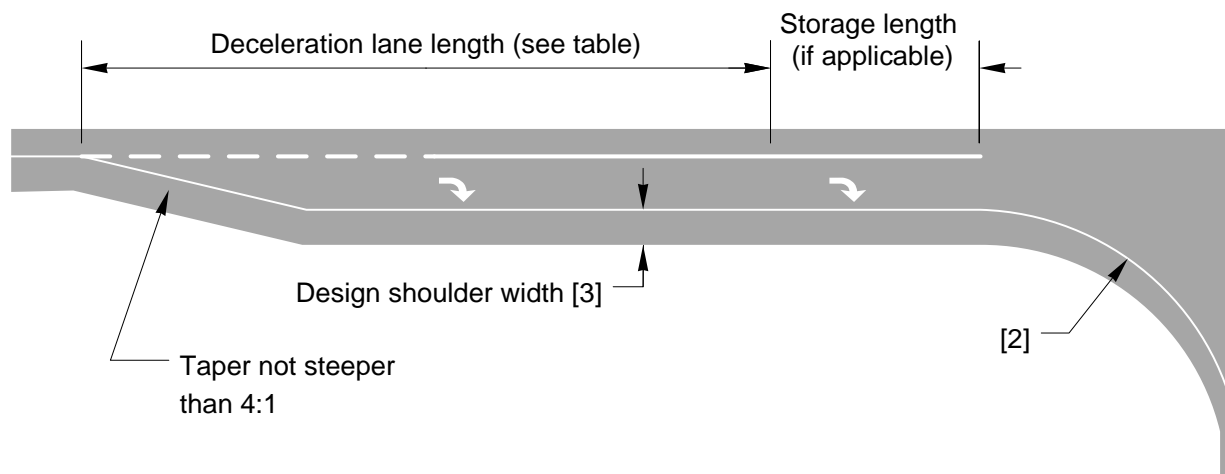

Highway Design Speed (mph)	Deceleration Lane Length (ft)
30	160 [1]
35	220
40	275
45	350
50	425
55	515
60	605
65	715
70	820

Minimum Deceleration Lane Length (ft)

Grade	Upgrade	Downgrade
3% to less than 5%	0.9	1.2
5% or more	0.8	1.35

Adjustment Multiplier for Grades 3% or Greater

Notes:

- [1] When adjusting for grade, do not reduce the deceleration lane to less than 150 ft.
- [2] For right-turn corner design, see [Exhibit 1310-6](#).
- [3] See [1310.03\(6\)](#) and [Chapter 1230](#).

General:

For pavement marking details, see the [Standard Plans](#) and the [MUTCD](#).

Exhibit 1310-14 Acceleration Lane

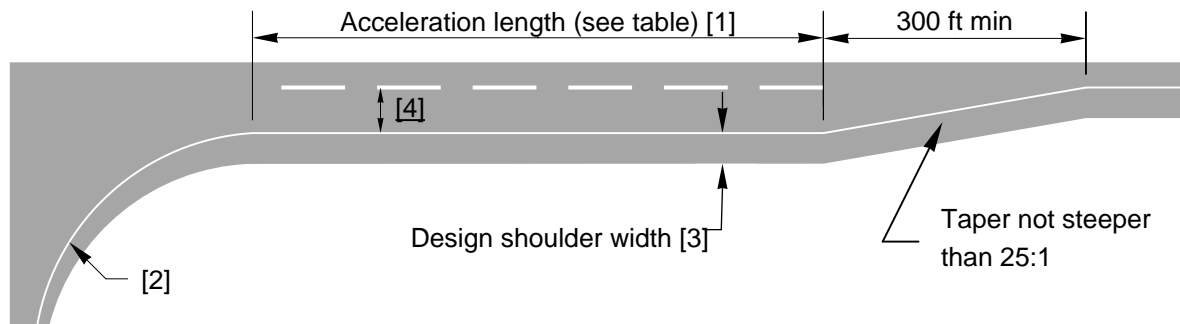

Highway Design Speed (mph)	Turning Roadway Design Speed (mph)		
	Stop	15	20
30	180	140	
35	280	220	160
40	360	300	270
45	560	490	440
50	720	660	610
55	960	900	810
60	1,200	1,140	1,100
65	1,410	1,350	1,310
70	1,620	1,560	1,520

Minimum Acceleration Length (ft) [1]

Highway Design Speed (mph)	% Grade	Upgrade	Downgrade
40	3% to less than 5%	1.3	0.7
50		1.3	0.65
60		1.4	0.6
70		1.5	0.6
40	5% or more	1.5	0.6
50		1.5	0.55
60		1.7	0.5
70		2.0	0.5

Adjustment Multiplier for Grades 3% or Greater

Notes:

- [1] At free right turns (no stop required) and all left turns, the minimum acceleration lane length is not less than 300 ft.
- [2] For right-turn corner design, see [Exhibit 1310-6](#).
- [3] See [1310.03\(6\)](#) and [Chapter 1230](#).
- [4] Lane width as determined by Chapters [1106](#) and [1230](#).

General:

For pavement-marking details, see the [Standard Plans](#) and the [MUTCD](#).

1310.03(5) Drop Lanes

A lane may be dropped at an intersection with a turn-only lane or beyond the intersection. Do not allow a lane-reduction taper to cross an intersection or end less than 100 feet before an intersection. (See [Chapter 1210](#) for lane reduction pavement transitions.)

When a lane is dropped beyond signalized intersections, provide a lane of sufficient length to allow smooth merging. For facilities with a posted speed of 45 mph or higher, use a minimum length of 1,500 feet. For facilities with a posted speed lower than 45 mph, provide a lane of sufficient length that the advanced lane reduction warning sign can be placed not less than 100 feet beyond the intersection area.

When a lane is dropped beyond unsignalized intersections, provide a lane beyond the intersection not less than the acceleration lane length from [Exhibit 1310-14](#).

1310.03(6) Shoulders

Shoulder width is controlled by its intended functional use and its contribution to achieving the desired safety performance when balanced with other design elements. See [Chapter 1230](#) for functional uses and recommended shoulder widths.

Reducing the shoulder width at intersections facilitates the installation of turn lanes without unduly affecting the overall width of the roadway. A narrower roadway also reduces pedestrian exposure in crosswalks and discourages motorists from using the shoulder to bypass other turning traffic.

1310.03(7) Islands

An island is a defined area within an intersection between traffic lanes for the separation of vehicle movements or for pedestrian refuge. Within an intersection, a median is considered an island. Design islands to clearly delineate the traffic channels to drivers and pedestrians.

Traffic islands perform the following functions:

- Channelization islands control and direct traffic movements.
- Divisional islands separate traffic movements.
- Refuge islands provide refuge for pedestrians and bicyclists crossing the roadway.
- Islands can provide for the placement of traffic control devices and luminaires.
- Islands can provide areas within the roadway for landscaping.

1310.03(7)(a) Size and Shape

Divisional islands are normally elongated and at least 4 feet wide and 20 feet long.

Channelization islands are normally triangular. In rural areas, 75 ft² is the minimum island area and 100 ft² is desirable. In urban areas where posted speeds are 25 mph or below, smaller islands are acceptable. Use islands with at least 200 ft² if pedestrians will be crossing or traffic control devices or luminaires will be installed.

Design triangular-shaped islands as shown in Exhibits [1310-15a](#) through [15c](#). The shoulder and offset widths illustrated are for islands with vertical curbs 6 inches or higher. Where painted islands are used, such as in rural areas, these widths are desirable but may be omitted. (See [Chapter 1240](#) for desirable turning roadway widths.)

Island markings may be supplemented with reflective raised pavement markers.

Provide barrier-free access at crosswalk locations where raised islands are used. For pedestrian refuge islands and barrier-free access requirements, see [Chapter 1510](#).

1310.03(7)(b) Location

Design the approach ends of islands so they are visible to motorists. Position the island so that a smooth transition in vehicle speed and direction is attained. Begin transverse lane shifts far enough in advance of the intersection to allow gradual transitions. Avoid introducing islands on a horizontal or vertical curve. If the use of an island on a curve cannot be avoided, provide sight distance, illumination, or extension of the island.

Exhibit 1310-15a Traffic Island Designs

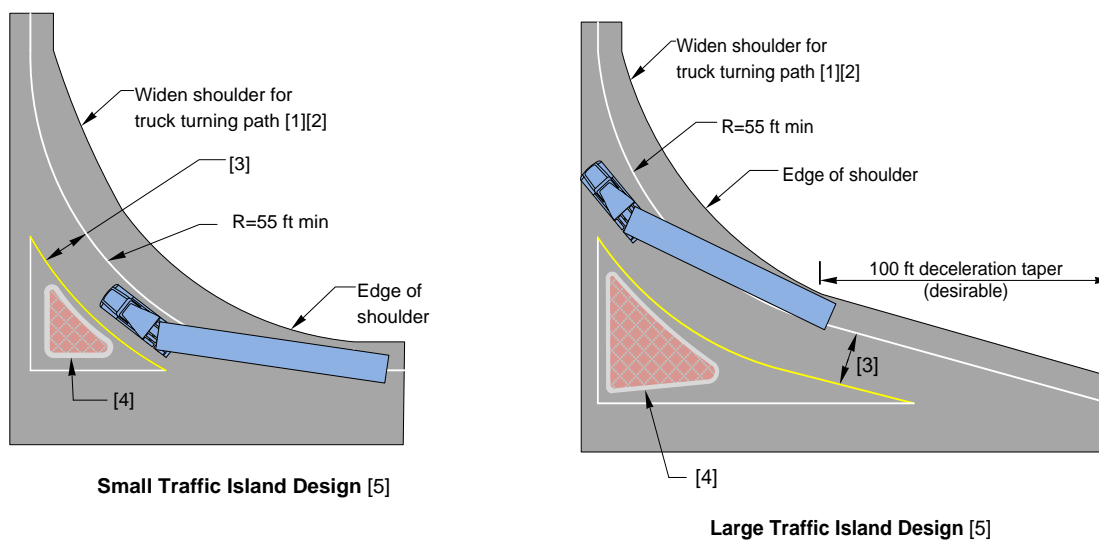

Notes:

- [1] Widen shoulders when right-turn radii or roadway width cannot be provided for large trucks. Design widened shoulder pavement the same depth as the right-turn lane.
- [2] Use turn simulation software (such as AutoTURN[®]) for the intersection design vehicle
- [3] For turning roadway widths, see [Chapter 1240](#).
- [4] For additional details on island placement, see [Exhibit 1310-15c](#).
- [5] Small traffic islands have an area of 100 ft² or less; large traffic islands have an area greater than 100 ft².

General:

- Provide an accessible route for pedestrians (see [Chapter 1510](#)).
- 60° to 90° angle at stop or yield control.
- For right-turn corner design, see [Exhibit 1310-6](#).

1310.03(7)(c) Compound Right-Turn Lane

To design large islands, the common method is to use a large-radius curve for the turning traffic. While this does provide a larger island, it also encourages higher turning speeds. Where pedestrians are a concern, higher turning speeds are undesirable. An alternative is a compound curve with a large radius followed by a small radius (see [Exhibit 1310-15b](#)). This design forces the turning traffic to slow down.

Exhibit 1310-15b Traffic Island Designs: Compound Curve

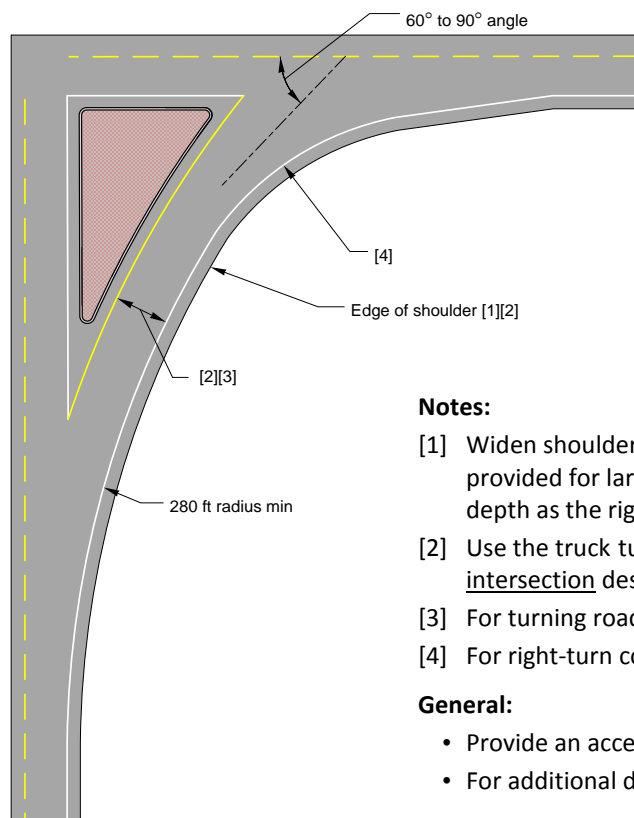

Notes:

- [1] Widen shoulders when right-turn radii and roadway width cannot be provided for large trucks. Design widened shoulder pavement the same depth as the right-turn lane.
- [2] Use the truck turn simulation software (such as AutoTURN®) for the [intersection](#) design vehicle.
- [3] For turning roadway widths, see [Chapter 1240](#).
- [4] For right-turn corner design, see [Exhibit 1310-6](#).

General:

- Provide an accessible route for pedestrians (see [Chapter 1510](#)).
- For additional details on island placement, see [Exhibit 1310-15c](#).

1310.03(7)(d) Curbing

Provide vertical curb 6 inches or higher for:

- Islands with luminaires, signals, or other traffic control devices.
- Pedestrian refuge islands.

Also consider curbing for:

- Divisional and channelizing islands.
- Landscaped islands.
- Stormwater conveyance.

In general, except to meet one of the uses listed above, it is desirable not to use curbs on facilities with a posted speed of 45 mph or above.

Avoid using curbs if the same objective can be attained with pavement markings.

Refer to [Chapter 1230](#) for additional information and design criteria on the use of curbs.

Exhibit 1310-15c Traffic Island Designs

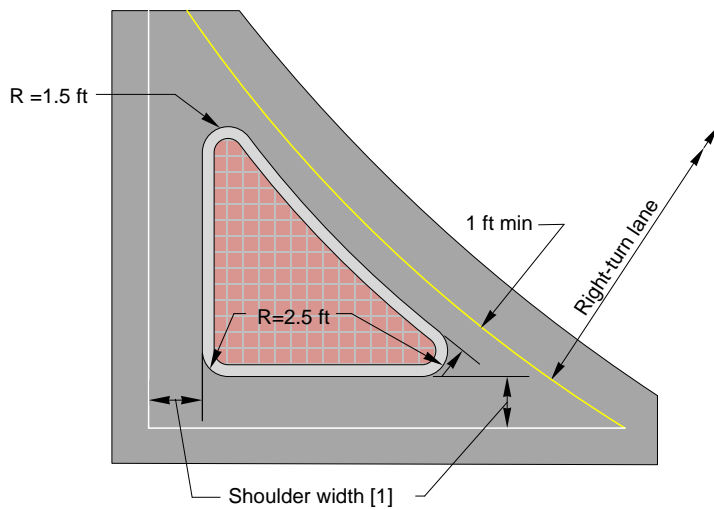

Small Raised Traffic Island [2]

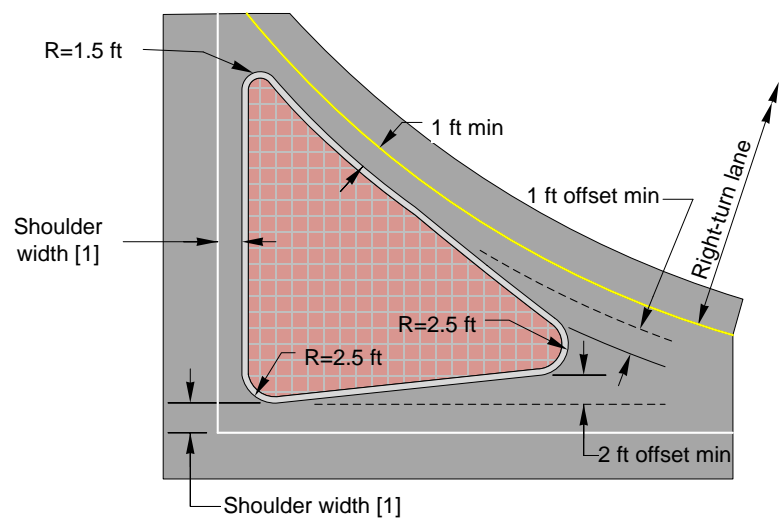

Large Raised Traffic Island [2]

Notes:

[1] For shoulder width at curbs, see [Chapter 1230](#). For additional information on shoulders at turn lanes, see [1310.03\(6\)](#).

[2] Small traffic islands have an area of 100 ft² or less; large traffic islands have an area greater than 100 ft².

General:

Provide an accessible route for pedestrians (see [Chapter 1510](#)).

1310.04 U-Turns

For divided multilane highways without full access control that have access points where the median prevents left turns, evaluate the demand for locations that allow U turns. Normally, U turn opportunities are provided at intersections. However, where intersections are spaced far apart, U-turn median openings may be provided between intersections to accommodate U-turns. Use the desirable U-turn spacing (see [Exhibit 1310-16](#)) as a guide to determine when to provide U-turn median openings between intersections. Where the U-turning volumes are low, longer spacing may be used.

Locate U-turn median openings where intersection sight distance can be provided.

Exhibit 1310-16 U-Turn Spacing

Urban/Rural	Desirable	Minimum
Urban [1]	1,000 ft	[2]
Suburban	½ mile	¼ mile [3]
Rural	1 mile	½ mile

Notes:

[1] For design speeds higher than 45 mph, use suburban spacing.

[2] The minimum spacing is the acceleration lane length from a stop (see [Exhibit 1310-14](#)) plus 300 ft.

[3] For design speeds 60 mph or higher, the minimum spacing is the acceleration lane length from a stop (see [Exhibit 1310-14](#)) plus 300 ft.

When designing U-turn median openings, use [Exhibit 1310-18](#) as a guide. Where the median is less than 40 feet wide, with a large design vehicle, provide a U-turn roadway (see [Exhibit 1310-17](#)). Design A, with the U-turn roadway after the left-turn, is desirable. Use Design A when the median can accommodate a left-turn lane. Use Design B only where left-turn channelization cannot be built in the median.

Exhibit 1310-17 U-Turn Roadway

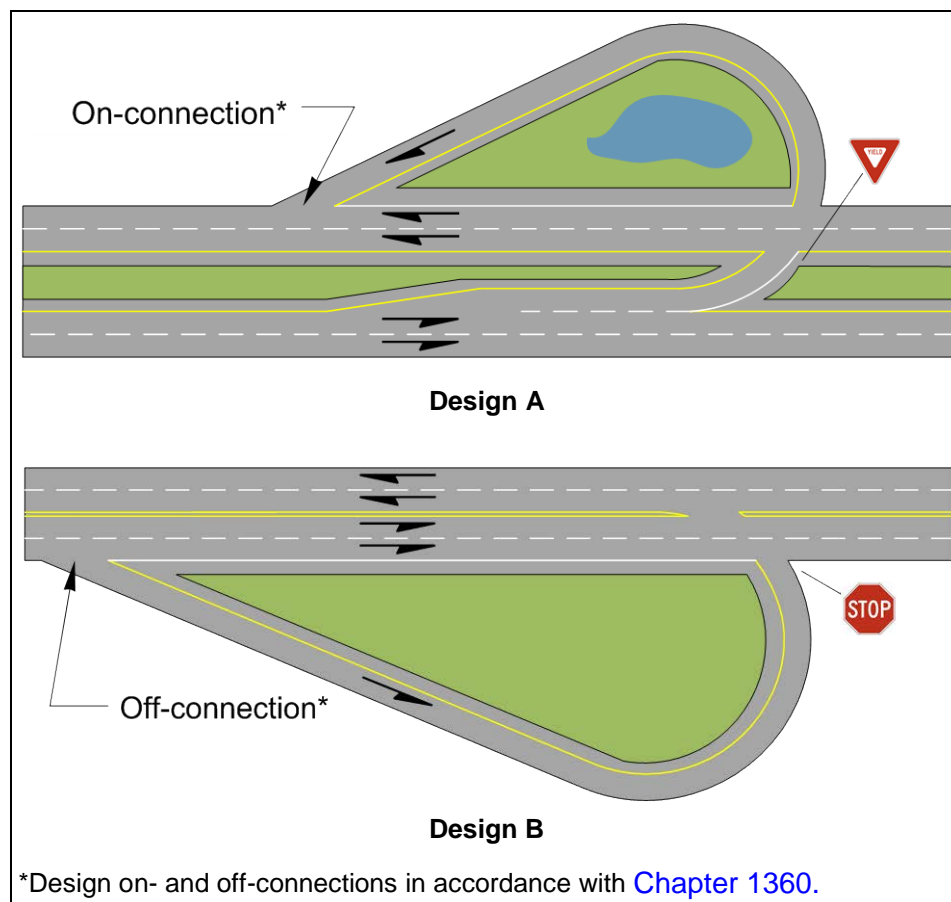

Document the need for U-turn locations, the spacing used, and the selected design vehicle. If the design vehicle is smaller than the largest vehicle using the facility, provide an alternate route.

U-turns at signal-controlled intersections do not need the acceleration lanes shown in [Exhibit 1310-18](#). For new U-turn locations at signal-controlled intersections, evaluate conflicts between right-turning vehicles from side streets and U-turning vehicles. Warning signs on the cross street might be appropriate.

Exhibit 1310-18 U-Turn Median Openings

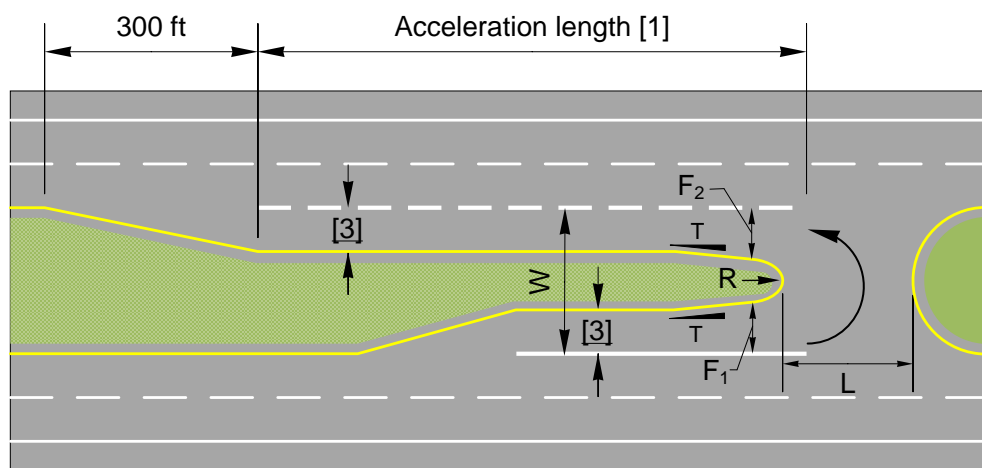
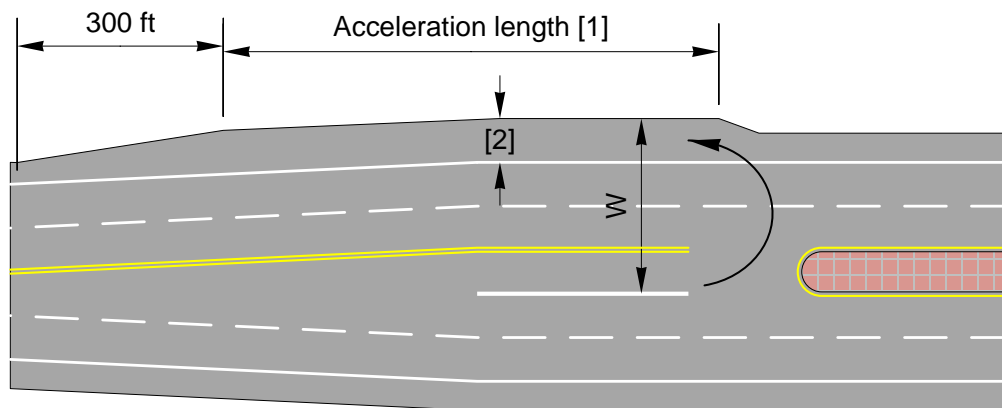

Vehicle	W	R	L	F ₁	F ₂	T
P	52	14	14	12	12	—
SU-30	87	30	20	13	15	10:1
CITY-BUS	87	28	23	14	18	10:1
WB-40	84	25	27	15	20	6:1
WB-67	94	22	49	15	35	6:1

U-Turn Design Dimensions

Notes:

- [1] The minimum length of the acceleration lane is shown in [Exhibit 1310-14](#). Acceleration lane may be eliminated at signal-controlled intersections.
- [2] When U-turn uses the shoulder, provide shoulder width sufficient for the intersection design vehicle to make the turn and shoulder pavement designed to the same depth as the through lanes for the acceleration length and taper.
- [3] Lane width as determined by Chapters [1106](#) and [1230](#).

General:

All dimensions are in feet.

1310.05 Intersection Sight Distance

Providing drivers the ability to see stop signs, traffic signals, and oncoming traffic in time to react accordingly will reduce the probability of conflicts occurring at an intersection. Actually avoiding conflicts is dependent on the judgment, abilities, and actions of all drivers using the intersection.

The driver of a vehicle that is stopped and waiting to cross or enter a through roadway needs obstruction-free sight triangles in order to see enough of the through roadway to complete all legal maneuvers before an approaching vehicle on the through roadway can reach the intersection. Use [Exhibit 1310-19a](#) to determine minimum intersection sight distance along the through roadway.

The sight triangle is determined as shown in [Exhibit 1310-19b](#). Within the sight triangle, lay back the cut slopes and remove, lower, or move hedges, trees, signs, utility poles, signal poles, and anything else large enough to be a sight obstruction. Eliminate parking to remove obstructions to sight distance. In order to maintain the sight distance, the sight triangle must be within the right of way or a state maintenance easement (see [Chapter 510](#)).

The setback distance for the sight triangle is 18 feet from the edge of traveled way. This is for a vehicle stopped 10 feet from the edge of traveled way. The driver is almost always 8 feet or less from the front of the vehicle; therefore, 8 feet are added to the setback. When the stop bar is placed more than 10 feet from the edge of traveled way, providing the sight triangle to a point 8 feet back of the stop bar is desirable.

Provide a clear sight triangle for a P vehicle at all intersections. In addition, provide a clear sight triangle for the SU-30 vehicle for rural highway conditions. If there is significant combination truck traffic, use the WB-67 rather than the SU-30. In areas where SU-30 or WB vehicles are minimal and right of way restrictions limit sight triangle clearing, only the P vehicle sight distance needs to be provided.

At existing intersections, when sight obstructions within the sight triangle cannot be removed due to limited right of way, the intersection sight distance may be modified. Drivers who do not have the desired sight distance creep out until the sight distance is available; therefore, the setback may be reduced to 10 feet. Document the right of way width and provide a brief analysis of the intersection sight distance clarifying the reasons for reduction. Verify and document that there is no identified crash trend at the intersection. Document the intersection location and the available sight distance in the Design Variance Inventory (see [Chapter 300](#)) as a design deviation.

If the intersection sight distance cannot be provided using the reductions in the preceding paragraph, where stopping sight distance is provided for the major roadway, the intersection sight distance, at the 10-foot setback point, may be reduced to the stopping sight distance for the major roadway, with an evaluate upgrade and HQ Design Office review and concurrence. (See [Chapter 1260](#) for required stopping sight distance.) Document the right of way width and provide a brief analysis of the intersection sight distance clarifying the reasons for reduction. Verify and document that there is no identified crash trend at the intersection. Document the intersection location and the available sight distance in the Design Variance Inventory (see [Chapter 300](#)) as a design deviation.

In some instances, intersection sight distance is provided at the time of construction, but subsequent vegetative growth has degraded the sight distance available. The growth may be seasonal or occur over time. In these instances, intersection sight distance can be restored through the periodically scheduled maintenance of vegetation in the sight triangle within the WSDOT right of way or state maintenance easement.

At intersections controlled by traffic signals, provide sight distance for right-turning vehicles. For intersections controlled by the geometry of roundabouts, see [Chapter 1320](#).

Designs for movements that cross divided highways are influenced by median widths. If the median is wide enough to store the design vehicle, with a 3-foot clearance at both ends of the vehicle, sight distances are determined in two steps. The first step is for crossing from a stopped position to the median storage. The second step is for the movement, either across or left into the through roadway.

Design sight distance for ramp terminals as at-grade intersections with only left- and right-turning movements. An added element at ramp terminals is the grade separation structure. [Exhibit 1310-19b](#) gives the sight distance guidance in the vicinity of a structure. In addition, when the crossroad is an undercrossing, check the sight distance under the structure graphically using a truck eye height of 6 feet and an object height of 1.5 feet.

Document a brief description of the intersection area, sight distance restrictions, and traffic characteristics to support the design vehicle and sight distances chosen.

Exhibit 1310-19a Sight Distance at Intersections

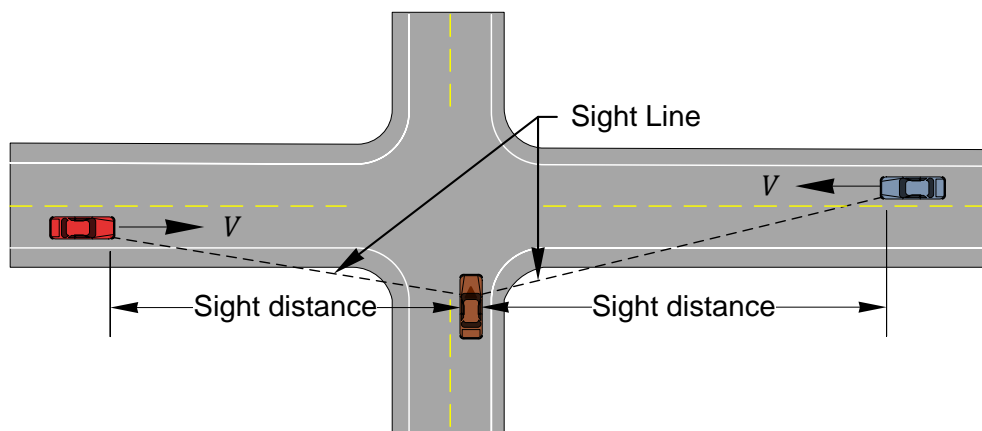

$S_i = 1.47Vt_g$
<p>Where: S_i = Intersection sight distance (ft) V = Design speed of the through roadway (mph) t_g = Time gap for the minor roadway traffic to enter or cross the through roadway (sec)</p>

Intersection Sight Distance Equation
Table 1

Notes:

Adjust the t_g values listed in Table 2 as follows:

Crossing or right-turn maneuvers:

All vehicles subtract 1.0 sec

Multilane roadways:

Left turns, for each lane in excess of one to be crossed, and for medians wider than 4 ft:

Passenger cars add 0.5 sec

All trucks and buses add 0.7 sec

Crossing maneuvers, for each lane in excess of two to be crossed, and for medians wider than 4 ft:

Passenger cars add 0.5 sec

All trucks and buses add 0.7 sec

Where medians are wide enough to store the design vehicle, determine the sight distance as two maneuvers.

Crossroad grade greater than 3%:

All movements upgrade for each percent that exceeds 3%:

All vehicles add 0.2 sec

Design Vehicle	Time Gap (t_g) in Sec
Passenger car (P)	7.5
Single-unit trucks and buses (SU-30 & CITY-BUS)	9.5
Combination trucks (WB-40 & WB-67)	11.5
<p>Note: Values are for a stopped vehicle to turn left onto a two-lane two-way roadway with no median and grades 3% or less.</p>	

Intersection Sight Distance Time Gaps (t_g)
Table 2

Exhibit 1310-19b Sight Distance at Intersections

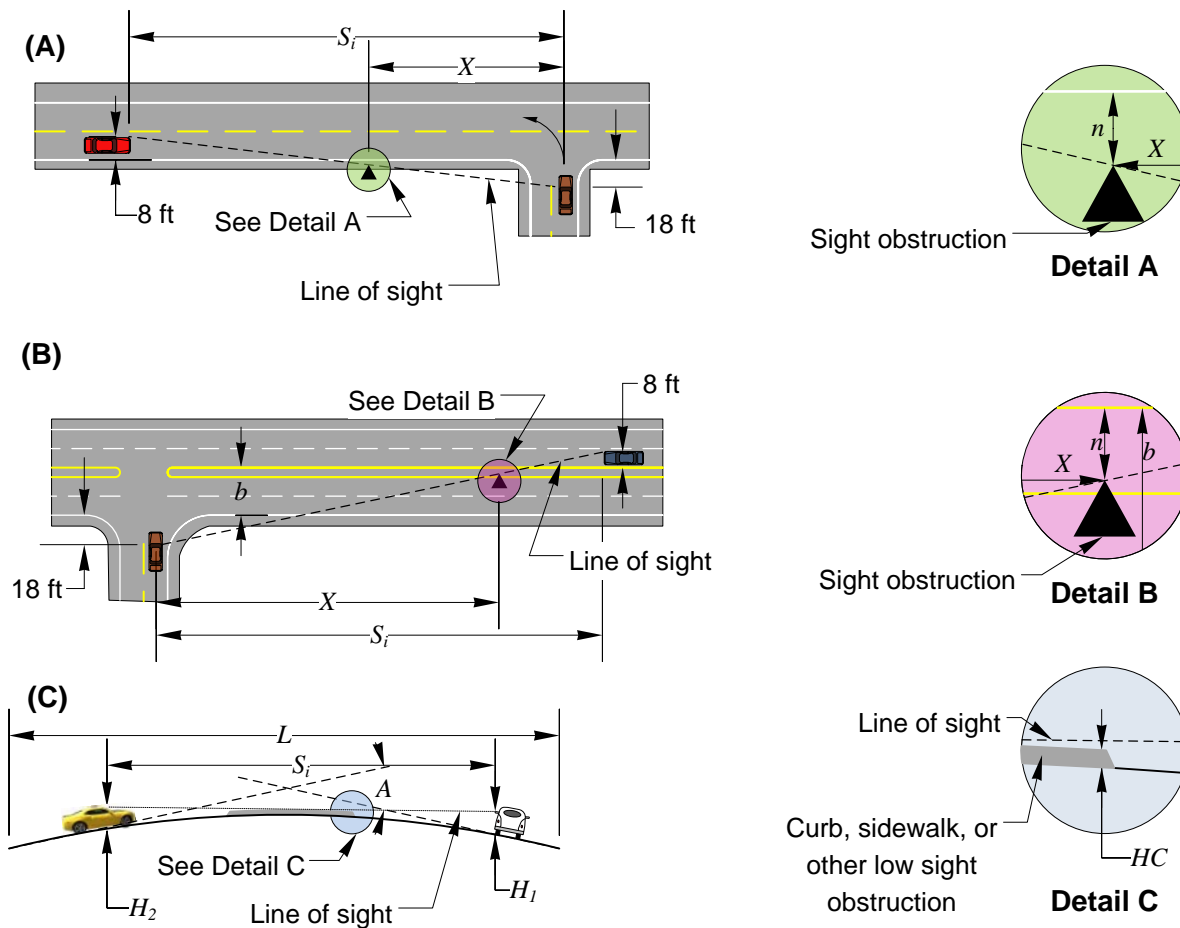

For sight obstruction driver cannot see over:

$$S_i = \frac{(26 + b)(X)}{(18 + b - n)}$$

Where:

- S_i = Available intersection sight distance (ft)
- n = Offset from sight obstruction to edge of lane (ft)
- b = Distance from near edge of traveled way to near edge of lane approaching from right (ft) ($b=0$ for sight distance to the left)
- X = Distance from centerline of lane to sight obstruction (ft)

For crest vertical curve over a low sight obstruction when $S < L$:

$$S_i = \sqrt{\frac{100L[\sqrt{2(H_1 - HC)} + \sqrt{2(H_2 - HC)}]^2}{A}}$$

$$L = \frac{AS_i^2}{100[\sqrt{2(H_1 - HC)} + \sqrt{2(H_2 - HC)}]^2}$$

Where:

- S_i = Available sight distance (ft)
- H_1 = Eye height (3.5 ft for passenger cars; 6 ft for all trucks)
- H_2 = Approaching vehicle height (3.5 ft)
- HC = Sight obstruction height (ft)
- L = Vertical curve length (ft)
- A = Algebraic difference in grades (%)

1310.06 Signing and Delineation

Use the [MUTCD](#) and the [Standard Plans](#) for signing and delineation criteria. Provide a route confirmation sign on all state routes shortly after major intersections. (See [Chapter 1020](#) for additional information on signing.)

Painted or plastic pavement markings are normally used to delineate travel paths. For pavement marking details, see the [MUTCD](#), [Chapter 1030](#), and the [Standard Plans](#).

Contact the region or HQ Traffic Office for additional information when designing signing and pavement markings.

1310.07 Procedures

Document design decisions and conclusions in accordance with [Chapter 300](#). For highways with limited access control, see [Chapter 530](#).

1310.07(1) Approval

An intersection is approved in accordance with [Chapter 300](#). Complete the following items, as needed, before intersection approval:

- Intersection Control Type Approval (see [Chapter 1300](#))
- Deviations approved in accordance with [Chapter 300](#)
- Approved Traffic Signal Permit (DOT Form 242-014 EF) (see [Chapter 1330](#))

1310.07(2) Intersection Plans

Provide intersection plans for any increases in capacity (turn lanes) at an intersection, modification of channelization, or change of intersection geometrics. Support the need for intersection or channelization modifications with history; school bus and mail route studies; hazardous materials route studies; pedestrian use; public meeting comments; etc.

For information to be included on the intersection plan for approval, see the Intersection/Channelization Plan for Approval Checklist on the following website:

www.wsdot.wa.gov/design/projectdev/

1310.07(3) Local Agency or Developer-Initiated Intersections

Intersections in local agency and developer projects on state routes must receive the applicable approvals in section [1310.07\(1\)](#) as part of the intersection design process.

The project initiator submits an intersection plan and the documentation of design decisions that led to the plan to the region for approval. For those plans requiring a design deviation, the deviation must be approved in accordance with [Chapter 300](#) prior to approval of the plan. After the plan approval, the region prepares a construction agreement with the project initiator (see the [Utilities Manual](#)).

1310.08 Documentation

Refer to [Chapter 300](#) for design documentation requirements.

1310.09 References

1310.09(1) Federal/State Laws and Codes

Americans with Disabilities Act of 1990 (ADA) (28 CFR Part 36, Appendix A)

[Revised Code of Washington \(RCW\) 35.68.075](#), Curb ramps for persons with disabilities – Required – Standards and requirements

[Washington Administrative Code \(WAC\) 468-18-040](#), Design standards for rearranged county roads, frontage roads, access roads, intersections, ramps and crossings

[WAC 468-52](#), Highway access management – Access control classification system and standards

1310.09(2) Design Guidance

[Local Agency Guidelines \(LAG\)](#), M 36-63, WSDOT

[Manual on Uniform Traffic Control Devices for Streets and Highways](#), USDOT, FHWA; as adopted and modified by Chapter 468-95 WAC “Manual on uniform traffic control devices for streets and highways” (MUTCD)

[Standard Plans for Road, Bridge, and Municipal Construction](#) (Standard Plans), M 21-01, WSDOT

1310.09(3) Supporting Information

A Policy on Geometric Design of Highways and Streets (Green Book), AASHTO

Aspects of Traffic Control Devices, Highway Research Record No. 211, pp 1 18, “Volume Warrants for Left-Turn Storage Lanes at Unsignalized Grade Intersections,” Harmelink, M.D.

Guidelines and Recommendations to Accommodate Older Drivers and Pedestrians, FHWA-RD-01-051, USDOT, FHWA, May 2001

Highway Capacity Manual (HCM), Special Report 209, Transportation Research Board, National Research Council

Intersection Channelization Design Guide, NCHRP 279

Conversely, some driveways, such as a rural locked and gated utility, farm, or logging access that larger vehicles sometimes use, may be better served with a smaller and narrower access. This is based on infrequent use and to prevent unauthorized use or dumping of debris on or near the driveway. Other design considerations are:

- Prevent stormwater from flowing onto the roadway from the driveway.
- Properly size culverts under the driveway to adequately accommodate the conveyance of stormwater in the roadway ditches and swales.
- Provide driveway sight distance.
- Accommodate for mailbox placement.
- Ensure surfacing materials and depths are appropriate.
- Generally, extend paving to the right of way line depending on the location/purpose of the driveway. The desirable intersection angle of the driveway is 90°, with 60° to 120° allowed.

1340.03(2) WSDOT Projects

When evaluating access connections or approaches on a project, review existing driveways for possible alterations, relocations, consolidations, or closures. The first step in that process is to determine the legality of the driveway. The region Development Services Office can provide a list of the permitted driveway connections on a managed access highway, noting that, per [RCW 47.50.080](#), Permit removal, “Unpermitted connections to the state highway system in existence on July 1, 1990, shall not require the issuance of a permit and may continue to provide access to the state highway system, unless the permitting authority determines that such a connection does not meet minimum acceptable standards of highway safety.” As a result, driveway connections on a managed access state highway can be considered to be permitted, grandfathered, or unpermitted as described below:

- *Permitted* driveways hold a valid permit and shall remain valid until modified or revoked.
- *Grandfathered* driveways that were in existence and in active use consistent with the type of connection on July 1, 1990, may continue to provide connection to the state highway system. They do not require the issuance of a new permit and may continue to provide access to the state highway system, unless the permitting authority determines that such a connection does not meet minimum acceptable standards of highway safety.
- *Unpermitted* driveways are not allowed. The permitting authority may initiate action to close the unpermitted driveway in compliance with the applicable chapters of [47.50 RCW](#) and [468-51](#) and [468-52 WAC](#). These are driveways that do not have a permit and were constructed after July 1, 1990.

If a WSDOT project proposes to alter, relocate, consolidate, or close a driveway—regardless of whether the driveway is permitted, grandfathered, or unpermitted—it is required that a new access connection permit be issued for any driveways that are to remain. If a driveway is to be removed, formal notification to the property owner will be provided as specified in [WAC 468-51-040](#). Unless determined otherwise, the affected property owners of driveways that will be altered, relocated, consolidated, or closed will not have the right of an adjudicative proceeding. Additional information regarding this process can be obtained by contacting your region’s Development Services Office.

On limited access highways, both the region Development Services and Real Estate Services offices may provide assistance to determine the legality of an existing driveway. Federal Highway Administration approval is required for driveway modifications on Interstate facilities.

1340.04 Driveway Design Templates

There are two design templates for use where there is no adjacent sidewalk. (When a driveway connection has or will have adjacent sidewalk, see 1340.05.) The templates may be used on both limited access and managed access state highways. If an Interstate limited access driveway is allowed, it must be gated. Considering the context of use, Exhibit 1340-1 is generally used for design vehicles of SU-30 and smaller, while Exhibit 1340-2 is generally used for design vehicles of SU-30 and larger.

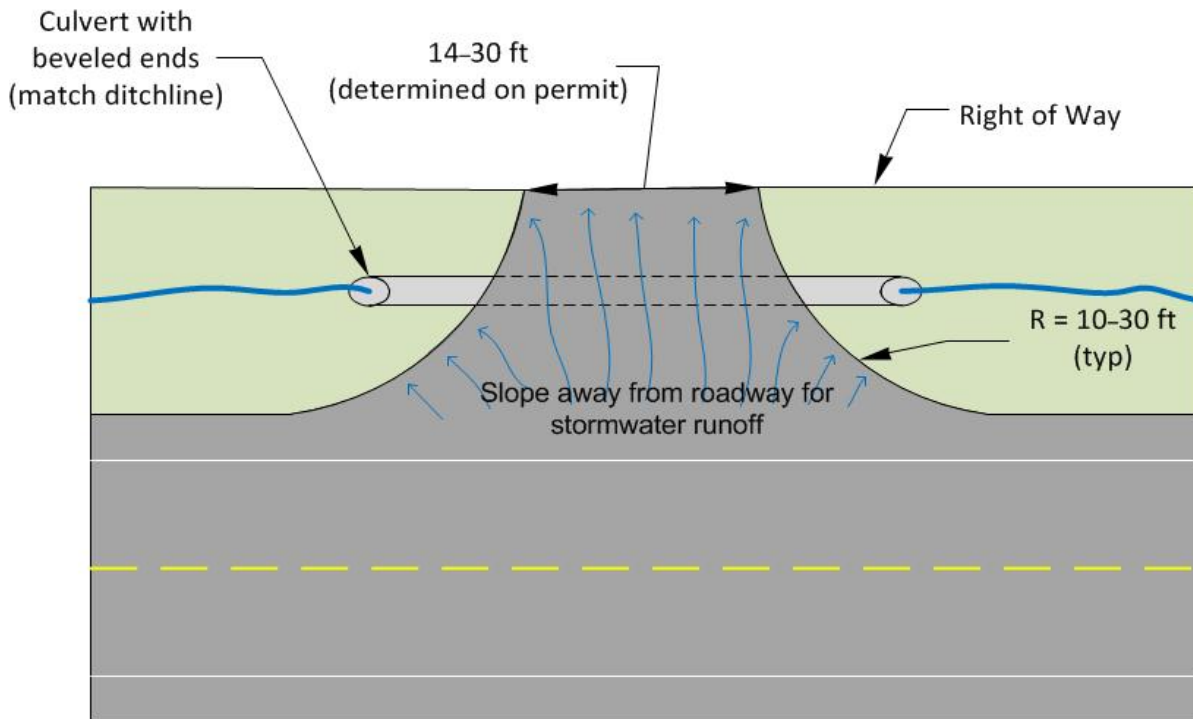

Driveway Design Template SU-30 and Smaller
Exhibit 1340-1

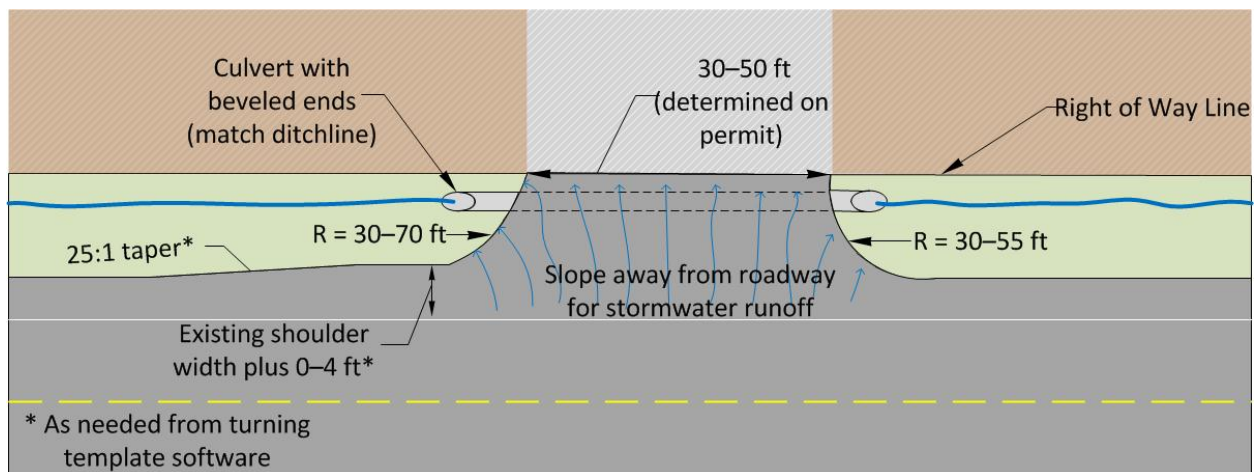

Driveway Design Template SU-30 and Larger
Exhibit 1340-2

1360.01	General
1360.02	Interchange Design
1360.03	Ramps
1360.04	Interchange Connections
1360.05	Ramp Terminal Intersections at Crossroads
1360.06	Interchanges on Two-Lane Highways
1360.07	Interchange Plans for Approval
1360.08	Documentation
1360.09	References

1360.01 General

The primary purpose of an interchange is to reduce conflicts caused by vehicle crossings and minimize conflicting left-turn movements. Provide interchanges on all Interstate highways and freeways, and at other locations where traffic cannot be controlled efficiently by intersections at grade.

For additional information, see the following chapters:

Chapter	Subject
520	Access control
530	Limited access
550	Interchange justification report
1103	Design controls
1106	Design element dimensions
1230	Ramp sections
1240	Turning widths
1250	Superelevation
1310	Intersections
1410	HOV lanes
1420	HOV direct access connections

1360.02 Interchange Design

1360.02(1) General

All freeway exits and entrances, except HOV direct access connections, are to connect on the right of through traffic. Deviations from this will be considered only for special conditions.

HOV direct access connections may be constructed on the left of through traffic when they are designed in accordance with [Chapter 1420](#).

Provide complete ramp facilities for all directions of travel wherever possible. However, give primary consideration to the basic traffic movement function that the interchange is to fulfill.

Complications are rarely encountered in the design and location of rural interchanges that simply provide a means of exchanging traffic between a limited access freeway and a local crossroad. Carefully consider the economic and operational effects of locating traffic

interchanges along a freeway through a community, particularly with respect to local access, to provide convenient local service without reducing the capacity of the major route(s).

Where freeway-to-freeway interchanges are involved, do not provide ramps for local access unless they can be added conveniently and without detriment to efficient traffic flow or reduction of capacity, either ramp or freeway main line. When exchange of traffic between freeways is the basic function, and local access is prohibited by access control restrictions or traffic volume, separate interchanges for local service may be needed.

1360.02(2) Interchange Patterns

Basic interchange patterns have been established that can be used under certain general conditions and modified or combined to apply to many more. Consider alternatives in the design of a specific facility; however, the conditions in the area and on the highway involved govern the final design of the interchange.

Selection of the final design is based on a study of projected traffic volumes, site conditions, geometric controls, criteria for intersecting legs and turning roadways, driver expectancy, consistent ramp patterns, continuity, and cost.

The patterns most frequently used for interchange design are those commonly described as directional, semidirectional, cloverleaf, partial cloverleaf, diamond, and single point (urban) interchange (see [Exhibit 1360-1](#)).

1360.02(2)(a) Directional

A directional interchange is the most effective design for connection of intersecting freeways. The directional pattern has the advantage of reduced travel distance, increased speed of operation, and higher capacity. These designs eliminate weaving and have a further advantage over cloverleaf designs in avoiding the loss of sense of direction drivers experience in traveling a loop. This type of interchange is costly to construct, commonly using a four-level structure.

1360.02(2)(b) Semidirectional

A semidirectional interchange has ramps that loop around the intersection of the highways. This results in multiple single-level structures and more area than the directional interchange.

1360.02(2)(c) Cloverleaf

The full cloverleaf interchange has four loop ramps for the left-turning traffic. Outer ramps provide for the right turns. A full cloverleaf is the minimum type interchange for a freeway-to-freeway interchange. Cloverleaf designs often incorporate a C-D road to minimize signing difficulties and remove weaving conflicts from the main roadway.

The principal advantage of this design is the elimination of all left-turn conflicts with one single-level structure. Because all movements are merging movements, it is adaptable to any grade line arrangement.

The cloverleaf has some major disadvantages. The left-turn movement has a circuitous route on the loop ramp, the speeds are low on the loop ramp, and there are weaving conflicts between the loop ramps. The cloverleaf also needs a large area. The weaving and the radius of the loop ramps are a capacity constraint on the left-turn movements.

1360.02(2)(d) Partial Cloverleaf (PARCLO)

A partial cloverleaf has loop ramps in one, two, or three quadrants that are used to eliminate the major left-turn conflicts. These loops may also serve right turns for interchanges where ramp cannot be built in one or two quadrants. Outer ramps are provided for the remaining turns. Design the grades to provide sight distance between vehicles approaching these ramps.

1360.02(2)(e) Diamond

A diamond interchange has four ramps that are essentially parallel to the major arterial. Each ramp provides for one right-turn and one left-turn movement. Because left turns are made at grade across conflicting traffic on the crossroad, intersection sight distance is a primary consideration.

The diamond design is the most generally applicable and serviceable interchange configuration and usually has a smaller footprint than any other type. Consider this design first unless another design is clearly dictated by traffic, topography, or special conditions.

1360.02(2)(f) Single Point Urban (SPUI)

A single point urban interchange is a modified diamond with all of its ramp terminals on the crossroad combined into one signalized at-grade intersection. This single intersection accommodates all interchange and through movements.

A single point urban interchange can improve the traffic operation on the crossroad with less right of way than a typical diamond interchange, but a larger structure.

Exhibit 1360-1 Basic Interchange Patterns

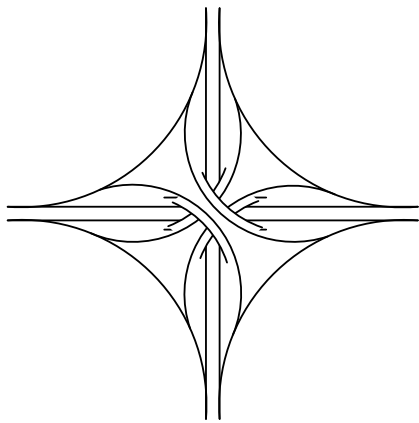

Directional

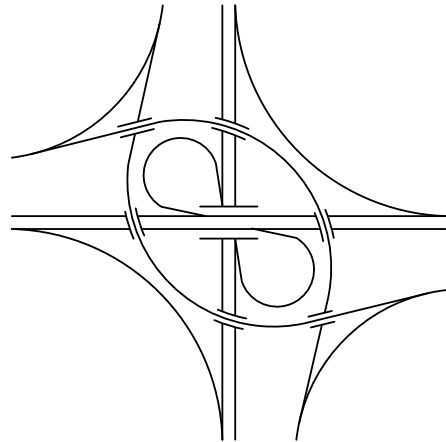

Semidirectional

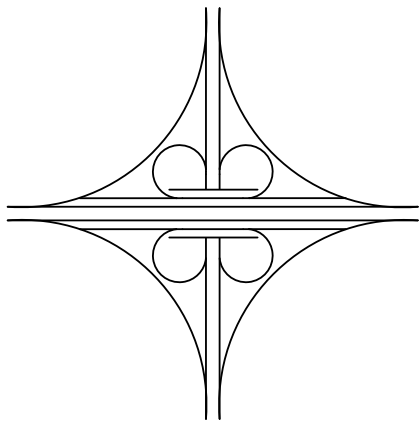

Cloverleaf With C-D Roads

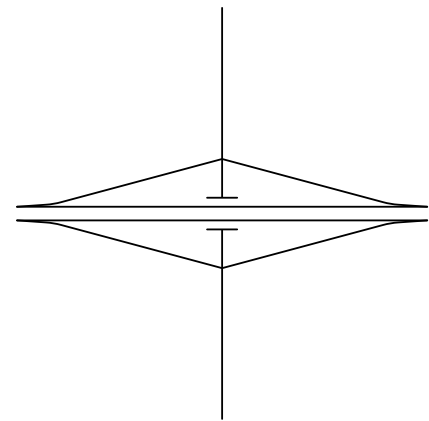

Diamond

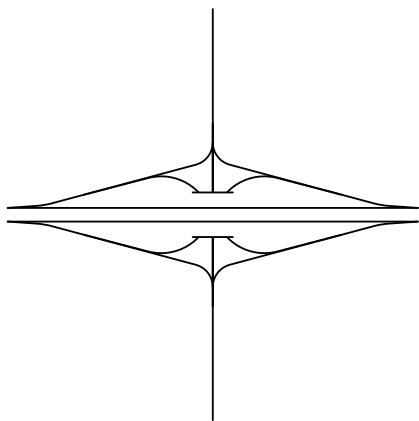

Single Point Urban Interchange (SPUI)

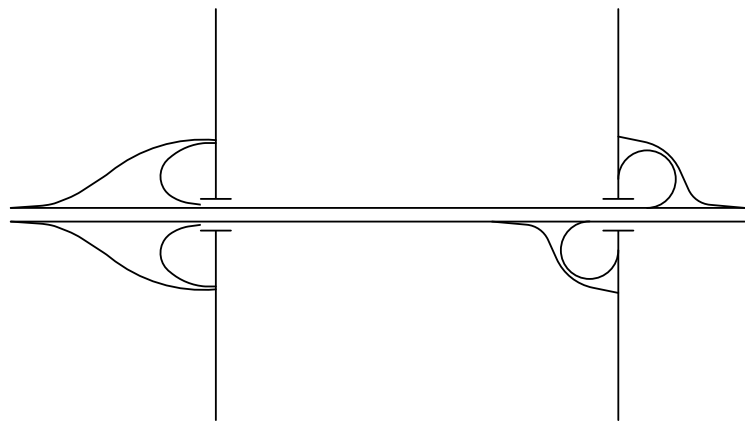

Partial Cloverleaf

1360.02(3) Spacing

To avoid excessive interruption of main line traffic, consider each proposed facility in conjunction with adjacent interchanges, intersections, and other points of access along the route as a whole.

The minimum spacing between adjacent interchanges is 1 mile in urban areas, 3 miles on the Interstate in rural areas, and 2 miles on non-Interstate in rural areas (see [Exhibit 1360-2](#)). In urban areas, spacing less than 1 mile may be used with C-D roads or grade-separated (braided) ramps. Interchange spacing is measured along the freeway centerline between the centerlines of the crossroads.

The spacing between interchanges may also be dependent on the spacing between ramp connections. The minimum spacing between the gore noses of adjacent ramps is given in [Exhibit 1360-3](#).

Exhibit 1360-2 Interchange Spacing

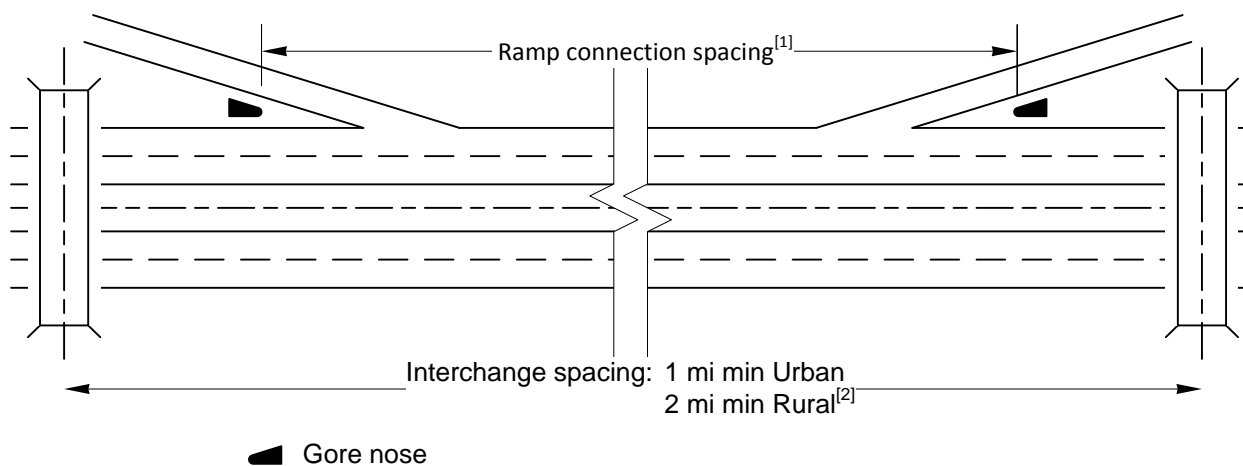

Notes:

- [1] As a minimum, provide length for weaving and signing, but not less than given in [Exhibit 1360-3](#).
- [2] 3 miles on the Interstate System.

Consider either frontage roads or C-D roads to facilitate the operation of near-capacity volumes between closely spaced interchanges or ramp terminals. C-D roads may be needed where cloverleaf loop ramps are involved or where a series of interchange ramps have overlapping speed change lanes. Base the distance between successive ramp terminals on capacity. Check the intervening sections by weaving analyses to determine whether capacity, sight distance, and effective signing can be provided without the use of auxiliary lanes or C-D roads.

Provide justifications for existing interchanges with less-than-desirable spacing or ramp connection spacing to remain in place.

1360.02(4) Route Continuity

Route continuity is providing the driver of a through route a path on which lane changes are minimized and other traffic operations occur to the right.

In maintaining route continuity, interchange configuration may not favor the heavy traffic movement, but rather the through route. In this case, design the heavy traffic movements with multilane ramps, flat curves, and reasonably direct alignment.



1360.02(5) Drainage

Avoid interchanges located in proximity to natural drainage courses. These locations often result in complex and unnecessarily costly hydraulic structures. The open areas within an interchange can be used for stormwater detention facilities.

1360.02(6) Uniformity of Exit Pattern

While interchanges are of necessity custom-designed to fit specific conditions, it is desirable that the pattern of exits along a freeway have some degree of uniformity. From the standpoint of driver expectancy, it is desirable that each interchange have only one point of exit, located in advance of the crossroad.

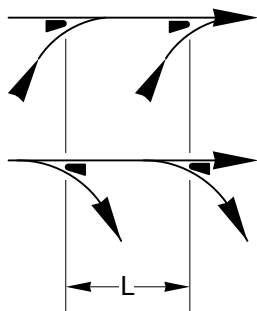
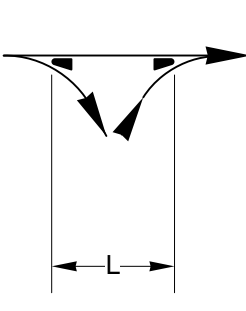
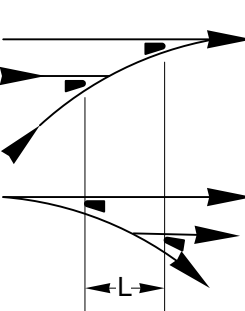
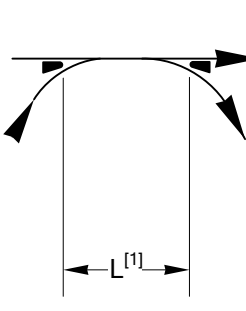
Exhibit 1360-3 Minimum Ramp Connection Spacing

On-On or Off-Off		Off-On		Turning Roadways		On-Off (Weaving)			
									
Freeway	C-D Road	Freeway	C-D Road	System ^[2] Interchange	Service ^[3] Interchange	A	B	C	D
1,000	800	500	400	800	600	2000	1600	1600	1000
 Gore nose									
L = Minimum distance in feet from gore nose to gore nose. A Between two interchanges connected to a freeway: a system interchange ^[2] and a service interchange. ^[3] B Between two interchanges connected to a C-D road: a system interchange ^[2] and a service interchange. ^[3] C Between two interchanges connected to a freeway: both service interchanges. ^[3] D Between two interchanges connected to a C-D road: both service interchanges. ^[3]									
Notes:									
These values are based on operational experience, need for flexibility, and signing. Check them in accordance with Exhibit 1360-12 and the procedures outlined in the <i>Highway Capacity Manual</i> , and use the larger value.									
[1] With justification, these values may be reduced for cloverleaf ramps.									
[2] A system interchange is a freeway-to-freeway interchange.									
[3] A service interchange is a freeway-to-local road interchange.									

1360.03 Ramps

1360.03(1) Ramp Design Speed

The design speed for a ramp is based on the design speed for the freeway main line.

It is desirable that the ramp design speed at the connection to the freeway be equal to the free-flow speed of the freeway. Meet or exceed the upper range values from [Exhibit 1360-4](#) for the design speed at the ramp connection to the freeway. Transition the ramp design speed to provide a smooth acceleration or deceleration between the speeds at the ends of the ramp. However, do not reduce the ramp design speed below the lower-range speed of 25 mph. For loop ramps, use a design speed as high as feasible, but not lower than 25 mph.

These design speed guidelines do not apply to the ramp in the area of the ramp terminal at-grade intersection. In the area of the intersection, use a design speed of 15 mph for turning traffic or 0 mph for a stop condition. Use the allowed skew at the ramp terminal at-grade intersection to minimize ramp curvature.

For freeway-to-freeway ramps and C-D roads, the design speed at the connections to both freeways is the upper range values from [Exhibit 1360-4](#); however, with justification, the midrange values from [Exhibit 1360-4](#) may be used for the remainder of the ramp. When the design speed for the two freeways is different, use the higher design speed.

Existing ramps meet design speed criteria if acceleration or deceleration criteria are met (see [Exhibit 1360-9](#) or [1360-10](#)) and superelevation meets the criteria in [Chapter 1250](#).

Exhibit 1360-4 Ramp Design Speed

Main Line Design Speed (mph)		50	55	60	65	70	80
Ramp Design Speed (mph)	Upper Range	45	50	50	55	60	70
	Midrange	30	40	45	45	50	60
	Lower Range	25	25	25	25	25	25

1360.03(2) Sight Distance

Design ramps in accordance with the provisions in [Chapter 1260](#) for stopping sight distances.

1360.03(3) Grade

The maximum grade for ramps for various design speeds is given in [Exhibit 1360-5](#).

Exhibit 1360-5 Maximum Ramp Grade

Ramp Design Speed (mph)		25–30	35–40	45 and above
Ramp Grade (%)	Desirable	5	4	3
	Maximum*	7	6	5

*On one-way ramps, downgrades may be 2% greater.

1360.03(4) Cross Section

Provide the minimum ramp widths given in Exhibit 1360-6, unless otherwise determined by design element dimensioning (see Chapter 1106). Ramp traveled ways may need additional width to these minimums when operational needs exist. (See Chapters 1230 and 1240 for additional information and roadway sections.)

Cross slope and superelevation criteria for ramp traveled ways and shoulders are as given in Chapters 1230 and 1250 for roadways. At ramp terminals, the intersection lane and shoulder width design guidance shown in Chapters 1310 and 1230 may be used.

Whenever feasible, make the ramp cross slope at the ramp beginning or ending station equal to the cross slope of the through lane pavement. Where space is limited and superelevation runoff is long, or when parallel connections are used, the superelevation transition may be ended beyond (for on-ramps) or begun in advance of (for off-ramps) the ramp beginning or ending station, provided that the algebraic difference in cross slope at the edge of the through lane and the cross slope of the ramp does not exceed 4%. In such cases, provide smooth transitions for the edge of traveled way.

Exhibit 1360-6 Ramp Widths

Number of Lanes		1	2
Ramp Width (ft)	Traveled Way ^[1]	11-13	23-25 ^[3]
	Shoulders	Right	4-8 ^[2]
		Left	2
	Medians ^[4]	6	6-8
Notes: [1] Evaluate shoulder use to accommodate offtracking, if determined inadequate for operational performance needs, apply turning roadway widths in Chapter 1240. [2] Provide width necessary to accommodate offtracking by large vehicles or for specific shoulder functions (see Chapter 1230) [3] Add 12 ft for each additional lane. [4] The minimum two-way ramp median width (including shoulders) is given. Wider medians may be required for signs or other traffic control devices and their respective clearances. When either the on- or off-ramp is single-lane, use the one-lane column. If both directions are two lanes, use the two-lane column.			

Ramp shoulders may be used by large trucks for offtracking and by smaller vehicles cutting to the inside of curves. Evaluate the need to pave shoulders full depth for larger vehicle offtracking using turn simulation software on one-way ramps to accommodate this type of use. If operational performance needs demonstrate that accommodation of offtracking on shoulders is inadequate apply turning roadway widths in Chapter 1240.

1360.03(5) Two-Way Ramps

Two-way ramps are on- and off-ramps on a single roadway. Design two-way ramps as separate one-way ramps. Provide a raised median to physically separate the on- and off- ramps. Wider medians than given in [Exhibit 1360-6](#) may be required for signing or other traffic control devices and their clearances. (For signs, it is sign width plus 4 feet.) Where wider medians are required, provide a 2-foot clearance between the face of curb and the edge of traveled way. Where additional width is not required, the raised median width may be reduced to a double-faced mountable or extruded curb. Traffic barrier or a depressed median may be provided in place of the raised median.

1360.03(6) Ramp Lane Increases

When off-ramp traffic and left-turn movement volumes at the ramp terminal at-grade intersection cause excessive queue length, it may be desirable to add lanes to the ramp to reduce the queue length caused by congestion and turning conflicts. Make provision for the addition of ramp lanes whenever ramp exit or entrance volumes are expected to result in an undesirable mobility or safety performance. (See [Chapter 1210](#) for width transition design.)

1360.03(7) Ramp Meters

Ramp meters are used to allow a measured or regulated amount of traffic to enter the freeway. When operating in the “measured” mode, they release traffic at a measured rate to keep downstream demand below capacity and improve system travel times. In the “regulated” mode, they break up platoons of vehicles that occur naturally or result from nearby traffic signals. Even when operating at near capacity, a freeway main line can accommodate merging vehicles one or two at a time, while groups of vehicles will cause main line flow to break down.

The location of the ramp meter is a balance between the storage and acceleration criteria. Locate the ramp meter to maximize the available storage and so that the acceleration lane length, from a stop to the freeway main line design speed, is available from the stop bar to the merging point. With justification, the average main line running speed during the hours of meter operation may be used for the highway design speed to determine the minimum acceleration lane length from the ramp meter. (See [1360.04\(4\)](#) for information on the design of on-connection acceleration lanes and [Chapter 1050](#) for additional information on the design of ramp meters.)

Driver compliance with the signal is required for the ramp meter to have the desired results. Consider enforcement areas with metered ramps.

Consider HOV bypass lanes with ramp meters. (See [Chapter 1410](#) for design data for ramp meter bypass lanes.)

1360.04 Interchange Connections

To the extent practicable, provide uniform geometric design and uniform signing for exits and entrances in the design of a continuous freeway. Do not design an exit ramp as an extension of a main line tangent at the beginning of a main line horizontal curve.

Provide spacing between interchange connections as given in [Exhibit 1360-3](#).

Avoid on-connections on the inside of a main line curve, particularly when the ramp approach angle is accentuated by the main line curve, the ramp approach results in a reverse curve to connect to the main line, or the elevation difference will cause the cross slope to be steep at the nose.

Keep the use of mountable curb at interchange connections to a minimum.

Provide justification when curb is used adjacent to traffic with a design speed of 40 mph or higher.

Exhibit 1360-7a Lane Balance

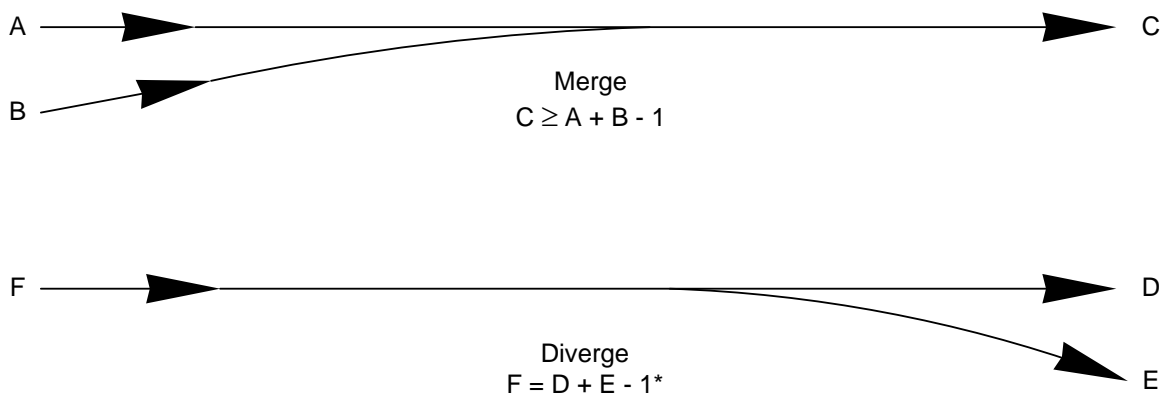

*Number of lanes (F) may increase by one lane, when the lane is an auxiliary lane between closely spaced entrance and exit ramps.

1360.04(1) Lane Balance

Design interchanges to the following principles of lane balance:

1360.04(1)(a) Entrances

At entrances, make the number of lanes beyond the merging of two traffic streams not less than the sum of all the lanes on the merging roadways less one (see Exhibit 1360-7a).

1360.04(1)(b) Exits

At exits, make the number of approach lanes equal the number of highway lanes beyond the exit plus the number of exit lanes less one (see Exhibit 1360-7a). Exceptions to this are:

- At a cloverleaf.
- At closely spaced interchanges with a continuous auxiliary lane between the entrance and exit.

In these cases, the auxiliary lane may be dropped at a single-lane, one-lane reduction off-connection ([Exhibit 1360-14c](#)), with the number of approach lanes being equal to the sum of the highway lanes beyond the exit and the number of exit lanes. Closely spaced interchanges have a distance of less than 2,100 feet between the end of the acceleration lane and the beginning of the deceleration lane.

Maintain the basic number of lanes, as described in [Chapter 1210](#), through interchanges. When a two-lane exit or entrance is used, maintain lane balance with an auxiliary lane (see Exhibit 1360-7b). The exception to this is when the basic number of lanes is changed at an interchange.

Exhibit 1360-7b Lane Balance

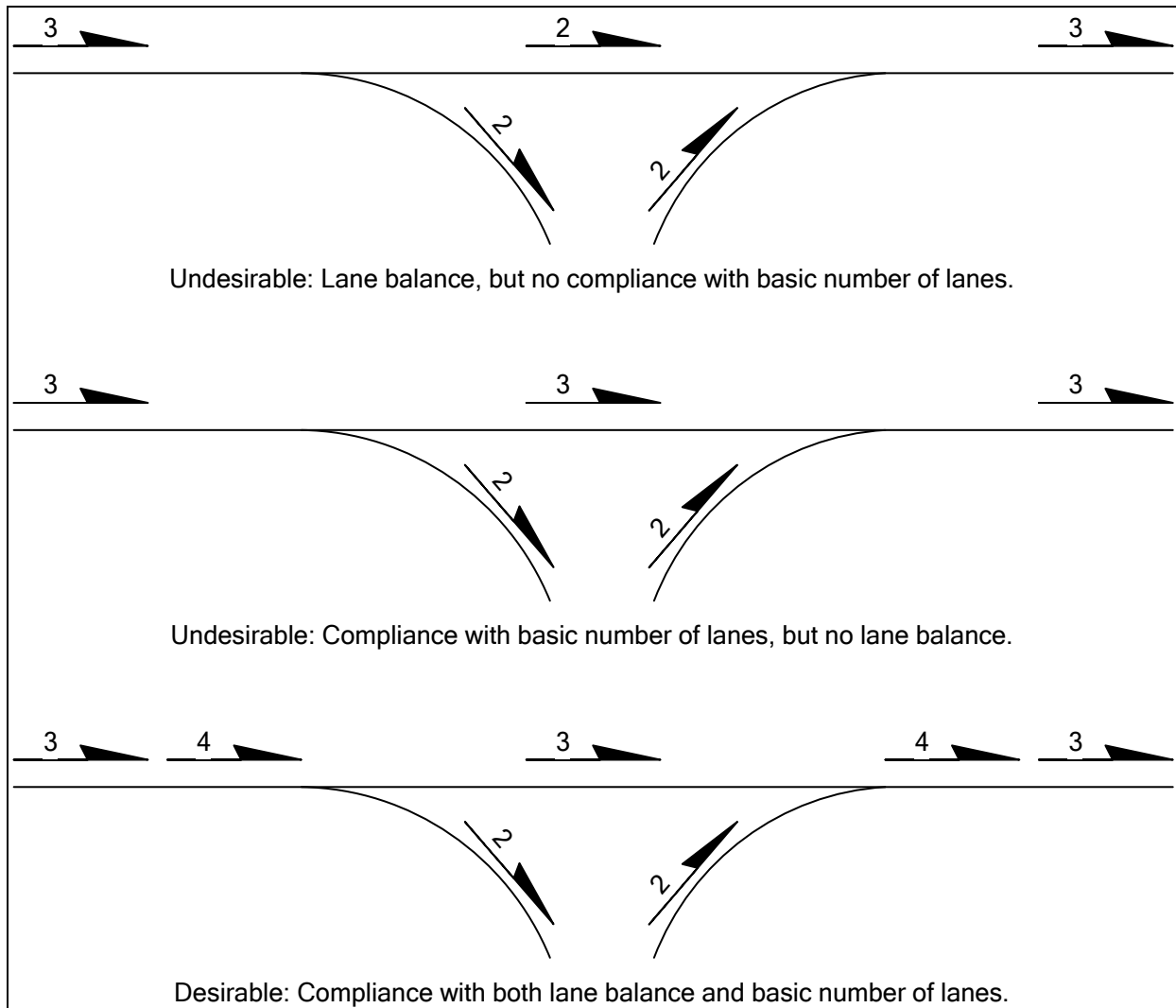

1360.04(2) Main Line Lane Reduction

The reduction of a basic lane or an auxiliary lane may be made at a two-lane exit or may be made between interchanges. When a two-lane exit is used, provide a recovery area with a normal acceleration taper. When a lane is dropped between interchanges, drop it 1,500 to 3,000 feet from the end of the acceleration taper of the previous interchange. This allows for signing but will not be so far that the driver becomes accustomed to the number of lanes and will be surprised by the reduction (see [Exhibit 1360-8](#)).

Reduce the traveled way width of the freeway by only one lane at a time.

1360.04(3) Sight Distance

Locate off-connections and on-connections on the main line to provide decision sight distance for a speed/path/direction change as described in Chapter 1260.

Exhibit 1360-8 Main Line Lane Reduction Alternatives

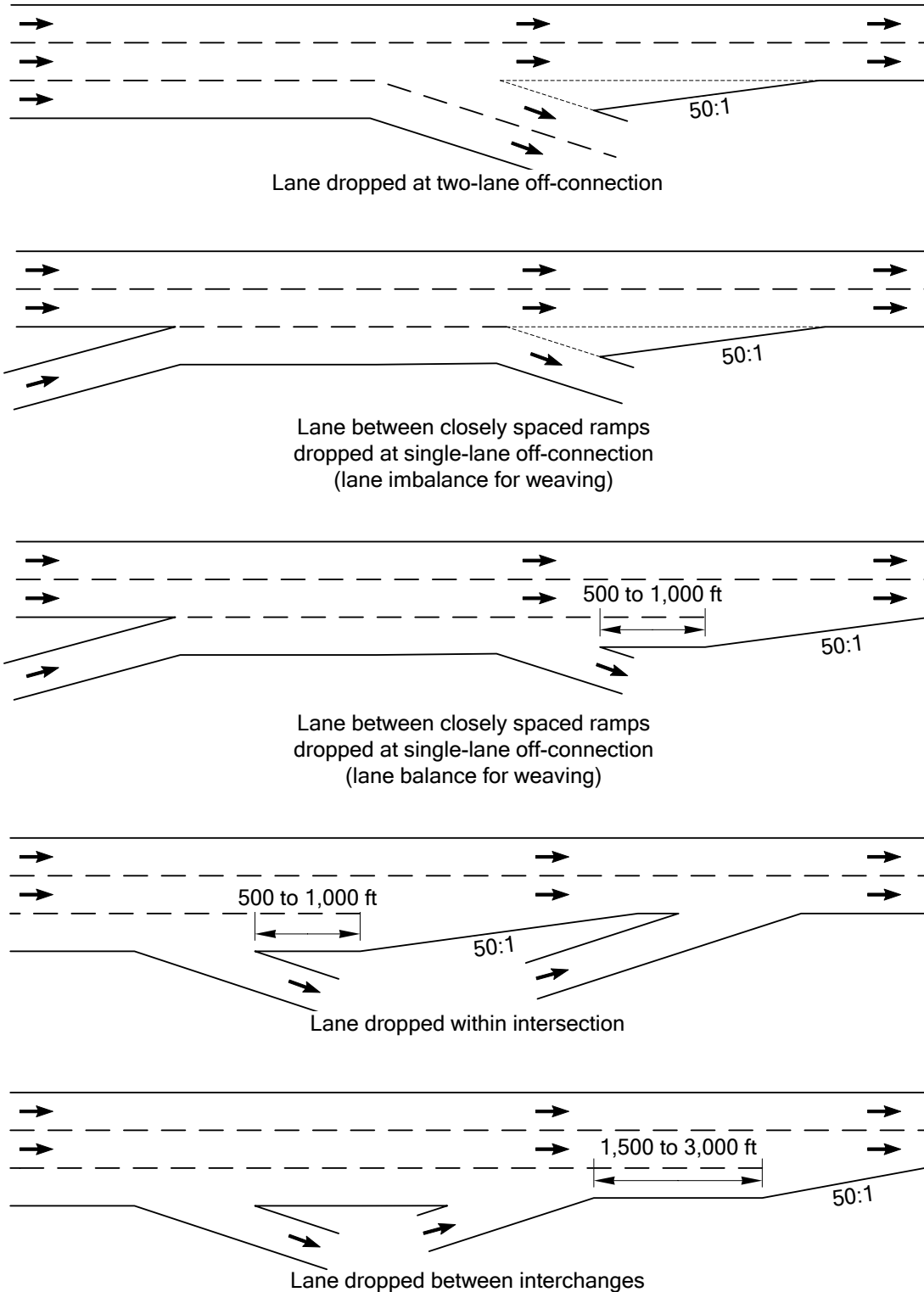

1360.04(4) On-Connections

On-connections are the paved areas at the end of on-ramps that connect them to the main lane of a freeway. They have two parts: an acceleration lane and a taper. The acceleration lane allows entering traffic to accelerate to the freeway speed and evaluate gaps in the freeway traffic. The taper is for the entering vehicle to maneuver into the through lane.

On-connections are either tapered or parallel. The tapered on-connection provides direct entry at a flat angle, reducing the steering control needed. The parallel on-connection adds a lane adjacent to the through lane for acceleration with a taper at the end. Vehicles merge with the through traffic with a reverse curve maneuver similar to a lane change. While less steering control is needed for the taper, the parallel is narrower at the end of the ramp and has a shorter taper at the end of the acceleration lane.

1360.04(4)(a) Acceleration Lane

Provide the minimum acceleration lane length, given in [Exhibit 1360-9](#), for each ramp design speed on all on-ramps. When the average grade of the acceleration lane is 3% or greater, multiply the distance from the Minimum Acceleration Lane Length table by the factor from the Adjustment Factor for Grades table.

For existing ramps that do not have significant crashes in the area of the connection with the freeway, the freeway posted speed may be used to calculate the acceleration lane length for Preservation projects. If corrective action is indicated, use the freeway design speed to determine the length of the acceleration lane.

The acceleration lane is measured from the last point designed at each ramp design speed (usually the PT of the last curve for each design speed) to the last point of the ramp width. Curves designed at higher design speeds may be included as part of the acceleration lane length.

1360.04(4)(b) Gap Acceptance

For parallel on-connections, provide the minimum gap acceptance length (L_g) to allow entering motorists to evaluate gaps in the freeway traffic and position their vehicles to use the gap. The length is measured beginning at the point that the left edge of traveled way for the ramp intersects the right edge of traveled way of the main line to the ending of the acceleration lane (see Exhibits [1360-13b](#) and [13c](#)). The gap acceptance length and the acceleration length overlap, with the ending point controlled by the longer of the two.

Exhibit 1360-9 Acceleration Lane Length

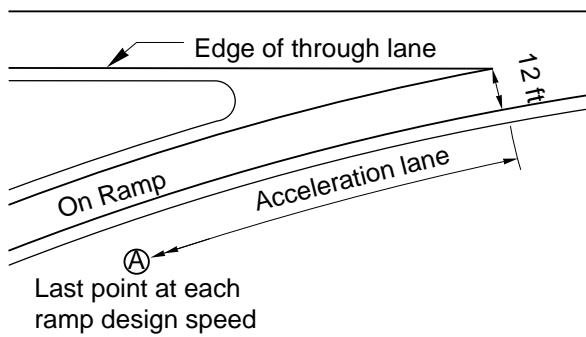

Tapered On-Connection

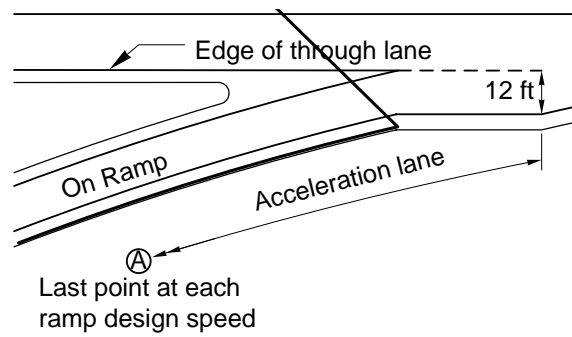

Parallel On-Connection

Highway Design Speed (mph)	Ramp Design Speed (mph)										
	0	15	20	25	30	35	40	45	50	60	70
30	180	140									
35	280	220	160								
40	360	300	270	210	120						
45	560	490	440	380	280	160					
50	720	660	610	550	450	350	130				
55	960	900	810	780	670	550	320	150			
60	1200	1140	1100	1020	910	800	550	420	180		
65	1410	1350	1310	1220	1120	1000	770	600	370		
70	1620	1560	1520	1420	1350	1230	1000	820	580	210	
80	2000	1950	1890	1830	1730	1610	1380	1200	970	590	210

Minimum Acceleration Lane Length (ft)

Highway Design Speed (mph)	Grade	Upgrade				Downgrade All Ramp Design Speeds
		Ramp Design Speed				
		20	30	40	50	
40	3% to less than 5%	1.3	1.3			0.70
45		1.3	1.35			0.675
50		1.3	1.4	1.4		0.65
55		1.35	1.45	1.45		0.625
60		1.4	1.5	1.5	1.6	0.60
70		1.5	1.6	1.7	1.8	0.60
40	5% or more	1.5	1.5			0.60
45		1.5	1.6			0.575
50		1.5	1.7	1.9		0.55
55		1.6	1.8	2.05		0.525
60		1.7	1.9	2.2	2.5	0.50
70		2.0	2.2	2.6	3.0	0.50

Adjustment Factors for Grades Greater Than 3%

Note: Lane widths are shown for illustrative purposes. Determine lane widths based on [Exhibit 1360-6](#), and Chapters [1106](#) and [1230](#).

1360.04(4)(c) Single-Lane On-Connections

Single-lane on-connections may be either tapered or parallel. The tapered is desirable; however, the parallel may be used with justification. Design single-lane tapered on-connections as shown in [Exhibit 1360-13a](#) and single-lane parallel on-connections as shown in [Exhibit 1360-13b](#).

1360.04(4)(d) Two-Lane On-Connections

For two-lane on-connections, the parallel is desirable. Design two-lane parallel on-connections as shown in [Exhibit 1360-13c](#). A capacity analysis will normally be the basis for determining whether a freeway lane or an auxiliary lane is to be provided.

Justify the use of a two-lane tapered on-connection. Design two-lane tapered on connections in accordance with [Exhibit 1360-13d](#).

1360.04(5) Off-Connections

Off-connections are the paved areas at the beginning of an off-ramp, connecting it to a main lane of a freeway. They have two parts: a taper for maneuvering out of the through traffic and a deceleration lane to slow to the speed of the first curve on the ramp. Deceleration is not assumed to take place in the taper.

Off-connections are either tapered or parallel. The tapered is desirable because it fits the normal path for most drivers. When a parallel connection is used, drivers tend to drive directly for the ramp and not use the parallel lane. However, when a ramp is on the outside of a curve, the parallel off-connection is desirable. An advantage of the parallel connection is that it is narrower at the beginning of the ramp.

1360.04(5)(a) Deceleration Lane

Provide the minimum deceleration lane length given in [Exhibit 1360-10](#) for each design speed for all off-ramps. Also, provide deceleration lane length to the end of the anticipated queue at the ramp terminal. When the average grade of the deceleration lane is 3% or greater, multiply the distance from the Minimum Deceleration Lane Length table by the factor from the Adjustment Factor for Grades table.

For existing ramps that do not have significant crashes in the area of the connection with the freeway, the freeway posted speed may be used to calculate the deceleration lane length for Preservation projects. If corrective action is indicated, use the freeway design speed to determine the length of the deceleration lane.

The deceleration lane is measured from the point where the taper reaches the selected ramp lane width to the first point designed at each ramp design speed (usually the PC of the first curve for each design speed). Curves designed at higher design speeds may be included as part of the deceleration lane length.

Exhibit 1360-10 Deceleration Lane Length

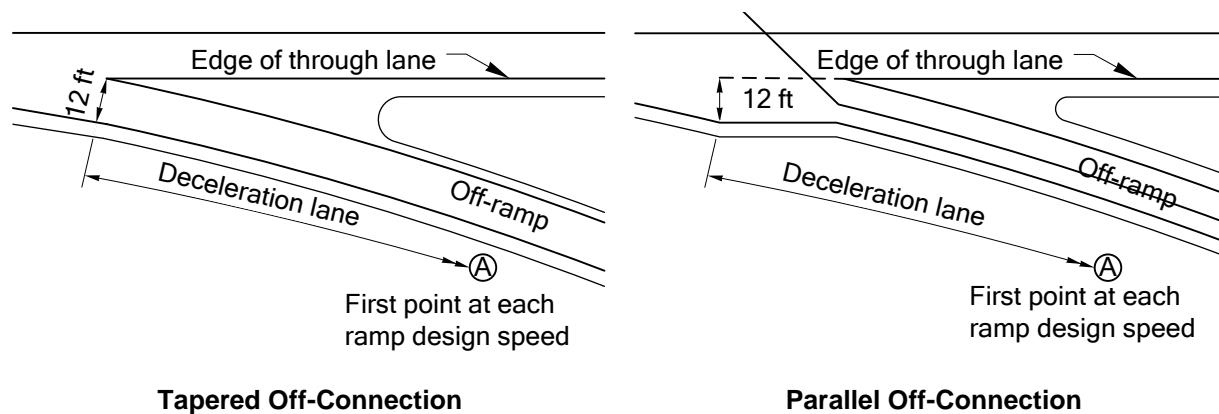

Highway Design Speed (mph)	Ramp Design Speed (mph)										
	0	15	20	25	30	35	40	45	50	60	70
30	235	200	170	140							
35	280	250	210	185	150						
40	320	295	265	235	185	155					
45	385	350	325	295	250	220	155				
50	435	405	385	355	315	285	225	175			
55	480	455	440	410	380	350	285	235	180		
60	530	500	480	460	430	405	350	300	240		
65	570	540	520	500	470	440	390	340	280	185	
70	615	590	570	550	520	490	440	390	340	240	
80	735	710	690	670	640	610	555	510	465	360	265

Minimum Deceleration Lane Length (ft)

Grade	Upgrade	Downgrade
3% to less than 5%	0.9	1.2
5% or more	0.8	1.35

Adjustment Factors for Grades Greater Than 3%

Note: Lane widths are shown for illustrative purposes. Determine lane widths based on [Exhibit 1360-6](#), and Chapters [1230](#) and [1106](#).

1360.04(5)(b) Gores

Gores (see Exhibits [1360-11a](#) and [11b](#)) are decision points. Design them to be clearly seen and understood by approaching drivers. In a series of interchanges along a freeway, it is desirable that the gores be uniform in size, shape, and appearance.

The paved area between the physical nose and the gore nose is the reserve area. It is reserved for the installation of an impact attenuator. The minimum length of the reserve area is controlled by the design speed of the main line (see Exhibits [1360-11a](#) and [11b](#)).

In addition to striping, raised pavement marker rumble strips may be placed for additional warning and delineation at gores. (See the *Standard Plans* for striping and rumble strip details.)

Keep the unpaved area beyond the gore nose as free of obstructions as possible to provide a clear recovery area. Grade this unpaved area as nearly level with the roadways as possible. Avoid placing obstructions such as heavy sign supports, luminaire poles, and structure supports in the gore area.

When an obstruction is placed in a gore area, provide an impact attenuator (see [Chapter 1620](#)) and barrier (see [Chapter 1610](#)). Place the beginning of the attenuator as far back in the reserve area as possible, desirably after the gore nose.

1360.04(5)(c) Single-Lane Off-Connections

For single-lane off-connections, the tapered is desirable. Use the design shown in [Exhibit 1360-14a](#) for tapered single-lane off-connections. Justify the use of a parallel single-lane off-connection, as shown in [Exhibit 1360-14b](#).

1360.04(5)(d) Single-Lane Off-Connection With One Lane Reduction

The single-lane off-connection with one lane reduction, shown in [Exhibit 1360-14c](#), is used when the conditions from lane balance for a single-lane exit, one-lane reduction, are met.

1360.04(5)(e) Tapered Two-Lane Off-Connection

The tapered two-lane off-connection design, shown in [Exhibit 1360-14d](#), is desirable where the number of freeway lanes is reduced or where high-volume traffic operations will be improved by the provision of a parallel auxiliary lane and the number of freeway lanes is unchanged.

1360.04(5)(f) Parallel Two-Lane Off-Connection

The parallel two-lane off-connection, shown in [Exhibit 1360-14e](#), allows less operational flexibility than the taper, requiring more lane changes. Justify the use of a parallel two-lane off-connection.

Exhibit 1360-11a Gore Area Characteristics

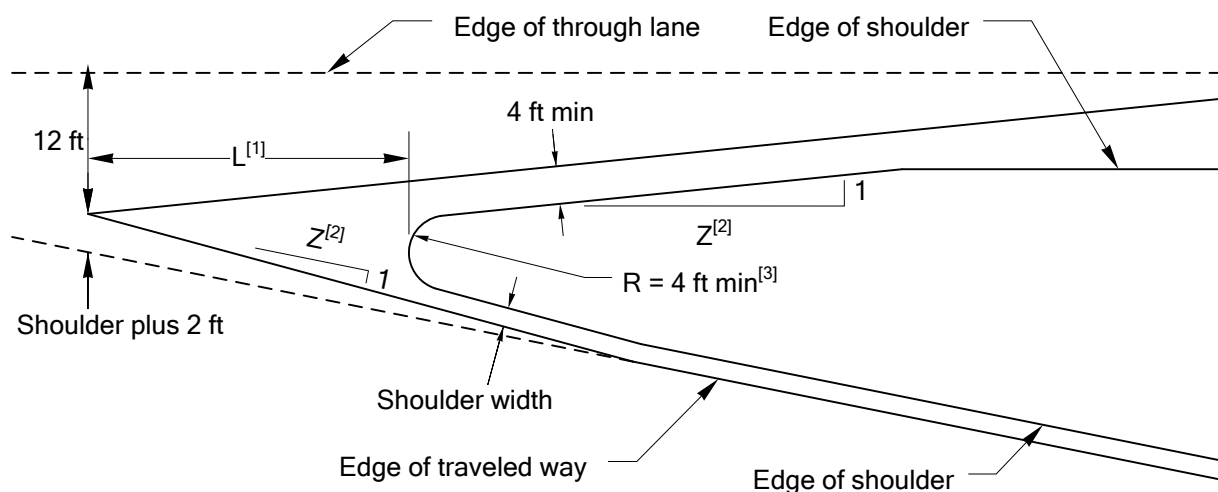
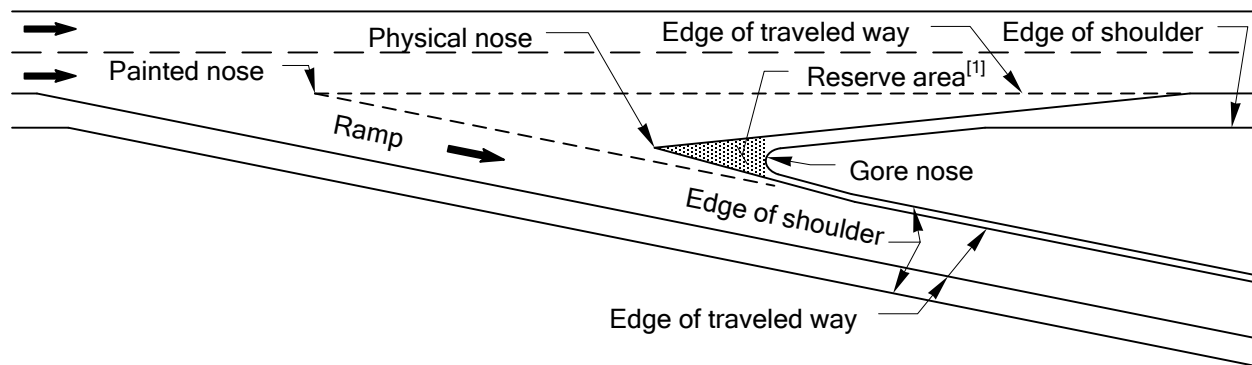

Single-Lane Off-Connections: No Lane Reduction

Notes:

[1] The reserve area length (L) is not less than:

Main Line Design Speed (mph)	40	45	50	55	60	65	70	80
L (ft)	25	30	35	40	45	50	55	70

[2] $Z = \frac{\text{Design Speed}}{2}$, design speed is for the main line.

[3] Radius may be reduced, when protected by an impact attenuator.

Exhibit 1360-11b Gore Area Characteristics

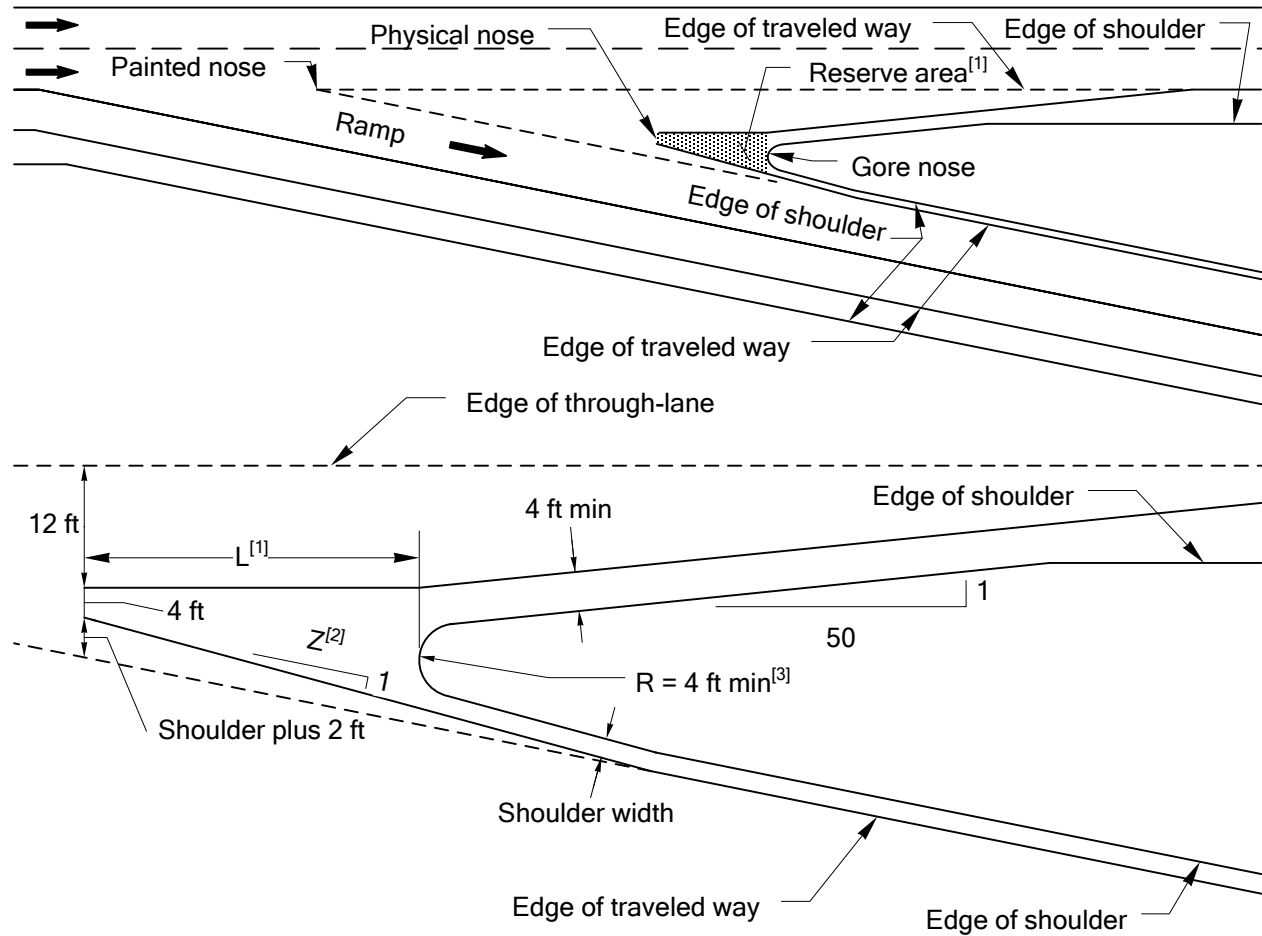

Single-Lane, One-Lane Reduction Off-Connections and All Two-Lane Off-Connections

Notes:

[1] The reserve area length (L) is not less than:

Main Line Design Speed (mph)	40	45	50	55	60	65	70	80
L (ft)	25	30	35	40	45	50	55	70

[2] $Z = \frac{\text{Design Speed}}{2}$, design speed is for the main line.

[3] Radius may be reduced, when protected by an impact attenuator.

1360.04(6) Collector-Distributor (C-D) Roads

A C-D road can be within a single interchange, through two closely spaced interchanges, or continuous through several interchanges. Design C-D roads that connect three or more interchanges to be two lanes wide. Other C-D roads may be one or two lanes in width, depending on capacity. Consider intermediate connections to the main line for long C-D roads.

- a. [Exhibit 1360-15a](#) shows the designs for collector-distributor outer separations. Use Design A, with concrete barrier, when adjacent traffic in either roadway is expected to exceed 40 mph. Design B, with mountable curb, may be used when adjacent posted speed does not exceed 40 mph.
- b. The details shown in [Exhibit 1360-15b](#) apply to single-lane C-D road off-connections. Design a two-lane C-D road off-connection, with the reduction of a freeway lane or an auxiliary lane, as a normal two-lane off-connection in accordance with [1360.04\(5\)](#).
- c. Design C-D road on-connections in accordance with [Exhibit 1360-15c](#).

1360.04(7) Loop Ramp Connections

Loop ramp connections at cloverleaf interchanges are distinguished from other ramp connections by a low-speed ramp on-connection, followed closely by an off-connection for another low-speed ramp. The loop ramp connection design is shown in [Exhibit 1360-16](#). The minimum distance between the ramp connections is dependent on a weaving analysis. When the connections are spaced far enough apart that weaving is not a consideration, design the on-connection in accordance with [1360.04\(4\)](#) and the off-connection in accordance with [1360.04\(5\)](#).

1360.04(8) Weaving Sections

Weaving sections may occur within an interchange, between closely spaced interchanges, or on segments of overlapping routes. [Exhibit 1360-12](#) gives the length of the weaving section for preliminary design. The total weaving traffic is the sum of the traffic entering from the ramp to the main line and the traffic leaving the main line to the exit ramp in equivalent passenger cars. For trucks, a passenger car equivalent of two may be estimated. Use the *Highway Capacity Manual* for the final design of weaving sections.

Because weaving sections cause considerable turbulence, interchange designs that eliminate weaving or remove it from the main roadway are desirable. Use C-D roads for weaving between closely spaced ramps when adjacent to high-speed highways. C-D roads are not needed for weaving on low-speed roads.

1360.05 Ramp Terminal Intersections at Crossroads

Design ramp terminal intersections at grade with crossroads as intersections at grade (see [Chapter 1300](#)). Whenever possible, design ramp terminals to discourage wrong-way movements. Locate ramp terminal intersections at grade with crossroads to provide signal progression if the intersection becomes signalized in the future. Provide intersection sight distance as described in Chapters [1310](#) or [1320](#).

Exhibit 1360-12 Length of Weaving Sections

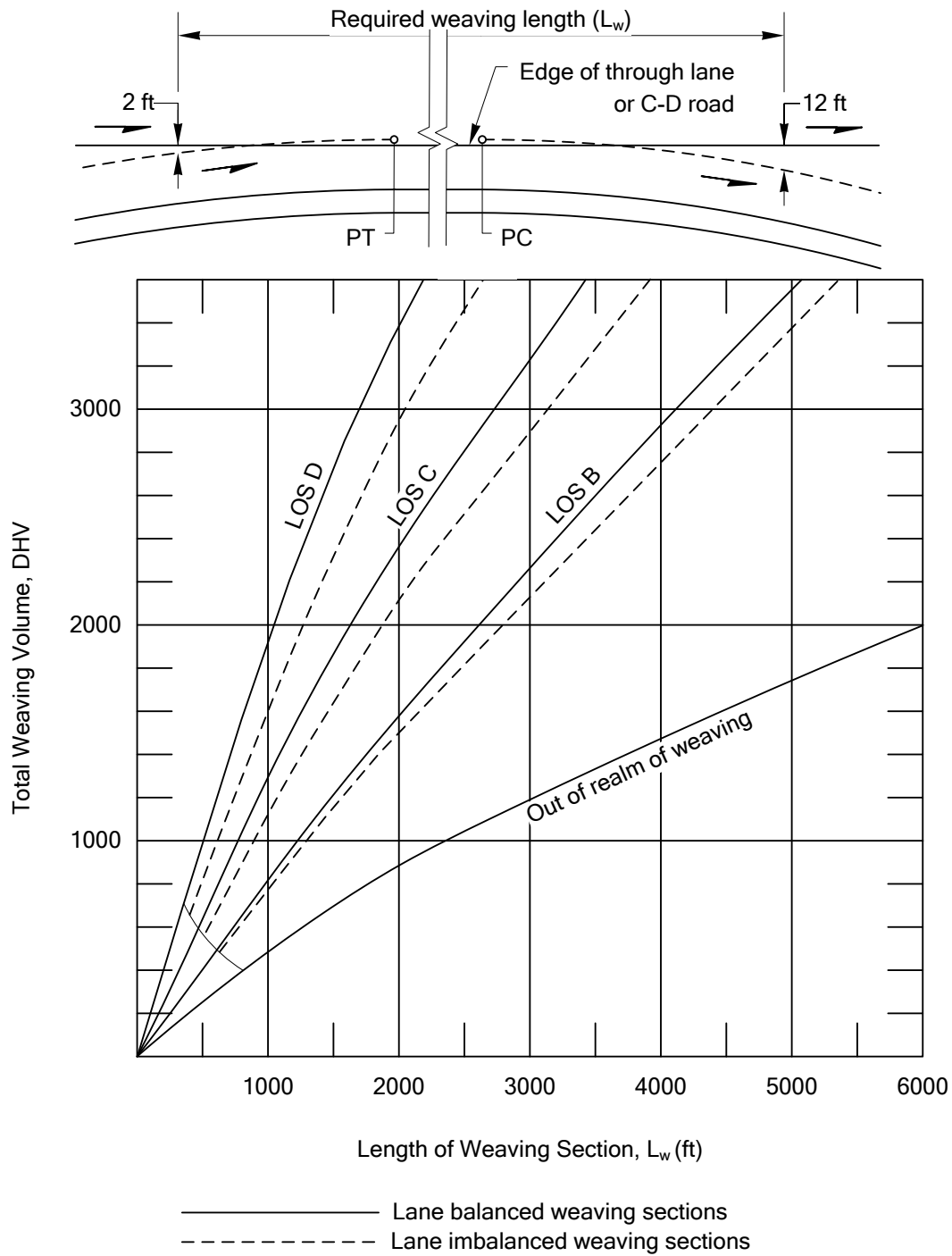

Note:

To determine whether or not lane balance for weaving exists, see [Exhibit 1360-8](#).

1360.06 Interchanges on Two-Lane Highways

Occasionally, the first stage of a conventional interchange will be built with only one direction of the main roadway and operated as a two-lane two-way roadway until the ultimate roadway is constructed.

The design of interchanges on two-lane two-way highways may vary considerably from traditional concepts due to the following conditions:

- The potential for cross-centerline crashes due to merge conflicts or motorist confusion.
- The potential for wrong-way or U-turn movements.
- Future construction considerations.
- Traffic type and volume.
- The proximity to multilane highway sections that might influence a driver's impression that these roads are also multilane.

Provide the deceleration taper for all interchange exit ramps on two-lane highways. Design the entering connection with either the normal acceleration taper or a "button hook" configuration with a stop condition before entering the main line. Consider the following items:

- Design the stop condition connection in accordance with a tee (T) intersection as shown in [Chapter 1310](#). Use this type of connection when an acceleration lane is not possible. Provide decision sight distance as described in [Chapter 1260](#).
- Since designs may vary from project to project, analyze each project for the most efficient signing placement, such as one-way, two-way, no passing, do not enter, directional arrows, guideposts, and traffic buttons.
- Prohibit passing through the interchange area on two-lane highways by means of signing, pavement marking, or a combination of both. The desirable treatment is a 4 foot median island, highlighted with raised pavement markers and diagonal stripes. When using a 4-foot median system, extend the island 500 feet beyond any merging ramp traffic acceleration taper. The width for the median can be provided by reducing each shoulder 2 feet through the interchange (see [Exhibit 1360-17](#)).
- Include signing and pavement markings to inform both the entering and through motorists of the two-lane two-way characteristic of the main line.
- Use as much of the ultimate roadway as possible. Where this is not possible, leave the area for future lanes and roadway ungraded.
- Design and construct temporary ramps as if they were permanent unless second-stage construction is planned to rapidly follow the first stage. Design the connection to meet the needs of the traffic.

1360.07 Interchange Plans for Approval

[Exhibit 1360-18](#) is a sample showing the general format and data for interchange design plans.

Compass directions (W-S Ramp) or crossroad names (E-C Street) may be used for ramp designations.

Include the following, as applicable:

- Design speeds (see [Chapter 1103](#)) for main line and crossroads.
- Curve data on main line, ramps, and crossroads.
- Numbers of lanes and widths of lanes and shoulders on main line, crossroads, and ramps.
- Superelevation diagrams for the main line, the crossroad, and all ramps; these may be submitted on separate sheets.
- Channelization.
- Stationing of ramp connections and channelization.
- Proposed right of way and access control treatment (see Chapters [510](#), [520](#), and [530](#)).
- Delineation of all crossroads, existing and realigned.
- Traffic data for the proposed design; include all movements.
- For HOV direct access connections on the left, include the statement that the connection will be used solely by HOVs or will be closed.

Prepare a preliminary contour grading plan for each completed interchange. Show the desired contours of the completed interchange, including details of basic land formation, slopes, graded areas, or other special features. Coordinate the contour grading with the drainage design and the roadside development plan.

1360.08 Documentation

Refer to [Chapter 300](#) for design documentation requirements.

1360.09 References

1360.09(1) Design Guidance

Manual on Uniform Traffic Control Devices for Streets and Highways, USDOT, FHWA; as adopted and modified by Chapter 468-95 WAC “Manual on uniform traffic control devices for streets and highways” (MUTCD)

Plans Preparation Manual, M 22-31, WSDOT

Standard Plans for Road, Bridge, and Municipal Construction (Standard Plans), M 21 01, WSDOT

Standard Specifications for Road, Bridge, and Municipal Construction (Standard Specifications), M 41-10, WSDOT

1360.09(2) Supporting Information

A Policy on Geometric Design of Highways and Streets (Green Book), AASHTO, [current edition](#)

A Policy on Design Standards – Interstate System, AASHTO, 2005

Highway Capacity Manual (Special Report 209), Transportation Research Board

Procedure for Analysis and Design of Weaving Sections: A User’s Guide, Jack E. Leisch, October 1985

Exhibit 1360-13a On-Connection: Single-Lane, Tapered

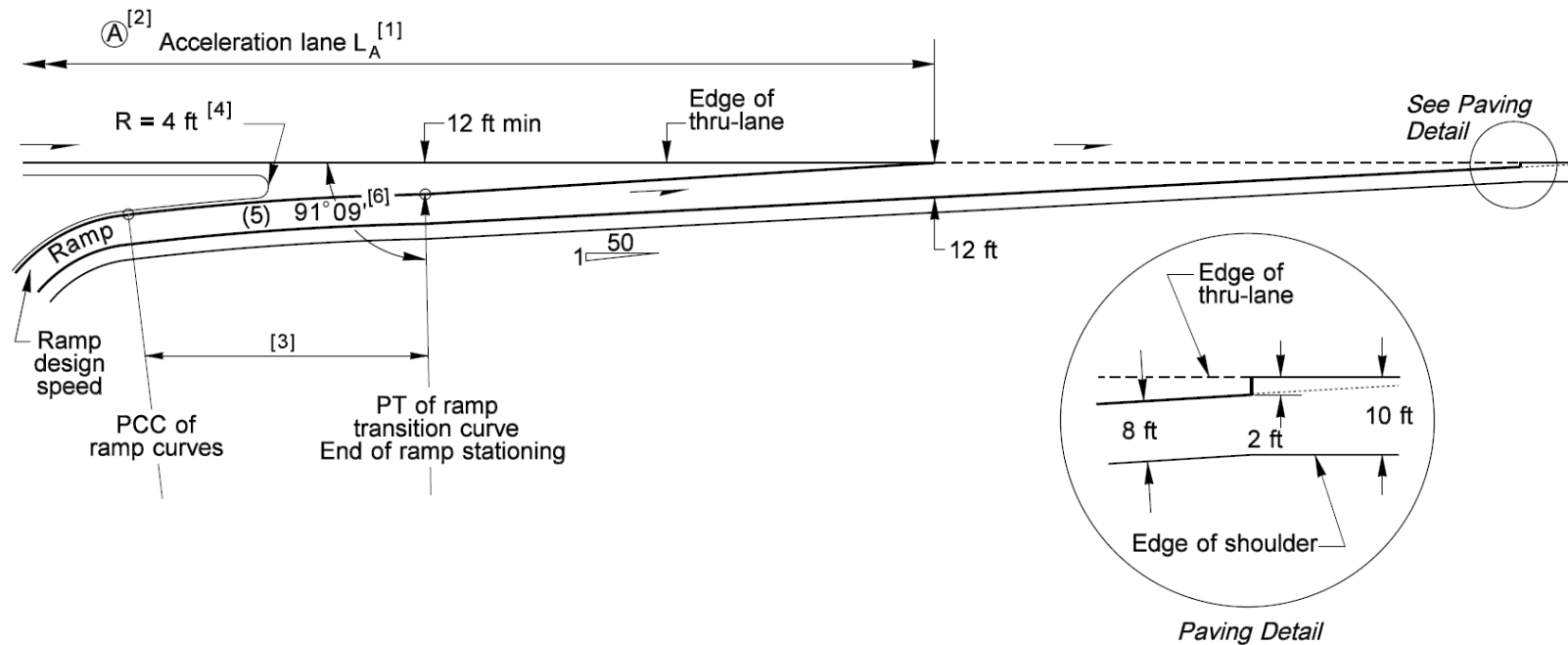
**Notes:**

- [1] For acceleration lane length L_A , see [Exhibit 1360-9](#).
- [2] Point A is the point controlling the ramp design speed.
- [3] A transition curve with a minimum radius of 3000 ft is desirable. The desirable length is 300 ft. When the main line is on a curve to the left, the transition may vary from a 3000-ft radius to tangent to the main line.
- [4] Radius may be reduced when concrete barrier is placed between the ramp and main line.
- [5] For ramp lane and shoulder widths, see [Exhibit 1360-6](#).
- [6] Approximate angle to establish ramp alignment.

General:

For striping, see the [Standard Plans](#).

Lane and shoulder widths are shown for illustrative purposes. Determine lane and shoulder widths based on [Exhibit 1360-6](#), and Chapters [1106](#) and [1230](#).

Exhibit 1360-13b On-Connection: Single-Lane, Parallel

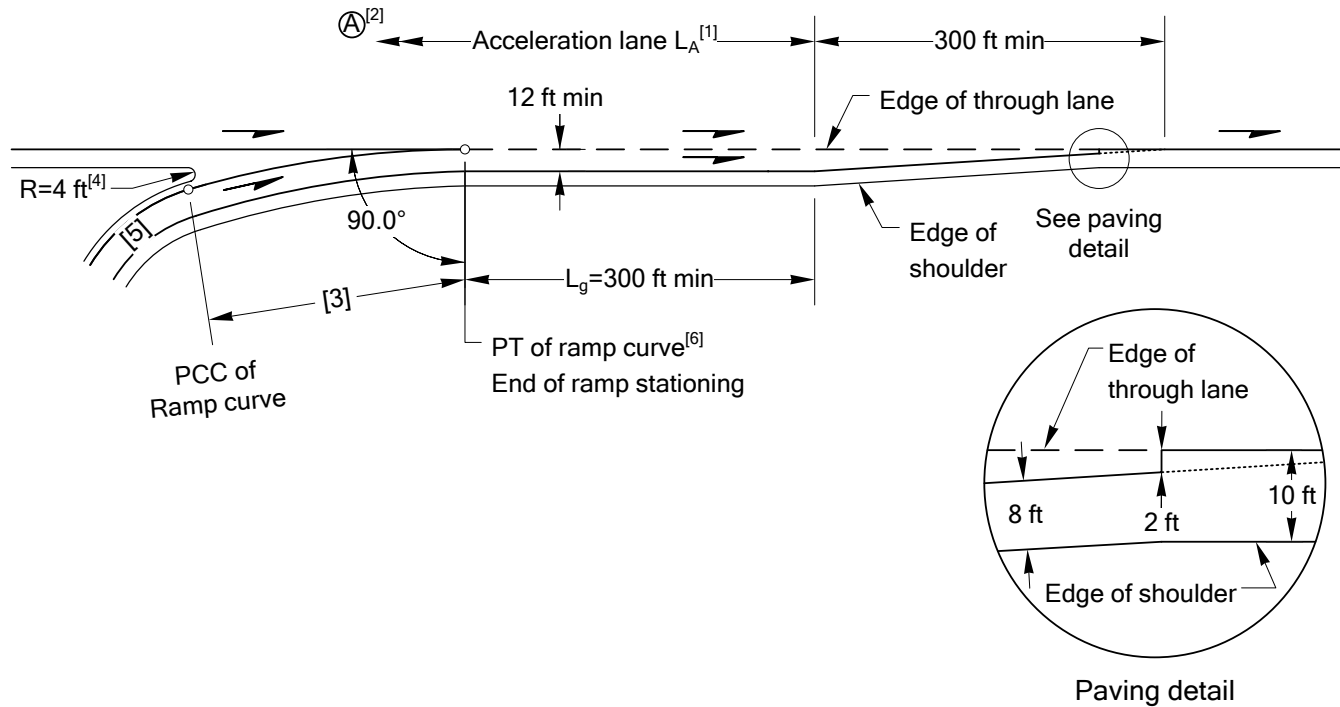
**Notes:**

- [1] For acceleration lane length L_A , see [Exhibit 1360-9](#).
- [2] Point A is the point controlling the ramp design speed.
- [3] A transition curve with a minimum radius of 3000 ft is desirable. The desirable length is 300 ft. When the main line is on a curve to the left, the transition may vary from a 3000-ft radius to tangent to the main line. The transition curve may be replaced by a 50:1 taper with a minimum length of 300 ft.
- [4] Radius may be reduced when concrete barrier is placed between the ramp and main line.
- [5] For ramp lane and shoulder widths, see [Exhibit 1360-6](#).
- [6] Ramp stationing may be extended to accommodate superelevation transition.

General:

For striping, see the [Standard Plans](#).

Lane and shoulder widths are shown for illustrative purposes. Determine lane and shoulder widths based on [Exhibit 1360-6](#), and Chapters [1106](#) and [1230](#).

Exhibit 1360-13c On-Connection: Two-Lane, Parallel

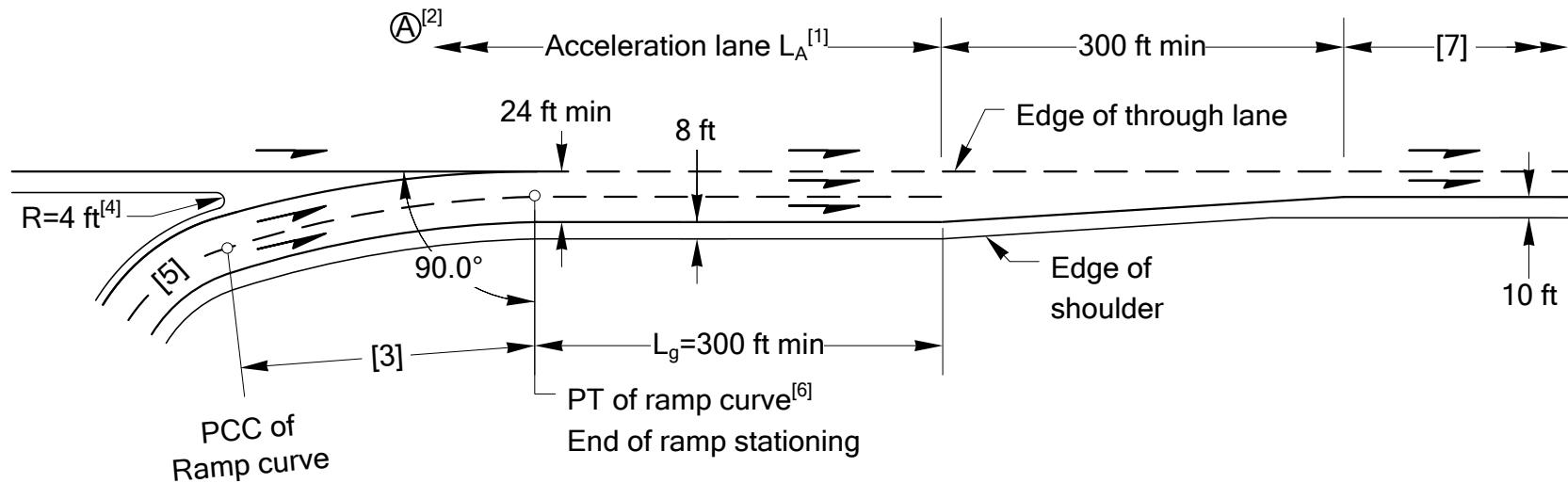
**Notes:**

- [1] For acceleration lane length L_A , see [Exhibit 1360-9](#).
- [2] Point A is the point controlling the ramp design speed.
- [3] A transition curve with a minimum radius of 3000 ft is desirable. The desirable length is 300 ft. When the main line is on a curve to the left, the transition may vary from a 3000-ft radius to tangent to the main line. The transition curve may be replaced by a 50:1 taper with a minimum length of 300 ft.
- [4] Radius may be reduced when concrete barrier is placed between the ramp and main line.
- [5] For ramp lane and shoulder widths, see [Exhibit 1360-6](#).
- [6] Ramp stationing may be extended to accommodate superelevation transition.
- [7] Added lane or 1,500-ft auxiliary lane plus 600-ft taper.

General:

For striping, see the [Standard Plans](#).

Lane and shoulder widths are shown for illustrative purposes. Determine lane and shoulder widths based on [Exhibit 1360-6](#), and Chapters [1106](#) and [1230](#).

Exhibit 1360-13d On-Connection: Two-Lane, Tapered

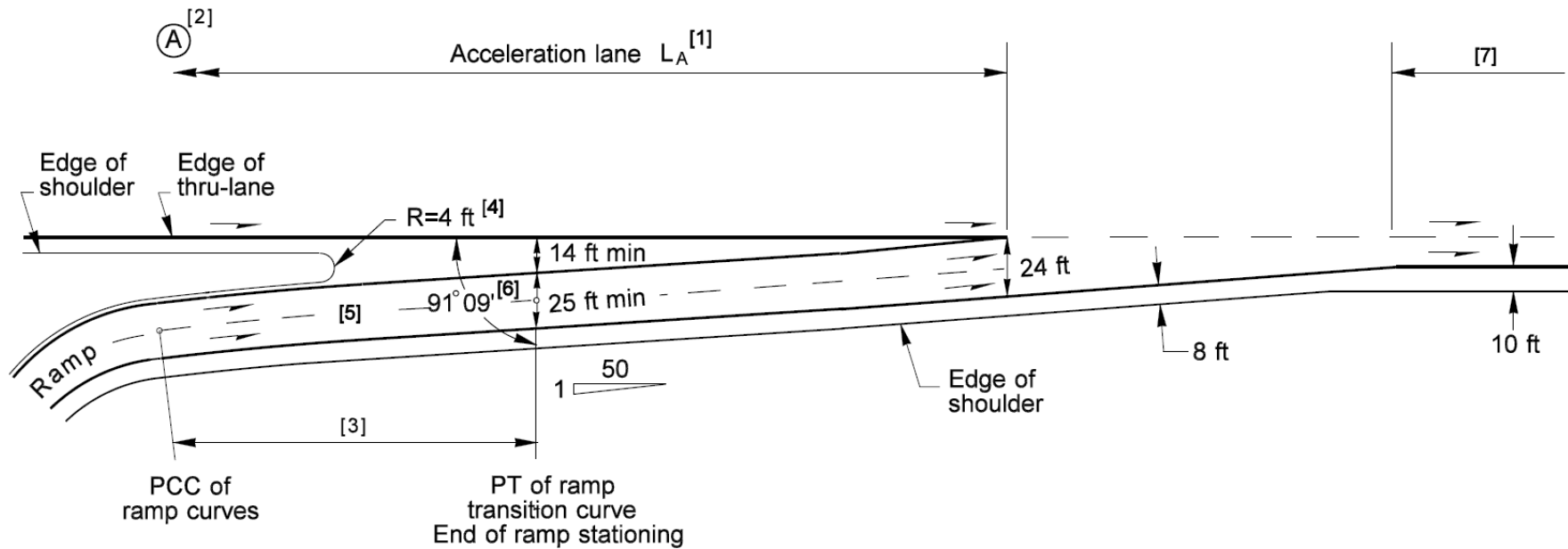

Notes:

- [1] For acceleration lane length L_A , see Exhibit 1360-9.
- [2] Point A is the point controlling the ramp design speed.
- [3] A transition curve with a minimum radius of 3000 ft is desirable. The desirable length is 300 ft. When the main line is on a curve to the left, the transition may vary from a 3000-ft radius to tangent to the main line.
- [4] Radius may be reduced when concrete barrier is placed between the ramp and main line.
- [5] For ramp lane and shoulder widths, see Exhibit 1360-6.
- [6] Approximate angle to establish ramp alignment.
- [7] Added lane or 1,500-ft auxiliary lane plus 600-ft taper.

General:

For striping, see the *Standard Plans*

Lane and shoulder widths are shown for illustrative purposes. Determine lane and shoulder widths based on Exhibit 1360-6, and Chapters 1106 and 1230.

Exhibit 1360-14a Off-Connection: Single-Lane, Tapered

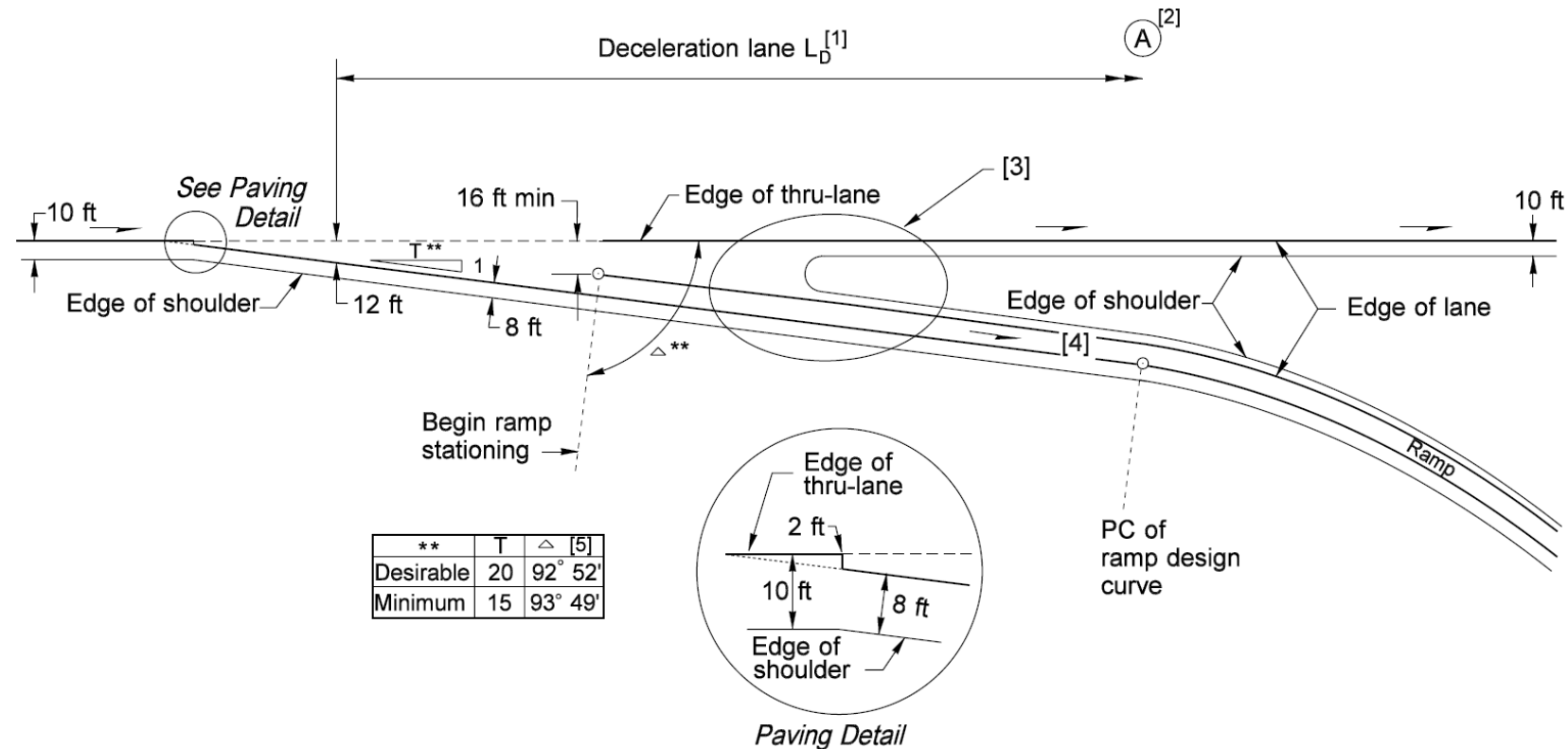

Notes:

- [1] For deceleration lane length L_D , see Exhibit 1360-10.
- [2] Point A is the point controlling the ramp design speed.
- [3] For gore details, see Exhibit 1360-11a.
- [4] For ramp lane and shoulder widths, see Exhibit 1360-6.
- [5] Approximate angle to establish ramp alignment.

General:

For striping, see the *Standard Plans*.

Lane and shoulder widths are shown for illustrative purposes. Determine lane and shoulder widths based on Exhibit 1360-6, and Chapters 1106 and 1230.

Exhibit 1360-14b Off-Connection: Single-Lane, Parallel

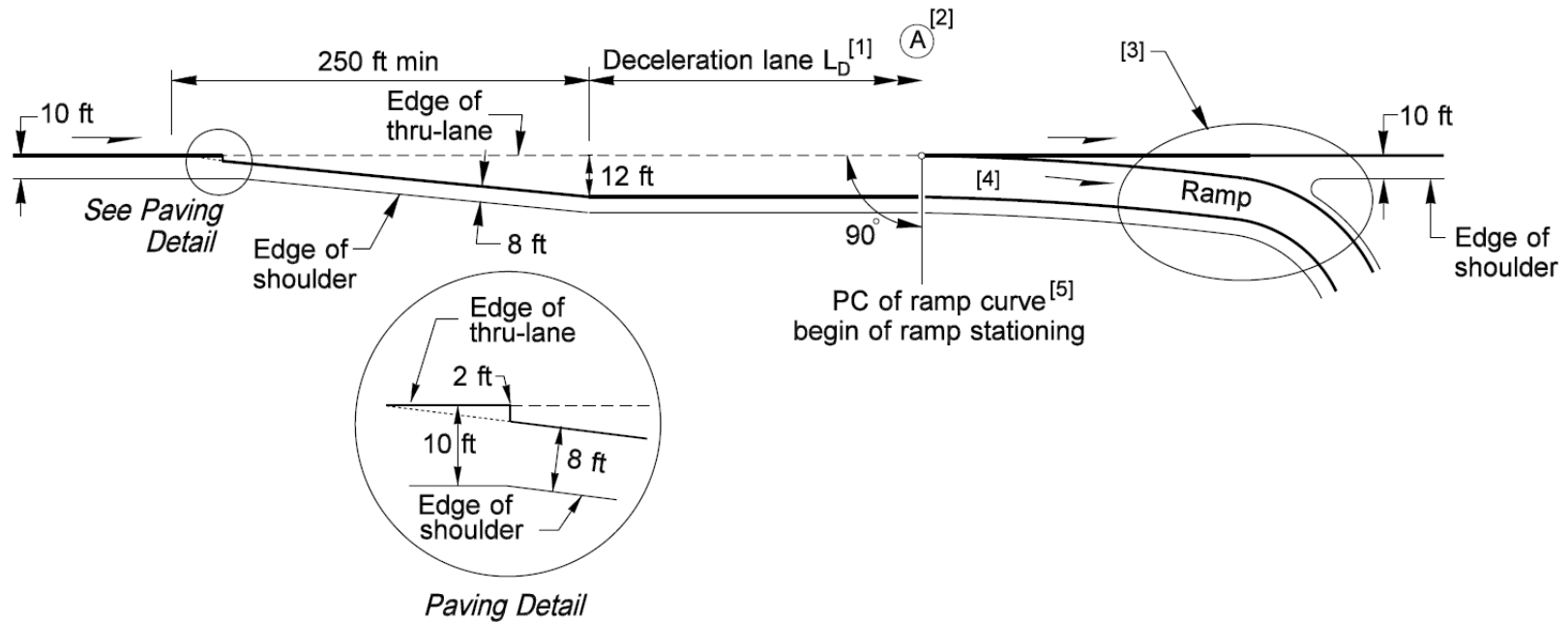

Notes:

- [1] For deceleration lane length L_D , see [Exhibit 1360-10](#).
- [2] Point A is the point controlling the ramp design speed.
- [3] For gore details, see [Exhibit 1360-11a](#).
- [4] For ramp lane and shoulder widths, see [Exhibit 1360-6](#).
- [5] Ramp stationing may be extended to accommodate superelevation transition.

General:

For striping, see the [Standard Plans](#).

Lane and shoulder widths are shown for illustrative purposes. Determine lane and shoulder widths based on [Exhibit 1360-6](#), and Chapters [1106](#) and [1230](#).

Exhibit 1360-14c Off-Connection: Single-Lane, One-Lane Reduction

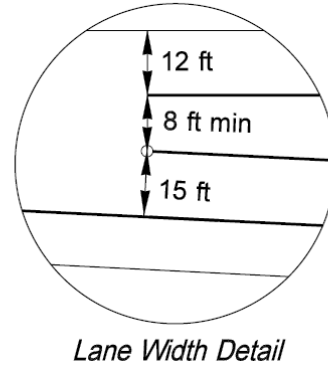
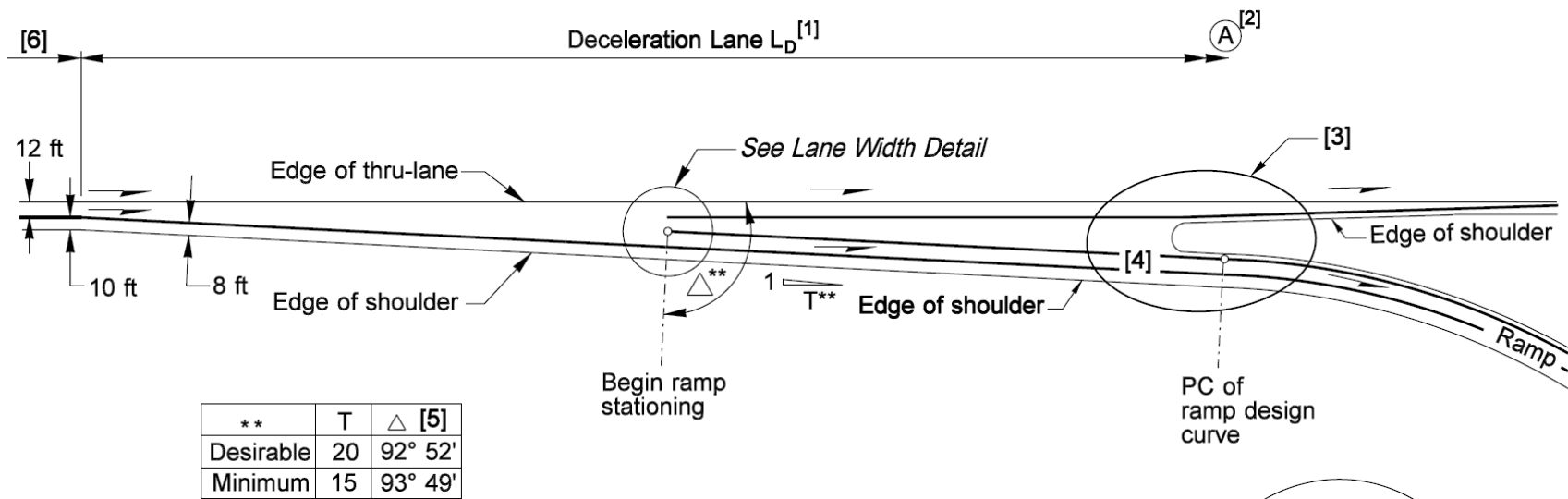

Notes:

- [1] For deceleration lane length LD, see Exhibit 1360-10.
- [2] Point A is the point controlling the ramp design speed.
- [3] For gore details, see Exhibit 1360-11b.
- [4] For ramp lane and shoulder widths, see Exhibit 1360-6.
- [5] Approximate angle to establish ramp alignment.
- [6] Auxiliary lane between closely spaced interchanges to be dropped.

General:

For striping, see the *Standard Plans*.

Lane and shoulder widths are shown for illustrative purposes. Determine lane and shoulder widths based on Exhibit 1360-6, and Chapters 1106 and 1230.

Exhibit 1360-14d Off-Connection: Two-Lane, Tapered

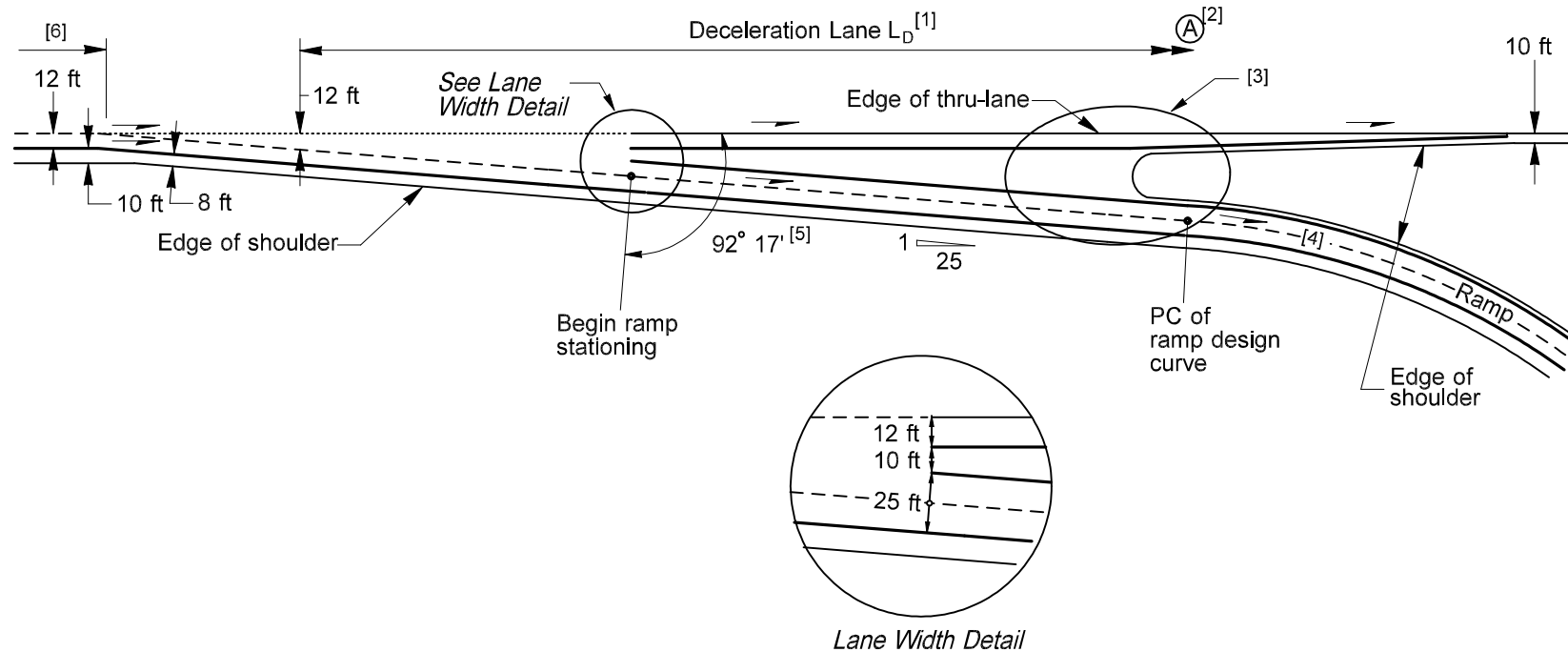
**Notes:**

- [1] For deceleration lane length L_D , see [Exhibit 1360-10](#).
- [2] Point **A** is the point controlling the ramp design speed.
- [3] For gore details, see [Exhibit 1360-11b](#).
- [4] For ramp lane and shoulder widths, see [Exhibit 1360-6](#).
- [5] Approximate angle to establish ramp alignment.
- [6] Lane to be dropped or auxiliary lane with a minimum length of 1,500 ft with a 300-ft taper.

General:

For striping, see the [Standard Plans](#).

Lane and shoulder widths are shown for illustrative purposes. Determine lane and shoulder widths based on [Exhibit 1360-6](#), and Chapters [1106](#) and [1230](#).

Exhibit 1360-14e Off-Connection: Two-Lane, Parallel

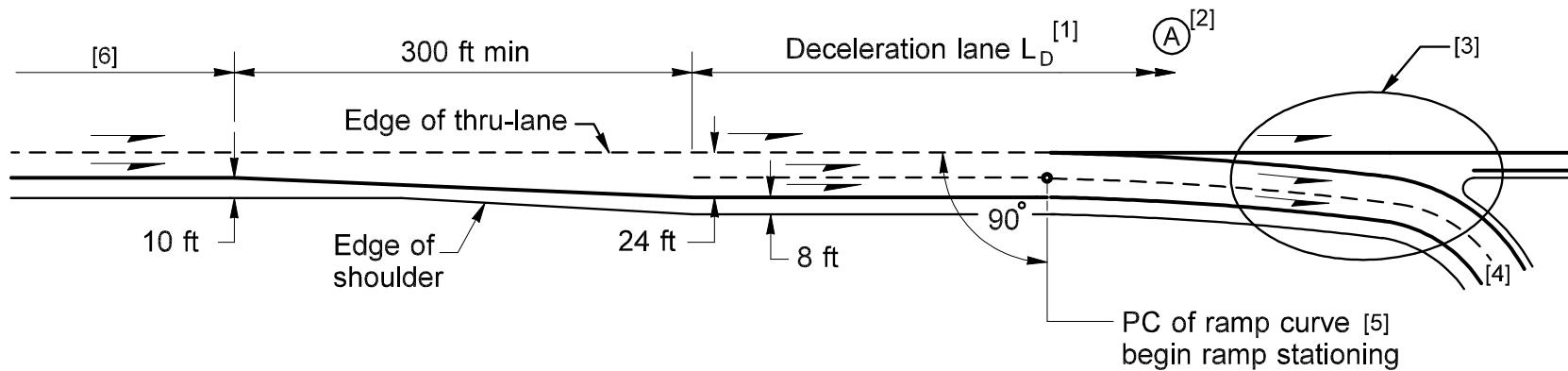
**Notes:**

- [1] For deceleration lane length L_D , see [Exhibit 1360-10](#).
- [2] Point A is the point controlling the ramp design speed.
- [3] For gore details, see [Exhibit 1360-11b](#).
- [4] For ramp lane and shoulder widths, see [Exhibit 1360-6](#).
- [5] Ramp stationing may be extended to accommodate superelevation transition.
- [6] Lane to be dropped or auxiliary lane with a minimum length of 1,500 ft with a 300-ft taper.

General:

For striping, see the [Standard Plans](#).

Lane and shoulder widths are shown for illustrative purposes. Determine lane and shoulder widths based on [Exhibit 1360-6](#), and Chapters [1106](#) and [1230](#).

Exhibit 1360-15a Collector-Distributor: Outer Separations

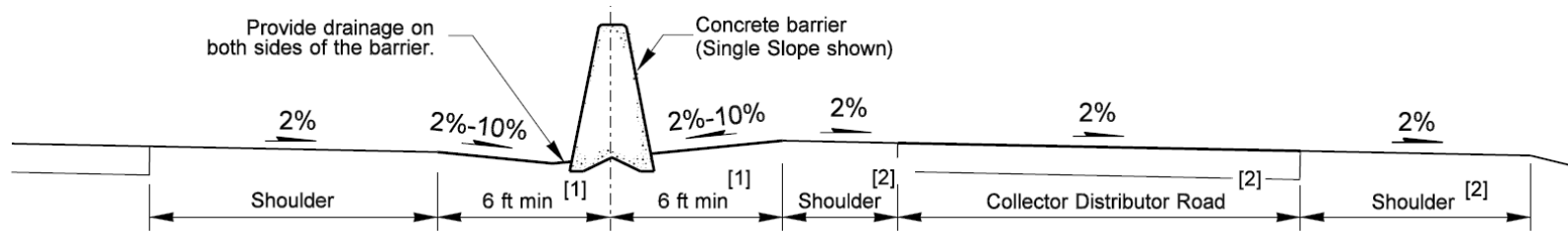

Design A

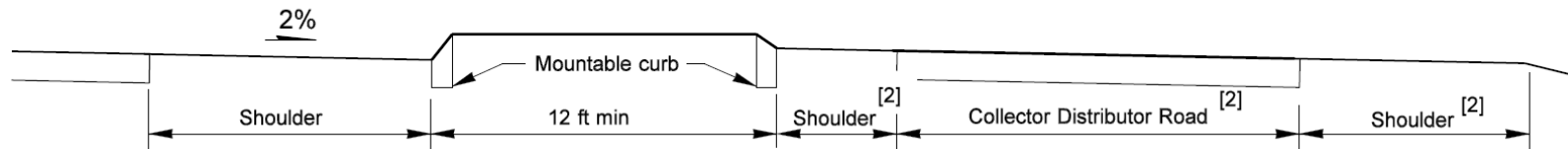

Design B

(For facilities with speeds of 40 MPH or less, only)

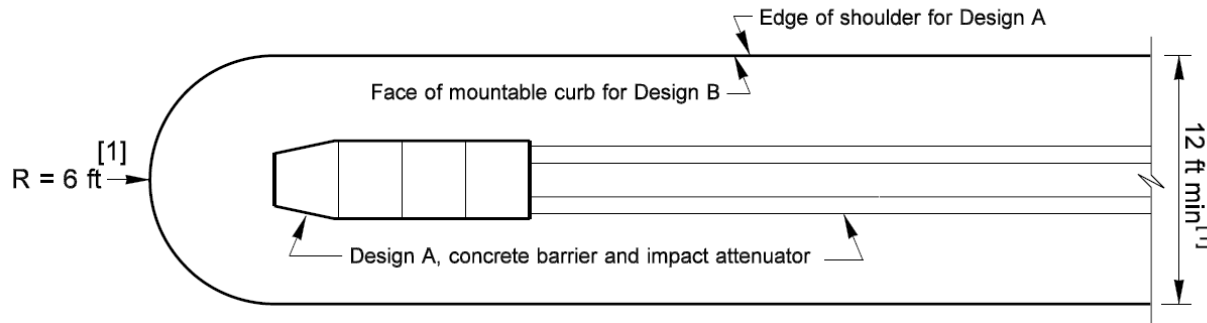

Notes:

- [1] With justification, the concrete barrier may be placed with 2 ft between the edge of either shoulder and the face of barrier. This reduces the width between the edge of through-lane shoulder and the edge of C-D road shoulder to 6 ft and the radius at the nose to 3 ft.
- [2] For collector-distributor road lane and shoulder widths, see ramp lane and shoulder widths, [Exhibit 1360-6](#).

Exhibit 1360-15b Collector Distributor: Off-Connections

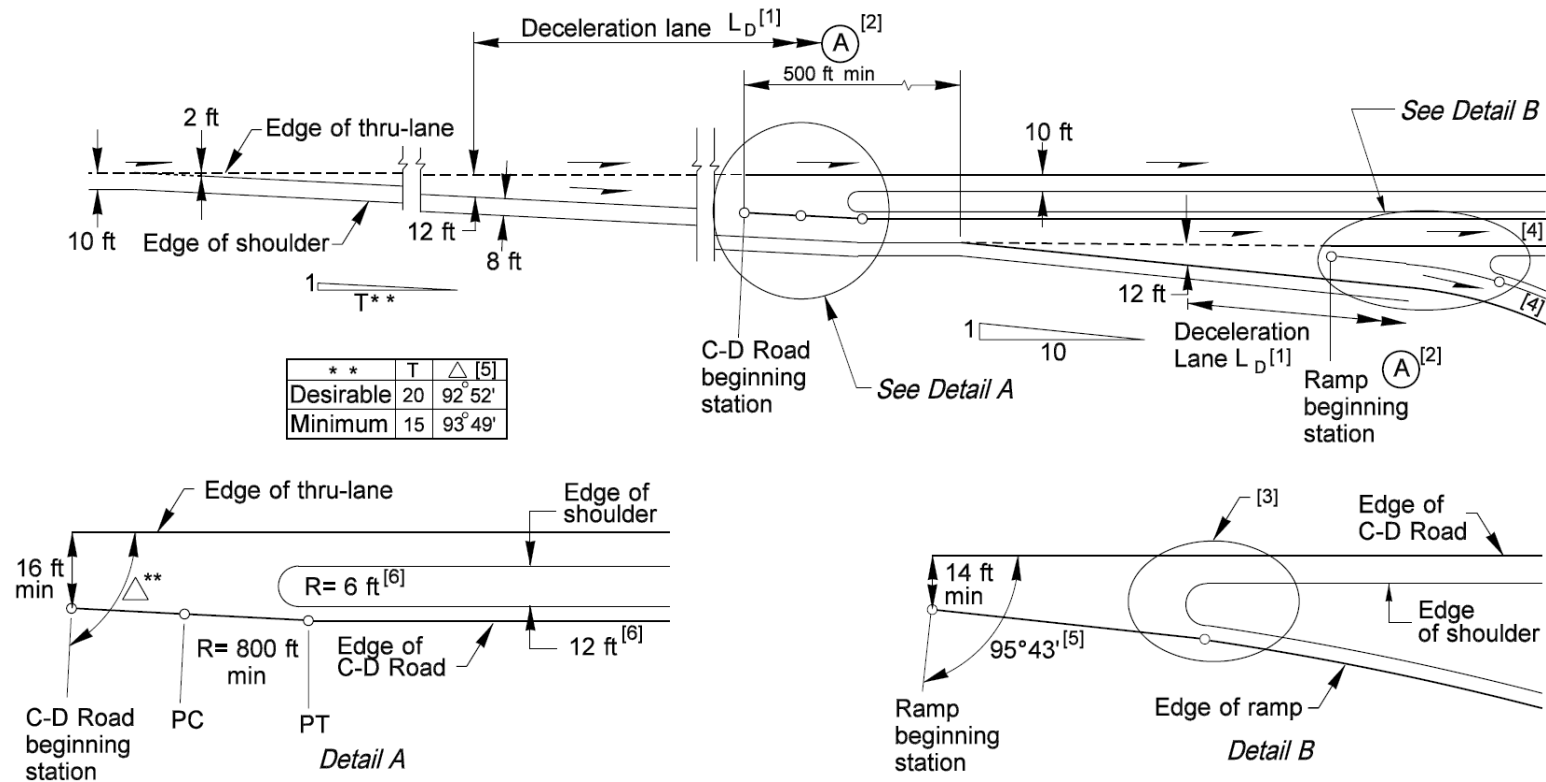

Notes:

- [1] For deceleration lane length LD, see Exhibit 1360-10.
- [2] Point A is the point controlling the C-D road or ramp design speed.
- [3] For gore details, see Exhibit 1360-11a.
- [4] For C-D road and ramp lane and shoulder widths, see Exhibit 1360-6.
- [5] Approximate angle to establish alignment.
- [6] May be reduced with justification (see Exhibit 1360-15a).

General:

For striping, see the Standard Plans.

Lane and shoulder widths are shown for illustrative purposes. Determine lane and shoulder widths based on Exhibit 1360-6, and Chapters 1230 and 1106.

Exhibit 1360-15c Collector Distributor: On-Connections

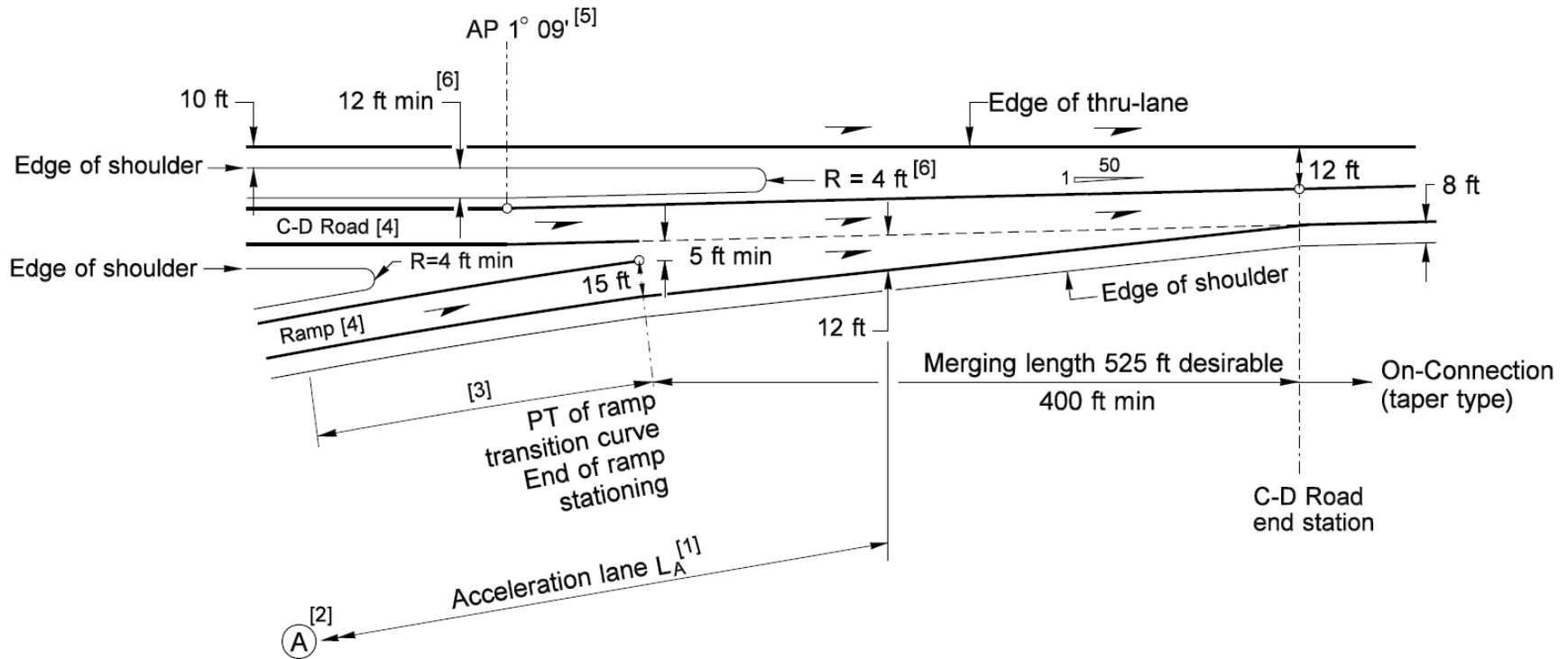

Notes:

- [1] For acceleration lane length L_A , see Exhibit 1360-9.
- [2] Point A is the point controlling the ramp design speed.
- [3] A transition curve with a minimum radius of 3000 ft is desirable. The desirable length is 300 ft. When the C-D road is on a curve to the left, the transition may vary from a 3000-ft radius to tangent to the C-D road.
- [4] For C-D road and ramp lane and shoulder widths, see Exhibit 1360-6.
- [5] Approximate angle to establish alignment.
- [6] May be reduced with justification (see Exhibit 1360-15a).

General:

For striping, see the *Standard Plans*.

Lane and shoulder widths are shown for illustrative purposes. Determine lane and shoulder widths based on Exhibit 1360-6, and Chapters 1230 and 1106.

Exhibit 1360-16 Loop Ramp Connections

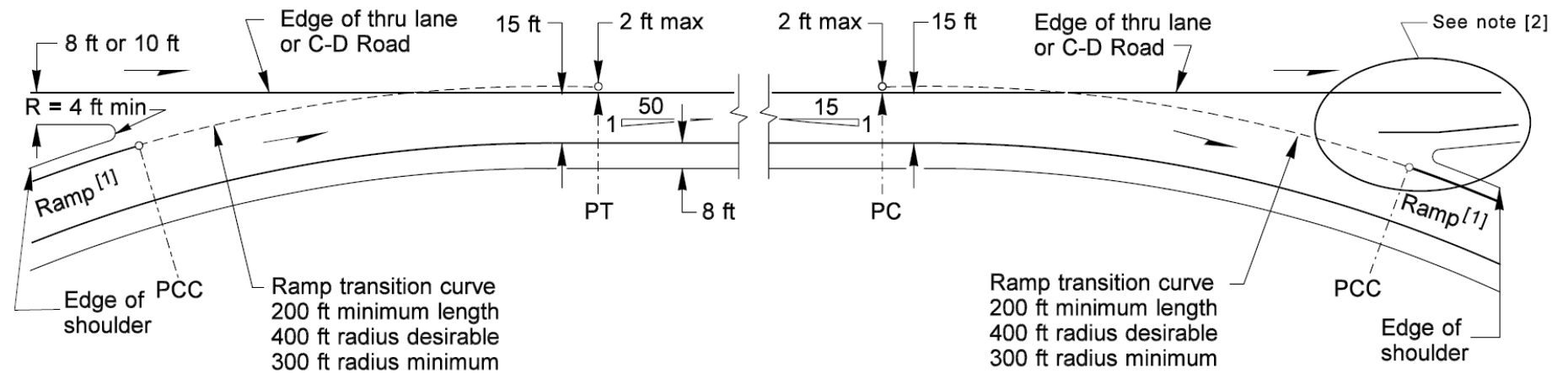

Notes:

- [1] For minimum weaving length, see [Exhibit 1360-12](#).
- [2] For minimum ramp lane and shoulder widths, see [Exhibit 1360-6](#).
- [3] For gore details, see [Exhibit 1360-11b](#).

General:

For gore details, see [Exhibit 1360-11b](#).
 Lane and shoulder widths are shown for illustrative purposes. Determine lane and shoulder widths based on [Exhibit 1360-6](#), and Chapters [1230](#) and [1106](#).

Exhibit 1360-17 Temporary Ramps

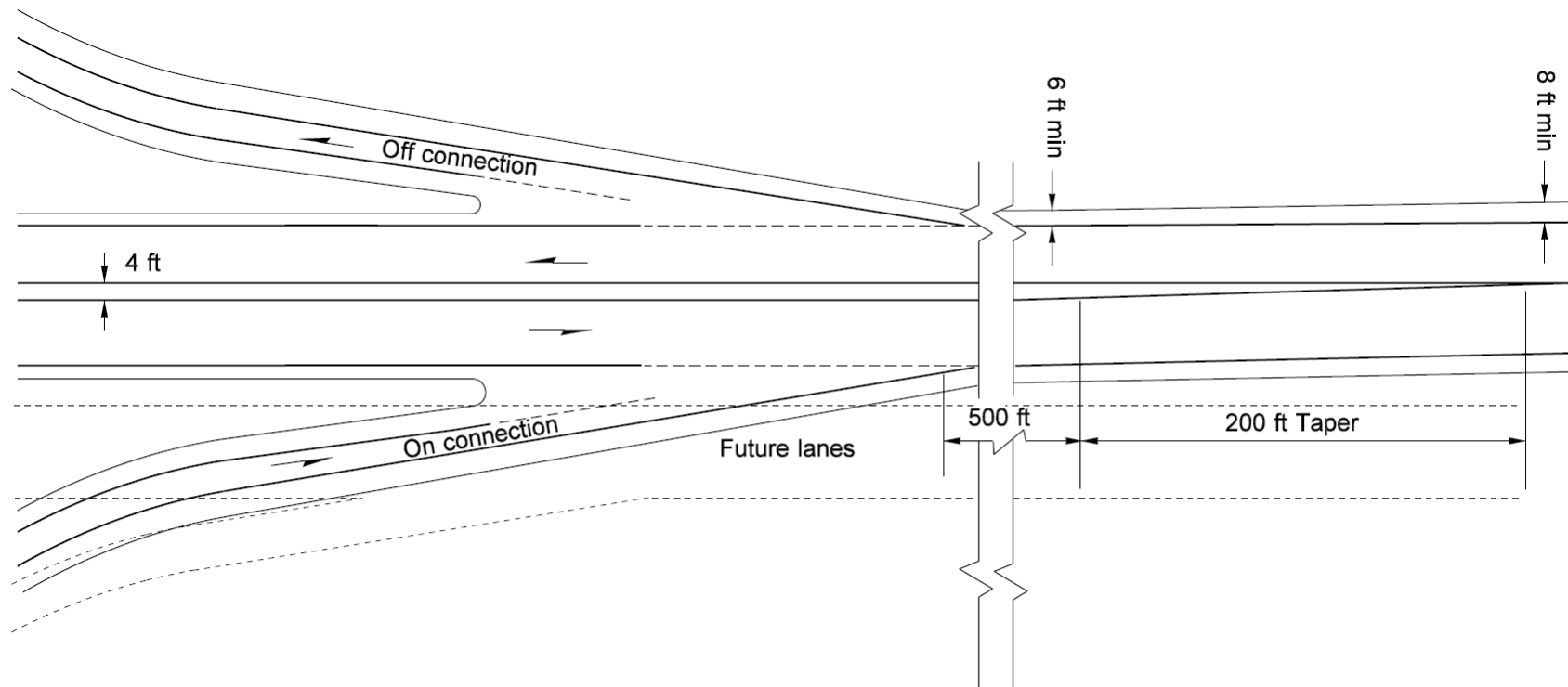
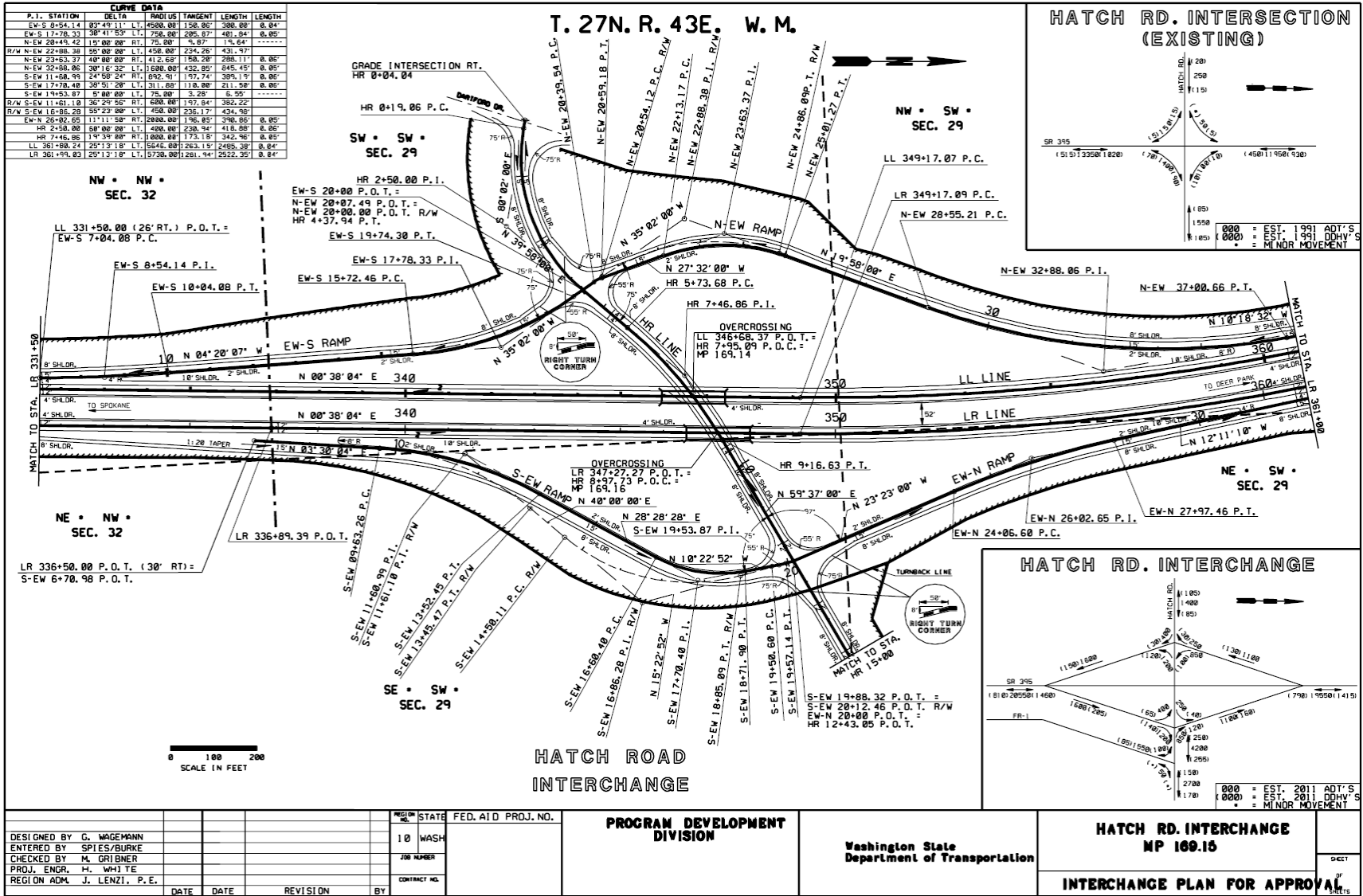

Exhibit 1360-18 Interchange Plan



- 1410.01 General
- 1410.02 References
- 1410.03 Definitions
- 1410.04 Preliminary Design and Planning
- 1410.05 Operations
- 1410.06 Design Criteria
- 1410.07 Documentation

1410.01 General

High-occupancy vehicle (HOV) facilities include separate HOV roadways, HOV lanes, transit lanes, HOV direct access ramps, and flyer stops. The objectives for the HOV facilities are:

- Improve the capability of corridors to move more people by increasing the number of people per vehicle.
- Provide travel time savings and a more reliable trip time to HOV lane users.
- Provide travel options for HOVs without adversely affecting the general-purpose lanes.

Plan, design, and construct HOV facilities that provide intermodal linkages. Give consideration to future highway system capacity needs. Whenever possible, design HOV lanes so that the level of service for the general-purpose lanes is not degraded.

In urban corridors that do not currently have planned or existing HOV lanes, complete an analysis of the need for HOV lanes before proceeding with any projects for additional general-purpose lanes. In corridors where both HOV and general-purpose facilities are planned, construct the HOV lane before or simultaneously with the construction of new general-purpose lanes.

For additional information, see the following chapters:

Chapter	Subject
1230	<u>Geometric</u> cross section
1240	General-purpose turning roadway widths
1420	HOV direct access

1410.02 References

(1) *Federal/State Laws and Codes*

[Revised Code of Washington \(RCW\) 46.61.165](#), High-occupancy vehicle lanes

[RCW 47.52.025](#), Additional powers – Controlling use of limited access facilities –High occupancy vehicle lanes

[Washington Administrative Code \(WAC\) 468-510-010](#), High occupancy vehicles (HOVs)

(2) Design Guidance

Manual on Uniform Traffic Control Devices for Streets and Highways, USDOT, FHWA; as adopted and modified by Chapter 468-95 WAC “Manual on uniform traffic control devices for streets and highways” (MUTCD)

Standard Plans for Road, Bridge, and Municipal Construction (Standard Plans), M 21-01, WSDOT

Traffic Manual, M 51-02, WSDOT

(3) Supporting Information

Design Features of High-Occupancy Vehicle Lanes, Institute of Traffic Engineers (ITE)

Guide for the Design of High-Occupancy Vehicle Facilities, American Association of State Highway and Transportation Officials (AASHTO)

High-Occupancy Vehicle Facilities, Parsons Brinkerhoff, Inc., 1990

HOV Systems Manual, NCHRP Report 414, 1998

1410.03 Definitions

buffer-separated HOV lane An HOV lane that is separated from the adjacent same direction general-purpose freeway lanes by a designated buffer.

bus rapid transit (BRT) An express rubber tired transit system operating predominantly in roadway managed lanes. It is generally characterized by separate roadway or buffer-separated HOV lanes, HOV direct access ramps, and a high-occupancy designation (3+ or higher).

business access transit (BAT) lanes A transit lane that allows use by other vehicles to access abutting businesses.

enforcement area A place where vehicles may be stopped for ticketing by law enforcement. It also may be used as an observation point and for emergency refuge.

enforcement observation point A place where a law enforcement officer may park and observe traffic.

flyer stop A transit stop inside the limited access boundaries.

high-occupancy toll (HOT) lane A managed lane that combines a high-occupancy vehicle lane and a toll lane.

high-occupancy vehicle (HOV) A vehicle that meets the occupancy requirements of the facility as authorized by [WAC 468-510-010](#).

HOV direct access ramp An on- or off-ramp exclusively for the use of HOVs that provides access between a freeway HOV lane and a street, transit support facility, or another freeway HOV lane without weaving across general-purpose lanes.

HOV facility A priority treatment for HOVs.

level of service A qualitative measure describing operational conditions within a traffic stream, incorporating factors of speed and travel time, freedom to maneuver, traffic interruptions, comfort and convenience, and safety.

1410.05 Operations

(1) Vehicle Occupancy Designation

Select the vehicle occupancy designation to provide the maximum movement of people in a corridor, provide free-flow HOV operations, reduce the empty lane perception, provide for the ability to accommodate future HOV growth within a corridor, and be consistent with the regional transportation plan and the policies adopted by the Metropolitan Planning Organization (MPO).

Establish an initial occupancy designation. It is Washington State Department of Transportation (WSDOT) policy to use the 2+ designation as the initial occupancy designation. Consider a 3+ occupancy designation if it is anticipated during initial operation that the volumes will be 1,500 vehicles per hour for a left-side HOV lane, or 1,200 vehicles per hour for a right-side HOV lane, or that a 45 mph operating speed cannot be maintained for more than 90% of the peak hour.

(2) Enforcement

Enforcement is necessary for the success of an HOV facility. Coordination with the Washington State Patrol (WSP) is critical when the operational characteristics and design alternatives are being established. This involvement ensures the project is enforceable and will receive their support.

Provide both enforcement areas and observation points for high-speed HOV lanes and ramp facilities.

Barrier-separated facilities, because of the limited access, are the easiest facilities to enforce. Shoulders provided to accommodate breakdowns may also be used for enforcement. Reversible facilities have ramps for the reverse direction that may be used for enforcement. Gaps in the barrier may be needed so emergency vehicles can access barrier-separated HOV lanes.

Buffer-separated and nonseparated HOV lanes allow violators to easily enter and exit the HOV lane. Provide strategically located enforcement areas and observation points.

Consider the impact on safety and visibility for the overall facility during the planning and design of enforcement areas and observation points. Where HOV facilities do not have enforcement areas, or where officers perceive that the enforcement areas are inadequate, enforcement on the facility will be difficult and less effective.

(3) Intelligent Transportation Systems

The objective of Intelligent Transportation Systems (ITS) is to make more efficient use of our transportation network. This is done by collecting data, managing traffic, and relaying information to the motoring public.

It is important that an ITS system be incorporated into the HOV project and that the HOV facility fully utilize the ITS features available. This includes providing a strategy of incident management since vehicle breakdowns and crashes have a significant impact on the efficient operation of the HOV facilities. (For more information on ITS, see [Chapter 1050](#).)

1410.06 Design Criteria

(1) Design Procedures

Refer to chapters in the 1100 series for practical design guidance and procedures.

(2) Design Considerations

HOV lanes are designed to the same criteria as the facilities to which they are attached. Design nonseparated and buffer-separated HOV lanes to match the vertical alignment, horizontal alignment, and cross slope of the adjacent lane.

(3) Adding an HOV Lane

The options for adding an HOV lane are: reconstruction, restriping, combined reconstruction and restriping, and possibly lane conversion.

(a) Reconstruction

Reconstruction involves creating roadway width. Additional right of way may be required.

(b) Restriping

Restriping involves reallocating the existing paved roadway to create enough space to provide an additional HOV lane.

(c) Combined Reconstruction and Restriping

Reconstruction and restriping can be combined to maximize use of the available right of way. For example, a new lane can be created through a combination of median reconstruction, shoulder reconstruction, and lane restriping. Handle each project on a case-by-case basis. Generally, consider the following reductions in order of preference:

- Reduction of the inside shoulder width, provided the enforcement and safety mitigation issues are addressed. (Give consideration to not precluding future HOV direct access ramps by over-reduction of the available median width.)
- Reduction of the interior general-purpose lane width to 11 feet.
- Reduction of the outside general-purpose lane width to 11 feet.
- Reduction of the HOV lane to 11 feet.
- Reduction of the outside shoulder width to 8 feet.

(d) Lane Conversion

If lane width adjustments are made, thoroughly eradicate the old lane markings. It is desirable that longitudinal joints (new or existing) not conflict with tire track lines. If they do, consider overlaying the roadway before restriping.

Both Exhibits [1410-4a](#) and [4b](#) show an observation point/enforcement area. Document any other enforcement area designs in the design documentation package. An alternative is to provide a 10 foot outside shoulder from the stop bar to the main line.

(5) HOV Direct Access Ramps

HOV direct access ramps provide access between an HOV lane and another freeway, a local arterial street, a flyer stop, or a park & ride facility. Design HOV direct access ramps in accordance with [Chapter 1420](#).

(6) HOV Lane Termination

Locate the beginning and end of an HOV lane at logical points. Provide decision sight distance, signing, and pavement markings at the termination points.

The desirable method of terminating an inside HOV lane is to provide a straight through move for the HOV traffic, ending the HOV restriction and dropping a general-purpose lane on the right. However, analyze volumes for both the HOV lanes and general-purpose lanes, as well as the geometric conditions, to optimize the overall operational performance of the facility.

(7) Enforcement Areas

Enforcement of the inside HOV lane can be done with a minimum 10-foot inside shoulder. For continuous lengths of barrier exceeding 2 miles, a 12-foot shoulder is recommended for the whole length of the barrier.

For inside shoulders less than 10 feet, locate enforcement and observation areas at 1 to 2-mile intervals or based on the recommendations of the WSP. These areas can also serve as refuge areas for disabled vehicles (see Exhibits [1410-5a](#) and [5b](#)).

Provide observation points approximately 1,300 feet before enforcement areas. They can be designed to serve both patrol cars and motorcycles or motorcycles only. Coordinate with the WSP during the design stage to provide effective placement and utilization of the observation points. Median openings give motorcycle officers the added advantage of being able to quickly respond to emergencies in the opposing lanes (see [Exhibit 1410-5b](#)). The ideal observation point places the motorcycle officer 3 feet above the HOV lane and outside the shoulder so the officer can look down into a vehicle.

Locate the enforcement area on the right side for queue bypasses and downstream from the stop bar so the officer can be an effective deterrent (see Exhibits [1410-4a](#) and [4b](#)).

An optional signal status indicator for enforcement may be placed at HOV lane installations that are metered. The indicator faces the enforcement area so that a WSP officer can determine whether vehicles are violating the ramp meter. The indicator allows the WSP officer to simultaneously enforce two areas: the ramp meter and the HOV lane. Consult with the WSP regarding use at all locations.

For additional information on enforcement signal heads, see the [Traffic Manual](#) regarding HOV metered bypasses.

(8) Signs and Pavement Markings

(a) Signs

Provide post-mounted HOV preferential lane signs next to the HOV lane or overhead-mounted signs over the HOV lane. Make the sign wording clear and precise, stating which lane is restricted, the type of HOVs allowed, and the HOV vehicle occupancy designation for that section of road. The sign size, location, and spacing are dependent upon the conditions under which the sign is used. Roadside signs can also be used to convey other HOV information such as the HERO program, carpool information, telephone numbers, and violation fines. Some situations may call for the use of variable message signs.

Place overhead signs directly over the HOV lane to provide maximum visibility. Use a sequence of overhead signs at the beginning and end of freeway HOV facilities. Overhead signs can also be used in conjunction with roadside signs along the roadway.

(b) Pavement Markings

Provide pavement markings that conform to the *Traffic Manual* and the *Standard Plans*.

(c) Interchanges

In the vicinity of interchange on- and off-connections where merging or exiting traffic crosses an HOV lane, make provisions for general-purpose traffic using the HOV lane. These provisions include signing and striping that clearly show the changes in HOV versus general traffic restrictions. (See the *Standard Plans* for pavement markings and signing.)

1410.07 Documentation

Refer to [Chapter 300](#) for design documentation requirements.

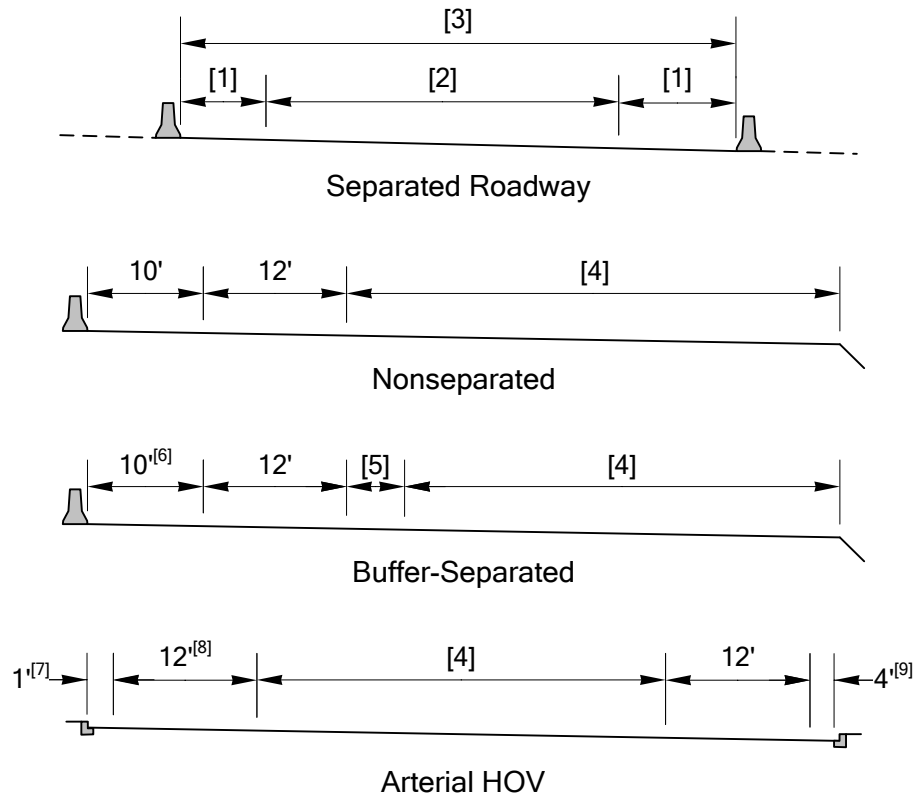
**Notes:**

- [1] The sum of the two shoulders is 12 ft for one-lane and 14 ft for two-lane facilities. Provide one shoulder with a width of at least 10 ft for disabled vehicles. The wider shoulder may be on the left or the right. Maintain the wide shoulder on the same side throughout the facility (see [1410.06\(4\)\(a\)2](#)).
- [2] 12-ft minimum for single lane, 24-ft minimum for two lanes. Wider width is required on curves (see [1410.06\(4\)\(a\)1](#) and [Exhibit 1410-1](#)).
- [3] For total width requirements, see [1410.06\(4\)\(a\)3](#).
- [4] Width as required, and the number of lanes.
- [5] Buffer 2 to 4 ft or 10 ft or more.
- [6] When buffer width is 4 ft or more, may be reduced to 8 ft.
- [7] 2 ft when adjacent to concrete barrier.
- [8] Arterial HOV lanes on the left operate in the same direction as the adjacent general-purpose lane.
- [9] May be reduced to 2 ft with justification.

Typical HOV Lane Sections
Exhibit 1410-2

Radius of Two-Lane Ramp R (ft)	Design Width of Third Lane ^[1] W (ft)
1,000 to Tangent	12
999 to 500	13
499 to 250	14
249 to 200	15
199 to 150	16
149 to 100	17

Notes:

- [1] Apply additional width to two-lane ramp widths.
- [2] For turning roadway widths, see traveled way width for two-lane one-way turning roadways in [Chapter 1240](#).

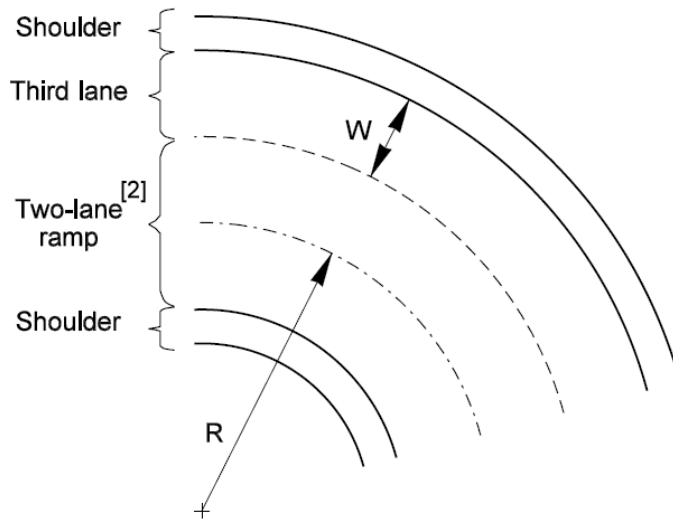

Roadway Widths for Two-Lane Ramps With an HOV Lane
 Exhibit 1410-3

1420.01	General
1420.02	HOV Access Types and Locations
1420.03	Direct Access Geometrics
1420.04	Passenger Access
1420.05	Traffic Design Elements
1420.06	Documentation
1420.07	References

1420.01 General

This chapter provides Washington State Department of Transportation (WSDOT) design guidance for left-side direct access facilities for high-occupancy vehicles (HOVs) between freeway HOV lanes and flyer stops within the freeway right of way or facilities outside of the right of way. Design right-side HOV-only access facilities in accordance with [Chapter 1360](#).

Direct access eliminates the need for left-side HOV lane users to cross the general-purpose lanes to right-side general-purpose ramps. Also, transit vehicles can use the HOV lane and provide service to the HOV direct access facility.

Providing the HOV user access to the inside HOV lane without mixing with the general-purpose traffic saves the user additional travel time and aids in safety, enforcement, incident handling, and overall operation of the HOV facility.

Locations for direct access ramps include HOV facilities on intersecting routes, park & ride lots, flyer stops, and locations with a demonstrated demand. Coordinate with the local transit agencies to identify these key locations. Give priority to locations that serve the greatest number of transit vehicles and other HOVs.

1420.01(1) *Practical Design*

Under WSDOT practical design (see [Chapter 1100](#) and Division 11) an important function of alternative solution formulation is to identify alternatives that address the baseline need while balancing the performance trade-offs identified in the process. Since HOV direct access connections are often added to existing corridors, performance tradeoffs to mainline GP lanes or other elements may be needed and acceptable to provide the new HOV connections. Document performance tradeoffs according to [Chapter 1100](#) and Division 11.

1420.01(2) *Reviews, Studies, and Reports*

The practical design project development process is to be followed when developing an HOV direct access project (see [Chapter 1100](#)). Despite the nature of the projects that are the focus of this chapter, most facets of the project development process remain unchanged. For example, early coordination with others is a vital part of developing a project. There are also environmental considerations, public involvement, and value engineering studies (see [Chapter 310](#)). There may also be reviews, studies, and reports required by agreements with regional transit authorities or other agencies.

Provide an interchange justification report (see [Chapter 550](#)) when there is a proposal to add, delete, or change an access point. Provide the operational analysis from the report for all flyer stops. For left-side connections, include the commitment that the connection will be used solely by HOVs or will be closed.

Throughout the project development phase, make sure the project:

- [Need Statement](#) (see [Chapter 1101](#)) and cost estimate are correct.
- Development process is on schedule.
- Documents are biddable.
- Will be constructible.
- Will be maintainable.

Constructability of HOV direct access facilities is an important consideration during the design phase. These facilities will typically be constructed on existing highways with traffic maintained on-site. Key goals are to:

- Provide a project that can be built.
- Plan a construction strategy.
- Provide a safe work zone.
- Minimize construction delays.

Consider access to these facilities by maintenance crews. Avoid items that require a significant maintenance effort and might result in lane closure for routine maintenance or repair.

1420.01(3) Left-Side Connections

Left-side connections are allowed only when they serve HOVs exclusively and connect to an HOV lane. The higher traffic volume associated with general-purpose traffic is not acceptable for left-side connections. If the demand for an HOV direct access decreases to the point that the HOV direct access connection is no longer desirable, the connection must be closed.

1420.02 HOV Access Types and Locations

To provide direct access for high-occupancy vehicles from the HOV lane to a passenger loading facility, there are many options and many constraints. Following are some of the options (selected as being usable on Washington's freeways) and constraints regarding their use.

To select an option, first establish the need, choose possible locations, evaluate site features (such as terrain, existing structures, median widths), and evaluate existing HOV information (such as lanes, park & ride facilities, transit routes and schedules, and origin and destination studies). Choose a location that meets access point spacing requirements and will not degrade traffic operations on the main line.

Important constraints to transit stop designs are:

- Passenger access routes and waiting areas are separated from freeway traffic.
- Passenger access to a bus is on its right side only.
- Passenger access to a loading platform must accommodate the disabled.

1420.02(1) Freeway Ramp Connection Locations

1420.02(1)(a) Spacing

For minimum ramp connection spacing, see [Chapter 1360](#). When evaluating the spacing of left-side direct access ramps, include only left-side connections.

Traffic operations can be degraded by the weaving caused by a left-side on-connection followed closely by a right-side off-connection (or a right-side on-connection followed by a left-side off-connection). As a general rule, if the spacing between the HOV direct access ramp and the general-purpose ramp is less than one gap acceptance length (see [1420.03\(6\)\(c\)](#)) per lane, make the HOV lane buffer-separated (see [Chapter 1410](#)).

Conduct an analysis to make certain that the new ramp will not degrade traffic operations. (See [Chapter 550](#) for the studies and report required for a new access point.)

When an off-connection follows an on-connection, provide full speed-change lane lengths and tapers or at least sufficient distance for full speed-change lanes that connect at full width with no tapers (see [1420.03\(6\)](#) and [\(7\)](#)). An auxiliary lane can be used to connect full-width speed-change lanes if there is not sufficient distance for both tapers.

1420.02(1)(b) Sight Distance

Locate both on- and off-connections to the main line where decision sight distance exists on the main line (see [Chapter 1260](#)).

1420.02(2) Ramp Terminal Locations

1420.02(2)(a) Local Streets and Roads

Access to the HOV lane can be provided by a ramp that terminates at a local street or road. The local street or road may incorporate HOV lanes, but they are not required. (See [1420.05](#) for signing and pavement markings.)

Consider traffic operations on the local road. Locate the terminal where:

- It has the least impact on the local road.
- Intersection spacing criteria are satisfied.
- Queues from adjacent intersections do not block the ramp.
- Queues at the ramp do not block adjacent intersections.
- Wrong-way movements are discouraged.

When off-ramps and on-ramps are opposite each other on the local road, consider incorporating a transit stop with the intersection.

1420.02(2)(b) Park & Ride Lots

HOV direct access ramps that connect the HOV lane with a park & ride lot provide easy access for express transit vehicles between the HOV lane and a local service transit stop at the park & ride facility. Other HOV traffic using the access ramp enters through the park & ride lot, which can create operational conflicts.

1420.02(2)(c) Flyer Stops

Median flyer stops do not provide general access to the HOV lane. Access is from the HOV lane to the transit stop and back to the HOV lane. No other vehicle access is provided. Ramps to and from the flyer stops are restricted to transit vehicles only.

1420.02(3) Ramp Types

1420.02(3)(a) Drop Ramps

Drop ramps are generally straight, stay in the median, and connect the HOV lane with a local road or flyer stop. Following is a photo and an example of a drop ramp.



Drop ramp photograph from FHWA/PB HOV Interactive 1.0 High Occupancy Vehicle Data Base from the U.S., Canada, and Europe

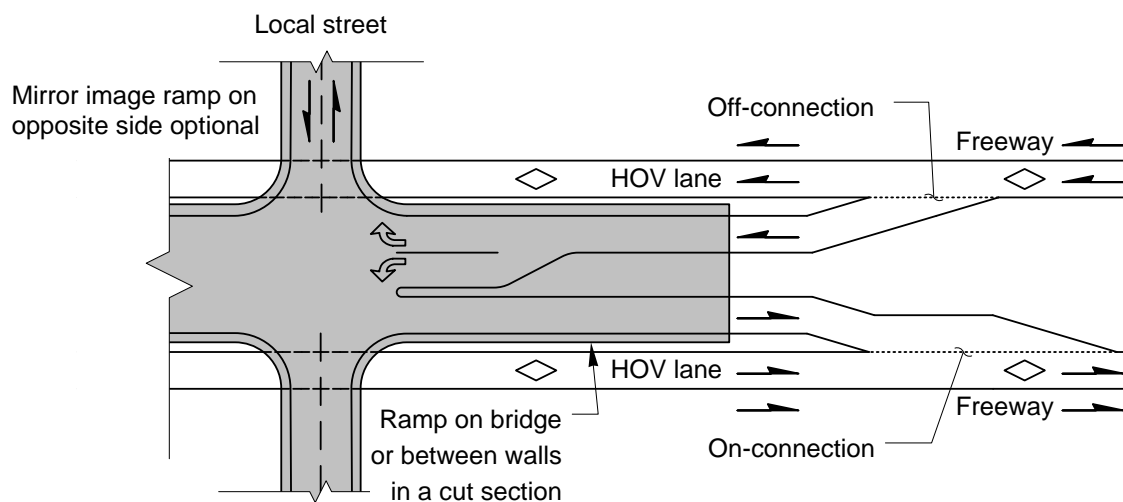

Consider this example for gore area characteristics for drop lanes:

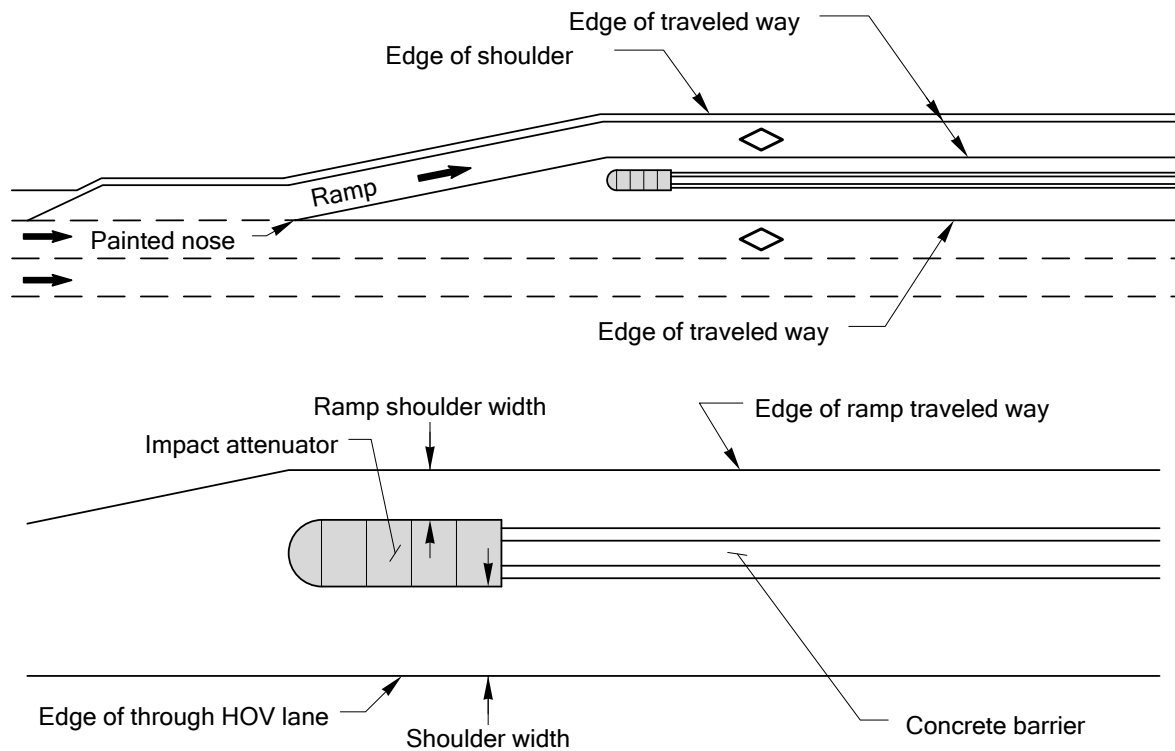

1420.02(3)(b) T Ramps

A T ramp is a median ramp that serves all four HOV access movements and comes to a T intersection within the median, usually on a structure. The structure then carries the HOV ramp over the freeway to a local road or directly to a park & ride lot. Through traffic is not permitted at the T ramp; therefore, flyer stops are not allowed. A photo and an example of a T ramp are shown for reference. Also, refer to [1420.03\(10\)](#) for added design information.



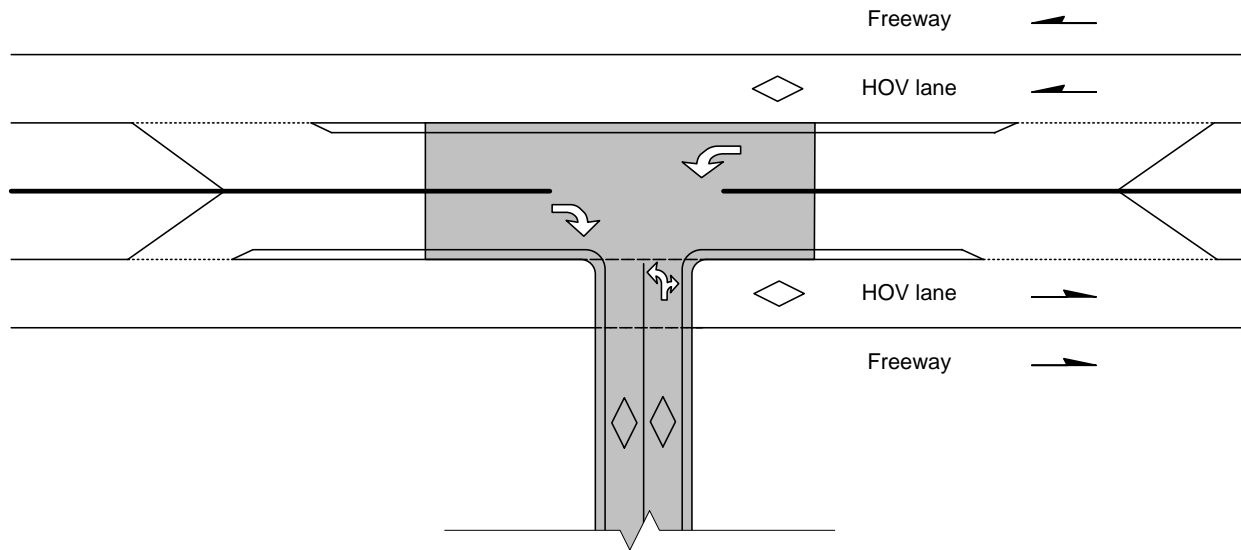

1420.02(3)(c) Flyover Ramps

A flyover ramp is designed to accommodate high-speed traffic by using flat curves as the ramp crosses from the median over one direction of the freeway to a local road, a park & ride lot, or an HOV lane on another freeway. A photo and an example of a flyover ramp are shown.



Flyover ramp photograph from FHWA/PB HOV Interactive 1.0 High Occupancy Vehicle Data Base from the U.S., Canada, and Europe

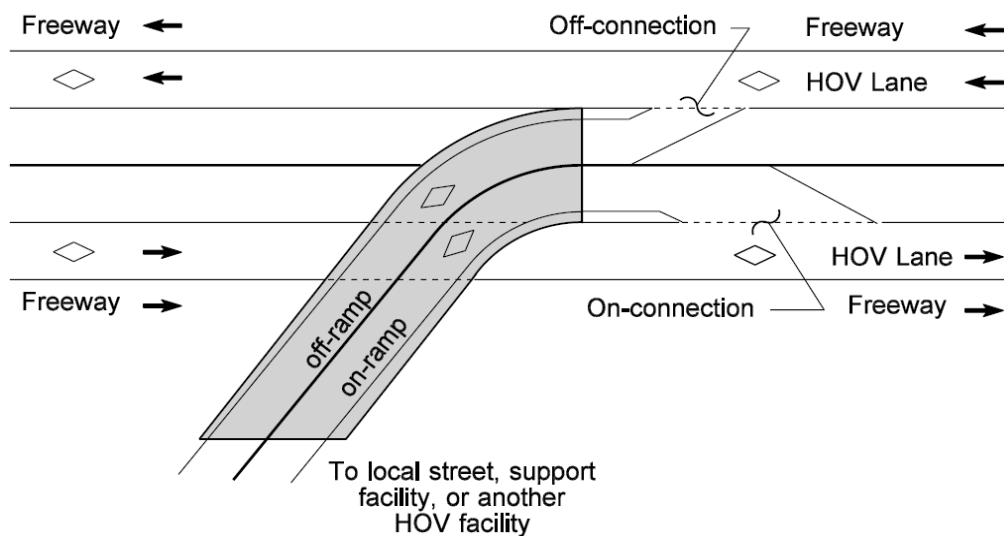

1420.02(4) Transit Stops

1420.02(4)(a) Flyer Stops

Flyer stops are transit stops inside the limited access boundaries for use by express transit vehicles using the freeway. They may be located in the median at the same grade as the main roadway or on a structure, on a ramp, or on the right side of the main line.

The advantage of a median flyer stop is that it reduces the time for express transit vehicles to serve intermediate destinations. A disadvantage is that passengers travel greater distances to reach the loading platform.

With left-side HOV lanes, flyer stops located on the right side increase the delay to the express transit vehicles by requiring them to cross the general-purpose lanes. However, these stops improve passenger access from that side of the freeway.

For additional design information, see [Chapter 1430](#).

1. Side-Platform Flyer Stops

Side-platform flyer stops are normally located in the median and have two passenger loading platforms: one on each side between the bus loading lane and the through HOV lane. This design provides the most direct movement for the express transit vehicle and is the desirable design for median flyer stops.

This design is relatively wide. Where space is a concern, consider staggering the loading platforms longitudinally.



Consider tall barrier to divide the directions of travel or staggering the loading platforms to discourage unauthorized at-grade movement of passengers from one platform to the other (see [1420.05\(1\)](#)). The side platform flyer stop with grade-separated access to each platform is the preferred design.

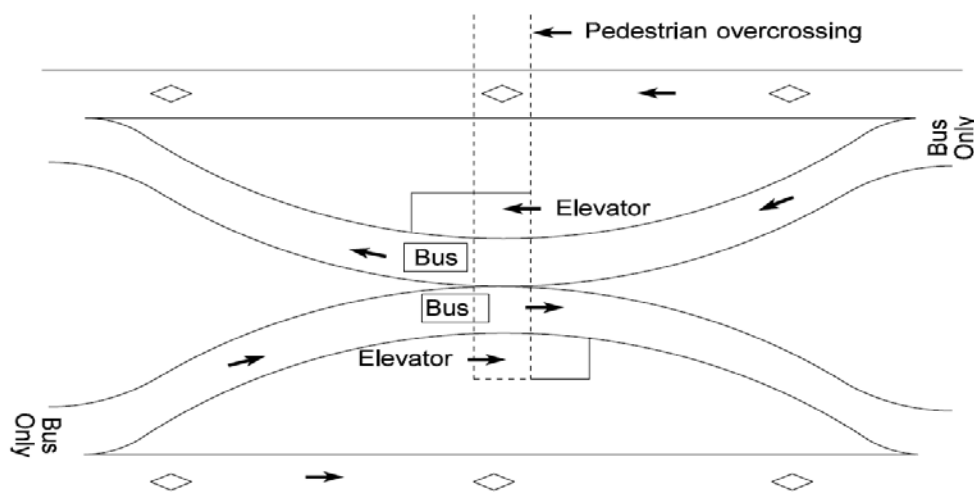

2. At-Grade Passenger Crossings

This design is similar to the side-platform flyer stop, except that passengers are allowed to cross, from one platform to the other, at grade. This design might eliminate the need for passenger access to one of the loading platforms with a ramp or an elevator, and it simplifies transfers. The passenger crossing necessitates providing a gap in the barrier for the crosswalk. Only transit vehicles are allowed. Passenger/ pedestrian accommodations must comply with the ADA.



At-grade passenger crossing photograph from FHWA/PB HOV Interactive 1.0 High Occupancy Vehicle Data Base from the U.S., Canada, and Europe

Consider an at-grade passenger crossing flyer stop only when passenger volumes are expected to be low. Design at-grade passenger crossing flyer stops as the first stage of the stop, with the ultimate design being side-platform flyer stops with grade-separated access to both platforms.

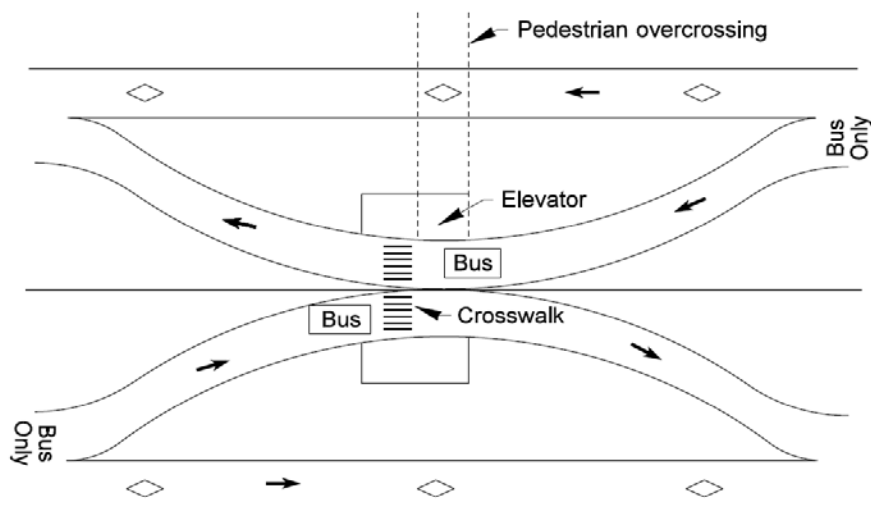

3. Ramp Flyer Stops

When ramp flyer stops are located on an HOV direct access drop ramp, the delay for the express transit vehicle will not be much more than for a median stop, and passenger access and connectivity to local service transit routes, on the local street or road, are improved. A flyer stop on a right-side ramp works well with right-side HOV lanes and diamond interchanges in which express transit vehicles can use the off-ramp to connect with a bus route on the local road and the on-ramp to return to the HOV lane. However, a stop on a general-purpose right-side ramp with a left-side HOV lane will increase the delay by requiring the express transit vehicle to use the general-purpose lanes and possibly degrade main line traffic operations by increasing weaving movements.

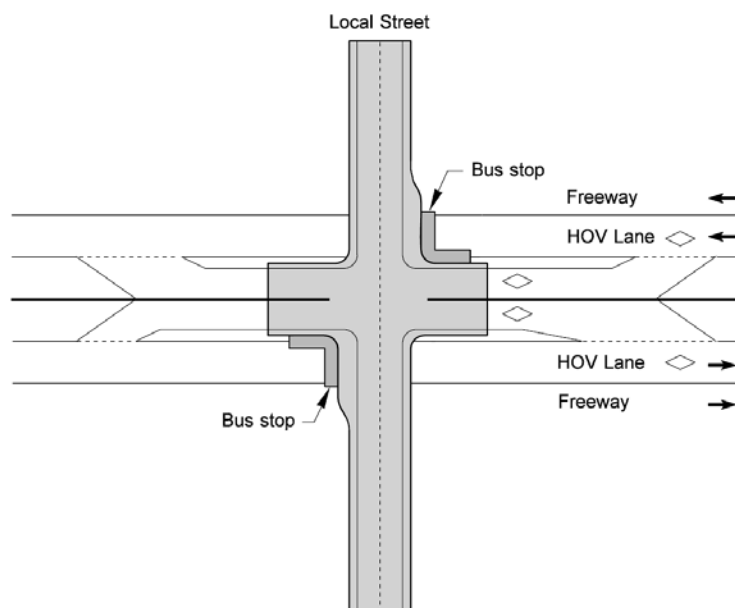

1420.02(4)(b) Off-Line Transit Stops

1. Park & Ride Stops

Transit stops located at park & ride lots provide transfer points between the express transit system and the local transit system, and there is convenient passenger access to the park & ride lot. When a direct access ramp is provided, express transit delays from the HOV lane to the stop are reduced. These delays can be reduced more by providing a median flyer stop with passenger access facilities connecting the park & ride lot to the flyer stop; however, this might be more inconvenient for the passengers.

2. Stops at Flyer Stop Passenger Access Points

To minimize the passenger travel distance between express and local service transit stops, locate local system transit stops near passenger access facilities for the flyer stops.

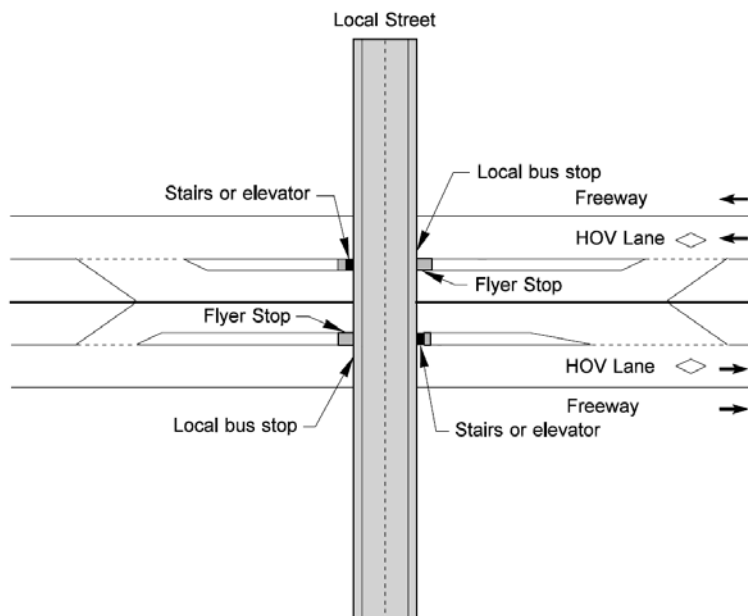

1420.02(5) Enforcement Areas

Enforcing the vehicle occupancy requirement helps the HOV facilities function as intended. Law enforcement officers need areas for observation that are near pull-out areas, where both the violator and the officer can pull safely out of the traffic flow.

Consider locating observation and pull-out areas near any point where violators can enter or exit an HOV direct access facility. Examples of potential locations are:

- Freeway on- and off-connections for HOV direct access ramps.
- HOV direct access ramp terminals at parking lots.

For freeway HOV lanes, locate enforcement areas on the adjacent shoulders so officers and violators are not required to cross several lanes of traffic.

Enforcement area guidance and designs are in [Chapter 1410](#).

1420.03 Direct Access Geometrics

HOV direct access ramps are different than other ramps because they are usually on the left side of the through lanes and they have a high percentage of buses. Design right-side HOV direct access using the procedures given in [Chapter 1360](#). The following procedures are for the design of left-side HOV direct access.

Because left-side ramps are rare and therefore less expected, signing is an important issue. (For signing guidance, see [1420.05\(2\)](#).)

When the bus percentage is high, there are several considerations:

- When a bus enters the through lanes from the left, the driver has a relatively poor view of the through traffic.
- A bus requires a longer distance to accelerate than other vehicles.
- A bus requires a longer deceleration length for passenger comfort.

1420.03(1) Design Vehicles

Use the following design vehicles for left-side HOV direct access facilities:

- Use AASHTO's A BUS vehicle for horizontal design.
- Use AASHTO's SU-30 vehicle for vertical design.
- Use AASHTO's P vehicle for stopping sight distance.

Refer to Chapters [1300](#) and [1430](#), and the AASHTO Green Book for vehicle descriptions and dimensions. Use turn simulation software (such as AutoTURN[®]) to verify turning movements.

1420.03(2) Design Speeds

Refer to [Chapter 1360](#) for the design speeds for ramps. Use the design speed of the general-purpose lanes for the main line design speed.

1420.03(3) **Sight Distance**

Provide stopping sight distance in accordance with [Chapter 1260](#). This provides sight distance for an automobile. The longer distance needed for a bus to stop is compensated for by the greater eye height of the driver, with the resulting vertical curve length about equal to that for an automobile.

Sag vertical curves may be shortened where necessary. (See [Chapter 1220](#) for guidance.)

1420.03(4) **Grades**

Grades for ramps are covered in [Chapter 1360](#). Deviations will be considered for:

- Downgrade on-ramps with grades increased by an additional 1%.
- Upgrade off-ramps with grades increased by an additional 2%.

These increased grades help when geometrics are restricted, and they assist transit vehicles with the acceleration when entering and the deceleration when exiting the freeway.

1420.03(5) **Ramp Widths**

1420.03(5)(a) **Lane Widths**

Use widths for separated roadway HOV facilities. (See Minimum Traveled Way Widths for Articulated Buses in [Chapter 1410](#).) On tangents, the minimum lane width may be reduced to 12 feet.

1420.03(5)(b) **Shoulder Widths**

Ramp shoulder width criteria are modified as follows:

- The minimum width for the sum of the two shoulders is 10 feet for one-lane ramps and 12 feet for two or more lanes.
- The minimum width for one of the shoulders is 8 feet for disabled vehicles. The minimum width for the other shoulder is 2 feet. (See [Chapter 1610](#) for shy distance at barrier.)
- The wider shoulder may be on the left or the right. Maintain the wide shoulder on the same side throughout the ramp.

Minimum Ramp Widths for Articulated Buses	
R (ft)*	W _R (ft)
Tangent	21
500	23
400	23
300	24
200	26
150	27
100	30
75	34
50	40
*R is to the curve inside edge of traveled way	

1420.03(5)(c) **Total Ramp Widths**

When an A-BUS is the intersection design vehicle at the ramp terminal, make the total width of the ramp (lane width plus shoulders) wide enough to allow an A-BUS to pass a stalled A-BUS. This width has two components:

- The vehicle width (U = 8.5 feet on tangent) for each vehicle
- Lateral clearance (C = 2 feet) for each vehicle

The vehicle width and the lateral clearance are about the width of an A-BUS from edge of mirror to edge of mirror.

The table above gives the minimum ramp width (W_R), including shoulders, at various radii (R) for an articulated bus. For ramp locations on a tangent section or on a curve with a radius greater than 150 feet, consider the W_R width when requesting a reduced lane or shoulder width. For ramp curves with a radius less than 150 feet, check the total ramp width and, if necessary, widen the shoulders to provide the W_R width.

1420.03(6) On-Connections

1420.03(6)(a) Parallel On-Connections

For left-side on-connections, use the parallel on-connection.

A parallel on-connection adds a parallel lane that is long enough for the merging vehicle to accelerate in the lane and then merge with the through traffic. This merge is similar to a lane change and the driver can use side and rear view mirrors to advantage.

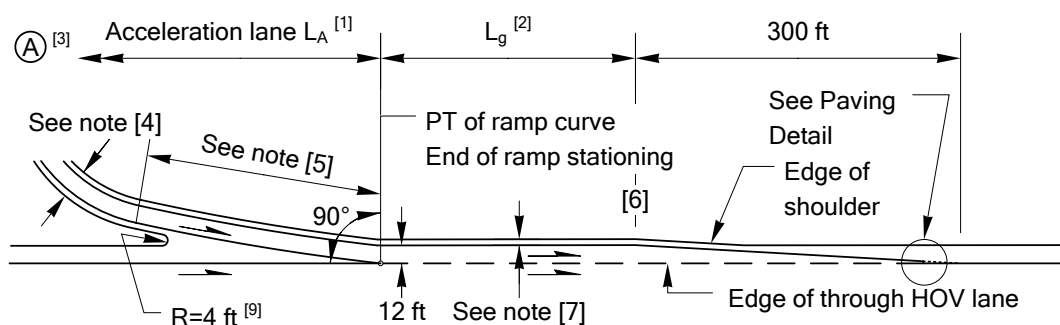

Notes:

- [1] For acceleration lane length L_A , see 1420.03(6)(b). Check L_A for each ramp design speed.
- [2] L_g is the gap acceptance length. Begin L_g at the beginning of the parallel lane, as shown, but not before the end of the acceleration lane L_A . (See 1420.03(6)(c) for the length L_g .)
- [3] Point (A) is the point controlling the ramp design speed or the end of the transit stop zone or other stopping point.
- [4] For ramp lane and shoulder widths, see 1420.03(5).
- [5] A transition curve with a minimum radius of 3,000 ft is desirable. The desirable length is 300 ft. When the main line is on a curve to the right, the transition may vary from a 3,000 ft radius to tangent to the main line. The transition curve may be replaced by a 50:1 taper with a minimum length of 300 ft.
- [6] Angle point for width transitions, when required. (See Chapter 1210 for pavement transitions.)
- [7] For ramp shoulder width, see 1420.03(5)(b).
- [8] The 10 ft left shoulder is the minimum width; 14 ft is desirable. Maintain this shoulder width for at least 500 ft; 1,000 ft is desirable.
- [9] Radius may be reduced when concrete barrier is placed between the ramp and main line.

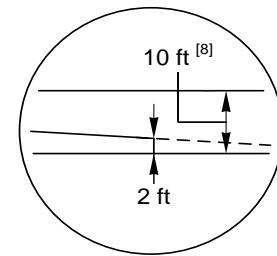

Paving Detail

General:

For striping, see the *Standard Plans*.

Lane widths are shown for illustrative purposes. Determine lane widths according to 1420.03(5)(c), Chapter 1230 and using Chapter 1106 procedures. Verify lane width selection with transit providers that may utilize these connections.

1420.03(6)(b) Acceleration Lanes

The table below gives the minimum acceleration lane length (L_A) for left-side HOV direct access on-connections.

The buses using HOV direct access ramps merge with high-speed traffic. Acceleration lanes that are longer than normally used are needed.

For left-side on-connections, consider at least the normal 10-foot-wide (14-foot desirable) left shoulder for the main line for a minimum length of 500 feet (1,000 feet desirable) beyond the end of the on-connection taper. This gives additional room for enforcement, merging, and erratic maneuvers.

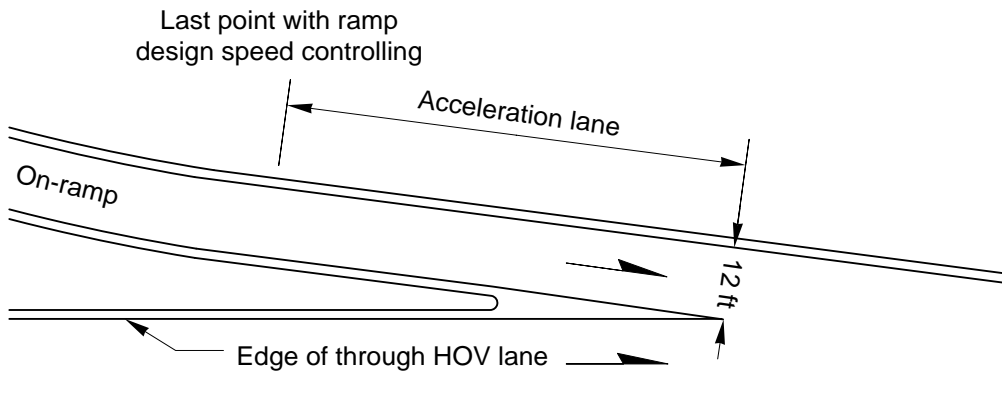

Freeway Speed (mph)	Ramp Design Speed								
	0	15	20	25	30	35	40	45	50
40	555	480	420	340	185				
45	835	760	700	615	470	290			
50	1,230	1,160	1,100	1,020	865	685	310		
55	1,785	1,715	1,655	1,575	1,420	1,235	875	410	
60	2,135	2,085	2,040	1,985	1,875	1,735	1,440	995	460
70	3,045	3,015	2,985	2,945	2,860	2,745	2,465	2,050	1,515
80	4,505	4,465	4,420	4,370	4,250	4,095	3,745	3,315	2,780

Acceleration Length (LA) for Buses (ft)

Notes: For the adjustment factors for grade, see acceleration lane in [Chapter 1360](#). Lane widths are shown for illustrative purposes. Determine lane widths according to [1420.03\(5\)\(c\)](#), [Chapter 1230](#) and using [Chapter 1106](#) procedures. Verify lane width selection with transit providers that may utilize these connections.

1420.03(6)(c) Gap Acceptance Length

Gap acceptance length is a minimum distance traveled while a merging driver finds a gap in the through traffic and begins the merge. For left-side parallel on-connections, the gap acceptance length is added to the acceleration length. The L_g values are given in the table below. These values are larger than for right-side on-connections to account for drivers' visibility constraints.

Highway Posted Speed (mph)	Gap Acceptance Length, L_g (ft)
45	550
50	625
55	700
60	775
65	850
70	925

1420.03(6)(d) Urban On-Connection Design

Design left-side HOV direct access on-connections in urban areas as follows:

1. Use the parallel design for left-side on-connections.
2. Add the Gap Acceptance Length for Parallel On-Connections (see [1420.03\(6\)\(c\)](#)) for a freeway speed of 60 mph to the acceleration length.
3. Use Acceleration Length for Buses (see [1420.03\(6\)\(b\)](#)) with a 60 mph freeway speed and the ramp design speed (see [1420.03\(2\)](#)) for acceleration length.

1420.03(6)(e) Rural On-Connection Design

Design left-side HOV direct access on-connections in rural areas using mainline design speed.

1420.03(7) Off-Connections**1420.03(7)(a) Parallel Off-Connection**

The parallel off-connection is desirable for left-side direct access off-connections. For freeway-to-freeway off-connections, provide a parallel lane with a length sufficient for signing and deceleration. The desirable minimum length is not less than the gap acceptance length (see [1420.03\(6\)\(c\)](#)).

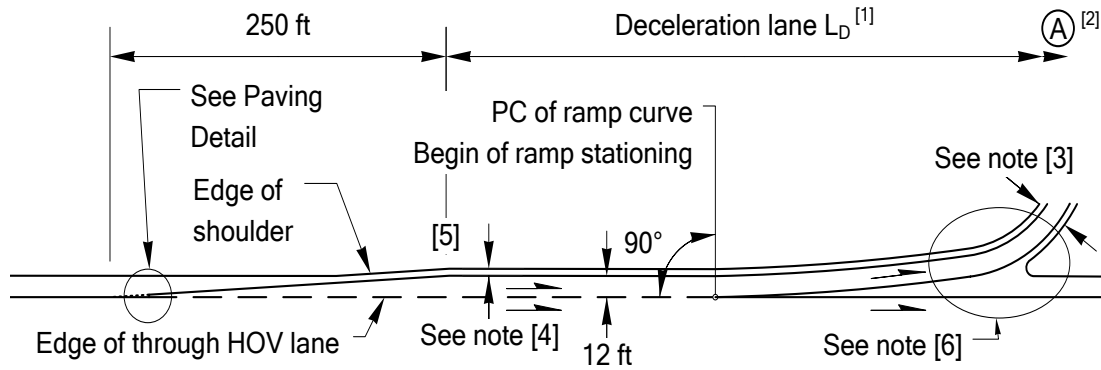
**Notes:**

- [1] For deceleration lane length L_D , see [1420.03\(7\)\(c\)](#). Check L_D for each ramp design speed.
- [2] Point **A** is the point controlling the ramp design speed or the end of the transit stop zone or other stopping point.
- [3] Lane widths are shown for illustrative purposes. Determine lane and shoulder widths according to [1420.03\(5\)\(c\)](#), [Chapter 1230](#) and using [Chapter 1106](#) procedures. Verify lane width selection with transit providers that may utilize these connections.
- [4] For ramp shoulder width, see [1420.03\(5\)\(b\)](#).
- [5] Angle point for width transitions, when required. (See [Chapter 1210](#) for pavement transitions.)
- [6] Gore area characteristics at drop ramp connections are shown on [1420.02\(3\)\(a\)](#). (See [Chapter 1360](#) for gore details at other connection types.)
- [7] The desirable shoulder width is 10 ft.

General:

For striping, see the [Standard Plans](#).

1420.03(7)(b) Tapered Off-Connection

The tapered off-connection may be used, with justification. (See [Chapter 1360](#) for the design of tapered off-connections.)

1420.03(7)(c) Deceleration Lanes

Bus passenger comfort requires longer deceleration lanes. Use the deceleration lane lengths from the table below for HOV direct access facilities.

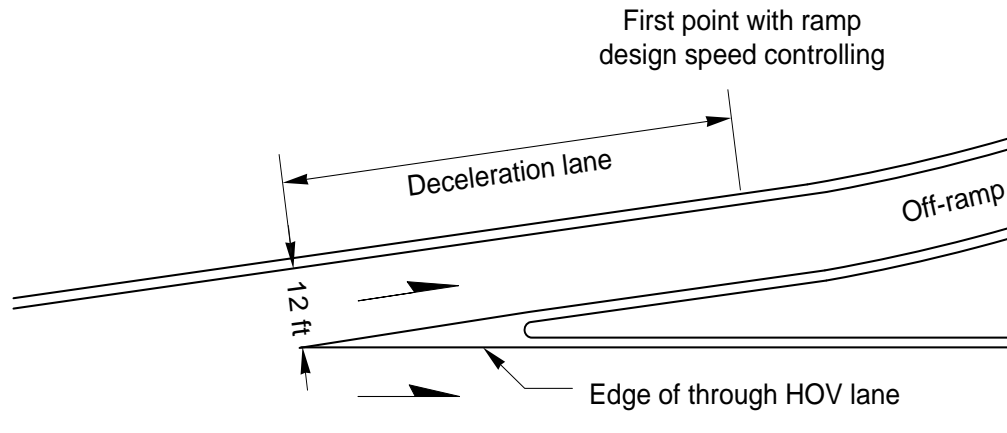

Freeway Speed (mph)	Ramp Design Speed								
	0	15	20	25	30	35	40	45	50
40	390	330	290	240	170	100			
45	470	420	380	330	260	190	90		
50	570	520	480	430	360	290	190	100	
55	680	620	590	540	470	400	300	210	110
60	800	740	700	660	580	520	420	330	230
70	990	930	900	850	780	710	610	520	420
80	1,210	1,150	1,110	1,060	990	920	830	740	640

Deceleration Length (L_D) for Buses (ft)

Notes: For the adjustment factors for grade, see deceleration lane in [Chapter 1360](#). Lane widths are shown for illustrative purposes. Determine lane widths according to [1420.03\(5\)\(c\)](#), [Chapter 1230](#) and using [Chapter 1106](#) procedures. Verify lane width selection with transit providers that may utilize these connections.

1420.03(7)(d) Urban Off-Connection Design

Design left-side HOV direct access off-connections in urban areas as follows:

1. Either the parallel (desirable) or the taper (with justification) design may be used.
2. Use the longer deceleration length of: the Deceleration Length for Buses (see [1420.03\(7\)\(c\)](#)) from a 60 mph freeway speed to the ramp design speed (see [1420.03\(2\)](#)) or the Minimum Deceleration Length given in [Chapter 1360](#) from the freeway design speed to the ramp design speed.

1420.03(7)(e) Rural Off-Connection Design

Design left-side HOV direct access off-connections in rural areas using mainline design speed.

1420.03(8) Vertical Clearance

Vertical clearance for a structure over a road is measured from the lower roadway surface, including the usable shoulders, to the bottom of the overhead structure.

Refer to [Chapter 720](#) for information on vertical clearance.

The minimum vertical clearance for a pedestrian grade separation over any road is 17.5 feet.

1420.03(9) Flyer Stops

Design flyer-stop ramp on-connections as given in [1420.03\(6\)](#), and design off-connections as given in [1420.03\(7\)](#). Flyer stop connections are included in the access point spacing discussed in [1420.02\(1\)\(a\)](#).

Design the ramp to the flyer stop in accordance with [1420.03\(3\)](#), [1420.03\(4\)](#), and [1420.03\(5\)](#).

The minimum width for the roadway at a flyer stop is 24 feet.

When a flyer stop is in the median, provide enough median width for the flyer stop roadway, passenger facilities, and barrier separation without reducing the width of the through lanes or shoulders (see [1420.04](#)).

The approval of a flyer stop requires the operational analysis portion of the interchange justification report (see [Chapter 550](#)).

1420.03(10) Wrong-Way Driving Countermeasures

The following bulleted items and examples are countermeasures for wrong-way driving at HOV direct access ramps:

- Provide a staggered traffic arrow to better describe the left and right turns.
- Provide pavement marking extensions, using wide lines, through intersections.
- Use redundant directional pavement arrows at ramp terminals.
- Paint or use reflective sheeting to highlight barrier terminals.
- Locate the left barrier end to provide good visibility for left-turning traffic for both the barrier terminal and the on-ramp roadway.
- Extend the right barrier as far as feasible while providing a 4-foot clearance for the left-turning exiting design vehicle.
- Provide redundant signing.
- Provide enlarged warning signs.

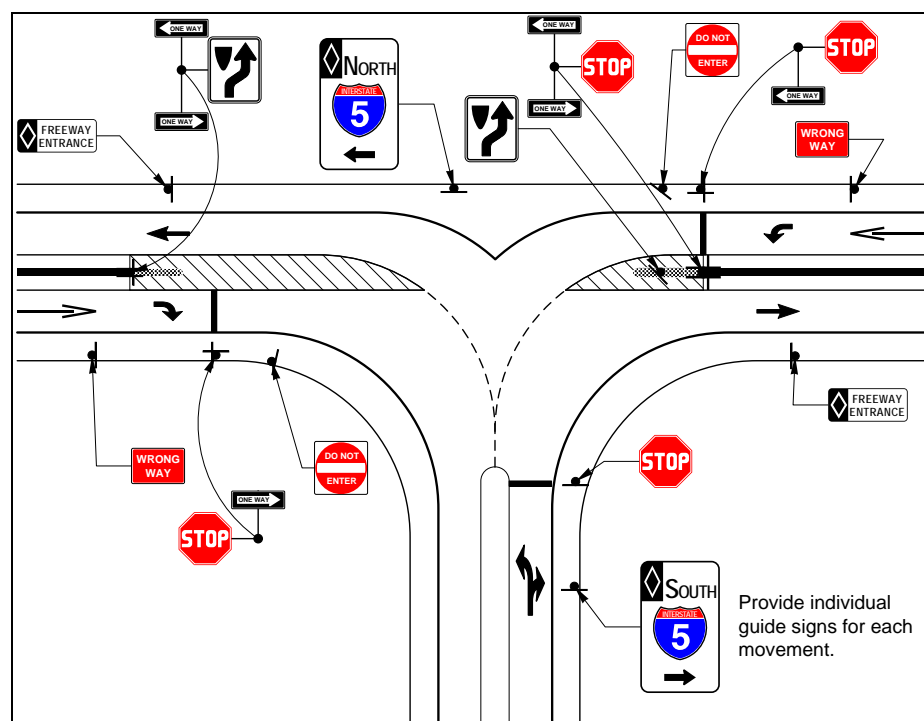
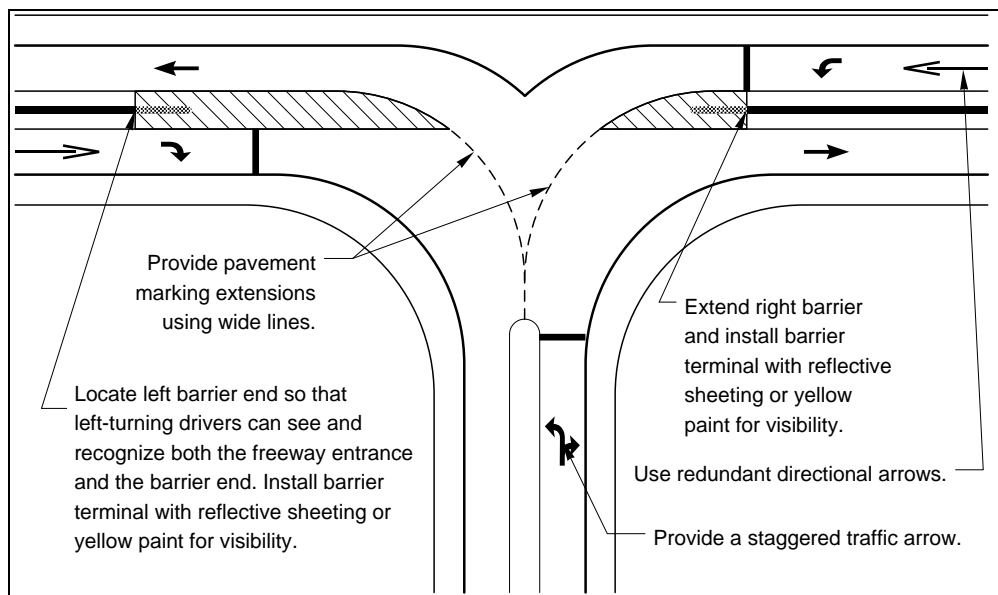

1420.04 Passenger Access

When designing transit stops, include accessibility (compliance with the ADA), safety, and the comfort of passengers. Minimize pedestrian/vehicle conflict points. Design the whole facility with security in mind by keeping lines of sight as open as possible. Traffic barriers, fencing, illumination, landscaping, seating, windscreens, shelters, enclosed walkways, telephones, and posted schedules are examples of items that contribute to passenger safety and well-being. (See [Chapter 1430](#) for passenger amenities at transit stops.)

1420.04(1) Passengers

To encourage use of the passenger access facility for an express transit stop, provide a route that is the shortest distance to travel from the park & ride lot or local transit stop. Failure to do so might generate the use of undesirable shortcuts. To encourage local use of the passenger access facilities, provide direct access from surrounding neighborhoods.

Provide grade separations for pedestrian access to transit stops in the median. Consider stairways, ramps, elevators, and escalators, but provide at least one access for the disabled at every loading platform, as required by the American with Disabilities Act of 1990. (See Chapter 1510 for guidance when designing pedestrian grade separations.)

The ADA Accessibility Guidelines for Buildings and Facilities states, "Platform edges bordering a drop-off and not protected by platform screens or guard rails shall have a detectable warning ... 24 inches wide running the full length of the platform drop-off." (See the [Standard Plans](#) for the detectable warning pattern.)

At transit stops, at-grade crosswalks are only permitted in the at-grade crossing flyer stop layout described in [1420.02\(4\)\(a\)2](#). Use traffic calming techniques, such as horizontal alignment, textured pavement and crosswalk markings, barrier openings, and other treatments, to channelize pedestrian movements and slow the transit vehicle's movements. Illuminate transit stop crosswalks (see [Chapter 1040](#)).

Where at-grade crosswalks are not permitted, take steps to minimize unauthorized at-grade crossings. Fencing, taller concrete traffic barrier, enclosed walkways, and ramps are examples of steps that may be taken.

1420.04(2) Bicycles

Bike lanes on nearby streets and separate trails encourage people to bicycle from surrounding neighborhoods. Provide these bicyclists direct access to passenger access facilities.

Design bicycle access facilities in conjunction with the access for the disabled (see Chapters [1510](#), [1515](#), and [1520](#)).

Locate bicycle parking outside of the passenger walkways (see [Chapter 1430](#)).

Locations near colleges and universities and locations with good bicycle access, especially near trails, will attract bicyclists. Contact the region Bicycle Coordinator for information on the predicted number of bicycle parking spaces needed and the types of bicycle racks available.

1420.05 Traffic Design Elements

Traffic design elements are critical to the safe and efficient use of HOV direct access facilities. The following discusses the elements of traffic design that might be different for HOV direct access facilities.

1420.05(1) Traffic Barriers

Separate the main line from the HOV direct access facilities with a traffic barrier. Whenever possible, separate opposing traffic lanes in the facility by using traffic barrier (see [Chapter 1610](#)). This is especially important in areas where opposing traffic is changing speeds to or from main line speeds. Concrete barrier is generally desirable on these facilities due to lower maintenance requirements.

Provide crashworthy end treatments to the approach ends of traffic barriers (see [Chapter 1620](#)).

When the operating speed is 25 mph or lower, and where an at-grade pedestrian crossing transit stop has an opening in a concrete barrier, a sloped-down end as shown in the [Standard Plans](#) is acceptable.

When providing a break in the barrier for turning maneuvers, consider sight distance (see [Chapter 1260](#)) when determining the location for stopping the barrier.

In areas where headlight glare is a concern, consider glare screens such as taller concrete barrier. Other glare screen options that mount on the top of a barrier tend to be high-maintenance items and are discouraged.

Taller barrier might also be desirable in areas where pedestrian access is discouraged, such as between opposing flyer stops or between a flyer stop and the main line.

1420.05(2) Signing

Design and place HOV signing to clearly indicate whether the signs are intended for motorists in the HOV lane or the general-purpose lanes. The purposes of the signs are to:

- Enhance safety.
- Convey the message that HOV lanes are restricted to HOVs.
- Provide clear directions for entrances and exits.
- Define vehicle occupancy requirements or other restrictions.

Because HOV facilities are not found in many regions, the signing not only considers the commuter but also the occasional user of the facility who might be unfamiliar with the HOV facility and its operation.

1420.05(2)(a) Safety

Much of HOV signing relates to enhancing safety for motorists. Not only are geometrics often minimized due to the lack of right of way, but there are unusual operational characteristics such as the differential speed between the HOV vehicle and the adjacent general-purpose traffic. To allow for the lack of passing opportunities in the HOV lane and the necessity for frequent merging and weaving actions, use messages that are clear and concise, and use symbols wherever possible.

Because left-side off-connections are unusual, advance warning signing alerting motorists that an exit is on the left becomes more important.

For T ramps, provide traffic control at the T to assign priority to one of the turn movements and to avert wrong-way movements.

1420.05(2)(b) Diamond Symbols

The diamond symbol is used to designate HOV facilities where carpools are allowed. For all signs, whether regulatory, guide, or warning, the symbol is white on a black background to convey the restrictive nature of the HOV lane and to make the signs more uniformly recognizable. The use of the symbol with all HOV signs also informs drivers that the message is intended for HOVs. The diamond symbol is only for HOV lanes where carpools are allowed; it is not used for bus, taxi, or bicycle preferential lanes.

1420.05(2)(c) Selection and Location

The signing details given throughout this section provide for the HOV geometric configurations used within the right of way. Signing for other types of HOV facilities (such as those used for reversible-flow and for HOV direct access between freeways and temporary HOV lanes used during construction) is designed on a case-by-case basis and requires consultation with the appropriate Headquarters and region traffic personnel. In addition to the normal regulatory signs, include HOV guide signs, both advance and action, in the design of signing for HOV direct access between freeways.

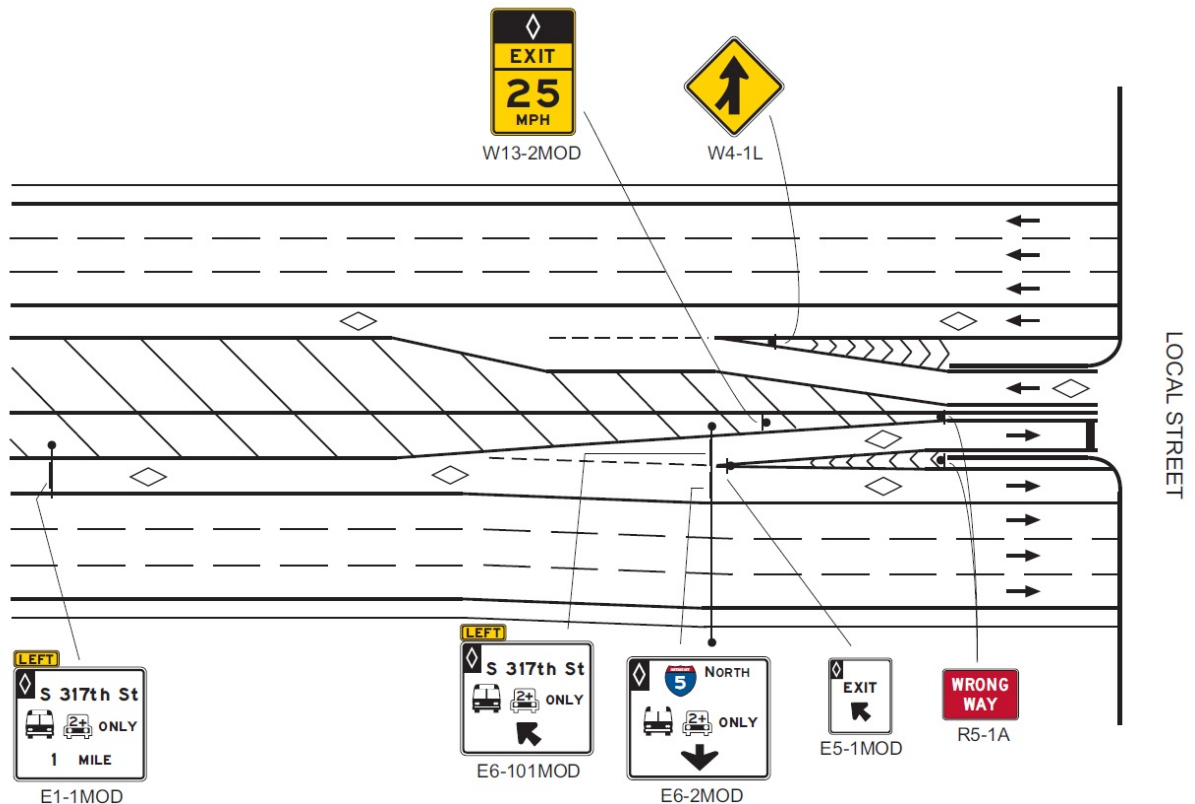

Notes:

- Place signs in accordance with the [MUTCD](#).
- For non-HOV sign details, see the [Sign Fabrication Manual](#).

1420.05(2)(d) Regulatory Signs

Regulatory signs for HOV facilities follow the normal regulatory signing principles: black legend with a white reflective background on a rectangular panel. Keep in mind that messages conveyed by the HOV signs (such as signs concerning violations and those indicating the beginning of an HOV lane downstream) are not necessarily intended only for the HOV vehicle. Therefore, it might be prudent to place additional signs on the right side of the freeway when doing so conforms to sound engineering practice.

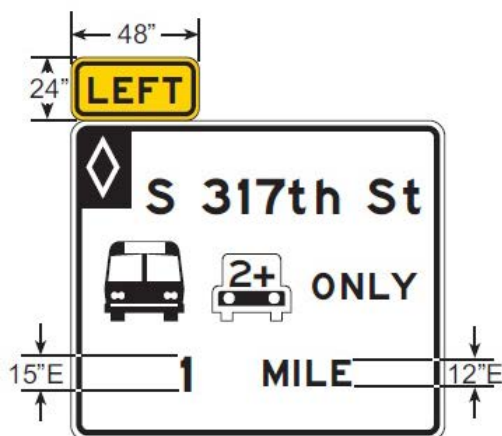

E1-1 MOD.
BLACK ON WHITE

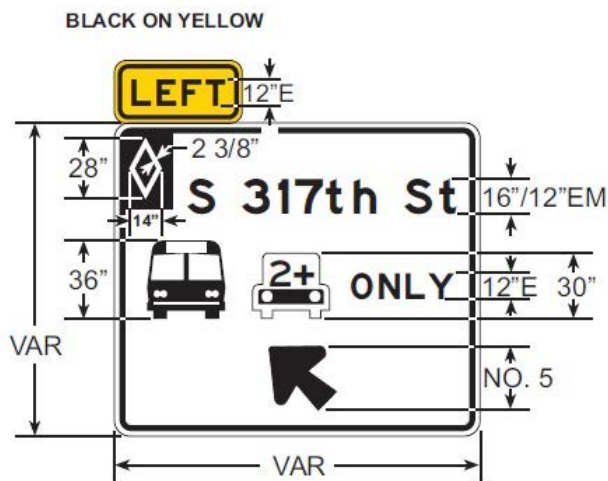

E6-101 MOD.
BLACK ON WHITE

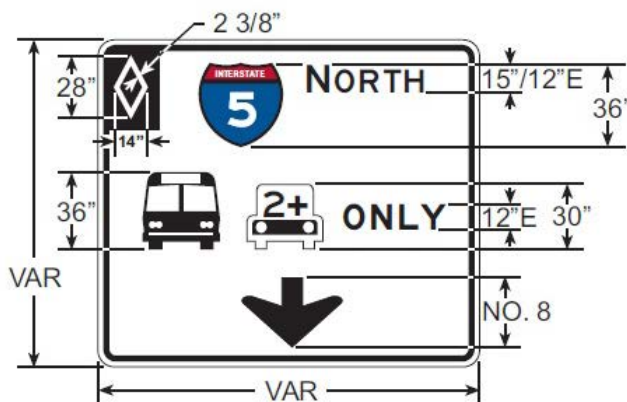

E6-2 MOD.
BLACK ON WHITE

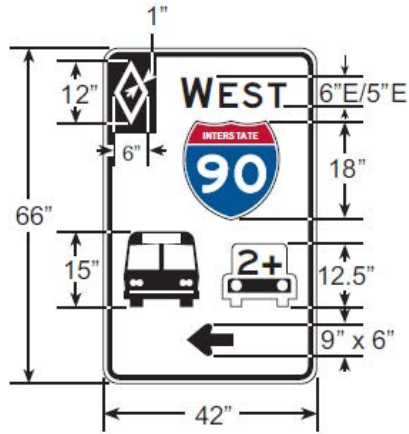

D1-701 MOD.
 BLACK ON WHITE
 SHIELD
 LEGEND - WHITE (REFL)
 TOP - RED (REFL)
 BOTTOM - BLUE (REFL)

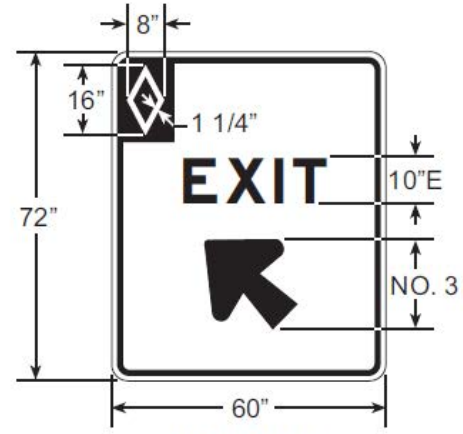

E5-1 MOD.
 BLACK ON WHITE

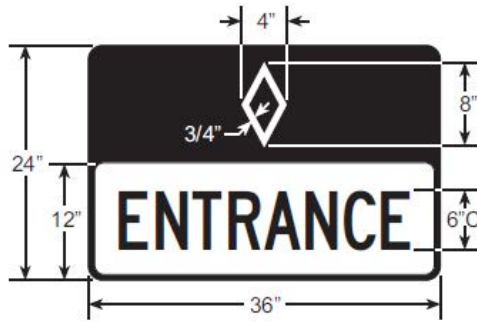

E12-201 MOD.
 BLACK ON WHITE

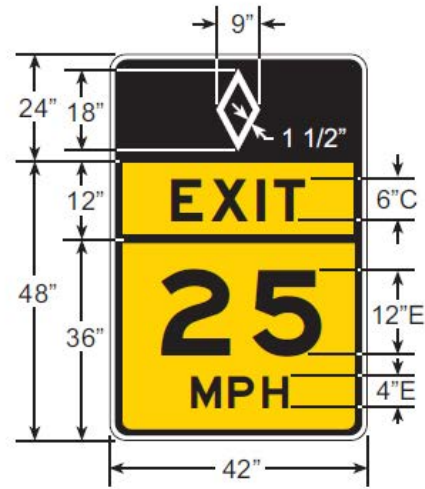

W13-2 MOD.
 WHITE ON BLACK &
 BLACK ON YELLOW



Guide striping provided for left-hand turns.



Do Not Enter sign located on the left side at the top of each off-ramp.



Keep Right sign located at the top of the median barrier separating on- and off-ramps.



HOV Entrance sign located on the right side at the beginning of each on-ramp.



Wrong Way signs (30° rotation at potential wrong-way entrance point).



Diamonds and Turn Only pavement markings on off-ramps.

1420.05(2)(e) Guide Signs

Guide signs for HOV facilities are generally used at intermediate on and off locations to inform HOV motorists of upcoming freeway exits and the appropriate location to exit the HOV lane. For HOV direct access to and from arterials, guide signs are used in a fashion similar to normal arterial interchange signing practice. The guide signs for HOV facilities have a black nonreflective legend on a white reflective background. The exception is the diamond, where the white reflective symbol is on a black nonreflective background. For all HOV-related guide signs, the diamond is placed in the upper left-hand corner of the sign.

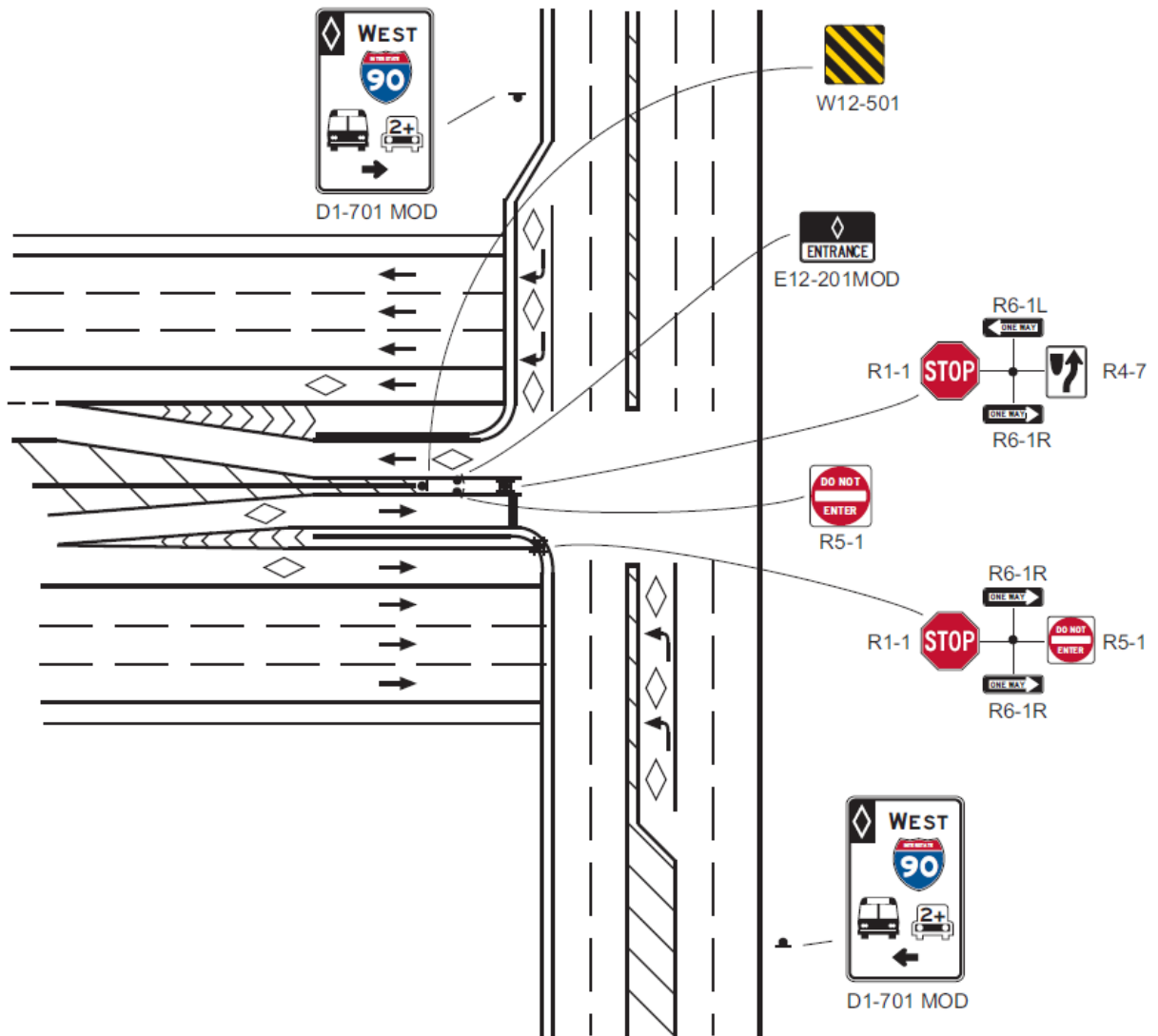

Notes:

- Sign placement shall be in accordance with the [MUTCD](#).
- For non-HOV sign details, see the [Sign Fabrication Manual](#).

1420.05(3) Lighting

Provide illumination of HOV direct access ramps, loading platforms at transit stops, major parking lots, and walkways as defined in Chapter 1040.

1420.05(4) Intelligent Transportation Systems

Intelligent Transportation Systems (ITS) are used to collect traffic data, maintain freeway flow, and disseminate traveler information. Transit information systems for passengers and transit facility surveillance are not normally a part of WSDOT's system, but implementation of these components may be considered for some locations.

Fully utilize available ITS elements in the design of HOV direct access facilities. Need for ITS elements varies depending on project features, such as facility design and operation, and whether the site has existing ITS components.

ITS elements that might be applicable to HOV direct access facilities include: closed circuit television surveillance; ramp metering; data collection; exit queue detection and override; dynamic signing; transit signal priority; and automatic vehicle identification and location.

Guidance on the development of ITS elements is found in [Chapter 1050](#). Include the region Traffic Office, transit operator, and affected local agency in the coordination for the design and implementation of ITS.

1420.06 Documentation

Refer to [Chapter 300](#) for design documentation requirements.

1420.07 References

1420.07(1) Federal/State Laws and Codes

Americans with Disabilities Act of 1990 (ADA) (28 Code of Federal Regulations [CFR] Part 36, Appendix A, as revised July 1, 1994)

[Washington Administrative Code \(WAC\) 468-510-010](#), High occupancy vehicles (HOV)

1420.07(2) Design Guidance

[ADA Field Guide for Accessible Public Rights of Way, WSDOT](#)

[ADA Standards for Accessible Design](#), U.S. Department of Justice (USDOJ), 2010; consists of 28 CFR parts 35 & 36 and the ADA and Architectural Barriers Act (ABA) Accessibility Guidelines for Buildings and Facilities (ADA-ABAAG; also referred to as the 2004 ADAAG), July 23, 2004, U.S.

Access Board. (For buildings and on-site facilities; applies to new construction or alterations as of March 15, 2012.)

www.access-board.gov/guidelines-and-standards

[ADA Standards for Transportation Facilities](#), USDOT, 2006; consists of 49 CFR Parts 37 & 38 and the ADA and ABA Accessibility Guidelines for Buildings and Facilities (ADA-ABAAG; also referred to as the 2004 ADAAG), July 23, 2004, U.S. Access Board as modified by USDOT. (For transit, light rail, and similar public transportation facilities.)

www.access-board.gov/guidelines-and-standards

Manual on Uniform Traffic Control Devices for Streets and Highways, USDOT, FHWA; as adopted and modified by Chapter 468-95 WAC “Manual on uniform traffic control devices for streets and highways” (MUTCD)

Revised Draft Guidelines for Accessible Public Rights-of-Way (PROWAG), November 23, 2005, U.S. Access Board. The current best practices for evaluation and design of pedestrian facilities in the public right of way per the following FHWA memoranda:

🔗 www.fhwa.dot.gov/environment/bikeped/prwaa.htm

🔗 www.fhwa.dot.gov/civilrights/memos/ada_memo_clarificationa.htm

🔗 <http://www.access-board.gov/guidelines-and-standards>

Sign Fabrication Manual, M 55-05, WSDOT

Standard Plans for Road, Bridge, and Municipal Construction (Standard Plans), M 21-01, WSDOT

1420.07(3) Supporting Information

A Policy on Geometric Design of Highways and Streets (Green Book), AASHTO

FHWA/PB, *HOV Interactive 1.0 High Occupancy Vehicle Data Base from the U.S., Canada and Europe* (CD ROM), USDOT, FHWA and Parsons Brinkerhoff

Bus Use of Highways: Planning and Design Guidelines, NCHRP 155

Guide for the Design of High-Occupancy Vehicle (HOV) Facilities, AASHTO

High-Occupancy Vehicle Facilities: A Planning, Design, and Operation Manual, Parsons Brinckerhoff

HOV Systems Manual, NCHRP 414

“Transit Implications of HOV Facility Design,” WA-RD 396.1, September 1996, WSDOT and USDOT, Federal Transit Administration

- 1430.01 [General](#)
- 1430.02 [Bus Stops and Pullouts](#)
- 1430.03 [Passenger Amenities](#)
- 1430.04 [Park and Ride Lots](#)
- 1430.05 [Transfer/Transit Centers](#)
- 1430.06 [Roadway and Intersection Design](#)
- 1430.07 [Documentation](#)
- 1430.08 [References](#)

1430.01 General

This chapter provides general siting and design information for transit facilities. It is intended for Washington State Department of Transportation (WSDOT) engineering and planning staff, local transit providers, developers, and local agencies engaged in the collaborative development of transit facilities on or adjacent to state highways.

The main points covered in this chapter are:

- **Bus Stop Policy:** WSDOT's policy for developing bus stops on state highways is presented. The policy calls for WSDOT and the transit provider to work together to locate stops on state highways. Bus stop placement considerations are also provided.
- **Park and Ride Lots:** Basic guidelines for development of park and ride lots are presented.
- **Transit/Transfer Centers:** Guidance on these centers is provided. Guidance in the [Park and Ride](#) section may apply as well.
- **Universal Access:** The requirements of the Americans with Disabilities Act (ADA) apply to bus stops and shelters, park and ride lots, and transit centers. This information is presented in various sections of the chapter, with additional references provided.
- **Tools and Resources:** Additional guidance and criteria are recommended and referenced, such as: other chapters in the *Design Manual* for designing intersections and road approaches; the *Roadside Manual* for parking lot design; the local transit authority's own standards; and AASHTO.

The design and planning information that follows supports the development of public transit infrastructure and services on state highways.

***Design Manual* topics and chapters commonly used in conjunction with this chapter include:**

- Right of way and access control: Chapters [510](#) through [560](#).
- Intersections and road approaches: Chapters [1300](#) through [1370](#).
- Americans with Disabilities Act (ADA) and sidewalk design: [Chapter 1510](#).
- High-occupancy vehicle (HOV) facilities: Chapters [1410](#) and [1420](#).

1430.02 Bus Stops and Pullouts

WSDOT's Modal Integration Goal seeks to optimize existing system capacity through better interconnectivity of all transportation modes. In support of this goal, WSDOT promotes safe and efficient public transportation services on state highways, including transit routes and stops.

On limited access facilities, bus stops are only allowed at designated locations, such as flyer stops. (See Chapters [520](#), [530](#), and [540](#) for access control policy and guidance.)

Bus stops may be approved on non-limited access facilities at the transit agency's request and upon formal review by WSDOT for sight distance and universal access requirements at the proposed location. At a transit agency's option, a bus stop on these highways may be located either within the travel lane, or outside the travel lane in a pullout. Contact the State Traffic Engineer for information on how to process a transit agency proposal for either an in-lane or pullout bus stop and for more information about the approval process.

Refer to [WAC 468-46](#), Transit Vehicle Stop Zones, for additional details.

The bus stop is the point of contact between the passenger and the transit services. The simplest bus stop is a location by the side of the road. The highest quality bus stop is an area that provides passenger amenities and protection from the weather. Bus stops are typically maintained by the transit agency. The bus boarding and alighting pad, the path to the shelter, and the area within the shelter must meet the requirements for universal access. Coordinate with the local transit agency regarding the location and what type of bus stop to use.

For additional information on bus stop treatments, see [Understanding Flexibility in Transportation Design – Washington](#) and the transit agency's standards for treatment.

1430.02(1) Bus Stop Placement Guidelines

The information in this section is offered as an example of good practice, and is not intended to be binding by either the transit agency or WSDOT.

Placement of bus stops addresses the needs and convenience of transit providers, riders, and highway or street operations. Basic considerations include:

- The need for safe, secure, and convenient service for patrons
- Access for people with disabilities
- Convenient passenger transfers to other intersecting bus routes or transfer points
- Connection to nearby pedestrian circulation systems
- Presence and width of sidewalks, crosswalks, and curb ramps
- Pedestrian activity through intersections
- Ability of the stop to accommodate transit dwell time and the loading/unloading of wheel chairs and bicycles
- Adequate curb space for the number of buses expected at the stop at one time
- Ease of reentering traffic stream (if a pullout)
- Design characteristics and operational considerations of the highway or street
- Presence of on-street automobile parking and truck delivery zones
- Traffic control devices near the bus stop, such as signals or stop signs
- Volumes and turning movements of other traffic, including bicycles

- Proximity and traffic volumes of nearby driveways
- Street grade
- Proximity to rail crossings
- Accommodating transit priority equipment at signalized intersections
- Transit queue bypass at signalized intersections
- Often stops are paired on each side of a highway or street
- Proximity to intersections

Where blocks are exceptionally long or where bus patrons are concentrated well away from intersections, midblock bus stops and midblock crosswalks may be beneficial. Contact the Region Traffic Engineer when a midblock bus stop is being considered on a multilane roadway to determine crossing design details and treatments that may be required. (See [Chapter 1510](#) and the *Traffic Manual* for more information on midblock crossings.)

It is common to clearly mark the bus stop as a NO PARKING zone or as a BUS ONLY zone with signs and/or curb painting.

The remainder of this section discusses three types of bus stops:

- Far-side, with a stop located just past an intersection
- Near-side, with a stop located just prior to an intersection
- Midblock, with a stop located away from an intersection

[Exhibit 1430-1](#) illustrates these three types of stops and provides some general dimensions. Consult the *AASHTO Guide for Geometric Design of Transit Facilities on Highways and Streets* for additional guidelines on bus stop spacing, including information on these types of stops.

Examine each case separately and determine the most suitable location, giving consideration to service and safety of patrons, efficiency of transit operations, and traffic operation in general.

1430.02(1)(a) Far-Side Bus Stops

Sight distance conditions generally favor far-side bus stops, especially at unsignalized intersections. A driver approaching a cross street on the through lanes can see any vehicles approaching from the right. With near-side stops, the view to the right may be blocked by a stopped bus. Where the intersection is signalized, the bus may block the view of one of the signal heads.

Advantages:

- Right turns can be accommodated with less conflict.
- Minimum interference is caused at locations where traffic is heavier on the approach side of the intersection.
- Stopped buses do not obstruct sight distance for vehicles entering or crossing from a side street.
- At a signalized intersection, buses can often find a gap to enter the traffic stream, except where there are heavy turning movements onto the street with the bus route.
- Waiting passengers assemble at less-crowded sections of the sidewalk away from the intersection corners.
- Buses in the bus stop do not obscure traffic control devices or pedestrian movements at the intersection.

Disadvantages:

- Intersections may be blocked if other vehicles park illegally in the bus stop or if more buses than the stop can accommodate arrive at the same time.
- If signal priority is not used, the bus stops at the red light and again at the far-side stop, interfering with traffic and efficient bus operations.

1430.02(1)(b) Near-Side Bus Stops**Advantages:**

- May be considered in cases where a far-side bus stop location does not provide a secure, convenient, or feasible boarding location for passengers.
- Minimum interference is caused where traffic is heavier on the departure side than on the approach side of the intersection.
- Less interference is caused where the cross street is a one-way street from right to left.
- Passengers generally exit the bus close to the crosswalk.
- There is less interference with traffic turning onto the bus route street from a side street.

Disadvantages:

- Can cause conflicts with right-turning traffic.
- Buses often obscure sight distance to stop signs, traffic signals, or other control devices, as well as to pedestrians crossing in front of the bus.
- Where the bus stop is too short to accommodate buses arriving at the same time, the overflow may obstruct the traffic lane.
- If a queue bypass or bus lane is not used at a signalized intersection, then vehicles waiting at a red signal may block buses from accessing the bus stop, which will require the bus to wait through multiple signal cycles to enter and then depart the bus stop.

1430.02(1)(c) Midblock Bus Stops

Midblock stop areas are desirable under the following conditions: where traffic or physical street characteristics prohibit a near- or far-side stop adjacent to an intersection, or where large factories, commercial establishments, or other large bus passenger generators exist. Locate a midblock stop at the far side of a pedestrian crosswalk (if one exists), so that standing buses do not block an approaching motorist's view of pedestrians in the crosswalk.

Advantages:

- Buses cause a minimum of interference with the sight distance of both vehicles and pedestrians.
- Stops can be located adjacent to major bus passenger generators and attractors.
- Allows riders to board buses closest to the crosswalk.

Disadvantages:

- Increases walking distance for passengers crossing at intersections.
- Buses may or may not have difficulty reentering the flow of traffic.
- Driveway access may or may not be negatively impacted.

Exhibit 1430-1 Bus Zone Dimensions

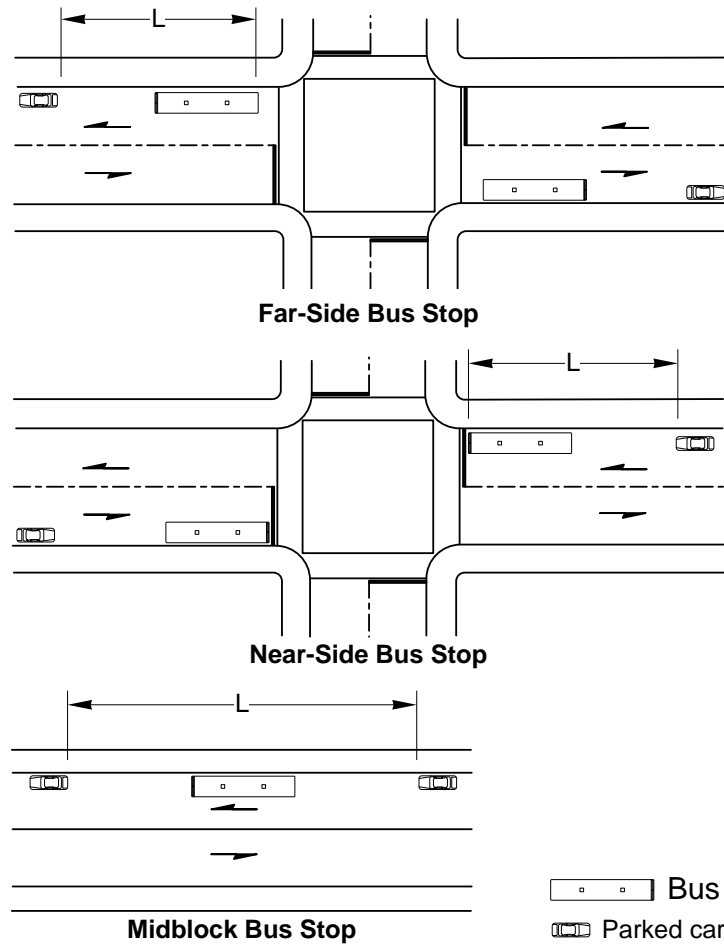

Minimum Lengths for Bus Curb Loading Zones (L) ^[1]						
Approx. Bus Length	Loading Zone Length (feet)					
	One-Bus Stop			Two-Bus Stop		
	Far-Side ^[2]	Near-Side ^{[3][4]}	Midblock	Far-Side ^[2]	Near-Side ^{[3][4]}	Midblock
25	65	90	125	90	120	150
30	70	95	130	100	130	160
35	75	100	135	110	140	170
40	80	105	140	120	150	180
60	100	125	160	160	190	220

Notes:

- [1] Based on bus 1 ft from curb on 40 ft wide streets. When bus is 0.5 ft from curb, add 20 ft near-side, 15 ft far-side, and 20 ft midblock. Add 15 ft when street is 35 ft wide, and 30 ft when street is 32 ft wide.
- [2] Measured from extension of building line or established stop line. Add 15 ft where buses make a right turn.
- [3] Add 30 ft where right-turn volume is high for other vehicles.
- [4] Measured from head of bus zone as determined by the transit agency (may depend on ADA considerations). Add 15 ft where buses make a right turn.

1430.02(2) Bus Pullouts

When designing a pullout, incorporate a deceleration lane or taper into the pullout, a staging area for all anticipated buses, and a merging lane or taper exiting the pullout. As roadway operating speeds increase, increase the taper length accordingly.



Bus Pullout with Longitudinal Island

Exhibit 1430-2 illustrates general dimensions and design features of a bus pullout located along a road. It could also apply to a pullout integrated at the edge of a park and ride lot or transit center.

Exhibit 1430-3 illustrates the dimensions and design features of bus pullouts associated with near-side, far-side, and midblock bus pullouts.

Exhibit 1430-4 illustrates the dimension and design of far-side bus zones and pullouts where buses stop after making a right turn. Adherence to these designs allows buses to stop with minimal interference to legally parked vehicles.

Exhibit 1430-2 Pullout for Bus Stop along a Road

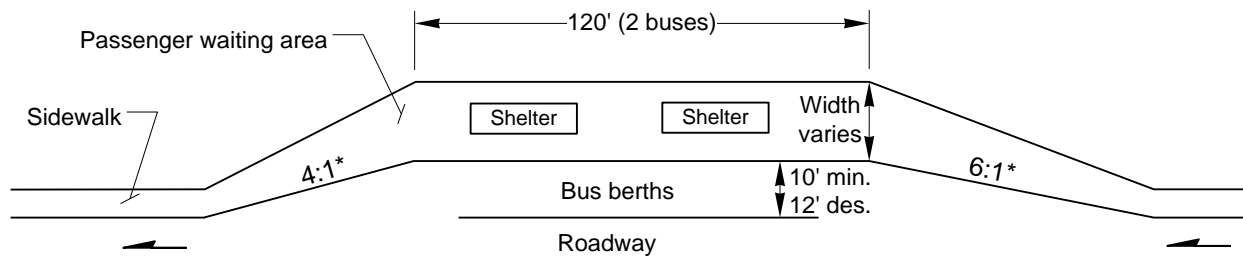

*On higher-speed facilities, it may be necessary to provide a greater acceleration/deceleration transition. Suggested values shown; coordinate designs with the transit agency.

Exhibit 1430-3 Bus Stop Pullouts: Arterial Streets

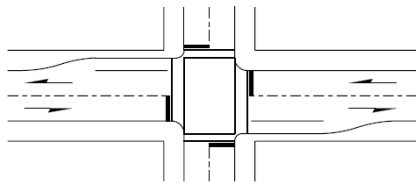

A. Far-Side

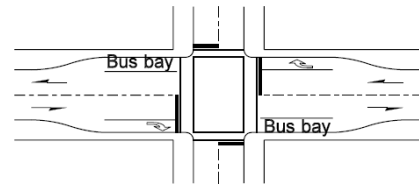

C. Near-Side Right-Turn Lane and Far-Side Bus Bays^[1]

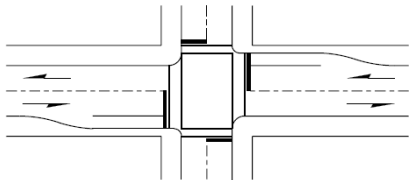

B. Near-Side

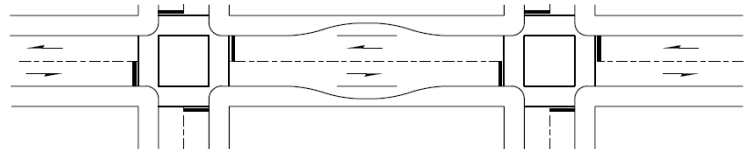

D. Midblock Bus Bays

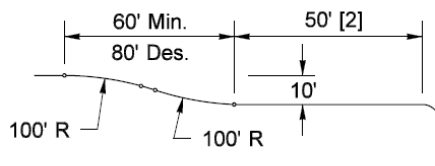

Near-Side Corner Location

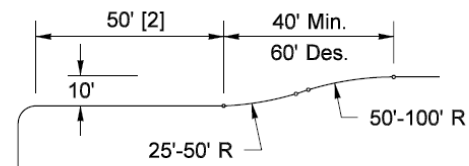

Far-Side Corner Location

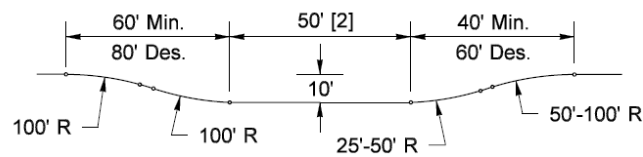

Midblock Location

Notes:

This exhibit provides some general values; coordinate with transit provider for actual dimensions.

[1] For right-turn lane design, see [Chapter 1310](#).

[2] Based on a 40 ft bus. Add 20 ft for articulated bus. Add 45 ft (65 ft articulated) for each additional bus.

Exhibit 1430-4 Bus Zone and Pullout After Right Turn

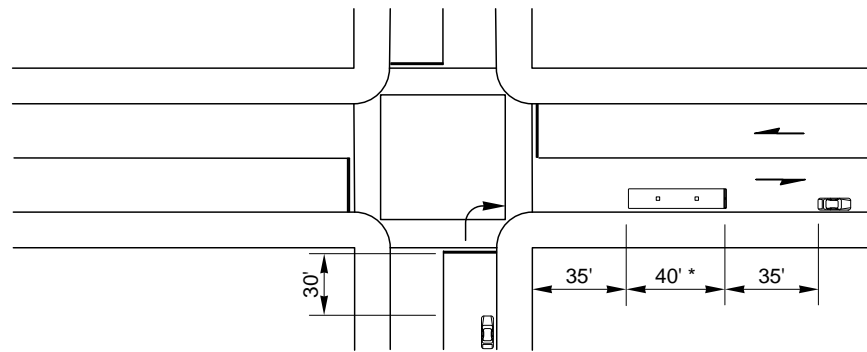

Far-Side Bus Stop

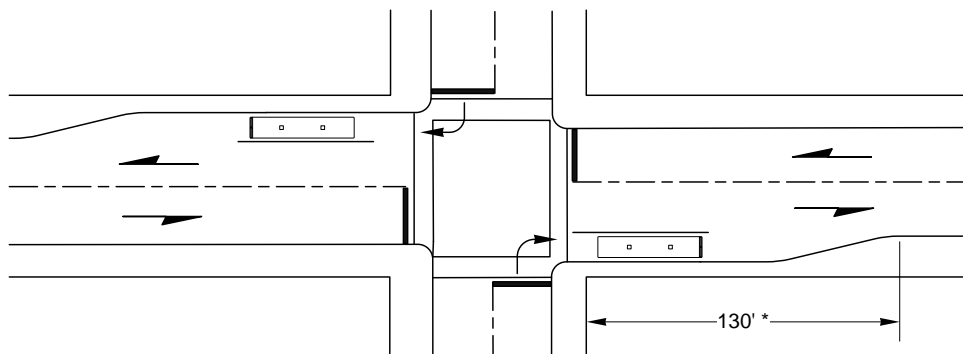

Far-Side Bus Pullout After Right Turn

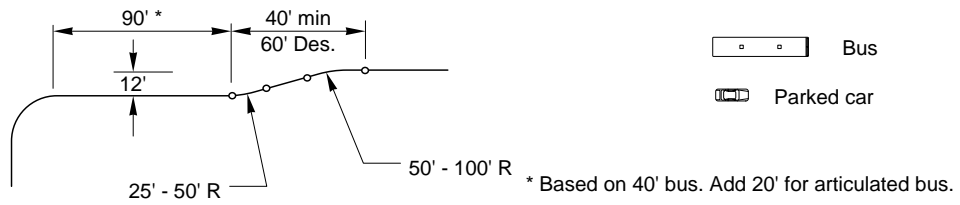

1430.03 Passenger Amenities

1430.03(1) Bus Stop Waiting Areas

Bus passengers desire a comfortable place to wait for the bus. Providing an attractive, pleasant setting for the passenger waiting area is an important factor in attracting bus users.

Important elements of a bus stop include:

- ADA Standards
- Protection from passing traffic
- Lighting
- Security
- Paved surface
- Protection from the environment
- Seating or other street furniture (if the wait may be long)
- Information about routes serving the stop

Providing protection from passing traffic involves locating stops where there is enough space, so passengers can wait away from the edge of the traveled roadway. The buffering distance from the roadway increases with traffic speed and traffic volume. Where vehicle speeds are 30 mph or below, 5 feet is a satisfactory distance. In a heavy-volume arterial with speeds up to 45 mph, a distance of 10 feet provides passenger comfort.

Passengers arriving at bus stops, especially infrequent riders, want information and reassurance. Provide information that includes the numbers or names of routes serving the stop. Other important information may include a system route map, the hours and days of service, schedules, and a phone number for information. Information technology systems are evolving and some transit agencies now provide information about wait time until the next bus and kiosks to purchase the fare before boarding.

Where shelters are not provided, a bus stop sign and passenger bench are desirable, depending on weather conditions. The sign indicates to passengers where to wait and can provide some basic route information. The information provided and format used is typically the responsibility of the local transit agency.

1430.03(2) Passenger Shelters

Passenger shelters provide protection for waiting transit users and create driver awareness of intermodal connections involving vulnerable users. Locate the shelter conveniently for users, without blocking the sidewalk or the drivers' line of sight.

Providing shelters (and footing for shelters) is normally the responsibility of the local transit agency; it provides for shelter design and footing needs. State motor vehicle funds cannot be used for design or construction of shelters, except for the concrete pad.

Lighting can enhance passenger safety and security. Lighting makes the shelter visible to passing traffic and allows waiting passengers to read the information provided. General street lighting is usually sufficient. Where streetlights are not in place, consider streetlights or transit shelter lights. For information on illumination, see [Chapter 1040](#).

A properly drained paved surface is needed so passengers do not traverse puddles and mud in wet weather. Protection from the environment is typically provided by a shelter, which offers shade from the sun, protection from rain and snow, and a wind break.

Shelters can range from simple to elaborate. The latter type may serve as an entrance landmark for a residential development or business complex and be designed to carry through the architectural theme of the complex. If a non-public transportation entity shelter is provided, its design and siting must be approved by the local transit agency. The reasons for this approval include safety, barrier-free design, intermodal connections, and long-term maintenance concerns.

Consider shelters at bus stops in new commercial and office developments and in places where large numbers of elderly and disabled persons wait, such as at hospitals and senior centers. In residential areas, shelters are placed at the highest-volume stops.

In order to use buses that are accessible, bus stops must also be accessible. The nature and condition of streets, sidewalks, passenger loading pads, curb ramps, and other bus stop facilities can constitute major obstacles to mobility and accessibility. State, local, public, and private agencies need to work closely with public transportation officials to provide universal access.

Involve the local transit agency in the bus stop pad design and location so that lifts can actually be deployed at the site.

In order to access a bus stop, it is important that the path to the stop also be accessible. This can be accomplished by the use of sidewalks with curb ramps. For sidewalk design and curb ramp information, see [Chapter 1510](#) and the *Standard Plans*. Exhibit 1430-5 depicts ADA standards for bus stop locations.

Exhibit 1430-5 Bus Stop Accessibility Features

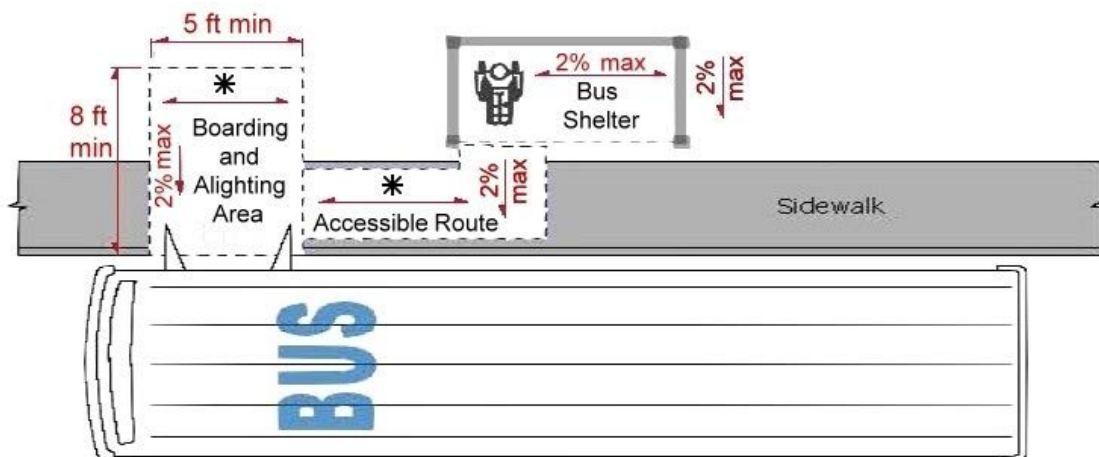

* Slope may be the same as the roadway

Design bus shelter clear space to meet the requirements found in *ADA Standards for Transportation Facilities*.



Passenger shelter showing clear space

For more details, see:

Chapter 3, *ADA Standards for Transportation Facilities*, United States Access Board

www.access-board.gov/guidelines-and-standards/transportation/facilities/ada-standards-for-transportation-facilities/chapter-3-building-blocks

Chapter 8, *ADA Standards for Transportation Facilities*, United States Access Board

www.access-board.gov/guidelines-and-standards/transportation/facilities/ada-standards-for-transportation-facilities/chapter-8-special-rooms,-spaces,-and-elements

1430.04 Park and Ride Lots

Park and ride lots provide parking for people who wish to transfer from private vehicles, bicycles, and other modes to public transit or carpools/vanpools. Most park and ride lots located within urban areas are served by transit agencies. Leased lots, such as at churches or shopping centers, or park and rides in rural locations, may have no bus service and only serve carpools and vanpools.

HOV facilities are often considered and included in larger park and ride lots, to improve access for transit and carpools (see [Chapter 1410](#)).

Park and ride needs and locations are determined through planning processes typically conducted by transit agencies, WSDOT, and/or RTPs/MPOs. Once the need is identified, then the project lead should be identified. Early and continual coordination between the project lead and other stakeholders, authorities, and agencies is critical.



Park and ride lot

A **Cooperative Agreement** is written by Headquarters (HQ) Real Estate Services for the purpose of assigning maintenance and/or operational responsibilities for a WSDOT park and ride lot to a transit agency or local governmental agency. (See the [Agreements Manual](#) and the HQ Real Estate Services Cooperative Agreement form.)

When a memorandum of understanding (MOU) or other formal agreement exists that outlines the design, funding, maintenance, and operation of park and ride lots, it must be reviewed for requirements pertaining to new lots. If the requirements in the MOU or other formal agreement cannot be met, the MOU must be renegotiated.

1430.04(1) Site Selection

In determining the location of a park and ride lot, public input is a valuable tool. Estimated parking demand and other factors determine the size of the lot. Traveler convenience is an important siting factor. Locations that minimize overall trip travel time are most attractive to commuters. Park and rides near freeway access tend to be heavily used because they minimize overall trip travel time for the most people. Freeway proximity makes it easier for transit authorities to provide frequent route service. Other factors that may affect the initial size of the park and ride lot may include available land, the state of the economy, energy availability and cost, perceived congestion, transit service frequency, and environmental controls.

Consider sizing the facility to allow for a conservative first-stage construction with expansion possibilities. As a rule of thumb, 1 acre can accommodate approximately 90 vehicles in a park and ride lot. This allows approximately 40% of the area for borders, landscaping, passenger amenities, bus facilities for larger lots, and future expansion. (See the *AASHTO Guide for Geometric Design of Transit Facilities on Highways and Streets*, Appendix E, for complementary information.)

The local transit authority can give critical input on the need for and design of the park and ride lot. The comprehensive transit plan may already specify a location, and coordination with the transit agency will ensure the site works well for transit vehicle access. Good coordination with the transit agencies through the entire design process is necessary to ensure a well-planned facility that meets the needs of all modal users.

Develop a list of potential sites to identify properties that can be most readily developed for parking and that have suitable access. Sources for selecting sites can include State Route Corridor Sketches and useful tools such as GIS or existing aerial photos, detailed land use maps, or property maps.

Factors influencing site selection and design of a park and ride facility include:

- Local transit authority master plan
- Regional transportation plan
- Local agency codes
- Ability to use existing underutilized paved parking areas within proximity of the desired location
- Local public input
- Proximity to demand
- Local traffic operations, characteristics, parking availability, and roadway geometry
- Local government zoning

- Social and environmental impacts
- Local land use compatibility with current or future development patterns
- Cost and benefit/cost
- Access by all modes of travel
- Security and lighting impacts
- Maintenance
- Stormwater treatment and outfall
- Available utilities
- Existing right of way or sundry site
- Potential for future expansion

Purchasing or leasing property increases costs. Therefore, the first choice is state- or transit-owned right of way, assuming the other selection criteria are favorable. Also, give prime consideration to the use of city- or county-owned right of way. Select a site that complements the current and future land use and highway needs.

Investigate each potential site in the field. The field survey serves to confirm or revise impressions gained from the office review. When conducting the investigation, consider the following:

- Physical characteristics of the site
- Current use and zoning of the area
- Land use surrounding the property (such as residential or commercial use)
- Street network and condition of the roadways
- Visibility from adjacent streets to enhance security
- Potential for additional expansion
- Ability to meet ADA requirements and accessibility for motorists and other modes of travel, including transit
- Proximity of any existing parking facilities (such as church or shopping center parking lots) that are underutilized during the day
- Potential for joint use of facilities with businesses (such as day care centers or dry cleaners) or land uses compatible with park and ride patrons
- Congestion and other design considerations
- Avoiding locations that encourage noncommuter use (such as proximity to a high school)

The desirable location for park and ride lot along one-way couplets is between the two one-way streets, with access from both streets. When this is not achievable, provide additional signing to guide users to and from the facility.

Establish potential sites, with transit agency input, and complete public meetings and environmental procedures prior to finalizing the design. Follow the procedures outlined in [Chapter 210](#).

1430.04(2) Design Guidance

The remainder of this section covers basic design principles and guidance for park and ride lots. Design features are to be in compliance with local requirements. In some cases, variances to local design requirements may be needed to provide for the safety and security of facility users.

Common design components with park and ride lots include:

- Geometric design of access points
- Selection of a design bus type
- Efficient traffic flows, both internal and external circulation, for transit, carpools, vanpools, pedestrians, and bicycles
- ADA-compliant features
- Parking space layout (including accessible stalls)
- Pavements
- Shelters
- Seating or other street furniture
- Exclusive HOV facilities
- Bicycle facilities
- Motorcycle facilities
- Traffic control devices (including signs, signals, and permanent markings)
- Illumination (within the lot and along the streets)
- Stormwater treatment, drainage, and erosion control
- Security for facility users and vehicles (emergency call boxes or telephones)
- Landscape preservation and development
- Environmental mitigation
- Restroom facilities (for transit drivers only or open to the public)
- Trash receptacles
- Artwork (where required by other agencies)

The degree to which the desirable attributes of any component are sacrificed to obtain the benefits of another component can only be determined on a site-specific basis. However, these guidelines present the optimum design elements of each factor.

Large park and ride lots are intended to be transfer points from private automobiles and other modes to transit buses. The same basic principles are used in designing all park and ride lots.

Park and Ride lots that serve a large number of buses and/or routes may also serve as Transfer/Transit Centers; in these cases section 1430.05 would also apply.

1430.04(2)(a) Access

Provide for all modes of transport used to arrive at and depart from transit facilities. The six basic modes are pedestrian, bicycle, motorcycle, automobile, vanpool, and bus.

Coordinate with the local jurisdiction and transit authorities to develop the park and ride lot's ingress and egress locations for transit and for other vehicles. Design the access route, circulation patterns, and return routes to minimize travel time. Exclusive direct connections for buses, vanpools, and carpools may reduce transit costs and save time for riders.

Design transit facility access points on intersecting collector or local streets where possible. Locate the access to avoid the queues from nearby intersections. Provide vehicle storage lanes for entering and exiting vehicles to ensure ease of access and encourage use of the facility. To avoid increasing congestion on the highway or the community that the facility serves, locate entrances and exits where a traffic signal, or other intersection control type (see [Chapter 1300](#)), can be reasonably installed at a later time, if needed.

Entrances and exits to park and rides range in scale from full public intersections to driveways, depending on contextual factors such as traffic volumes and remoteness. Design access points using criteria in the 1300 chapter series (Division 13) or other published design guidelines used by the local agency.

When locating access points on a state highway, see chapters in the 500 series (Division 5) for information about access control types (managed or limited access) and standard access spacing and other requirements.

When designing the entrance/exit locations used by buses, start the design using a 15-foot lane width, and then adjust as needed using the bus design vehicle and turn simulation software (such as AutoTURN®) to verify the design.

1430.04(2)(b) Internal Circulation

Provide walkways to minimize pedestrian use of a circulation road or an aisle to minimize pedestrian conflict points with other modes.

Make the pedestrian circulation path from any parking stall to the loading zone as direct as possible. Where pedestrian movement originates from an outlying part of a large parking lot, consider a walkway that extends toward the loading zone in a straight line.

For additional criteria for pedestrian movement, see *Design Manual Chapter 1510* and Chapter 630 of the *Roadside Manual*.

Locate major vehicular circulation routes within a park and ride lot at the periphery of the parking area to minimize vehicle-pedestrian conflicts. Take care that an internal intersection is not placed too close to a street intersection. Consider a separate loading area with priority parking for vanpools. Wherever possible, do not mix buses and auto circulation.



Pedestrian Access Route

Close coordination with the local transit authority is critical in the design of internal circulation for buses and vanpools. Design bus circulation routes to provide for easy movement, with efficient terminal operations and convenient passenger transfers. Design bus routes within the internal layout, including entrance and exit driveways, to the turning radius of the design bus vehicle.

Additional considerations for internal circulation are:

- Base the general design for the individual user modes on the priority sequence of: pedestrians, bicycles, feeder buses, and park and ride area.
- Design the different traffic flows (auto, pedestrian, bicycle, and bus) circulating within the lot to be understandable to all users, and to minimize conflicting movements between modes.
- Disperse vehicular movements within the parking area by the strategic location of entrances, exits, and aisles.
- Do not confront drivers with more than one decision at a time.
- Provide clear signing for all modes.
- Make the pedestrian circulation routes ADA-compliant (see [Chapter 1510](#)).
- Parking stall and access aisle surfaces shall be even and smooth, with surface slopes not exceeding 2%.
- Consider future expansion.
- Align parking aisles to facilitate convenient pedestrian movement toward the bus loading zone.
- Locate the passenger loading zone either in a central location, to minimize the pedestrian walking distance from the parking area to the loading zone, or near the end of the facility, to minimize the transit travel time.
- In large lots, you may need to provide more than one waiting area for multiple buses.

1430.04(2)(c) Parking Area Design

Refer to the [Roadside Manual](#) for detailed guidance on parking area design. Some general guidelines follow.

Normally, internal circulation is two way with 90° parking. However, one-way aisles with angled parking may be advantageous in a smaller lot due to the limited available space or to promote a specific circulation pattern.

Provide parking for bicycles, motorcycles, and private automobiles, as well as carpools, vanpools, and buses. Locate accessible parking stalls close to the transit loading and unloading area. Two accessible parking stalls may share a common access aisle. For information on the number and design of accessible stalls, see the [Roadside Manual](#) and the parking space layouts in the [Standard Plans](#). Sign accessible parking stalls in accordance with the requirements of [RCW 46.61.581](#). Parking stalls and access aisle surfaces shall be even and smooth, with surface slopes not exceeding 2%.

Locate the bicycle-parking area relatively close to the transit passenger loading area, separated from motor vehicles by curbing or other physical barriers, without landscaping that hides the bike area from view, and with a direct route from the street.

- Design the bike-parking area to discourage pedestrians from inadvertently walking into the area and tripping. Provide lots that are served by public transit, with lockers or with a rack that will support the bicycle frame and allow at least one wheel to be locked.
- Consider providing shelters for bicycle racks. For bicycles, the layout normally consists of stalls 2.5 feet x 6 feet, at 90° to aisles, with a minimum aisle width of 4 feet. Coordinate decisions to provide bicycle lockers, racks, and shelters with the local transit authority and the region subject matter experts.

For more information, see [Understanding Flexibility in Transportation Design – Washington](#). It is complementary to the content in this chapter, and provides more insights to modal designs, environment and aesthetics, community engagement, jurisdictional coordination.

1430.04(2)(d) Drainage

Provide sufficient slope for surface drainage, as ponding of water in a lot is undesirable for both vehicles and pedestrians. This is particularly true in cold climates where freezing may create icy spots. The maximum grade is 2%. Install curb, gutter, and surface drains and grates where needed. Coordinate designs for drainage and pedestrian access routes to avoid conflicts. Coordinate drainage design with the local agency to make sure appropriate codes are followed. For additional drainage information, see *Design Manual Chapter 800* and the *Roadside Manual*.

1430.04(2)(e) Pavement Design

Design pavement to conform to design specifications for each of the different uses and loadings that a particular portion of a lot or roadway is expected to handle. Bus lanes are typically Portland cement concrete pavement. Within the parking area, HMA-type pavements are typically used. Coordinate the pavement designs with the local transit agency and local jurisdiction. Consult with the Region Materials Engineer on pavement section requirements. There may be benefits to permeable pavement if space for stormwater facilities is limited.

1430.04(2)(f) Driver Guidance

Provide a well thought out design for traffic movements within the lot using the proper pavement markings and signage for safe and efficient use by all users of the lot. Typically, reflectorized markings for centerlines, lane lines, channelizing lines, and lane arrows are needed to guide or separate patron and transit traffic. Install park and ride identification signs. For signing and pavement markings, see Chapters [1020](#) and [1030](#) and the [MUTCD](#).

1430.04(2)(g) Shelters

Coordinate with the transit agency on the need, location, design, and installation of pedestrian shelters. To satisfy local needs, shelters may be individually designed, provided by the transit agency, or selected from a variety of commercially available designs. These designs must meet ADA accessibility requirements. Consider the following features in shelter design:

- Select open locations with good visibility for user safety.
- Situate enclosed shelters away from edges of driveways and roadways to keep users dry.
- Select materials and locations where the bus driver can see waiting passengers.
- Avoid using doors, for ease of maintenance and to limit vandalism opportunities.
- Allow for a small air space along the bottom of the enclosure panels, to permit air circulation and reduce debris collection.
- Optional features you may provide are: lighting; heat; telephone; static or electronic travel information (schedules); electronic fare collection equipment; commercial advertisements for revenue generation; and trash receptacles.

For additional information on passenger amenities, see [1430.03](#).

1430.04(2)(h) Illumination, Safety, and Security

Lighting is important from a safety standpoint and as a deterrent to criminal activity in both the parking area and the shelters. For guidance, see *Design Manual Chapter 1040*, Chapter 630 of the *Roadside Manual*, local agency criteria, and AASHTO.

The *Guide for Geometric Design of Transit Facilities on Highways and Streets*, AASHTO, 2014, states: “Security at stations and major stops—both manned and unmanned—should be achieved by closed circuit television monitoring, provision of call boxes, good visibility and lighting, police surveillance, and effective designs. Both the actual security and the passengers’ perceptions of security are important for a viable service or operation.” (See the Guide for more information.)

1430.04(2)(i) Planting Areas

Selectively preserve existing vegetation and provide new plantings to afford a balanced environment for the park and ride lot user. For guidance and policy, see the *Roadside Manual* and the *Roadside Policy Manual*, respectively.

1430.04(2)(j) Fencing

For fencing guidelines, see [Chapter 560](#) and discuss with the partnering transit agency.

1430.04(2)(k) Maintenance

Maintenance of park and ride lots outside state right of way is the responsibility of the local transit authority. Negotiate maintenance agreements with local transit authorities or other appropriate parties during the design phase, to identify the requirements and responsibilities for the maintenance. A Cooperative Agreement is written by HQ Real Estate Services for the purpose of assigning maintenance and/or operational responsibilities for a WSDOT park and ride lot to a transit agency or local governmental agency. (See the *Agreements Manual* and the HQ Real Estate Services Cooperative Agreement form.)

Document the agreements in the Design Documentation Package (see [Chapter 300](#)).

Consider the following in the maintenance plan:

- Cost estimate
- Periodic inspection
- Pavement repair
- Traffic control devices (signs and pavement markings)
- Lighting
- Mowing
- Cleaning of drainage structures
- Sweeping/trash pickup
- Landscaping
- Shelters
- Snow and ice control

Understanding Flexibility in Transportation Design – Washington, 2005 provides more information on many of the above topics.

1430.05 Transfer/Transit Centers

Transfer/transit centers are large multimodal bus stops where buses on a number of routes converge to allow riders the opportunity to change buses or transfer to other modes.

Transit centers are frequently major activity centers and serve as destination points.

Many factors dictate the particular needs of each transit center. Design of a transit center considers such features as passenger volume; number of buses on the site at one time; local auto and pedestrian traffic levels; and universal access.

Transit agencies generally lead in the development of transfer/transit centers, and their standards apply. Consult the *AASHTO Guide for Geometric Design of Transit Facilities on Highways and Streets* for more comprehensive overviews and design guidelines for these facilities.

1430.05(1) Bus Platforms

At a transit center where several transit routes converge and where buses congregate (lay over), multiple bus berths or spaces are typically needed, along with areas where passengers boarding or alighting the bus can take refuge. Typically, there are several design styles for multi-berth bus platforms (see AASHTO). Parallel and sawtooth types are described below.

An important aspect in multiple bus berthing is proper signing and marking for the bus bays for both operators and passengers. Clearly delineate the route served by each bay. Consider pavement marking to indicate stopping positions. Separate layover bays may be needed for terminating bus routes, or the layover function can be provided at the passenger platform if the platform only serves a single route. Consider future service plans and maximize flexibility in the design of transit center bays and circulation.

Portland cement concrete pavement is desirable for pedestrian walkways on the platform, for ease of cleaning.

Where buses are equipped with a bicycle rack, provide for the loading and unloading of bicycles.

[Exhibit 1430-6](#) shows typical parallel and sawtooth designs for parking 40-foot buses for passengers boarding and alighting at a platform. The sawtooth design does not require buses to arrive or depart in any order.

[Exhibit 1430-7](#) is an example of a platform design that has a combination of parallel and sawtooth bus berths at a platform. The sawtooth design provides more space-efficient berthing, as the parallel design shown may require that buses arrive and/or depart in order. Coordinate the bus berth style and platform design with the local transit authority throughout the design process, and obtain its concurrence for the final design.

In the design of parallel bus berths, additional roadway width is needed for swing-out maneuvers if shorter bus loading platforms are utilized. The roadway width and the amount of lineal space required at the bus platform are directly related where designs allow departing buses to pull out from the platform around a standing bus. The shorter the berth length allowed, the wider the roadway. Use turn simulation software (such as AutoTURN®) to verify the design.

Considerable length is needed in a parallel design to permit a bus to pass and pull into a platform in front of a parked bus. Design the bus aisle so that a bus can by-pass another bus stopped at the platform. The decision to provide a parallel design to accommodate a by-pass maneuver may depend on how many routes service the location, and the frequency of service.

1430.05(2) Flow/Movement Alternatives

Two primary alternatives for vehicle and passenger movement are possible for transfer centers, regardless of the type of bus berths used, as shown in [Exhibit 1430-6](#). Buses may line up along one side of the transfer center. This type of arrangement is generally suitable for a limited number of buses due to the walking distances for transferring passengers. For a larger number of buses, an arrangement similar to [Exhibit 1430-7](#) can minimize transfer time by consolidating the buses in a smaller area.

Consult the AASHTO *Guide for Geometric Design of Transit Facilities on Highways and Streets* for more comprehensive overviews and design guidelines.

Exhibit 1430-6 Bus Berth Design

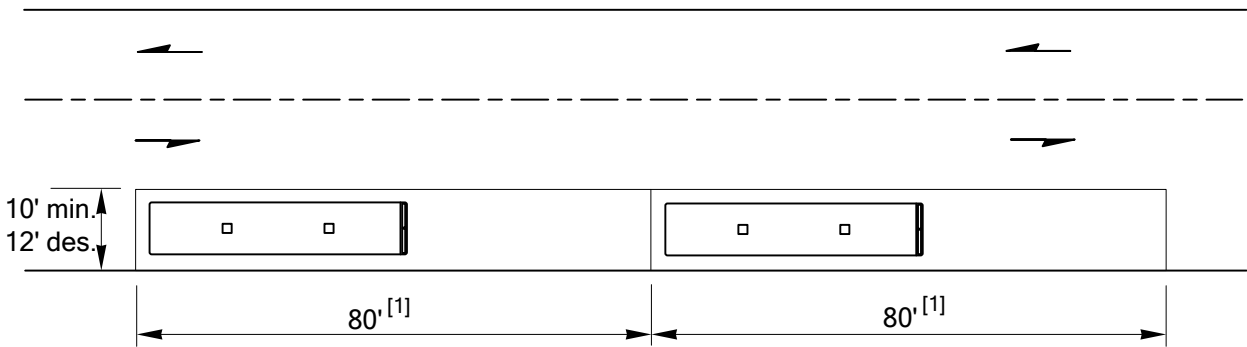

Parallel Design

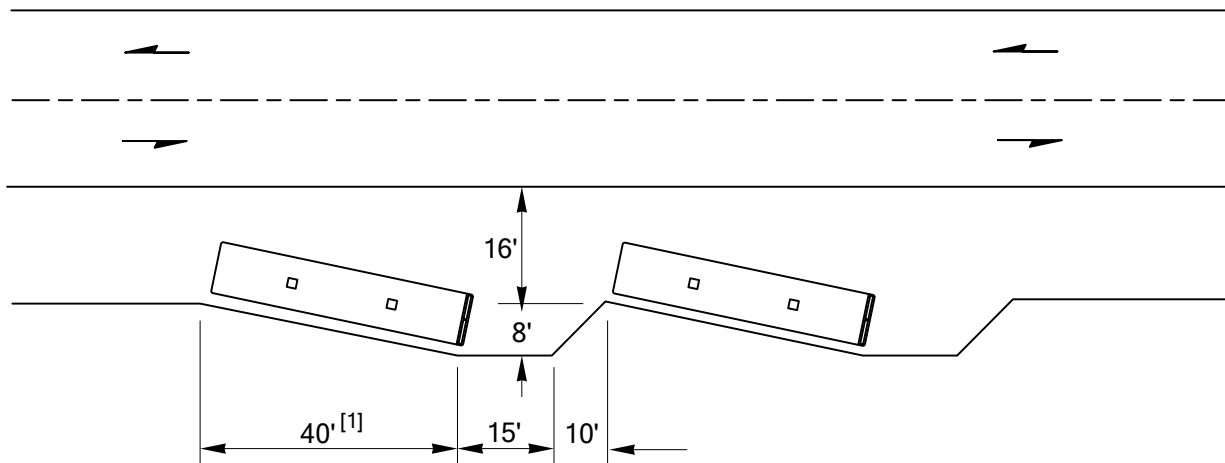

Sawtooth Design^[2]

Notes:

- [1] Dimensions shown are for a 40-ft bus; adjust the length when designing for a longer bus.
- [2] Design shown is an example; contact the local transit agency for additional information.

Exhibit 1430-7 Design Alternative for a Combination of Bus Berths at a Platform

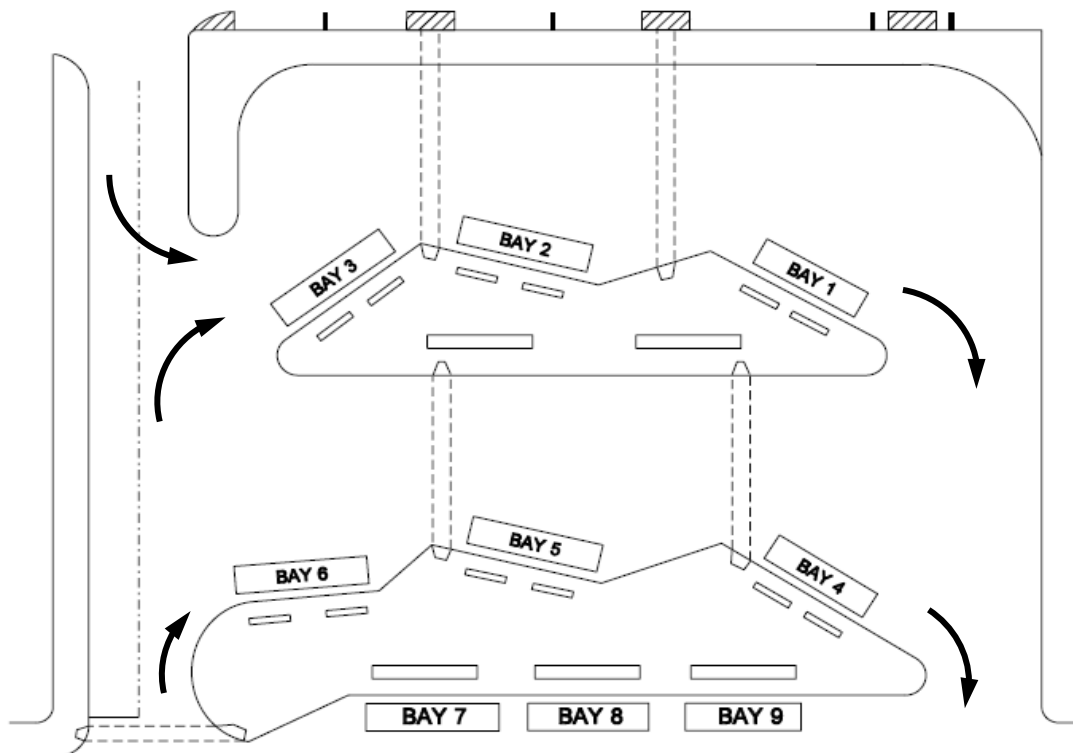

Not to Scale

1430.06 Roadway and Intersection Design

Refer to chapters in the 1100, 1200, and 1300 series (Divisions 11, 12, and 13) for guidance on roadway and intersection design controls and design elements. Some brief discussions are provided below.

1430.06(1) Pavement

Coordinate the pavement design (type and thickness) of a transit project, whether initiated by a public transportation agency or a private entity, with WSDOT or the local agency public works department, depending on highway, street, or road jurisdiction. These agencies play a major role in determining the paving section for the particular project.

Consult with the Region Materials Engineer on pavement section requirements.

1430.06(2) Grades

Roadway grades refer to the maximum desirable slope or grade, or the maximum slope based on the minimum design speed that a 40-foot bus can negotiate efficiently. For roadway grade guidance, see [Chapter 1220](#) or the [Local Agency Guidelines](#).

Bus speed on grades is directly related to the weight/horsepower ratio. Select grades that permit uniform operation at an affordable cost. In cases where the roadway is steep, a climbing lane for buses and trucks may be needed. For climbing lane guidance, see [Chapter 1270](#). Avoid abrupt changes in grade due to bus overhangs and ground clearance.

1430.06(3) Lane Widths

Guidance on roadway and lane widths is given in [Chapter 1230](#) or the *Local Agency Guidelines*, based on the context, modal users, needs of the highway or road, and jurisdiction.

1430.06(4) Design Vehicle Characteristics

Most transit agencies operate several types of buses within their systems. Vehicle sizes range from articulated buses to passenger vans operated for specialized transportation purposes and vanpooling. Several bus types are listed below. (See [Chapter 1103](#), Design Controls, and [Chapter 1300](#) for design vehicle guidance.)

1430.06(4)(a) City Buses (CITY-BUS)

These traditional urban transit vehicles are typically 40 feet long and have a wheelbase of approximately 25 feet. Many of these vehicles are equipped with either front or rear door wheelchair lifts or a front “kneeling” feature that reduces the step height for mobility-impaired patrons. Installing higher curb can reduce the time it takes to kneel a bus and thus increase reliability.

1430.06(4)(b) Articulated Buses (A-BUS)

Because articulated buses are hinged between two sections, these vehicles can turn within a relatively short radius. Articulated buses are typically 60 feet in length, with a wheelbase of 22 feet from the front axle to the mid axle and 19 feet from the mid axle to the rear axle. If articulated buses are the common bus using a stop, adjust the length of the pullout accordingly to avoid conflicts.

1430.06(4)(c) Small Buses

Some transit agencies operate small buses, which are designed for use in low-volume situations or for driving on lower-class roads. Small buses are also used for transportation of elderly and disabled persons and for shuttle services. Passenger vans are a type of small bus used for specialized transportation and vanpooling. Since the vehicle specifications vary so widely within this category, consult the local transit authority for the specifications of the particular vehicle in question.

1430.06(5) Intersection Radii

A fundamental characteristic of transit-accessible development is convenient access and circulation for transit vehicles. It is important that radii at intersections be designed to accommodate turning buses. Radii that accommodate turning buses reduce conflicts between automobiles and buses, reduce bus travel time, and provide maximum comfort for the passengers.

Refer to Chapters 1300 and 1310 for intersection design guidance, and take the following factors into consideration in designing intersection radii:

- Right of way availability
- Angle of intersection
- Width and number of lanes on the intersecting streets
- Feasibility of channelization adjustments such as set-back stop bar or adjusted center line
- Design vehicle turning radius
- On-street parking and/or curb extensions (see Chapter 1510)
- Allowable bus encroachment
- Operating speed and speed reductions
- Adequate intersection sight distance
- Needs of pedestrians, bicyclists, and other design users (see chapters in the 1100 series (Division 11) for contextual discussions and Chapter 1230 for roadway types.)

Because of space limitations and generally lower operating speeds in urban areas, curve radii for turning movements are typically smaller than those used in rural areas.

1430.07 Documentation

Refer to Chapter 300 for design documentation requirements.

1430.08 References

1430.08(1) Federal/State Laws and Codes

Americans with Disabilities Act of 1990 (ADA) (28 Code of Federal Regulations [CFR] Part 36, Appendix A, as revised July 1, 1994)

[Revised Code of Washington \(RCW\) 46.61.581](#), Parking spaces for persons with disabilities – Indication, access – Failure, penalty

[RCW 70.92.120](#), Handicap symbol – Display – Signs showing location of entrance for handicapped

[Washington Administrative Code \(WAC\) Chapter 468-46](#), Transit vehicle stop zones

[WAC 468-510-010](#), High occupancy vehicles (HOVs)

1430.08(2) Design Guidance

ADA Field Guide for Accessible Public Rights of Way, WSDOT

www.wsdot.wa.gov/publications/manuals/fulltext/m0000/ada_field_guide.pdf

ADA Standards for Accessible Design, U.S. Department of Justice (USDOJ), 2010; consists of 28 CFR parts 35 & 36 and the *ADA and Architectural Barriers Act (ABA) Accessibility Guidelines for Buildings and Facilities (ADA-ABAAG)*; also referred to as the 2004 ADAAG, July 23, 2004, U.S.

Access Board. (For buildings and on-site facilities; applies to new construction or alterations as of March 15, 2012.)

🔗 www.access-board.gov/guidelines-and-standards

ADA Standards for Transportation Facilities, USDOT, 2006; consists of 49 CFR Parts 37 & 38 and the *ADA and ABA Accessibility Guidelines for Buildings and Facilities* (ADA-ABAAG; also referred to as the 2004 ADAAG), July 23, 2004, U.S. Access Board as modified by USDOT. (For transit, light rail, and similar public transportation facilities.)

🔗 www.access-board.gov/guidelines-and-standards

Manual on Uniform Traffic Control Devices for Streets and Highways, USDOT, FHWA; as adopted and modified by Chapter 468-95 WAC “Manual on uniform traffic control devices for streets and highways” (MUTCD)

Plans Preparation Manual, M 22-31, WSDOT

Roadside Manual, M 25-30, WSDOT

Standard Plans for Road, Bridge, and Municipal Construction (Standard Plans), M 21-01, WSDOT

Traffic Manual, M 51-02, WSDOT

Revised Draft Guidelines for Accessible Public Rights-of-Way (PROWAG), November 23, 2005, U.S. Access Board. The current best practices for evaluation and design of pedestrian facilities in the public right of way per the following FHWA memoranda:

🔗 <http://www.fhwa.dot.gov/environment/bikeped/prwaa.htm>

🔗 http://www.fhwa.dot.gov/civilrights/memos/ada_memo_clarificationa.htm

🔗 www.access-board.gov/guidelines-and-standards

Transit Capacity and Quality of Service Manual, Third Edition (TCRP Report 165), Transportation Research Board.

<http://www.trb.org/Main/Blurbs/169437.aspx>

1430.08(3) Supporting Information

A Policy on Geometric Design of Highways and Streets (Green Book), AASHTO, current edition

ADA Standards for Accessible Design, U.S. Department of Justice

🔗 www.ada.gov/stdspdf.htm

Bus Use of Highways: Planning and Design Guidelines, National Cooperative Highway Research Program Report 155, Transportation Research Board, 1975

Guide for Geometric Design of Transit Facilities on Highways and Streets, AASHTO, 2014

The AASHTO Guide provides a comprehensive reference of current practice in the geometric design of transit facilities on streets and highways.

Guidelines for the Location and Design of Bus Stops, Transit Cooperative Research Program (TCRP) Report 19, Transportation Research Board, 1996

Understanding Flexibility in Transportation Design – Washington, WSDOT, 2005

🔗 www.wsdot.wa.gov/research/reports/600/638.1.htm

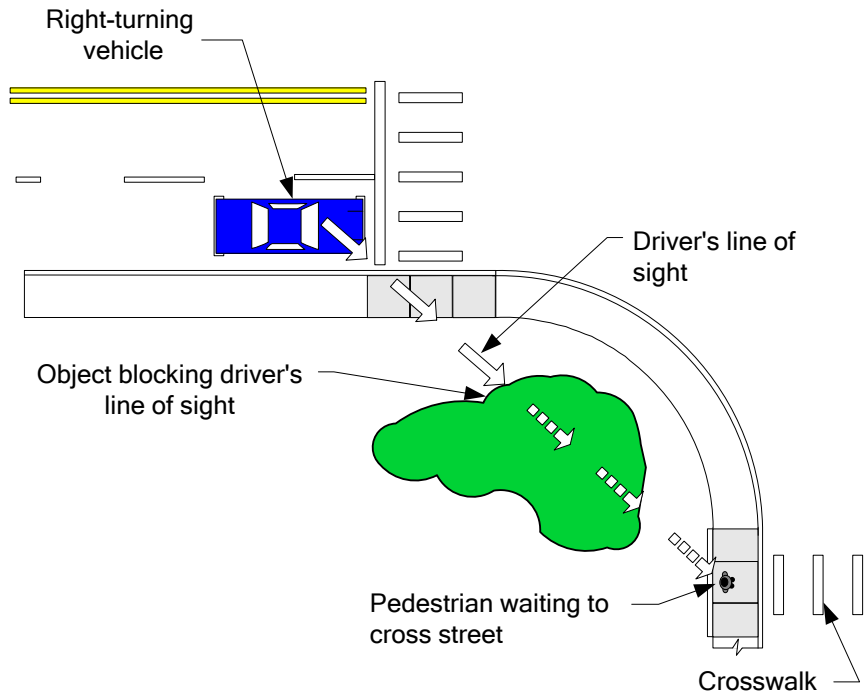
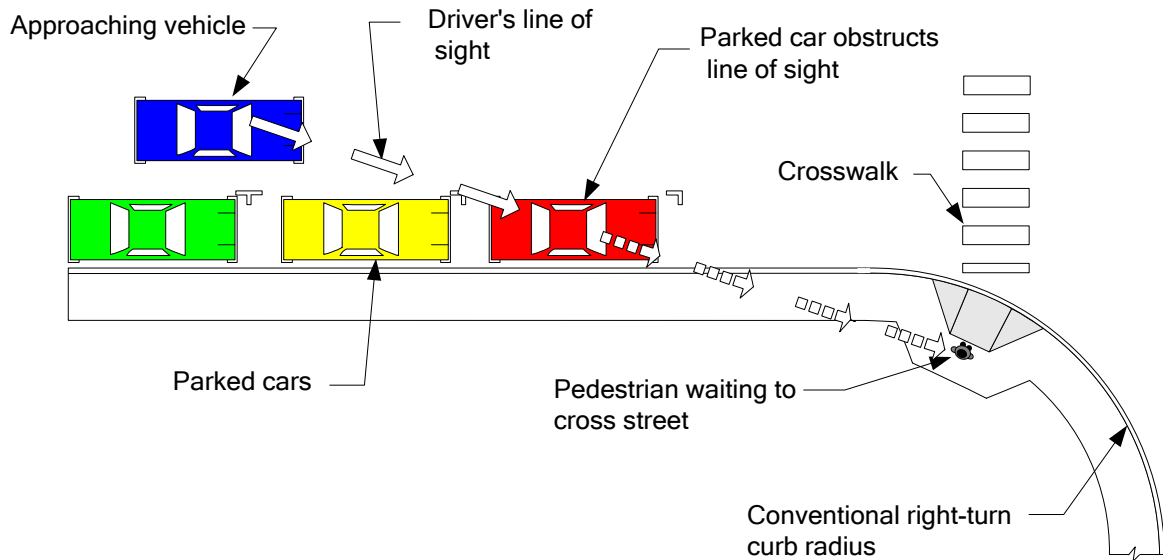

Obstructed Line of Sight at Intersection
Exhibit 1510-19

1510.10(5) Curb Extensions

Curb extensions are traffic calming measures that may improve sight distance and reduce pedestrian crossing times, which limits pedestrian exposure. Installing a curb extension can help reduce the sight distance problem with parked cars that limit driver/pedestrian visibility. Curb extensions may allow for better curb ramp design as well as provide more space for pedestrians. *Note:* Curb extensions are not an option on streets with high-speed traffic or without on-street parking because drivers would be confronted with sudden changes in roadway width.

Extend the curb no farther than the width of the parking lane. (See Chapters 1230, and 1520 for shoulder/bike lane width guidance.) Design the approach nose to ensure adequate setback of vehicles to provide visibility of pedestrians. At intersections with traffic signals, the curb extensions can be used to reduce pedestrian signal timing. Examples of sidewalk curb extensions are shown in Exhibits 1510-20 and 1510-21.

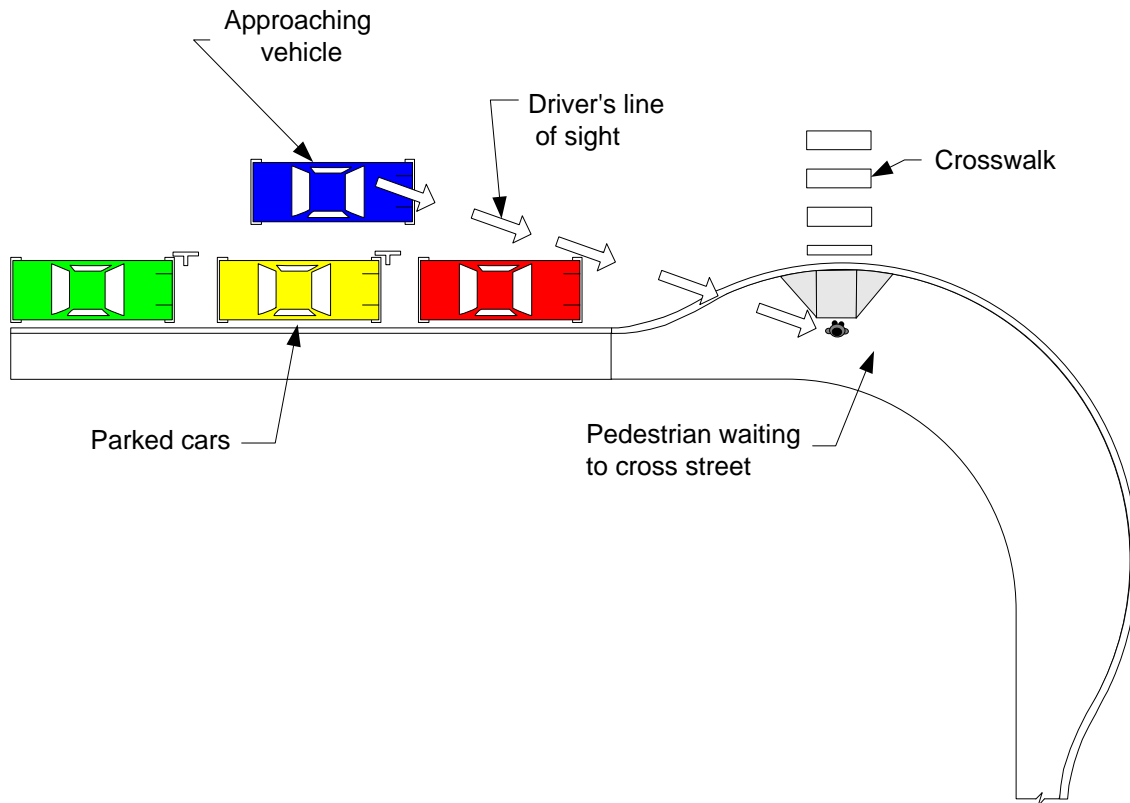

Improved Line of Sight at Intersection
Exhibit 1510-20



Curb Extension Examples
Exhibit 1510-21

The right-turn path of the design vehicle is a critical element in determining the size and shape of the curb extension. Sidewalk curb extensions tend to restrict the width of the roadway and can make right turns difficult for large trucks. Ensure the geometry of the curb extension is compatible with the turn path for the design vehicle selected.

Avoid interrupting bicycle traffic with curb extensions.

Do not use curb extensions on state highways when:

- The design vehicle (see [Chapter 1300](#)) encroaches on curbs or opposing lanes, and other solutions will not improve the circumstances.
- On-street parking is not provided/allowed.
- The posted speed is above 35 mph.

Site features such as landscaping, cabinets, poles, benches, planters, bollards, newspaper stands, and sandwich boards should be selected and placed so they do not obstruct the vision of pedestrians or drivers within curb extension areas, as shown in [Exhibit 1510-21](#). Take into account motorist and pedestrian visibility and Design Clear Zone guidelines (see [Chapter 1600](#)).

1510.11 Raised Medians/Traffic Islands

Wide multilane streets are often difficult for pedestrians to cross, particularly when there are insufficient gaps in vehicular traffic because of heavy volumes. Consider raised medians and traffic islands with a pedestrian refuge area (see [Exhibit 1510-22](#)) on roadways with the following conditions:

- Two-way arterial with intermediate to high speeds (greater than 35 mph), moderate to high average daily traffic (ADT), and high pedestrian volumes.
- Significant pedestrian crash history.
- Near a school or other community center.
- Crossing distance exceeds 30 feet.
- Complex or irregularly shaped intersections.

A traffic island used for channelized right-turn slip lanes can provide a pedestrian refuge, but the slip lane may promote faster turning speeds. Minimize the turning radius of the slip lane to keep speeds as low as feasible. To reduce conflicts, keep the slip lane as narrow as practicable and design a crosswalk alignment that is at a right angle to the face of curb. (See Chapters [1310](#) for turn lanes, [1360](#) for interchange ramps, and [1320](#) for pedestrian accommodations in roundabouts.)

The pedestrian access route through a raised median or traffic island can be either raised with curb ramps or a cut-through type (see [Exhibit 1510-22](#)). Curb ramps in medians and islands can add difficulty to the crossing for some users. The curbed edges of cut-throughs can be useful cues to the visually impaired in determining the direction of a crossing, especially on an angled route through a median or island.

1510.11(1) **Accessibility Criteria for Raised Medians and Traffic Islands**

There are many design considerations when deciding whether to ramp up to the median or island grade or create a cut-through median or island matching the roadway grade. These considerations may include the profile grade and cross slope of the road, drainage patterns, and the length or width of the median or island.

The following accessibility criteria apply:

- Each raised median or traffic island shall contain a pedestrian access route connecting to each crosswalk (see [1510.07](#)).
- A passing space shall be provided that is at least 5 feet wide for a distance of at least 5 feet for each pedestrian access route in a raised median or on a traffic island (see [Exhibit 1510-22](#)).

Note: It is recommended that cut-throughs be designed to have a minimum width of 5 feet to ensure a passing space is provided.

- Medians and pedestrian refuge islands shall be 6 feet minimum in length in the direction of pedestrian travel.
- Detectable warning surfaces are to be separated by 2 feet minimum length in the direction of pedestrian travel.
- Detectable warning surfaces are located at each curb ramp or roadway entrance of a pedestrian access route through a raised median or traffic island. The detectable warning surface shall be located at the back of the curb (see [Exhibit 1510-22](#)).
- Pedestrian access routes of shared-use paths that go through raised medians or traffic islands shall be the same width as the shared-use path (see [Chapter 1515](#)).

1510.13 At-Grade Railroad Crossings

The design of pedestrian facilities that cross railroad tracks (see [Exhibit 1510-26](#)) often presents challenges due to the conflicting needs of pedestrians and trains. In particular, the flangeway gap for trains to traverse a crossing surface may create a significant obstacle for a person who uses a wheelchair, crutches, or walking aids for mobility. Whenever practicable, align pedestrian crossings perpendicular to the tracks in order to minimize potential problems related to flangeway gaps. Crossing surfaces may be constructed of timber planking, rubberized materials, or concrete. Concrete materials generally provide the smoothest and most durable crossing surfaces. When detectable warning surfaces are used at railroad crossings, place them according to the [MUTCD](#) stop line placement criteria.



Undesirable

Recommended

Pedestrian Railroad Crossings

Exhibit 1510-26

There are a number of railroad crossing warning devices (see [Exhibit 1510-27](#)) intended specifically for pedestrian facilities (see the [MUTCD](#)). When selecting warning devices, factors such as train and pedestrian volumes, train speeds, available sight distance, number of tracks, and other site-specific characteristics should be taken into account. Coordinate with the HQ Design Office Railroad Liaison early in the design process so that all relevant factors are considered and an agreement may be reached regarding the design of warning devices and crossing surfaces.



Pedestrian Railroad Warning Device

Exhibit 1510-27

Except for crossings located within the limits of first-class cities,* the Washington Utilities and Transportation Commission (WUTC) approves proposals for any new railroad at-grade crossings or changes to warning devices or geometry at existing crossings. Additionally, any project that requires the railroad to perform work such as installation of warning devices or crossing surfaces must obtain a railroad construction and maintenance agreement. Contact the HQ Design Office Railroad Liaison to coordinate with both the WUTC and the railroad company.

***RCW 35.22.010**: A first class city is a city with a population of ten thousand or more at the time of its organization or reorganization that has a charter adopted under Article XI, section 10, of the state Constitution.

Note: There are very few first-class cities in the state of Washington. Verify with the HQ Design Office Railroad Liaison.

1510.14 Pedestrian Grade Separations (Structures)

On the approach to a bridge that has a raised sidewalk, provide a ramp that transitions to the sidewalk from the paved shoulder. A ramp that transitions from a paved shoulder to a sidewalk on a bridge is to have a slope of 5% maximum and be constructed of asphalt or cement concrete. In addition to aiding pedestrian access, the ramp also serves as a roadside safety feature to mitigate the raised blunt end of the concrete sidewalk. If a pedestrian circulation path (such as a raised sidewalk or shared-use path) is located near the bridge, consider eliminating the gap between the bridge sidewalk and the pedestrian circulation path by extending the bridge sidewalk to match into the nearby pedestrian circulation path.

At underpasses where pedestrians are allowed, it is desirable to provide sidewalks and to maintain the full shoulder width. When bridge columns are placed on either side of the roadway, it is preferred to place the walkway between the roadway and the columns for pedestrian visibility and security. Provide adequate illumination and drainage for pedestrian safety and comfort.

In cases where there is a pedestrian crash history, and the roadway cannot be redesigned to accommodate pedestrians at grade, planners should consider providing a grade-separated pedestrian structure (see Exhibits 1510-28 and 1510-29). When considering a grade-separated pedestrian structure, determine whether the conditions that require the crossing are permanent. If there is likelihood that pedestrians will not use a grade separation, consider less-costly solutions.

Locate the grade-separated crossing where pedestrians are most likely to cross the roadway. A crossing might not be used if the pedestrian is required to deviate significantly from a more direct route.

It is sometimes necessary to install fencing or other physical barriers to channel the pedestrians to the structure and reduce the possibility of undesired at-grade crossings. **Note:** The HQ Bridge and Structures Office is responsible for the design of pedestrian structures.

Consider a grade-separated crossing where:

- There is moderate to high pedestrian demand to cross a freeway or expressway.
- There are large numbers of young children, particularly on school routes, who regularly cross high-speed or high-volume roadways.
- The traffic conflicts that would be encountered by pedestrians are considered unacceptable (such as on wide streets with high pedestrian volumes combined with high-speed traffic).
- There are documented crashes or close calls involving pedestrians and vehicles.

- One or more of the conditions stated above exists in conjunction with a well-defined pedestrian origin and destination (such as a residential neighborhood across a busy street from a school).

1510.14(1) Pedestrian Bridges

Pedestrian grade-separation bridges (see [Exhibit 1510-28](#)) are more effective when the roadway is below the natural ground line, as in a cut section. Elevated grade separations in cut sections, where pedestrians climb stairs or use long approach ramps, tend to be underused. Pedestrian bridges need adequate right of way to accommodate accessible ramp approaches leading up to and off of the structure. The bridge structure must comply with ADA requirements and meet the accessibility criteria for either a pedestrian circulation path (if the grade is 5% or less) or an access ramp (if the grade is greater than 5% but less than or equal to 8.3%), and must include a pedestrian access route. (See [1510.06](#) and [1510.07](#) for pedestrian circulation path and pedestrian access route accessibility criteria; see [1510.15\(2\)](#) for access ramp accessibility criteria.)

For the minimum vertical clearance from the bottom of the pedestrian structure to the roadway beneath, see [Chapter 720](#). The height of the structure can affect the length of the pedestrian ramp approaches to the structure. When access ramps are not feasible, provide both elevators and stairways.

Provide railings on pedestrian bridges. Protective screening is sometimes desirable to deter pedestrians from throwing objects from an overhead pedestrian structure (see [Chapter 720](#)).

The minimum clear width for pedestrian bridges is 8 feet. Consider a clear width of 14 feet where a pedestrian bridge is enclosed or shared with bicyclists, or equestrians, or if maintenance or emergency vehicles will need to access.



Pedestrian Bridges
Exhibit 1510-28

1510.14(2) Pedestrian Tunnels

Tunnels are an effective method of providing crossings for roadways located in embankment sections. Well-designed tunnels can be a desirable crossing for pedestrians. When feasible, design the tunnel with a nearly level profile to provide an unobstructed line of sight from portal to portal (see [Exhibit 1510-29](#)). People may be reluctant to enter a tunnel with a depressed profile because they are unable to see whether the tunnel is occupied. Law enforcement also has difficulty patrolling depressed profile tunnels.

Provide vandal-resistant daytime and nighttime illumination within the pedestrian tunnel. Installing gloss-finished tile walls and ceilings can enhance light levels within the tunnel. The minimum overhead clearance for a pedestrian tunnel is 10 feet. The minimum width for a pedestrian tunnel is 12 feet. Consider a tunnel width between 14 and 18 feet depending on usage and the length of the tunnel.



Pedestrian Tunnel
Exhibit 1510-29

Pedestrian tunnels need adequate right of way to accommodate accessible approaches leading to the tunnel structure. The tunnel structure must comply with ADA requirements and meet the accessibility criteria for either a pedestrian circulation path (if the grade is less than or equal to 5%) or an access ramp (if the grade is greater than 5% and less than or equal to 8.3%), and must include a pedestrian access route. (See [1510.06](#) and [1510.07](#) for pedestrian circulation path and pedestrian access route accessibility criteria; see [1510.15\(2\)](#) for access ramp accessibility criteria.)

1510.15 Other Pedestrian Facilities

1510.15(1) Transit Stops and School Bus Stops

The location of transit stops is an important element in providing appropriate pedestrian facilities. (Coordinate with the local transit provider.) Newly constructed transit stops must conform to ADA requirements. Design newly constructed transit stops so that they are accessible from the sidewalk or paved shoulder. A transit stop on one side of a street usually has a counterpart on the opposite side because transit routes normally function in both directions on the same roadway. Provide adequate crossing facilities for pedestrians.

When locating a transit stop (see [Traffic Manual](#) 7.9), consider transit ridership and land use demand for the stop. Also, take into account compatibility with the following roadway/traffic characteristics:

- ADT
- Traffic speed
- Crossing distance
- Crash history
- Sight distance
- Connectivity to a pedestrian access route
- Traffic generator density

If any of these suggests an undesirable location for a pedestrian crossing, consider a controlled crossing or another location for the transit stop. (See [Chapter 530](#) for further information on bus stops on limited access facilities.)

When analyzing a transit stop location with high pedestrian crash frequency, take into account the presence of nearby transit stops and opportunities for pedestrians to cross the street in a reasonably safe manner. At-grade midblock pedestrian crossings may be effective at transit stop locations on roadways with lower vehicular volumes. Pedestrian grade separations are appropriate at midblock locations when vehicular traffic volumes prohibit pedestrian crossings at grade. (See [the Traffic Manual](#) for recommendations for marked crosswalks at unsignalized intersections.)

School bus stops are typically adjacent to sidewalks in urban areas and along shoulders in rural areas. Determine the number of children using the stop and provide a waiting area that allows the children to wait for the bus. Coordinate with the local school district. Because of their smaller size, children might be difficult for motorists to see at crossings or stops. Determine whether utility poles, vegetation, and other roadside features interfere with motorists' ability to see the children. When necessary, remove or relocate the obstructions or move the bus stop. Parked vehicles can also block visibility, and parking prohibitions might be advisable near the bus stop. Coordinate transit and school bus stop locations with the region Traffic Office.

1510.15(2) Access Ramps Serving Transit Stops, Park & Ride Lots, Rest Areas, Buildings, and Other Facilities

An access ramp (see [Exhibit 1510-30](#)) provides an accessible pedestrian route from a pedestrian circulation path to a facility such as a transit stop, park & ride lot, rest area, pedestrian overcrossing/undercrossing structure, or building. When the running slope is 5% or less, it can be designed as a pedestrian circulation path that includes a pedestrian access route. When the running slope is greater than 5% to a maximum of 8.3%, it must be designed as an access ramp. (See [1510.06](#) and [1510.07](#) for pedestrian circulation path and pedestrian access route accessibility criteria; see [1510.15\(2\)\(a\)](#) for access ramp accessibility criteria.)

1510.15(2)(a) Accessibility Criteria for Access Ramps

Access ramps are composed of one or more ramp segments interconnected by level landings. Unless superseded by the following specific accessibility requirements for access ramps, the accessibility requirements for pedestrian access routes also apply:

- Ramp segments shall have a maximum running slope of 8.3%.
- The cross slope of ramp segments shall be 2% maximum.
- The minimum clear width of ramps is 4 feet; however, it is desirable to match the width of the connecting pedestrian facility.
- The rise for any ramp segment shall be 30 inches maximum.
- A level landing (2% maximum running and cross slopes) shall be provided at the top and bottom of each access ramp segment.
- An access ramp landing's clear width shall be at least as wide as the widest ramp segment leading to the landing.
- An access ramp landing's length shall be 5 feet minimum.
- Access ramps that change direction between ramp segments at landings shall have a level landing 5 feet minimum width by 5 feet minimum length.
- All access ramp segments with a rise greater than 6 inches shall have ADA-compliant handrails (see [1510.15\(3\)](#) for handrail accessibility criteria).

Provide edge protection complying with one of the two following options on each side of access ramp segments:

- The surface of the ramp segment and landing shall extend 12 inches minimum beyond the inside face of the handrail.
- A curb or barrier shall be provided that does not allow the passage of a 4-inch-diameter sphere, where any portion of the sphere is within 4 inches of the ramp/landing surface.



Access Ramp With Accessible Handrails
Exhibit 1510-30

1510.15(3) Railings and Handrails for Pedestrian Facilities

Accessible handrails are required on stairs and also on access ramps that have a rise greater than 6 inches (see [1510.15\(2\)\(a\)](#) for access ramp accessibility criteria). If the height of a drop-off (typically greater than 30 inches) adjacent to a pedestrian facility necessitates the need to protect pedestrians from falls, then a more robust railing system designed for fall protection should be used. If the drop-off is adjacent to either a stairway or an access ramp with a rise greater than 6 inches, then a combined railing system that meets the requirements for both accessibility and fall protection must be used.

1510.15(3)(a) Fall Protection Railing

Railing designed for fall protection alone is typically placed adjacent to pedestrian facilities other than stairs or access ramps to prevent pedestrians or bicyclists from falls. The minimum railing height for pedestrian fall protection is 42 inches. For facilities where bicycle traffic is anticipated, such as on a grade-separation structure on a shared-use facility (see [Chapter 1515](#)), the minimum railing height for bicyclist fall protection is 54 inches.

1510.15(3)(b) Accessible Fall Protection Railing

When fall protection is needed adjacent to stairs or an access ramp that has a rise greater than 6 inches, then a combined railing system that meets both the accessibility criteria for handrail outlined in [1510.15\(3\)\(d\)](#) and the requirements for fall protection must be used. The minimum railing height for pedestrian fall protection is 42 inches. For facilities where bicycle traffic is anticipated, such as on the approach to a grade-separation structure on a shared-use facility (see [Chapter 1515](#)), the minimum railing height for bicyclist fall protection is 54 inches.

1510.15(3)(c) Accessible Handrail

Accessible handrail meeting the accessibility criteria listed in 1510.15(3)(d) that is not designed to provide fall protection is to be used adjacent to stairs or access ramps that have a rise greater than 6 inches at locations where robust fall protection is not needed.

1510.15(3)(d) Accessibility Criteria for Handrail

The following accessibility criteria apply to all handrail installations provided at stairs and access ramps that have a rise greater than 6 inches.

1. Height

- The top of handrail gripping surfaces shall be 34 inches minimum and 38 inches maximum vertically above walking surfaces, stair nosings, and ramp surfaces.
- The mounting height of the handrail shall also be at a consistent height.

2. Gripping Surface

- Clearance between handrail gripping surfaces and adjacent surfaces shall be 1½ inches minimum.
- Handrail gripping surfaces shall be continuous along their length and shall not be obstructed along their tops or sides.
- The bottoms of handrail gripping surfaces shall not be obstructed for more than 20% of their length.
- Where provided, horizontal projections shall be located 1½ inches minimum below the bottom of the handrail gripping surface.
- Handrail gripping surfaces with a circular cross section shall have an outside diameter between 1¼ inches minimum and 2 inches maximum.
- Handrail gripping surfaces with a noncircular cross section shall have a perimeter dimension between 4 inches minimum and 6¼ inches maximum, and a cross section dimension of 2¼ inches maximum.
- Handrail gripping surfaces and the surfaces adjacent to them shall be free of sharp or abrasive elements and shall have rounded edges.
- Handrails shall not rotate in their fittings.

3. Placement and Continuity

- Handrails shall be provided on both sides of access ramps and stairs.
- Handrails shall be continuous within the full length of each access ramp run or stair flight.
- Inside handrails on switchback or dogleg access ramps and stairs shall be continuous between runs or flights.

4. Extensions

- Access ramp handrails shall extend horizontally above the landing for 12 inches minimum beyond the top and bottom of ramp runs.
- At the top of a stair flight, handrails shall extend horizontally above the landing for 12 inches minimum beginning directly above the first riser nosing.

- At the bottom of a stair flight, handrails shall extend at the slope of the stair flight for a horizontal distance at least equal to one tread depth beyond the last riser nosing.
- Handrail extensions shall return to a wall, guard, or the landing surface, or shall be continuous to the handrail of an adjacent access ramp run or stair flight.

Exception: Handrail extensions shall not be required for continuous handrails at the inside turn of switchback or dogleg access ramps or stairs.

1510.15(4) Other Pedestrian Facilities, Features, and Elements

This chapter covers the accessibility criteria for the most commonly encountered pedestrian design elements in the public right of way. However, there are ADA requirements that apply to any feature or element for pedestrian use, such as doorways, elevators, stairs, call boxes, and drinking fountains. For accessibility criteria for less commonly encountered pedestrian design elements, consult the applicable federal guidance document(s) listed in [1510.02\(2\)](#).

1510.16 Illumination and Signing

In Washington State, the highest number of crashes between vehicles and pedestrians tends to occur during November through February, when there is poor visibility and fewer daylight hours. Illumination of pedestrian crossings and other walkways is an important design consideration because lighting has a major impact on a pedestrian's safety and sense of security. Illumination provided solely for vehicular traffic is not always effective in lighting parallel walkways for pedestrians. Consider pedestrian-level (mounted at a lower level) lighting for pedestrian circulation paths, intersections, and other pedestrian crossing areas with high nighttime pedestrian activity, such as shopping districts, transit stops, schools, community centers, and other major pedestrian generators or areas with a history of pedestrian crashes. (See [Chapter 1040](#) for design guidance on illumination, and [Chapter 1020](#) and the [MUTCD](#) for pedestrian-related signing.)

1510.17 Work Zone Pedestrian Accommodation

While Title II of the ADA requires that a public entity maintain its pedestrian facilities in operable working condition, including maintenance of their accessibility features, construction and maintenance activities often temporarily disrupt these facilities. When this occurs, provide access and mobility for pedestrians through and around work zones (see [Exhibit 1510-31](#)). Address this in the temporary traffic control plans if the project occurs in a location accessible to pedestrians. The designer must determine pedestrian needs in the proposed work zone during the public input process and through field visits.

Detailed guidance on work zone pedestrian accommodation can be found in the WSDOT *Field Guide for Accessible Public Rights of Way*, the [MUTCD](#), and [Chapter 1010](#).

Some work zone considerations include:

- Separate pedestrians from conflicts with work zone equipment and operations.
- Separate pedestrians from traffic moving through or around the work zone.
- Provide pedestrians with alternate routes that have accessible and convenient travel paths that duplicate, as closely as feasible, the characteristics of the existing pedestrian facilities.

- 1520.01 [General](#)
- 1520.02 [Roadway Bicycle Facility Types](#)
- 1520.03 [Bicycle Facility Selection](#)
- 1520.04 [Intersection Design Treatments](#)
- 1520.05 [Additional Bicycle Design Requirements and Considerations](#)
- 1520.06 [Documentation](#)
- 1520.07 [References](#)

1520.01 General

The Washington State Department of Transportation (WSDOT) encourages and relies on bicycle use on and interconnecting with its facilities. Bicycle facilities or improvements for bicycle transportation are included in WSDOT's project development and highway programming processes.

This chapter is a guide for designing bicycle facilities within state highway right of way or between the curb lines on city streets designated as state highways. When designing facilities outside of state highway right of way or beyond the curb on city streets designated as state highways, use the local agency's design guidance. If the bicycle facility will have shared use with pedestrians incorporate ADA requirements in [Chapter 1515](#).

Guidance in this chapter applies to typical situations encountered on state highways, and includes options for intersection and interchange design. Unique design challenges are resolved using expertise and guidance from the regional Bicycle Coordinator or if none exists, the WSDOT headquarters Bicycle Coordinator. Additional concepts to resolve unique bicycle facility design situations can be found in guides referenced ([1520.07](#)), but may require additional approvals for signing, pavement markings or bike facility types not presented within this chapter.

The region Traffic Engineer is responsible for determining which sections are inappropriate for bicycle traffic on state highways. The State Traffic Engineer, after consultation with the Bicycle Advisory Committee, prohibits bicycling on sections of state highways through the traffic regulation process. Contact the region Traffic Office for further information.

1520.02 Roadway Bicycle Facility Types

WSDOT has adopted the following six types of bicycle facilities, from most protected to least protected:

- Shared-Use Paths (see [Chapter 1515](#) for guidance)
- Raised and Curb-Separated
- Separated Buffered Bike Lanes
- Buffered Bike Lanes
- Conventional Bike Lanes
- Shared Lane Markings

Shared-use paths (see [Chapter 1515](#)) are the most protected type of bike facility because the path is physically separated from motor vehicle traffic most commonly by a wide vegetated outer separation or other physical barrier. Roadway bicycle facilities can range from separated from motor vehicle traffic to physically sharing a lane with motor vehicle traffic. The following subsections discuss five types of roadway bicycle facilities adopted for use on state highways.

All roadway bicycle facility types will be designated by striping, signage, and pavement markings to indicate the preferential or exclusive use for bicycle users. See [1520.05\(1\)](#) for more information.

1520.02(1) Raised and Curb-Separated

[Exhibit 1520-1](#) shows a raised and curb-separated bicycle facility. These facilities are considered protected because they are vertically separated from motor vehicle traffic. When a raised and curb-separated bicycle facility is applied, it is considered part of the streetside zone (see [Chapter 1230](#)); however, it cannot be combined with other zone areas because the intent is also segregation from pedestrians. The raised and curb-separated facility is dedicated for bike users and delineated with pavement markings, signing, and in some cases pavement material.

There are advantages in utilizing streetside zones in conjunction with a raised and curb-separated bike facility. A furnishing zone can be used to help segregate pedestrian and bicycle users or for additional separation between the bike facility and motor vehicle traffic. If a furnishing zone is not used to separate the raised bike facility from the pedestrian zone, consider different pavement types, signs, pavement borders, or striping within the streetside zone to effectively separate pedestrian and bicycle users.

When the raised and curb-separated bike facility is placed adjacent to motor vehicle traffic, consider using a sloped and mountable curb (see [Chapter 1230](#)) to enable passing maneuvers between cyclists.

Within incorporated limits, raised and curb-separated bike facilities are located behind the curb and therefore fall under a local agency's jurisdiction. (See [Chapters 1230](#), and [1600](#) for additional information on jurisdictional boundaries). In these situations, follow the local agency's design guidance for this type of bike facility.

Exhibit 1520-1 Raised and Curb-Separated Bike Facility

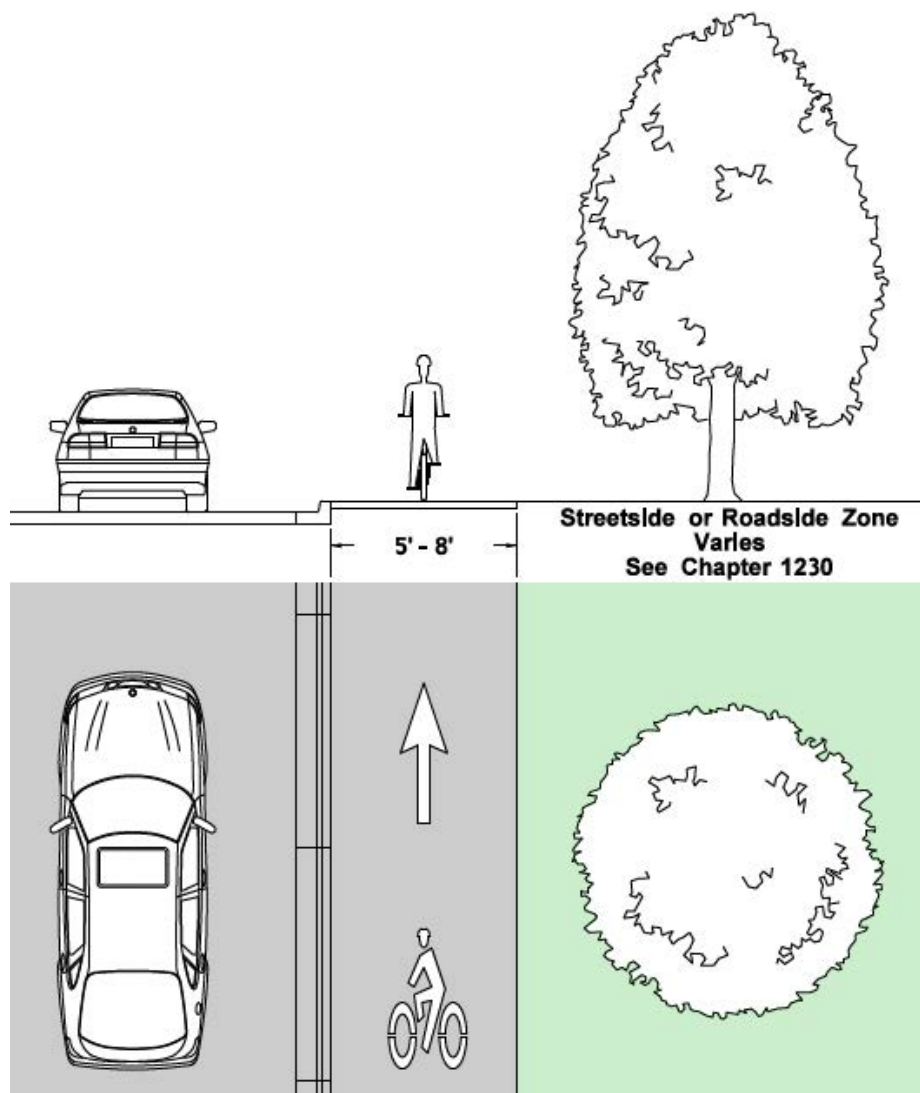
**1520.02(2) Separated Buffered Bike Lanes**

Separated buffered bike lanes are at grade with the roadway, and they include a bike lane, a buffer area, and some type of vertical feature that reduces the likelihood of encroachment into the bike lane by motor vehicles and increases user comfort. Bike markings (see the [Standard Plans](#)) in the bike lane and signage are employed. The most common type of vertical separator used within the buffer area is a pavement mounted flexible tubular marker or delineator. Use of dual-faced curbing, raised medians, or the parking zone adjoining the buffer area can also accomplish the same task.

If parked vehicles within the parking zone are used as the vertical separator, the parking zone cannot encroach onto the buffer area. When a separated buffered bike lane is positioned between motor vehicle lanes and a parking zone, consider including an additional buffer area between the parking zone and bike lane. Use of the buffer area described in these two configurations facilitates loading and unloading of the parked vehicles, and reduces the risk of a

cyclist being struck when a parked vehicle door opens (aka “dooring”). See NACTO’s *Urban Bikeway Design Guide and Urban Street Design Guide* for examples.

Exhibit 1520-2 shows an example of separated buffered bike lane using a flexible tubular marker as the vertical separator. A painted buffer strip with flexible tubular marker helps accentuate the bicycle facility from the motor vehicle lane, when curbing or a raised median (also considered vertical separation) is not used for the buffer strip. Consider a 3-foot-wide buffer strip whenever possible. When utilizing a buffer, the bike lane itself may be 3 feet in width. However, 5 feet is recommended exclusively to the bike lane to enable passing maneuvers between cyclists, and account for the effective width needs of bicyclists when drainage features are present in the bike lane. In space constrained areas where inexperienced bicyclists, such as children, are expected or where there is a steep uphill grade use a 4 foot minimum for the bicycle lane. High bicyclist volume locations should consider more width to facilitate mobility performance for this mode. In constrained spaces where lower volumes of cyclists are anticipated and inexperienced bicyclists are not expected, the minimum total width of both the bike lane and buffer combined is 5 feet.

Exhibit 1520-2 Separated Buffered Bike Lane

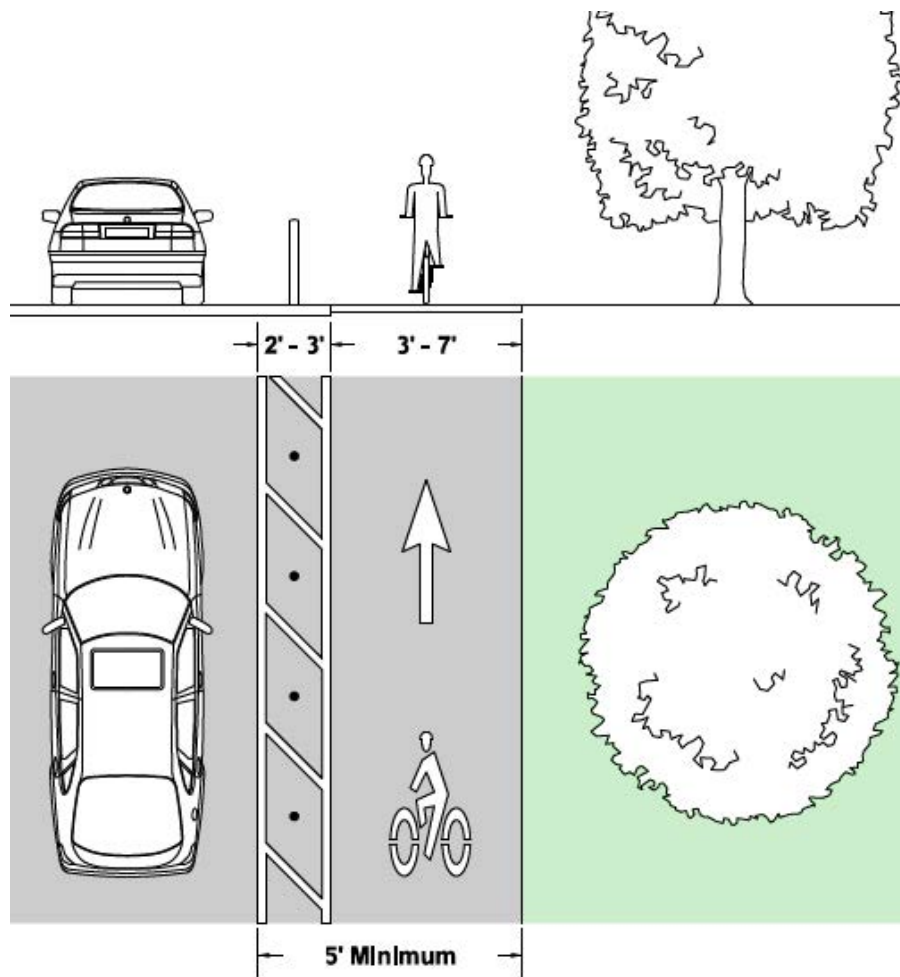

1520.02(3) Buffered Bike Lane

Exhibit 1520-3 shows a buffered bike lane. The design is effectively the same as a separated buffered bike lane (see 1520.02(2)) without the use of vertical separators. Consider a 3-foot buffer strip whenever possible. When utilizing a buffer, the bike lane itself may be 3 feet in width, but it is recommended that 5 feet be provided exclusively to the bike lane to enable passing maneuvers between cyclists. High cyclist volume locations should consider more width to facilitate mobility performance for this mode. In locations where the posted speed is 30mph or less and lower volumes of cyclists are anticipated, the minimum total width of both the bike lane and buffer combined is 5 feet. In locations where inexperienced bicyclists, such as children, are expected or when there is a steep uphill grade the minimum total width of both the bike lane and the buffer combined is 6 feet.

Exhibit 1520-3 Buffered Bike Lane

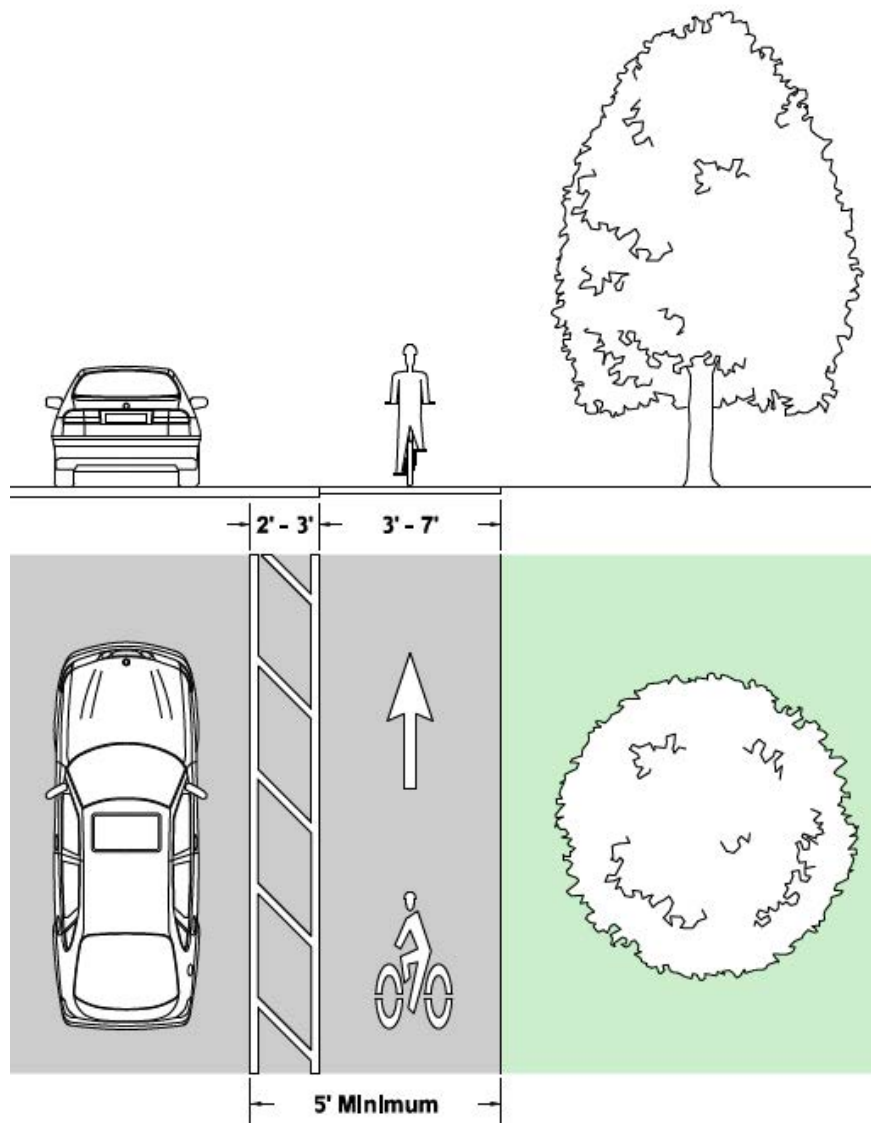

1520.02(4) Conventional Bike Lane

Conventional bike lanes are at grade and adjacent to motor vehicle traffic lane and are designated by a single solid wide stripe between the motor vehicle lane and bike lane. Additional bike markings (see the [Standard Plans](#)) in the bike lane and signage are employed. A width of 6 feet is recommended for a conventional bike lane when designing for the “Interested, but Concerned” user type. The minimum width for a conventional bike lane is 5 feet when adjacent to curb, or 4 feet when no curb is present. Additional width is considered when higher volumes of cyclists are anticipated or when adjacent to parallel on-street parking. Exhibit 1520-4 shows a conventional bike lane.

Exhibit 1520-4 Bike Lane

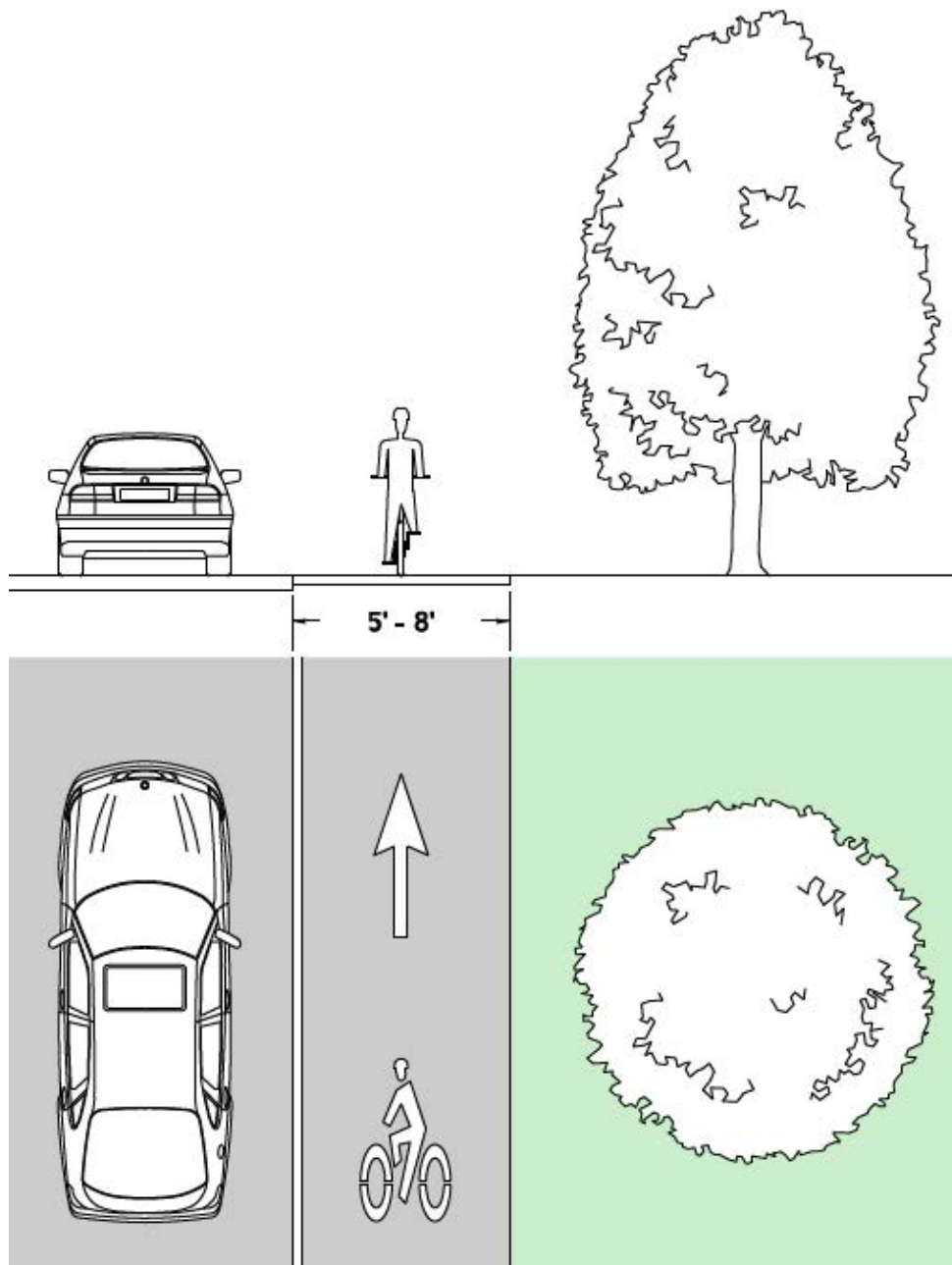

1520.02(5) Shared Lane

A shared lane is a combined motor vehicle and bicycle lane, as shown in Exhibit 1520-5. Shared lanes are appropriate for lower-speed and lower-volume streets. Shared lanes employ pavement markings and signage to indicate the combined use. Shared lanes are more common in bicycle boulevards, establishing a complete network for cyclists within an urban or suburban environment. Shared lanes may be used on state highways within the ranges presented in [1520.03](#); however, it is more likely that shared lanes will interface with state highways through crossing situations. It is important to consider how to configure an intersection or dedicated bicycle crossing location when intersecting with a bicycle boulevard network (see [1520.04\(5\)](#)).

Exhibit 1520-5 Shared Lane Markings

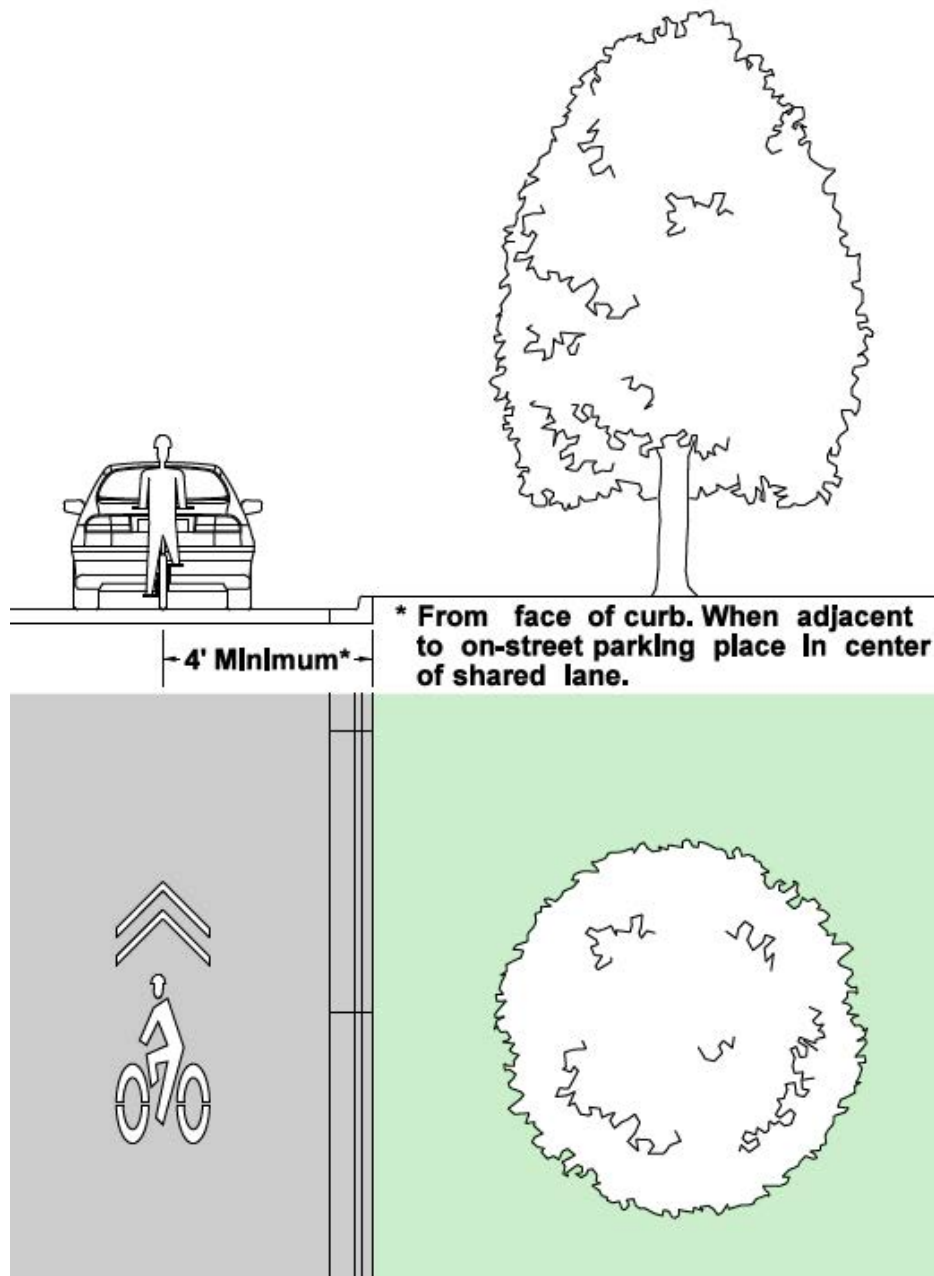

Shared lane markings (aka “sharrows”) are pavement markings specifically used to indicate a shared lane or intersection space. The position of the marking can encourage a desired lateral position within the lane for cyclists, as well as alerting motor vehicle users. Consider the shared lane marking placement with respect to on-street parking and the potential for dooring that will lower safety performance for the cyclist. Shared lane markings must be placed at least 4 feet from the face of curb, or in the center of the shared lane (or at least 11 feet from face of curb) when an adjacent parallel parking zone is present.

Conventionally, wide lanes have been encouraged for shared-lane applications, to allow for motor vehicles to pass cyclists, or for cyclists to pass motor vehicles in a queue. However, wider lanes may also encourage motor vehicle drivers to travel at higher speeds and a detriment for a shared lane application. Permitting in-lane passing between motor vehicles and bicyclists can lower safety performance for cyclists.

The speed of cyclists can vary significantly between users, and depends on the experience, fitness level of the user, bike technology, and roadway grade. If a shared lane is proposed on an hill, consider a conventional bike lane in the upgrade direction of travel.

1520.02(5)(a) Accommodating Bikes on Shoulders

Many rural highways are used by bicyclists for commuting between cities or for recreation. Providing and maintaining paved shoulders can significantly improve convenience and safety for both bicyclists and motorists along such routes.

Accommodating bicycle users on the shoulder is common on state highways, particularly on rural high-speed facilities. Shoulder improvements to facilitate bicycle travel include widening the shoulders to a minimum of 4 feet, improving roadside maintenance (including periodic sweeping), and removing surface obstacles such as drain grates that are not compatible with bicycle tires. If shoulder rumble strips are present, provide for at least 4 feet of usable shoulder between the rumble strip and the outside edge of shoulder. If guardrail or barrier is present, increase the dimension to 5 feet of usable shoulder.

Accommodating bicycle use on shoulders is appropriate at many locations. Note, however, that bike on shoulder accommodations are not dedicated bicycle facilities, and bicycle users do not have the same operating privileges as with designated roadway bike facilities. In rural to suburban/urban transition areas consider converting the shoulder to a protected buffered bike lane, both to encourage speed management of motor vehicle users through the transition and to establish a dedicated special-use lane for cyclists to tie into the local network.

1520.03 Bicycle Facility Selection

Bicycle facilities are desirable in order to provide viable travel alternatives, and for bicycle users to have the ability to access land use destinations along state highways.

Understand how the state highway interfaces with routes identified as local, state, or regional bike routes. If the state highway is the bike route, intersects with an existing route, or if bicycle users are an identified modal priority (See [Chapter 1103](#)), account for the bike facility needs within the design. Other projects need to consider a design that does not preclude the future vision for a planned bike route, depending on the context identification selection (See [Chapter 1102](#)) and design year selection (See [Chapter 1103](#)).

The only instance during planning or design when performance effects on existing or planned bike facilities may not be considered is in locations being designed for the existing context, and the location prohibits bicycle use. State highways that prohibit bike use can be found here:

<http://www.wsdot.wa.gov/bike/closed.htm>

1520.03(1) Types of Cyclists

Recent research indicates that people have different viewpoints and thresholds that dictate their willingness to utilize bike facilities. Three general types of cyclist users exist:

- *Strong and Fearless* – This cyclist type are confident not only in their abilities as a cyclist but also with their ability to operate intermixed with other modal users.
- *Enthusied and Confident* – These cyclists prefer utilizing separated facilities, but are comfortable riding intermixed within other modes in some transportation contexts.
- *Interested, but Concerned* – Cyclists who primarily have safety concerns and who are less skilled or less familiar with the rules of the road, but would like to ride more. These cyclists are frequently dissuaded from cycling, even if bike facilities are present, because of the degree of separation between themselves and other traffic. This category includes children and others new to bicycling.

1520.03(1)(a) Designing for the Interested, but Concerned

The Interested, but Concerned cyclist constitutes the largest segment of cyclist types within suburban, urban and small town populations. Bike facility selection on state routes is based on designing for the “Interested, but Concerned” user type as a starting point. [Exhibit 1520-6a](#) shows ranges of applications for the different types of bicycle facilities related to generally accepted safety and mobility performance for this design user.

Other performance needs may increase or decrease the viability of certain types of bike facilities, such as shared-use paths through aesthetic areas or those planned for a mixture of commute and recreational purposes. Further considerations for cyclist perception of comfort are another factor that can affect use of the facility. Designing for a higher level of separation may be more important at locations that serve community activity centers, schools or popular destinations (such as a retail oriented segment of a route) where additional accommodations are appropriate for either the functional uses or less skilled cyclists (including children). In these situations, separated facilities or wider dimensions may provide the level of comfort needed to satisfy user needs and context considerations. Additionally, some suburban, urban, and small town contexts will have more specific bicycle performance needs that will help identify either spot improvements or alteration of the type of existing facility to enhance a specific performance area. Bike facility selection in [1520.03\(1\)\(b\)](#) are provided for these reasons.

1520.03(1)(b) Designing for the Confident

In some contexts, it is appropriate to design for the Strong and Fearless, and Enthused and Confident user types. In cases, where right of way is very constrained or where bicycles are not considered the modal priority (see [Chapter 1103](#)), it is appropriate to use [Exhibit 1520-6b](#) for determining facility selection after input from community engagement efforts.

However, understand that the application of [Exhibit 1520-6b](#) may result in less mode shift or use of the capacity provided.

Exhibit 1520-6a Bicycle Facility Selection Chart – Interested, but Concerned Cyclists

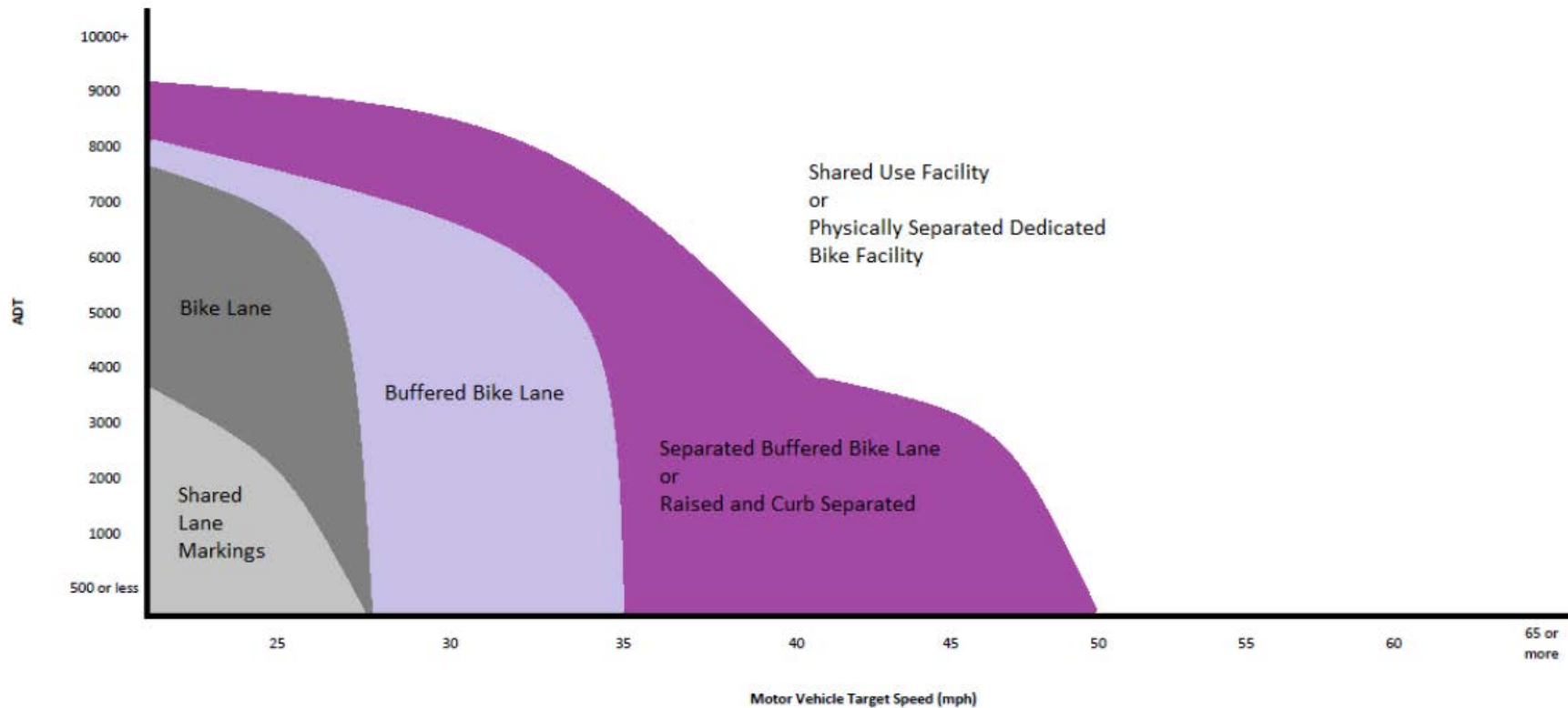

Note: Adapted from *Montgomery County Bicycle Planning Guidance*, Montgomery County Department of Transportation, 2014.

Exhibit 1520-6b Bicycle Facility Selection Chart – Confident Cyclists

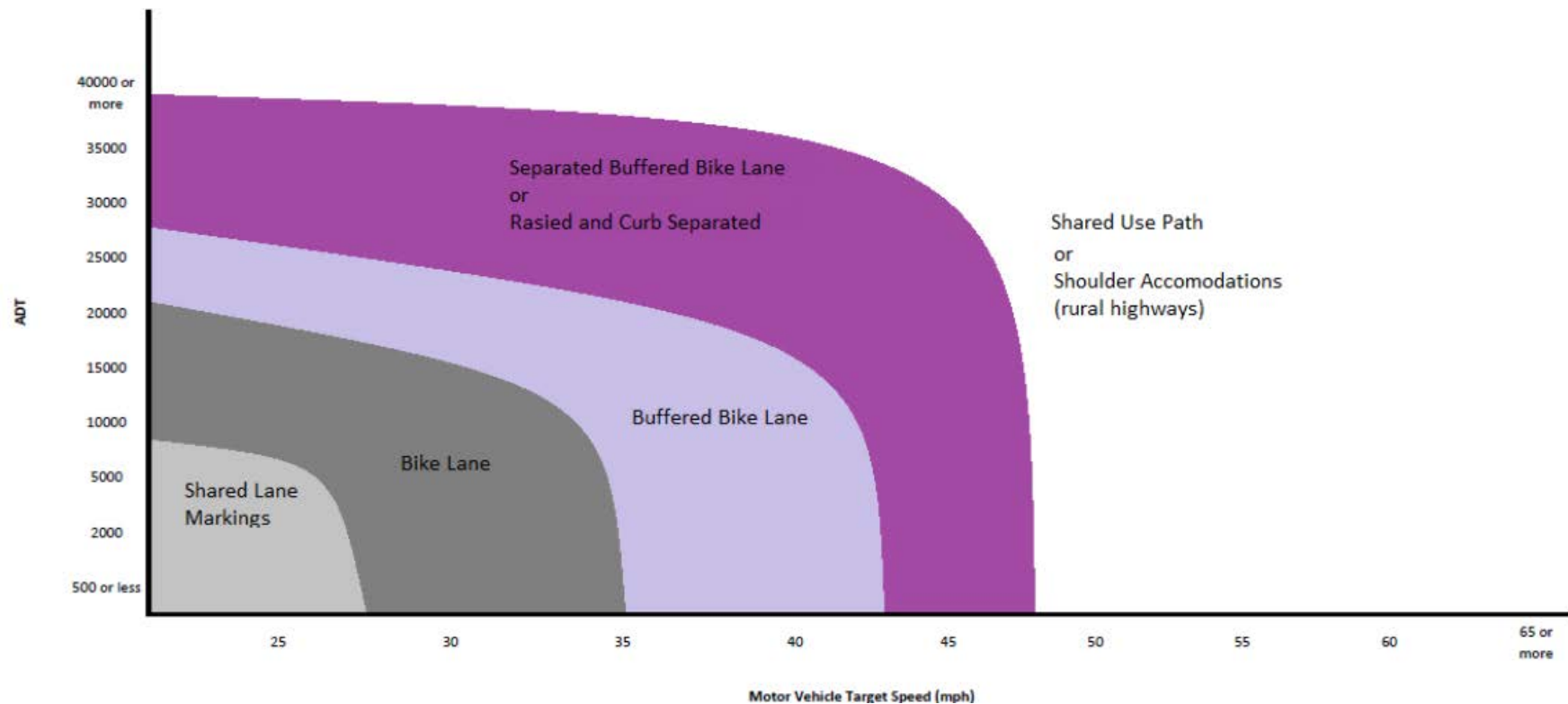

1520.03(2) Speed Considerations

While Exhibits 1560-6a and 1560-6b provide ranges of speeds in which different types of bike facilities may be appropriate, it is critical to understand that motor vehicle speed plays a significant role in crash severity between motor vehicles and cyclists. When designing multimodal facilities, a target speed selection within the low speed design control is encouraged. Safety performance increases as motor vehicle speeds are decreased. The optimum target speed for safety performance of multimodal designs is the lowest statutory speed allowed on state routes, which is 25 mph. See Chapter 1103 for further discussion on target speed and speed management treatments.

1520.04 Intersection Design Treatments

The principle objective when designing intersections for bicycle mobility and safety performance is to provide a visible, distinct, predictable, and clearly designated path leading to and through the intersection while managing potential conflicts between all other users and cyclists. This chapter covers options for intersection design for bicyclists while chapters in the 1300 series provide guidance for intersection control type selection and design.

Intersection design to meet the bicycle safety and mobility performance of the cyclist is unique to each location. The primary emphasis is to create a visible, distinct, predictable and clear path for the cyclist to reduce conflicts between cyclists and other design users. This is most commonly achieved through clear delineation of the bike facility leading up to and through the intersection, along with segregating or prioritizing movements between design users. Several proven state-of-the-practice intersection treatments are presented within this section. However, pavement marking or aspects about the configuration may not currently be supported by the *Manual on Uniform Traffic Control Devices*.

At the time of publication, bike boxes (1520.04(2)) and two-stage left turn lanes (1520.04(3)) are subject to an experimentation request to FHWA. Obtain Headquarters (HQ) Traffic Office approval and assistance with submitting a request for experimentation. Consult, as appropriate, the Federal Highway Administration's (FHWA) MUTCD website for bicycle facilities for a listing of the current status of bicycle-related pavement markings and treatments:

http://www.fhwa.dot.gov/environment/bicycle_pedestrian/guidance/mutcd/index.cfm.

See 1520.05(1) for additional information on bicycle pavement markings under MUTCD evaluation.

Note: Exhibits 1520-7 through 1520-9 all show colored pavement markings to increase the safety performance of intersection designs. However, colored pavement markings are not required, and may be added at a later stage if the desired safety performance is not met.

1520.04(1) Approach Through Lanes

The approach to intersections needs to balance the bicycle user's safety needs with the mobility needs of other users. Clear delineation of user lanes and potential conflict areas is currently the treatment most commonly used to manage the approach to intersections. Use dotted lines to identify the conflict area. Colored pavement markings can be used to further enhance and delineate the conflict area. Exhibit 1520-7 shows different applications of the approach through lane most likely to be encountered.

1520.04(2) Bike Boxes and Crossing Pavement Markings

Bike boxes are designated areas for bicyclists positioned across and in front of the bike and motor vehicle lanes as shown in [Exhibit 1520-8](#). Bike boxes are used at signalized intersections and increase both mobility and safety performance for the bicycle mode. Applying a bike box assists mobility performance by prioritizing the bicycle movement at an intersection, and enables a cyclist to position for a left-turn movement. Bike boxes have also been found to prevent cyclist and motor vehicle encroachment into the pedestrian crossing, reducing conflicts with pedestrians at intersections. Bicycle safety performance is improved by increasing the visibility of the cyclist, and by reducing conflicts between motor vehicles making a right turn and the bicycle through movement (also known as “right-hook” conflict).

There are several different ways to delineate bike lanes through the intersection. Dotted lines are the most common, but can be combined with sharrows or green pavement markings (see [1520.05\(1\)](#)) to further enhance the bike facility’s presence and position within an intersection.

1520.04(3) Two-Stage Left Turns

[Exhibit 1520-9](#) shows an example of a two-stage left-turn design for bicycle users. This design utilizes a rectangular bike box to enable cyclist queueing at the crossroad signal phase. The bicyclist passes partway through the intersection to access the bike box, and then waits for the crossroad next signal phase to eliminate the bicyclist left turn movement. This treatment is has best value at intersections with significant volumes of motor vehicle traffic or large volumes of left-turn cyclists, or when separated or buffered roadway bicycle facilities are used on the segment.

This treatment can increase safety performance by reducing conflicts between cyclists and other users, segregating motor vehicle and bicycle users, and separating turning cyclists from through cyclists.

The position of the queue box is a critical aspect of this intersection design. Depending on the size and configuration of the intersection, it may present a modal performance trade-off between bicycle mobility and safety versus motor vehicle mobility performance. Use turn simulation software to verify the queue box is outside the crossroad left-turn path, or restrict left turns at the crossroad to accommodate the queue box. Similarly, right turns may need to be restricted for motor-vehicles approaching the queue box if motor vehicle right-turn lanes or right-turn pockets are not present.

Exhibit 1520-7 Approach Through Lanes

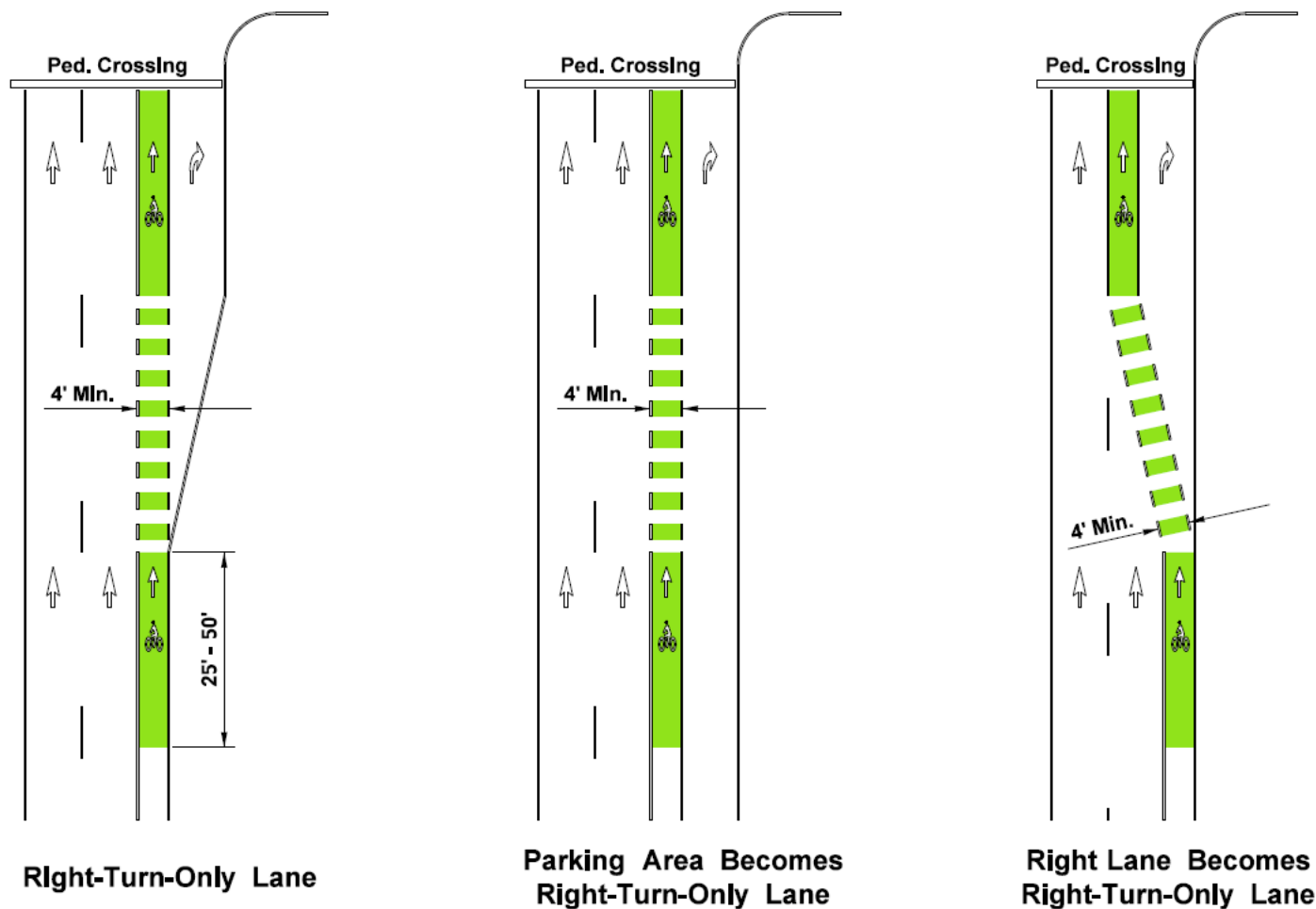

Notes:

- Not to scale and not all dimensions shown.
- See [1520.05\(1\)\(a\)](#) for criteria when considering the use of green colored pavement markings.
- Consider both the speed of motorized vehicles and bicyclists when determining the length of weave and degree of taper for the bike lane.

Exhibit 1520-8 Bike Box and Intersection Crossing Markings

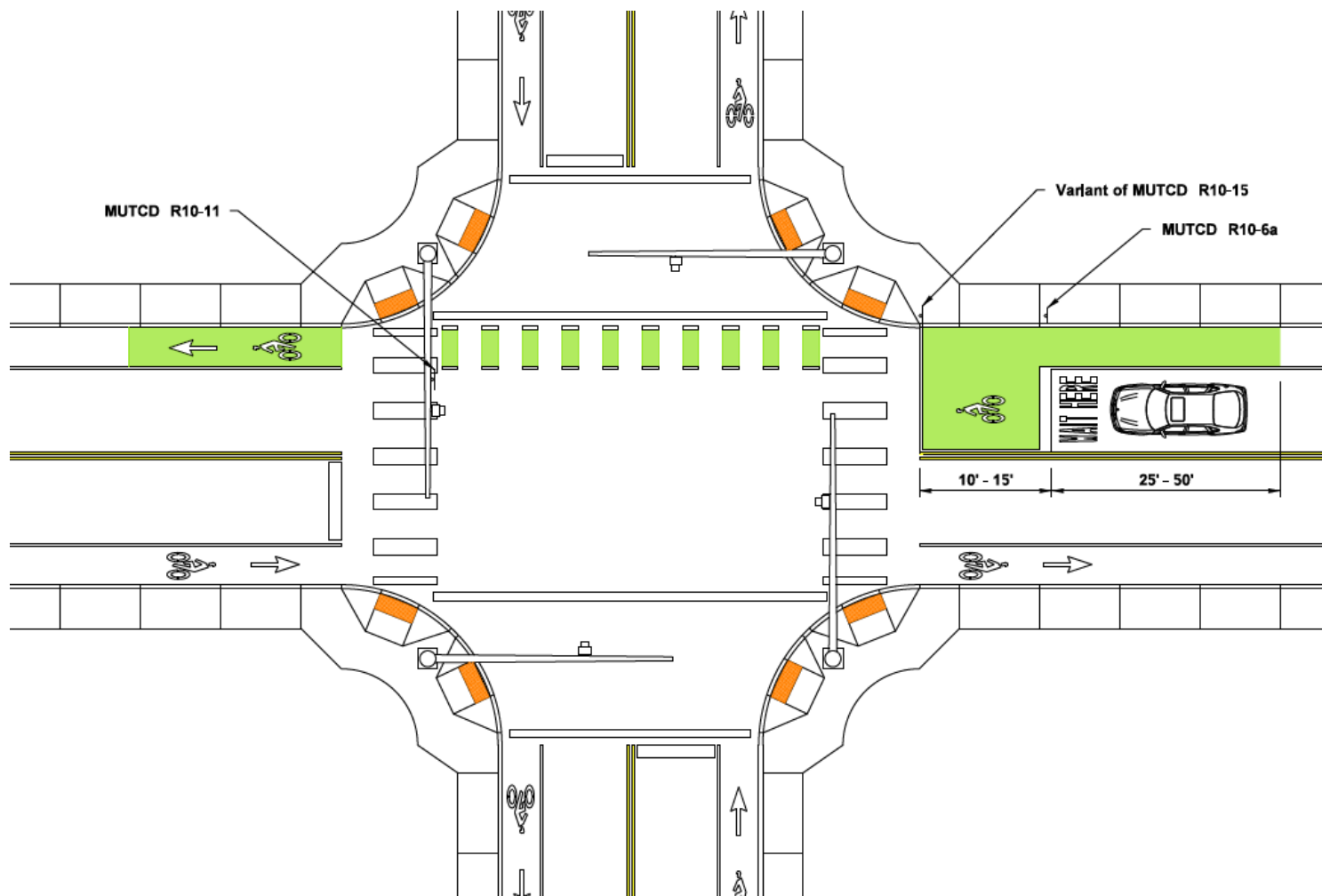

Notes:

- This exhibit is intended to illustrate options for bike facilities through interchange areas, and not intended to represent recommended practice for any other features including ADA criteria (See Chapter 1510 for ADA and pedestrian design).
- See 1520.05(1)(a) for criteria when considering the use of green colored pavement markings.

Exhibit 1520-9 Two-Stage Left-Turn Queue Box

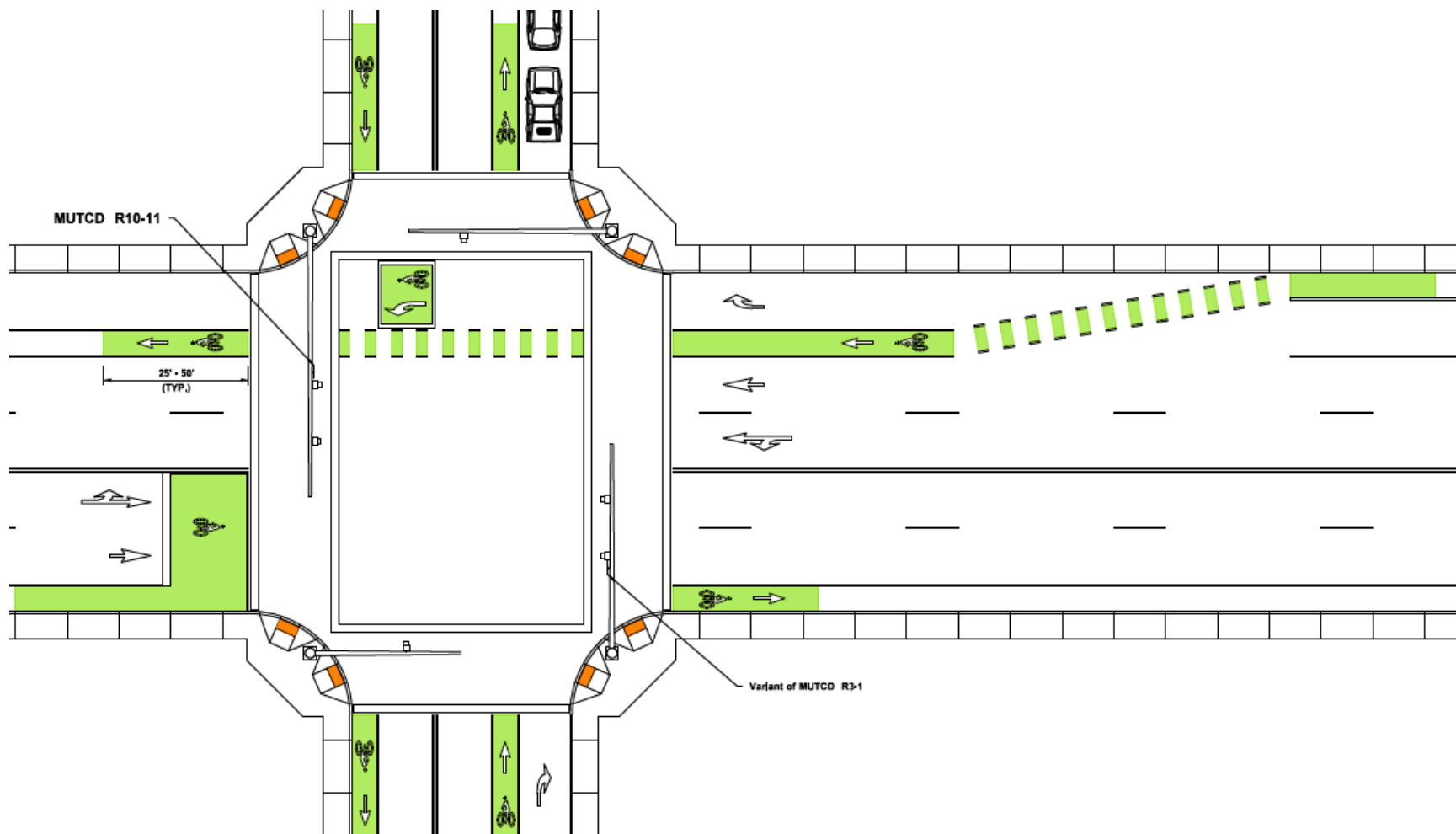

Notes:

- This exhibit is intended to illustrate options for bike facilities through interchange areas, and not intended to represent recommended practice for any other features including ADA criteria (See [Chapter 1510](#) for ADA and pedestrian design).
- Consider both the speed of motorized vehicles and bicyclists when determining the length of weave and degree of taper for the bike lane.
- See [1520.05\(1\)\(a\)](#) for criteria when considering the use of green colored pavement markings.

Exhibit 1520-10 Median Refuge Island for Cyclists

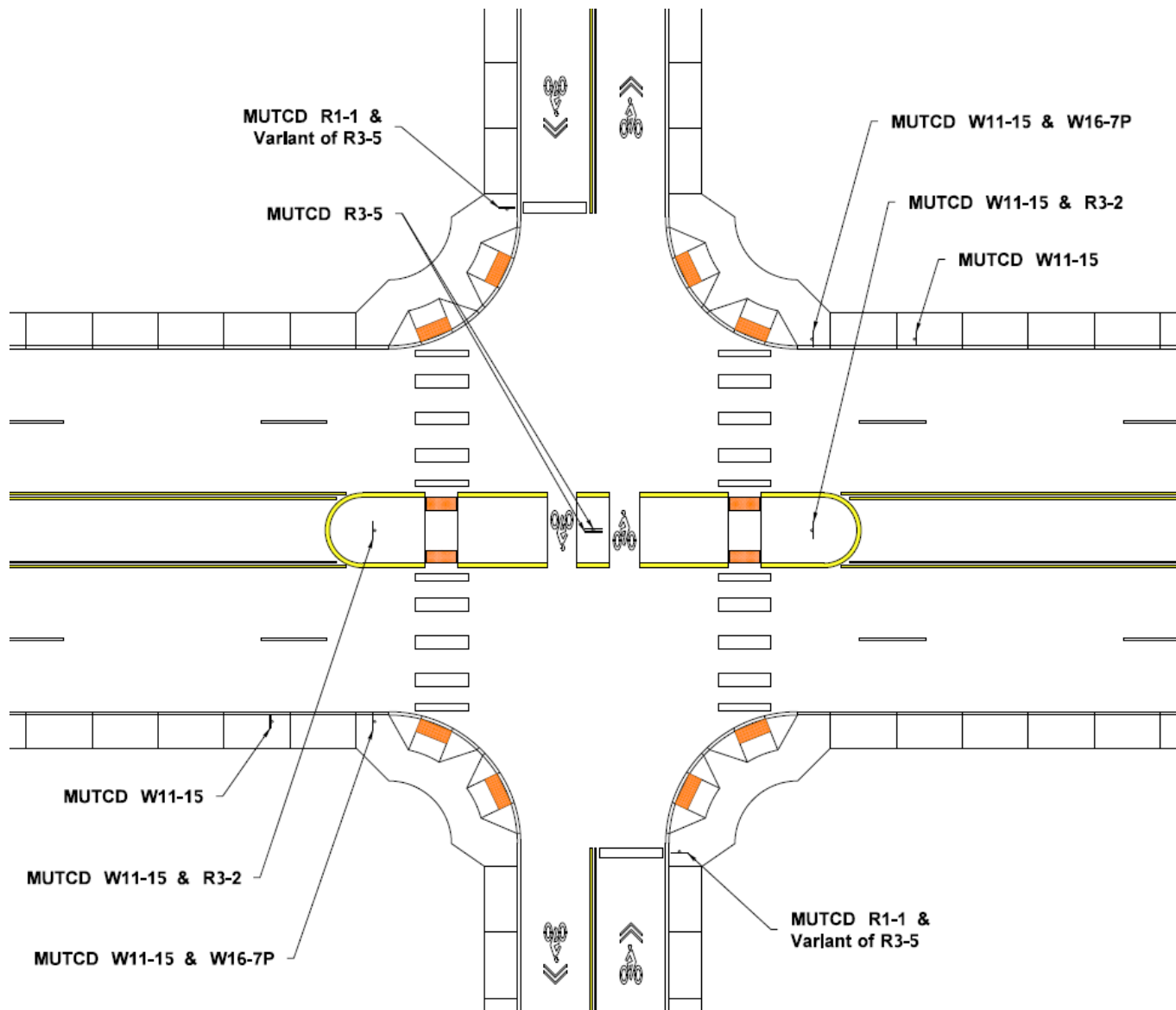

1520.04(4) Traffic Signals Considerations

Consider bicycle needs and intersection geometry when timing the traffic signal cycle and when selecting the method of detecting the presence of cyclists. Contact the regional Bicycle Coordinator and region Traffic Engineer for assistance in determining the timing criteria. At a minimum consider safety performance needs, projected bicycle volume, motor vehicle volume, traffic delay, roadway grade and the types of bicyclists using the intersection that may require more time to clear the intersection. Consider the installation of effective loop detectors or other methods of detecting a bicycle within the bike lane (in advance of the intersection) and turn lanes. Select detectors sensitive enough to detect bicycles, and use a bike detector symbol to identify detector presence.

Push button actuators may also be used to facilitate movement of bicyclists through a signalized intersection. However, requiring bicyclists to go out of their way to use push button actuators may create motor vehicle driver confusion of the bicyclists intended path through the intersection, as well as inconveniencing the bicyclist. If pushbutton actuators are used, consider their position relative to the bike facility. Pushbutton actuators are more effective when the bike facility is adjacent to the curb (curb extensions at intersections can create this environment). Consider an additional push button actuator for the exclusive use of cyclists when positioning of the actuator is in conflict with ADA design requirements (see [Chapter 1510](#)). For additional guidance on signal design, see [Chapter 1330](#).

1520.04(4)(a) Bike Signals

Intersections with separated bike lanes, other complex multimodal intersection treatments or those with a specific baseline need to increase bicycle user safety performance may incorporate a dedicated bike signal head with detection or actuation systems. Bike signal heads further separate modal user movements at intersections, while also allowing for priority to cyclists at intersections. Contact the region Traffic Engineer for approval for application of this treatment.

At the time of this publication, bike signal faces are subject to requirements of FHWA Interim Approval for this treatment. For current status of the treatment and conditions of the Interim Approval, if still applicable, see

http://www.fhwa.dot.gov/environment/bicycle_pedestrian/guidance/mutcd/index.cfm

1520.04(5) Median Refuge Islands for Cyclists

Layered networks have the benefit of separating modes onto different facilities to either enhance mobility or safety performance of active transportation modes. However, layered networks do intersect and specific median treatments exist to manage the confluence of these networks.

Median refuge islands provide a refuge for bicyclists to cross one direction of traffic at a time while restricting motor-vehicle through movements on crossroads designated as primary bicycle corridors or bike boulevards. The treatment minimizes impacts for bicyclists on the crossroad while prohibiting motor vehicle left turn movements from the cross street to eliminate conflicts.

Consider median refuge islands when one or more of the following occurs:

- Bike facilities cross a roadway with median restricted left turns.
- Bike facilities cross a moderate to high (motor vehicle) volume roadway, with intermediate motor-vehicle speeds
- Bike facilities cross a 4 lane divided highway.
- Separated or buffered bike facilities used on the cross street.
- There is a performance need to restrict motor vehicle through traffic on a bike route.
- Safety or mobility performance need of mainline cyclists exist for left turning movements onto a bike route or shared use pathway

[Exhibit 1520-10](#) shows an example of a median refuge designed for cyclists. Design refuge areas between 4 and 5 feet wide (longitudinally with respect to the median), additional width may be needed if high volumes of cyclists exist or are anticipated at the crossing. Consider the types of cyclists and destinations when determining the median refuge length (lateral dimension with respect to the median) to adequately store the bicycle. Consider what locations may need to accommodate the length of a bicycle and trailer. The refuge area is to be in alignment with the approach and receiving lanes of the crossroad. In other situations the median refuge island may be designed for both pedestrians and bicycle users. When this is the case, design the median refuge predominately for the pedestrian as with midblock crossings (See [Chapter 1510](#)), note that additional lateral and longitudinal dimensions will be necessary.

1520.05 Additional Bicycle Design Requirements and Considerations

1520.05(1) *Signing and Pavement Markings*

Use the [MUTCD](#) and the [Standard Plans](#) for signing and pavement marking criteria. (See [Chapter 1020](#) for additional information on signing and [Chapter 1030](#) for information on pavement markings). Pavement marking and signing options for bicycle facilities are rapidly changing. Situations may exist where unique project concerns may necessitate innovative pavement markings or signage. Consult, as appropriate, the Federal Highway Administration (FHWA) MUTCD website for bicycle facilities for a listing of the current status of bicycle-related pavement markings and treatments:

http://www.fhwa.dot.gov/environment/bicycle_pedestrian/guidance/mutcd/index.cfm

HQ Traffic Office approval is necessary for traffic control devices not currently approved for use through the [MUTCD](#).

1520.05(1)(a) Green Pavement Marking – Criteria for Consideration

Green -colored pavement markings are a traffic control device whose need must be demonstrated before use and documented with a design decision. The highest benefit of applying green colored pavement markings occurs where the potential conflicts exist between cyclists and other design users, or when other design users should yield to cyclists. Green colored pavement markings are only intended as a supplemental treatment for standard striping configurations for bicycle facilities.

The below criteria are provided when evaluating the need to apply green colored pavement markings.

1. Existing Bike Facilities – retrofitting an existing facility with green pavement may be considered when two or more of the following apply:
 - a. It is the engineering judgment of the Region Traffic Engineer
 - b. There is an existing traffic conflict area, such as bike lane crossing a motor vehicle turn lane, and there are one or more observed motor vehicle and bicyclist crashes in the last 5 years.
 - c. The bike mode is a modal priority (see [Chapter 1103](#)), and there is a baseline or contextual need identified associated with increasing safety performance of the mode.
 - d. When a bike route intersects a multilane highway, and the crossing is neither signalized nor a roundabout.
2. Changing of Bike Facility Type –consider green pavement markings when one or more of the following apply:
 - a. It is the engineering judgment of the Region Traffic Engineer.
 - b. A transition from a separated facility through a functional intersection or interchange area necessitates additional delineation to create a clear, visible, predictable and distinct travel path for bike users, and a bike signal or actuation device is not used.
 - c. The facility type change does not substantively alter the configuration of an existing conflict area, and there are one or more observed motor vehicle and bicyclist crashes in the last 5 years at that conflict area.
3. New Bike Facility – Generally, the immediate application of green colored pavement on a new bike facility is discouraged until the need for increased safety performance is demonstrated. This said, consider green colored pavement when two or more of the following conditions exist:
 - a. It is the engineering judgment of the Region Traffic Engineer
 - b. The bike mode is a modal priority (see [Chapter 1103](#)), and there is a baseline or contextual need in which the application of green colored pavement markings is needed to meet the stated modal safety performance target (see [Chapter 1101](#)).
 - c. The bike facility nodes and/or crossings are within 1 mile of activity centers, such as schools, libraries, colleges, etc.
 - d. The bike facility crosses a motor vehicle free right turn to or from an interchange ramp.
 - e. The bike facility is a bike route or bike boulevard (for definition, see NACTO’s [Urban Bikeway Design Guide](#)).
 - f. The state route is also a city street, and the city policy or municipal code requires green colored pavement markings as their standard.
 - g. The bike facility is raised and curb separated, and the city engineer requests green colored pavement markings at either crossings or conflict areas.

1520.05(1)(b) Green Pavement Marking – Configuration

Use green pavement markings to supplement the conventional white bike lane striping as required by the MUTCD. Apply green colored pavement markings in conflict areas, consistent with what is shown in Exhibits 1520-7 through 1520-9. Preceding the conflict area, apply solid green 25-50 feet in length (see Exhibit 1520-11), use green ladder striping between the required white dotted striping through the extent of the conflict area, and apply solid green after the ladder striping for at least 25 ft but no more than 50 ft. If closely spaced conflict areas exist, it may be appropriate to carry solid green into the next conflict area as determined by the Region Traffic Engineer.

1520-11 Length of Solid Green Pavement Marking Preceding Conflict Area

Motor Vehicle Speed	Length of Solid Green Colored Pavement Marking Preceding Conflict Area
25 mph	25 ft
30 mph	30 ft
35 mph or more	35-50 ft
Interchange Ramps	See 1520.05(6)

Additional configurations or styles exist for the application of green colored pavement and can be used with the approval of HQ Traffic Office. Consider specifically when bike route continuity with a local agency's bike facilities is a concern.

1520.05(2) Drainage Grates and Manhole Covers

Locate drainage inlet grates and manhole covers to avoid bike lanes. When drainage grates or manhole covers are located in a bike lane, minimize the effect on bicyclists. Consider providing 3 feet of lateral clearance between the edge of a drainage inlet grate and the bike lane stripe, when practicable. Install and maintain grates and manhole covers level with the surface of the bike lane.

Provide drainage inlet grates on bicycle facilities that have openings narrow enough and short enough that bicycle tires will not drop into the grates. Replace existing grates that are not designed for bicycles: a WSDOT vanned grate, herringbone grate, or other grate with an opening 4 inches or less center to center and perpendicular to the direction of travel.

1520.05(3) At-Grade Railroad Crossings

Whenever a bike lane crosses railroad tracks, continue the crossing at least as wide as the bike lane. Use special construction and materials to keep the flangeway depth and width to a minimum. Wherever possible, design the crossing at right angles to the rails. Where a skew is unavoidable, widen the shoulder or bike lane, to permit bicyclists to cross at right angles. Exhibit 1520-12 shows options and details to consider for at-grade railroad crossings.

Exhibit 1520-12 At-Grade Railroad Crossings

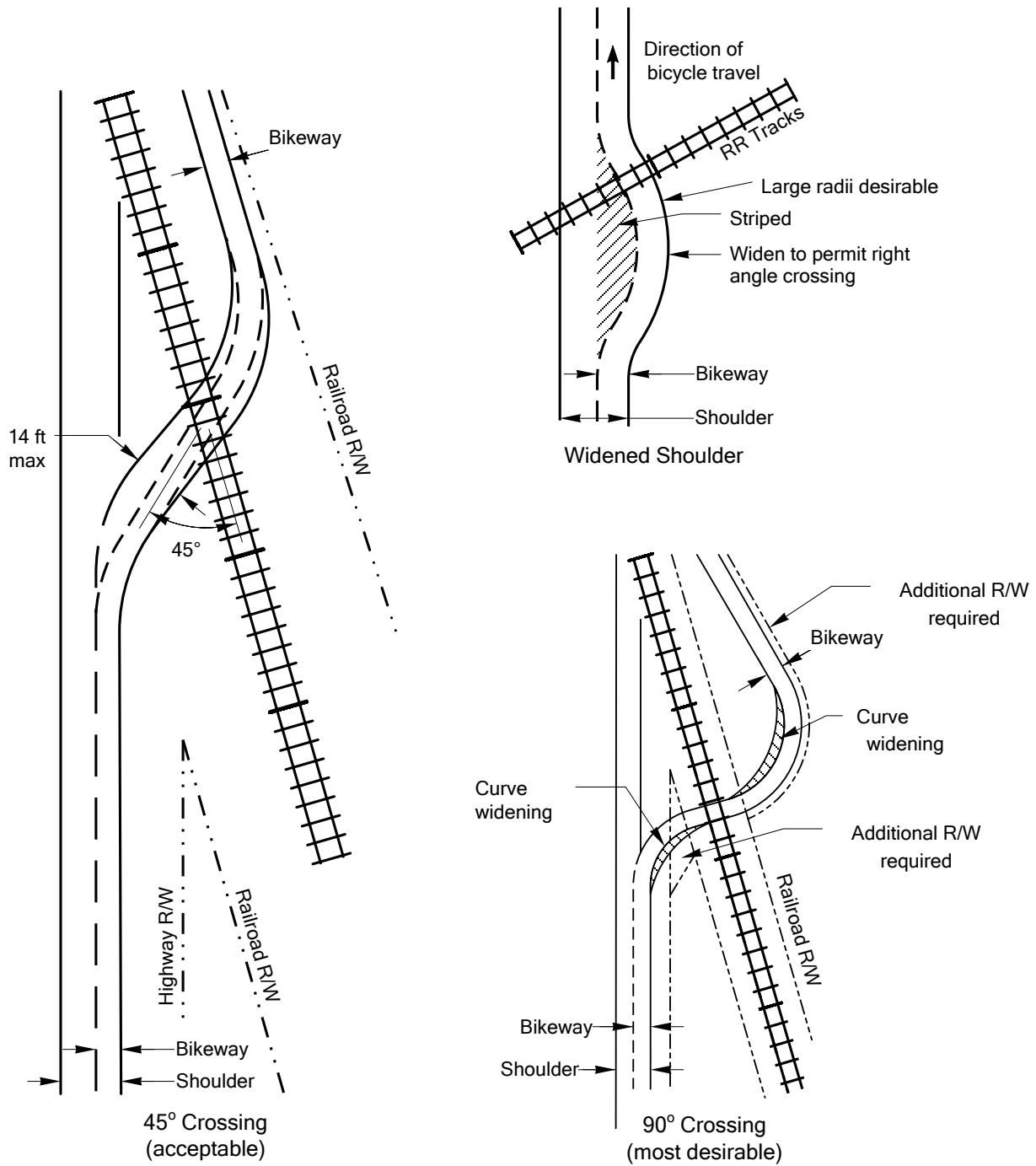

Notes:

- Provide additional width at railroad crossings to allow bicyclists to choose their own crossing routes.
- When pedestrians are provided for, design as a shared-use path (see Chapters 1510 and 1515).

1520.05(4) Barrier and Railing

When the edge of the bike lane is within 5 feet of a barrier or railing, provide a barrier height a of 42 inches or more to reduce the potential for bicyclists to fall over the barrier (see Exhibit 1520-13). When the bicycle facility is adjacent to barrier, consider single slope barrier to mitigate for pedal movement conflicts other barrier designs.

On structures, the bridge railing type and height are part of the structure design. Contact the HQ Bridge and Structures Office for additional information. (See [Chapter 720](#) for further considerations.)

Exhibit 1520-13 Barrier Adjacent to Bicycle Facilities

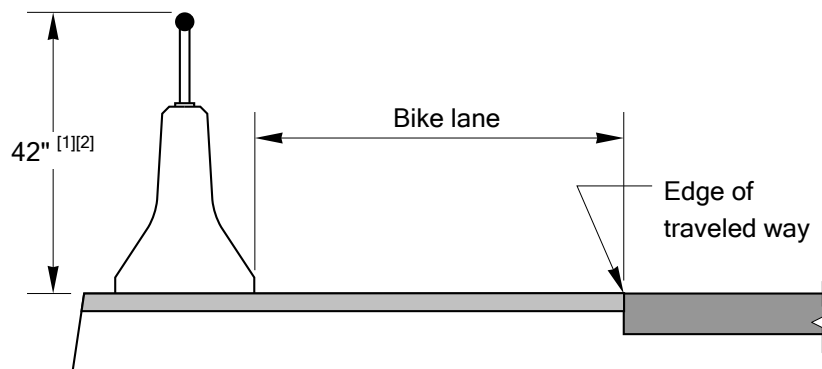

Bike Lane

Bike lane between edge of traveled way and barrier

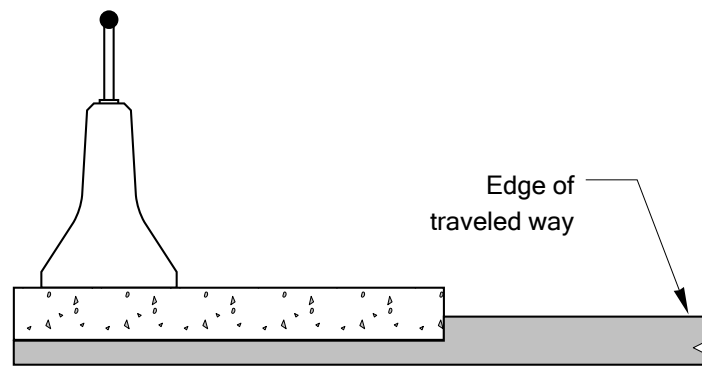

Bike Lane With Sidewalk or Curb

Bike lane between edge of traveled way and sidewalk

Notes:

- [1] Height does not apply to bridge railing. On structures, the bridge railing type and height are part of the structure design. (Contact the HQ Bridge and Structures Office for additional information.)
- [2] Applies to bike lanes. Additional height is not needed for shared-use roadways.

1520.05(5) *Transit Considerations*

Transit and bicycle facilities can generate unique conflicts because of their typical position within the geometric cross section of the traveled way zone. Where public transport and cycling facilities meet, an integrated design that does not inconvenience either mode is desirable to meet the performance needs of these modes. Consider the following:

- Route the bike lane behind the transit stop location using a raised bike lane or outer separation for that spot location. Ensure the resulting outer separation provided for the transit stop meets the Americans with Disabilities Act (ADA) requirements (see [Chapter 1510](#)). Ensure signing and pavement markings are used to alert cyclists and pedestrians of the conflict area created with this design.
- Provide additional delineation in the bike lane to highlight the pedestrian and cyclist conflict, when separated buffered bike lanes and in-lane transit stops are used. Bus loading and other conflict areas will need to meet ADA requirements (see [Chapter 1510](#)) and those of the transit agency.
- Where bus operating speeds are low, consider a bus-bicycle shared lane with the transit agency.

Consider providing bicycle parking facilities near public transportation stops to improve accessibility performance needs.

1520.05(6) *Interchange Considerations*

Crossing bicycle facilities through an interchange functional area has a greater potential for conflict because of higher travel speeds and lane configurations. Interchange crossings designed in a manner similar to intersection crossings are more compatible to bicyclists. Exhibits [1520-14a](#) through [1520-14d](#) illustrate design options for bike facilities design through an interchange functional area. Interchanges can be special environments to evaluate the safety and mobility needs of the bike mode. The specific challenge is often the inclusion of motor vehicle free right turns to or from interchange ramps. The preferred configuration for bicycle safety performance at an interchange will not provide the motor vehicle free right turn, and will realign ramps to intersect perpendicular with the crossroad (see off ramp terminal in [Exhibit 1520-14a](#)). However, given the modal priorities and operational performance needs of those priorities, this configuration may not always be practicable.

In some cases, it is possible to align the bike facility to cross an off ramp with a more direct path for the bike crossing (see [Exhibit 1520-14d](#)). Breaking up the work load for the motor vehicle driver is one advantage of this configuration, similar to pedestrian treatments common in roundabout design. Shortening the crossing distance required for the bicyclist is another advantage with this configuration. Consider the inclusion of Rectangular Rapid Flashing Beacons (RRFB) or a refuge island when there are multiple travel lanes. This configuration may also require additional speed management (see [Chapter 1103](#)), signing or striping treatments on the ramp.

Other situations may dictate additional delineation parallel to and matching the length of the auxiliary lane provided at the ramp terminal as shown in [Exhibit 1520-14b](#). This configuration can be coupled with additional signing preceding the motor vehicle merge, and additional separation or a buffer between the ramp's auxiliary lane and the through bike lane. The length of the motorized auxiliary lane will vary depending on speed and volume, so the length of green

markings shown in [Exhibit 1520-11](#) may not adequately satisfy the delineation desired at these locations. Consult with the Region Traffic Engineer for determining the length of green pavement markings at interchange locations, when they are provided according to [1520.05\(1\)\(a\)](#).

[Exhibit 1520-14c](#) provides a design option in which the bike lane merges with the sidewalk, and requires bicyclists to cross an interchange ramp at the pedestrian crossing. This configuration is ideal when bicycle mode is not identified as a modal priority, there is high motor vehicle ADT, there is a large intersection design vehicle, there is intermediate to high motor vehicle speeds, or when there are identification design users (see [Chapter 1103](#)) that suggests low experienced bicyclists will be present. Consider inclusion of an RRFB or a median refuge island when there are multiple lanes. Exhibits [1520-14b](#) and [1520-14d](#) also show the option of providing a bike ramp to the sidewalk. Providing options for cyclists at interchanges is encouraged, since the range of comfort among users is known to be diverse. Consult with the local agency regarding any prohibitions against bicyclists using the sidewalk that may negate the ability to implement this configuration.

Exhibit 1520-14a – Bike Facility Crossing On and Off Ramps

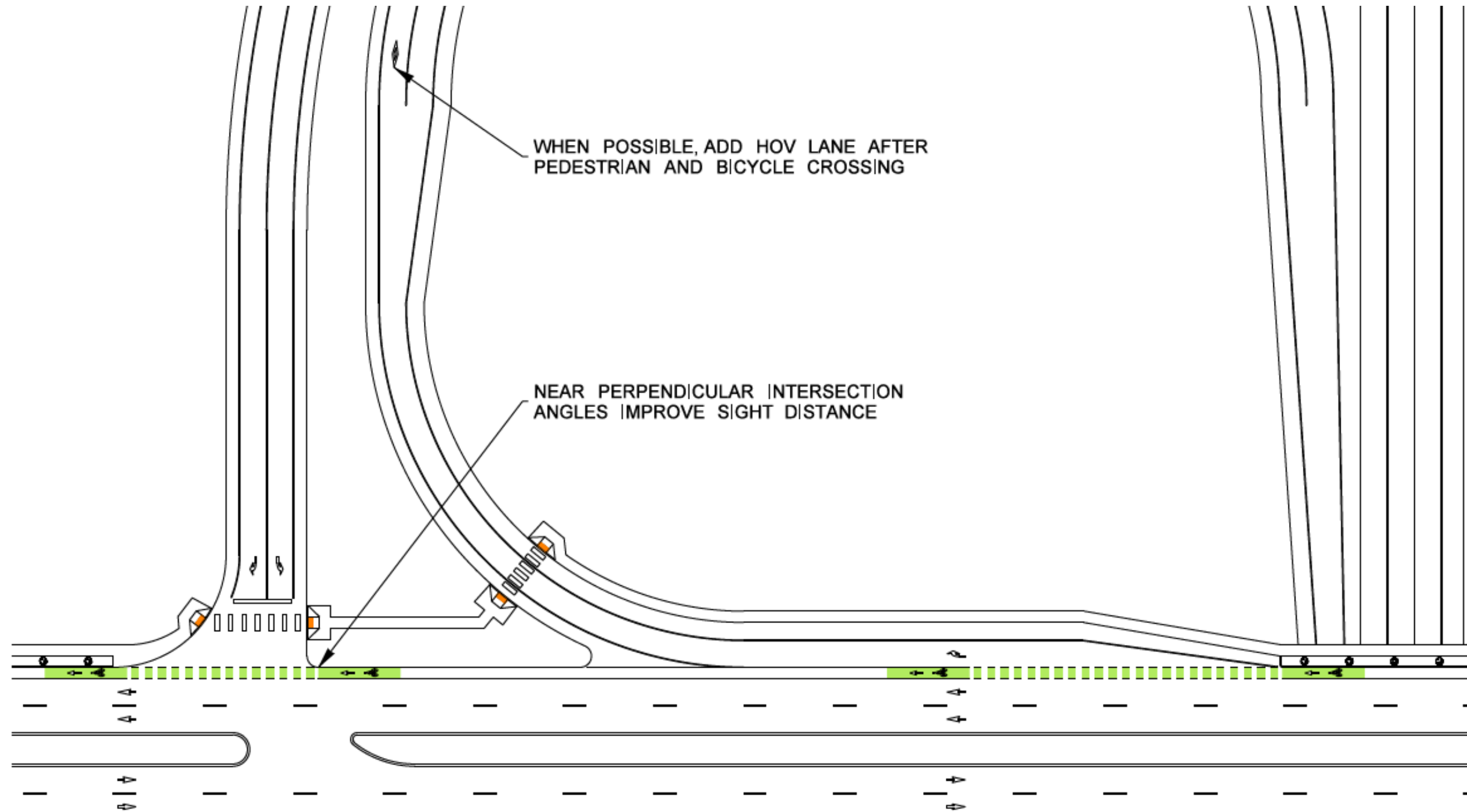

Notes:

- Adapted from the Draft *Recommended Design Guidelines to Accommodate Pedestrians and Bicycles at Interchanges*, ITE, unpublished.
- This exhibit is intended to illustrate options for bike facilities through interchange areas, and not intended to represent recommended practice for any other features including ADA criteria (See [Chapter 1510](#) for ADA and pedestrian design).

Exhibit 1520-14b – Bicycle Facility Crossing Single Lane On Ramp

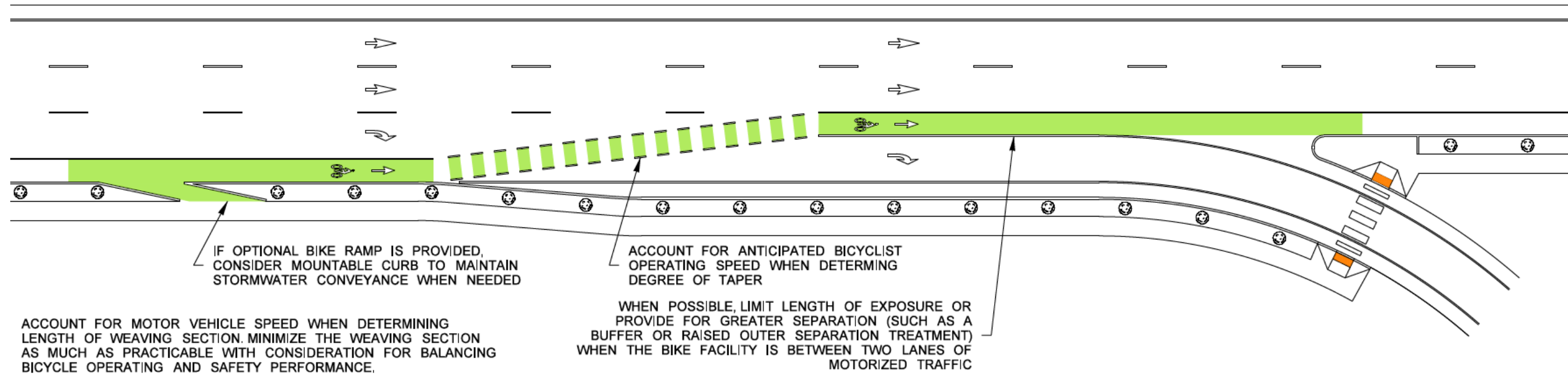
**Notes:**

- Adapted from the Draft *Recommended Design Guidelines to Accommodate Pedestrians and Bicycles at Interchanges*, ITE, unpublished.
- This exhibit is intended to illustrate options for bike facilities through interchange areas, and not intended to represent recommended practice for any other features including ADA criteria (See [Chapter 1510](#) for ADA and pedestrian design).
- Consider both the speed of motorized vehicles and bicyclists when determining the length of weave and degree of taper for the bike lane.

Exhibit 1520-14c – Bicycle Facility Crossing Option for Dual Lane On-Ramp Configuration

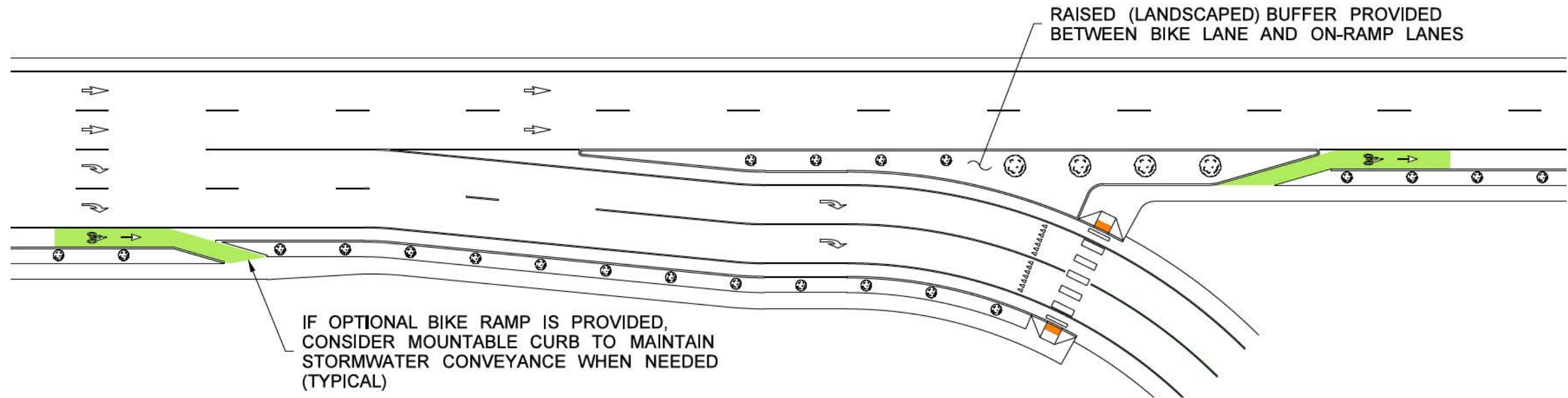

Notes:

- Adapted from the Draft *Recommended Design Guidelines to Accommodate Pedestrians and Bicycles at Interchanges*, ITE, unpublished.
- This exhibit is intended to illustrate options for bike facilities through interchange areas, and not intended to represent recommended practice for any other features including ADA criteria (See [Chapter 1510](#) for ADA and pedestrian design).

Exhibit 1520-14d – Bicycle Facility Crossing Option for Dual Off-Ramp

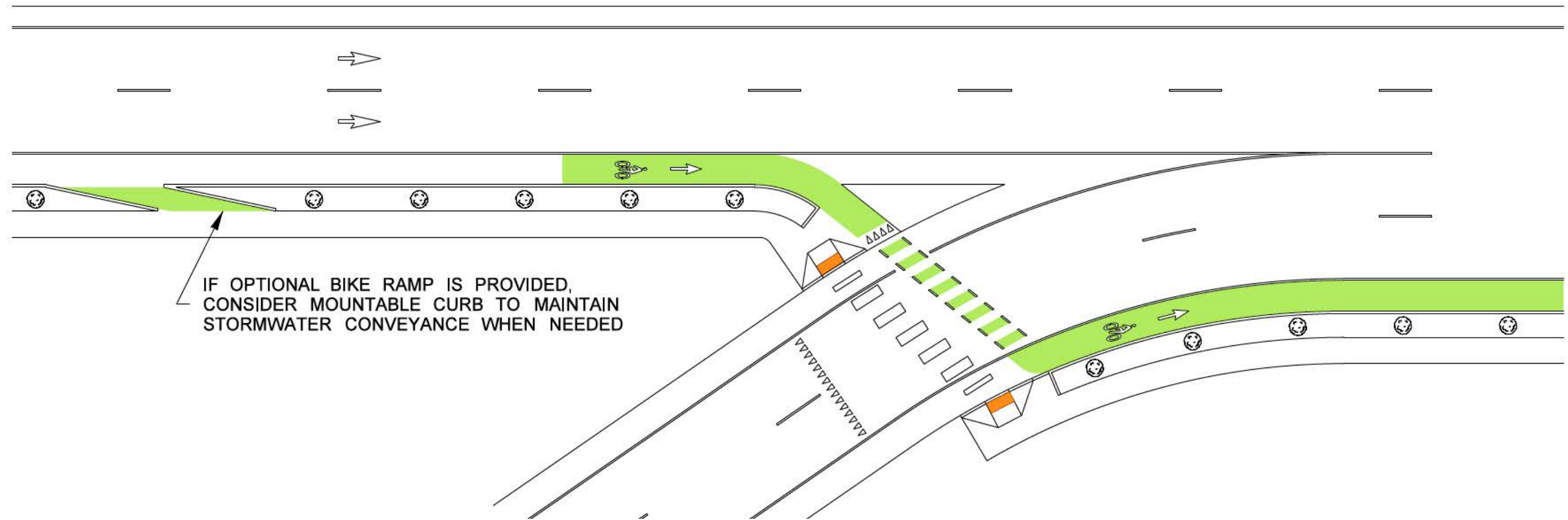

Notes:

- Adapted from the Draft *Recommended Design Guidelines to Accommodate Pedestrians and Bicycles at Interchanges*, ITE, unpublished
- This exhibit is intended to illustrate options for bike facilities through interchange areas, and not intended to represent recommended practice for any other features including ADA criteria (See [Chapter 1510](#) for ADA and pedestrian design).

1520.05(7) Sight Triangles at Intersections and Conflict Areas

The visibility of all users is to be evaluated at intersections. Identifying sight triangles can help determine the optimal configuration of bicycle and pedestrian crossings. See [Chapter 1310](#) for determining sight distance at an intersection, and [Chapter 1340](#) for sight distance at road approaches near midblock crossings. Visibility is impacted by both speed and the configuration of the intersection. There are multiple benefits in multimodal intersection configurations to proactively manage motorized vehicle speeds (see [Chapter 1103](#) for speed reducing traffic calming treatments) at intersection locations, rather than widening the intersection and/or removing elements from the roadside or streetside zone to obtain the needed sight distance. The primary objective at intersections and interchanges is to create a clear, distinct, and predictable travel path for all users through the intersection.

1520.05(8) Maintenance Considerations

Consult with all maintenance jurisdictions for partnering opportunities and clearly understand which jurisdiction will be responsible for specific elements of the bike facility maintenance. Some maintenance jurisdictions may be better equipped to maintain the bike facility than others. Certain bike facilities, like the raised and curb separated, clearly fall within the jurisdictional authority of an incorporated city (see chapters [1230](#) and [1600](#) for more information). For other facility types it may be more advantageous to discuss the capabilities of each maintenance jurisdiction, and develop a maintenance agreement (see [Chapter 301](#)).

It is important to obtain information from maintenance regarding the facility type and dimensioning, and discuss methods for maintaining the facility. The Maintenance Owner's Manual (See [Chapter 301](#)) is suggested to contain frequency, equipment needs and material types necessary for the continual maintenance of facility features, including but not limited to:

- Sweeping
- Snow removal
- Striping and pavement markings
- Signing

1520.06 Documentation

Document the type of bike facility employed or changed in section 5 of the Basis of Design. Dimensions chosen for the facility are documented on design parameter sheets.

1520.07 References

1520.07(1) Federal/State Laws and Codes

Americans with Disabilities Act of 1990 (ADA)

[23 Code of Federal Regulations \(CFR\) Part 652](#), Pedestrian and Bicycle Accommodations and Projects

Revised Code of Washington (RCW), Chapter 35.75, Streets – Bicycles – Paths

<http://apps.leg.wa.gov/rcw/default.aspx?cite=35.75>

RCW 46.04, Definitions

<http://apps.leg.wa.gov/rcw/default.aspx?cite=46.04>

RCW 46.61, Rules of the road

<http://apps.leg.wa.gov/rcw/default.aspx?cite=46.61>

RCW 46.61.710, Mopeds, electric-assisted bicycles – General requirements and operation

<http://apps.leg.wa.gov/rcw/default.aspx?cite=46.61.710>

RCW 47.26.300, Bicycle routes – Legislative declaration

<http://apps.leg.wa.gov/rcw/default.aspx?cite=47.26.300>

1520.07(2) Supporting Information

Urban Bikeway Design Guide, NACTO, current edition (WSDOT endorsed)

<http://nacto.org/publication/urban-bikeway-design-guide/>

Guide for the Development of Bicycle Facilities, AASHTO, current edition

https://bookstore.transportation.org/collection_detail.aspx?ID=116

Separated Bike Lane Planning and Design Guide, FHWA, current edition

http://www.fhwa.dot.gov/environment/bicycle_pedestrian/publications/separated_bikelane_pdg/page00.cfm

Bicycle Parking Guidelines, Association of Pedestrian and Bicycle Professionals, current edition

<http://www.apbp.org/?page=Publications>

Manual on Uniform Traffic Control Devices for Streets and Highways, USDOT, FHWA; as adopted and modified by Chapter 468-95 WAC “Manual on uniform traffic control devices for streets and highways” (MUTCD)

www.wsdot.wa.gov/publications/manuals/mutcd.htm

Standard Plans for Road, Bridge, and Municipal Construction (Standard Plans), M 21-01, WSDOT

www.wsdot.wa.gov/publications/manuals/m21-01.htm

Understanding Flexibility in Transportation Design – Washington, WSDOT, 2005

www.wsdot.wa.gov/research/reports/600/638.1.htm

Selecting Roadway Design Treatments to Accommodate Bicycles, USDOT, Federal Highway Administration (FHWA), 1994

NCHRP Report 766: Recommended Bicycle Lane Widths for Various Roadway Characteristics, Transportation Research Board of the National Academies, 2014

http://onlinepubs.trb.org/onlinepubs/nchrp/nchrp_rpt_766.pdf

NCHRP Report 500 Volume 18: A Guide for Reducing Collisions Involving Bicycles, Transportation Research Board of the National Academies, 2006

http://onlinepubs.trb.org/onlinepubs/nchrp/nchrp_rpt_500v18.pdf

Four Types of Cyclists?, Dill, Jennifer, and Nathan McNeil, Transportation Research Record: Journal of the Transportation Research Board 2387.1 (2013): 129-138.

Recommended Design Guidelines to Accommodate Pedestrians and Bicycles at Interchanges, ITE, unpublished.

<http://ecommerce.ite.org/IMIS/ItemDetail?iProductCode=RP-039>

Montgomery County Bicycle Planning Guidance, Montgomery County Department of Transportation, 2014.

<http://www.montgomeryplanning.org/transportation/bikeways/documents/FINALBicyclePlanningGuidance.pdf>

Separated Bike Lane Planning and Design Guide, Massachusetts Department of Transportation (MassDOT), 2015

<http://www.massdot.state.ma.us/highway/DoingBusinessWithUs/ManualsPublicationsForms/SeparatedBikeLanePlanningDesignGuide.aspx>

- 1600.01 General
- 1600.02 References
- 1600.03 Clear Zone
- 1600.04 Mitigation Guidance
- 1600.05 Medians
- 1600.06 Other Roadside Safety Features
- 1600.07 Documentation

1600.01 General

Roadside safety addresses the area outside the roadway and is an important component of total highway design. There are numerous reasons why a vehicle leaves the roadway, including driver error and behaviors. Regardless of the reason, a roadside design can reduce the seriousness of the error and the subsequent consequences of a roadside encroachment. From a crash reduction and severity perspective, the ideal highway has roadsides and median areas that are flat and unobstructed by objects. It is also recognized that different facilities have different needs and considerations, and these issues are considered in any final design.

It is not possible to provide a clear zone free of objects at all locations and under all circumstances. The engineer faces many tradeoffs in design decision-making, balancing needs of the environment, right of way, and different modes of transportation. The fact that recommended values for guardrail are presented in this chapter does not require the Department to modify all locations to meet the specified criteria; those locations are addressed as appropriate through the priority array.

Elements such as sideslopes, fixed objects, and water are features that a vehicle might encounter when it leaves the roadway. These features present varying degrees of deceleration to the vehicle and its occupants. Unfortunately, geography and economics do not always allow ideal highway conditions. The mitigative measures to be taken depend on the probability of a crash occurring, the likely severity, and the available resources.

In order of priority, the mitigative measures the Washington State Department of Transportation (WSDOT) uses are:

1. Removal
2. Relocation
3. Reduction of impact severity (using breakaway features or making it traversable) and
4. Shielding with a traffic barrier.

Factors for selecting a mitigative measure include, but may not be limited to:

- Cost (initial and life cycle costs)
- Maintenance needs
- Crash severity

Use traffic barriers when other measures cannot reasonably be accomplished and conditions are appropriate based on engineering analysis. (See [Chapter 1610](#) for additional information on traffic barriers.)

1600.02 References

1600.02(1) Federal/State Laws and Codes

[Revised Code of Washington \(RCW\) 47.24.020\(2\)](#), Jurisdiction, control

[RCW 47.32.130](#), Dangerous objects and structures as nuisances

1600.02(2) Design Guidance

Highway Safety Manual, AASHTO

Local Agency Guidelines (City and County Design Standards), M 36-63, WSDOT

Roadside Design Guide, AASHTO, 2011

Standard Plans for Road, Bridge, and Municipal Construction (Standard Plans), M 21-01, WSDOT

1600.02(3) Supporting Information

A Policy on Geometric Design of Highways and Streets (Green Book), AASHTO, 2011

Understanding Design Clear Zone – This e-learning course for WSDOT employees covers how to determine the appropriate Design Clear Zone for recoverable and nonrecoverable slopes as well as ditches. Request this training via the web-based Learning Management System.

Highways Over National Forest Lands, MOU, 2013, US Forest Service and WSDOT,
www.wsdot.wa.gov/publications/manuals/m22-50.htm

Utilities Manual, M 22-87, WSDOT. Chapter 9 provides guidance for utilities in the WSDOT right of way.

1600.03 Clear Zone

A clear roadside border area is a primary consideration when analyzing potential roadside and median features (as defined in [1600.04](#)). The intent is to provide as much clear, traversable area for a vehicle to recover as practicable given the function of the roadway and the potential tradeoffs. The Design Clear Zone is used to evaluate the adequacy of the existing clear area and proposed modifications of the roadside. When considering the placement of new objects along the roadside or median, evaluate the potential for impacts and try to select locations with the least likelihood of an impact by an errant vehicle.

In situations where the Design Clear Zone is beyond WSDOT right of way, evaluate options on a case-by-case basis. Consider the nature of the objects within the Design Clear Zone, the roadway geometry, traffic volume, and crash history. Coordinate with adjacent property owners when proposed options include any work beyond WSDOT right of way. At a minimum, provide clear zone to the limits of the WSDOT right of way.

1600.03(1) Design Clear Zone on Limited Access State Highways and Other State Highways Outside Incorporated Cities and Towns

Use the Design Clear Zone Inventory form ([Exhibit 1600-3](#)) to identify potential features to be mitigated and propose corrective actions.

Guidance for establishing the Design Clear Zone for highways outside incorporated cities is provided in [Exhibit 1600-2](#). This guidance also applies to limited access facilities within the city limit. Providing a clear recovery area that is consistent with this guidance does not require any additional documentation. However, there might be situations where it is not practicable to provide these recommended distances. In these situations, document the decision as a deviation as discussed in [Chapter 300](#).

For state highways that are in an urban environment, but outside an incorporated city, evaluate both median and roadside clear zones as discussed above using [Exhibit 1600-2](#). However, there is flexibility in establishing the Design Clear Zone in urbanized areas adjacent to incorporated cities and towns. To achieve this flexibility, an evaluation of the impacts, including safety, aesthetics, the environment, economics, modal needs, and access control, can be used to establish the Design Clear Zone. This discussion, analysis, and legal agreement development takes place early in the consideration of the median and roadside designs. A legal agreement on the responsibility for design, construction, operation, and maintenance for these median and roadside sections must be formalized with the city and/or county. Document the design decision for the selected Design Clear Zone as part of the design approval (see [Chapter 300](#)).

Because AASHTO's *A Policy on Geometric Design of Highways and Streets* had addressed the concept of operational offset within the discussion of clear zone, some practitioners misinterpreted this offset as providing an adequate clear zone. The 18-inch operational offset beyond the face of curb is a lateral clearance for opening car doors or for truck mirrors.

1600.03(2) Design Clear Zone Inside Incorporated Cities and Towns

For managed access state highways within an urban area, it might not be practicable to provide the Design Clear Zone distances shown in [Exhibit 1600-2](#). Roadways within an urban area generally have curbs and sidewalks and might have objects such as trees, poles, benches, trash cans, landscaping, and transit shelters along the roadside.

For projects on city streets as state highways that include work in those areas that are the City's responsibility and jurisdiction (see [Exhibit 1600-1](#)), design the project using the city's Development/Design Standards. The standards adopted by the city must meet the requirements set by the Design Standards Committee for all projects on arterials, bike projects, and all federal-aid projects.

Exhibit 1600-1 City and State Responsibilities and Jurisdictions

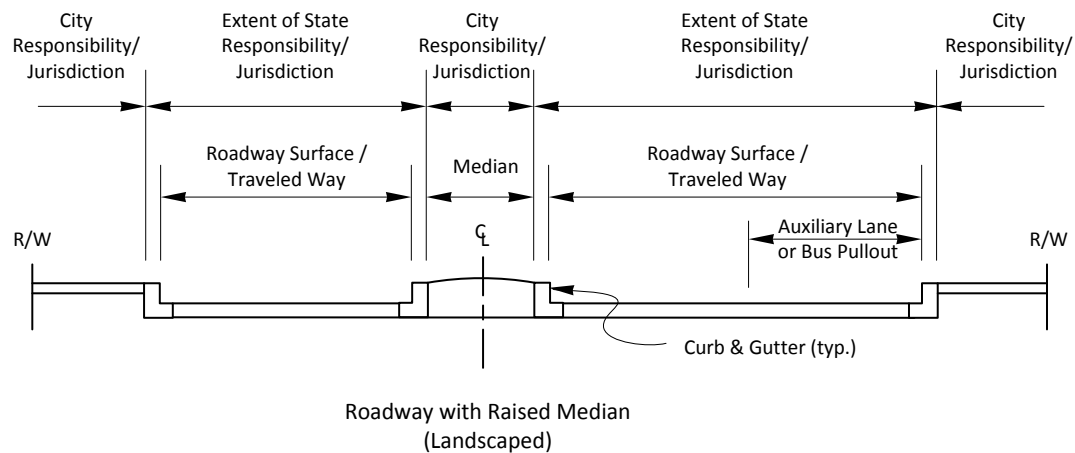

1600.03(2)(a) Roadside and Median

For managed access state highways inside incorporated cities, it is the city's responsibility to establish an appropriate Design Clear Zone in accordance with guidance contained in the City and County Design Standards (*Local Agency Guidelines*, Chapter 42.) [Exhibit 1600-1](#) shows an example of state and city responsibilities and jurisdictions. Document the Design Clear Zone established by the city in the Design Documentation Package. Have the responsible transportation official from the City (e.g., City Engineer) document the Design Clear Zone, and their acknowledgement and acceptance of the design and maintenance responsibilities for project roadsides and medians, in a letter addressed to WSDOT, and file this letter as part of the local agency coordination in the Design Documentation Package. Respond to the sender by letter acknowledging receipt. Sample templates for these letters will be made available online at the Design Support website under the Design Documentation section.

1600.03(3) Design Clear Zone and Calculations

The Design Clear Zone guidance provided in [Exhibit 1600-2](#) is a function of the posted speed, sideslope, and traffic volume. There are no distances in the table for 3H:1V fill slopes. Although fill slopes between 4H:1V and 3H:1V are considered traversable if free of fixed objects, these slopes are defined as nonrecoverable slopes. A vehicle might be able to begin recovery on the shoulder, but likely will not be able to further this recovery until reaching a flatter area (4H:1V or flatter) at the toe of the slope. Under these conditions, the Design Clear Zone distance is called a recovery area. The method used to calculate the recovery area and an example are shown in [Exhibit 1600-4](#).

For ditch sections, the following criteria determine the Design Clear Zone:

- (a) For ditch sections with foreslopes 4H:1V or flatter (see [Exhibit 1600-5](#), Case 1, for an example), the Design Clear Zone distance is the greater of the following:
- The Design Clear Zone distance for a 10H:1V cut section based on speed and the average daily traffic (ADT).
 - A horizontal distance of 5 feet beyond the beginning of the backslope.

When a backslope steeper than 3H:1V continues for a horizontal distance of 5 feet beyond the beginning of the backslope, it is not necessary to use the 10H:1V cut slope criteria.

- (b) For ditch sections with foreslopes steeper than 4H:1V and backslopes steeper than 3H:1V, the Design Clear Zone distance is 10 feet horizontal beyond the beginning of the backslope (see [Exhibit 1600-5](#), Case 2, for an example).
- (c) For ditch sections with foreslopes steeper than 4H:1V and backslopes 3H:1V or flatter, the Design Clear Zone distance is the distance established using the recovery area formula (see [Exhibit 1600-4](#); also see [Exhibit 1600-5](#), Case 3, for an example).

1600.04 Mitigation Guidance

There are three general categories of features to be mitigated: sideslopes, fixed objects, and water. This section provides guidance for determining when these objects present a significant risk to an errant motorist. For each case, the following conditions need added consideration:

- Locations with high expected crash frequency.
- Locations with pedestrian and bicycle usage. (See Chapters [1510](#), [Pedestrian Facilities](#), [1515](#), [Shared-Use Paths](#), and [1520](#), [Roadway Bicycle Facilities](#).)
- Playgrounds, monuments, and other locations with high social or economic value.
- Redirectional land forms, also referred to as earth berms, were installed to mitigate objects located in depressed medians and at roadsides. They were constructed of materials that provided support for a traversing vehicle. With slopes in the range of 2H:1V to 3H:1V, they were intended to redirect errant vehicles. The use of redirectional land forms has been discontinued as a means for mitigating fixed objects. Where redirectional land forms currently exist as mitigation for a fixed object, provide designs where the feature they were intended to mitigate is removed, relocated, made crashworthy, or shielded with barrier. Landforms may be used to provide a smooth surface at the base of a rock cut slope.

The use of a traffic barrier for features other than those described below requires justification.

1600.04(1) Side Slopes

1600.04(1)(a) Fill Slopes

Fill slopes can present a risk to an errant vehicle with the degree of severity dependent upon the slope and height of the fill. Providing fill slopes that are 4H:1V or flatter can mitigate this condition. If flattening the slope is not feasible or cost-effective, the installation of a barrier might be appropriate. [Exhibit 1600-6](#) represents a selection procedure used to determine whether a fill sideslope constitutes a condition for which a barrier is a cost-effective mitigation. The curves are based on the severity indexes and represent the points where total costs associated with a traffic barrier are equal to the predicted cost of crashes over the service life for selected slope heights without traffic barrier. If the ADT and height of fill intersect on the “Barrier Recommended” side of the embankment slope curve, then provide a barrier if flattening the slope is not feasible or cost-effective.

Do not use [Exhibit 1600-6](#) for slope design. Design slopes consistent with guidance in [Chapter 1230](#), evaluating designs with clear, traversable slopes before pursuing a barrier option. Also, if [Exhibit 1600-6](#) indicates that barrier is not recommended at an existing slope, that result is not justification for a deviation. For example, if the ADT is 4,000 and the embankment height is 10 feet, barrier might be cost-effective for a 2H:1V slope, but not for a 2.5H:1V slope. This process only addresses the potential risk of exposure to the slope. Obstacles on the slope can compound

the condition. Where barrier is not cost-effective, use the recovery area formula to evaluate fixed objects on critical fill slopes less than 10 feet high.

1600.04(1)(b) Cut Slopes

A cut slope is usually less of a risk than a traffic barrier. The exception is a rock cut with a rough face that might cause vehicle snagging rather than providing relatively smooth redirection.

Analyze the potential motorist risk and the benefits of treatment of rough rock cuts located within the Design Clear Zone. Conduct an individual investigation for each rock cut or group of rock cuts. A cost-effectiveness analysis that considers the consequences of doing nothing, removal, smoothing of the cut slope, and other viable options to reduce the severity of the condition can be used to determine the appropriate treatment. Some potential options are:

- Graded landform along the base of a rock cut.
- Flexible barrier
- More rigid barrier
- Rumble strips

1600.04(2) Fixed Objects

Use engineering judgment when considering the following objects for mitigation:

- Wooden poles or posts with cross-sectional areas greater than 16 square inches that do not have breakaway features.
- Signs, illumination, cameras, weather stations, and other items mounted on nonbreakaway poles, cantilevers, or bridges.
- Trees with a diameter of 4 inches or more, measured at 6 inches above the ground surface.
- Fixed objects extending above the ground surface by more than 4 inches; for example, boulders, concrete bridge rails, signal/electrical/ITS cabinets, piers, and retaining walls.
- Drainage items such as culvert and pipe ends.

Mitigate fixed features that exist within the Design Clear Zone when practicable. Although limited in application, there may be situations where removal of an object outside the right of way is appropriate. The possible mitigative measures are listed as follows in order of preference:

- Remove
- Relocate
- Reduce impact severity (using a breakaway feature)
- Shield the object by using longitudinal barrier or impact attenuator

1600.04(2)(a) Trees

When evaluating new plantings or existing trees, consider the maximum allowable diameter of 4 inches, measured at 6 inches above the ground when the tree has matured. When removing trees within the Design Clear Zone, complete removal of stumps is preferred. However, to avoid significant disturbance of the roadside vegetation, larger stumps may be mitigated by grinding or cutting them flush to the ground and grading around them.

Removal of trees may be beneficial to reduce the impacts of driving errors, which result in angle crashes and roadside and clear zone encroachments. It is recognized that different facilities have

different needs and considerations, and these issues are considered in any final design. For instance, removal of trees within the Design Clear Zone may not be desirable in contexts such as within a forest, park, or within a scenic and recreational highway. In these corridors, analyze crash reports' contributing factors to determine whether roadside vegetation is contributing to crashes. If large vegetation is removed, replace with shrubs or groundcover or consult guidance contained in established vegetation management plans or corridor plans. Additional guidance for maintenance of roadside vegetation can be found in the Memorandum of Understanding between the US Forest Service and WSDOT, *Highways Over National Forest Lands*, dated July 2002.

1600.04(2)(b) Mailboxes

For mailboxes located within the Design Clear Zone, provide supports and connections as shown in the *Standard Plans*. The height from the ground to the bottom of the mailbox is 3 feet 3 inches. This height may vary from 3 feet 3 inches to 4 feet if requested by the mail carrier. If the desired height is to be different from 3 feet 3 inches, provide the specified height in the contract plans. (See [Exhibit 1600-7](#) for installation guidelines.) Coordinate with homeowners when upgrading mailboxes.

In urban areas where sidewalks are prevalent, contact the postal service to determine the most appropriate mailbox location. Locate mailboxes on limited access highways in accordance with [Chapter 530](#), Limited Access. A turnout, as shown in [Exhibit 1600-7](#), is not needed on limited access highways with shoulders of 6 feet or more where only one mailbox is to be installed. On managed access highways, mailboxes are to be on the right-hand side of the road in the postal carrier's direction of travel. Avoid placing mailboxes along high-speed, high-volume highways. Locate Neighborhood Delivery and Collection Box Units outside the Design Clear Zone.

1600.04(2)(c) Culvert Ends

Provide a traversable end treatment when the culvert end section or opening is on the roadway sideslope and within the Design Clear Zone. This can be accomplished for small culverts by beveling the end to match the sideslope, with a maximum of 4 inches extending out of the sideslope.

Bars might be needed to provide a traversable opening for larger culverts. Place bars in the plane of the culvert opening in accordance with the *Standard Plans* when:

- Single cross-culvert opening exceeds 40 inches, measured parallel to the direction of travel.
- Multiple cross-culvert openings that exceed 30 inches each, measured parallel to the direction of travel.
- Culvert approximately parallel to the roadway that has an opening exceeding 24 inches, measured perpendicular to the direction of travel.

Bars are permitted where they will not significantly affect the stream hydraulics and where debris drift is minor. Consult the region Maintenance Office to verify these conditions. If debris drift is a concern, consider options to reduce the amount of debris that can enter the pipe (see the *Hydraulics Manual*). Other treatments are extending the culvert to move the end outside the Design Clear Zone or installing a traffic barrier.

1600.04(2)(d) Signposts

Whenever possible, locate signs behind existing or planned traffic barrier installations to eliminate the need for breakaway posts. Place them at least 25 feet from the end of the barrier terminal and with the sign face behind the barrier. When barrier is not present, use terrain features to reduce the likelihood of an errant vehicle striking the signposts. Whenever possible, minor adjustments to the sign location may be made to take advantage of barrier or terrain features. (See [Chapter 1020](#) for additional information regarding the placement of signs.) Use the [MUTCD](#) to guide placement of the warning sign.

Signposts with cross-sectional areas greater than 16 square inches that are within the Design Clear Zone and not located behind a barrier are to have breakaway features as shown in the [Standard Plans](#).

Sign bridges and cantilever sign supports are designed for placement outside the Design Clear Zone or shielded by barrier.

1600.04(2)(e) Traffic Signal Standards/Posts/Supports

Breakaway signal posts generally are not feasible or desirable. Since these supports are generally located at intersecting roadways, there is a higher potential for a falling support to impact vehicles and/or pedestrians. In addition, signal supports that have overhead masts may be too heavy for a breakaway design to work properly. Other mitigation, such as installing a traffic barrier, is also very difficult. With vehicles approaching the support from many different angles, a barrier would have to surround the support and would be subject to impacts at high angles. Additionally, barrier can inhibit pedestrian movements. Therefore, barrier is generally not an option. However, since speeds near signals are generally lower, the potential for a severe impact is reduced. For these reasons, locate the support as far from the traveled way as possible.

In locations where signals are used for ramp meters, the supports can be made breakaway as shown in the [Standard Plans](#).

1600.04(2)(f) Fire Hydrants

Fire hydrants are allowed on WSDOT right of way by franchise or permit. Fire hydrants that are made of cast iron can be expected to fracture on impact and can therefore be considered a breakaway device. Any portion of the hydrant that will not be breakaway must not extend more than 4 inches above the ground. In addition, the hydrant must have a stem that will shut off water flow in the event of an impact. Mitigate other hydrant types.

1600.04(2)(g) Utility Poles

Since utilities often share the right of way, utility objects such as poles are often located along the roadside. It is undesirable/infeasible to install barrier for all of these objects, so mitigation is usually in the form of relocation (underground or to the edge of the right of way) or delineation. In some instances where there is a history of impacts with poles and relocation is not possible, a breakaway design might be appropriate. Evaluate roadway geometry and crash history as an aid in determining locations that exhibit the greatest need.

Contact the Headquarters (HQ) Design Office for information on breakaway features. Coordinate with the HQ Utilities Unit when appropriate.

Document coordination with the region Utilities Office for evaluations and mitigative measures. For additional guidance, see Chapter 9 of the [Utilities Manual](#).

1600.04(2)(h) Light Standards

Provide breakaway light standards unless fixed light standards can be justified. Fixed light standards may be appropriate in areas of extensive pedestrian concentrations, such as adjacent to bus shelters. Document the decision to use fixed bases in the Design Documentation Package.

1600.04(3) Water

Water with a depth of 2 feet or more and located with a likelihood of encroachment by an errant vehicle is to be considered for mitigation on a project-by-project basis. Consider the length of time traffic is exposed to this feature.

Analyze the potential risk to motorists and the benefits of treating bodies of water located within the Design Clear Zone. A cost-effectiveness analysis that considers the consequences of doing nothing versus installing a longitudinal barrier can be used to determine the appropriate treatment.

For fencing considerations along water features, see [Chapter 560](#).

1600.05 Medians

Medians are to be analyzed for the potential of an errant vehicle to cross the median and encounter oncoming traffic. Median barriers are normally used on limited access, multilane, high-speed, high-volume highways. These highways generally have posted speeds of 45 mph or higher. Median barrier is not normally placed on collectors or other state highways that do not have limited access control. Providing access through median barrier results in openings; therefore, end treatments are needed.

Provide median barrier on full access control multilane highways with median widths of 50 feet or less and posted speeds of 45 mph or higher. Consider median barrier on highways with wider medians or lower posted speeds when there is a history of cross-median crashes.

When installing a median barrier, provide left-side shoulder widths ([see Chapter 1230](#)) and shy distance ([see Chapter 1610](#).) Consider a wider shoulder area where the barrier might cast a shadow on the roadway and hinder the melting of ice. (See [Chapter 1230](#) for additional criteria for placement of median barrier, [Chapter 1610](#) for information on the types of barriers that can be used, and [Chapter 1260](#) for lateral clearance on the inside of a curve to provide the needed stopping sight distance.) Consideration of drainage is an important factor when designing median barrier treatments.

When median barrier is being placed in an existing median, identify the existing crossovers and enforcement observation points. Provide the needed median crossovers in accordance with [Chapter 1370](#), considering enforcement needs. [Chapter 1410](#) provides guidance on HOV enforcement.

1600.06 Other Roadside Safety Features

1600.06(1) Rumble Strips

Rumble strips are grooves or rows of raised pavement markers placed perpendicular to the direction of travel to alert inattentive drivers. There are three kinds of rumble strips: roadway, shoulder, and centerline.

In Washington, most rumble strips consist of grooves milled into the pavement surface. Although most installations have not adversely affected the pavement, there have been a few instances where milled rumble strips have been associated with advanced levels of pavement deterioration, resulting in continuous ruts or large areas of pavement delamination. Poor pavement performance has most commonly been associated with rumble strip installations in bituminous surface treatment (BST) pavement and hot mix asphalt (HMA) pavement with low density, particularly along longitudinal joints. Rumble strip installation should be avoided in open-graded pavements. Consult with the Region Materials Engineer to determine installation procedure and verify that the pavement structure is adequate. When installing both rumble strips and recessed lane markers, follow the Standard Plan to avoid overlapping the grindings. Installing rumble strips in bituminous surface treatment (or BST) or other thin surface treatments can expose pavement structure and lead to delamination.

The best practice is to install the rumble strips immediately prior to placing the surface treatment in order to seal the installation. In all cases, avoid placing HMA pavement joints and centerline rumble strips along the same (coincident) line wherever practical (see [Standard Plan M-65.10-02](#)). Where rumble strips currently exist and an additional BST application is contemplated, evaluate whether the depth of the grooves following paving will support their continuing function to alert drivers. If not, or in the case of an HMA overlay, it may be necessary to remove existing rumble strips and install new ones. Note: WSDOT experience has shown that BST can be placed over existing rumble strips at least once and still be effective.

For additional guidance on surface preparation and pavement stability, refer to the [WSDOT Pavement Policy \(June 2011\)](#).

1600.06(1)(a) Roadway Rumble Strips

Roadway rumble strips are placed transversely to the traveled way to alert drivers who are approaching a change of roadway condition or object that requires substantial speed reduction or other maneuvering. Some locations where roadway rumble strips may be used are in advance of:

- Stop-controlled intersections.
- Port of entry/customs stations.
- Lane reductions where crash history shows a pattern of driver inattention.
- Horizontal alignment changes where crash history shows a pattern of driver inattention.

They may also be placed at locations where the character of the roadway changes, such as at the end of a freeway.

Contact the HQ Design Office for additional guidance on the design and placement of roadway rumble strips.

Document decisions to use roadway rumble strips in the Design Documentation Package.

1600.06(1)(b) Shoulder Rumble Strips

Shoulder rumble strips (SRS) are placed parallel to the traveled way just beyond the edge line to warn drivers they are entering a part of the roadway not intended for routine traffic use. Shoulder rumble strips are effective in reducing run-off-the-road crashes when the contributing circumstances are human factors related, such as inattention, apparently fatigued, or apparently asleep.

When shoulder rumble strips are used, discontinue them where no edge stripe is present, such as at intersections and where curb and gutter are present. Discontinue shoulder rumble strips where shoulder driving is allowed. Where bicycle travel is allowed, discontinue shoulder rumble strips at locations where shoulder width reductions can cause bicyclists to move into or across the area where rumble strips would normally be placed, such as shoulders adjacent to bridges or longitudinal barrier with reduced shoulder widths.

Shoulder rumble strip patterns vary depending on the likelihood of bicyclists being present along the highway shoulder and whether they are placed on divided or undivided highways. Rumble strip patterns for undivided highways are shallower and may be narrower than patterns used on divided highways. They also provide gaps in the pattern, providing opportunities for bicycles to move across the pattern without having to ride across the grooves. There are four shoulder rumble strip patterns. Consult the [Standard Plans](#) for the patterns and construction details.

1. Divided Highways

Install shoulder rumble strips on both the right and left shoulders of rural Interstate highways. Consider them on both shoulders of rural divided highways. Use the Shoulder Rumble Strip Type 1 pattern on divided highways.

Shoulder rumble strips on rural Interstate highways may be omitted under any of the following conditions:

- When another project scheduled within two years of the proposed project will overlay or reconstruct the shoulders or will use the shoulders for detours.
- When a pavement analysis determines that installing shoulder rumble strips will result in inadequate shoulder strength.
- When overall shoulder width will be less than 4 feet wide on the left and 6 feet wide on the right.

Document the decision to omit rumble strips in a design analysis (see [Chapter 300.](#))

2. Undivided Highways

Shoulder rumble strip usage on the shoulders of undivided highways demands strategic application because bicycle usage is more prevalent along the shoulders of the undivided highway system. Rumble strips affect the comfort and control of bicycle riders; consequently, their use is to be limited to highway corridors that experience high levels of run-off-the-road crashes. Apply the following criteria in evaluating the appropriateness of rumble strips on the shoulders of undivided highways.

- Consult the region and Headquarters Bicycle and Pedestrian Coordinators to determine bicycle usage along a route, and involve them in the decision-making process when considering rumble strips along bike touring routes or other routes where bicycle events are regularly held.
- Use on rural roads only.
- Determine that shoulder pavement is structurally adequate to support milled rumble strips.
- Posted speed is 45 mph or higher.
- Provide for at least 4 feet of usable shoulder between the rumble strip and the outside edge of shoulder. If guardrail or barrier is present, increase the dimension to 5 feet of usable shoulder. Field-verify these dimensions.
- Preliminary evaluation indicates a run-off-the-road crash experience of approximately 0.6 crashes per mile per year. (This value is intended to provide relative comparison of crash experience and is not to be used as absolute guidance on whether rumble strips are appropriate.)
- Do not place shoulder rumble strips on downhill grades exceeding 4% for more than 500 feet in length along routes where bicyclists are frequently present.
- An engineering analysis indicates a run-off-the-road crash experience considered correctable by shoulder rumble strips.

For projects that will remove and potentially replace existing shoulder rumble strips, evaluate the criteria for shoulder width and downhill grades for compliance with placement guidance. Discontinue rumble strips where the downhill grade exceeds 4% for more than 500 feet. If the usable shoulder width between the rumble strip and outer edge of shoulder is less than 4 feet (5 feet if guardrail or barrier is present) reevaluate the appropriateness of the rumble strips. Assess the existing shoulder rumble strip's impact on run-off-the-road crash experience and bicycling. Assess alternate rumble strip patterns and placement options. Consult the region and Headquarters Bicycle and Pedestrian Coordinators. Document decisions to continue or discontinue shoulder rumble strip usage where the existing usable shoulder width between the rumble strip and outer edge of shoulder is less than 4 feet (5 feet if guardrail or barrier is present).

Consult with the region or Headquarters Bicycle and Pedestrian Coordinator for determining levels of bicycle traffic for your project. The Shoulder Rumble Strip Type 2 or Type 3 pattern is used on highways with minimal bicycle traffic. When bicycle traffic on the shoulder is determined to be high, the Shoulder Rumble Strip Type 4 pattern is used.

Shoulder rumble strip installation considered at any other locations must involve the region and Headquarters Bicycle and Pedestrian Coordinators as a partner in the decision-making process.

Consult the following website for guidance on conducting an engineering analysis:

 <http://www.wsdot.wa.gov/Design/Policy/RoadsideSafety.htm>

1600.06(1)(c) Centerline Rumble Strips

Centerline rumble strips are placed on the centerline of undivided highways to alert drivers that they are entering the opposing lane. They are applied as a countermeasure for crossover crashes. Centerline rumble strips are installed with no differentiation between passing permitted and no passing areas. Refresh pavement markings when removed by centerline rumble strips.

A March 2011 WSDOT study found that centerline rumble strips were highly effective across the state highway network, and most effective on roadways where: the AADT is less than 8,000, the combined paved lane and shoulder width is 12 to 17 feet, and the posted speed is 45 to 55 mph.

Centerline rumble strips are evaluated using a programmatic approach, starting with a preliminary review of each rural undivided highway as a potential installation site. The HQ Design Office conducts the preliminary review, evaluating cross-centerline crash history and pavement width. A list of sites is generated from this review and periodically updated and distributed to the regions for a more detailed analysis of each site. The presence of a particular site on the preliminary list does not imply that rumble strips must be installed.

The preliminary review conducted in the Design Office does not assess pavement structure; traffic volume and composition; type and volume of nonmotorized users; or proximity to roadside residents. Region project development staff are expected to evaluate these items, and to field-verify roadway widths and appropriate project limits. The final determination about the appropriateness of centerline rumble strips is the responsibility of region project development staff. Although these decisions are made in the region, it is important that they be evaluated in a consistent manner from region to region. Evaluate the following criteria in determining the appropriateness of centerline rumble strips.

1. Crash Experience

WSDOT has evaluated the effectiveness of centerline rumble strips on roadways with various lane and shoulder widths. For roadways with a combined lane and shoulder width of 15 feet or more, the benefits are substantial. These highways exhibited a 50% reduction in fatal and serious injury crashes, when looking at both cross-centerline and run-off-the-road-right (ROTRR) crashes. For roadways with 12 to 14 feet of combined lane and shoulder width, the benefits are more closely aligned with reductions in cross-centerline crashes. There are mixed results with ROTRR crashes on 12- to 14-foot-wide roadways, although when combined with the cross-centerline crashes, the net result indicates an overall 25% reduction in fatal and serious injury crashes. Further evaluation of apparent run-off-the-road vehicles that cross the centerline and end on the opposing roadside may be of value.

Review the crash history to determine the frequency of crashes with human factors contributing circumstances such as inattention, apparently fatigued, apparently asleep, over the centerline, or on the wrong side of the road. These types of cross-centerline crashes are considered to be correctable with centerline rumble strips.

2. Highway Type

Centerline rumble strips are most appropriate on rural roads, but with special consideration, may also be appropriate for urban roads. Some concerns specific to urban areas are more residents impacted by noise in more densely populated areas, the frequent need to interrupt the rumble strip pattern to accommodate left-turning vehicles, and a reduced effectiveness at

lower speeds (35 mph and below). Centerline rumble strips are not appropriate where two way left-turn lanes exist.

3. Roadway Width

A 2004 study of the effects of centerline rumble strips on lateral placement and speed of vehicles determined that drivers tend to shift their lane position 3 to 5½ inches to the right to avoid driving on centerline rumble strips. This results in the vehicle driving closer to the pavement edge and to bicyclists who may be traveling on the outer edges of the lane. Centerline rumble strips are inappropriate when the combined lane and shoulder widths in either direction are less than 12 feet. (See [Chapter 1230](#) for guidance on lane and shoulder widths.)

The narrower roadways within this range warrant additional consideration. Where the combined lane and shoulder width is 14 feet or less, consider the level of bicycle and pedestrian use along the route. When drivers shift their lane position away from centerline to avoid the rumble strips, they are moving closer to pedestrians and bicyclists on the shoulder. Also consider the roadside characteristics and the potential for a lane position adjustment to result in a run-off-the-road event, evaluating clear zone width along the route. Balance these issues with the frequency and severity of cross-centerline crashes.

4. Traffic Volume

Higher-volume routes equate to greater exposure, with more opportunities for: cross-centerline crashes, conflicts with nonmotorized users on the shoulder, and incidental contact with the rumble strips. The March 2011 WSDOT centerline rumble strip study noted that lower-volume routes had higher rates of cross-centerline crashes.

5. Noise for Roadside Residents

Most rumble strip noise complaints result from incidental contact where the vehicle might not have been heading toward a crash. Left-turning or passing vehicles, along with the off-tracking of large trucks or trailers may result in incidental contact with centerline rumble strips. With some specific attention to details, some of these contacts can be significantly reduced by discontinuing the rumble strip installations through intersections or frequently used road approaches. For roadways with limited passing opportunities, evaluate the frequency and position of neighboring residents and site-specific crash experience to determine if the rumble strip should be discontinued in a potential passing location. Attention to horizontal curvature, curve widening, and large-vehicle usage may help identify locations where the rumble strips may need to be discontinued through a tight radius curve.

1600.06(2) Headlight Glare Considerations

Headlight glare from opposing traffic can cause potential safety problems. This can include glare from frontage roads. Glare can be reduced by the use of wide medians, separate alignments, earth mounds, plants, concrete barrier, and glare screens. Glare screen fencing may be effective for frontage roads. Consider long-term maintenance when selecting the treatment for glare. When considering glare screens, see [Chapter 1260](#) for lateral clearance on the inside of a curve to provide the necessary stopping sight distance. In addition to reducing glare, taller concrete barriers also provide improved crash performance for larger vehicles such as trucks.

Glare screen is relatively expensive, and its use is to be justified. It is difficult to justify the use of glare screen where the median width exceeds 20 feet, the ADT is less than 20,000 vehicles per

day, or the roadway has continuous lighting. Consider the following factors when assessing the need for glare screen:

- Higher frequency of night crashes compared to similar locations or statewide experience.
- Higher than normal ratio of night-to-day crashes.
- Unusual distribution or concentration of nighttime crashes.
- Over-representation of older drivers in night crashes.
- Combination of horizontal and vertical alignment, particularly where the roadway on the inside of a curve is higher than the roadway on the outside of the curve.
- Direct observation of glare.
- Public complaints concerning glare.

The most common area with the potential for glare is between opposing main line traffic. Other conditions for which glare screen might be appropriate are:

- Between a highway and an adjacent frontage road or parallel highway, especially where opposing headlights might seem to be on the wrong side of the driver.
- At an interchange where an on-ramp merges with a collector-distributor and the ramp traffic might be unable to distinguish between collector and main line traffic. In this instance, consider other solutions such as illumination.
- Where headlight glare is a distraction to adjacent property owners. Playgrounds, ball fields, and parks with frequent nighttime activities might benefit from screening if headlight glare interferes with these activities.

There are currently three basic types of glare screen available: chain link (see the [Standard Plans](#)), vertical blades, and concrete barrier (see [Exhibit 1600-8](#)).

When the glare is temporary (due to construction activity), consider traffic volumes, alignment, duration, presence of illumination, and type of construction activity. Glare screen may be used to reduce rubbernecking associated with construction activity, but less expensive methods, such as plywood that seals off the view of the construction area, might be more appropriate.

1600.07 Documentation

Refer to [Chapter 300](#) for design documentation requirements.

Exhibit 1600-2 Design Clear Zone Distance Table

Posted Speed (mph)	Average Daily Traffic	Cut Section (Backslope) (H:V)						Fill Section (H:V)					
		3:1	4:1	5:1	6:1	8:1	10:1	3:1	4:1	5:1	6:1	8:1	10:1
35 or Less		The Design Clear Zone Distance is 10 ft											
40	Under 250	10	10	10	10	10	10	*	13	12	11	11	10
	251 – 800	11	11	11	11	11	11	*	14	14	13	12	11
	801 – 2,000	12	12	12	12	12	12	*	16	15	14	13	12
	2,001 – 6,000	14	14	14	14	14	14	*	17	17	16	15	14
	Over 6,000	15	15	15	15	15	15	*	19	18	17	16	15
45	Under 250	11	11	11	11	11	11	*	16	14	13	12	11
	251 – 800	12	12	13	13	13	13	*	18	16	14	14	13
	801 – 2,000	13	13	14	14	14	14	*	20	17	16	15	14
	2,001 – 6,000	15	15	16	16	16	16	*	22	19	17	17	16
	Over 6,000	16	16	17	17	17	17	*	24	21	19	18	17
50	Under 250	11	12	13	13	13	13	*	19	16	15	13	13
	251 – 800	13	14	14	15	15	15	*	22	18	17	15	15
	801 – 2,000	14	15	16	17	17	17	*	24	20	18	17	17
	2,001 – 6,000	16	17	17	18	18	18	*	27	22	20	18	18
	Over 6,000	17	18	19	20	20	20	*	29	24	22	20	20
55	Under 250	12	14	15	16	16	17	*	25	21	19	17	17
	251 – 800	14	16	17	18	18	19	*	28	23	21	20	19
	801 – 2,000	15	17	19	20	20	21	*	31	26	23	22	21
	2,001 – 6,000	17	19	21	22	22	23	*	34	29	26	24	23
	Over 6,000	18	21	23	24	24	25	*	37	31	28	26	25
60	Under 250	13	16	17	18	19	19	*	30	25	23	21	20
	251 – 800	15	18	20	20	21	22	*	34	28	26	23	23
	801 – 2,000	17	20	22	22	23	24	*	37	31	28	26	25
	2,001 – 6,000	18	22	24	25	26	27	*	41	34	31	29	28
	Over 6,000	20	24	26	27	28	29	*	45	37	34	31	30
65	Under 250	15	18	19	20	21	21	*	33	27	25	23	22
	251 – 800	17	20	22	22	24	24	*	38	31	29	26	25
	801 – 2,000	19	22	24	25	26	27	*	41	34	31	29	28
	2,001 – 6,000	20	25	27	27	29	30	*	46	37	35	32	31
	Over 6,000	22	27	29	30	31	32	*	50	41	38	34	33
70	Under 250	16	19	21	21	23	23	*	36	29	27	25	24
	251 – 800	18	22	23	24	26	26	*	41	33	31	28	27
	801 – 2,000	20	24	26	27	28	29	*	45	37	34	31	30
	2,001 – 6,000	22	27	29	29	31	32	*	50	40	38	34	33
	Over 6,000	24	29	31	32	34	35	*	54	44	41	37	36

Notes:

This exhibit applies to:

- All state highways outside incorporated cities.
- Limited access state highways within cities.

For Roadside and Median areas on managed access state highways within incorporated cities, see [1600.03](#) for guidance. Curb is not considered adequate to redirect an errant vehicle.

Design Clear Zone distances are given in feet, measured from the edge of traveled way.

*When the fill section slope is steeper than 4H:1V, but not steeper than 3H:1V, the Design Clear Zone distance is modified by the recovery area formula (see [Exhibit 1600-4](#)) and is referred to as the recovery area. The basic philosophy behind the recovery area formula is that the vehicle can traverse these slopes but cannot recover (control steering); therefore, the horizontal distance of these slopes is added to the Design Clear Zone distance to form the recovery area.

Exhibit 1600-4 Recovery Area

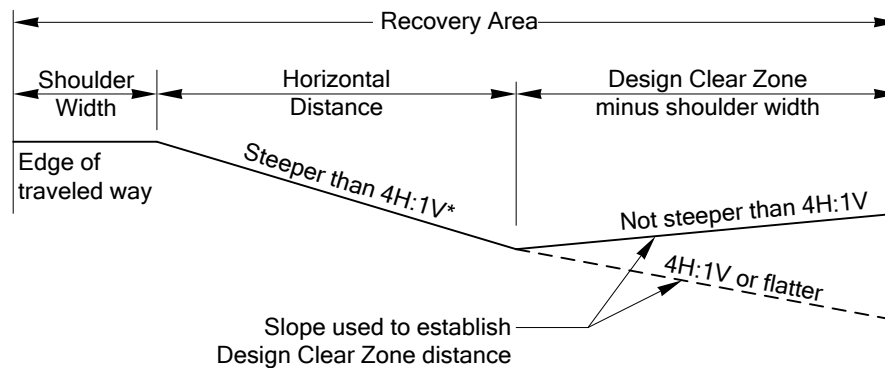

*Recovery area normally applies to slopes steeper than 4H:1V, but not steeper than 3H:1V. For steeper slopes, the recovery area formula may be used as a guide if the embankment height is 10 ft or less.

Formula:

$$\text{Recovery area} = (\text{shoulder width}) + (\text{horizontal distance}) \\ + (\text{Design Clear Zone distance} - \text{shoulder width})$$

Example:

Fill section (slope 3H:1V or steeper)

Conditions: Speed – 45 mph
Traffic – 3,000 ADT
Slope – 3H:1V

Criteria: Slope 3H:1V – Use recovery area formula

$$\text{Recovery area} = (\text{shoulder width}) + (\text{horizontal distance}) \\ + (\text{Design Clear Zone distance} - \text{shoulder width}) \\ = 8 + 12 + (17-8) \\ = 29 \text{ feet}$$

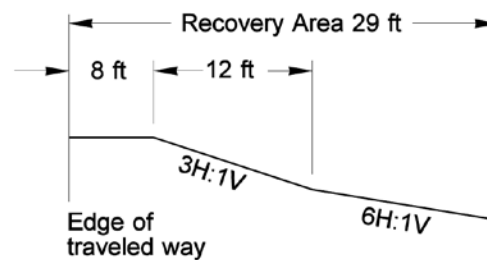

Exhibit 1600-5 Design Clear Zone for Ditch Sections

Cut section with ditch (foreslope 4H:1V or flatter)

Conditions: Speed – 55 mph
 Traffic – 4,200 ADT
 Slope – 4H:1V

Criteria: Greater of:

- (1) Design Clear Zone for 10H:1V cut section, 23 feet
- (2) 5 feet horizontal beyond beginning of backslope, 22 feet

Design Clear Zone = 23 feet

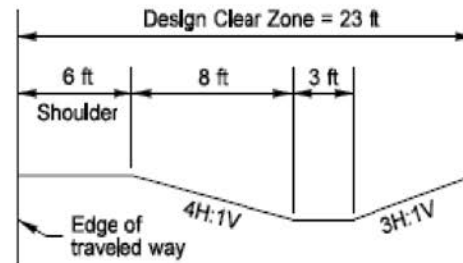

Case 1

Cut section with ditch (foreslope steeper than 4H:1V and backslope steeper than 3H:1V)

Conditions: NA

Criteria: 10 feet horizontal beyond beginning of backslope

Design Clear Zone = 19 feet

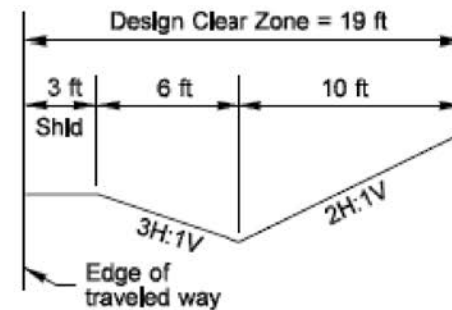

Case 2

Cut section with ditch (foreslope 3H:1V or steeper and backslope not steeper than 3H:1V)

Conditions: Speed – 45 mph
 Traffic – 3,000 ADT
 Foreslope – 2H:1V
 Backslope – 4H:1V

Criteria: Use recovery area formula

$$\begin{aligned}
 \text{Recovery Area} &= (\text{shoulder width}) + (\text{horizontal distance}) \\
 &\quad + (\text{Design Clear Zone distance} \\
 &\quad - \text{shoulder width}) \\
 &= 6 + 6 + (15 - 6) \\
 &= 21 \text{ feet}
 \end{aligned}$$

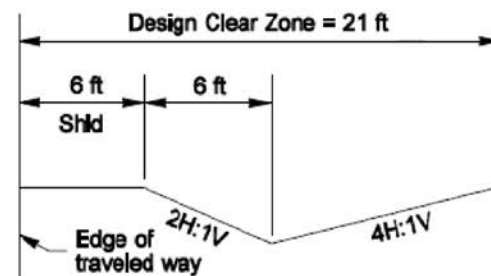

Case 3

Exhibit 1600-6 Guidelines for Embankment Barrier

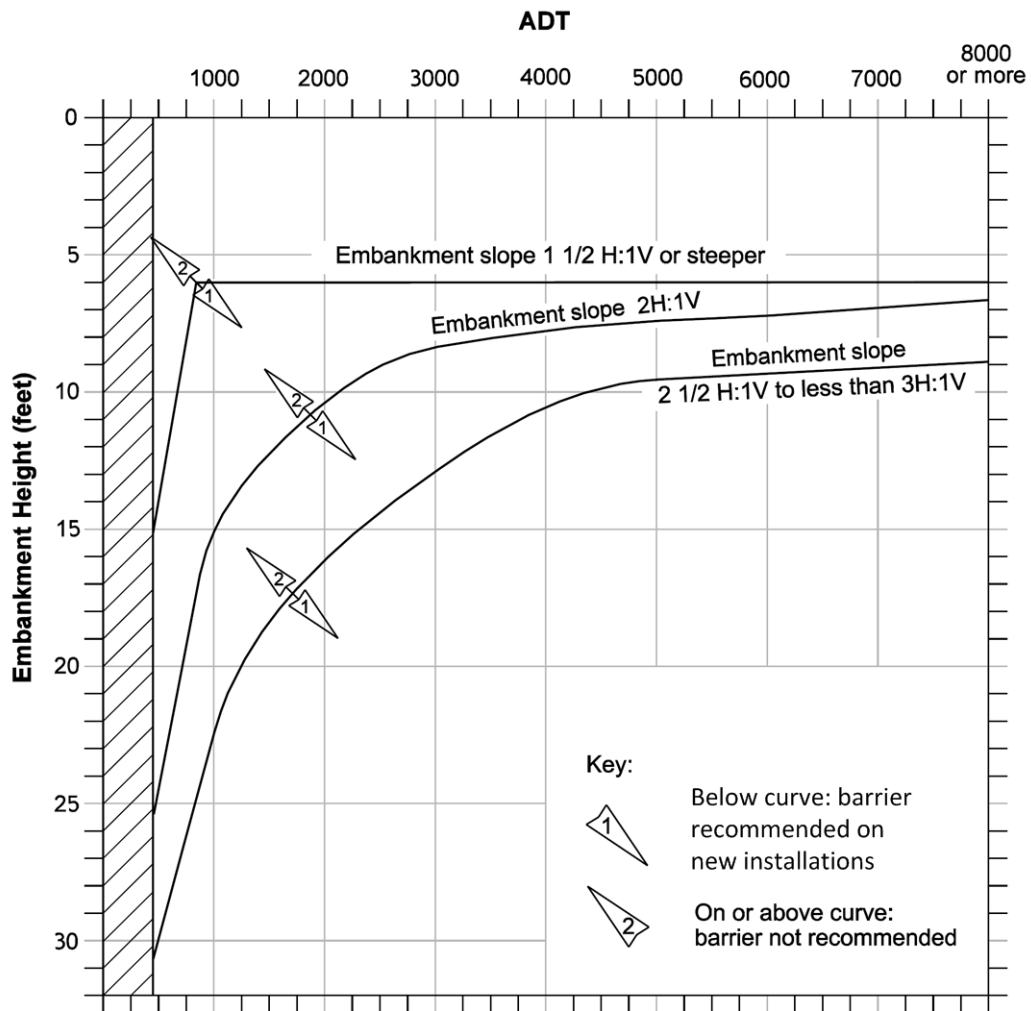

Note:

Routes with ADTs under 400 may be evaluated on a case-by-case basis.

Exhibit 1600-7 Mailbox Location and Turnout Design

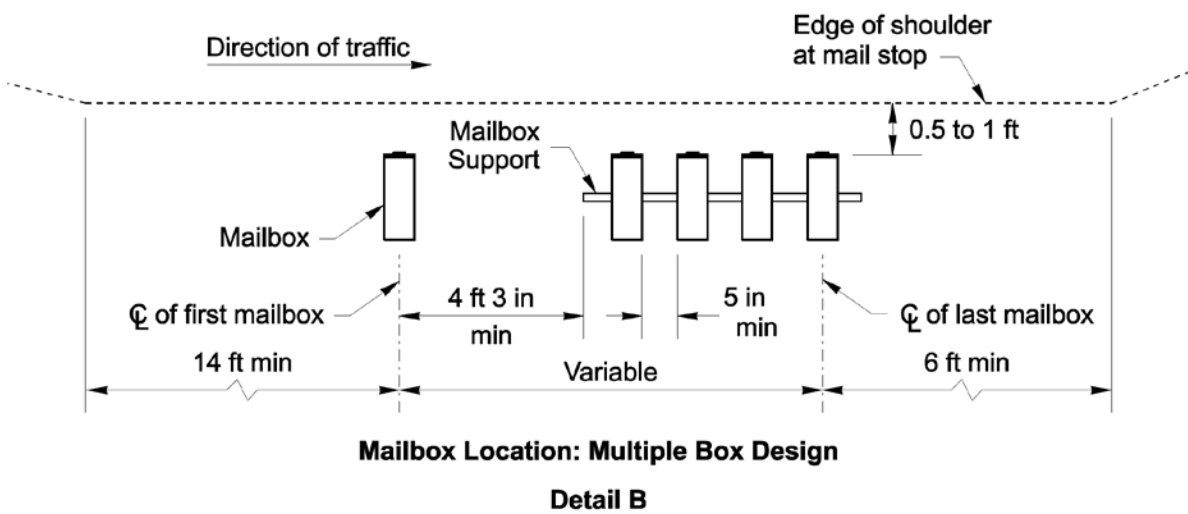
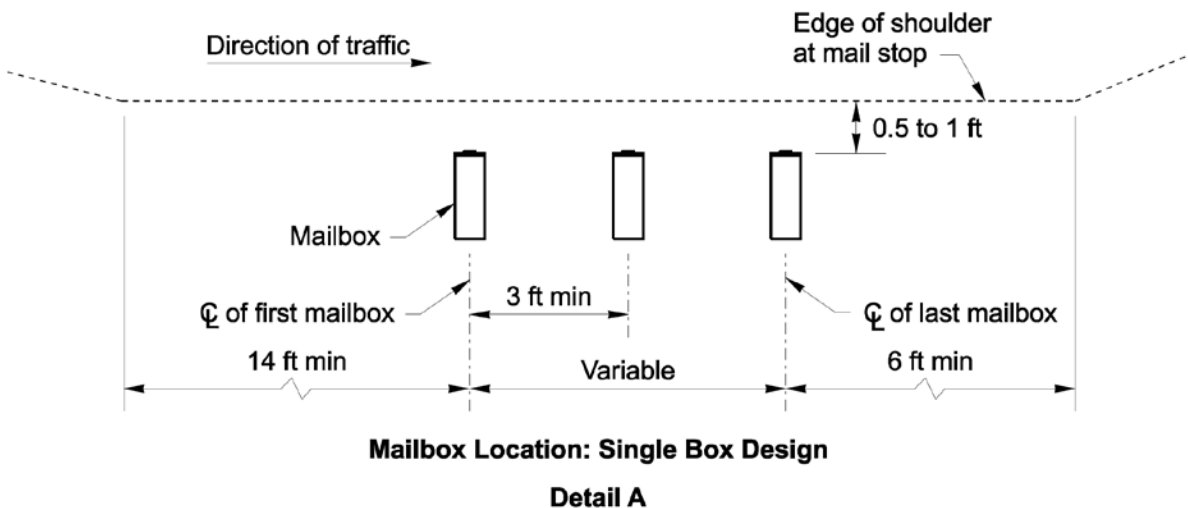
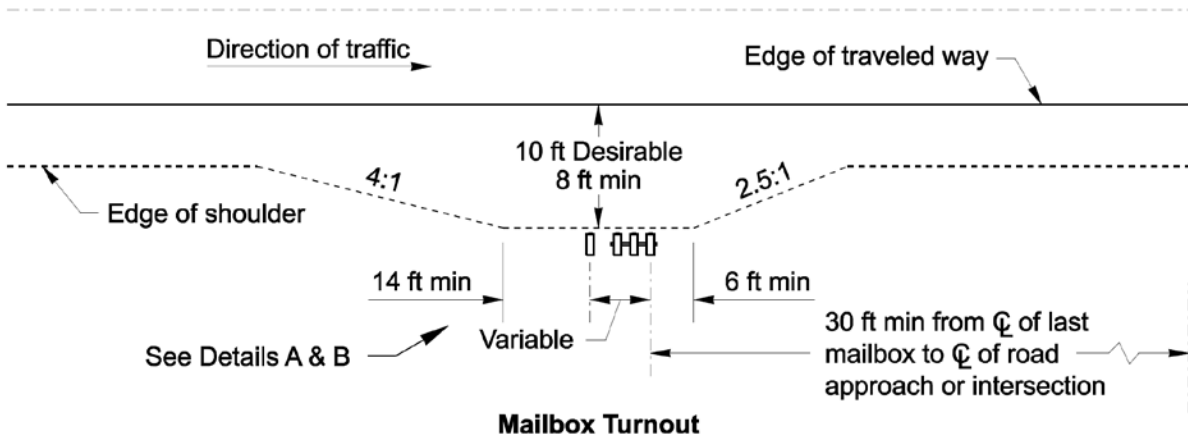
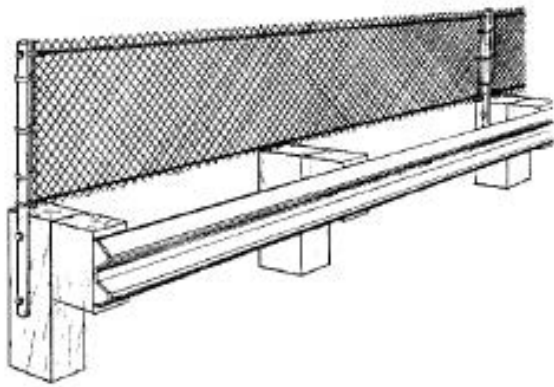
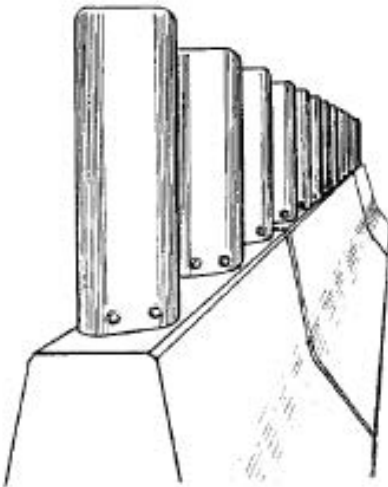
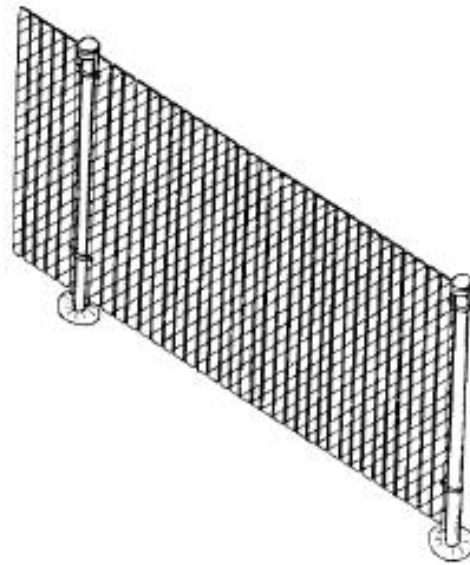

Exhibit 1600-8 Glare Screens



Chain Link



Vertical Blades

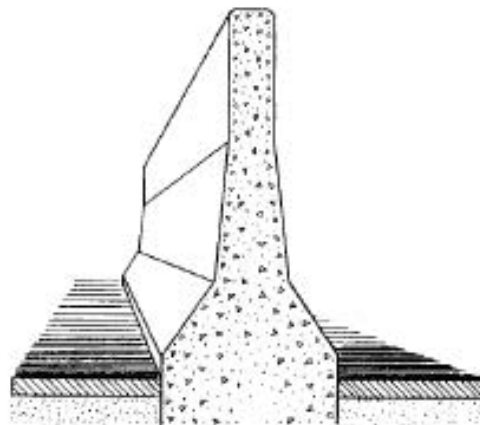

Concrete Barrier

1610.01	General	1610.07	Cable Barrier
1610.02	References	1610.08	Concrete Barrier
1610.03	Definitions	1610.09	Special-Use Barriers
1610.04	Project Criteria	1610.10	Bridge Traffic Barriers
1610.05	Barrier Design	1610.11	Other Barriers
1610.06	Beam Guardrail	1610.12	Documentation

1610.01 General

The Washington State Department of Transportation (WSDOT) uses traffic barriers to reduce the overall severity of crashes that occur when a vehicle leaves the traveled way. Consider whether a barrier is preferable to the recovery area it replaces. In some cases, installation of a traffic barrier may result in more crashes, as it presents an object that can be struck. Barriers are designed so that such encounters might be less severe and not lead to secondary or tertiary crashes. However, when impacts occur, traffic barriers are not guaranteed to redirect vehicles without injury to the occupants or additional crashes.

Barrier performance is affected by the characteristics of the types of vehicles that collide with them. For example, motor vehicles with large tires and high centers of gravity are commonplace on our highways and they are designed to mount obstacles. Therefore, they are at greater risk of mounting barriers or of not being decelerated and redirected as conventional vehicles would be.

When barriers are crash-tested, it is impossible to replicate the innumerable variations in highway conditions. Therefore, barriers are crash-tested under standardized conditions. These standard conditions were previously documented in National Cooperative Highway Research Program (NCHRP) Report 350. These guidelines have been updated and are now presented in the *Manual for Assessing Safety Hardware (MASH)*.

Barriers are not placed with the assumption that the system will restrain or redirect all vehicles in all conditions. It is recognized that the designer cannot design a system that is foolproof or will address every potential crash situation. Instead, barriers are placed with the assumption that, under normal conditions, they might provide lower potential for occupant deceleration and vehicle redirection for given roadside crashes when compared to a location without barrier.

Traffic barriers do not prevent crashes or injuries from occurring. They are intended to lower the potential severity for crash outcomes based on the conditions for which they are installed. Consequently, barriers should not be used unless a reduced crash frequency and severity potential is likely. No matter how well a barrier system is designed, optimal performance is dependent on drivers' proper use, maintenance, and operation of their vehicles and the proper use of vehicle restraint systems. At the time of installation, the ultimate choice of barrier type and placement is made by gaining an understanding of site and traffic conditions, having a thorough understanding of and using the criteria presented in Chapters 1600 and 1610, and using engineering judgment.

1610.02 References

1610.02(1) Design Guidance

Bridge Design Manual, M 23-50, WSDOT

Roadside Design Guide, AASHTO, 2011

Standard Plans for Road, Bridge, and Municipal Construction (Standard Plans), M 21-01, WSDOT

Traffic Manual, M 51-02, WSDOT

1610.02(2) Supporting Information

NCHRP 350, TRB, 1993

Manual for Assessing Safety Hardware (MASH), AASHTO, 2009

Determining Length of Need. This e-learning course for WSDOT employees covers the “Length of Need,” which is a calculation of how much longitudinal barrier is necessary to shield objects on the roadside. Request this training via the web-based Learning Management System.

1610.03 Definitions

Refer to the *Design Manual Glossary* for many of the terms used in this chapter.

1610.04 Project Criteria

See [Chapter 1105 Design Element Selection](#). Additionally, follow the guidance in this chapter for any project that introduces new barrier onto the roadside (including median). Remove barrier that is not needed. Use the criteria in [Chapter 1600](#) as the basis for removal.

1610.04(1) Barrier Terminals and Transitions

Install, replace, or upgrade transitions as discussed in [1610.06\(5\)](#), Transitions and Connections.

Impact attenuator criteria can be found in [Chapter 1620](#), Impact Attenuator Systems. Concrete barrier terminal criteria can be found in [1610.08\(3\)](#).

When installing new terminals, consider extending the guardrail to meet the length-of-need criteria found in [1610.05\(5\)](#) as a spot safety enhancement, which is a modification to isolated roadway or roadside features that, in the engineer’s judgment, reduce potential for crash frequency or severity.

When the end of a barrier has been terminated with a small mound of earth, remove and replace with a crash-tested terminal, except as noted in [1610.09](#).

Redirectional landforms, also referred to as earth berms, were formerly installed to help mitigate crashes with fixed objects located in depressed medians and at roadsides. They were constructed of materials that provided support for a traversing vehicle. With slopes in the range of 2H:1V to 3H:1V, they were intended to redirect errant vehicles. The use of redirectional landforms has been discontinued. Where redirectional land forms currently exist as mitigation for a fixed object,

provide alternative means of mitigation of the fixed object, such as remove, relocate, upgrade with crash-tested systems, or shield with barrier. Landforms may be used to provide a smooth surface at the base of a rock cut slope.

Replace guardrail terminals that do not have a crash-tested design with crash-tested guardrail terminals (see [1610.06\(4\)](#), Terminals and Anchors). Common features of systems that do not meet current crash-tested designs include:

- No cable anchor.
- A cable anchored into concrete in front of the first post.
- Second post not breakaway (CRT).
- Design A end section (Design C end sections may be left in place—see the [Standard Plans](#) for end section details).
- Terminals with beam guardrail on both sides of the posts (two-sided).
- Buried guardrail terminals that slope down such that the guardrail height is reduced to less than 26 inches.

When the height of an existing terminal will be reduced to less than 26 inches from the ground to the top of the rail element, adjust the height to a minimum of 26 inches and a maximum of 28 inches. A rail height of 28 inches is desirable to accommodate future overlays. When adjusting terminals that are equipped with CRT posts, the top-drilled holes in the posts need to remain at the surface of the ground.

One terminal that was used extensively on Washington’s highways was the Breakaway Cable Terminal (BCT). This system used a parabolic flare similar to the Slotted Rail Terminal (SRT) and a Type 1 anchor. (Type 1 anchor posts are wood set in a steel tube or a concrete foundation.) Replace BCTs on Interstate routes. On non-Interstate routes and Interstate ramps, BCTs that have at least a 3-foot offset may remain in place unless the guardrail run or anchor is being reconstructed or reset. (Raising the rail element is not considered reconstruction or resetting.)

Existing transitions that do not have a curb but are otherwise consistent with the designs shown in the [Standard Plans](#) may remain in place.

1610.04(2) Standard Run of Barrier

A “Standard Run” of barrier consists of longitudinal barrier as detailed in the [Standard Plans](#).

1610.04(2)(a) Barrier Height Criteria

For HMA Overlay Projects that will reduce the height of W-beam guardrail to less than 26 inches from the ground to the top of the rail element, adjust the height to a minimum of 26 inches and a maximum of 28 inches. A rail height of 28 inches is desirable to accommodate future overlays.

If Type 1 Alternate W-beam guardrail is present, raise the rail element after each overlay. If Type 1 Alternate is not present, raise the existing blockout up to 4 inches higher than the top of the existing post by boring a new hole in the post.

Overlays in front of safety shape concrete barriers can extend to the top of the lower, near-vertical face of the barrier before adjustment is necessary.

- Allow no more than 1 foot 1 inch from the pavement to the beginning of the top near-vertical face of the safety shape barriers.

- Allow no less than 2 feet 8 inches from the pavement to the top of the single-slope barrier.
- Allow no less than 35 inches to the center of the top cable for four-cable high-tension cable barriers.

Note: There are new high-tension cable barrier systems under development, which may change the selection and placement criteria. The Headquarters (HQ) Design Office will circulate guidance on these new developments as they are adopted as WSDOT policy.

1610.04(2)(b) Additional Standard Run Considerations

Examples of barriers that are not acceptable as a “Standard Run” are:

- W-beam guardrail with 12-foot-6-inch post spacing or no blockouts, or both.
- W-beam guardrail on concrete posts.
- Cable barrier on wood or concrete posts.
- Half-moon or C-shaped rail elements.

1610.04(3) *Bridge Rail*

When Bridge Rail is included in a project, the bridge rails, including crossroad bridge rail, are to meet the following criteria:

- Use an approved, crash-tested concrete bridge rail on new bridges or bridges to be widened. The *Bridge Design Manual* provides examples of typical bridge rails. Consult the HQ Bridge and Structures Office regarding bridge rail selection and design and for design of the connection to an existing bridge.
- An existing bridge rail on a highway with a posted speed of 30 mph or below may remain in place if it is not located on a bridge over a National Highway System (NHS) highway. When Type 7 bridge rail is present on a bridge over an NHS highway with a posted speed of 30 mph or below, it may remain in place regardless of the type of metal rail installed. Other bridge rails are to be evaluated for strength and geometrics. (See [1610.10](#) for guidance on retrofit techniques.)
- The Type 7 bridge rail is common. Type 7 bridge rails have a curb, a vertical-face parapet, and an aluminum top rail. The curb width and the type of aluminum top rail are factors in determining the adequacy of the Type 7 bridge rail, as shown in [Exhibit 1610-1](#). Consult the HQ Bridge and Structures Office for assistance in evaluating other bridge rails.

Exhibit 1610-1 Type 7 Bridge Rail Upgrade Criteria

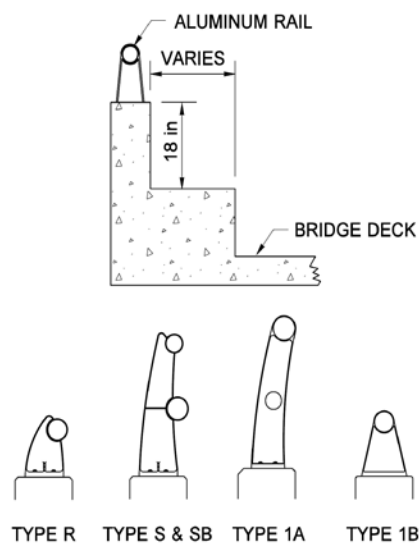

Aluminum Rail Type	Curb Width	
	9 Inches or Less	Greater Than 9 Inches*
Type R, S, or SB	Bridge rail adequate	Bridge rail adequate
Type 1B or 1A	Bridge rail adequate	Upgrade bridge rail
Other	Consult the HQ Bridge and Structures Office	
*When the curb width is greater than 9 inches, the aluminum rail must be able to withstand a 5 kip load.		

1610.05 Barrier Design

When selecting a barrier, consider the flexibility, cost, and maintainability of the system. It is generally desirable to use the most flexible system possible to minimize damage to the impacting vehicle and injury to the vehicle's occupant(s). However, since nonrigid systems sustain more damage during an impact, the exposure of maintenance crews to traffic might be increased with the more frequent need for repairs.

Maintenance costs for concrete barrier are lower than for other barrier types. In addition, deterioration due to weather and vehicle impacts is less than most other barrier systems. Unanchored precast concrete barrier can usually be realigned or repaired when moved from its alignment. However, heavy equipment may be necessary to reposition or replace barrier segments. Therefore, in medians, consider the shoulder width and the traffic volume when determining the acceptability of unanchored precast concrete barrier versus rigid concrete barrier.

Drainage, alignment, and drifting snow or sand are considerations that can influence the selection of barrier type. Beam guardrail and concrete barrier can contribute to snow drifts. Consider long-term maintenance costs associated with snow removal at locations prone to snow drifting. Slope flattening is recommended when the safety benefit justifies the additional cost to eliminate the need for the barrier. Cable barrier is not an obstruction to drifting snow and can be used if slope flattening is not feasible.

With some systems, such as concrete and beam guardrail, additional shoulder widening or slope flattening is common. However, selection of these types of barriers is sometimes limited due to the substantial environmental permitting and highway reconstruction needs. Permits issued under the SEPA and NEPA processes may lead to the use of a barrier design such as cable barrier, which has fewer potential environmental impacts and costs.

1610.05(1) Sight Distance

When selecting and placing a barrier system, consider the possible impact the barrier type and height may have on sight distance. In some cases, barriers may restrict the sight distances of road users entering the roadway, such as from road approaches, intersections, and other locations. In these cases, the barrier may need to be adjusted to meet the required sight distance requirements at these locations.

1610.05(2) Shy Distance

Provide 2 feet of additional widening for shy distance when a barrier is to be installed in areas where the roadway is to be widened and the shoulder width will be less than 8 feet. This shy distance is not needed when the section of roadway is not being widened or the shoulders are at least 8 feet wide.

1610.05(3) Barrier Deflections

Expect all barriers except rigid barriers (such as concrete bridge rails) to deflect when hit by an errant vehicle. The amount of deflection is primarily dependent on the stiffness of the system. However, vehicle speed, angle of impact, and weight also affect the amount of barrier deflection. For flexible and semirigid roadside barriers, the deflection distance is designed to help prevent the impacting vehicle from striking the object being shielded. For unrestrained rigid systems (unanchored precast concrete barrier), the deflection distance is designed to help prevent the barrier from being knocked over the side of a drop-off or steep fill slope (2H:1V or steeper).

In median installations, design systems such that the anticipated deflection will not enter the lane of opposing traffic using deflection values that were determined from crash tests. When evaluating new barrier installations, consider the impacts where significant traffic closures are necessary to accomplish maintenance. Use a rigid system where deflection cannot be tolerated, such as in narrow medians or at the edge of bridge decks or other vertical drop-off areas. Runs of rigid concrete barrier can be cast in place or extruded with appropriate footings.

In some locations where deflection distance is limited, anchor precast concrete barrier. Unless the anchoring system has been designed to function as a rigid barrier, some movement can be expected and repairs may be more expensive. Use of an anchored or other deflecting barrier on top of a retaining wall without deflection distance provided requires approval from the HQ Design Office.

Refer to [Exhibit 1610-2](#) for barrier deflection design values when selecting a longitudinal barrier. The deflection distances for cable and beam guardrail are the minimum measurements from the face of the barrier to the fixed feature. The deflection distance for unanchored concrete barrier is the minimum measurement from the back edge of the barrier to the drop-off or slope break.

Exhibit 1610-2 Longitudinal Barrier Deflection

Barrier Type	System Type	Deflection
Cable barrier or beam guardrail, Types 20 and 21, on G-2 posts	Flexible	Up to 12 ft (face of barrier to object)
Beam guardrail, Types 1, 1a, 2, 10, and 31	Semirigid	3 ft (face of barrier to object)
Two-sided W-beam guardrail, Types 3 and 4	Semirigid	2 ft (face of barrier to object)
Permanent concrete barrier, unanchored	Rigid Unrestrained	3 ft ^[1] (back of barrier to object)
Temporary concrete barrier, unanchored	Rigid Unrestrained	2 ft ^[2] (back of barrier to object)
Precast concrete barrier, anchored	Rigid Anchored	6 inches (back of barrier to object)
Rigid concrete barrier	Rigid	No deflection
Notes:		
[1] When placed in front of a 2H:1V or flatter fill slope, the deflection distance can be reduced to 2 feet.		
[2] When used as temporary bridge rail, anchor all barrier within 3 feet of a drop-off.		

1610.05(4) Flare Rate

Flare the ends of longitudinal barriers where practicable. The four functions of a flare are to:

- Locate the barrier and its terminal as far from the traveled way as feasible.
- Reduce the length of need.
- Redirect an errant vehicle.
- Minimize a driver's reaction to the introduction of an object near the traveled way.

Keeping flare rates as flat as practicable preserves the barrier's redirection performance and minimizes the angle of impact. However, it has been shown that an object (or barrier) close to the traveled way might cause a driver to shift laterally, slow down, or both. The flare reduces this reaction by gradually introducing the barrier so the driver does not perceive the barrier as an object to be avoided. The flare rates in [Exhibit 1610-3](#) are intended to satisfy the four functions listed above. More gradual flares may be used. Flare rates are offset parallel to the edge of the traveled way. Transition sections are not normally flared.

Exhibit 1610-3 Longitudinal Barrier Flare Rates

Posted Speed (mph)	Rigid & Rigid Anchored System	Unrestrained Rigid System	Semirigid System
65–70	20:1	18:1	15:1
60	18:1	16:1	14:1
55	16:1	14:1	12:1
50	14:1	12:1	11:1
45	12:1	11:1	10:1
40 or below	11:1	10:1	9:1

1610.05(5) Length of Need

The length of traffic barrier needed to shield a fixed feature (length of need) is dependent on the location and geometrics of the object, direction(s) of traffic, posted speed, traffic volume, and type and location of traffic barrier. When designing a barrier for a fill slope (see [Chapter 1600](#)), the length of need begins at the point where the need for barrier is recommended. For fixed objects and water, Exhibits [1610-10a](#) and [10b](#) show design parameters for determining the needed length of a barrier for both adjacent and opposing traffic on relatively straight sections of highway.

When barrier is to be installed on the outside of a horizontal curve, the length of need can be determined graphically, as shown in [Exhibit 1610-10c](#). For installations on the inside of a curve, determine the length of need as though it were straight. Also, consider the flare rate, barrier deflection, and barrier end treatment to be used.

When beam guardrail is placed in a median, consider the potential for impact from opposing traffic when conducting a length of need analysis. When guardrail is placed on either side of objects in the median, consider whether the trailing end of each run of guardrail will shield the leading end of the opposing guardrail. Shield the leading end when it is within the Design Clear Zone of opposing traffic (see [Exhibit 1610-10d](#)). This is also a consideration when objects are placed in the outer separations between the main line and collector-distributors.

Before the actual length of need is determined, establish the lateral distance between the proposed barrier installation and the object shielded. Provide a distance that is greater than or equal to the anticipated deflection of the longitudinal barrier. (See [Exhibit 1610-2](#) for barrier deflections.) Place the barrier as far from the edge of the traveled way as possible while maintaining the deflection distance.

If the end of the length of need is near an adequate cut slope, extend the barrier and embed it in the slope (see [1610.06\(4\)](#)). Avoid gaps of 300 feet or less. Short gaps are acceptable when the barrier is terminated in a cut slope. If the end of the length of need is near the end of an existing barrier, it is recommended that the barriers be connected to form a continuous barrier. Consider maintenance access issues when determining whether or not to connect barriers.

1610.05(6) Median Barrier Selection and Placement Considerations

The most desirable barrier installation uses the most flexible system appropriate for the location and one that is placed as far from the traveled way as practicable. Engineers are faced with the fact that barrier systems and vehicle fleets continue to evolve. What may be an optimal choice of barrier based on the majority of vehicles on the road today may not be the best selection for vehicles on the road in the foreseeable future. This continuum of change does not allow engineers to predict the future with any degree of certainty. Consequently, engineering decisions need to be made based on the most reliable and current information.

Engineers are constantly striving to develop more effective design features to improve highway safety. However, economics and feasibility do not permit new designs to be employed as soon as they are invented. The fact that a new design has been developed does not mean that the old design is unsafe. Although new designs may have been tested under controlled conditions, their performance under relevant applications may demonstrate unexpected performance aspects. Therefore there may be a need to modify application methods based on that practical experience.

Good engineering judgment is called for in determining the appropriate placement of barrier systems. Solutions may need to be arrived at while considering competing factors such as crash frequency and severity. As discussed previously, performance of the system relies on the interaction of the vehicle, driver, and system design at any given location. Additionally, the ability to access the system for maintenance and availability of parts plays into the final decision.

With median barriers, the deflection characteristics and placement of the barrier for a traveled way in one direction can have an impact on the traveled way in the opposing direction. In addition, the median slopes and environmental issues often influence the type of barrier that is appropriate.

In narrow medians, avoid placement of barrier where the design deflection extends into oncoming traffic. Narrow medians provide little space for maintenance crews to repair or reposition the barrier. Therefore, avoid installing deflecting barriers in medians that provide less than 8 feet from the edge of the traveled way to the face of the barrier.

In wider medians, the selection of barrier might depend on the slopes in the median. At locations where the median slopes are relatively flat (10H:1V or flatter), unrestrained precast concrete barrier, beam guardrail, and cable barrier can be used depending on the available deflection distance. At these locations, position the barrier as close to the center as possible so that the recovery distance can be maximized for both directions. There may be a need to offset the barrier from the flow line to avoid impacts to the drainage flow.

In general, cable barrier is recommended with medians that are 30 feet or wider. However, cable barrier may be appropriate for narrower medians if adequate deflection distance exists. In wide medians where the slopes are steeper than 10H:1V but not steeper than 6H:1V, cable barrier placed near the center of the median is preferable. For additional cable barrier placement guidance, see Exhibits [1610-13a](#) through [13c](#). Place beam guardrail at least 12 feet from the slope breakpoint, as shown in [Exhibit 1610-4](#). Do not use concrete barrier at locations where the foreslope into the face of the barrier is steeper than 10H:1V.

Exhibit 1610-4 Traffic Barrier Locations on Slopes

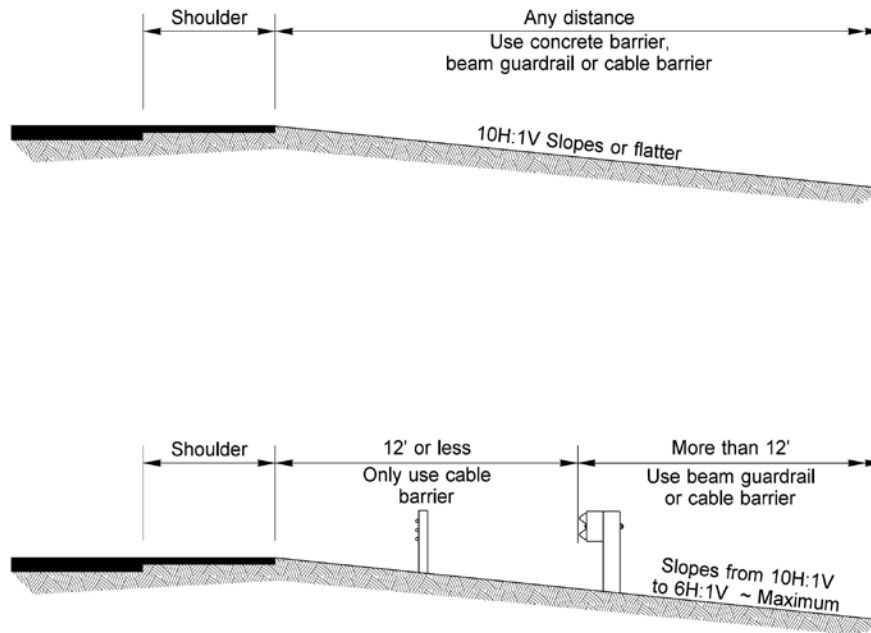

At locations where the roadways are on independent alignments and there is a difference in elevation between the roadways, the slope from the upper roadway might be steeper than 6H:1V. In these locations, position the median barrier along the upper roadway and provide deflection and offset distance as discussed previously. Barrier is generally not needed along the lower roadway except where there are fixed features in the median.

When W-beam barrier is placed in a median as a countermeasure for cross-median crashes, design the barrier to be struck from either direction of travel. For example, the installation of beam guardrail might be double-sided (Type 31-DS).

1610.05(7) Aesthetic Barrier Treatment

When designing a barrier for use on a Scenic Byway, consider barriers that are consistent with the recommendations in the associated corridor management plan (if one is available). Contact the region Landscape Architect or the Scenic Byways Coordinator in the HQ Highways and Local Programs Office to determine whether the project is on such a designated route. Low-cost options, such as using weathering steel beam guardrail (see 1610.06) or cable barrier (see 1610.07), might be feasible on many projects. Higher-cost options, such as steel-backed timber rail and stone guardwalls (see 1610.09), might necessitate a partnering effort to fund the additional costs. Grants might be available for this purpose if the need is identified early in the project definition phase.

1610.05(8) Barrier Delineation

Refer to 1030.06 for delineation requirements.

1610.06 Beam Guardrail

1610.06(1) Beam Guardrail Systems

Beam guardrail systems are shown in the [Standard Plans](#).

Strong post W-beam guardrail (Types 1 through 4, and 31) and thrie beam guardrail (Types 10 and 11) are semirigid barriers used predominantly on roadsides. They have limited application as median barrier. Installed incorrectly, strong post W-beam guardrail can cause vehicle snagging or spearing. This can be avoided by lapping the rail splices in the direction of traffic (as shown in the [Standard Plans](#)), by using crash-tested end treatments, and by blocking the rail away from the strong posts. However, avoid the use of blockouts that extend from the post to the rail element for a distance exceeding 16 inches. Placement of curb at guardrail installations also requires careful consideration.

Previously, WSDOT standard practice was to install W-beam guardrail at a rail height of 27 inches. However, there are newer designs that use a 31-inch rail height. One is the 31 inch-high WSDOT Type 31. The Type 31 system uses many of the same components as the WSDOT Type 1 system. However, the main differences are that the blockouts extend 12 inches from the posts, the rail height is 31 inches from the ground to the top of the rail, and the rail elements are spliced between posts.

The 31-inch-high system offers tolerance for future HMA overlays. The Type 31 system allows a 3-inch tolerance from 31 inches to 28 inches without adjustment of the rail element.

1610.06(2) W-Beam Barrier Selection and Placement

During the project development processes, consult with maintenance staff to help identify guardrail runs that may need to be upgraded.

- Use the 31-inch-high guardrail design for new runs. When guardrail is installed along existing shoulders with a width greater than 4 feet, the shoulder width may be reduced by 4 inches to accommodate the 12-inch blockout.
- Existing runs with rail height at 27 inches are acceptable to leave in place and can be extended if the design height of 27 inches is maintained in the extended section. Where future overlays are anticipated, extend with Type 1 alternate or the 31-inch design.
- For existing runs below 26 inches, adjust or replace the rail to a height of 26 inches minimum to 28 inches maximum, or replace the run with the 31-inch-high guardrail design.
- Some 31-inch-high proprietary guardrail designs that do not incorporate the use of blockouts have been successfully crash-tested. The use of this type of system may be appropriate for some applications. Contact the HQ Design Office for further details.

Some designs for Type 31 applications are under development and will be added to the HQ Design Standards (Plan Sheet Library: <http://www.wsdot.wa.gov/Design/Standards/PlanSheet>) as soon as they are completed. Plans will be housed at this location until they are transitioned into the [Standard Plans](#). **Note:** If a design is not available for the Type 31 guardrail system, a Type 1 guardrail design may be used.

1610.06(3) Additional Guidance

- Weak post W-beam guardrail (Type 20) and three beam guardrail (Type 21) are flexible barrier systems that can be used where there is adequate deflection distance (see the [Standard Plans](#)). These systems use weak steel posts. The primary purpose of these posts is to position the guardrail vertically, and they are designed to bend over when struck. These more flexible systems will likely result in less damage to the impacting vehicle. Since the weak posts will not result in snagging, blockouts are not necessary.
- Keep the slope of the area between the edge of the shoulder and the face of the guardrail 10H:1V or flatter. On fill slopes between 6H:1V and 10H:1V, avoid placing within 12 feet of the break point. Do not place beam guardrail on a fill slope steeper than 6H:1V. (See [Exhibit 1610-4](#) for additional guidance on beam guardrail slope placement.)
- On the high side of superelevated sections, place beam guardrail at the edge of shoulder prior to the slope break.
- For W-beam guardrail installed at or near the shoulder, 2 feet of shoulder widening behind the barrier is generally provided from the back of the post to the beginning of a fill slope (see [Exhibit 1610-11](#), Case 2). If the slope is 2H:1V or flatter, this distance can be measured from the face of the guardrail rather than the back of the post (see [Exhibit 1610-11](#), Case 1).
- On projects where no roadway widening is proposed and the minimum 2-foot shoulder widening behind the barrier is not practicable, long post installations are available as shown in [Exhibit 1610-11](#), Cases 3, 4, 5, and 6. When guardrail is to be installed in areas where the roadway is to be widened or along new alignments, the use of Cases 5 and 6 requires a design deviation.
- Rail washers on beam guardrail are not normally used. If rail washers are present, removal is not necessary except for posts 2 through 8 of an existing BCT installation. However, if the rail element is removed for any reason, do not reinstall rail washers. In areas where heavy snow accumulations are expected to cause the bolts to pull out, specify snowload post washers and rail washers in the contract documents. (Snowload post washers are used to help prevent the bolts from pulling through the posts, and snowload rail washers are used to help prevent the bolt head from pulling through the rail.) In other installations, it is normal to have the rail pull loose from the bolt head when impacted. Do not use rail washers within the limits of a guardrail terminal except at the end post where they are needed for anchorage of the rail.
- The use of curb in conjunction with beam guardrail is discouraged. If a curb is needed, the 3 inch-high curb is preferred. If necessary, the 4-inch-high extruded curb can be used behind the face of rail at any posted speed. The 6-inch-high extruded curb can be used at locations where the posted speed is 50 mph or below. When replacing extruded curb at locations where the posted speed is above 50 mph, use 3 inch-high or 4-inch-high curb. (See the [Standard Plans](#) for extruded curb designs.)
- **Note:** When used in conjunction with the 31-inch-high Type 31 W-beam guardrail, an acceptable option is to place up to a 6-inch-high extruded curb at a maximum 6 inch offset outside the face of the rail at any posted speed. Contact the WSDOT Design Office for more information.
- Beam guardrail is usually galvanized and has a silver color. It can also be provided in weathering steel that has a brown or rust color. Along Scenic Byways, Heritage Tour Routes, state highways through national forests, or other designated areas where aesthetic barrier is needed, consider using weathering steel guardrail, colored terminals

(powder-coated galvanized steel), and colored steel posts (galvanized weathering steel or powder-coated galvanized steel) to minimize the barrier's visual impact (see [1610.05\(7\)](#)).

- There are new methods under development that may change the options for providing colored guardrail to meet the aesthetic barrier. The HQ Design Office will circulate guidance on these new developments as they are adopted as WSDOT policy.

1610.06(4) Terminals and Anchors

A guardrail anchor is needed at the end of a run of guardrail to develop tensile strength throughout its length. In addition, when the end of the guardrail is subject to head-on impacts, a crash-tested guardrail terminal is needed (see the [Standard Plans](#)).

1610.06(4)(a) Buried Terminal (BT)

A buried terminal is designed to terminate the guardrail by burying the end in a backslope. The BT is the preferred terminal because it eliminates the exposed end of the guardrail.

The BT uses a Type 2 anchor to develop the tensile strength in the guardrail. The backslope needed to install a BT is to be 3H:1V or steeper and at least 4 feet in height above the roadway. The entire BT can be used within the length of need for backslopes of 1H:1V or steeper if the barrier remains at full height in relation to the roadway shoulder to the point where the barrier enters the backslope. For backslopes between 1H:1V and 3H:1V, design the length of need beginning at the point where the W-beam remains at full height in relation to the roadway shoulder—usually beginning at the point where the barrier crosses the ditch line. If the backslope is flatter than 1H:1V, provide a minimum 20-foot-wide by 75 foot-long distance behind the barrier and between the beginning length of need point at the terminal end to the mitigated object to be protected.

For new BT installations, use the Buried Terminal Type 2. **Note:** Previously, another BT option (the Buried Terminal Type 1) was an available choice. For existing situations, it is acceptable to leave this option in service as long as height requirements and other previous design criteria can still be met.

1. Buried Terminal Type 2

Flare the guardrail to the foreslope/backslope intersection using a flare rate that meets the criteria in [1610.05\(4\)](#). Provide a 4H:1V or flatter foreslope into the face of the guardrail and maintain the full guardrail height to the foreslope/backslope intersection in relation to a 10H:1V line extending from edge of shoulder breakpoint. (See the [Standard Plans](#) for details.)

1610.06(4)(b) Nonflared Terminal

If a BT terminal cannot be installed as described in [1610.06\(4\)\(a\)](#), consider a nonflared terminal (see [Exhibit 1610-12a](#)). For Type 31 guardrail systems, there are currently two acceptable sole source proprietary designs: the ET-31 and the SKT-MGS. Both the ET-31 and the SKT-MGS can be supplied with wood or steel posts. These systems use W-beam guardrail with a special end piece that fits over the end of the guardrail. When hit head on, the end piece is forced over the rail and either flattens or bends the rail and then forces it away from the impacting vehicle.

Both the SKT-MGS and the ET-31 terminals include an anchor for developing the tensile strength of the guardrail. The length of need begins at the third post for both terminals. Both of these terminals are available in two designs, which are based on the posted speed of the highway. For

highways with a posted speed of 50 mph or above, use the ET-31 (TL3) or the SKT-MGS (TL3) terminal. For highways with a posted speed of 45 mph or below, use the ET-31 (TL2) or SKT-MGS (TL2).

While these terminals do not need to have an offset at the end, a flare is recommended so that the end piece does not protrude into the shoulder. These terminals may have a 2-foot offset to the first post. Four feet of widening is needed at the end posts to properly anchor the system. When widening includes an embankment, fill material will be necessary for optimum terminal performance. (See the *Standard Plans* for widening details.)

When the entire barrier run is located farther than 12 feet beyond the shoulder break point and the slopes are greater than 10H:1V and 6H:1V or flatter, additional embankment at the terminal is not needed.

No snowload rail washers are allowed within the limits of these terminals.

When a Beam Guardrail Type 1 nonflared terminal is needed, two sole source proprietary terminals, the ET-PLUS or the Sequential Kinking Terminal (SKT), may be used (see Exhibit 1610-12b). Both of these Type 1 barrier terminals are available in two designs based on the posted speed of the highway. The primary difference in these designs is the length of the terminal. For highways with a posted speed of 50 mph or above, use the 50-foot-long ET PLUS TL3 or the SKT 350 terminal. For highways with a posted speed of 45 mph or below, use the 25 foot-long ET PLUS TL2 or SKT-TL2.

The FHWA has granted approval to use the above sole source nonflared proprietary terminals without justification.

Note: Approved shop drawings for terminals can be found by accessing the following website:

www.wsdot.wa.gov/design/policy/trafficbarriers.htm

1610.06(4)(c) Flared Terminal

WSDOT does not use a flared terminal system for the Type 31 system. However, if a flared terminal is needed for other applications, there are currently two acceptable sole source proprietary designs: the Slotted Rail Terminal (SRT) and the Flared Energy Absorbing Terminal (FLEAT). Both of these designs include an anchor for developing the tensile strength of the guardrail. The length of need begins at the third post for both flared terminals.

1. The SRT uses W-beam guardrail with slots cut into the corrugations and posts throughout the length of the terminal. The end of the SRT is offset from the tangent guardrail run by the use of a parabolic flare. When struck head on, the first two posts are designed to break away, and the parabolic flare gives the rail a natural tendency to buckle, minimizing the possibility of the guardrail end entering the vehicle. The buckling is facilitated by the slots in the rail. The remaining posts provide strength to the system for redirection and deceleration without snagging the vehicle. The SRT has a 4 foot offset of the first post.

The SRT terminal can be supplied with wood or steel posts. Match the type of SRT posts with those of the longitudinal barrier run to which the terminal will be connected.

2. The FLEAT uses W-beam guardrail with a special end piece that fits over the end of the guardrail and posts. The end of the FLEAT is offset from the tangent guardrail run by the use of

a straight flare. When struck head on, the end piece is forced over the rail, bending the rail and forcing it away from the impacting vehicle.

Note: Approved shop drawings for terminals can be found by accessing the following website:

www.wsdot.wa.gov/design/policy/trafficbarriers.htm

The FLEAT is available in two designs based on the posted speed of the highway. For highways with a posted speed of 50 mph or above, use a FLEAT 350, which has a 4-foot offset at the first post. For highways with a posted speed of 45 mph or below, use a FLEAT TL-2, which has a 1 foot-8-inch offset at the first post.

The FLEAT terminal can be supplied with wood or steel posts. Match the type of FLEAT posts with those of the longitudinal barrier run to which the terminal will be connected.

When a flared terminal is specified, it is critical that the embankment quantity also be specified so that the area around the terminal can be constructed as shown in the [Standard Plans](#).

When the entire barrier run is located greater than 12 feet beyond the shoulder break point and the slopes are greater than 10H:1V and 6H:1V or flatter, additional embankment at the terminal is not needed.

Snowload rail washers are not allowed within the limits of these terminals.

The FHWA has granted approval to use the SRT and the FLEAT sole source proprietary flared terminals without justification.

1610.06(4)(d) Terminal Evolution Considerations

Some currently approved terminals have been in service for a number of years. During this time, there have been minor design changes. However, these minor changes have not changed the devices' approval status. Previous designs for these terminals may remain in place. (For guidance on BCT terminals, see [1610.04\(1\)](#).)

Note: If questions arise concerning the current approval status of a device, contact the HQ Design Office for clarification when replacement is being considered.

1610.06(4)(e) Other Anchor Applications

Use the Type 10 anchor to develop the tensile strength of the guardrail on the end of Type 31 guardrail runs where a crash-tested terminal is not needed. The Type 1 or Type 4 anchor is used for older Beam Guardrail Type 1 where a crash-tested terminal is not needed. Use the Type 5 anchor with the Weak Post Intersection Design (see [1610.06\(6\)\(b\)](#), Cases 12 and 13). Use the Type 7 anchor to develop tensile strength in the middle of a guardrail run when the guardrail curves and weak posts are used (see [1610.06\(6\)\(b\)](#), Cases 9, 12, and 13).

The old Type 3 anchor was primarily used at bridge ends (see [Exhibit 1610-5](#)). This anchor consisted of a steel pipe mounted vertically in a concrete foundation. Bridge approach guardrail was then mounted on the steel pipe.

- On one-way highways, these anchors were usually positioned so that neither the anchor nor the bridge rail posed a snagging potential. When these cases are encountered, the anchor may remain in place if a stiffened transition section is provided at the connection to the post.

- On two-way highways, the anchor may present a snagging potential. In these cases, install a connection from the anchor to the bridge rail if the offset from the bridge rail to the face of the guardrail is 1 foot 6 inches or less. If the offset is greater than 1 foot 6 inches, remove the anchor and install a new transition and connection.

Exhibit 1610-5 Old Type 3 Anchor

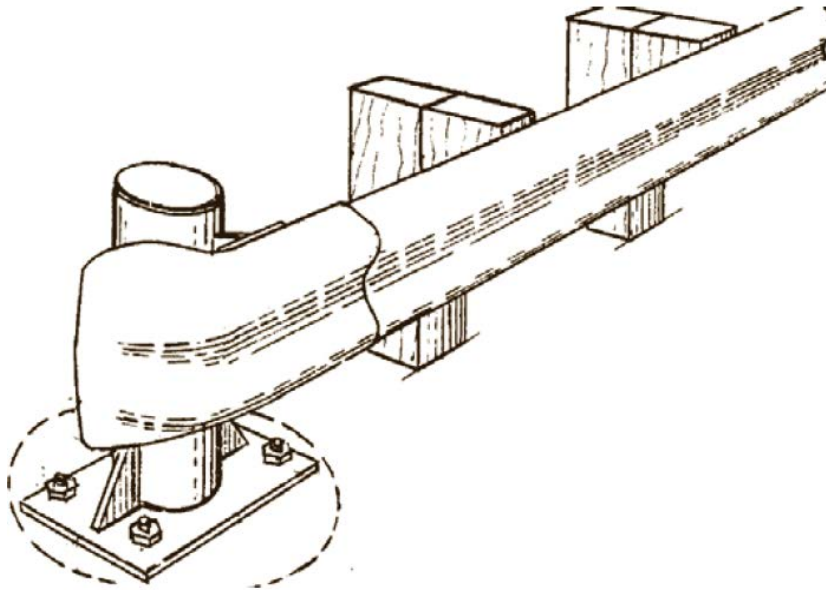

Locations where crossroads and driveways cause gaps in the guardrail create situations for special consideration. Elimination of the need for the barrier is the preferred solution. Otherwise, a barrier flare might be needed to provide sight distance. If the slope is 2H:1V or flatter and there are no fixed features on or at the bottom of the slope, a terminal can be used to end the rail (see Chapters 1310 and 1340 for additional sight distance guidance). Place the anchor of this installation as close as possible to the road approach radius PC.

1610.06(5) *Transitions and Connections*

When there is an abrupt change from one barrier type to a more rigid barrier type, a vehicle hitting the more flexible barrier is likely to be caught in the deflected barrier pocket and directed into the more rigid barrier. This is commonly referred to as “pocketing.” A transition stiffens the more flexible barrier by decreasing the post spacing, increasing the post size, and using stiffer beam elements to eliminate the possibility of pocketing.

When connecting beam guardrail to a more rigid barrier or a structure, or when a rigid object is within the deflection distance of the barrier, use the transitions and connections that are shown in Exhibits 1610-6 and 1610-9 and detailed in the *Standard Plans*. The transition pay item includes the connection.

Exhibit 1610-6 Guardrail Connections

Condition	Connection
Unrestrained concrete barrier	A
Rigid, rigid anchored, untapered safety shape bridge rails or barriers[1]	B
Bridge rails with curbs 9 inches or less in width	B
Bridge rails with curbs between 9 and 18 inches wide	C
Vertical walls, single slope, or tapered safety shape barrier[1]	D
Note: [1] New single slope and safety shape bridge rails are designed with the toe of the barrier tapered so that it does not project past the face of the approach guardrail.	

1610.06(6) Guardrail Placement Cases

The *Standard Plans* contains placement cases that show beam guardrail elements needed for typical situations. For some applications, the Standard Plans provides options for both Type 1 and Type 31 guardrail for similar installations. For new installations, use the appropriate Type 31 placement option. Additional placement cases incorporate other combinations of barrier types.

1610.06(6)(a) Beam Guardrail Type 31 Placements (for new installations)

- **Case 1-31** is used where there is one-way traffic. It uses a crash-tested terminal on the approach end and a Type 10 anchor on the trailing end.
- **Case 2-31** is used where there is two-way traffic. A crash-tested terminal is used on both ends.
- **Case 3-31** is used at railroad signal supports on one-way or two-way roadways. A terminal is used on the approach end, but usually cannot be used on the trailing end because of its proximity to the railroad tracks. If there is a history of crossover accidents, consider additional protection such as an impact attenuator.
- **Case 4-31** is used where guardrail on the approach to a bridge is to be shifted laterally to connect with the bridge rail. A terminal is used on the approach end and a transition is needed at the bridge end. A curve in the guardrail is shown to shift it to the bridge rail. However, the length of the curve is not critical. The criterion is to provide a smooth curve that is not more abrupt than the allowable flare rate (see [Exhibit 1610-3](#)).
- **Case 5-31** is a typical bridge approach where a terminal and a transition are needed.
- **Case 6** is used on bridge approaches where opposing traffic is separated by a median that is 36 feet or wider. This case is designed so that the end of the guardrail will be outside the Design Clear Zone for the opposing traffic.
- **Case 10 (A-31, B-31, and C-31)** is used at roadside fixed features (such as bridge piers) when 3 or more feet are available from the face of the guardrail to the feature. The approach end is the same for one-way or two-way traffic. Case 10A-31 is used with two-way traffic; therefore, a terminal is needed on the trailing end. Case 10B-31 is used for one-way traffic when there is no need to extend guardrail past the bridge pier and a Type 10 anchor is used to end the guardrail. Case 10C-31 is used for one-way traffic when the guardrail will extend for a distance past the bridge pier.

- **Case 11 (A-31, B-31, and C-31)** is used at roadside fixed features (such as bridge piers) when the guardrail is to be placed within 3 feet of the feature. Since there is no room for deflection, the rail in front of the feature is to be considered a rigid system and a transition is needed. The trailing end cases are the same as described for Case 10.
- **Beam Guardrail Type 31 (12'6", 18'9", or 25' Span)** is used when it is necessary to omit one, two, or three posts. This application is typically used when guardrail is installed over drainage structures but may have other applications if adequate deflection distance is present. Three CRT posts are provided on each end of the omitted post(s).
- **Guardrail Placement Strong Post – Type 31** is the “Strong Post Intersection Design for Type 31 barrier” that provides a stiff barrier. This design is used at crossroads or road approaches where a barrier is needed and where the length of need cannot be achieved using standard components such as standard longitudinal barrier runs, transitions, and terminals.

Note: Some placement cases for use with Beam Guardrail Type 31 are currently under development. As plans become available, they will be housed in the HQ Design Standards (Plan Sheet Library) until they become Standard Plans (www.wsdot.wa.gov/design/standards/plansheet).

1610.06(6)(b) Additional Placement Cases (typically, for existing installations)

- **Case 1** is used where there is one-way traffic. It uses a crash-tested terminal on the approach end and a Type 4 anchor on the trailing end.
- **Case 2** is used where there is two-way traffic. A crash-tested terminal is used on both ends. When flared terminals are used on both ends, use a minimum of 25 feet of guardrail between the terminal limits when feasible.
- **Case 3** is used at railroad signal supports on one-way or two-way roadways. A terminal is used on the approach end, but usually cannot be used on the trailing end because of its proximity to the railroad tracks. If there is a history of crossover accidents, consider additional protection such as an impact attenuator.
- **Case 4** is used where guardrail on the approach to a bridge is to be shifted laterally to connect with the bridge rail. A terminal is used on the approach end and a transition is needed at the bridge end. A curve in the guardrail is shown to shift it to the bridge rail. However, the length of the curve is not critical. The criterion is to provide a smooth curve that is not more abrupt than the allowable flare rate (see [Exhibit 1610-3](#)).
- **Case 5** is a typical bridge approach where a terminal and a transition are needed.
- **Case 6** is used on bridge approaches where opposing traffic is separated by a median that is 36 feet or wider. This case is designed so that the end of the guardrail will be outside the Design Clear Zone for the opposing traffic.
- **Cases 7 and 8** are used with beam guardrail median barrier when median fixed features such as bridge piers are encountered. A transition is needed on the approach end for each direction, and the flare rate is not to be more abrupt than the allowable flare rate (see [Exhibit 1610-3](#)).
- **Case 9 (A, B, and C)** is used on bridge approaches where opposing traffic is separated by a median less than 36 feet wide. This design, called a “Bull Nose Terminal,” treats both bridge ends and the opening between the bridges. The “nose” is designed to collapse when struck head on, and the ribbon strength of the rail brings the vehicle to a controlled stop. Type 7 anchors are installed on each side of the nose to develop the ribbon

strength. Since an impacting vehicle might penetrate into the system, it is critical that no fixed feature be located within the first 65 feet of the system.

- **Case 10 (A, B, and C)** is used at roadside fixed features (such as bridge piers) when 3 or more feet are available from the face of the guardrail to the object. The approach end is the same for one-way or two-way traffic. Case 10A is used with two-way traffic; therefore, a terminal is needed on the trailing end. Case 10B is used for one-way traffic when there is no need to extend guardrail past the bridge pier and a Type 4 anchor is used to end the guardrail. Case 10C is used for one-way traffic when the guardrail will extend for a distance past the bridge pier.
- **Case 11 (A, B, and C)** is used at roadside fixed features (such as bridge piers) when the guardrail is to be placed within 3 feet of the object. Since there is no room for deflection, the rail in front of the feature is to be considered a rigid system and a transition is needed. The trailing end cases are the same as described for Case 10.
- **Cases 12 and 13** are called “Weak Post Intersection Designs.” They are used where an intersection design needs a gap in the guardrail or there is not adequate space for a bridge approach installation that includes a transition, a terminal, or both. These placements are designed to collapse when hit at the nose, and the ribbon strength of the rail brings the vehicle to a stop. A Type 7 anchor is used to develop the ribbon strength. These designs include a Type 5 transition for connection with bridge rail and a Type 5 anchor at the other end of the rail. The Type 5 anchor is not a breakaway anchor and therefore can typically be used only in situations where a crash-tested terminal is not needed; for example, where slow-moving vehicles are anticipated, such as some side roads and driveways.

Since an impacting vehicle might penetrate into the system, it is critical that no fixed feature be located within the clear area shown in the [Standard Plans](#). The 25 feet of barrier length beyond the PC along the side road are critical for the operation of this system.

These designs were developed for intersections that are approximately perpendicular. Evaluate installation on skewed intersections on a case-by-case basis. Use the Case 22 placement if it is not feasible to install this design according to the [Standard Plans](#).

- **Case 14** shows the approach rail layout for a Service Level 1 bridge rail system. Type 20 guardrail is used on the approach and no transition is needed between the Type 20 guardrail and the Service Level 1 bridge rail since they are both weak post systems. A Type 6 transition is used when connecting the Type 20 to a strong post guardrail or a terminal.
- **Case 15** is used to carry guardrail across a box culvert where there is insufficient depth to install standard posts for more than 17 feet 8 inches. This design uses steel posts anchored to the box culvert to support the rail. Newer designs—Cases 19, 20, and 21—have replaced this design for shorter spans.
- **Cases 16 and 17** are similar to Cases 1 and 2, except that they flare the rail and terminal as far from the road as possible and reduce the length of need.
- **Case 18** is used on the trailing end of bridge rail on a one-way roadway. No transition is needed.
- **Case 19 (A and B)** is used where it is not possible to install a post at the 6 foot 3-inch spacing. This design omits one post (resulting in a span of 11 feet 6 inches, which is consistent with a post spacing of 12 feet 6 inches) and uses nested W-beam to stiffen the

rail. The cases differ by the location of the splice. No cutting of the rail or offsetting of the splices is needed or desirable.

- **Case 20** is similar to Cases 19A and 19B, except that it allows for two posts to be omitted, which results in a span consistent with post spacing of 18 feet 9 inches.
- **Case 21** has a similar intent as Cases 19A, 19B, and 20 in that it allows for the omission of posts to span an obstruction. This design uses CRT posts with additional post blocks for three posts before and after the omitted posts. The design allows for three posts to be omitted, which results in a span consistent with a post spacing of 25 feet.
- **Case 22** is the “Strong Post Intersection Design” that provides a stiff barrier. This design is to be used as a last resort at crossroads or road approaches where a barrier is needed and there isn’t a clear area behind the nose or minimum distances for a “Weak Post Intersection Design” (see Cases 12 and 13).

Note: Some placement cases for use with Beam Guardrail Type 31 are currently under development. As plans become available, they will be housed in the HQ Design Standards (Plan Sheet Library) until they become Standard Plans

(www.wsdot.wa.gov/design/standards/plansheet).

1610.07 Cable Barrier

Cable barrier is a flexible barrier system that can be used on a roadside or as a median barrier. It is used primarily in medians and is preferred for many installations due in part to its high benefit-to-cost ratio. Some of the advantages of cable barrier are:

- It provides effective vehicle containment and redirection while imposing the lowest deceleration forces on the vehicle’s occupant(s).
- It may reduce the severity of crashes, which is of significant importance on high-speed facilities.
- After it is struck, it has a tendency not to redirect vehicles back into traffic, which can help reduce the frequency of secondary crashes.
- It can often be placed on existing facilities without the delay of extended environmental permitting and the expense of complex highway reconstruction that might be needed for other barrier system choices.
- It has advantages in heavy snowfall areas because it has minimal potential to create snowdrifts.
- In crucial wildlife habitats, it can aid in some types of animal movements.
- It does not present a visual barrier, which may make it desirable on Scenic Byways (see [1610.05](#)).
- The effort (time and materials) needed to maintain and repair cable barrier systems is much less than the effort needed for a W-beam system.

Deflection is a consideration in narrower median areas and in many urban and other limited-width situations. Use of cable barrier in these situations may not be possible or may require special designs.

For new installations, use four-cable high-tension cable barrier systems, which are available from several manufacturers.

1610.07(1) High-Tension Cable Barrier Placement

For typical median applications with slopes between 10H:1V and 6H:1V, the following apply when using single runs of cable barrier (see [Exhibit 1610-13a](#)):

- Cable barrier may be installed in the centerline of the ditch.
- Cable barrier can be offset from the ditch centerline no more than 1 foot (left or right).
- Avoid installing cable barrier within a 1-foot to 8-foot offset from the ditch centerline.
- When locating cable barrier between an 8-foot offset from the ditch centerline and the slope breakpoint, place the cable barrier as far from the edge of traveled way as practicable. Provide a minimum placement distance of 8 feet to the edge of traveled way to allow vehicles to use this area for refuge (see [Exhibit 1610 13a](#)).
- For median shoulder applications, place the cable barrier as far from the edge of traveled way as practicable. Maintain a minimum of 8 feet of usable shoulder width between the edge of traveled way and the face of the cable barrier system (see [Exhibit 1610 13a](#)).

Note: [Exhibit 1610-13a](#) shows typical median placement criteria for single runs of cable barrier. Additional placement cases are shown in the WSDOT [Standard Plans](#). For non-typical installations, such as double runs of cable barrier or median ditch cross sections that differ significantly from those shown, contact the HQ Design Office for guidance.

- In some situations with cable barrier installations in medians, it is advantageous to terminate a run on one side of the median and begin an adjacent run on the opposite side. In this type of application, it is important to provide adequate cable barrier over-lap distance between the two runs. For placement guidance, see [Exhibit 1610-13c](#).

Narrow medians provide little space for maintenance crews to repair or reposition the barrier. Wherever site conditions permit, provide at least 14 feet of clearance from the adjacent lane edge to the cable barrier.

For typical non-median shoulder applications (see [Exhibit 1610-13b](#)), the following apply:

- Place the cable barrier as far from the edge of traveled way as practicable.
- For shoulder widths less than 8 feet, see [1610.05\(2\)](#) for further guidance.
- Install cable between slope breakpoints as shown in [Exhibit 1610-13b](#).
- Install cable barrier on slopes that are 6H:1V or flatter.
- Cable barrier can be installed up to 1 foot in front of slope breakpoints as steep as 2H:1V.

Note: There are approved high-tension cable barrier systems that can be placed on slopes as steep as 4H:1V. The use of these systems requires special placement considerations. Contact the HQ Design Office for guidance when selecting these systems.

1610.07(2) High-Tension Cable Barrier Deflection Distances

Depending on the system and post spacing, deflection distances for high-tension barrier systems may range from approximately 6 to 12 feet. Specify the maximum allowable deflection distance in the contract documents. (See Exhibits [1610-13a](#) and [13b](#) for placement details.)

Note: There are new high-tension cable barrier systems under development that may change selection and placement criteria. The HQ Design Office will circulate guidance on these new developments as they are adopted as WSDOT policy.

1610.07(3) **High-Tension Cable Barrier Termination**

- It is possible to terminate high-tension cable barrier systems by connecting directly to beam guardrail runs that are rigidly anchored (such as transitions to bridge rails) and also to a separate anchorage system. Designers should review field conditions, check local maintenance personnel needs, and then specify the required connection option in the contract documents. If a separate anchorage system is used, refer to [Exhibit 1610-13c](#) for placement guidance.
- When cable barrier is to be connected to a more rigid barrier, a transition section is typically needed. Contact the HQ Design Office for further details.

1610.07(4) **High-Tension Cable Barrier Height Criteria**

Select a high-tension four-cable barrier system with a height to the center of the top cable of not less than 35 inches and a height to the center of the bottom cable not greater than 19 inches.

1610.07(5) **High-Tension Cable Barrier Curb Placement**

Avoid the placement of curb in conjunction with high-tension cable barrier systems. Currently, there are no known acceptable cable barrier systems that have been successfully crash tested with this feature present.

Note: There are high-tension cable barrier systems under development that may change selection and placement criteria. The HQ Design Office will circulate guidance on these new developments as they are adopted as WSDOT policy.

1610.08 **Concrete Barrier**

General Considerations:

- Concrete barriers are rigid, rigid anchored, or unrestrained rigid systems. Commonly used in medians, they are also used as shoulder barriers. These systems are stiffer than beam guardrail or cable barrier, and impacts with these barriers tend to be more severe.
- Light standards mounted on top of concrete median barrier must not have breakaway features. (See the concrete barrier light standard section in the Standard Plans.)
- When concrete barrier is considered for use in areas where drainage and environmental issues (such as stormwater, wildlife, or endangered species) might be adversely impacted, contact the HQ Hydraulics Office and the appropriate environmental offices for guidance.

1610.08(1) **Concrete Barrier Shapes**

Concrete barriers use a single-slope or safety shape (New Jersey or F-Shape) to redirect vehicles while minimizing vehicle vaulting, rolling, and snagging. A comparison of these barrier shapes is shown in [Exhibit 1610-7](#).

The single-slope barrier face is the recommended option for embedded rigid concrete barrier applications.

Note: There are new precast concrete barrier systems under development that may change future selection and placement criteria. The HQ Design Office will circulate guidance on these new developments as they are adopted as WSDOT policy.

Exhibit 1610-7 Concrete Barrier Shapes

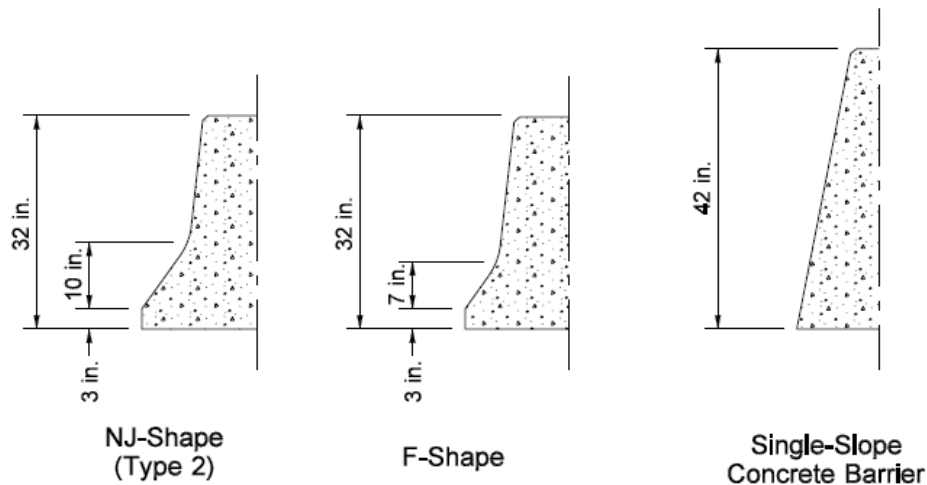

When the single-slope or F-Shape face is used on structures, and precast barrier is selected for use on the approaches, a cast-in-place transition section is needed so that no vertical edges of the barrier are exposed to oncoming traffic. For details on bridge rail designs, see the [Bridge Design Manual](#).

For aesthetic reasons, avoid changes in the shape of the barrier face within a project or corridor.

The New Jersey shape and F-shape barriers are commonly referred to as “safety shapes.” The New Jersey shape and F-shape have an initial overall height of 32 inches. This height includes provision for up to a 3-inch future pavement overlay that can reduce the barrier height to 29 inches minimum.

1610.08(1)(a) New Jersey Shape Barrier

The New Jersey shape face is primarily used on precast concrete barrier.

Concrete barrier Type 2 (see the [Standard Plans](#)) is a precast barrier that has the New Jersey shape on two sides and can be used for both median and shoulder installations.

The cost of precast Type 2 barrier is significantly less than the cost of the cast-in-place barriers. Therefore, consider the length of the barrier run and the deflection needs to determine whether transitioning to precast Type 2 barrier is desirable. If precast Type 2 barrier is used for the majority of a project, use the New Jersey face for small sections that need cast-in-place barrier, such as for a light standard section.

Concrete barrier Type 4 is also a precast, single-faced New Jersey shape barrier. These units are not freestanding and are to be placed against a rigid structure or anchored to the pavement. If Type 4 barriers are used back to back, consider filling any gap between them to prevent tipping.

Concrete barrier Type 5 is a precast barrier that has a single New Jersey face and is intended for use at bridge ends where the flat side is highly visible. Both Type 2 and Type 5 designs are freestanding, unanchored units connected with steel pins through wire rope loops. For permanent installation, this barrier is placed on a paved surface and a 2-foot-wide paved surface is provided beyond the barrier for its displacement during impact (see [Chapter 1230](#)).

Precast barrier can be anchored where a more rigid barrier is needed. (Anchoring methods are shown in the [Standard Plans](#).) The Type 1 and Type 2 anchors are for temporary installations on a rigid pavement. Type 3 anchors can be used in temporary or permanent installations on an asphalt pavement. Consult the HQ Bridge and Structures Office for details when anchoring permanent precast concrete barrier to a rigid pavement.

Precast barrier used on the approach to bridge rail is to be connected to the bridge rail by installing wire rope loops embedded 1 foot 3 inches into the bridge rail with epoxy resin.

Place unrestrained (unanchored) precast concrete barrier on foundation slopes of 5% or flatter. In difficult situations, a maximum slope of 8% may be used. Keep the slope of the area between the edge of the shoulder and the face of the traffic barrier as flat as possible. The maximum slope is 10H:1V (10%).

1610.08(1)(b) Single-Slope Barrier

The single-slope concrete barrier can be cast in place, slipformed, or precast. The most common construction technique for this barrier has been slipforming, but some precast single-slope barrier has been installed. The primary benefit of using precast single-slope barrier is that it can be used as temporary barrier during construction and then reset into a permanent location. In temporary applications, the single-slope barrier may also offer the added benefits of reducing headlight glare and providing reduced deflection characteristics over some other barrier types.

Single-slope barrier is considered a rigid system regardless of the construction method used. For new installations, the minimum height of the barrier above the roadway is 2 feet 10 inches, which allows a 2-inch tolerance for future overlays. The minimum total height of the barrier section is 3 feet 6 inches, with a minimum of 3 inches embedded in the roadway wearing surface. This allows for use of the 3-foot-6-inch barrier between roadways with grade separations of up to 5 inches. A grade separation of up to 10 inches is allowed when using a 4-foot-6-inch barrier section, as shown in the [Standard Plans](#). The barrier is to have a depth of embedment equal to or greater than the grade separation. Contact the HQ Bridge and Structures Office for grade separations greater than 10 inches.

1610.08(1)(c) Low-Profile Barrier

Low-profile barrier designs are available for median applications where the posted speed is 45 mph or below. These barriers are normally used in urban areas. They are typically 18 to 20 inches high and offer sight distance benefits. For barrier designs, terminals, and further details, contact the HQ Design Office.

1610.08(2) High-Performance Concrete Barrier

High-Performance Concrete Barrier (HP Barrier) is a rigid barrier with a minimum height of 42 inches above the roadway surface. This barrier is designed to function more effectively during heavy-vehicle [crashes](#). This taller barrier may also offer the added benefits of reducing headlight glare and reducing noise in surrounding environments. HP Barrier is generally considered single-slope barrier. (See the [Standard Plans](#) for barrier details.) For additional available shapes, contact the HQ Design Office.

For new/reconstruction, use HP Barrier in freeway medians of 22 feet or less. Also, use HP Barrier on Interstate or freeway routes where accident history suggests a need or where roadway

geometrics increase the possibility of larger trucks hitting the barrier at a high angle (for example, on-ramps for freeway-to-freeway connections with sharp curvature in the alignment).

Consider the use of HP Barrier at other locations such as nonfreeway narrow medians, near highly sensitive environmental areas, near densely populated areas, over or near mass transit facilities, or on vertically divided highways.

1610.08(3) Concrete Barrier Terminals

Whenever possible, bury the end of the concrete barrier in the backslope. The backslope needed to bury the end is to be 3H:1V or steeper and at least 4 feet in height above the roadway. Flare the concrete barrier into the backslope using a flare rate that meets the criteria in [1610.05\(4\)](#). Provide a 10H:1V or flatter foreslope into the face of the barrier and maintain the full barrier height to the foreslope/backslope intersection. This might create the need to fill ditches and install culverts in front of the barrier face.

The 7-foot-long precast concrete terminal end section for concrete barrier Type 2 and the 10- to 12-foot single-slope barrier terminal may be used:

- Outside the Design Clear Zone.
- On the trailing end of the barrier when it is outside the Design Clear Zone for opposing traffic.
- On the trailing end of one-way traffic.
- Where the posted speed is 25 mph or below.

Another available end treatment for Type 2 barriers is a precast or cast-in-place tapered terminal section with a minimum length of 48 feet and a maximum length of 80 feet. It is used infrequently for special applications and is designed to be used for posted speeds of 35 mph or below. For details, contact the HQ Design Office or refer to the Plan Sheet Library:

www.wsdot.wa.gov/design/standards/plansheet/

Replace existing sloped-down concrete terminals that are within the Design Clear Zone when they do not meet the above criteria.

When the end of a concrete barrier cannot be buried in a backslope or terminated as described above, terminate the barrier using a guardrail terminal and transition or an impact attenuator (see [Chapter 1620](#)).

1610.08(4) Assessing Impacts to Wildlife

The placement of concrete barriers in locations where wildlife frequently cross the highway can influence traffic safety and wildlife mortality. When wildlife encounter physical barriers that are difficult to cross, they often travel parallel to those barriers. With traffic barriers, this means that they often remain on the highway for a longer period, increasing the risk of wildlife/vehicle crashes or vehicle/vehicle crashes as motorists attempt avoidance.

Traffic-related wildlife mortality may play a role in the decline of some species listed under the Endangered Species Act. To address public safety and wildlife concerns, see [Exhibit 1610-8](#) to assess whether concrete barrier placement needs to have an evaluation by the HQ Environmental Services Office to determine its effect on wildlife. Conduct this evaluation early in the project development process to allow adequate time for discussion of options.

Exhibit 1610-8 Concrete Barrier Placement Guidance: Assessing Impacts to Wildlife

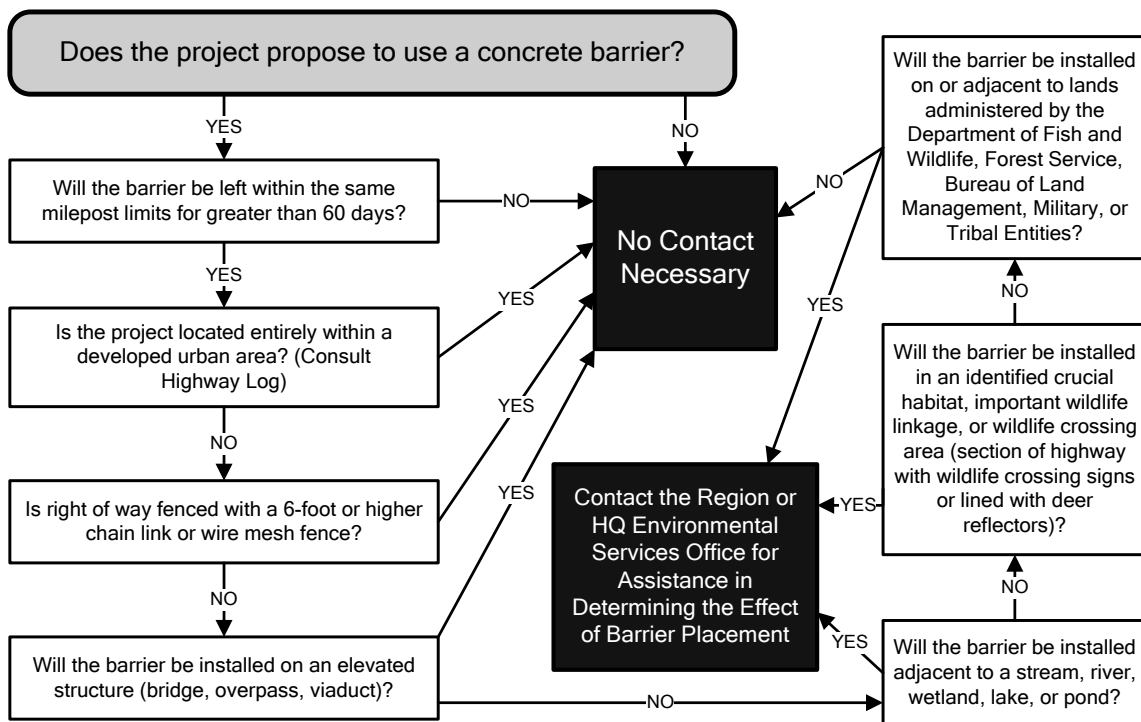

1610.08(5) Assessing Impacts to Stormwater and Wetlands

In locations where medians or roadsides are used for drainage, the retention of stormwater or the existence of wetlands can influence the choice and use of barrier systems. For example, the placement of concrete barrier and beam guardrail in many of these cases may create the need for additional impervious material, which can result in complete retrofit and reconstruction of the existing systems. When water is drained, stored, or treated, and where wetlands exist, the ability to provide alternative facilities that replace the functions of the existing ones may be nonexistent or prohibitively expensive to provide elsewhere.

To address public safety, stormwater, and wetland concerns, assess whether concrete barrier or beam guardrail placement will cause the need for an evaluation by the HQ Environmental Services Office. Conduct this evaluation early in the project development process to allow adequate time for discussion of options.

1610.09 Special-Use Barriers

The following barriers may be used on designated Scenic Byway and Heritage Tour routes if funding can be arranged (see 1610.05).

1610.09(1) Steel-Backed Timber Guardrail

Steel-backed timber guardrails consist of a timber rail with a steel plate attached to the back to increase its tensile strength. There are several variations of this system that have passed crash tests. The nonproprietary systems use a beam with a rectangular cross section that is supported by either wood or steel posts. A proprietary (patented) system called the Ironwood Guardrail is

also available. This system uses a beam with a round cross section and is supported by steel posts with a wood covering to give the appearance of an all-wood system from the roadway.

The Ironwood Guardrail can be allowed as an alternative to the nonproprietary system. However, specifying this system exclusively needs approval by an Assistant State Design Engineer of a public interest finding for the use of a sole source proprietary item.

The most desirable method of terminating the steel-backed timber guardrail is to bury the end in a backslope, as described in [1610.06\(4\)](#). When this type of terminal is not possible, use of the barrier is limited to highways with a posted speed of 45 mph or below. On these lower-speed highways, the barriers can be flared away from the traveled way and terminated in a berm outside the Design Clear Zone.

For details on these systems, contact the HQ Design Office.

1610.09(2) Stone Guardwalls

Stone guardwalls function like rigid concrete barriers but have the appearance of natural stone. These walls can be constructed of stone masonry over a reinforced concrete core wall or of simulated stone concrete. These types of barriers are designed to have a limited projection of the stones to help aid in the redirection characteristics of the barrier. The most desirable method of terminating this barrier is to bury the end in a backslope, as described in [1610.08\(3\)](#). When this type of terminal is not possible, use of the barrier is limited to highways with a posted speed of 45 mph or below. On these lower-speed highways, the barrier can be flared away from the traveled way and terminated in a berm outside the Design Clear Zone.

For details on these systems, contact the HQ Design Office.

1610.10 Bridge Traffic Barriers

Bridge traffic barriers redirect errant vehicles and help to keep them from going over the side of the structure. (See the [Bridge Design Manual](#) for information regarding bridge barrier on new bridges and replacement bridge barrier on existing bridges.)

For new bridge rail installations, use a 2-foot-10-inch-high single-slope or a 2 foot-8-inch-high safety shape (F Shape) bridge barrier. A transition is available to connect the New Jersey shape (Type 2 concrete barrier) and the F-Shape bridge barrier. (See the [Standard Plans](#) for further details.)

Use taller 3-foot-6-inch single-slope or safety shape bridge barriers on Interstate or freeway routes where accident history suggests a need or where taller barrier is required on approaching roadways with narrow medians, as defined in [1610.08\(2\)](#). Also, consider taller 3-foot-6-inch barrier when geometrics increase the possibility of larger trucks hitting the barrier at a high angle (such as on-ramps for freeway-to-freeway connections with sharp curvature in the alignment).

For further guidance on bridges where high volumes of pedestrian traffic are anticipated, see Chapters [720](#), [1510](#), [1515](#), and [1520](#).

Approach barriers, transitions, and connections are usually needed on all four corners of bridges carrying two-way traffic and on both corners of the approach end for one-way traffic. (See [1610.06\(5\)](#) for guidance on transitions.)

If the bridge barrier system does not meet the criteria for strength and geometrics, modifications to improve its redirection characteristics and its strength may be needed. The modifications can be made using one of the retrofit methods described in [1610.10\(1\)](#) and [1610.10\(2\)](#).

1610.10(1) Concrete Safety Shape

Retrofitting with a new concrete bridge barrier is costly and needs to have justification when no widening is proposed. Consult the HQ Bridge and Structures Office for design details and to determine whether the existing bridge deck and other superstructure elements are of sufficient strength to accommodate this bridge barrier system.

1610.10(2) Thrie Beam Retrofit

Retrofitting with thrie beam is an economical way to improve the strength and redirection performance of bridge barriers. The thrie beam can be mounted to steel posts or the existing bridge barrier, depending on the structural adequacy of the bridge deck, the existing bridge barrier type, the width of curb (if any), and the curb-to-curb roadway width carried across the structure.

The HQ Bridge and Structures Office is responsible for the design of thrie beam bridge barrier. [Exhibit 1610-14](#) shows typical retrofit criteria. Contact the HQ Bridge and Structures Office for assistance with thrie beam retrofit design.

Consider the Service Level 1 (SL-1) system on bridges with wooden decks and for bridges with concrete decks that do not have the needed strength to accommodate the thrie beam system. Contact the HQ Bridge and Structures Office for information needed for the design of the SL-1 system.

If a thrie beam retrofit results in reduction in sidewalk width see [Chapter 1510](#).

The funding source for retrofit of existing bridge rail is dependent on the length of the structure. Bridge rail retrofit, for bridges less than 250 feet in length, or a total bridge rail length of 500 feet, is funded by the project (Guardrail Preservation or Improvement). For longer bridges, the retrofit will be included in the I-2 Bridge Rail upgrades program. Contact the HQ Program Development Office to determine whether funding is available.

1610.11 Other Barriers

1610.11(1) Dragnet

The Dragnet Vehicle Arresting Barrier consists of chain link or fiber net that is attached to energy absorbing units. When a vehicle hits the system, the Dragnet brings the vehicle to a controlled stop with limited damage. Possible uses for this device include the following:

- Reversible lane entrances and exits
- Railroad crossings
- Truck escape ramps (instead of arrester beds—see [Chapter 1270](#))
- T-intersections
- Work zones
- Swing span bridges

For permanent installations, this system can be installed between towers that lower the unit into position when needed and lift it out of the way when it is no longer needed. For work zone applications, it is critical to provide deflection space for stopping the vehicle between the system and the work zone. For additional information on the Dragnet, contact the HQ Design Office.

1610.12 Documentation

Refer to [Chapter 300](#) for design documentation requirements.

Exhibit 1610-9 Transitions and Connections

Connecting W-Beam Guardrail to: Transitions and Connections		Transition Type*	Connection	
Bridge Rail	New Installation	20, 21	D	
	Existing Concrete	Concrete Parapet > 20 inches	20, 21, 4 ^[4]	Exhibit 1610-6 ^[6]
		Concrete Parapet < 20 inches	20, 21, 2, 4 ^[4]	Exhibit 1610-6 ^[6]
		Existing W-Beam Transition	2 ^{[1][5]} , 4 ^[4]	[1]
	Thrie Beam at Face of Curb ^[3]	Approach End	23	n/a
		Trailing End (two-way traffic only)	23	n/a
	Thrie Beam at Bridge Rail (curb exposed) ^[3]	Approach End	22	n/a
		Trailing End (two-way traffic only)	22	n/a
	Weak Post Intersection Design (see 1610.06(6)(b), Cases 12 & 13)		5	Exhibit 1610-6
	Concrete Barrier	Rigid & Rigid Anchored	21	Exhibit 1610-6
Unrestrained		21, 2, 4 ^[4]	A	
Weak Post Barrier Systems (Type 20 and 21)		6	n/a	
Rigid Structures such as Bridge Piers	New Installation (see Cases 11–31)	21	n/a	
	Existing W-Beam Transition	[2]	n/a	
Connecting Thrie Beam Guardrail to:		Transition Type*	Connection	
Bridge Rail or Concrete Barrier	New Installation (example: used with thrie beam bull nose)	1B	Exhibit 1610-6	

*Consult Section C of the *Standard Plans* for details on transition types.

Notes:

- [1] If work creates the need for reconstruction or resetting of the transition, upgrade as shown above. Raising the guardrail is not considered reconstruction. If the transition is not being reconstructed, the existing connection may remain in place. When Type 3 anchors are encountered, see 1610.06(4)(e) for guidance.
- [2] For new/reconstruction, use Case 11 (thrie beam). For existing Case 11 with W-beam, add a second W beam rail element.
- [3] For Service Level 1 bridge rail, see 1610.06(6)(b), Case 14.
- [4] Use on highways with speeds 45 mph or below.
- [5] If existing transition has the needed guardrail height—three 10" x 10" (nominal) posts and three 6" x 8" (nominal) posts spaced 3'-1.5" apart—it is acceptable to nest existing single W-beam element transitions.
- [6] When connecting a Type 20 or Type 21 Transition to an existing bridge rail, a special connection plate may be required. Contact the WSDOT Bridge and Structures Office for details.

Exhibit 1610-10a Barrier Length of Need on Tangent Sections

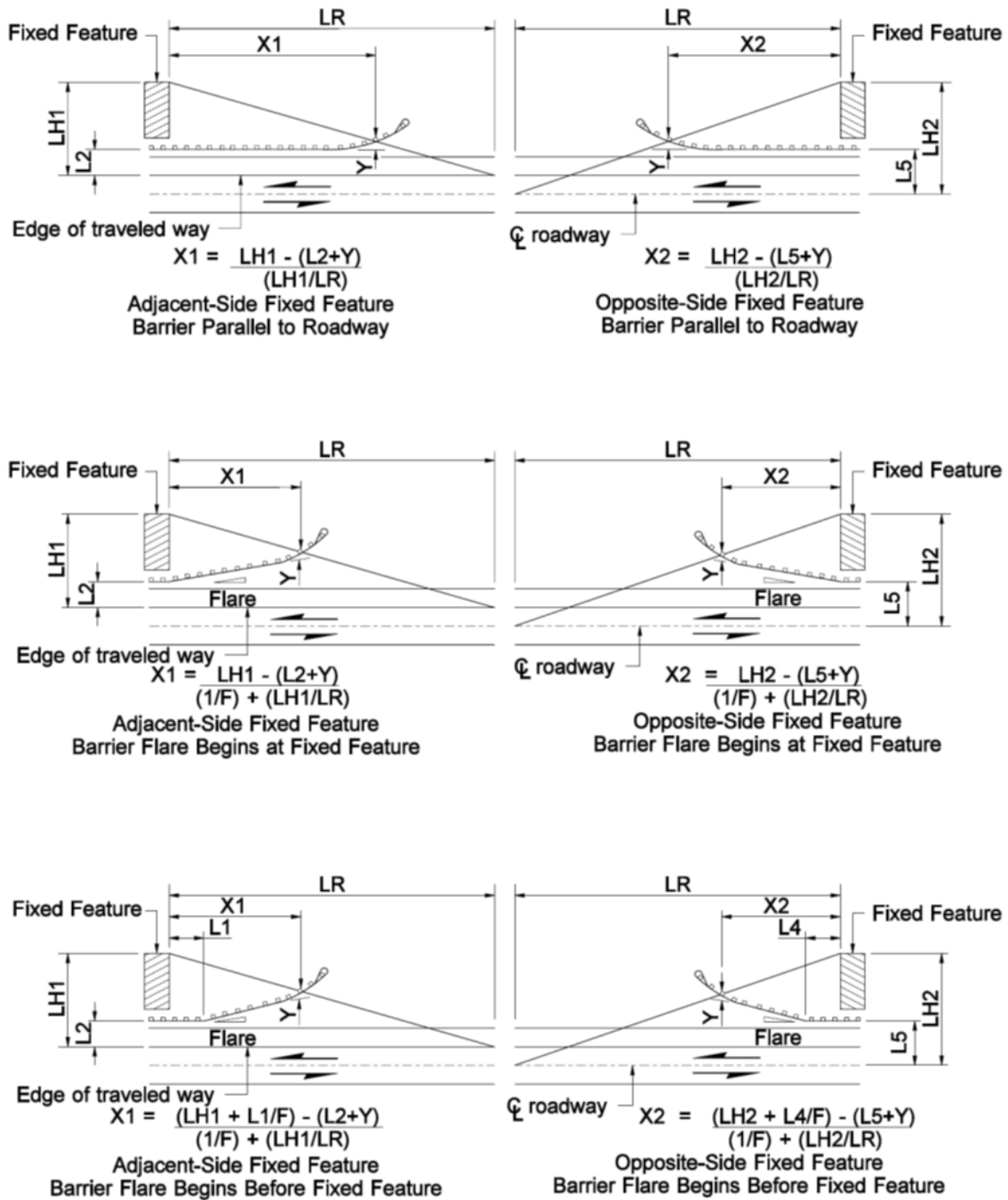

Note:

For supporting length of need equation factors, see [Exhibit 1610-10b](#).

Exhibit 1610-10b Barrier Length of Need

Posted Speed (mph)	Design Parameters						
	ADT				Barrier Type		
	Over 10,000	5,000 to 10,000	1,000 to 4,999	Under 1,000	Rigid & Rigid Anchored Barrier	Rigid Unrestrained Barrier	Semirigid Barrier
	LR (ft)	LR (ft)	LR (ft)	LR (ft)	F	F	F
70	360	330	290	250	20	18	15
65	330	290	250	225	20	18	15
60	300	250	210	200	18	16	14
55	265	220	185	175	16	14	12
50	230	190	160	150	14	12	11
45	195	160	135	125	12	11	10
40	160	130	110	100	11	10	9
35	135	110	95	85	11	10	9
30	110	90	80	70	11	10	9
25	110	90	80	70	11	10	9

L1 = Length of barrier parallel to roadway from adjacent-side fixed feature to beginning of barrier flare. This is used if a portion of the barrier cannot be flared (such as a bridge rail and the transition).

L2 = Distance from adjacent edge of traveled way to portion of barrier parallel to roadway.

L4 = Length of barrier parallel to roadway from opposite-side fixed feature to beginning of barrier flare.

L5 = Distance from centerline of roadway to portion of barrier parallel to roadway. **Note:** If the fixed feature is outside the Design Clear Zone when measured from the centerline, it may only be necessary to provide a crash-tested end treatment for the barrier.

LH1 = Distance from outside edge of traveled way to back side of adjacent-side fixed feature. **Note:** If a fixed feature extends past the Design Clear Zone, the Design Clear Zone can be used as LH1.

LH2 = Distance from centerline of roadway to back side of opposite-side fixed feature. **Note:** If a fixed feature extends past the Design Clear Zone, the Design Clear Zone can be used as LH2.

LR = Runout length, measured parallel to roadway.

X1 = Length of need for barrier to shield an adjacent-side fixed feature.

X2 = Length of need for barrier to shield an opposite-side fixed feature.

F = Flare rate value.

Y = Offset distance needed at the beginning of the length of need.

Different end treatments need different offsets:

- For the SRT 350 and FLEAT 350, use Y = 1.8 feet.
- For evaluating existing BCTs, use Y = 1.8 feet.
- For the FLEAT TL-2, use Y = 0.8 feet.
- No offset is needed for the nonflared terminals or impact attenuator systems. Use Y = 0.

Exhibit 1610-10c Barrier Length of Need on Curves

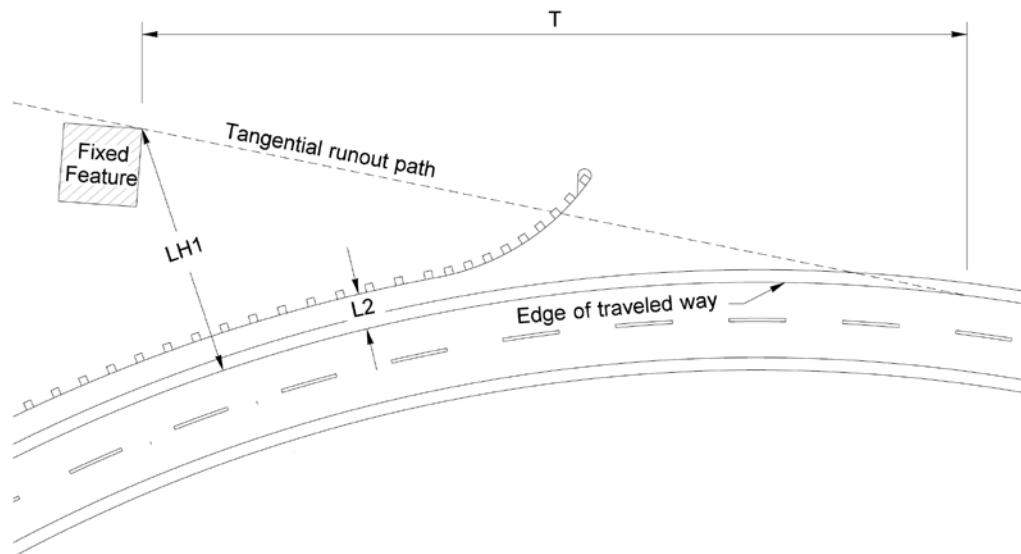
**Notes:**

- This is a graphical method for determining the length of need for barrier on the outside of a curve.
- On a scale drawing, draw a tangent from the curve to the back of the fixed feature. Compare T to LR from [Exhibit 1610-10b](#) and use the shorter value.
- If using LR, follow Exhibits [1610-10a](#) and [10b](#).
- If using T, draw the intersecting barrier run to scale and measure the length of need.

Exhibit 1610-10d W-Beam Guardrail Trailing End Placement for Divided Highways

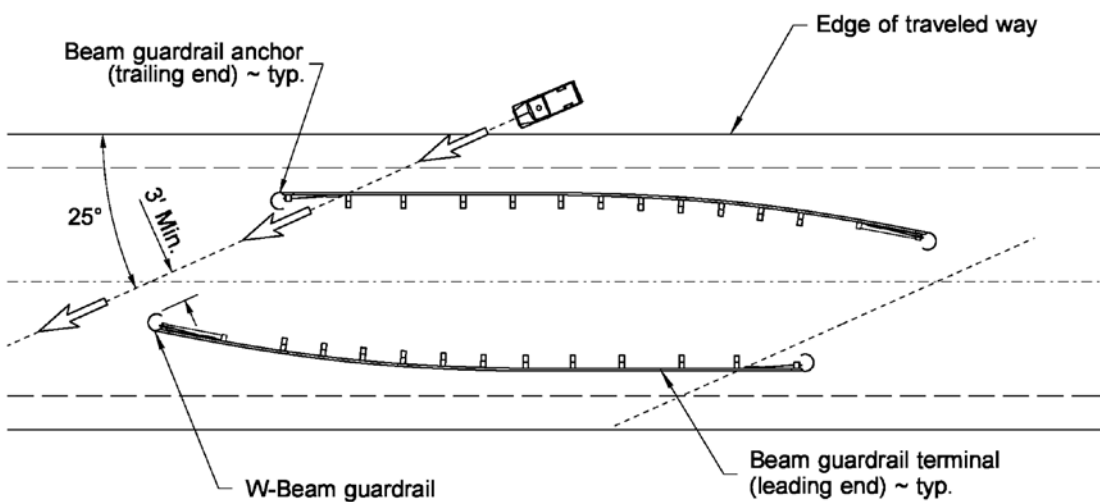
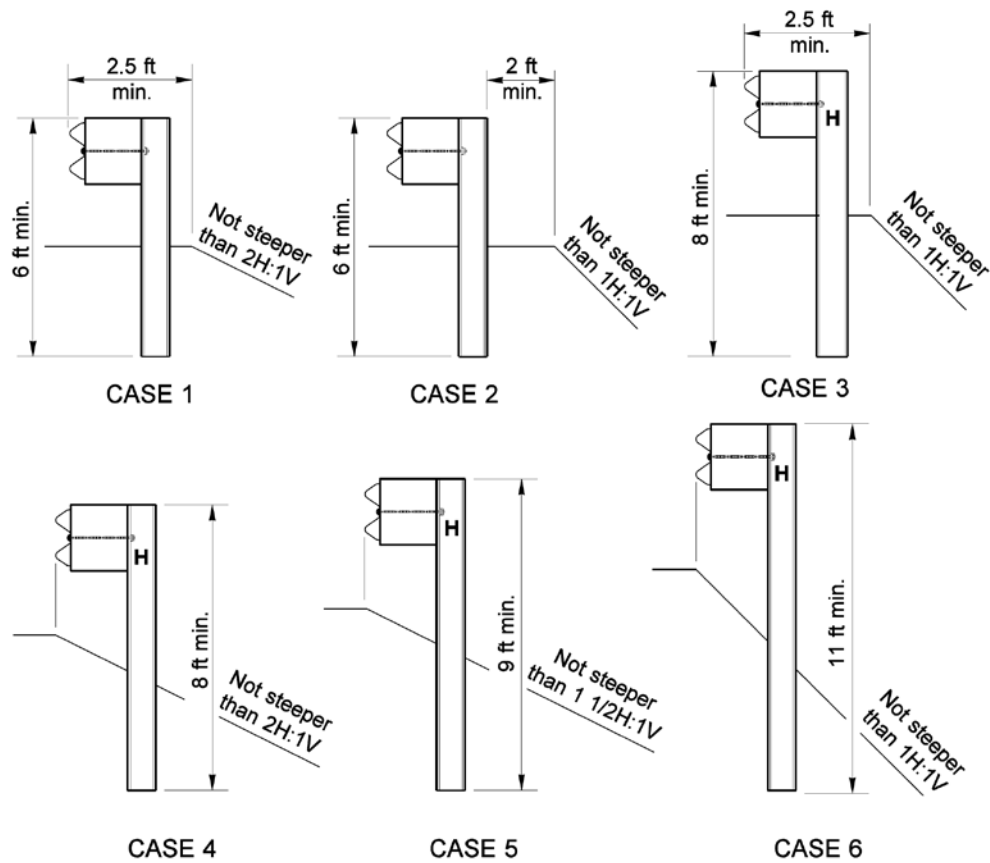

Exhibit 1610-11 Beam Guardrail Post Installation



Type 31 Shown

Notes:

- Use Cases 1 and 3 when there is a 2.5-foot or greater shoulder widening from face of guardrail to the breakpoint.
- Use Case 2 when there is a 4.0-foot or greater shoulder widening from the face of the guardrail to the breakpoint.
- Use Cases 4, 5, and 6 when there is less than a 2.5-foot shoulder widening from face of guardrail to the breakpoint.

Exhibit 1610-12a Beam Guardrail Terminals

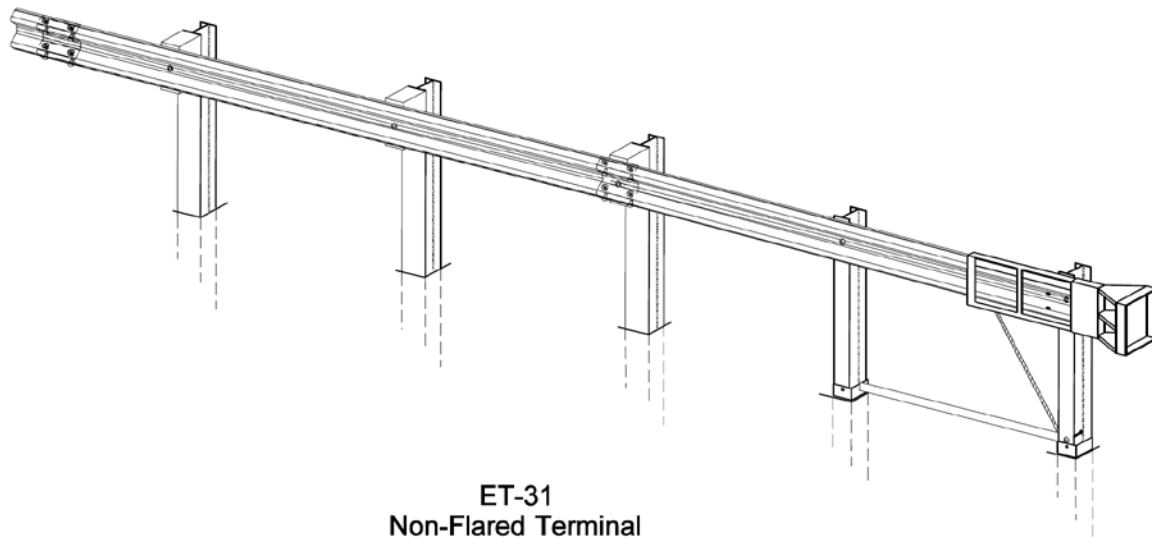
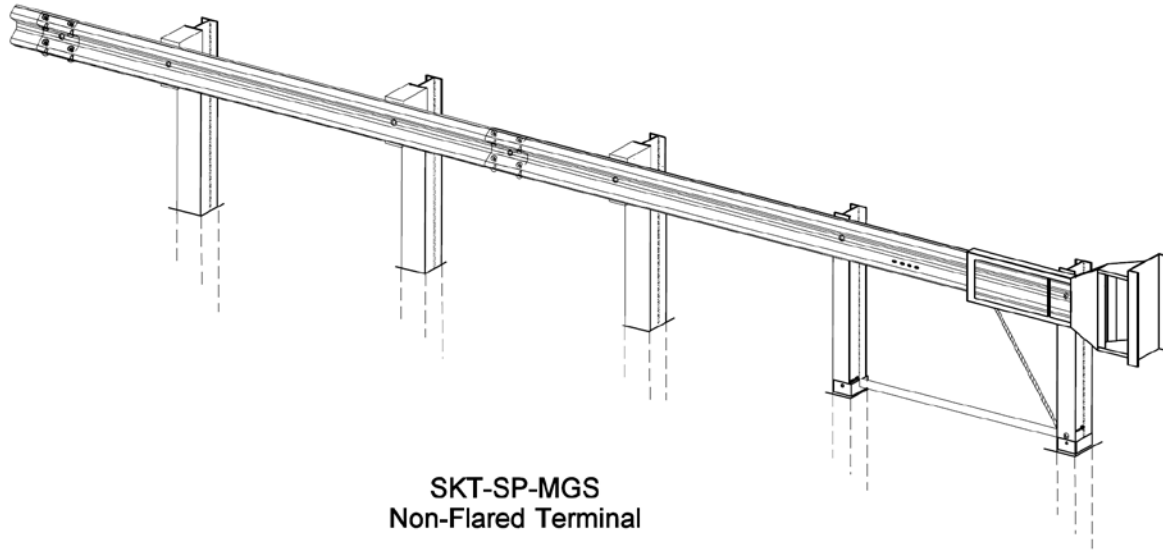

Exhibit 1610-12b Beam Guardrail Terminals

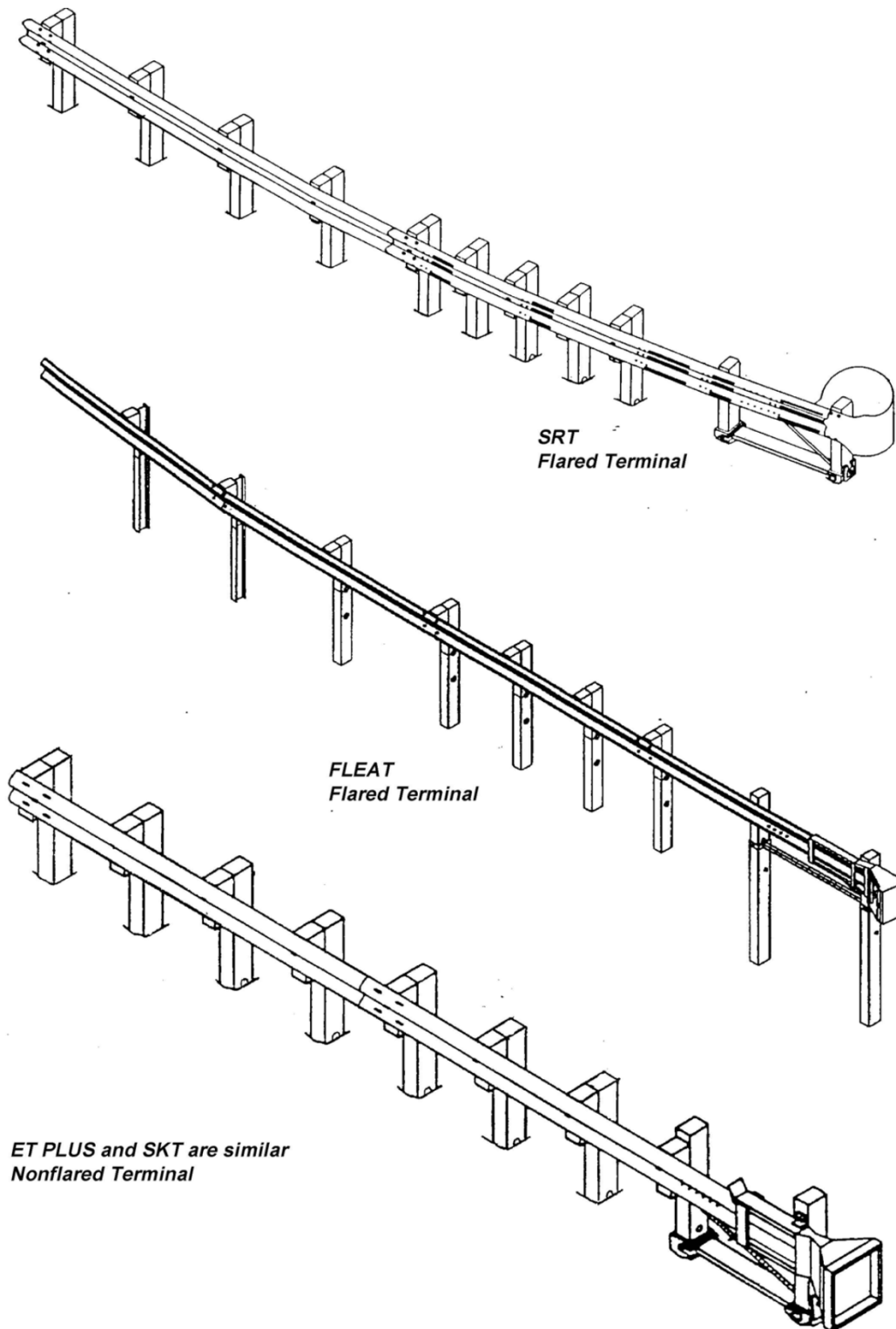
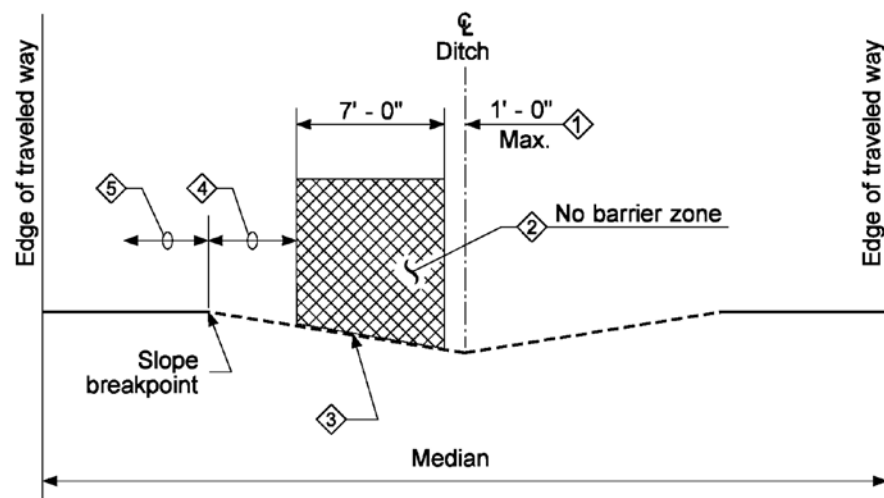
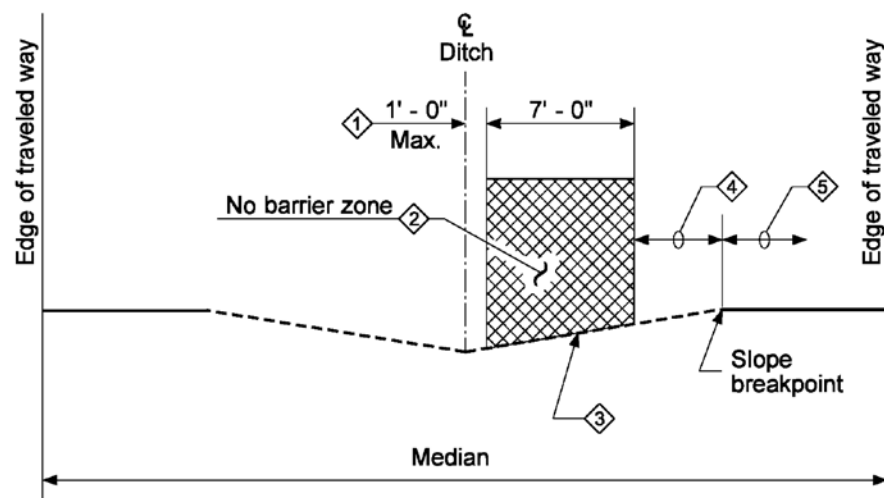

Exhibit 1610-13a Single Cable Barrier Placement Locations on Median Slopes



Median Placement - Left



Median Placement - Right

Notes:

- ① Cable barrier may be installed in the center of the ditch and from the ditch centerline a maximum of 1 foot (left or right).
- ② Avoid installing cable barrier within a 1-foot to 8-foot offset from the ditch centerline.
- ③ Applies to slopes between 10H:1V and 6H:1V.
- ④ Slope Installation: Install cable barrier between an 8-foot offset from the ditch centerline and the slope breakpoint. Provide a maximum deflection distance of 8 feet to the edge of traveled way.
- ⑤ Shoulder Installation: For median shoulder applications, maintain a minimum of 8 feet of usable shoulder width between the edge of traveled way and the face of the cable barrier system.

Exhibit 1610-13b Cable Barrier Locations on Shoulder Slopes

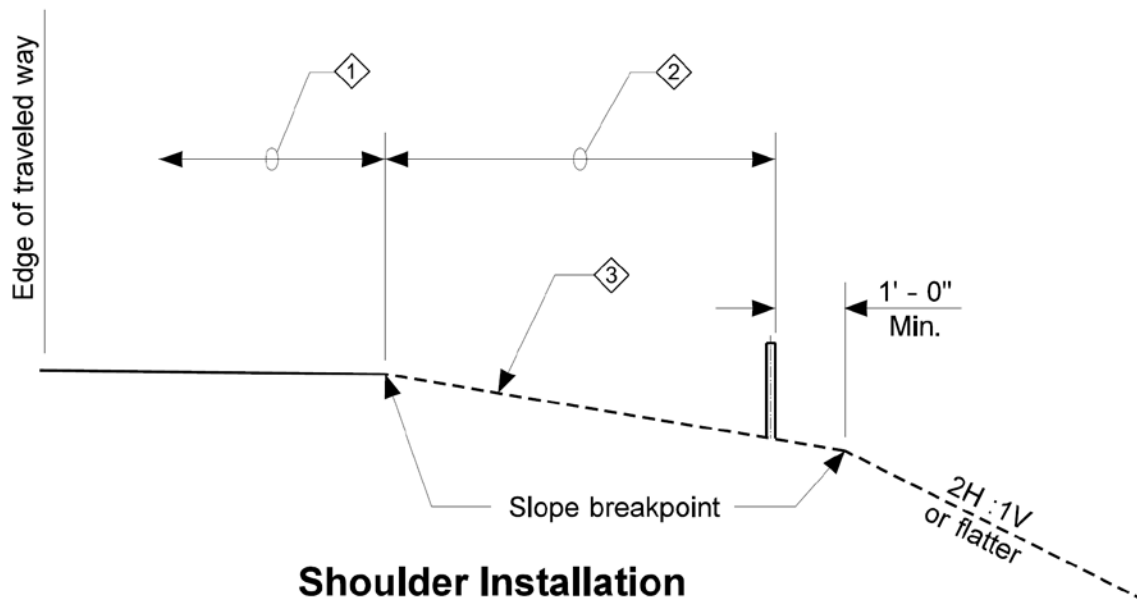
**Notes:**

- 1 For shoulder widths less than 8 feet, see [1610.05\(2\)](#) for further guidance.
- 2 Slope Installation: Install cable barrier relative to the slope breakpoints within the limits shown.
- 3 Applies to slopes that are 6H:1V or flatter.

Exhibit 1610-13c Cable Barrier Placement for Divided Highways

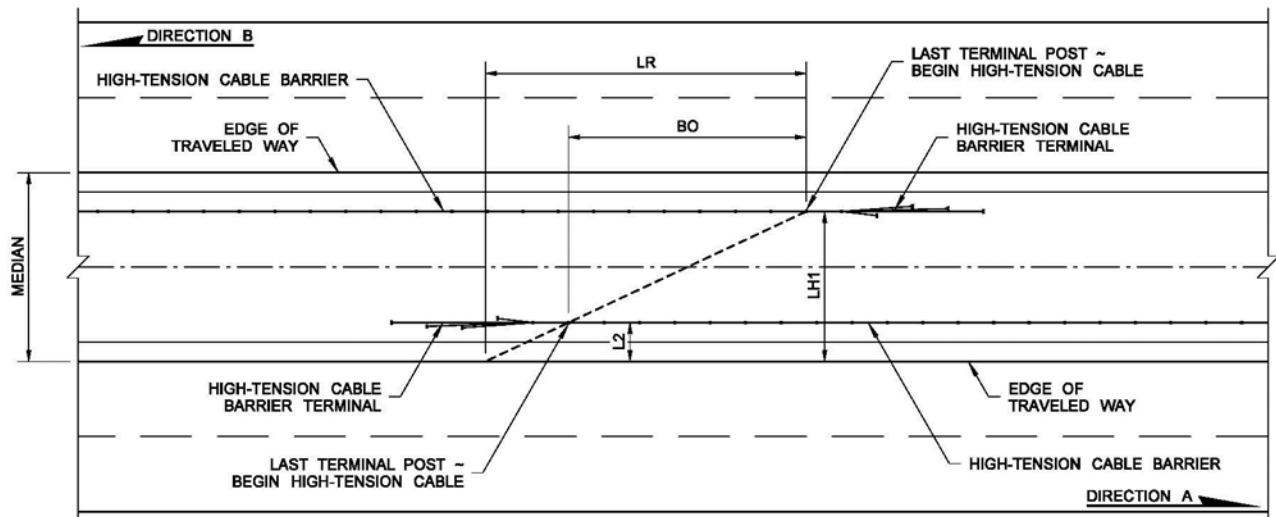

Cable Barrier Median Overlap

$$BO = \frac{LH1 - L2}{LH1/LR} \quad (\text{Direction A shown})$$

Note:

Calculate barrier overlap (BO) from both directions of travel. Use the greatest value of BO obtained.

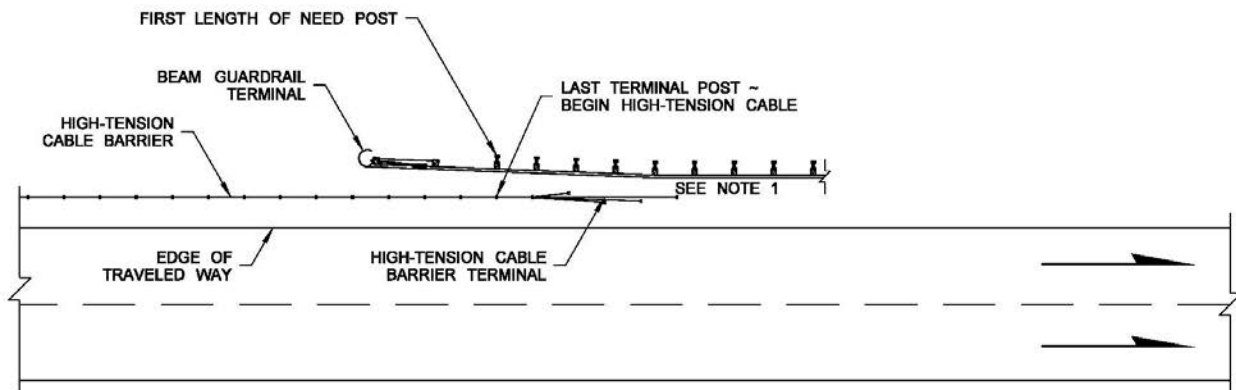

Cable Barrier Overlap With Beam Guardrails

Notes:

- [1] The beam guardrail may need to be extended and flared to maintain adequate barrier overlap and shoulder width.
- [2] Typical applications may be at bridge transitions or where high-tension cable and beam guardrail systems end or begin.
- [3] For supporting length of need equation factors, see [Exhibit 1610-10b](#).

Exhibit 1610-14 Thrie Beam Rail Retrofit Criteria

Curb Width	Bridge Width	Concrete Bridge Deck		Wood Bridge Deck or Low-Strength Concrete Deck
		Concrete Bridge Rail (existing)	Steel or Wood Post Bridge Rail (existing)	
<18 inches		Thrie beam mounted to existing bridge rail ^[2] and blocked out to the face of curb. Height = 32 inches	Thrie beam mounted to steel posts ^[2] at the face of curb. Height = 32 inches	<ul style="list-style-type: none"> • Service Level 1 Bridge Rail^[2] • Height = 32 inches
>18 inches	> 28 ft (curb to curb)	Thrie beam mounted to steel posts ^[2] at the face of curb. ^[1] Height = 32 inches		<ul style="list-style-type: none"> • Curb or wheel guard needs to be removed
>18 inches	< 28 ft (curb to curb)	Thrie beam mounted to existing bridge rail. ^[2] Height = 35 inches	Thrie beam mounted to steel posts ^[2] in line with existing rail. Height = 35 inches	

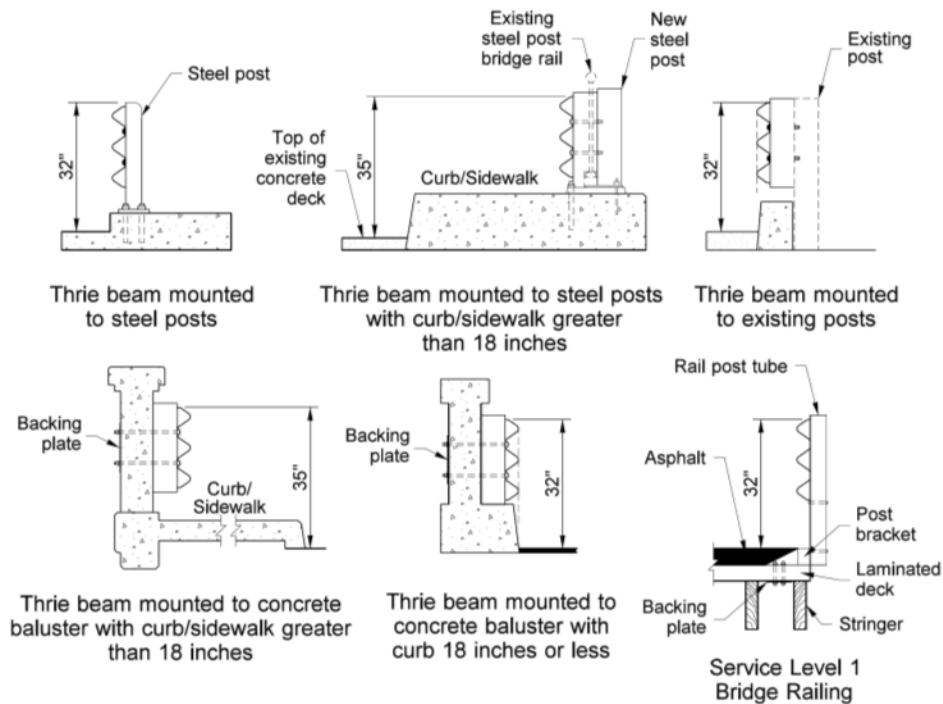

Notes:

[1] To maximize available curb/sidewalk width for pedestrian use, thrie beam may be mounted to the bridge rail at a height of 35 inches.

[2] Contact the HQ Bridge and Structures Office for design details on bridge rail retrofit projects.

- 1620.01 General
- 1620.02 Design Criteria
- 1620.03 Selection
- 1620.04 Impact Attenuator Systems
- 1620.05 Documentation

1620.01 General

Impact attenuator systems are protective systems that help aid an errant vehicle from impacting an object by either gradually decelerating the vehicle to a stop when hit head-on or by redirecting it away from the feature when struck on the side. These systems are used for rigid objects or other features that cannot be removed, relocated, or made breakaway.

Approved systems are shown in Exhibits [1620-1a](#) and [1620-1b](#) and on the Washington State Department of Transportation (WSDOT) Headquarters (HQ) Design Office web page:

 www.wsdot.wa.gov/design/policy/roadsidesafety.htm

Approved systems shall meet standardized testing defined in National Cooperative Highway Research Program (NCHRP) Report 350 or the American Association of State Highway and Transportation Officials (AASHTO) *Manual for Assessing Safety Hardware* (MASH). In addition, these devices shall have an acceptance letter from FHWA that certifies that the device meets the appropriate crash test criteria and is eligible for federal-aid reimbursement.

1620.02 Design Criteria

The following design criteria apply to new, existing, or reset permanent and temporary impact attenuators.

Impact attenuators are placed so that they do not present a feature that needs mitigating in relation to opposing traffic. For median and reversible lane locations, the backup structure or attenuator-to-object connection is designed to help in aiding opposing traffic from being snagged.

Avoid placement of curbs between attenuators and traffic. Refer to the specific attenuator manufacturer's instructions if considering placement of curbing between an attenuator and the travelled way. It is desirable that existing curbing be removed and the surface smoothed with asphalt or cement concrete pavement before an impact attenuator is installed. However, mountable curbs 4 inches or less in height may be retained depending on the feasibility of their removal.

In general, attenuators are aligned parallel to the roadway except the inertial barriers.

Consult with the Area Maintenance Superintendent who will be maintaining the system prior to selecting the attenuator systems to include in a construction contract.

1620.03 Selection

To select an appropriate impact attenuator system, the following factors must be assessed:

- Posted speed
- Operating speed
- Average daily traffic (ADT)
- Repair crew exposure
- Proximity to the roadway
- Anticipated number of yearly impacts
- Available space (length and width)
- Maintenance costs
- Initial cost
- Duration (permanent or temporary use)
- Portion of the impact attenuator that is redirective/nonredirective (see [Exhibit 1620-2](#))
- Width of object to be shielded

It is very important for designers to take into account the portion of an impact attenuator that is designed to redirect vehicles during a side impact of the unit. It is crucial that fixed objects, either permanent or temporary (such as construction equipment), are not located behind the nonredirective portion of these devices.

The posted speed is a factor in the selection of many impact attenuators. Use Exhibits [1620-1a](#) and [1620-1b](#) to select the system and configuration appropriate for the posted speed. In the interest of a cost-effective design, selecting a system applicable for the posted speed is recommended (although using a system tested for a higher speed is acceptable). Where there is evidence that the average operating speed of the facility is higher than the posted speed, consider selecting an attenuator system rated at the facility's operating speed. Manufacturer's product information may indicate that a longer system (than what is in Exhibits [1620-1a](#) and [1620-1b](#)) is required for speeds of 70 mph or greater. These models are generally referred to as "high speed" or "70 mph" systems. Use of these systems on facilities with 70 mph posted speeds is not required, and selection of a system rated for at least 60 mph will typically be appropriate for most sites on these facilities. For permanent installations where unusual conditions warrant consideration of a high-speed device, these systems are available and may be used with justification. Contact the HQ Design Office for guidance when selecting one of these systems.

For a comparison summary of space and initial cost information related to impact attenuator systems, see Exhibits [1620-1a](#) and [1620-1b](#).

When maintenance costs are considered, anticipate the average annual impact rate. If few impacts are anticipated, lower-cost devices such as inertial barriers might meet the need. (See [Chapter 301](#) for examples of how to determine lifecycle costs for proposed hardware). Inertial barriers have the lowest initial cost and initial site preparation. However, maintenance will be costly and necessary after each impact. Labor and equipment are needed to clean up the debris and install new containers (barrels). Inertial barriers are not be used where flying debris might be a danger to pedestrians.

- 1720.01 General
- 1720.02 Definitions
- 1720.03 Planning, Development, and Responsibilities
- 1720.04 Permanent Facilities
- 1720.05 Portable Facilities
- 1720.06 Shoulder Sites
- 1720.07 Federal Participation
- 1720.08 Procedures
- 1720.09 Documentation

1720.01 General

Truck weighing facilities are needed to protect state highways from overweight vehicles, to provide for vehicle safety inspection, and to provide a source of data for planning and research. The development, construction, and maintenance of these facilities is a cooperative effort between the Washington State Department of Transportation (WSDOT) and the Washington State Patrol (WSP).

1720.02 Definitions

Note: For definitions of *roadway*, *traveled way*, *lane*, *median*, *outer separation*, *shoulder*, *decision sight distance*, *sight distance*, and *stopping sight distance*, see the [Glossary](#).

Commercial Vehicle Information Systems and Networks (CVISN) A network that links intelligent transportation systems (ITS) to share information on commercial vehicles. When in operation at a weigh site, it can enable commercial vehicles to clear the facility without stopping.

frontage road An auxiliary road that is a local road or street located beside a highway for service to abutting property and adjacent areas and for control of access.

static scale A scale that requires a vehicle to stop for weighing.

usable shoulder The width of the shoulder that can be used by a vehicle for stopping.

weigh in motion (WIM) A scale facility capable of weighing a vehicle without the vehicle stopping.

1720.03 Planning, Development, and Responsibilities

The WSP works with WSDOT Strategic Planning and Programming to develop a prioritized list of weigh facility needs for each biennium. The list includes:

- New permanent facilities.
- New portable facilities.
- New shoulder sites.
- WIM equipment.

- Vehicle inspection facilities.
- Scale approach slab reconstruction.

The WSP provides the Program Management Office of Strategic Planning and Programming a Project Definition, which includes:

- A statement of need, the purpose of the project, and the type of work.
- The general location of the project.

Program Management sends this information to the region for preparation of a Project Summary. The region works with the WSP to identify the specific location of the facility. The region then prepares a design decision estimate and submits it to Program Management.

The region negotiates and the Regional Administrator executes any formal agreements with the WSP required for the design, construction, or maintenance of vehicle weighing and inspection facilities.

The Memorandum of Understanding Related to Vehicle Weighing and Equipment: Inspection Facilities on State Highways, [Exhibit 1720-8](#), contains details about the various responsibilities of WSDOT and the WSP.

1720.04 Permanent Facilities

Permanent truck weighing facilities have permanent scales and may have buildings. When these facilities are in operation, trucks are required stop. However, when Weigh In Motion (WIM) and Commercial Vehicle Information Systems and Networks (CVISN) capabilities have been installed, the driver may be notified to continue without stopping. The notification to continue may be through the use of signs or transponders.

(1) Site Locations

The exact location of a truck weighing facility is generally controlled by topography, highway alignment, and geometrics. It is also desirable to select a site where adequate right of way is already available. Select the most economical site to minimize site preparation, expense, and impact on the environment. Water, electricity availability, and sewage treatment and disposal are other considerations for site selection. Additionally, use the following criteria:

- Locate the facility such that its operation will not hinder the operation of the highway or other related features such as intersections and interchanges.
- To the extent feasible, eliminate options for truck traffic to bypass the weigh site.
- Base the site selection on the type and volume of trucks using the route.

An interchange justification report is required for weigh sites on multilane divided highways with access control (see [Chapter 550](#)).

(2) Design Features

On multilane highways, provide off- and on-connections as shown in [Chapter 1360](#). [Exhibit 1720-1](#) is the minimal design of a weigh site on multilane highways.

Locate the weighing facility so that its operation will not hinder the operation of the highway or other related features such as intersections.

(2) Design Features

Shoulder sites are designed in coordination with the WSP. Input from the local WSP Commercial Vehicle Enforcement personnel will ensure the proposed site will meet their needs without over-building the facility. Obtain written concurrence from the WSP for the length, width, and taper rates before the design is finalized.

When the ADT is 1,500 or less, and with the written approval of the WSP, the tapers at small shoulder sites may be eliminated. The shoulders on either side of the site may be used as acceleration and deceleration lanes, whether or not they were designed for this use. Therefore, provide adequate strength to support truck traffic.

Hot mix asphalt is acceptable for use on all shoulder sites. Design the depth in accordance with the surfacing report. Design the shoulder pavement at this depth for a length not less than the deceleration lane length before, and the acceleration lane length after, the site (see [Chapter 1360](#)).

When the shoulders are designed to be used for deceleration and acceleration lanes, the minimum width is 12 feet with full pavement depth for the deceleration/acceleration lane lengths (see [Chapter 1360](#)).

Use a maximum 2% slope in order to optimize portable scale efficiency and facilitate drainage.

1720.07 Federal Participation

Federal funds appropriate to the system being improved may be used for the acquisition of right of way and the construction of truck weighing facilities and vehicle inspection facilities. This includes, but is not limited to, on- and off-ramps, deceleration/acceleration lanes, passing lanes, driveways, parking areas, scale approach slabs, vehicle inspection facilities, roadway illumination, and signing.

1720.08 Procedures

Prepare site plans for all truck weighing facilities that include:

- Class of highway and design speed for main line (see [Chapter 1103](#)).
- Curve data on main line and weigh site.
- Number of lanes and width of lanes and shoulders on main line and weigh site.
- Superelevation diagrams for the main line and weigh site.
- Stationing of ramp connections and channelization.
- Illumination.
- Signing.
- Water supply and sewage treatment.
- Roadside development.

Get WSP approval of the site plans before the final plan approval.

1720.09 Documentation

Refer to [Chapter 300](#) for design documentation requirements.

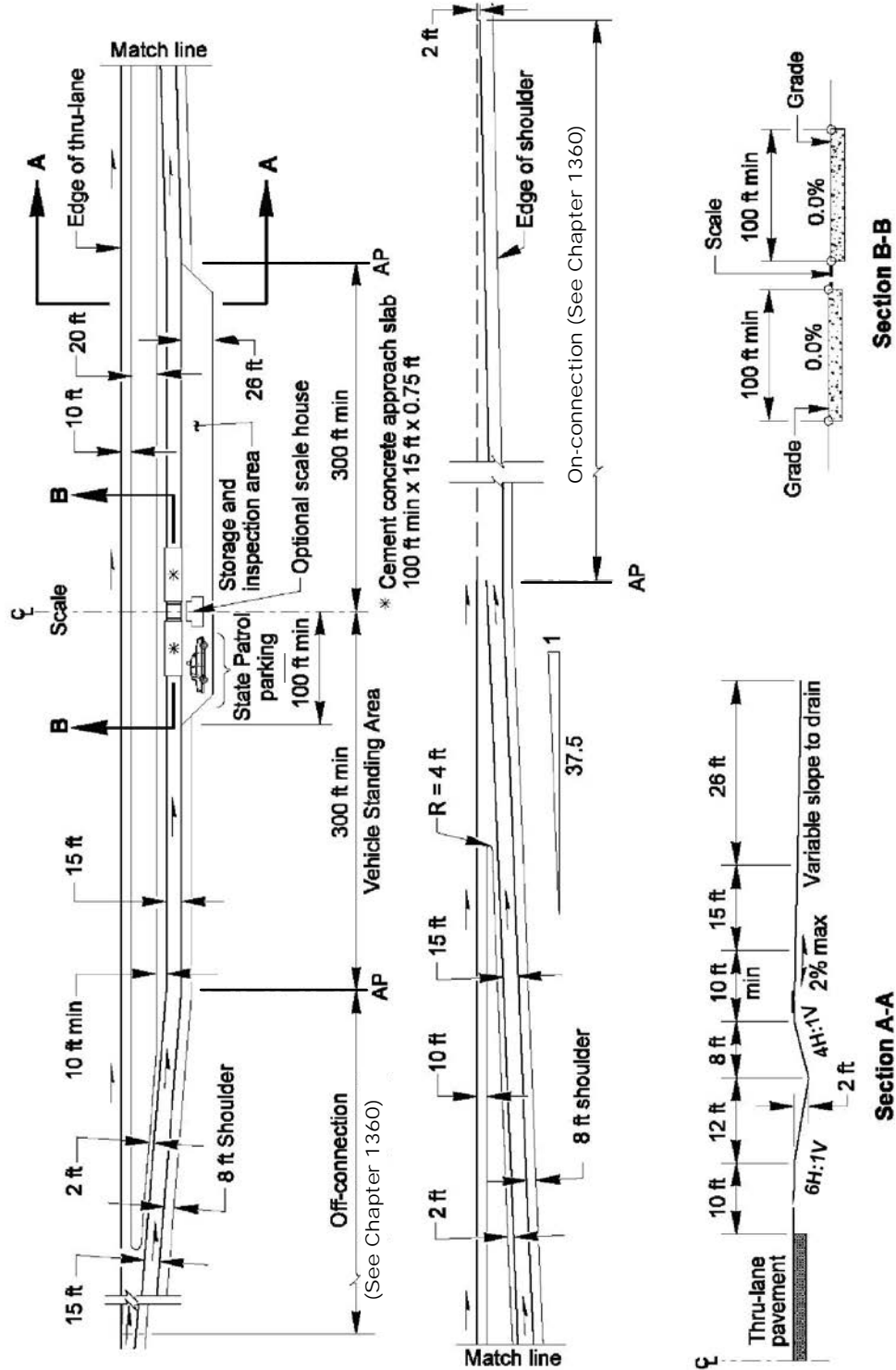

Truck Weigh Site: Multilane Highways
Exhibit 1720-1

[Acronyms](#)

[ADA / Pedestrian Terms](#)

[Main Glossary of Terms](#)

Acronyms

AADT	Annual average daily traffic	ICD	Inscribed circle diameter
ACT	Alternatives Comparison Table	IHSDM	Interactive Highway Safety Design Model
ADA	Americans with Disabilities Act of 1990	IJR	Interchange Justification Report
ADT	Annual daily traffic	ITS	Intelligent transportation systems
ALJ	Administrative law judge	L/A	Limited access
AOS	Apparent opening size	LOS	Level of service
APS	Accessible pedestrian signal	MAISA	Multi Agency, Interdisciplinary, and Stakeholder Advisory (Team)
AWDVTE	Average weekday vehicle trip ends	MEF	Maximum extent feasible
BAT	Business access transit	MOU	Memorandum of Understanding
B/C	Benefit / cost	MPO	Metropolitan Planning Organization
BLM	Bureau of Land Management	MTIP	Metropolitan Transportation Improvement Program
BOD	Basis of Design	MUTCD	Manual on Uniform Traffic Control Devices
BRT	Bus rapid transit	NEPA	National Environmental Policy Act
BST	Bituminous surface treatment	NHS	National Highway System
CAR	Collision Analysis Report	PAR	Pedestrian access route
CE	Categorical Exemption (SEPA)	PATS	Priority Array Tracking System
CE	Categorical Exclusion (NEPA)	PC&R	Project Control and Reporting
CFA	Contributing Factors Analysis	PCPH	Passenger cars per hour
CFR	Code of Federal Regulations	PE	Preliminary engineering
CIPP	Capital Improvement and Preservation Program	PF	Project File
CLB	Current Law Budget	PoDI	Project of Division Interest (FHWA)
CMP	Corridor Management Plan	PPH	Persons per hour
CPMS	Capital Program Management System	PS	Project Summary
CRT	Controlled releasing terminal post	PS&E	Plans, Specifications, and Estimates
CSS	Context sensitive solutions	RCW	Revised Code of Washington
CTR	Commute Trip Reduction	RFP	Request for Proposal
CVISN	Commercial Vehicle Inf. System and Networks	ROD	Record of Decision
DDHV	Directional design hour volume	RTIP	Regional Transportation Improvement Program
DDP	Design Documentation Package	RTPO	Regional Transportation Planning Organization
DHV	Design hourly volume	RV	Recreational vehicle
DNS	Determination of Nonsignificance (SEPA)	R/W	Right of way
DS	Determination of Significance (SEPA)	SEPA	[Washington] State Environmental Policy Act
DVIS	Design Variance Inventory System	SHS	Sustainable Highway Safety
EA	Environmental Assessment (NEPA)	SIMMS	Signal Maintenance Management System
E&EP	Environmental & Engineering Programs Division	SOV	Single-occupant vehicle
EIS	Environmental Impact Statement	SRA	Safety rest area
ERS	Environmental Review Summary	STIP	Statewide Transportation Improvement Program
FAST	Freight Action Strategy	STP	Surface Transportation Program
FGTS	Freight and Goods Transportation System	TIP	Transportation Improvement Program
FHWA	Federal Highway Administration	TMA	Transportation Management Area
FONSI	Finding of No Significant Impact (NEPA)	TMP	Transportation management plan
FTA	Federal Transit Administration	TRIPS	Transportation Information and Planning Support
GIS	Geographic Information System	TWLT	Two-way left-turn lane
GLO	General Land Office	UPO	[Central Puget Sound] Urban Planning Office
GMA	Growth Management Act	USC	United States Code
HCM	Highway Capacity Manual	VE	Value engineering
HCP	Highway Construction Program	VECP	Value Engineering Change Proposal
HMA	Hot mix asphalt	VIC	Visitor Information Center
HOT	High-occupancy toll	VPH	Vehicles per hour
HOV	High-occupancy vehicle	WAC	Washington Administrative Code
HQ	WSDOT's Headquarters in Olympia	WIM	Weigh in motion
HSM	Highway Safety Manual	WSDOT	Washington State Department of Transportation
HSP	Highway System Plan (also SHSP)	WSPMS	Washington State Pavement Management System
HSS	Highways of Statewide Significance	WTP	Washington Transportation Plan
ICA	Intersection Control Analysis		

ADA / Pedestrian Terms

Note: This grouping of terms is used primarily in Chapters [1510](#) and [1515](#).

ADA / Pedestrian Terms	
accessible	Usable by persons with disabilities (ADA compliant).
accessible pedestrian signal (APS)	A device that communicates information about the “WALK” phase in audible and vibrotactile (vibrating surface that communicates information through touch, located on the accessible pedestrian signal button) formats.
accessible route	See pedestrian access route .
ADA	An abbreviation for the Americans with Disabilities Act of 1990. The ADA is a civil rights law that identifies and prohibits discrimination based on disability. Title II of the ADA requires public entities to design new pedestrian facilities or alter existing pedestrian facilities to be accessible to and usable by people with disabilities.
alternate pedestrian access route	A temporary accessible route to be used when the existing pedestrian access route is blocked by construction, alteration, maintenance, or other temporary condition(s).
alteration	<p>A change to a facility in the public right of way that affects or could affect access, circulation, or use.</p> <p>Alterations include, but are not limited to: renovation; rehabilitation; reconstruction; historic restoration; resurfacing of circulation paths or vehicular ways; or changes or rearrangement of structural parts or elements of a facility.</p> <p>Alterations <i>do not</i> include: Spot pavement repair; liquid-asphalt sealing, chip seal (bituminous surface treatment), or crack sealing; or lane restriping that does not alter the usability of the shoulder.</p>
buffer	A space measured from the back of the curb to the edge of the sidewalk that could be treated with plantings or alternate pavement, or be used for needs such as drainage treatment or utility placement.
clear width	The unobstructed width within a pedestrian circulation path. The clear width within a pedestrian circulation path must meet the accessibility criteria for a pedestrian access route.
construction impact zone	The area in which an alteration to an existing facility takes place (also known as the project footprint). If a crosswalk (marked or unmarked) will be reconstructed, paved (overlay or inlay), or otherwise altered as part of a project, then the curb ramps that serve that crosswalk are within the construction impact zone.
counter slope	The slope of the gutter or roadway at the foot of a curb ramp or landing where it connects to the roadway, measured along the axis of the running slope extended.
cross slope	The slope measured perpendicular to the direction of travel.

ADA / Pedestrian Terms	
crosswalk	<p>A marked or unmarked pedestrian crossing, typically at an intersection, that connects the pedestrian access routes on opposite sides of a roadway. A crosswalk must meet accessibility criteria.</p> <p>A crosswalk is also defined as:</p> <ul style="list-style-type: none"> • "...the portion of the roadway between the intersection area and a prolongation or connection of the farthest sidewalk line or in the event there are no sidewalks then between the intersection area and a line ten feet therefrom, except as modified by a marked crosswalk" (RCW 46.04.160). • "(a) That part of a roadway at an intersection included within the connections of the lateral lines of the sidewalks on opposite sides of the highway measured from the curbs or in the absence of curbs, from the edges of the traversable roadway, and in the absence of a sidewalk on one side of the roadway, the part of the roadway included within the extension of the lateral lines of the sidewalk at right angles to the center line; (b) any portion of a roadway at an intersection or elsewhere distinctly indicated as a pedestrian crossing by lines on the surface, which might be supplemented by contrasting pavement texture, style, or color" (MUTCD, 2003; <i>Guide for the Planning, Design, and Operation of Pedestrian Facilities</i>, AASHTO, 2004).
curb extension	A curb and sidewalk bulge or extension out into the parking lane used to decrease the length of a pedestrian crossing and increase visibility for the pedestrian and driver.
curb ramp	<p>A combined ramp and landing to accomplish a change in level at a curb. This element provides street and sidewalk access to pedestrians with mobility impairments.</p> <ul style="list-style-type: none"> • parallel curb ramp A curb ramp design where the sidewalk slopes down to a landing at road level with the running slope of the ramp in line with the direction of sidewalk travel • perpendicular curb ramp A curb ramp design where the ramp path is perpendicular to the curb and meets the gutter grade break at a right angle.
detectable warning surface	A tactile surface feature of truncated dome material built into or applied to the walking surface to alert persons with visual impairments of vehicular ways. Federal yellow is the color used on WSDOT projects to achieve visual contrast. Colors other than federal yellow that meet the light-on-dark/dark-on-light requirement may be used on projects where cities have jurisdiction. (Detectable warning surfaces are detailed in the Standard Plans .)
flangeway gap	The gap for the train wheel at a railroad crossing. The space between the inner edge of a rail and the pedestrian crossing surface.
grade break	The intersection of two adjacent surface planes of different grade.
landing	A level paved area, within or at the top and bottom of a stair or ramp, designed to provide turning and maneuvering space for wheelchair users and as a resting place for pedestrians.
maximum extent feasible (MEF)	From the U.S. Department of Justice, 28 CFR Part 36.402 , Alterations. The phrase "to the maximum extent feasible" applies to "the occasional case where the nature of an existing facility makes it virtually impossible to comply fully with applicable accessibility standards through a planned alteration." This phrase also refers to a stand-alone piece of design documentation that WSDOT uses to record its reasons for not being able to achieve full ADA compliance in alteration projects (called a Maximum Extent Feasible document).
midblock pedestrian crossing	A marked pedestrian crossing located between intersections.

ADA / Pedestrian Terms	
passenger loading zone	An area provided for pedestrians to board/disembark a vehicle.
pedestrian	Any person afoot or using a wheelchair (manual or motorized) or means of conveyance (other than a bicycle) propelled by human power, such as skates or a skateboard.
pedestrian access route (PAR) (synonymous with <i>accessible route</i>)	A continuous, unobstructed walkway within a pedestrian circulation path that provides accessibility. Pedestrian access routes consist of one or more of the following pedestrian facilities: walkways/sidewalks, curb ramps (excluding flares), landings, crosswalks, pedestrian overpasses/underpasses, access ramps, elevators, and platform lifts. Note: Not all transportation facilities need to accommodate pedestrians. However, those that do accommodate pedestrians need to have an accessible route.
pedestrian circulation path	A prepared exterior or interior way of passage provided for pedestrian travel. Includes independent walkways, shared-use paths, sidewalks, and other types of pedestrian facilities. All pedestrian circulation paths are required to contain a continuous pedestrian access route that connects to all adjacent pedestrian facilities, elements, and spaces that are required to be accessible.
pedestrian facilities	Walkways such as sidewalks, walking and hiking trails, shared-use paths, pedestrian grade separations, crosswalks, and other improvements provided for the benefit of pedestrian travel. Pedestrian facilities are intended to be accessible routes.
pedestrian overpass or underpass	A grade-separated pedestrian facility, typically a bridge or tunnel structure over or under a major highway or railroad that allows pedestrians to cross.
pedestrian refuge island	An island in the roadway that physically separates the directional flow of traffic, provides pedestrians with a place of refuge, and reduces the crossing distance. Note: Islands with cut-through paths are more accessible to persons with disabilities than are raised islands with curb ramps.
pedestrian signal	An adaptation of a conventional traffic signal installed at established pedestrian crossings. It is used to provide a protected phase for pedestrians by terminating the conflicting vehicular movements to allow for pedestrian crossings.
person with disability	An individual who has an impairment, including a mobility, sensory, or cognitive impairment, that results in a functional limitation in access to and use of a building or facility.
raised median	A raised island in the center of a road used to restrict vehicle left turns and side street access. Note: Islands with cut-through paths are more accessible to persons with disabilities than are raised islands with curb ramps.
ramp	A walking surface with a running slope steeper than 20H:1V (5%).
running slope	A slope measured in the direction of travel, normally expressed as a percent.
sidewalk	A walkway along a highway, road, or street intended for use by pedestrians.
site	A parcel of land bounded by a property line or a designated portion of a public right of way.
street furniture	Sidewalk equipment or furnishings, including garbage cans, benches, parking meters, and telephone booths.
traffic calming	Design techniques that have been shown to reduce traffic speeds and unsafe maneuvers. These techniques can be stand-alone or used in combination, and they include lane narrowing, curb extensions, surface variations, and visual clues in the vertical plane.

ADA / Pedestrian Terms	
transitional segments	Segments of a pedestrian circulation path that blend between existing undisturbed pedestrian facilities and newly altered pedestrian facilities. Use of transitional segments may permit the work of the alteration to more nearly meet the new construction standards. At a later time, when other segments of the pedestrian circulation path are altered, the noncomplying transitional segments can be removed and replaced with pedestrian facilities that meet the accessibility criteria.
universal access	Access for all persons regardless of ability or stature.
walk interval	That phase of a traffic signal cycle during which the pedestrian is to begin crossing, typically indicated by a WALK message or the walking person symbol and its audible equivalent.
walkway	The continuous portion of the pedestrian access route that is connected to street crossings by curb ramps.

Main Glossary of Terms

A	B	C	D	E	F	G	H	I	J	K	L	M	N	O	P	Q	R	S	T	U	V	W	Y	Z
-------------------	-------------------	-------------------	-------------------	-------------------	-------------------	-------------------	-------------------	-------------------	-------------------	-------------------	-------------------	-------------------	-------------------	-------------------	-------------------	-------------------	-------------------	-------------------	-------------------	-------------------	-------------------	-------------------	-------------------	-------------------

A

access A means of entering or leaving a public road, street, or highway with respect to abutting property or another public road, street, or highway.

access break Any point from inside or outside the state limited access right of way limited access hachures that crosses over, under, or physically through the plane of the limited access, is an access break or “break in access,” including, but not limited to, locked gates and temporary construction access breaks.

access connection An access point, other than a public road/street, that permits access to or from a managed access highway on the state highway system.

access connection permit A written authorization issued by the permitting authority for a specifically designed access connection to a managed access highway at a specific location; for a specific type and intensity of property use; and for a specific volume of traffic for the access connection based on the final stage of the development of the applicant’s property. The actual form used for this authorization is determined by the permitting authority.

access control The limiting and regulating of public and private access to Washington State’s highways, as required by state law. A *design control* (see [Chapter 1103](#)) – there are two categories of controlling access to state highways *limited access* and *managed access*.

Access Control Tracking System Limited Access and Managed Access Master Plan A database list, related to highway route numbers and mileposts, that identifies either the level of limited access or the class of managed access: www.wsdot.wa.gov/design/accessandhearings

access density the number of access points (driveways) per mile.

access deviation A deviation (see Chapter 300) that authorizes deferring or staging acquisition of limited access control, falling short of a 300-foot requirement, or allowing an existing access point to stay within 130 feet of an intersection on a limited access highway. Approval by the Director & State Design Engineer, Development Division, is required (see Chapter 530).

access hearing plan A limited access plan prepared for presentation at an access hearing.

access management The programmatic control of the location, spacing, design, and operation of driveways, median openings, interchanges, and street connections to a roadway.

access point Any point that allows private or public entrance to or exit from the traveled way of a state highway, including “locked gate” access and maintenance access points.

access point revision A new access point or a revision of an existing interchange/ intersection configuration. Locked gates and temporary construction breaks are also access point revisions.

access point spacing On a managed access highway, the distance between two adjacent access points on one side of the highway, measured along the edge of the traveled way from one access point to the next (see also corner clearance).

access report plan A limited access plan prepared for presentation to local governmental officials at preliminary meetings before preparation of the access hearing plan.

access rights Property rights that allow an abutting property owner to enter and leave the public roadway system.

adaptive lighting system A lighting system with a control system connected, allowing for dimming, on/off operation by time of night, and independent scheduling of individual lights for select hours of operation during nighttime hours.

affidavit of publication A notarized written declaration stating that a notice of hearing (or notice of opportunity for a hearing) was published in the legally prescribed manner.

affidavit of service by mailing A notarized written declaration stating that the limited access hearing packet was mailed at least 15 days prior to the hearing and entered into the record at the hearing.

alternative(s) Possible solutions to accomplish a defined purpose and need. These include local and state transportation system mode and design options, locations, and travel demand management and transportation system management-type improvements such as ramp metering, mass transit, and high-occupancy vehicle (HOV) facilities.

Alternatives Comparison Table (ACT) A table that documents and presents the tradeoffs among those performance metrics identified for each alternative under consideration on a project. The ACT is used to assist in analyzing the baseline and contextual performance tradeoffs and ultimately to select an alternative. It is a supplemental document to the “Alternatives Analysis” section of the [Basis of Design](#).

ancillary services Those secondary services, also considered amenities, provided at safety rest areas that include, but are not limited to, vending machines, picnic areas, interpretive signing, telephones, recreational vehicle (RV) sanitary disposal facilities, trails, scenic viewpoints, commercial and public information displays, and visitor information centers.

annual average daily traffic (AADT) The total volume of traffic passing a point or segment of a highway facility in both directions for one year divided by the number of days in the year.

annual daily traffic (ADT) The volume of traffic passing a point or segment of a highway, in both directions, during a period of time, divided by the number of days in the period, and factored to represent an estimate of traffic volume for an average day of the year.

application for an access connection An application provided by the permitting authority to be completed by the applicant for access to a managed access highway.

approach An access point, other than a public road/street, that allows access to or from a limited access highway on the state highway system.

approach and access connection These terms are listed under the specific access section to which they apply. The first section below is for limited access highways and uses the term approach. The second section below is for managed access highways and uses the term access connection. Approaches and access connections include any ability to leave or enter a highway right of way other than at an intersection with another road or street.

(a) **limited access highways: approach** An access point, other than a public road/street, that allows access to or from a limited access highway on the state highway system. There are five types of approaches to limited access highways that are allowed:

- **Type A** An off and on approach in a legal manner, not to exceed 30 feet in width, for the sole purpose of serving a single-family residence. It may be reserved by the abutting owner for specified use at a point satisfactory to the state at or between designated highway stations. This approach type is allowed on partial and modified control limited access highways.
- **Type B** An off and on approach in a legal manner, not to exceed 50 feet in width, for use necessary to the normal operation of a farm, but not for retail marketing. It may be reserved by the abutting owner for specified use at a point satisfactory to the state at or between designated highway stations. This approach type is allowed on partial and modified control limited access highways. This approach type may be used for wind farms when use of the approach is limited to those vehicles necessary to construct and maintain the farm for use in harvesting wind energy.
- **Type C** An off and on approach in a legal manner, for a special purpose and width to be agreed upon. It may be specified at a point satisfactory to the state at or between designated highway stations. This approach type is allowed on partial and modified control limited access highways and on full control limited access highways where no other reasonable means of access exists, as solely determined by the department.
- **Type D** An off and on approach in a legal manner, not to exceed 50 feet in width, for use necessary to the normal operation of a commercial establishment. It may be specified at a point satisfactory to the state at or between designated highway stations. This approach type is allowed only on modified control limited access highways.
- **Type E** This type is no longer allowed to be constructed because of the requirements that there be only one access point per parcel on a limited access state highway.
- **Type F** An off and on approach in a legal manner, not to exceed 30 feet in width, for the sole purpose of serving a wireless communication site. It may be specified at a point satisfactory to the state at or between designated highway stations. This approach type is allowed only on partial control limited access highways. (See WAC [468 58 080\(vi\)](#) for further restrictions.)

(b) **managed access highways: access connection** An access point, other than a public road/street, that permits access to or from a managed access highway on the state highway system. There are five types of access connection permits:

- **conforming access connection** A connection to a managed access highway that meets current WAC and WSDOT location, spacing, and design criteria.

- **grandfathered access connection** Any connection to the state highway system that was in existence and in active use on July 1, 1990, and has not had a significant change in use.
- **joint-use access connection** A single connection to a managed access highway that serves two or more properties.
- **nonconforming access connection** A connection to a managed access highway that does not meet current WSDOT location, spacing, or design criteria, pending availability of a future conforming access connection.
- **variance access connection** A connection to a managed access highway at a location not normally allowed by current WSDOT criteria.

(c) **managed access connection category** There are four access connection permit categories for managed access connections to state highways: Category I, Category II, Category III, and Category IV (see [Chapter 540](#)).

approach design speed The design speed of the roadway leading into the roundabout.

approach lanes The lane or set of lanes for traffic approaching the roundabout (see [Chapter 1320](#)).

area of influence The area that will be directly impacted by the proposed action: freeway main line, ramps, crossroads, immediate off-system intersections, and state and local roadway systems.

articulated bus A two-section bus that is permanently connected at a joint.

auxiliary aids and services (1) Qualified interpreters, notetakers, transcription services, written materials, telephone handset amplifiers, assistive listening devices, assistive listening systems, telephones compatible with hearing aids, open and closed captioning, telecommunications devices for deaf persons (TDDs), videotext displays, or other effective methods for making aurally delivered materials available to individuals with hearing limitations; (2) Qualified readers, taped texts, audio recordings, Brailled materials, large print materials, or other effective methods for making visually delivered materials available to individuals with visual impairments; (3) Acquisition or modification of equipment or devices; (4) Other similar services and actions; and (5) Providing and disseminating information, written materials, and notices in languages other than English, where appropriate.

auxiliary lane The portion of the roadway adjoining the through lanes for parking, speed change, turning, storage for turning, weaving, truck climbing, and other purposes supplementary to through-traffic movement.

average daily traffic (ADT) The total volume during a given time period (in whole days): greater than one day and less than one year, divided by the number of days in that time period.

average light level The average of all light intensities within the design area.

average weekday vehicle trip ends (AWDVTE) The estimated total of all trips entering plus all trips leaving a road approach on a weekday for the final stage of development of the property served by the road approach.

B

backslope A sideslope that goes up as the distance increases from the roadway (cut slopes).

barrier terminal A crash-tested end treatment for longitudinal barriers that is designed to reduce the potential for spearing, vaulting, rolling, or excessive deceleration of impacting vehicles from either direction of travel. Barrier terminals include applicable anchorage.

baseline The approved time phased plan (for a project, a work breakdown structure component, a work package, or a schedule activity), plus or minus approved project scope, cost, schedule, and technical changes. Generally refers to the current baseline, but may refer to the original or some other baseline. Usually used with a modifier (e.g., cost baseline, schedule baseline, performance measurement baseline, technical baseline).

baseline performance metric A description of need in terms that can be measured or assessed in both the existing and proposed (future) state.

baseline performance need The primary reason a project has been proposed. It refers to the threshold determination at the project location resulting from a statewide biennial prioritization and funding process. It may also be the specific issue to be addressed by the project described by a partnering agency that is providing the funding.

basic number of lanes The minimum number of general purpose lanes designated and maintained over a significant length of highway.

Basis of Design (BOD) A document and template used to record information, decisions, and analysis needed in the development of a project design, including all factors leading to the development and selection of a project alternative, and the selection of design elements associated with that alternative.

benefit/cost analysis A method of valuing a proposition by first monetizing all current expenditures to execute—cost—as well as the expected yields into the future—benefit, then dividing the total benefit by the total cost, thus providing a ratio. Alternatives may be rendered and compared in this fashion where, typically, a higher ratio is preferable, indicating a better return on investment.

bicycle Any device propelled solely by human power upon which a person or persons may ride, having two tandem wheels, either of which is 16 inches or more in diameter, or three wheels, any one of which is more than 20 inches in diameter.

bicycle route A system of facilities that is used or has a high potential for use by bicyclists or that is designated as such by the jurisdiction having the authority. A series of bicycle facilities may be combined to establish a continuous route and may consist of any or all types of bicycle facilities.

bike lane A portion of a highway or street identified by signs and pavement markings as reserved for bicycle use.

break See access break.

buffer-separated HOV lane An HOV lane that is separated from the adjacent same direction general-purpose freeway lanes by a designated buffer.

bus A rubber-tired motor vehicle used for transportation, designed to carry more than ten passengers.

business access transit (BAT) lanes A transit lane that allows use by other vehicles to access abutting businesses.

bus pullout A bus stop with parking area designed to allow transit vehicles to stop wholly off the roadway.

bus rapid transit (BRT) An express rubber tired transit system operating predominantly in roadway managed lanes. It is generally characterized by separate roadway or buffer-separated HOV lanes, HOV direct access ramps, and a high-occupancy designation (3+ or higher).

bus shelter A facility that provides seating and protection from the weather for passengers waiting for a bus.

bus stop A place designated for transit vehicles to stop and load or unload passengers.

C

capacity The maximum sustainable flow rate at which vehicles or persons can reasonably be expected to traverse a point or uniform segment of a lane or roadway during a specified time period under given roadway, geometric, traffic, environmental, and control conditions. Capacity is usually expressed as vehicles per hour (vph), passenger cars per hour (pcph), or persons per hour (pph).

Capital Improvement and Preservation Program (CIPP) WSDOT's program of projects developed each biennium that delivers capital investments in highway, marine, and rail facilities that have been funded in part or in whole by the state Legislature. The CIPP is submitted to the Governor and, ultimately, by the Governor to the Legislature.

Capital Program Management System (CPMS) A computer database used to develop and manage the highway and marine construction programs. The CPMS allows users to establish and maintain project data and is used to manage and deliver statewide construction programs.

capture trips Trips that do not enter or leave the traveled ways of a project's boundary within a mixed-use development.

carpool/vanpool A group of people who share the use and cost of a car or van for transportation on a regular basis.

Categorical Exclusion (CE) (NEPA) or Categorical Exemption (CE) (SEPA) Actions that do not individually or cumulatively have a significant effect on the environment.

centeredness Refers to the mix of residential and employment densities within a land use area.

central island The area of the roundabout, including the truck apron, surrounded by the circulating roadway.

central island diameter The diameter of the central island, including the truck apron (see [Chapter 1320](#)).

circulating lane A lane used by vehicles circulating in the roundabout.

circulating roadway The traveled lane(s) adjacent to the central island and outside the truck apron, including the entire 360° circumference of the circle.

circulating roadway width The total width of the circulating lane(s) measured from inscribed circle to the central island (see [Chapter 1320](#)).

clear run-out area The area beyond the toe of a nonrecoverable slope available for use by an errant vehicle.

clear zone The total roadside border area, available for use by errant vehicles, starting at the edge of the traveled way and oriented from the outside or inside shoulder (in median applications) as applicable. This area may consist of a shoulder, a recoverable slope, a nonrecoverable slope, and/or a clear run-out area. The clear zone cannot contain a critical fill slope, fixed objects, or water deeper than 2 feet.

Climate Change Vulnerability The risk a transportation facility will be impacted by the effects of climate change.

climbing lane An auxiliary lane used for the diversion of slow traffic from the through lane.

coefficient of retroreflection (RL) A measure of retroreflection.

collector A context description of a roadway intended to provide a mix of access and mobility performance. Typically low speed, collecting traffic from local roads and connecting them with destination points or arterials. This term is used in multiple classification systems, but is most commonly associated with the *Functional Classification System*.

collector-distributor road (C-D road) A parallel roadway designed to remove weaving from the main line and reduce the number of main line entrances and exits.

collector system Routes that primarily serve the more important intercounty, intracounty, and intraurban travel corridors; collect traffic from the system of local access roads and convey it to the arterial system; and on which, regardless of traffic volume, the predominant travel distances are shorter than on arterial routes ([RCW 47.05.021](#)).

crash rate Crashes per one million vehicle miles traveled and fatal rates per one hundred million vehicle miles.

Commercial Vehicle Information Systems and Networks (CVISN) A network that links intelligent transportation systems (ITS) to share information on commercial vehicles. When in operation at a weigh site, it can enable commercial vehicles to clear the facility without stopping.

complex ramp alignment and grade The exit advisory speed is 35 mph or lower than the posted main line speed, or there is a 6% or greater change in grade from existing main line grade to the ramp grade.

conflict An event involving two or more road users in which the action of one user causes the other user to make an evasive maneuver to avoid a crash.

conflict point A point where traffic paths cross, merge, or diverge.

connection See [approach and access connection](#).

consider To think carefully about, especially in order to make a decision. The decision to document a consideration is left to the discretion of the engineer.

context Interrelated built and natural conditions that impact the design because of their potential influence on travel and operational characteristics and/or project scope. Context is identified by an interdisciplinary team through observation and interpretation of the built and natural environment that is adjacent to or that the team determines would affect the project design.

- **land use** Those characteristics adjacent or in close proximity to the project that impact travel mode decisions and/or facility travel patterns or operations, and will therefore influence decisions about project design or configuration.
- **transportation** The travel characteristics that represents the function of the transportation corridor within which the project exists, including types and modes of travel, and patterns and purpose of travel, including those uses, functions, and operations on the local or regional network in close proximity to the project corridor.
- **Vision/Future** Describes a future condition, for either land use or transportation context, that is desired by one or more groups interested in outcomes for a segment or corridor.

context categories The naming convention used to describe either a land use or transportation context (see [Chapter 1102](#)).

context characteristic A distinguishing trait within a context, either land use or transportation. [Chapter 1102](#) lists several common characteristics that help distinguish between one type of context versus another. There may be additional traits not covered in the chapter.

contextual performance metric A restatement of a contextual performance need in terms that can be measured or assessed in both the existing and proposed (future) state.

contextual performance need A statement of need that applies to a project location which has not been identified as a baseline need.

context sensitive solutions (CSS) A collaborative, interdisciplinary approach that involves all stakeholders to develop a transportation facility that fits its physical setting and preserves scenic,

aesthetic, historic, and environmental resources while maintaining safety and mobility. CSS is an approach that considers the total context within which a transportation improvement project will exist.

contiguous parcels Two or more pieces of real property, under the same ownership, with one or more boundaries that touch and have similarity of use.

continuous load The electrical load on a circuit that lasts for a duration of three or more hours on any day.

contributing factors Those operational conditions, human factors, context conditions, design elements, design controls, or actions identified by data, engineering judgment, or the community that contribute to a performance need under evaluation.

controlled releasing terminal (CRT) post A standard-length guardrail post that has two holes drilled through it so it might break away when struck.

conventional traffic signal A permanent or temporary installation providing alternating right of way assignments for conflicting traffic movements. At least two identical displays are required for the predominant movement on each approach.

corner clearance On a managed access highway, the distance from an intersection of a public road or street to the nearest access connection along the same side of the highway. The minimum corner clearance distance (see [Chapter 540](#)) is measured from the closest edge of the intersecting road or street to the closest edge of the traveled way of the access connection, measured along one side of the traveled way (through lanes) (see also [access point spacing](#)).

corridor sketch an information source that describes the attributes of a state highway corridor, its current and future function, as well as its performance expectations. It will ultimately identify cost-effective strategies for future consideration. A completed corridor sketch may have information that is valuable at the project level in determining contextual performance needs, and project alternatives. A corridor sketch is not a substitute for detailed planning and analysis, nor is it a list of investments or projects.

corridor vision The future transportation context from a regional perspective. Practical Design considers and accounts for the contextual needs of the longer section of highway in the development and evaluation of alternatives to ensure a favorable outcome for the greater system.

countermeasure an action taken to counteract an existing or anticipated condition.

court reporter A person with a license to write and issue official accounts of judicial or legislative proceedings.

crash-accepted device A feature that has been proven acceptable for use under specified conditions, either through crash testing or in-service performance.

Crash Analysis Report (CAR) A template that is the basis for all crash analyses for all types of design documentation that need crash analyses, as described in [Chapter 321](#).

critical fill slope A slope on which a vehicle is likely to overturn. Slopes steeper than 3H:1V are considered critical fill slopes.

crossroad The minor roadway at an intersection. At a stop-controlled intersection, the crossroad has the stop.

curb section A roadway cross section with curb and sidewalk.

D

decision sight distance The distance needed for a driver to detect an unexpected or difficult-to-perceive condition, recognize the condition, select an appropriate maneuver, and complete the maneuver based on design conditions and design speed.

deflection (in respect to roundabouts) The change in the path of a vehicle imposed by the geometric features of a roundabout resulting in a slowing of vehicles.

delineation Any method of defining the roadway operating area for the driver.

deliverable Any unique and verifiable product, result or capability to perform a service that must be produced to complete a process, phase, or project.

departure lanes The lane or set of lanes for traffic leaving the roundabout (see Chapter 1320).

Design Analysis A process and tool used to document important design decision(s), summarizing information needed for an approving authority to understand and support the decision (see Chapters 300 and 1106).

Design Approval Documented approval of the design at this early milestone locks in design policy for three years. Design approval becomes part of the Design Documentation Package (see Chapter 300.)

design-bid-build The project delivery method where design and construction are sequential steps in the project development process (23 CFR 636.103).

design-build contract An agreement that provides for design and construction of improvements by a consultant/contractor team. The term encompasses design-build-maintain, design-build-operate, design-build-finance, and other contracts that include services in addition to design and construction. Franchise and concession agreements are included in the term if they provide for the franchisee or concessionaire to develop the project that is the subject of the agreement (23 CFR 636.103).

design-builder The firm, partnership, joint venture, or organization that contracts with WSDOT to perform the work.

design controls key parameters that critically shape design decisions and effect calculated dimensions for some design elements. Design controls are conscientiously selected and work together with the context characteristics to achieve a particular outcome (see Chapter 1103)

Design Clear Zone The minimum clear zone target value used in highway design.

Design Documentation Package (DDP) See [Project File](#).

design element Any component or feature associated with roadway design that becomes part of the final product. Examples include lane width, shoulder width, alignment, and clear zone (see [Chapter 1105](#).)

designer This term applies to WSDOT design personnel. Wherever “designer” appears in this manual, design-build personnel shall deem it to mean: Engineer of Record, Design Quality Assurance Manager, design-builder, or any other term used in the design-build contract to indicate design-build personnel responsible for the design elements of a design-build project, depending on the context of information being conveyed.

design hourly volume (DHV) Computed by taking the annual average daily traffic times the K-factor. It can only be accurately determined in locations where there is a permanent traffic recording device active 365 days of the year. It correlates to the peak hour (see [peak hour](#)), but it is not equivalent. In some circumstances, it is necessary to use the peak hour data instead of DHV because peak hour can be collected using portable traffic recorders.

design speed A design control; the speed used to determine the various geometric design features of the roadway.

design up An approach to developing project alternatives utilizing the smallest dimensions that meet the need by providing the desired performance.

design users A broad term intended to capture all modal users that currently utilize or are legally permitted on a roadway segment or node.

design variance Same as design analysis.

Design Variance Inventory (DVI) A list of design variances for a project. Only approved variances should be included on this list (see [Chapter 300](#)).

Design Variance Inventory System (DVIS) A database application developed to generate the DVI form. The DVIS also provides query functions, giving designers an opportunity to search for previously granted variances. The *Design Manual* is constantly being refined and guidelines change over time. What may have been a design variance previously may not be one today. The DVIS database is intended for internal WSDOT use only, and WSDOT staff access it from the left margin of this website:

 <http://wwwi.wsdot.wa.gov/design/>

design vehicle See [intersection design vehicle](#).

design year The forecast year used for design as described in [Chapter 1103](#). See also [horizon year](#).

desirable Design criteria that are recommended for inclusion in the design.

Determination of Nonsignificance (DNS) (SEPA) The written decision by the Regional Administrator that a proposal will not have a significant impact and no EIS is required.

Determination of Significance (DS) (SEPA) A written decision by the Regional Administrator that a proposal could have a significant adverse impact and an EIS is required.

directional design hour volume (DDHV) The traffic volume for the design hour in the peak direction of flow, in vehicles per hour. For example, if during the design hour, 60% of the vehicles traveled eastbound and 40% traveled westbound, then the DDHV for the eastbound direction would be the DHV x 0.60.

divided multilane A roadway with two or more through lanes in each direction and a median that physically or legally prohibits left turns, except at designated locations.

document (verb) The act of including a short note to the Design Documentation Package that explains a design decision.

dooring Describes a conflict with a parked vehicle door opening into a roadway bike facility.

double-lane roundabout A roundabout with a two-lane circulating roadway and one or more entry or exit legs with two lanes.

driveway A vehicular access point that provides access to or from a public roadway.

drop and ride An area of a park & ride lot or other multimodal facility where patrons are dropped off or picked up by private auto or taxi.

durability A measure of a traffic line's resistance to the wear and deterioration associated with abrasion and chipping.

E

easement A documented right, as a right of way, to use the property of another for designated purposes.

element An architectural or mechanical component or design feature of a space, site, or public right of way.

emergency escape ramp A roadway leaving the main roadway designed for the purpose of slowing and stopping out-of-control vehicles away from the main traffic stream.

emergency vehicle signal A special adaptation of a conventional traffic signal installed to allow for the safe movement of authorized emergency vehicles. Usually, this type of signal is installed on the highway at the entrance into a fire station or other emergency facility. The signal ensures protected entrance onto the highway for the emergency vehicle. When not providing for this movement, the signal either operates continuously (consistent with the requirements for a conventional traffic signal) or displays continuous green, which is allowed at non-intersection locations only. At least two identical displays are required per approach.

enforcement observation point A place where a law enforcement officer may park and observe traffic.

entry angle The angle between the entry roadway and the circulating roadway measured at the yield point (see [Chapter 1320](#)).

entry curve The curve of the left edge of the roadway that leads into the circulating roadway (see [Chapter 1320](#)).

entry width The width of an entrance leg at the inscribed circle measured perpendicular to travel (see [Chapter 1320](#)).

Environmental Assessment (EA) (NEPA) A document prepared for federally funded, permitted, or licensed projects that are not categorical exclusions (CE), but do not appear to be of sufficient magnitude to require an EIS. The EA provides enough analysis to determine whether an EIS or a FONSI should be prepared.

Environmental Impact Statement (EIS) A detailed written statement of a proposed course of action, project alternatives, and possible impacts of the proposal.

Environmental Review Summary (ERS) (see [Project Summary](#)) Part of the Project Summary document, the ERS identifies environmental permits and approvals. It is prepared in the region and is required for Design Approval.

exit curve The curve of the left edge of the roadway that leads out of the circulating roadway (see [Chapter 1320](#)).

exit width The width of an exit leg at the inscribed circle (see [Chapter 1320](#)).

expressway A divided highway that has a minimum of two lanes in each direction for the exclusive use of traffic and that may or may not have grade separations at intersections. A transportation context characteristic that is designated for a divided highway with limited access that provides regional mobility. See [Exhibit 1102-2](#) for more details.

extrude A procedure for applying marking material to a surface by forcing the material through a die to give it a certain shape.

F

facility All or any portion of buildings, structures, improvements, elements, and pedestrian or vehicular routes located in a public right of way.

feature A component of a pedestrian access route, such as a curb ramp, driveway, crosswalk, or sidewalk.

Federal Highway Administration (FHWA) The division of the U.S. Department of Transportation with jurisdiction over the use of federal transportation funds for state highway and local road and street improvements.

Federal Transit Administration (FTA) The division of the U.S. Department of Transportation with jurisdiction over the use of federal funds for financial assistance to develop new transit systems and improve, maintain, and operate existing systems.

feeder service Bus service that provides connections with other bus or rail services.

final design Any design activities following preliminary design; expressly includes the preparation of final construction plans and detailed specifications for the performance of construction work (23 CFR 636.103). Final design is also defined by the fact that it occurs after NEPA/SEPA approval has been obtained.

Finding of No Significant Impact (FONSI) (NEPA) A federal document indicating that a proposal will not significantly affect the environment and an EIS is not required.

findings and order A document containing the findings and conclusions of a limited access hearing approved by the Assistant Secretary, Engineering & Regional Operations (see [Chapter 210](#)).

findings and order plan A limited access plan, prepared after a limited access hearing, which is based on the hearing record.

fixed feature (object to be mitigated) A fixed object, a side slope, or water that, when struck, can result in impact forces on a vehicle's occupants that may result in injury or place the occupants in a situation that has a high likelihood of injury. A fixed feature can be either constructed or natural.

flare The widening of the approach to the roundabout to increase capacity and facilitate natural vehicle paths.

flasher warning assembly Flashing beacons that are used only to supplement an appropriate warning or regulatory sign or marker. The displays consist of two alternating flashing yellow indications.

flyer stop A transit stop inside the limited access boundaries.

footcandle (fc) The illumination of a surface one square foot in area on which a flux of one lumen is uniformly distributed. One footcandle equals one lumen per square foot.

foreslope A sideslope that goes down as the distance increases from the roadway (fill slopes and ditch inslopes).

freight corridor type Designations for a highway facility found in the Freight and Goods Transportation System (FGTS).

freeway A divided highway that has a minimum of two lanes in each direction for the exclusive use of traffic and with full control of access.

frontage road An auxiliary road that is a local road or street located beside a highway for service to abutting property and adjacent areas and for control of access.

functional classification The grouping of streets and highways according to the character of the service they are intended to provide.

G

geocomposites Prefabricated edge drains, wall drains, and sheet drains that typically consist of a cusped or dimpled polyethylene drainage core wrapped in a geotextile. The geotextile wrap keeps the core clean so that water can freely flow through the drainage core, which acts as a conduit. Prefabricated edge drains are used in place of shallow geotextile-wrapped trench drains at the edges of the roadway to provide subgrade and base drainage. Wall drains and sheet drains are typically placed between the back of the wall and the soil to drain the soil retained by the wall.

Geographic Information System (GIS) A computerized geographic information system used to store, analyze, and map data. Data may be used with GIS if the data includes the Accumulated Route Mile (ARM) or State Route Milepost (SRMP) programs. Global Positioning System (GPS) technology provides a means of collecting data and is an alternative to ARM and SRMP. WSDOT's primary desktop tool to view and analyze GIS data is ArcGIS software. GIS is used to gather and analyze data to support the purpose and need as described in the Project Summary (<http://wwwi.wsdot.wa.gov/gis/supportteam/default.asp>).

geogrids A polymer grid mat constructed either of coated yarns or a punched and stretched polymer sheet. Geogrids usually have high strength and stiffness and are used primarily for soil reinforcement.

geomembranes Impervious polymer sheets that are typically used to line ponds or landfills. In some cases, geomembranes are placed over moisture-sensitive swelling clays to control moisture.

geonets Similar to geogrids, but typically lighter weight and weaker, with smaller mesh openings. Geonets are used in light reinforcement applications or are combined with drainage geotextiles to form a drainage structure.

geosynthetic erosion control The minimizing of surficial soil particle movement due to the flow of water over the surface of bare soil or due to the disturbance of soil caused by construction activities under or near bodies of water. This is the primary function of geotextiles used as silt fences or placed beneath riprap or other stones on soil slopes. Silt fences keep eroded soil particles on the construction site, whereas geotextiles placed beneath riprap or other stones on soil slopes prevent erosion from taking place at all. In general, the permanent erosion control methods described in [Chapter 630](#) are only used where more natural means (like the use of biodegradable vegetation mats to establish vegetation to prevent erosion) are not feasible. These functions control some of the geosynthetic properties, such as apparent opening size (AOS) and permittivity, and in some cases load-strain characteristics. The application will also affect the geosynthetic installation conditions. These installation conditions influence the remaining geosynthetic properties needed, based on the survivability level required.

geosynthetic filtration The passage of water through the geosynthetic relatively unimpeded (permeability or permittivity) without allowing passage of soil through the geosynthetic (retention). This is the primary function of geotextiles in underground drainage applications.

geosynthetic survivability The ability of the geosynthetic to resist installation conditions without significant damage, such that the geosynthetic can function as intended. Survivability affects the strength properties of the geosynthetic required.

geotextiles (nonwoven) A sheet of continuous or staple fibers entangled randomly into a felt for needle-punched nonwovens and pressed and melted together at the fiber contact points for heat-bonded nonwovens. Nonwoven geotextiles tend to have low-to-medium strength and stiffness with high elongation at failure and relatively good drainage characteristics. The high elongation characteristic gives them superior ability to deform around stones and sticks.

geotextiles (woven) Slit polymer tapes, monofilament fibers, fibrillated yarns, or multifilament yarns simply woven into a mat. Woven geotextiles generally have relatively high strength and stiffness and, except for the monofilament wovens, relatively poor drainage characteristics.

glass beads Small glass spheres used in highway pavement markings to provide the necessary retroreflectivity.

gore The area downstream from the intersection of the shoulders of the main line and exit ramp. Although generally referring to the area between a main line and an exit ramp, the term may also be used to refer to the area between a main line and an entrance ramp.

gore nose At an exit ramp, the point at the end of the gore area where the paved shoulders of the main line and the ramp separate (see [Chapter 1360](#)) or the beginning of traffic barrier, not including any impact attenuator. Also, the similar point at an entrance ramp.

H

hearing An assembly to which the public is invited and at which participation is encouraged. Types of hearings include:

- **administrative appeal hearing** A formal process whereby a property owner may appeal WSDOT's implementation of access management legislation. The appeal is heard by an administrative law judge (ALJ), who renders a decision. (See [Chapter 540](#) for administrative appeal hearing procedures.)
- **combined hearing** A hearing held when there are public benefits to be gained by combining environmental, corridor, design, and/or limited access subjects.
- **corridor hearing** A formal or informal hearing that presents the corridor alternatives to the public for review and comment before a commitment is made to any one route or location. This type of hearing is beneficial for existing corridors with multiple Improvement projects programmed over a long duration.
- **design hearing** A formal or informal hearing that presents the design alternatives to the public for review and comment before the selection of a preferred alternative.
- **environmental hearing** A formal or informal hearing documenting that social, economic, and environmental impacts have been considered and that public opinion has been solicited.
- **formal hearing format** A hearing conducted by a moderator using a formal agenda, overseen by a hearing examiner, and recorded by a court reporter, as required by law. Limited access hearings require the use of the formal hearing format (see [Chapter 210](#)).

- **informal hearing format** A hearing where oral comments are recorded by a court reporter, as required by law. An informal hearing often uses the “open house” format (see Chapter 210). A formal agenda and participation by a hearing examiner are optional.
- **limited access hearing** A formal hearing that gives local public officials, owners of abutting properties, and other interested persons an opportunity to be heard about the limitation of access to the highway system.

hearing agenda An outline of the actual public hearing elements, used with formal hearings. (See [Chapter 210](#) for contents.)

Hearing Coordinator The Development Services & Access Manager within the HQ Access and Hearings Section: (360) 705-7251.

hearing examiner An administrative law judge from the Office of Administrative Hearings, or a WSDOT designee, appointed to moderate a hearing.

hearing script A written document of text to be presented orally by department representatives at a hearing.

hearing summary Documentation prepared by the region and approved by Headquarters that summarizes environmental, corridor, and design hearings. (See [Chapter 210](#) for content requirements.)

hearing transcript A document prepared by the court reporter that transcribes verbatim all oral statements made during the hearing, including public comments. This document becomes part of the official hearing record.

high-occupancy toll (HOT) lane A managed lane that combines a high-occupancy vehicle lane and a toll lane.

high-occupancy vehicle (HOV) A vehicle that meets the occupancy requirements of the facility as authorized by [WAC 468-510-010](#).

high pavement type Portland cement concrete pavement or hot mix asphalt (HMA) pavement on a treated base.

high-speed roadway See [speed](#).

highway A general term denoting a street, road, or public way for the purpose of vehicular travel, including the entire area within the right of way.

Highway Construction Program (HCP) A comprehensive multiyear program of highway Improvement and Preservation projects selected by the Legislature.

Highway System Plan (HSP) A WSDOT planning document that addresses the state highway system element of the Washington Transportation Plan (WTP). The HSP defines the service objectives, action strategies, and costs to maintain, operate, preserve, and improve the state highway system for 20 years. The HSP is the starting point for the state highway element of the CIPP and the state Highway Construction Program. It is periodically updated to reflect completed work and changing transportation

needs, policies, and revenues. It compares highway needs to revenues, describes the “constrained” costs of the highway programs, and provides details of conceptual solutions and performance in the improvement program.

Highways of Statewide Significance (HSS) Include interstate highways and other principal arterials that are needed to connect major communities in the state. The designation helps assist with the allocation and direction of funding. (<http://www.wsdot.wa.gov/planning/HSS>)

Horizon year typically considered to be 20 years from the year construction is scheduled to begin, as described in [Chapter 1103](#). See also design year.

HOV direct access ramp An on- or off-ramp exclusively for the use of HOVs that provides access between a freeway HOV lane and a street, transit support facility, or another freeway HOV lane without weaving across general-purpose lanes.

HOV facility A priority treatment for HOVs.

I

impact attenuator system A device that acts primarily to bring an errant vehicle to a stop at a deceleration rate tolerable to the vehicle’s occupants or to redirect the vehicle away from a fixed feature.

incorporated city or town A city or town operating under [RCW 35](#) or [35A](#).

inscribed circle The outer edge of the circulating roadway.

inscribed circle diameter (ICD) The diameter of the inscribed circle (see [Chapter 1320](#)).

intelligent transportation systems (ITS) An integrated system of advanced sensor, computer, electronics, and communication technologies and management strategies, used to increase the safety and efficiency of the surface transportation system.

interchange A system of interconnecting roadways, in conjunction with one or more grade separations, providing for the exchange of traffic between two or more intersecting highways or roadways.

Interchange Justification Report (IJR) The document used to propose a revision to limited access freeways.

intermediate pavement type Hot mix asphalt pavement on an untreated base.

Intermediate speed roadway See speed.

intersection An at-grade access point connecting a state highway with a road or street duly established as a public road or public street by the local governmental entity.

intersection angle The angle between any two intersecting legs at the point the centerlines intersect.

intersection area The area of the intersecting roadways bounded by the edge of traveled ways and the area of the adjacent roadways to the farthest point: (a) the end of the corner radii, (b) through any marked crosswalks adjacent to the intersection, (c) to the stop bar, or (d) 10 feet from the edge of shoulder of the intersecting roadway (see [Chapter 1310](#)).

intersection at grade The general area where a roadway or ramp terminal is met or crossed at a common grade or elevation by another roadway.

- **four-leg intersection** An intersection formed by two crossing roadways.
- **split tee** A four-leg intersection with the crossroad intersecting the through roadway at two tee intersections offset by at least the width of the roadway.
- **tee (T) intersection** An intersection formed by two roadways where one roadway terminates at the point it meets a through roadway.
- **wye (Y) intersection** An intersection formed by three legs in the general form of a “Y” where the angle between two legs is less than 60°.

intersection control beacon (also *flashing beacon*) A secondary control device, generally suspended over the center of an intersection, that supplements intersection warning signs and stop signs. One display per approach may be used; however, two displays per approach are desirable. Intersection control beacons are installed only at intersections that control two or more directions of travel.

intersection leg Any one of the roadways radiating from and forming part of an intersection.

- **entrance leg** The lanes of an intersection leg for traffic entering the intersection.
- **exit leg** The lanes of an intersection leg for traffic leaving the intersection.

Note: Whether an intersection leg is an entrance leg or an exit leg depends on which movement is being analyzed. For two-way roadways, each leg is an entrance leg for some movements and an exit leg for other movements.

intersection density The ratio of intersections per mile.

intersection design vehicle A specific selection of the vehicle to be used to dimension intersection design elements at an individual intersection.

intersection sight distance The length of roadway visible to the driver of a vehicle entering an intersection.

Interstate System A network of routes designated by the state and the Federal Highway Administration (FHWA) under terms of the federal-aid acts as being the most important to the development of a national system. The Interstate System is part of the principal arterial system.

island A defined area within an intersection, between traffic lanes, for the separation of vehicle movements or for pedestrian refuge.

J

justify Preparing a memo to the DDP identifying the reasons for the decision: a comparison of advantages and disadvantages of all options considered. A more rigorous effort than document.

K

K-factor The proportion of AADT occurring in the analysis hour is referred to as the K-factor, expressed as a decimal fraction (commonly called “K,” “K30,” or “K100”). The K30 is the thirtieth (K100 is the one-hundredth) highest peak hour divided by the annual average daily traffic. Normally, the K30 or K100 will be in the range of 0.09 to 0.10 for urban and rural areas. Average design hour factors are available on the web in the Statewide Travel and Collision Data Office’s Annual Peak Hour Report.

L

lamp lumens The total light output from a lamp, measured in lumens.

lane A strip of roadway used for a single line of vehicles.

lane control signal (reversible lanes) A special overhead signal that permits, prohibits, or warns of impending prohibition of lane use.

lane width The lateral design width for a single lane, striped as shown in the [Standard Plans](#) and the [Standard Specifications](#). The width of an existing lane is measured from the edge of traveled way to the center of the lane line or between the centers of adjacent lane lines.

lateral clearance The distance from the edge of traveled way to a roadside object.

layered networks Roadway network arrangement where the objective is to separate modes onto different facilities with planned interconnection locations.

lead agency The public agency that has the principal responsibility for carrying out or approving a project.

least cost planning An approach to making planning decisions that considers a variety of conceptual solutions to achieve desired system performance targets at the least cost. Least cost planning results in the best mix of practical policy and capital investments to optimize the total transportation system performance—the solution may or may not be on a state corridor. See also [Practical Design/Practical Solutions](#).

left-cross Describes the intersection conflict between a motor vehicle left-turn and bicycle through movement in the opposing direction.

legal road approach A road approach that complies with the requirements of Chapter 530 for limited access facilities and Chapter 540 for managed access facilities.

length of need The length of a traffic barrier used to shield a fixed feature.

level of service (LOS) LOS is based on peak hour, except where noted. LOS assigns a rank (A – F) to facility sections based on traffic flow concepts like density, delay, and/or corresponding safety performance conditions. (See the Highway Capacity Manual and AASHTO's Geometric Design of Highways and Streets ["Green Book"] for further details.)

life cycle cost The total cost of a project or item over its useful life. This includes all of the relevant costs that occur throughout the life of a project or item, including initial acquisition costs (such as right of way, planning, design, and construction), operation, maintenance, modification, replacement, demolition, financing, taxes, disposal, and salvage value as applicable.

light emitting diode (LED) A two-lead semiconductor light source.

limited access (L/A) Full, partial, or modified access control is planned and established for each corridor and then acquired as the right to limit access to each individual parcel (see [Chapter 520](#)).

- **acquired limited access control** Access rights have been purchased.
- **established limited access control** An access hearing has been held and the Assistant Secretary, Engineering & Regional Operations, has adopted the findings and order, which establishes the limits and level of control.
- **planned limited access control** Limited access control is planned for some time in the future; however, no access hearing has been held.

Limited Access and Managed Access Master Plan A map of Washington State that shows established and planned limited access highways: www.wsdot.wa.gov/design/accessandhearings

limited access highway All highways listed as “Established L/A” on the Limited Access and Managed Access Master Plan and where the rights of direct access to or from abutting lands have been acquired from the abutting landowners.

- **full access control** This most restrictive level of limited access provides access, using interchanges, for selected public roads/streets only, and prohibits highway intersections at grade.
- **partial access control** The second most restrictive level of limited access. At grade intersections with selected public roads are allowed, and there may be some crossings and some driveway approaches at grade. Direct commercial access is not allowed.
- **modified access control** The least restrictive level of limited access. Characteristics are the same as for partial access control except that direct commercial access is allowed.

local roads Non-state highways that are publicly owned.

long tunnel A tunnel, lid, or underpass that is greater than 80’ in length and has a length to vertical clearance ratio greater than 10:1.

low pavement type Bituminous surface treatment (BST).

low-speed roadway See [speed](#)

lumen The unit used to measure luminous flux.

luminaire A complete lighting unit comprised of a light bulb or light emitting Diode (LED) module, wiring, and a housing unit.

luminance The quotient of the luminous flux at an element of the surface surrounding the point and propagated in directions defined by an elementary cone containing the given direction, by the product of the solid angle of the cone and area of the orthogonal projection of the element of the surface on a plane perpendicular to the given direction. The luminous flux may be leaving, passing through, and/or arriving at the surface.

luminous flux The time rate of the flow of light.

M

managed access highway Highways where the rights of direct access to or from abutting lands have not been acquired from the abutting landowners.

managed lane A lane that increases efficiency by packaging various operational and design actions. Lane management operations may be adjusted at any time to better match regional goals.

managing project delivery A WSDOT management process for project delivery from team initiation through project closing.

maximum uniformity ratio The average light level within the design area divided by the minimum light level within the design area (see [Chapter 1040](#)).

maximum veiling luminance ratio The maximum veiling luminance divided by the average luminance over a given design area for an observer traveling parallel to the roadway centerline (see [Chapter 1040](#)).

mcd/m²/lux Pavement marking retroreflectivity is represented by the coefficient of retroreflected luminance (RL) measured in millicandelas per square meter.

Measures of Effectiveness (MOEs) In the context of [Chapter 320](#), examples are: speed, delay, density, LOS, QOS, person or vehicle throughput, cost vs. benefit, and queue. (See FHWA's MOE List.)

median The portion of a divided highway separating vehicular traffic traveling in opposite directions.

median functions one or more reason(s) for a median as described in [Chapter 1230](#).

median opening An opening in a continuous median for the specific purpose of allowing vehicle movement.

Memorandum of Understanding (MOU) There is one MOU (Highways Over National Forest Lands) between the United States Forest Service (USFS) and WSDOT that requires the USFS to obtain a road approach permit for new access to a state highway that is crossing Forest Service land.

metering signal A signal used to control the predominant flow rate of traffic at an at-grade facility.

Methods and Assumptions Document A mandatory document developed at the beginning of the IJR phase to record IJR assumptions, methodologies, criteria, and decisions (see [Chapter 550](#)).

Metropolitan Planning Organization (MPO) A lead agency designated by the Governor to administer the federally required transportation planning process in a metropolitan area with a population over 50,000. The MPO is responsible for the 20 year long-range plan and Transportation Improvement Program (TIP).

mil Unit of measurement equivalent to 0.001 inches.

minimum average light level The average of all light intensities within the design area, measured just prior to relamping the system (see [Chapter 1040](#)).

minimum light level The minimum light intensity of illumination at any single point within the design area measured just prior to relamping the system (see [Chapter 1040](#)).

minor arterial system A rural network of arterial routes linking cities and other activity centers that generate long distance travel and, with appropriate extensions into and through urban areas, form an integrated network providing interstate and interregional service ([RCW 47.05.021](#)).

minor operational enhancement projects These projects usually originate from the Q2 component of the Q Program and are quick responses to implement low-cost improvements. They are typically narrow in scope and focus on improvements to traffic operations and modifications to traffic control devices. Guidance on the type of work included in the Q subprograms is in the Chart of Accounts.

modal compatibility An assessment to determine which mode(s) need to be considered strictly based on the context characteristics present or planned. The assessment is independent of whether any particular mode is present on the segment, and intended to guide strategic investment opportunities on a segment.

modal priority Mode(s) that will be prioritized when making design decisions for the project, guided by the outcome of the modal compatibility assessment.

mode A specific type or form of transportation. Typically for roadway design the modes are: automobiles, transit, truck freight, pedestrians, skateboards, and bicycles.

monument As defined in [Chapter 410](#), a monument is any physical object or structure that marks or references a survey point. This includes, but is not limited to, a point of curvature (P.C.), a point of tangency (P.T.), a property corner, a section corner, a General Land Office (GLO) survey point, a Bureau of Land Management (BLM) survey point, and any other permanent reference set by a governmental agency or private surveyor.

monument removal or destruction The physical disturbance or covering of a monument such that the survey point is no longer visible or readily accessible.

mounting height – luminaire The vertical distance between the surface of the design area and the center of the light source of the luminaire. Note: This is not to be confused with pole height (H1), but is the actual distance that the luminaire is located above the roadway edge line.

movable bridge signal (also drawbridge signal) A signal installed to notify traffic to stop when the bridge is opened for waterborne traffic. Movable bridge signals display continuous green when the roadway is open to vehicular traffic.

multilane approach An approach that has two or more lanes, regardless of the lane use designation.

multimodal connection The point where multiple types of transportation activities occur; for example, where transit buses and van pools drop off or pick up passengers (including passengers with bicycles).

N

National Highway System (NHS) The NHS was developed by the U.S. Department of Transportation (DOT) in cooperation with the states, local officials, and metropolitan planning organizations (MPOs). The NHS includes the following subsystems of roadways (note that a specific highway route may be on more than one subsystem):

- **Interstate** The Eisenhower Interstate System of highways retains its separate identity within the NHS.
- **Other Principal Arterials** These are highways in rural and urban areas that provide access between an arterial and a major port, airport, public transportation facility, or other intermodal transportation facility.
- **Strategic Highway Network (STRAHNET)** This is a network of highways that are important to the United States' strategic defense policy and that provide defense access, continuity, and emergency capabilities for defense purposes.
- **Major Strategic Highway Network Connectors** These are highways that provide access between major military installations and highways that are part of the Strategic Highway Network.
- **Intermodal Connectors** These highways provide access between major intermodal facilities and the other four subsystems making up the National Highway System.

natural vehicle path The natural path that a driver navigates a vehicle given the layout of the intersection and the ultimate destination.

need A statement that identifies the transportation problem(s) or other performance gap

negative illumination Lighting the background and leaving the object dark to contrast with the light behind it as the driver views it.

network connectivity How the various roadways and other transportation facilities within a network interconnect in a defined geographic area.

nighttime The period of time from one-half hour after sunset to one-half hour before sunrise and any other time when persons or objects may not be clearly discernible at a distance of 500 feet ([RCW 46.04.200](#)).

no-build condition The baseline, plus state transportation plan and comprehensive plan improvements, expected to exist, as applied to the year of opening or the design year.

nonconforming road approach A road approach that does not meet current requirements for location, quantity, spacing, sight distance, or geometric elements.

nonrecoverable slope A slope on which an errant vehicle might continue until it reaches the bottom, without having the ability to recover control. Fill slopes steeper than 4H:1V, but not steeper than 3H:1V, are considered nonrecoverable.

nonseparated HOV lane An HOV lane that is adjacent to and operates in the same direction as the general-purpose lanes with unrestricted access between the HOV lane and the general-purpose lanes.

notice of appearance A form provided by WSDOT for anyone wanting to receive a copy of the findings and order and the adopted limited access plan (see Chapter 210).

notice of hearing (or hearing notice) A published advertisement that a public hearing will be held.

notice of opportunity for a hearing An advertised offer to hold a public hearing.

O

occupancy designation The minimum number of occupants required for a vehicle to use the HOV facility.

operating speed The speed at which drivers are observed operating their vehicles during free flow conditions.

order of hearing The official establishment of a hearing date by the Director & State Design Engineer, Development Division.

outer separation The area between the outside edge of traveled way for through traffic and the nearest edge of traveled way of a frontage road or collector-distributor (C-D) road.

overlapped displays Overlapped displays allow a traffic movement to operate with one or more nonconflicting phases. Most commonly, a minor street's exclusive right-turn phase is overlapped with the nonconflicting major street's left-turn phase. An overlapped display can be terminated after the parent phase (the main phase the overlap is associated with) terminates. An overlapped display programmed for two or more parent phases continues to display until all of the parent phases have terminated. An overlap is made up of two or more phases—not one phase controlling two movements.

P

painted nose The point where the main line and ramp lanes separate.

"pass-by" trips Pass-by trips are intermediate stops between an origin and a primary trip destination; for example, home to work, home to shopping.

passenger loading zone An area provided for pedestrians to board/disembark a vehicle.

passing lane An auxiliary lane on a two-lane highway used to provide the desired frequency of passing zones.

passing sight distance The distance (on a two-lane highway) needed for a vehicle driver to execute a normal passing maneuver based on design conditions and design speed.

pavement marking A colored marking applied to the pavement to provide drivers with guidance and other information.

peak hour The 60-minute interval that contains the largest volume of traffic during a given time period. If a traffic count covers consecutive days, the peak hour can be an average of the highest hour across all of the days. An a.m. peak is simply the highest hour from the a.m., and the p.m. peak is the

highest from the p.m. The peak hour correlates to the DHV, but is not the same. However, it is close enough on items such as intersection plans for approval to be considered equivalent.

performance-based decisions Decisions that are made based on performance, performance metrics, performance targets, and performance gaps. Also, decisions made using performance evaluation tools, such as Highway Safety Manual methodology for evaluating safety performance.

performance category Any broad area of performance important to an organization, project, or place. WSDOT's six performance categories: Economic Vitality, Preservation, Safety, Mobility, Environment, and Stewardship are a product of legislative policy.

performance evaluation tools Quantitative tools used to measure performance. Examples of these tools currently being used by WSDOT are Highway Safety Manual methodology (for safety performance) and Highway Capacity Manual (for mobility performance).

performance gap The difference between the measured and targeted performance unit for a performance metric. This gap is another way of describing the performance need(s) at a location.

performance metric Any measurable indicator used to assess the achievement of outcomes.

performance need See [baseline performance need](#) and [contextual performance need](#)

performance target(s) An outcome or desired state intended for a project. Performance targets are identified as either baseline or contextual (see [Chapter 1101](#)).

permit holder The abutting property owner or other legally authorized person to whom an access connection permit is issued by the permitting authority.

permitted access connection A connection for which an access connection permit has been issued by a permitting authority.

permitting authority The agency that has legal authority to issue managed access connection permits. For access connections in unincorporated areas, the permitting authority is WSDOT; for access connections within corporate limits, the permitting authority is a city or town.

physical nose The point, upstream of the gore, with a separation between the roadways of 16 to 22 feet (see [Chapter 1360](#)).

planning Transportation planning is a decision-making process required by federal and state law used to solve complex, interrelated transportation and land use problems.

Plans, Specifications, and Estimates (PS&E) The project development activity that follows Project Definition and culminates in the completion of contract-ready documents and the engineer's cost estimate.

pole height (H1) The vertical distance from the light source to the pole base. This distance is specified in contracts and used by the pole manufacturers to fabricate the light standard.

policy point There are eight policy points addressed in the IJR:

- Need for the Access Point Revision
- Reasonable Alternatives
- Operational & Crash Analyses
- Access Connections & Design
- Land Use & Transportation Plans
- Future Interchanges
- Coordination
- Environmental Processes

portable traffic signal A type of conventional traffic signal used in work zones to control traffic. This signal is most commonly used on two-way two-lane highways where one lane has been closed for roadwork. This signal is most commonly operated in pairs, with one signal at each end of the work zone. This eliminates the need for 24-hour flagger control. The traffic signal provides alternating right of way assignments for conflicting traffic movements. The signal has an adjustable vertical support with two three-section signal displays and is mounted on a mobile trailer with its own power source.

positive illumination Lighting the surface of the object as the driver views it.

posted speed The maximum legal speed as posted on a section of highway using regulatory signs.

Practical Design/Practical Solutions An approach to making project decisions that focuses on the specific problem the project is intended to address. This performance-based approach looks for lower cost solutions that meet outcomes that WSDOT, partnering agencies, communities and stakeholders have identified. Practical design is a fundamental component to the vision, mission, values, goals, and reforms identified in [Results WSDOT- WSDOT's Strategic Plan](#). With practical solutions, decision-making focuses on maximum benefit to the system, rather than maximum benefit to the project. Focusing on the specific project need minimizes the scope of work for each project so that system-wide needs can be optimized.

prehearing packet A concise, organized collection of all necessary prehearing data, prepared by the region and approved by the HQ Development Services & Access Manager prior to the hearing (see [Chapter 210](#)).

preliminary engineering (PE) A term used to describe the Project Delivery process from project scoping through PS&E review.

principal arterial system A connected network of rural arterial routes with appropriate extensions into and through urban areas, including routes designated as part of the Interstate System, that serves corridor movements with travel characteristics indicative of substantial statewide and interstate travel ([RCW 47.05.021](#)).

priority array A collection of similar needs identified in the HSP, prioritized based on the methodology adopted by WSDOT to meet the requirements of [RCW 47.05](#).

Priority Array Tracking System (PATS) A database that allows tracking of highway needs and their solutions. The system is designed to ensure WSDOT addresses the highest-ranked transportation needs. Deficiencies are tracked for each strategy in the HSP.

product or service Any element of a project from concept through maintenance and operation. In all instances, the required function should be achieved at the lowest life cycle cost based on requirements for performance, maintainability, safety, environment, and aesthetics.

project The Project Management Institute defines a project to be "a temporary endeavor undertaken to create a unique product or service."

Project Change Request Form A form used to document and approve revisions to project scope, schedule, or budget from a previously approved Project Definition (see Project Summary). Include copies in the Design Documentation Package.

Project Control and Reporting (PC&R) The Headquarters (HQ) Project Control and Reporting Office is responsible for monitoring, tracking, and reporting delivery of the Highway Construction Program in coordination with the Program Management offices in each of the six WSDOT regions and the Urban Corridors Office.

Project Definition (see *Project Summary*)

Project Development Approval Final approval of all project development documents by the designated representative of the approving organization prior to the advertisement of a capital transportation project (see Chapter 300).

Project Engineer This term applies to WSDOT personnel. Wherever "Project Engineer" appears in this manual, the design-builder shall deem it to mean "Engineer of Record."

Project File (PF) A file containing all documentation and data for all activities related to a project (see Chapter 300).

- **Design Documentation Package (DDP)** The portion of the Project File, including Design Approval and Project Development Approval that will be retained long term in accordance with WSDOT document retention policies. Depending on the scope of the project, it contains the Project Summary and some or all of the other documents discussed in Chapter 300. Technical reports and calculations are part of the Project File, but they are not designated as components of the DDP. Include estimates and justifications for decisions made in the DDP (see Chapter 300). The DDP explains how and why the design was chosen and documents approvals.

project management plan A formal, approved document that defines how the project is executed, monitored, and controlled. It may be in summary or detailed form and may be composed of one or more subsidiary management plans and other planning documents. For further information, see the Project Management Online Guide:

 www.wsdot.wa.gov/projects/projectmgmt/onlineguide/preconstruction.htm

project need statement A statement identifying the baseline performance need for the project. For each identified project need, there may be one or more performance metrics, targets, and gaps.

Project Scoping See [scoping phase](#).

Project Summary A set of documents consisting of the Environmental Review Summary (ERS), and Project Definition (PD). The Project Summary is part of the design documentation required to obtain Design Approval and is ultimately part of the design documentation required for Project Development Approval (see [Chapter 300](#)).

- **Environmental Review Summary (ERS)** A document that records the environmental classification (class of action) and considerations (consequences of action) for a specific project.
- **Project Definition (PD)** A document that records the purpose and need of the project, along with program level and design constraints.

Projects of Division Interest (PoDIs) A primary set of projects for which FHWA determines the need to exercise oversight and approval authority, as described in [Chapter 300](#).

proposal The combination of projects/actions selected through the study process to meet a specific transportation system need.

public art An enhancement to a functional element, feature, or place within a transportation facility to provide visual interest. The enhancement could be an addition to a functional element, integrated into a design, or for purely aesthetic purposes. An element is considered “public art” if it is beyond WSDOT standard practice for architectural treatment.

public involvement plan A plan to collaboratively involve the public in decision making, tailored to the specific needs and conditions of a project and the people and communities it serves. It is often part of a broader communications plan.

public transportation Passenger transportation services available to the public, including buses, ferries, rideshare, and rail transit.

purpose General project goals such as improve safety, enhance mobility, or enhance economic development.

Q

Quality of Service (QOS) Defined by the *Highway Capacity Manual* or by agreement. Intended to describe how well a facility or service operates or functions from the perspective of the user.

quantitative safety analysis An analysis that relies on science-based modeling associated with safety, and utilizes quantitative tools.

quantitative tools Tools used to measure performance. Examples of tools currently being used by WSDOT are:

- *Highway Safety Manual* methodology (for safety performance)
 - o Safety Analyst Toolset
 - o ISATe
 - o IHSDM

- o HSM Enhanced Spread Sheets
- o See also <http://wwwi.wsdot.wa.gov/RiskManagement/SHS/SafetyTools.htm>
- *Highway Capacity Manual* (for mobility performance)

queue cutter traffic signal A traffic signal used at highway-rail grade crossings where the queue from a downstream traffic signal is expected to extend within the Minimum Track Clearance Distance. It is used to keep vehicles from an adjacent signalized intersection from queuing on the railroad tracks.

R

ramp connection The pavement at the end of a ramp, connecting to a main lane of a roadway.

ramp (in relation to a [roadway](#)) A short roadway connecting a main lane of a highway with another facility, such as a road, parking lot, or transit stop, for vehicular use.

ramp meter A traffic signal at a freeway entrance ramp that allows a measured or regulated amount of traffic to enter the freeway.

ramp terminal An intersection at the end of a ramp.

Record of Decision (ROD) Under the National Environmental Policy Act, the Record of Decision accompanies the Final Environmental Impact Statement; explains the reasons for the project decision; discusses alternatives and values considered in selection of the preferred alternative; and summarizes mitigation measures and commitments that will be incorporated in the project.

recoverable slope A slope on which the driver of an errant vehicle can regain control of the vehicle. Slopes of 4H:1V or flatter are considered recoverable.

recovery area The minimum target value used in highway design when a fill slope between 4H:1V and 3H:1V starts within the Design Clear Zone.

Recreational Vehicle Account In 1980 the RV account was established for use by the department of transportation for the construction, maintenance, and operation of recreational vehicle sanitary disposal systems at safety rest areas ([RCW 46.68.170](#)). A recreational vehicle sanitary disposal fee is required for registration of a recreational vehicle ([RCW 46.17.375](#)). Adjustments to the recreational vehicle fee by the department of transportation may be implemented after consultation with the citizens' representatives of the recreational vehicle user community ([RCW 47.01.460](#)).

Regional Transportation Planning Organization (RTPO) A planning organization authorized by the Legislature in 1990 as part of the Growth Management Act. The RTPO is a voluntary organization with representatives from state and local governments that are responsible for coordinating transportation planning activities within a region.

relocation assistance program A program that establishes uniform procedures for relocation assistance that will ensure legal entitlements and provide fair, equitable, and consistent treatment to persons displaced by WSDOT-administered projects, as defined in the [Right of Way Manual](#).

Request for Proposal (RFP) The document package issued by WSDOT requesting submittal of proposals for the project and providing information relevant to the preparation and submittal of proposals, including the instructions to proposers, contract documents, bidding procedures, and reference documents.

rest area An area to the side of a path.

résumé An official notification of action taken by WSDOT following adoption of a findings and order (see Chapter 210).

retroreflection The phenomenon of light rays striking a surface and being returned directly back to the source of light.

retroreflectometer An instrument used to measure retroreflectivity.

right-hook Potential intersection conflicts between motor vehicles making a right turn and the bicycle through movement.

right of way (R/W) A general term denoting land or interest therein, acquired for or designated for transportation purposes. More specifically, lands that have been dedicated for public transportation purposes or land in which WSDOT, a county, or a municipality owns the fee simple title, has an easement devoted to or required for use as a public road/street and appurtenant facilities, or has established ownership by prescriptive right.

right of way and limited access plan (R/W and L/A plan) A right of way plan that also shows limited access control details.

road approach An access point, other than a public road/street, that allows access to or from a limited access highway on the state highway system.

road approach design template The design geometric criteria for a road approach based on the usage, types of vehicles, and traffic volume.

roadside park A roadside user facility for safe vehicular parking off the traveled way and separated from the highway by some form of buffer. These sites might be equipped with features or elements such as points of interest, picnic tables, and/or vault toilet buildings. Unlike a safety rest area, a roadside park does not always provide a permanent restroom building.

roadway The portion of a highway, including shoulders.

roadway luminance The light projected from a luminaire that travels toward a given area, represented by a point on the pavement surface, and then back toward the observer, opposite to the direction of travel. The units of roadway luminance are footcandles.

roundabout A circular intersection at grade with yield control of all entering traffic, channelized approaches with raised splitter islands, counter-clockwise circulation, and appropriate geometric curvature to force travel speeds on the circulating roadway generally to less than 25 mph.

rumble strips Rumble strips are grooves or rows of raised pavement markers placed perpendicular to the direction of travel to alert inattentive drivers.

rural design area An area that meets none of the conditions to be an urban design area.

rural intersection An intersection in a rural design area.

S

Safety Analyst A program developed to implement the Highway Safety Manual methodology

safety rest area (SRA) A roadside facility equipped with permanent restroom building(s), a parking area, picnic tables, refuse receptacles, illumination, and other ancillary services. SRAs typically include potable water and might include traveler information and telephones.

Safety Rest Area Strategic Plan Developed in 2008 under a stakeholder-coordinated effort of executive and advisory team members, this plan provides guidance for current and future management of the SRA program.

sawtooth berth A series of bays that are offset from one another by connecting curb lines, constructed at an angle from the bus bays. This configuration minimizes the amount of space needed for vehicle pull in and pull out.

scoping phase An initial phase of project development for a specific project. The scoping phase precedes the design and/or preliminary engineering phase and is intended to support priority programming and budget building scenarios. The [Project Summary](#) is the documentation developed during this phase.

security lighting A minimal amount of lighting used to illuminate areas for public safety or theft reduction. Security lighting for walkways is the lighting of areas where shadows and horizontal and vertical geometry obstruct a pedestrian's view.

"select zone" analysis A traffic model run, where the related project trips are distributed and assigned along a populated highway network. This analysis isolates the anticipated impact on the state highway network created by the project.

separated HOV facility An HOV roadway that is physically separated from adjacent general-purpose lanes by a barrier or median, or is on a separate right of way.

service life The service life of a pavement marking is the time or number of traffic passages required for its retroreflectivity to decrease from its initial value to a minimum threshold value indicating that the marking needs to be refurbished or replaced.

shared roadway A roadway that is open to both bicycle and motor vehicle travel. This may be a new or existing roadway/highway, a street with wide curb lanes, or a road with paved shoulders.

shared-use landing A level (0 to 2% grade cross slope and running slope) paved area within the shared-use path, designed to provide turning and maneuvering space for wheelchair users and as a resting place for pedestrians.

shared-use path A facility physically separated from motorized vehicular traffic within the highway right of way or on an exclusive right of way with minimal crossflow by motor vehicles. Shared-use paths are primarily used by bicyclists and pedestrians, including joggers, skaters, and pedestrians with disabilities, including those who use nonmotorized or motorized wheeled mobility devices. With appropriate design considerations, equestrians may also be accommodated by a shared-use path facility.

short tunnel A tunnel, lid, or underpass that is shorter than 80' in length and has a length to vertical clearance ratio of 10:1 or less.

shoulder The portion of the roadway contiguous with the traveled way, primarily for accommodation of stopped vehicles, emergency use, lateral support of the traveled way, and where allowed, use by pedestrians and bicycles.

shoulder width The lateral dimension of the shoulder, measured from the edge of traveled way to the edge of roadway or the face of curb.

shy distance The distance from the edge of the traveled way beyond which a roadside object might not be perceived by a typical driver as an immediate feature to be avoided to the extent that the driver will change the vehicle's placement or speed.

sight distance The length of highway visible to a driver.

Signal Maintenance Management System (SIMMS) A database used for traffic signals, illumination, and Intelligent Transportation Systems (ITS). SIMMS is used to establish an inventory base, enter work reports, print timesheets, and store maintenance records for electrical/electronics systems within WSDOT right of way.

signed shared roadway A shared roadway that has been designated by signing as a route for bicycle use.

single-lane roundabout A roundabout having single-lane entries at all legs and one circulating lane.

single-occupant vehicle (SOV) Any motor vehicle other than a motorcycle carrying one occupant.

site Parcel(s) of land bounded by a property line or a designated portion of a public right of way.

site design Style and configuration of the built environment or parcel(s).

slip base A mechanical base designed to allow the light standard to break away from the fixed foundation when hit by a vehicle traveling at the design speed and traveling at a departure angle less than or equal to the design departure angle.

slip lane A lane that separates heavy right-turn movements from the roundabout circulating traffic (see [Chapter 1320](#)).

slip ramp A connection between legs of an intersection that allows right-turning vehicles to bypass the intersection or a connection between an expressway and a parallel frontage road. These are often separated by an island.

slow-moving vehicle turnout A shoulder area widened to provide room for a slow-moving vehicle to pull out of the through traffic, allow vehicles to pass, and then return to the through lane.

speed The operations or target or posted speed of a roadway. There are three classifications of speed established:

- **Low speed** is considered 35 mph and below.
- **Intermediate speed** is considered 40-45 mph.
- **High speed** is considered 50 mph and above.

speed limit sign beacon A beacon installed with a fixed or variable speed limit sign. The preferred display is two flashing yellow indications.

speed management An engineered effort to achieve a targeted speed.

speed transition segment An engineered segment of road intended to lower the operating speed between contexts with different target speeds.

splitter island The raised island at each two-way leg between entering and exiting vehicles, designed primarily to control the entry and exit speeds by providing deflection. They also discourage wrong-way movements, and provide pedestrian refuge.

spraying A procedure for applying marking material to a surface as a jet of fine liquid particles.

state highway system All roads, streets, and highways designated as state routes in compliance with [RCW 47.17](#).

Statewide Transportation Improvement Program (STIP) A planning document that includes all federally funded projects and other regionally significant projects for a three-year period.

static scale A scale that requires a vehicle to stop for weighing.

stopping sight distance The distance needed for a driver to stop a vehicle traveling at design speed based on design conditions.

stop sign beacon A beacon installed above a stop sign. The display is a flashing red indication.

streetside zone The portion of the public right of way dedicated to the pedestrian thoroughfare and supporting the accessibility, activities and functions of the local land use. The streetside zone is comprised of a frontage zone, pedestrian zone, furnishing zone and parking zone (see [Chapter 1230](#)). Note some local agencies may divide the streetside zone.

study area The transportation system area to study in the study process and for an IJR. The study area is a minimum of one interchange upstream and downstream from the proposal. The study area shall also include the intersecting roadway in the area to the extent necessary to ensure its ability to collect and distribute traffic to and from the interchange. The study area should be expanded as necessary to capture operational impacts of adjacent interchanges in the vicinity that are, or will be, bottlenecks or chokepoints that influence the operations of the study interchange.

study plan A term associated with environmental procedures, this plan proposes an outline or “road map” of the environmental process to be followed during the development of a project that requires complex NEPA documentation (see [Chapter 210](#) and the *Environmental Manual*).

subject matter expert A person who is an authority in a particular area or topic, and understands the data and the limitations on the use and application of the data.

suburban area A term for the area at the boundary of an urban design area. Suburban settings may combine higher speeds common in rural design areas with activities more common to urban settings.

superelevation The rotation of the roadway cross section in such a manner as to overcome part of the centrifugal force that acts on a vehicle traversing a curve.

superelevation runoff The length of highway needed to accomplish the change in cross slope from a section with adverse crown removed (level) to a fully superelevated section, or vice versa.

superelevation transition length The length of highway needed to change the cross slope from normal crown or normal pavement slope to full superelevation.

support team An integral part of the IJR process consisting of an assemblage of people from the regions, FHWA (for Interstates), WSDOT HQ Access and Hearings, and other representatives organized to develop and analyze alternatives to meet the need of a proposal, including approval authorities.

Surface Transportation Program (STP) A federal program established by Congress in 1991 that provides a source of federal funding for highway and bridge projects.

T

tangent runoff The length of highway needed to change the cross slope from normal crown to a section with adverse crown removed (level).

target speed A proactive approach to establishing a speed consistent with the context characteristics. Target speed is the design operating speed, which aligns design, posted and operating speed as the same value.

team management The direction of a group of individuals that work as a unit. Effective teams are results-oriented and are committed to project objectives, goals and strategies.

temporary traffic signal A conventional traffic signal used during construction to control traffic at an intersection while a permanent signal system is being constructed. A temporary traffic signal is typically an inexpensive span-wire installation using timber strain poles.

Total Project Costs The costs of all phases of a project, including environmental, design, right of way, utilities, and construction.

tradeoffs analysis An analysis method for balancing factors, performance or outcomes, which are not attainable at the same time.

traffic barrier A longitudinal barrier, including bridge rail or an impact attenuator, used to redirect vehicles from fixed features located within an established Design Clear Zone, help mitigate median crossovers, reduce the potential for errant vehicles to travel over the side of a bridge structure, or (occasionally) protect workers, pedestrians, or bicyclists from vehicular traffic.

traffic barrier/longitudinal barrier A device oriented parallel or nearly parallel to the roadway whose primary function is to contain or safely redirect errant vehicles away from fixed features or to (occasionally) protect workers, pedestrians, or bicyclists from vehicular traffic. Beam guardrail, cable barrier, bridge rail, concrete barrier, and impact attenuators are barriers, and they are categorized as rigid, rigid anchored, unrestrained rigid, semirigid, and flexible. They can be installed as roadside or median barriers.

traffic calming treatments Treatments along the roadway that can be used to reduce speeds through a section of roadway (see [Chapter 1103](#)).

Traffic Impact Analysis (TIA) (sometimes called *Traffic Impact Study (TIS)*) If a traffic analysis is not an IJR, it is a TIA. TIAs are used for environmental reviews and developer projects (see [Chapter 320](#)).

traffic paint A pavement marking material that consists mainly of a binder and a solvent. The material is kept in liquid form by the solvent, which evaporates upon application to the pavement, leaving the binder to form a hard film.

transit A general term applied to passenger rail and bus service used by the public.

transit facility A capital facility that improves the efficiency of public transportation or encourages the use of public transportation.

transit flyer stop A multimodal connection located within the boundaries of a limited access facility.

transition A section of barrier used to produce the gradual stiffening of a flexible or semirigid barrier as it connects to a more rigid barrier or fixed object.

transit lane A lane for the exclusive use of transit vehicles.

transit stop A facility for loading and unloading passengers that is set aside for the use of transit vehicles only.

transit vehicle A bus or other motor vehicle that provides public transportation (usually operated by a public agency).

Transportation Improvement Program (TIP) A three-year transportation improvement strategy required from MPOs by Congress, which includes all federally funded or regionally significant projects.

Transportation Information and Planning Support (TRIPS) A mainframe computer system designed to provide engineering, maintenance, planning, and accounting staff with highway inventory, traffic, and accident data.

Transportation Management Area (TMA) Urbanized areas with populations of 200,000 or greater are federally designated as Transportation Management Areas.

transportation management plan (TMP) A set of traffic control plans, transportation operations plans, and public information strategies for managing the work zone impacts of a project. A TMP is required for all projects to address work zone safety and mobility impacts.

Transportation Planning Studies These studies identify the current functions of a corridor and forecast future demands on the system. Data collection and public involvement are used to forecast future needs that will improve the function of a state route.

travel demand The demand travelers will make on the system based on the number and types of trips they will take and the mode and routes they will use. Local travel demand represents short trips that should be made on the local transportation system, such as intracity roads and streets. Regional travel demand represents long trips that are made on the regional transportation system, such as Interstate, regional, and/or intercity/interregional roads, streets, or highways.

traveled way The portion of the roadway intended for the movement of vehicles, exclusive of shoulders and lanes for parking, turning, and storage for turning.

traveled way zone The portion of the roadway intended for the movement of people and goods, exclusive of shoulders, roadsides, on-street parking, medians and streetside zones.

traveler information Commercial and noncommercial information that informs and orients the traveling public. This includes access information for food, gas, lodging, local attractions, regional tourist attractions, roadway conditions, and construction schedules.

traveling public Motorists, motorcyclists, bicyclists, pedestrians, and pedestrians with disabilities.

trips Short trips are normally local. Long trips are normally interstate, regional, or interregional.

truck apron The optional mountable portion of the central island of a roundabout between the raised nontraversable area of the central island and the circulating roadway (see [Chapter 1320](#)).

turning radius The radius that the front wheel of the intersection design vehicle on the outside of the curve travels while making a turn (see [Chapter 1320](#)).

turning roadway A curve on an open highway, a ramp, or the connecting portion of the roadway between two intersecting legs of an intersection.

two-way left-turn lane (TWLTL) A lane, located between opposing lanes of traffic, to be used by vehicles making left turns from either direction, from or onto the roadway.

U

undivided multilane A roadway with two or more through lanes in each direction on which left turns are not controlled.

uniformity ratio The ratio of the minimum average light level on the design area to the minimum light level of the same area (see [Chapter 1040](#)).

urban area An area designated by the Washington State Department of Transportation (WSDOT) in cooperation with the Transportation Improvement Board (TIB) and Regional Transportation Planning Organizations (RTPO), subject to the approval of the Federal Highway Administration (FHWA).

urban design area An area where urban design criteria are appropriate, that is defined by one or more of the following:

- An urban area.
- An area within the limits of an incorporated city or town.
- An area characterized by intensive use of the land for the location of structures, that receives urban services such as sewer, water, and other public utilities, as well as services normally associated with an incorporated city or town. This may include an urban growth area defined under the Growth Management Act (see [RCW 36.70A](#), Growth management – Planning by selected counties and cities), but outside the city limits.
- An area with not more than 25% undeveloped land.

urban intersection An intersection in an urban design area .

urbanized area An urban area with a population of 50,000 or more.

usable shoulder The width of the shoulder that can be used by a vehicle for stopping.

V

validation A process to confirm the reasonableness, accuracy and completeness of estimated costs and quantities.

Value Engineering (VE) Analysis A systematic approach to identifying and removing unnecessary costs which do not contribute to a desired result by analyzing cost versus function.

Value Engineering Change Proposal (VECP) A construction contract change proposal submitted by the construction contractor based on a VECP provision in the contract. The intent of these types of proposals is to (1) improve the project's performance, value, and/or quality, (2) lower construction costs, or (3) shorten the delivery time, while considering their impacts on the project's overall life-cycle cost and other applicable factors.

Value Engineering (VE) Job Plan A systematic and structured action plan (see [Chapter 310](#)) for conducting and documenting the results of the VE analysis. While each VE analysis shall address each phase in the VE Job Plan, the level of analysis conducted and effort expended for each phase should be

scaled to meet the needs of each individual project. The VE Job Plan shall include and document the following phases:

1. Information Phase: Gather project information, including project commitments and constraints.
2. Function Analysis Phase: Analyze the project to understand the required functions.
3. Creative Phase: Generate ideas on ways to accomplish the required functions, which improve the project's performance, enhance its quality, and lower project costs.
4. Evaluation Phase: Evaluate and select feasible ideas for development.
5. Development Phase: Develop the selected alternatives into fully supported recommendations.
6. Presentation Phase: Present the VE recommendation to the project stakeholders.
7. Resolution Phase: Evaluate, resolve, document, and implement all approved recommendations.

Post-analysis Job Plan activities include the implementation and evaluation of the outcomes of the approved recommendations. These post-analysis phases are conducted in accordance with the policies in WSDOT *Design Manual Chapter 310* and as described in paragraph 4f of FHWA Order 1311.1A, FHWA Value Engineering Policy.

variance, variability Inherent fluctuations due to random events that result in a range of potential values for a quantity.

veiling luminance The stray light produced within the eye by light sources produces a veiling luminance that is superimposed on the retinal image of the objects being observed. This stray light alters the apparent brightness of an object within the visual field and the background against which it is viewed, thereby impairing the ability of the driver to perform visual tasks. Conceptually, veiling luminance is the light that travels directly from the luminaire to the observer's eye.

viewpoint A roadside stopping opportunity with a view of some point of interest or area scenery. This area is not typically separated from the traveled way by some form of highway buffer.

violation rate The total number of violators divided by the total number of vehicles on an HOV facility.

visioning exercises a process of determining the goals for a facility or place.

Visitor Information Center (VIC) A staffed or nonstaffed booth or separate building that displays and dispenses free tourist travel maps and brochures. These are typically located at border-entry SRAs to provide travel information to highway users as they enter the state.

W

warning beacon A beacon that supplements a warning or regulatory sign or marking. The display is a flashing yellow indication. These beacons are not used with STOP, YIELD, or DO NOT ENTER signs or at intersections that control two or more lanes of travel. A warning identification beacon is energized only during those times when the warning or regulation is in effect.

warrant A minimum condition for which an action is authorized. Meeting a warrant does not attest to the existence of a condition that needs attention. Further justification is required.

Washington State Pavement Management System (WSPMS) A computer system that stores data about the pavement condition of all the highways in the state. Information available includes the latest field review and past contracts for every main line mile of state highway. Calculations are used to determine whether a given section of pavement is a past due, due, or future due preservation need.

Washington Transportation Plan (WTP) A WSDOT planning document developed in coordination with local governments, regional agencies, and private transportation providers. The WTP addresses the future of transportation facilities owned and operated by the state as well as those the state does not own but in which it has an interest. It identifies needed transportation investments, which are defined by service objectives and specific desired outcomes for each transportation mode.

weaving section A length of highway over which one-way traffic streams cross by merging and diverging maneuvers.

weigh in motion (WIM) A scale facility capable of weighing a vehicle without the vehicle stopping.

wet film thickness Thickness of a pavement marking at the time of application without glass beads.

work zone An area of a highway with construction, maintenance, or utility work activities. A work zone is identified by the placement of temporary traffic control devices that may include signs, channelizing devices, barriers, pavement markings, and/or work vehicles with warning lights. It extends from the first warning sign or high-intensity rotating, flashing, oscillating, or strobe lights on a vehicle to the END ROAD WORK sign or the last temporary traffic control device ([MUTCD](#)).

work zone impact Highway construction, maintenance, or utility work operations in the traveled way, adjacent to the traveled way, or within the highway's right of way that creates safety and mobility concerns for workers or the traveling public.

work zone traffic control The planning, design, and preparation of contract documents for the modification of traffic patterns due to work zone impacts.

wye (Y) connection An intersecting one-way roadway, intersecting at an angle less than 60°, in the general form of a "Y."

Y

yield-at-entry The requirement that vehicles on all entry lanes yield to vehicles within the circulating roadway.

yield point The point at which entering traffic must yield to circulating traffic before entering the circulating roadway (see [Chapter 1320](#)).

