

---

## Part 5: other comments

### Funding New WSF Ferries

In the past 10 years WSF has made good progress in its effort to replace aging ferries. The three 64 car ferries, and the four 144 car ferries are a good start in a race to catch up after decades during which no new boats were added to the fleet. And, today, of course, there are no backup boats, causing havoc each time a vessel needs planned or unplanned maintenance/repair.

Simply to maintain WSF's current fleet at its current level of service, given the necessary retirement of aging vessels, it is estimated that one new boat has to be added to the fleet every two years for the next 26 years, with a total estimated cost of \$2.6 Billion, an average of \$200 Million per ferry.

Few would challenge the need, and all appreciate WSF's focus on long-term planning. Without a well thought-out strategic plan, the iconic economic powerhouse that drives and supports tourism and commerce in Washington State would be jeopardized.

There is one element in this plan, however, that can and must be fixed. There is no amount of logic or common sense that justifies the amount that WSF is spending for its new boats. No one would or should knowingly pay twice as much as necessary for each new ferry.

Currently there are three scenarios (two that are realistic) for building boats for WSF:

1. "Build In Washington"
2. Build in US
3. Build Internationally

"Build In Washington" - although the "Build In Washington" law was established with the best of intentions, recognizing the trickle down benefits to Washington State companies and residents from any construction project of this size, it has become the single most counterproductive measure for building WSF ferries. Any single bidder project is fundamentally flawed when it comes to competition for cost and quality (with a corrected view of the apprentice requirement, there are other options). Not only has this measure resulted in extremely high construction costs, it has also locked Washington State out of possible federal boat construction funds, and unnecessarily squeezed hundreds of millions of dollars out of the pockets of Washington taxpayers. The "Build In Washington" measure causes more financial damage than benefit.

Build in US - It is no secret that similarly designed 64 car ferries have been built in the US for less than half the cost of building the same boats in Washington State. Continuing on this course for the next 26 years can only increase the economic damage for residents of this state.

Build Internationally - Although it would literally take an act of Congress to construct WSF ferries overseas, the vast potential savings cannot be overlooked.

With regards to WSF, probably the most comparable example of overseas construction relates to the 2014 contract between BC Ferries and the Remontowa Shipbuilding company in Gdansk, Poland for the construction of three 145 car ferries for \$165 Million (each WSF 144 car ferry costs about \$130 Million).

The \$165 Million figure for three boats doesn't tell the entire story. The total contract for those three ferries is \$252 Million (\$84 Million each), but includes financing, project management and \$51 Million for Canadian taxes and federal import duties. The boats will run on LNG, with diesel as backup. The bid that BC Ferries chose was not the lowest. As we know, BC Ferries is adding beautiful and well built boats to its fleet. Other bids were submitted by firms in Norway, Turkey, North Vancouver, and Germany.

As a matter of interest, several years ago, WSF toyed with the idea of purchasing some European ferries and retro-fitting them to be usable at WSF docks.

Changing the way Washington State builds ferries is imperative. Expecting Washington State residents to bear the financial burden associated with the current arrangement is unacceptable, especially while looking at the plan for the next 26 years.

---

## WSF 2040 PLAN INPUT – FROM STEVE STOCKETT – ZONE24X7

After working on the complexities of a ferry technology project nearly full time and spending over \$100,000 in solution design and intellectual property development I have learned that WSF has perhaps the most overworked, underappreciate management staff I have ever encountered in such a complex operational environment and with such big dollar numbers at stake. You guys need a large dollar increase in management and long-range planning staff given the huge numbers and operating opportunities that exist over the next several years. I realize you have given me more time than you have available but not enough time for me to even scratch the surface of our short, medium- and long-term technology solutions for WSF and the DOT.

My response to your draft 2040 plan is as a 40 plus year- 5000 trip ferry user, as a Wedding Venue business owner on Vashon, and as a Principal in Zone24x7's Maritime/Parking Industry initiatives. I am bringing to your problems 45 years of experience in identifying and solving a myriad of small to large operational problems with best practices procedures designed to seamlessly integrate to old, new, and unique custom technologies. I have developed the intellectual property business processes to just about every unique solution needed to reserve, sell/collect fares and the operational procedures and technologies to interact in any way with Maritime Vessel's. This includes Artificial Intelligence, Big Data, Robotics, Sensors, and Personal Technology Apps. Zone24x7 has designed the hardware and software over the last 18 months to be able to pilot these technologies and operational procedures in a proof of concept on the Triangle Route as early as mid-2019. We are proposing such a proof of concept pilot be approved in the upcoming Legislative Session. The proven technologies would be available in the medium – based on competitive bidding from anyone you want – including open licensing of our intellectual property – to roll out systemwide – truly revolutionizing the WSF.

### Problem 1: Demographic and Ferry Usage Forecasting

Your preliminary plan fails to recognize that one of the primary reasons that your mid sound destinations are failing to grow is that a lack of transportation options, and increasingly difficult wait, frequency, and reliability time problems have choked off growth. I encourage you to, as an example, go back to your forecast source and ask them if there might not be a monumental shift in their forecast if Vashon had ferry service every 30 minutes 16 hours a day and every 45 minutes the other 8. I suspect they will say barring other growth restriction factor that population would double over the next 20 years.

As you say your whole plan hinges on the accuracy of the traffic forecasts. If you look at the geographic and demographics of WSF served less populated areas explosive growth could occur with better transportation,

### Problem 2: Constricted funding for Technology in the Short and Medium Term - and Long term!

There are technologies already out there in the world in a variety of settings that could move your existing customer base, on your existing boats, from your existing docks at least 30% faster, with less dock neighborhood congestion, at less cost and with higher revenues. This is the Proof of concept Pilot I am proposing for the Tringle route starting as early as 2019 and getting better and better over time.

Technologies from red traffic cones to robotics that exist today could dramatically reduce dwell time as well as crossing time. Cutting the cycle time on each unique route can add easily up to 25% more runs

---

during your peak 16 hour on every route with the only increase in costs coming from more fuel due to more, faster crossings. Tens of millions of dollars in annual savings on toll booth operations and traffic management is also very feasible. Finally saving literally millions of hours per year of your customers time in their portal to portal travel will result in traffic and income to you and very grateful customers. Investing 2% more of the budget you are proposing for boats into technology solutions will more quickly and more completely solve your current problems than the boats will.

Problem 3 – No serious considerations of alternatives to doing things – including boat capital – exactly the way you always have.

Going from a proposed fleet of 26 144 cars and up boats to a fleet of 30 much smaller cheaper, faster “quick load/unload/fast ferries would save billions for dollars in capital and tens of millions in annual operating costs. This current technology boat with the custom modifications to support WSF short haul, fast turnaround needs would allow you to carry 50% more people and cars, twice as fast, and with greatly reduced neighborhood impacts than your proposed plan.

I understand you have urgent 2019-2022 needs which you should pursue. However, you should during that same time frame do a Proof of Concept Trial with existing assets and minimal added technology. You should also vet out and do a trial with a purchased, retrofitted fast ferry – or at least design one with based on existing designs. You should take this next 2 years to evaluate big, slow boats vs. fast small boats.

Based on our study of the industry and the problems that WSF faces launching at 21<sup>st</sup> century Mosquito Fleet of super-fast ferries on Puget Sound would make you guys super heroes.

---

To view the current LRP go here: <<https://wsflongrangeplan.com/>>.  
To comment on it go to the comments page here: <<https://wsflongrangeplan.com/comment/>>  
or send them directly to WSF via the e-mail here: < [WSFLongRangePlan@WSDOT.wa.gov](mailto:WSFLongRangePlan@WSDOT.wa.gov) >.  
Additionally, they have a survey here: < <http://sgiz.mobi/s3/WSF-Long-Range-Plan-Survey> >

---

**Doug Rauh**  
**Bainbridge Island, WA**

**comments on Washington State Ferries (WSF) 2040 Long Range Plan** as of 2018 05 23.

WSF needs to plan for conversion of the current fleet of ferries to lighter, smaller ferries using less polluting propulsion systems, lower operating cost, lower Life-Cycle Cost ferries and increase utilization of technology.

---

### **Ferries Classes:**

One class for routes with **large walk-on** demand and little capacity on the land side transportation system for vehicles. The other class would be for routes with smaller walk-on demand and **large requirement for vehicles capacity**. These routes have little land side restriction for additional vehicle demand. The ferry and terminal design should go back to basics of just moving people and vehicles across salt water. WSF primary goal should be transportation and everything else is optional.

---

### **Routes:**

The (Bainbridge to Seattle) and (Bremerton to Seattle) routes are **vehicle limited** at the Seattle terminal. Both of these routes should have three smaller ferries with small vehicle decks and extra walk-on capacity. All other routes need larger vehicle space and smaller walk-on capacity. The Bainbridge to Seattle and the Bremerton to Seattle should have 3+ smaller ferries. The more frequent service would reduce the ferry traffic impact on the land side infrastructure like SR-305. This would also align the route capacity to the highway capacity and/or local policy on congestion.

---

### **Ferry Weight:**

Any new WSF ferry should have a weight similar to the Norwegian “**Ampere**” ferry. Aluminum and **light weight material** should be used in construction in order to reduce the energy needed to move the ferry between terminals.

---

### **Ferry Propulsion Energy Type:**

The current **Diesel** option creates a large amount of **Green House Gas**. The other available options are **Electric, LNG and Hybrid-Electric**. **Norway** and **Finland** have moved toward **Electric** because they have hydroelectric power similar to Washington State.

---

### **Technology:**

**Autonomous** software for ferry routes, auto-**docking** software, automatic **mooring** and auto **electrical connection**.

---

### **Ferry Propulsion System:**

Current WSF ferries do not use azimuth drive systems. Ferries using **azimuth propulsion** have better handling in current, wind and much **shorter turning radius**. During collision avoidance an azimuth system could turn the ferry faster.

---

Saturday, April 28, 2018      Doug Rauh’s Bainbridge Island comments on WSF 2040 Long Range Plan      Page 1 of 43

---

### **Ferry Maintenance:**

An **aluminum hull does not require painting** like steel and is lighter.

---

### **Ferry Operational Life:**

The current design life of a ferry is **60 years WSF policy**.

The long life requires a mid-life upgrade.

Mid-life upgrades are expensive and takes the ferry out of service.

A shorter life that does not require a mid-life upgrade would be in line with what other ferry systems are doing.

Replacement ferry could be built while the ferry to be replaced continued service.

---

### **Ferry Life Cycle Cost:**

The **Initial Cost** of a ferry has resulted in ferries that have **higher fuel costs** thus **higher Life Cycle Cost**.

**Higher operating costs** result in **higher fares** due to high fare-box recovery rate which reduces demand for the service.

---

### **Ferry Price:**

Past ferry prices have been 2+ times the price paid by other ferry systems for similar boats.

**Construction** and **Financing Costs** need to be reduced.

---

### **Ferry Fares:**

Ferry **deck space** needs to be charged by **actual space used**.

---

### **Ferry Financial Model:**

Current WSF financial model is based on shifting a larger percentage of fare increases from people to vehicles.

**Will this vehicle biased revenue model be sustainable as autonomous vehicles replace privately owned vehicles?**

---

### **Ferry System Demographics:**

As **Baby Boomer ferry users age out** of the work force will peak demand for service shift to mid-day?

---

### **Terminal Automation:**

**The Vehicle Ticketing process from highway to holding needs more automation.**

All passenger **turnstiles need to accommodate commuters with computer roller cases** and travelers with luggage.

---

### **Terminal to Ferry Loading:**

Needs to be **more efficient** and **safer** for both passengers and vehicles.

---

### **Online Ticket sales**

**Seniors are not allowed to buy discounted senior ticket online per WSF policy.**

WSF ticket process should validate the **right to use** a particular ticket **at time of use** **NOT** at the **time of purchase**.

---

---

## Everything below this point is Reference Material

In the same order as the comments points above

Comment Points are in bold and gray background

Doug Rauh's comments or emphasis in references are in yellow and/or bold.

---

### Ferries Classes:

One class for routes with **large walk-on** demand and little capacity on the land side transportation system for vehicles. The other class would be for routes with smaller walk-on demand and **large requirement for vehicles capacity**.

These routes have little land side restriction for additional vehicle demand.

The ferry and terminal design should go back to basics of just moving people and vehicles across salt water.

WSF primary goal should be transportation and everything else is optional.

---

Both the **Bainbridge to Seattle** and **Bremerton to Seattle** would function more efficiently with three **smaller** ferries on each route.

These ferries should carry fewer vehicles (60-120?) and (1,000-2,000?) passengers.

Assume slower crossing speed with more frequent sailings.

Mid-day each ferries could skip a run and be fully recharged.

This would reduce large pulse of vehicles into the Seattle street system and its related congestion.

All other routes would use a ferry with a large vehicle deck and a smaller passenger space in order to match demand while keeping the ferry light and the crew size small.

The aluminum hull design for both ferries could be the same or similar.

<https://hiveminer.com/Tags/electricferry,ferry> pictures of Norway's Ampere all electric ferry

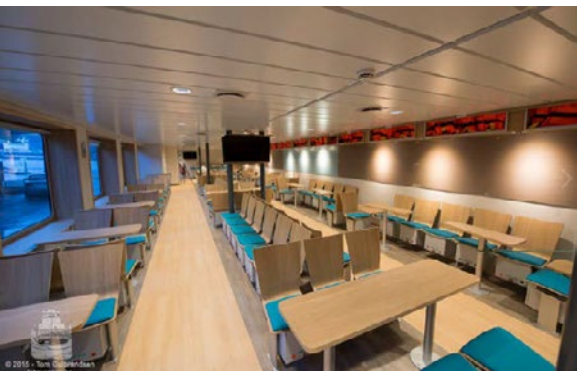

<https://www.siemens.com/innovation/en/home/pictures-of-the-future/mobility-and-motors/electromobility-electric-ferries.html>

---



---

### Routes:

The (Bainbridge to Seattle) and (Bremerton to Seattle) routes are **vehicle limited** at the Seattle terminal. Both of these routes should have three smaller ferries with small vehicle decks and extra walk-on capacity. All other routes need larger vehicle space and smaller walk-on capacity. The Bainbridge to Seattle and the Bremerton to Seattle should have **3+** smaller ferries. The more frequent service would reduce the ferry traffic impact on the land side infrastructure like SR-305. This would also align the route capacity to the highway capacity and Seattle's proposed congestion toll.

---

<https://www.seattletimes.com/seattle-news/transportation/seattle-mayor-wants-a-tolling-plan-to-reduce-traffic-congestion-greenhouse-gases/>

### Tolls on downtown streets? **Seattle mayor pushes for plan to cut traffic, greenhouse gases**

Originally published **April 4, 2018** at 6:00 am Updated April 4, 2018 at 11:06 am

**If Mayor Jenny Durkan implements widespread tolling of city roadways, Seattle would be the nation's first city to establish such systemwide tolling.**

---

### **WSF could supplement a car ferry with an all electric passenger ferry similar to the Norwegian "Future of the Fjords" on the Bainbridge to Seattle route.**

An all-electric ferry on the Bainbridge route would allow WSF to slow down the larger heavier vehicle ferries thus saving fuel and reducing Green House Gas.

<https://worldmaritimeneews.com/archives/250388/zero-emission-passenger-ship-joins-the-fjords/>



### **Zero Emission Passenger Ship Joins The Fjords**

[zoom](#)Image Courtesy: The Fjords

Norwegian transportation company The Fjords has taken delivery of its zero emission passenger vessel, **Future of The Fjords**.

Featuring a length of 42 meters, the **all-electric catamaran** will begin operation in mid-May, making around 700 yearly round trips along the UNESCO World Heritage-listed fjord route between Flåm and Gudvangen. The Fjords said that this is the first vessel of its kind to offer **completely emission free** transport through the Western Norwegian landscape.

**Future of The Fjords** is the **sister ship** to **Vision of The Fjords**, a **diesel electric hybrid** launched in 2016. Although both ships are designed and constructed by Norwegian shipyard Brødrene Aa, they are very different.

“Vision of The Fjords was an important development for us, but we had the ambition to take it one step further and **replace the diesel electric propulsion with all-electric** – thus **eradicating all noise** and **emissions to air for the entire route**. Future of The Fjords does just that, minimising its impact on the environment while maximising the experience of passengers,” Rolf Sandvik, The Fjords CEO, said.

The NOK 144 million vessel is propelled by **two 450kW electric motors**, enabling **cruising speeds of 16 knots**. Additionally, The Fjords has, in partnership with Brødrene Aa, developed a unique charging solution called the Power Dock.

With a length of 40 meters and a width of 5 meters, the floating glass fibre dock will sit in the water at Gudvangen, housing a 2.4 MWh battery pack. This charges steadily throughout the day via connection to the local grid network, which does not have the capacity to charge the Future of The Fjords directly.

The solution **allows the vessel to 'refill' in just 20 minutes**.

---

Saturday, April 28, 2018

Doug Rauh's Bainbridge Island comments on WSF 2040 Long Range Plan

Page 4 of 43



---

### Ferry Weight:

Any new WSF ferry should have a weight similar to the Norwegian "Ampere" ferry. Aluminum and **light weight material** should be used in construction in order to reduce the energy needed to move the ferry between terminals.

---

A WSF Jumbo Mark-II class ferry is **ten times the weight** of Finland's (electric) Elektra ferry and Norway's Ampere.

---

<https://www.seattletimes.com/seattle-news/transportation/washington-state-ferries-plans-to-convert-its-biggest-vessels-to-electric-power/>

Washington State Ferries plans to convert its biggest vessels to electric power

Originally published May 4, 2018 at 6:00 am Updated May 4, 2018 at 12:42 pm



This is one of the four main engines that help propel the MV Tacoma ferry. When converted to a hybrid system two of the four engines would be taken out of service and **100 tons of batteries** would be added. Steve Ringman/The Seattle Times)

---

[https://en.wikipedia.org/wiki/Jumbo\\_Mark-II-class\\_ferry](https://en.wikipedia.org/wiki/Jumbo_Mark-II-class_ferry)

General characteristics

Type: auto/passenger ferry

Tonnage: 4936 tons

**Displacement: 5398 tons** ← estimated to need **100+ tons** of Lithium batteries with a 4 year limited life

Length: 460 ft 2 in (140.3 m)

Beam: 90 ft (27.4 m)

Draft: 17 ft 3 in (5.3 m)

Decks: 2 auto decks/1 passenger deck/1 sun deck w/"quiet room" at each end

Deck clearance: 15 ft 4 in (4.7 m)

Installed power: Total of 13,200 hp from 4 x EMD 16-710 Diesel-Electric engines

Speed: 18-knot (33 km/h; 21 mph)

Capacity: 2500 passengers 202 vehicles (max 60 commercial)

Saturday, April 28, 2018

Doug Rauh's Bainbridge Island comments on WSF 2040 Long Range Plan

Page 5 of 43

<http://www.finferries.fi/media/elektra-technical-data.pdf>

Length over all 97,92 m

Breadth moulded 15,20 m

Draught 3,55 m 5 lanes,

length of lanes 450 m

Passenger + crew 375 persons

**DWT 525 t** Cars 90 ← uses about **10 tons** of batteries

Propulsion power 2 x 900 kW

**Batteries** all together **1 MWh**

Diesel generators 3 x 420 kW

## Elektra's technical data

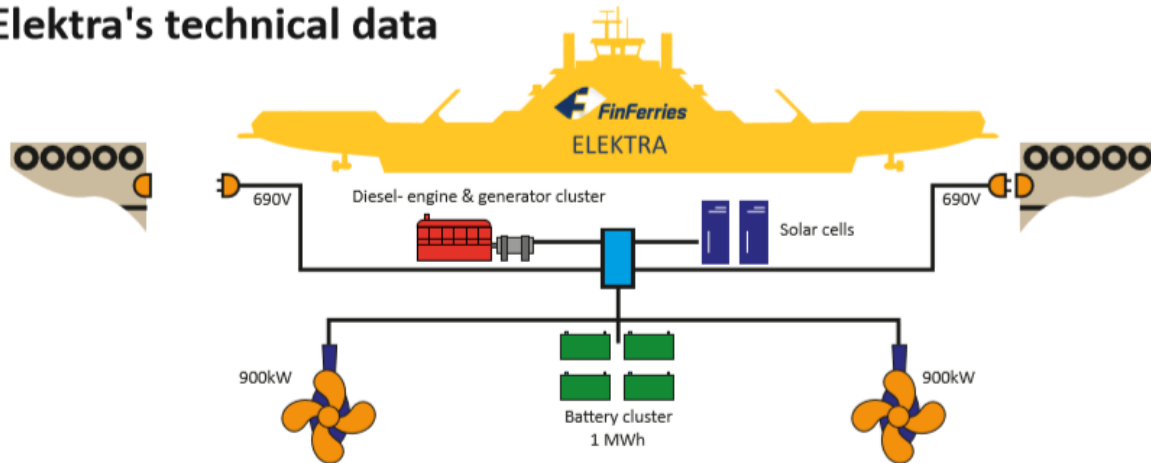

[https://www.google.com/search?q=finferry+elektra&source=lnms&tbn=isch&sa=X&ved=0ahUKewjpdW63JfbAhVsyIQKHc7KCD0Q\\_AUICyGc&biw=1536&bih=898#imgrc=VYpMHRHBcXDYJM](https://www.google.com/search?q=finferry+elektra&source=lnms&tbn=isch&sa=X&ved=0ahUKewjpdW63JfbAhVsyIQKHc7KCD0Q_AUICyGc&biw=1536&bih=898#imgrc=VYpMHRHBcXDYJM): **Finland Elektra electric ferry**



**Ferry Propulsion Energy Type:**

The current **Diesel** option creates a large amount of **Green House Gas**.

The other available options are **Electric, LNG and Hybrid-Electric**.

**Norway and Finland** have moved toward **Electric** because they have hydroelectric power similar to Washington State.

[https://www.psrc.org/sites/default/files/tip2018-fhwa-wsdot\\_wsf-hybrid-electric-ferry-conversion\\_web.pdf](https://www.psrc.org/sites/default/files/tip2018-fhwa-wsdot_wsf-hybrid-electric-ferry-conversion_web.pdf)

**Phase 1**, the subject of this CMAQ funding request, is the vessel conversion component of the program. Construction entails purchase of equipment needed for the conversion of the two JMII (Jumbo Mark II class) vessels to hybrid electric propulsion( the third Jumbo Mark II on the Edmonds-Kingston route would be converted after wards) and integration of battery storage technology into the existing diesel electric propulsion systems. Specifically, the project scope includes the following elements:

- Installation of **lithium-ion battery banks totaling 6.3 MWh** in the existing shaft alley compartments on both ends of each of two vessels;

**Why does Finland’s 10 tons of Lithium store 1.0 MWh while WSF’s 100 tons of Lithium stores 6.3 MWh?**

**Shouldn’t WSF be getting 10.0 MWh’s of storage from 100 toons of lithium-ion battery banks?**

<https://www.wsdot.wa.gov/NR/rdonlyres/6C78A08B-19A1-4919-B6E6-E9EF83E6376D/123052/HybridSystemIntegrationStudy.pdf>

**JUMBO MARK II CLASS**

Hybrid System Integration Study  
 Prepared for: Washington State Ferries  
 Seattle, WA  
 Ref: 17102-070-0 Rev. - February 8, 2018

**The fuel consumption was designed into the Jumbo Mark II and should emphasize the importance of designing for goals not initial price.**

**The Life Cycle Cost of the Jumbo Mark II’s is a disgrace due to the fuel consumption.**

Page 31

*Table 12: Jumbo Mark II Fuel Consumption*

Route	Gallons/ Hour	Hours of Operation	Gallons/ Day	Gallons/ Month
Seattle-Bainbridge	275	20	5,500	167,500
Edmonds-Kingston	225	20	4,500	137,000

MARK II VESSEL CLASS CONSUMPTION BY VESSEL, BY MONTH - LAST 12 MONTHS THRU OCTOBER 2017

	Nov-16	Dec-16	Jan-17	Feb-17	Mar-17	Apr-17	May-17	Jun-17	Jul-17	Aug-17	Sep-17	Oct-17	TOTALS
TACOMA	157,225	166,109	163,189	50,663	164,206	160,071	163,249	160,005	165,507	166,974	162,372	49,034	1,728,604
WENATCHEE	160,100	63,467	60,451	140,884	177,128	164,273	169,175	169,440	173,172	173,339	165,648	175,039	1,792,116
PUYALLUP	88,069	107,266	145,234	131,439	136,732	131,454	137,284	132,932	141,712	135,060	135,298	158,231	1,580,711
JUMBO MARK II FUEL	405,394	336,842	368,874	322,986	478,066	455,798	469,708	462,377	480,391	475,373	463,318	382,304	5,101,431

*Partial consumption month - vessel was undergoing maintenance at least part of the month*

*Figure 19: Jumbo Mark II Monthly Diesel Consumption, Last 12 Months*

Information from WSF indicates that a **Jumbo Mark II** will typically be **out of service an average of seven and a half weeks per year**. When the TACOMA or WENATCHEE is out of service on the Seattle-Bainbridge run, the PUYALLUP shifts to this route. Jumbo Mark IIs will be on the Seattle-Bainbridge run 365 days per year and 208 days per year on Edmonds-Kingston.

As a result, the **life cycle cost analysis** will estimate **Jumbo Mark IIs annually consuming about 4,015,000 gallons at Seattle-Bainbridge (two vessels on run) and 935,100 gallons at Edmonds- Kingston.**

The vessels are assumed to operate with periodic usage of the onboard diesels **to avoid oversizing** the hybrid power system. **A necessary departure from the dock prior to a full recharge of the battery system might require a diesel generator to come online prior to docking at the other side.**  
 If the captain required accelerating above a certain threshold assumed in this...

**Norway added more batteries after running operationally because of a need for additional margin.**

**Does “to avoid oversizing” mean the Jumbo Mark II’s should have more than 100 tons of Lithium-ion batteries in order to provide enough margin for continuous operation?**

Page 35

9.3 Lithium-Ion Batteries

The TACOMA and WENATCHEE will each make about 7,200 crossings per year while the PUYALLUP will make about 7,800. Due to the PUYALLUP's larger amount of time on the Edmonds-Kingston route, the battery pack would incur a lower average DOD and support a higher projected cycle life. As a result, the TACOMA and WENATCHEE serve as the worst case for this report. With selected **target battery life duration of four years**, the batteries will need to supply 28,800 cycles at the previously discussed DOD for the more demanding Seattle to Bainbridge crossing. Clearly, this will be a high cycle count application.

**Does “target battery life duration of four years” mean during the 40 years of remaining life 10 sets of Lithium-ion batteries will have to be purchased?**

**How much will that cost?**

**Is battery replacement cost included in the life time savings being projected by WSF?**

Page 41

**Since new battery banks are planned every four years,**  
**the variable costs will be left out of the LCCA as representing a replacement rate over a longer period...**

**How does the above statement build trust in the economic analysis of this proposed conversion?**

Page 45

*Table 18: Emissions from Electrical Usage – Puget Sound Energy w/o Green Energy Program*

Route	Energy per Trip	Annual Crossings (One-way) <sup>1</sup>	Annual Energy	Annual CO <sub>2</sub> Emissions
Seattle – Bainbridge	2200 kWh	8,395	18,470 MWh	8,630 MT
Edmonds – Kingston	1700 kWh	2,702	4,590 MWh	2,140 MT
<sup>1</sup> Only Kingston and Bainbridge with PSE sourced charging		<b>Total</b>	<b>23,060 MWh</b>	<b>10,770 MT</b>



---

While **WSF would not include the emissions from the sourced electricity in their GHG emissions inventories**, it is still important to consider. ...

**It looks to me like WSF is just buying a transfer of pollution from ferries generation to utility generation. No actual pollution reduction is actually occurring only how the pollutions source is attributed.**

Page 53

While the propellers and electric motors will still cause some noise and vibrations, the noise levels will be significantly reduced **without the use of the diesel generators.**

**There won't be any shore power for years so won't the diesel generators on the ferries still be running?**

Page 54

WSF produces **67% of WSDOT's total emissions and the three Jumbo Mark II vessels** emit 26% of WSF's share of carbon emissions. Given the late 1990's emissions standards that the Jumbo Mark II diesel engines were required to meet, the emissions savings is likely even greater in regard to NOx, SOx, and diesel particulate matter.

**This project would have enormous impact in meeting the 2020 emissions targets.**

**The utilities pollution increase due to WSF buying electricity will reduce this "enormous impact" which to me appears to be BS.**

---

<https://www.bloomberg.com/news/features/2018-03-13/the-next-ship-you-board-might-run-on-batteries>

The **first zero-emissions ferry**, called the **MF Ampere**, started sailing between the villages of Oppedal and Lavik along the Sognefjord in 2015. Operated by **Norled AS**, it's made of light **aluminium**, **runs on 10 tons of lithium-ion batteries** and carries up to **350 passengers** and **120 cars**. After each 20-minute journey, it **recharges for 10 minutes**. The ride is both **smoother** and **quieter** than on diesel-powered ferries.



The **MF Ampere**. Photographer: Carina Johansen



Cables connect to batteries in the battery room of the MF Ampere.

<https://fortress.wa.gov/ecy/publications/documents/1402030.pdf>  
 Reducing Greenhouse Gas Emissions in Washington State Government Third Biennial Progress Report  
**December 2014** Publication no. 14-02-030  
 Page 12 State vehicle fleet  
 State agencies emitted about 268,445 MTCO<sub>2</sub>e from state-owned motor vehicles in 2013.  
**About 64 percent of the 2013 transportation-related total is from the Washington State ferry system.**

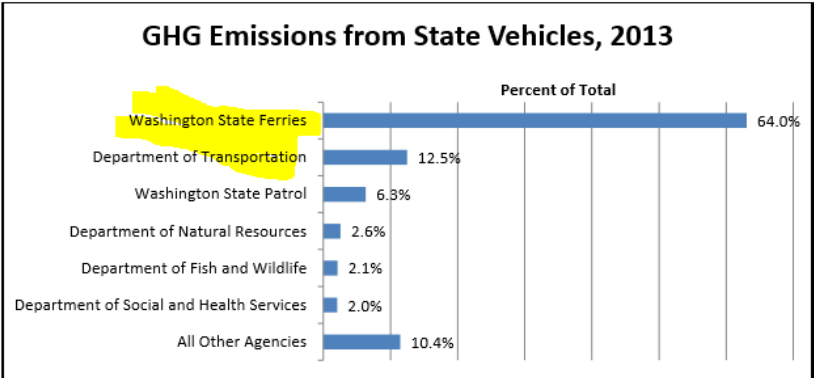

Figure 6: GHG Emissions from State Vehicles, 2013



## Technology:

**Autonomous** software for ferry routes, **auto-docking** software, automatic **mooring** and auto **electrical connection**.

<https://www.youtube.com/watch?v=epOAE8pudsg> ← 2 minutes video showing **automatic mooring** and **electrical** to Norway's electric ferry **Ampere**.

**Watch video to see how the mooring and electrical connection works.**

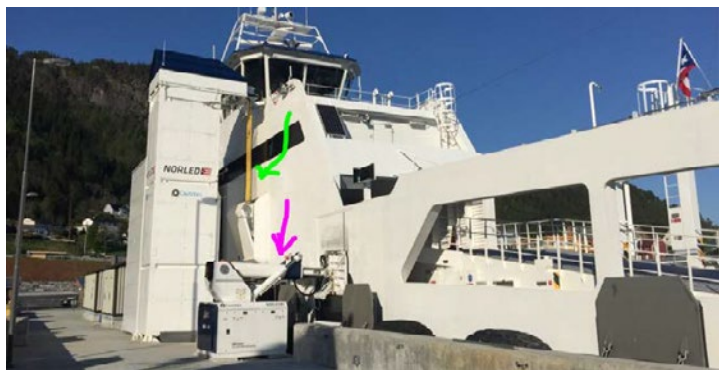

Automatic electrical connection **green arrow**.

Automatic mooring **pink arrow**.

MoorMaster™ automated **mooring** and Automatic **Plug-in System**

Discover how our combined automated mooring and **Automatic Plug-in System** **moors and charges** the world's first fully battery-powered catamaran ferry.

The system enables vessel operator **Norled** to **bring down operating costs**, improve safety, and decrease emissions.

<https://globenewswire.com/news-release/2018/04/20/1482333/0/en/Cavotec-signs-breakthrough-EUR-9m-orders-for-unmanned-mooring-of-electric-ferries.html>

### Cavotec signs breakthrough EUR 9m orders for unmanned mooring of electric ferries

April 20, 2018 03:30 ET | Source: Cavotec SA

Cavotec is set to revolutionise the operation of e-vessels by delivering and maintaining its automated, unmanned, mooring system MoorMaster™ for e-ferry ports across Norway. With these orders, **MoorMaster™** is now the leading technology to safely and efficiently moor e-vessels, a segment set for rapid growth.

The orders are worth approximately EUR 9m, of which EUR 4m was booked in the fourth quarter of 2017.

On completion of these projects, Cavotec will have equipped more than **40 e-ferry ports** in Scandinavia with MoorMaster™, thereby delivering substantial operational and safety benefits for ferry operators.

“These projects demonstrate the **unrivalled suitability of MoorMaster™ for e-ferry applications**, and the importance of the technology for this rapidly growing segment in Norway and beyond,” says Gustavo Miller, President Ports and Maritime Division at Cavotec.

MoorMaster™ is ideal for e-ferry applications because the units keep vessels in pre-programmed positions to maximise the amount of time available to charge ship battery units. The technology also reduces overall CAPEX for operators, and delivers substantial operational and safety benefits,” says Sofus Gedde-Dahl, Sales Director E-Ferries at Cavotec. Following its stated aim of reducing carbon dioxide emissions by 40 per cent, Norway has led the introduction of electrically powered and hybrid vessels. Cavotec has become a crucial partner in this effort through its development of innovative automated charging interface and mooring technologies.

Saturday, April 28, 2018

Doug Rauh's Bainbridge Island comments on WSF 2040 Long Range Plan

Page **11** of **43**

Cavotec systems have moored and charged the world's first fully **electric car ferry**, the **MF Ampere**, since it entered service in **2015**. Following the success of the MF Ampere application, Cavotec mooring and charging technologies have been introduced at a growing number of e-ferry berths in Norway, Finland, and Sweden.

To date, more than **260 MoorMaster™ units worldwide** have performed some 330,000 moorings at ferry, bulk and container handling, as well as lock and ship-to-ship applications worldwide.

"The rapid introduction of e-ferries in Norway has been the dominant driver for the wider adoption of MoorMaster™ in recent years, a development that we see being replicated in neighbouring markets such as Finland and Denmark," says Gedde-Dahl.

---

**Doug Rauh Bainbridge Island comments on new technology in the 2040 WSF Long Range Plan. The WSF presentation to the WSTC on the next 20 year plan should include technology at least as advanced as what the Norwegians are installing on their ferries today.**

---

[https://www.marinelink.com/news/autocrossing-rollsroyces436449?utm\\_source=MT-ENews-2018-04-17&utm\\_medium=email&utm\\_campaign=MT-ENews](https://www.marinelink.com/news/autocrossing-rollsroyces436449?utm_source=MT-ENews-2018-04-17&utm_medium=email&utm_campaign=MT-ENews)

### **Rolls-Royce's Autocrossing System for 13 New Ferries**

Posted by Michelle Howard **April 17, 2018**



Photo: Rolls-Royce

Rolls-Royce Marine has signed a deal to supply its **Autocrossing system** to a total of **13 new environmentally friendly ferries** for the Norwegian company Fjord1. The vessels are currently being built by three yards in Turkey and two yards in **Norway**. All contracts also include two azipull propellers for each vessel with accompanying propeller control system from Rolls-Royce.

With this contract, Rolls-Royce has sold autocrossing to a total of 18 new ferries to operate along the coast of Norway, of which **16 have been ordered by Fjord1** and **two** by another Norwegian ferry company, **FosenNamsos Sjø**.

Dagfinn Neteland, CEO of Fjord1, said, "Our passengers will be part of the most environmentally friendly and modern transportation concept ever seen in Norwegian fjords. The technology from Rolls-Royce enables us to deliver this promise."

Andreas Seth, Rolls-Royce, SVP Electro, Automation and Control, said, "We are proud to take part in the ongoing renewal program for ferries that connects communities along the long Norwegian coastline. The Government deserves praise for opting for both innovative and environmentally friendly solutions. It makes it possible for the maritime industry to deliver our latest technology."

The new generation of environmentally friendly ferries have strict yearly limits on energy consumption as part of the commercial agreement between the **ferry operator** and the

Saturday, April 28, 2018      Doug Rauh's Bainbridge Island comments on WSF 2040 Long Range Plan      Page **12** of **43**

---

Government. **The automatic crossing system provides safe, predictable and energy-efficient transit back and forth by automatically controlling the vessel's acceleration, deceleration, speed and track.**

The **two energy-efficient Rolls-Royce Azipull thrusters** respond adaptively to environmental conditions to ensure optimal behaviour and maximise efficiency.

The **vessel's captain will supervise the automatic system** and **intervene using traditional maneuvering systems if needed.**

If the captain is not, for some reason, able to take manual control, the system stops the vessel at a safe distance from the quayside and keeps it safely positioned automatically until further action can be taken.

Seth said, "Five of the new vessels will operate in one of Norway's two designated test areas for autonomous ship technology. This is a perfect location as the Autocrossing system from Rolls-Royce is indeed **a step on the journey towards increased autonomous and remote navigation.**

The **Automatic Crossing System** can today be installed as an **add-on** to any standard **Rolls-Royce azimuthing thruster.**

This means the system can be retrofitted to the existing fleet of ferries around the world.

Overview of shipyards building the 13 new ferries for Fjord1:

- Havyard Ship Technology, Norway = 5 ferries
- Fjellstrand, Norway = 1 ferry
- Tersan Shipyard, Turkey = 2 ferries
- Sefine Shipyard, Turkey = 3 ferries
- Cemre Shipyard, Turkey = 2 ferries

Earlier this year Fjord1 took delivery of three new ferries from Tersan, with Autocrossing installed, while the two ferries for FosenNamsos Sjø are under construction at Kleven's Myklebust shipyard in Norway.

---

Doug Rauh's comments on **autodocking** system for ferries: WSF's should include in 2040 Long Range Plan.

---

[https://www.marinelink.com/news/autodocking-norwegian436844?utm\\_source=MT-ENews-2018-04-26&utm\\_medium=email&utm\\_campaign=MT-ENews](https://www.marinelink.com/news/autodocking-norwegian436844?utm_source=MT-ENews-2018-04-26&utm_medium=email&utm_campaign=MT-ENews)

## Norwegian Ferry Tests **Autodocking** System

**Eric Haun**, Editor web editor of MarineLink.com and contributor to Maritime Reporter...

April 26, **2018**



(Photo: Wärtsilä)

A ferry owned by Norwegian operator **Norled** is the first in the world to experiment with autodocking technology.

Saturday, April 28, 2018

Doug Rauh's Bainbridge Island comments on WSF 2040 Long Range Plan

Page **13** of **43**

---

Equipped with **Wärtsilä's** innovative **autodocking system**, the 83-meter ferry Folgefonn concluded three months of testing with harbor docking trials in April.

The autodocking system **activates some 2,000 meters from the berth** and keeps the vessel transiting at its normal transit speed until it gradually slows down to activate the line-up and docking maneuver.

**The vessel operates completely automatically until secured at the berth.**

Full maneuvering of the vessel, including the steering and propulsion, is automatically controlled by the software, with manual intervention and control possible at any moment if need be. At no time during the tests did Folgefonn's captain need to take manual control of the vessel.

When the ship is ready to sail again, **the system may be used for the departure** procedure in an identical but reverse manner.

**Wärtsilä**, who received support for the autodocking pilot project from the Norwegian state-owned Innovasjon Norge (Innovation Norway), said developing intelligent vessels is central to its [smart marine ecosystem vision](#). In 2017, the same Wärtsilä team [tested remote controlling of a ship](#) sailing in the [North Sea from](#) its San Diego location.

The company believes autodocking technology delivers significant benefits to operators, including improved safety since there is less likelihood of human error and ship's officers can focus on situational awareness outside the wheelhouse. In addition, **greater efficiency in docking allows more time at berth**, and there is **less wear and tear on the vessel** since the thrusters are utilized more efficiently.

Norled has made the **Folgefonn** available for further development of a number of Wärtsilä's products and systems. Among the Wärtsilä technologies already installed and tested are its energy optimization system, the hybrid propulsion system, [wireless inductive battery charging](#) and [energy storage](#). The ferry can now be operated with automatic wireless charging, automatic vacuum mooring and automated docking.

"We [thank Norled](#) for their valued cooperation in this project. These tests represent an important element within Wärtsilä's overall smart marine vision. Autodocking can become a vital part of our offering to the ferry and other shipping markets, and will further promote our activities in leading the transformation into a new era of high efficiency and profitability for our customers," says Roger Holm, President, Wärtsilä Marine Solutions.

"We are pleased to support Wärtsilä's efforts for creating greater efficiencies for marine operators. Technologies that improve safety, reduce operating costs, and lower the environmental impact can only be good for our industry," says Sigvald Breivik, Technical director, Norled.

---

---

### Ferry Propulsion System:

Current WSF ferries do not use azimuth drive systems.

Ferries using **azimuth thruster** have better handling in current, wind and much **shorter turning radius**.

During collision avoidance an azimuth system could turn the ferry faster.

<https://youtu.be/L6CIXYhYdrE> <-- minute video **Azimuth thruster in action**

<https://www.youtube.com/watch?v=pBbWBsu0Qc0> ← 2 minute video on permanent magnet thruster

WSF could improve maneuverability by using azimuth thrusters allowing safer docking during times of strong wind and/or current.

---

<https://www.maritimepropulsion.com/blogs/post/optimizing-ferries-for-electric-power-52>

### Optimizing Ferries for Electric Power

Posted to **Propulsion** (by **Eric Haun** ) on May 5, 2017

**Two new zero-emissions ferries will enter service in Norway in 2018, both optimized for electric power.**

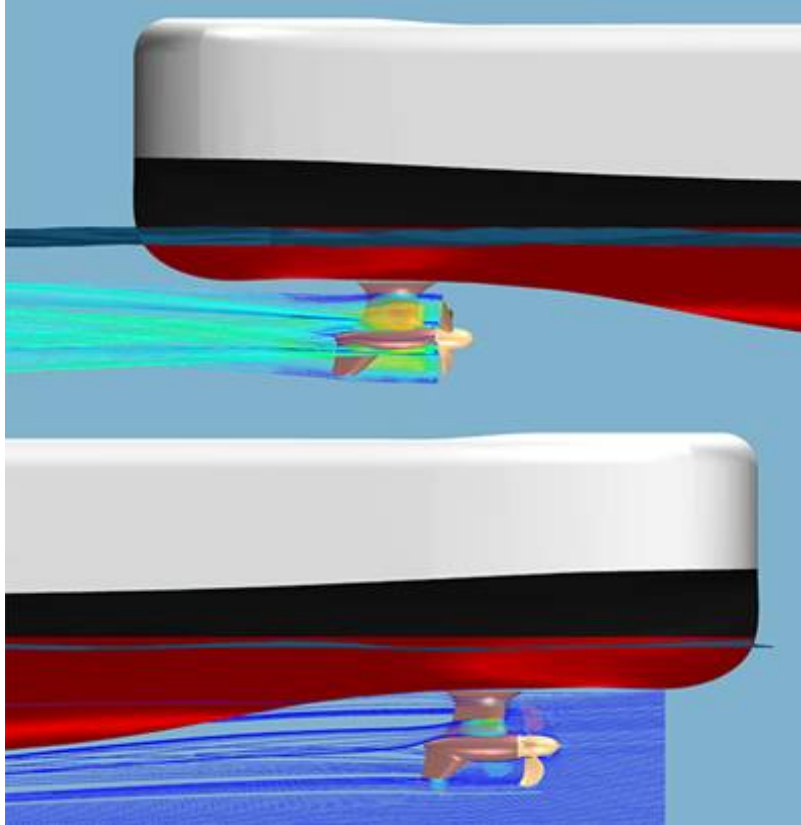

CFD illustrates the **very low drag** of the **fully feathered bow thruster** and the efficient stern Azipull  
(Image: Rolls-Royce)

Batteries will be the sole power source for two new double-ended ferries being built for operations on Norway's west coast. The ferries, now under construction at the Tersan shipyard in Turkey and to be operated by Fjord1 and the Norwegian public roads authority Statens Veivesen, will produce zero emissions when they enter service in January 2018.

---

Each ferry will carry up to **120 cars, 12 trailers and 349 passengers** on the crossing of approximately two kilometers between Anda and Lote, Norway. The battery vessels will replace diesel power, and the **lithium ion batteries** will be charged at each side of the crossing.

Rolls-Royce said it has been working closely with designer Multi Maritime to ensure that the Azipull thruster propulsion system and hull form minimize energy requirements and deliver sufficient low-speed thrust during bad weather, so minimizing battery size.

A single **Azipull AZP 85CP-F thruster** from Rolls-Royce will be located at each end of a ferry. The pulling propeller and the streamlined lower gear housing provide increased thrust through energy recovery, the manufacturer said. These also provide high efficiency with **low vibration**, making them attractive for a wide variety of vessel types. And for the new ferries in particular, the Azipull's controllable pitch and feathering propeller were deciding factors.

Studies carried out by Rolls-Royce for the ferry design indicated that in transit the lowest power requirement is when the aft thruster provides all the propulsion thrust and steering.

In this mode the forward thruster only represents drag, and the design enables this to be cut to a few percent of the total thrust by setting the CP propeller to the **fully feathered position**. The full propulsion and steering capabilities of both are available for maneuvering or in emergency.

This type of vessel does not turn around for the return trip. The thrusters exchange functions and the previously feathered idle unit provides transit propulsion. Efficient operation over the different phases of the crossing is ensured by combinatorics that form part of the Rolls-Royce control logic for the Azipull thrusters.

---



## Ferry Maintenance:

An **aluminum hull does not require painting** like steel and is lighter.

<https://electrek.co/2018/02/03/all-electric-ferry-cuts-emission-cost/>

All-electric ferry cuts emission by 95% and **costs by 80%**, brings in **53 additional orders**

Fred Lambert - Feb. 3rd 2018 1:57 pm ET @FredericLambert



The operators of the first all-electric ferry in Norway are starting to get some good data on the vehicle and it's nothing short of impressive.

They claim that the **all-electric ferry cuts** emission by 95% and **costs by 80%** compared to fuel-powered counterparts and the results are attracting customers.

The ferry in question is called "**Ampere**" and it was put into operation back in May 2015 with the aim to reduce NOx and CO2 emissions, as well as **noise pollution** on the water.

It was the result of an extensive partnership between Norled AS, a shipping company and ferry operator, Fjellstrand Shipyard, Siemens AS, and Corvus Energy.

The last two developed the electric powertrain and battery system powering the ferry with **over 1 MWh** of **battery capacity** on board.

Here's a diagram of the system – including the two charging stations with battery packs installed in Opedal and Lavik:

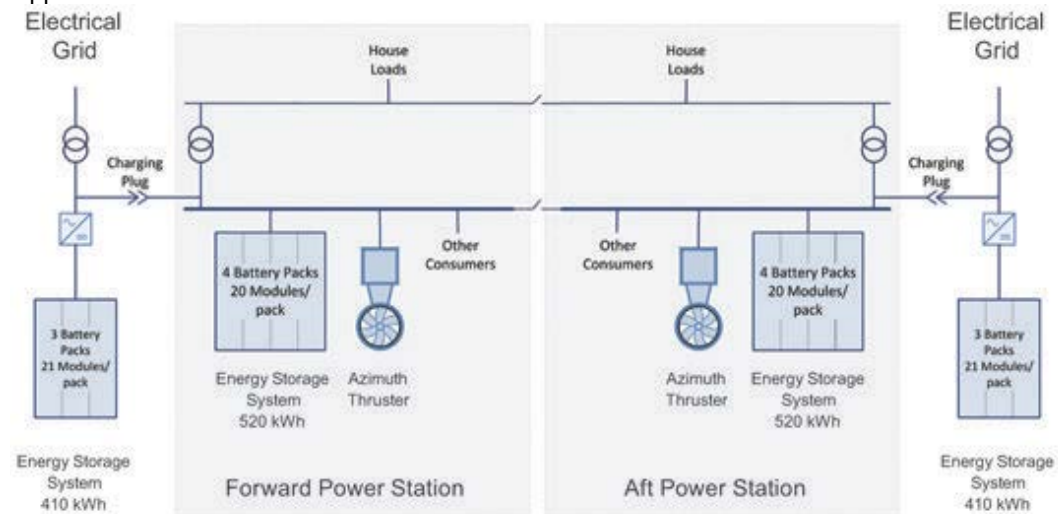

---

It was already clear that the deployment of the all-electric ship was a success since they quickly commissioned another one, called “Elektra”, that went into operation last summer.

But they announced at the Nordic EV summit in Oslo this week that the numbers are even more impressive than anticipated with CO2 emissions reduced by 95% and **operating cost by 80%**.

With those numbers, you would think that every ferry operators on the planet would be looking to update their fleet with those all-electric alternatives.

Sure enough, **they are seeing a lot of order with a reported backlog of 53 additional ferries**. Here’s a video of the Ampere from when it was launched back in 2015:

#### **Electrek’s Take**

As we have often discussed in the past, all modes of transportation are gradually being converted to electric propulsion and that includes maritime transport.

Ferries are a perfect place to start since they often travel only short distances and stay for relatively long periods of time at the same ports, where they can be charged.

That’s exactly what they took advantage of and interestingly, they are charging the ferries through battery packs at each port, which helps maintain a high charge rate while reducing peak demand costs.

Now we are seeing more and more companies going electric for maritime transport.

Last year, [Two massive ferries \(even bigger than the Ampere\) being converted to battery-electric](#) – becoming the biggest all-electric ships in the world in the process.

New [large all-electric container barges](#) dubbed ‘Tesla ships’ are also launching this autumn and [an new all-electric cargo ship with a massive 2.4 MWh battery pack](#) recently launched in China.

---

## Ferry Operational Life:

The current design life of a ferry is **60 years per WSF** policy.

The long life requires a mid-life upgrade.

Mid-life upgrades are expensive and takes the ferry out of service.

A shorter life that does not require a mid-life upgrade would be in line with what other ferry systems are doing.

Replacement ferry could be built while the ferry to be replaced continued service.

<http://wstc.wa.gov/Meetings/AgendasMinutes/agendas/2018/April17/documents/0417-BP1-WSF2040LongRangePlan.pdf>

# Vessel Replacement



**Doug Rauh's comments: If vessel life is reduced to a more realistic 40 year life then 16 ferries need to be replaced. If the Bainbridge and Bremerton routes were to convert to 3 smaller electric ferries on each route than another 6 ferries would need to be built.**

**If looks like one new small all electric ferries would need to be built every year forever.**

**WSF would need a \$1,000,000 a week for capital replace for at least the next 20 years.**

**The construction costs will have to come down to a more realistic \$50,000,000-\$60,000,000 per ferry.**

It would be cost effective for WSF to replace one ferry every year with smaller aluminum electric/LNG ferries.

A smaller ferry would allow other ship yards beside Vigor to bid on the contracts.

By removing the current midlife overhaul the ferry would spend more time in service and less time in dry dock.

Changing the number of ferries on some routes from 2 to 3+ ferries would provide better service while maintaining the same capacity.

This would also reduce the peak traffic demand on the land side infrastructure due to the ferry loading and unloading.

A steady ferry construction process would reduce the cost of construction.

**On a 3 boat route if one ferry is down the capacity is only reduced by 30% compared 50% loss of capacity with the current 2 boat route configuration.**

---

### **Ferry Life Cycle Cost:**

Using **Initial Cost** when purchasing ferries has resulted in **higher fuel costs** thus **higher Life Cycle Cost**. **Higher operating costs** resulting in **higher fares** due to high fare-box recovery rate which reduces demand for the service.

**Washington State requires Life Cycle Cost** be used for **long life Capital Equipment** like ferries. Operational Costs are determined in the design and WSF should not be placed in the position of trying to save money after the design.

With all the noise today about conversion of the Jumbo Mark II's it should be remembered that when Representative Karen Schmitt (Ferry God Mother) forced low cost to be used instead of Life Cycle Cost thus the Operational Cost went up Forcing riders to pay higher fares while creating a lot of air pollution.

The Ferry God Mother didn't like the ceiling noise in the Jumbo ferries or the salt spray on the car deck. The design called for an increase in weight of 900 tons or the equal to 3 full loads of 200 cars weighing 3000 pounds. For almost 20 years WSF has been pushing that extra weight across the Sound from Bainbridge Island to Seattle. **Trades offs and goals are achieved in design not afterwards.**

**Converting the Jumbo Mark II's to hybrid electric is a bad idea,** these ferries are too heavy for electric batteries.

If a Lithium battery set last 4 years WSF will need 10 battery sets for the 40 years remaining in the life of these ferries. That is 4,000 tons of Lithium per boat.

**12,000 tons of lithium for the Jumbo Mark II class.**

Lithium batteries degrade over time, will the 100 tons of batteries be enough in year 4?

**Reassigning pollution generation from ferries to utilities does not reduce air pollution.**

---

## Ferry Price:

Past ferry prices have been 2+ times the price paid by other ferry systems for similar boats.

**Construction and Financing Costs need to be reduced.**

How come the world's largest containership costs \$150,000,000 and

a 144 car WSF ferry costs \$144,000,000 or **\$1,000,000 per car?**

**How can B.C. Ferries buy 3 ferries for \$165,000,000 while WSF buy 1 for \$144,000,000?**



<https://www.bcferries.com/about/projects/bc-ferries-newest-class-of-vessels.html>

BC Ferries has commenced work for the design and build of two new ferries to serve the Northern Gulf Islands. The first of the new vessels will be deployed on the **Powell River – Texada Island** route, replacing the 59-year old *North Island Princess*, which will be retired from the BC Ferries fleet. The second vessel will replace the *Quadra Queen II* on the **Port McNeill – Alert Bay – Sointula** route. The *Quadra Queen II* will become a relief vessel, allowing for fleet redeployments and the retirement of the 53-year old *Howe Sound Queen*.

These two new vessels are planned to enter the fleet by 2020.

Both vessels will be the same build to achieve optimal procurement, **low operating cost and interoperability.**

**Standardized vessels** help **ensure consistent service across many routes.**

## Vessel Class Overview

The two minor class vessels will have the capacity to carry at least 44 vehicles and up to 300 passengers and crew. They will have a number of key features that support BC Ferries' goal to be efficient and environmentally responsible throughout its system. Highlights include:

- A **hybrid diesel electric** - battery power generation and propulsion system that uses on board electric battery power for operation of the vessel. Electric propulsion is quiet, smooth and efficient compared to traditional diesel propulsion.
- Engines which operate on ultra-low sulphur diesel fuel, which has lower environmental impact than regular marine diesel oil.
- **Hull, propeller and thruster design that minimizes underwater radiated noise.**
- Arrangements to minimize shipboard vibration and airborne noise to improve conditions for communities, passengers and crew.
- A fully contained waste water handling system which eliminates discharges to the sea.



Artist rendering images

---

## Concept Features

### Function & Design

- A double-ended hull with single vehicle deck, high bulwarks and enclosed ends.
- Proposed capacity of 300 (passengers and crew) maximum, 150 on a normal license.
- Roll-on/roll-off vehicle deck with minimum 44 automobile equivalents (AEQ\*) (approximately 270 meters of vehicle lanes) with either end capable of loading/unloading.
- **Standardized design for fleet interoperability and efficient training.**
- **Service life of minimum 40 years**; emphasis on sound structural design and effective coatings.
- Suitable for year-round service in coastal British Columbia on Near Coastal Voyages, Class 2 (NC2), and Sheltered Waters routes.
- Passenger lounge accessible from vehicle deck, meets accessibility requirements without elevators.
- **Lounge outfitted with mix of tables, study carrels, comfortable seats, community bulletin board, tourism space and charging stations for personal electronic devices.**
- Overhead sun deck with a **mix of tables and individual seats** protected by a transparent wind break.
- Sufficient speed to maintain and recover schedule when required.

### Environment

- Overall design optimized for low noise, low vibration and minimal wake wash.
- Sea keeping suitable for winter transit in coastal British Columbia without excessive motion or spray.
- All systems designed for low energy consumption and clean environmental performance.

### Safety

- Mechanical and electrical systems designed for simplicity, efficient performance and ease of maintenance.
- Propulsion to provide efficient transit and sufficient manoeuvrability for reliable docking in expected environmental conditions.
- Redundant systems for reliable performance.
- Modern safety and control systems.

**Doug Rauh's comment: WSF seats should vary in height to match the various heights of their customers who vary in height from kids to tall adults?**

---

<http://www.timescolonist.com/business/second-lng-ferry-underway-in-poland-1.1822577>



An artist's rendering of the **intermediate-class vessels** being built in **Gdansk, Poland**.  
Photograph By Joanne Whittier, B.C. Ferries



## Second LNG ferry underway in Poland

[Carla Wilson](#) Times Colonist April 14, 2015 06:00 AM

Polish shipyard workers have started building the second of **three new intermediate-class vessels for B.C. Ferries**. The three ferries will operate on **liquefied natural gas**, considered a **lower-cost and cleaner-burning fuel**, but will also have the ability to use **low-sulphur diesel fuel**.

B.C. Ferries has contracted with the Polish shipyard to **build, design and deliver the three intermediate-class vessels at a cost of \$165 million**. Each will be **351 feet long** with capacity for **145 vehicles** and **600 passengers**.

---

<http://www.seattletimes.com/seattle-news/transportation/a-parking-headache-whats-the-fix-for-crowded-park-and-ride-lots/>

**Q:** According to **state law, Washington State Ferries must be built in Washington**.

How much more does it cost to build the ferries here than it would other places?

— Christopher Hodgkin, Friday Harbor

**A.**

**It costs millions of dollars more on average to build a ferryboat in Washington than at an out-of-state shipyard.**

But according to a [recent study](#) by the Washington State Institute for Public Policy (WSIPP), if you weigh that cost against the loss of shipyard jobs and consumer spending by building elsewhere, the math isn't that definitive.

We'll break it down.

The study is split into two parts: a benefit-cost analysis that addresses how an out-of-state builder would directly impact specific groups, and an economic-impact analysis that assesses indirect and long-term effects.

The benefit-cost analysis found Washington taxpayers could save \$10.5 million to build a 1,500-passenger, **144-car ferry** — like the [Washington State Ferries \(WSF\) vessel called Tokitae](#) — in another state. But that would mean losing \$7.25 million in shipyard-employee income for that project, the study says.

That pencils out to a benefit of \$3.25 million. For perspective, the **Tokitae cost \$144 million**.

The economic-impact analysis predicts that building elsewhere would have a more negative effect, including an average two-year loss of about 659 jobs and about \$68 million in consumer spending.

“Neither analysis predicts a substantial impact on Washington’s economy (either positively or negatively) from keeping ferry construction in state or moving construction to out-of-state shipyards,” the study says.

The Olympic-class Tokitae [entered service in mid-2014](#) as part of a three-vessel deal with Vigor Shipyards in Seattle that totaled \$388 million.

Vigor has led WSF construction for the past 20 years, as the only company that meets all the state’s building requirements, the study says.

This summer, a new Olympic-class ferry will launch on the Seattle-Bremerton route, and another new vessel will go into service next year.

WSF spokesman Ian Sterling said the agency has no official position on the out-of-state vs. in-state issue. The Legislature directed WSIPP, a nonpartisan think tank, to do the analysis in 2015. WSIPP is governed by a board of directors that represents the governor, legislators and public universities.

Saturday, April 28, 2018 Doug Rauh’s Bainbridge Island comments on WSF 2040 Long Range Plan Page 23 of 43

Material from The Seattle Times archives was included in this report. Jessica Lee: 206-464-2532 or [jlee@seattletimes.com](mailto:jlee@seattletimes.com). On Twitter @jessleeST.

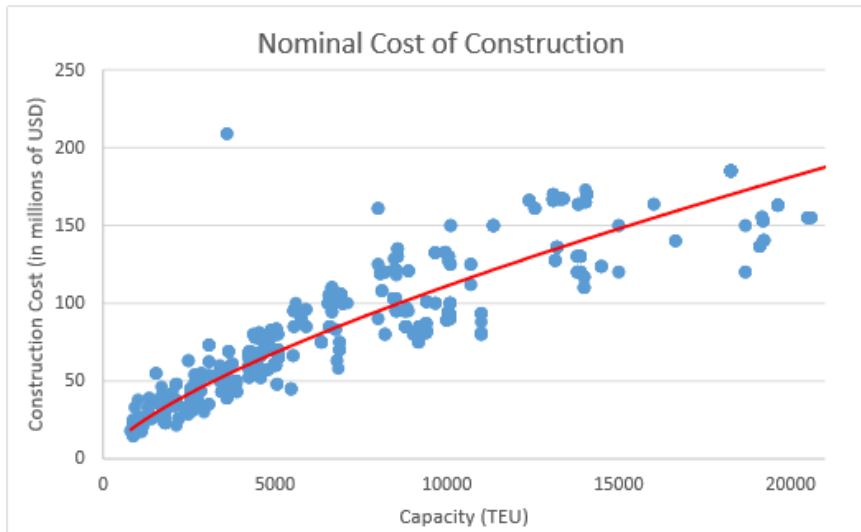

<sup>7</sup> Cost per TEU was calculated by simply dividing the construction cost by the TEU capacity; this does not consider the utilization of the vessel's capacity.

The **CMA CGM Benjamin Franklin** at **18,000 TEUs** would be about **\$150,000,000** compared to a **144 WSF ferry** at **\$144,000,000**

[https://www.porttechnology.org/news/inside\\_the\\_cma\\_cg\\_m\\_benjamin\\_franklin](https://www.porttechnology.org/news/inside_the_cma_cg_m_benjamin_franklin)

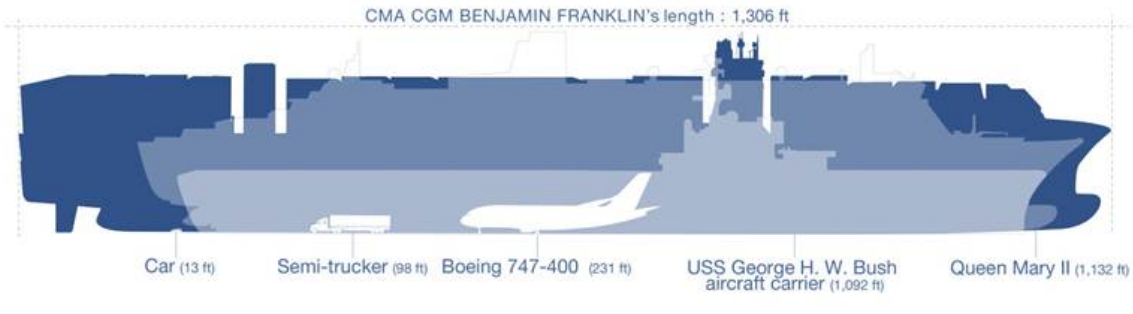

Tonnage: **178,228 GT** 116,356 NT 185,000 DWT  
 Length: 399.2 m (1,310 ft)  
 Beam: 54 m (177 ft)  
 Height: 60 m (197 ft), 70 m (230 ft) over antennae.[2]  
 Draft: 16 m (52 ft)  
 Depth: 30.2 m (99 ft)  
 Installed power: MAN B&W diesel engine, (63,910 kW)  
 Propulsion: Single shaft; screw propeller Solid  
 Speed: 22.9 knots (42.4 km/h; 26.4 mph)  
**Capacity: 18,000 TEU**, Refrigerated connections 1,500 [2]  
 Crew: 27[3]

<http://media.gettyimages.com/photos/the-cma-cgm-benjamin-franklin-the-largest-container-ship-to-ever-call-picture-id50254222>



The **CMA CGM Benjamin Franklin**, the **largest container ship to ever call at a North America port**, is docked at the Port of Los Angeles in San Pedro, California, after arriving before dawn on Dec. 26, 2015.

[http://i139.photobucket.com/albums/q309/ferrynutseattle/ferrynutseattle3/002\\_zps935fbb49.jpg](http://i139.photobucket.com/albums/q309/ferrynutseattle/ferrynutseattle3/002_zps935fbb49.jpg)



Vigor Industrial, Seattle, Washington

Operators: 2014–present: Washington State Ferries

Built: 2012–2018 (planned)  
 In service: 2014–present  
 Building: 1  
 Planned: 4  
 Completed: 2  
 Active: 2

General characteristics

---

Type: auto/passenger ferry

**Displacement: 4320 long tons at design load waterline**

Length: 362 ft (110.3 m)

Beam: 83 ft 4 in (25.4 m)

Draft: 16 ft 6 in (5.0 m)

Depth: 24 ft 6 in (7.5 m)

Decks: 2 vehicle

1 passenger / 1 sun deck

Deck clearance: 15 ft 6 in (4.7 m)

Installed power: Total 6,000 hp (4,500 kW) from 2 x Diesel engines

Speed: 17-knot (31 km/h)

Capacity: 1500 passengers

**144 vehicles** (max 30 commercial)

Notes: All specifications are subject to change. Vessels in design and construction phase.[1]

---

<file:///C:/Users/Doug/Documents/WSF/Triple-E%20class%20container/MSO%20OSCAR%20140%20million.htm>

07.03.2015 - Wilhelmshaven. **MSC OSCAR world's largest Container ship**

makes maiden call at EUROGATE Container Terminal Wilhelmshaven.

MSC Mediterranean Shipping Company's largest container ship ever built, the MSC Oscar, makes her maiden call at Port of Wilhelmshaven today. Since its inauguration in January at Daewoo's Shipbuilding and Maritime Engineering (DSME) Shipyard in South Korea, record-breaking MSC Oscar represents the first in its class and will be followed by additional vessels in the same class during 2015-2016.

In true MSC family tradition the vessel was named after Oscar, the son of Diego Aponte, MSC's President and CEO.

The **45,300 ton steel MSC Oscar, which cost US\$140 mio to build**, is 395 metres long, 59 metres wide with a draught of 16 metres.

The super-size MSC Oscar **is equivalent to the size of four combined football fields** and is now servicing the Albatross string on the new East-West trade routes between Asia and Europe.

History

**Name: MSC Oscar**

Owner: Mediterranean Shipping Company

Operator: Mediterranean Shipping Company

Port of registry: Panama[1]

Builder: Daewoo Shipbuilding & Marine Engineering (DSME)

**Cost: \$140m**

Completed: 2015

Identification: IMO number: 9703291[1]

General characteristics

Type: Container ship

**Tonnage: 197,362 DWT**

**Length: 395.4 m (1,297 ft)**

**Beam: 59 m (194 ft)**

Draught: 16m

Ice class: none

Installed power: MAN B&W 11S90ME-C two-stroke diesel engine; output: 62.5 MW (83,800 hp)[2]

Propulsion: Single five-blade propeller; blade length: 10.5 m (34 ft)[2]

Speed: 22.8 kn (42.2 km/h; 26.2 mph)[3][4]

**Capacity: 19,224 TEU**

Crew: Max 35[3]

---

[https://youtu.be/Yfq\\_hDYW\\_6Y](https://youtu.be/Yfq_hDYW_6Y) ← 1 minute video of TESO new ferry (2016) with solar panels on the roof.

C-Job | **New TESO double-ended ferry arrives in Holland for testing**

C-Job Naval Architects Published on May 4, 2016

C-Job was responsible for the initial, concept & basic design for this double-ended ferry which will sail in spring 2016 between the beautiful Dutch island of **Texel** and **Den Helder**.

**The ferry will be operated by locally owned organization TESO.**

The challenge was to achieve an increase in 10% more cars without increasing the length (due to less maneuverability) and less wind pressure.

Due to the T-shaped design, the car capacity increased with 18% and although the lateral surface increased marginally, the **wind pressure was reduced** compared to the Dr. Wagemaker.

More info: <http://www.c-job.eu/en-GB/88/teso-tex...>

Drone video by Videolux Productions Texel <http://www.videolux.nl>

---

[42 millones para financiar el nuevo ferry de La Naval . El ...](#)

[www.elcorreo.com](http://www.elcorreo.com)

La construcción del ferry Texelstroom por parte de La Naval para la compañía holandesa TESO recibió ayer el espaldarazo definitivo financiación, que supone un total de 42 millones de euros, de los cuales 15 millones corresponden al Banco Sabadell Guipuzcoano.

La construcción del ferry 'Texelstroom' por parte de **La Naval** para la compañía **holandesa TESO** recibió ayer el espaldarazo definitivo con la firma del contrato de financiación,

que supone **un total de 42 millones de euros**, de los cuales 15 millones corresponden al Banco Sabadell Guipuzcoano, que dirige la operación.

### Translation

The construction of the ferry 'Texelstroom' by **The Navy** for the company **Dutch TESO** yesterday received the ultimate accolade with the signing of the financing agreement,

**that is a total of 42 million euros**, of which 15 million correspond to the Sabadell Banco Guipuzcoano, which directs the operation.

42,000,000 Euro's equals **\$57,540,000 U.S. Dollars**

**Plus solar panels on the roof for about \$100,000,000 less than WSF pays for a 144 ferry.**

### Texelstroom Ferry







---

## Texelstroom Ferry

PROJECT TYPE Dual-fuel ferry

OWNER AND OPERATOR Texels Eigen Stoomboot Onderneming (TESO)

BUILDER LaNaval Shipyard

KEEL LAID December 2014

Texelstroom is a sustainable, new-generation ferry built at LaNaval Shipyard, Spain, for its operator and owner Texels Eigen Stoomboot Onderneming (TESO). The ferry will operate between the islands of Texel and Den Helder, Netherlands.

The eco-friendly vessel is fuelled primarily by a **hybrid diesel oil** or **compressed natural gas** (CNG), complemented by electric batteries and solar power. It is also capable of operating solely on diesel.

The ferry project was conceptualised in 2010, the design works were initiated in October 2012, the vessel's keel was laid in December 2014, and delivered occurred in June 2016. The ferry will start operations following the completion of commissioning.

The design phase of the ferry project formed part of the larger European Union's I. Transfer Program, which aims to make ferry transport more accessible and sustainable.

The [hybrid diesel electric-fuelled vessel](#) is classed by Lloyd's Register. Texelstroom Ferry design details

The ferry is 135m-long and 28m-wide, and has the capacity to carry **1,750 passengers** and **350 vehicles**. It incorporates a 4,000m<sup>2</sup> main hall on the passenger deck, buffet areas, weather decks, service areas, two bridges, offices, a dining area, and other crew areas.

The most prominent area within the ferry is the crèche area, whose design is inspired by a sandy beach. The area features backlit decorative panels and a large artificial tree in one of the galleries. Engines and propulsion machinery for TESO's new ferry

The double-ended ferry is equipped with two independent engine rooms. One engine room is fitted with Anglo Belgian Corporation's (ABC) two ABC 12DZC diesel engines, whereas the other engine room is equipped with two ABC 12DZD dual-fuel (diesel-electric (CNG) engines. All the four engines have a rated capacity of 2,000kW.

The vessel is propelled by two Rolls Royce **azimuth propellers** each fitted at the two ends. It is capable of sailing at an average working speed of 10k and a maximum speed of **15k**. Fuel supply for the Dutch hybrid ferry

The CNG fuel for the vessel is supplied by PitPoint and conveyed to the bunkering station at the island of Texel via a 7km-long pipeline. The fuel is then stored in two containers installed on the vessel's top deck. Sustainability and safety features

Texelstroom is equipped with a heat recovery system, which recovers the heat from the engines' cooling liquid to boil a 90m<sup>3</sup> water tank to approximately 85°C. The recovered heat is then used to heat the vessel while at dock.

**"The eco-friendly vessel is fuelled primarily by a hybrid diesel oil or compressed natural gas (CNG), complemented by electric batteries and solar power."**

The vessel is also equipped with **700m<sup>2</sup> of photovoltaic (PV) solar panels on the rooftop**, with an installed capacity of **approximately 150kWh**, which is used to charge the electric batteries.



Other sustainable design features include the use of an **optimised hull design** to reduce water resistance and optimised ventilation system on the car decks, while smaller chimneys have been chosen and the wheel houses are arranged to be located in a lower position to improve the vessel's stability and wind sensitivity.

The saloon-deck onboard the vessel is equipped with two fire curtains measuring 2.5m-high and 8m-long. The vessel is equipped with foam [fire-fighting systems and fibre-optic-based fire-detection systems](#).

#### Contractors involved

The initial concept and basic design of the vessel was provided by C-Job, whereas the interior and exterior design was performed by Vripack, who further subcontracted Oliver Design to perform the fitting out works. The solar panels for the vessel were supplied and installed by Alusin Solar in collaboration with Bikote Solar. The foam fire-fighting systems and fibre-optic-based fire-detection systems for the ferry's car decks were supplied by InnoVfoam, and the sliding doors for the public areas were supplied by Aluflam Marine. Bolidt supplied its proprietary flooring and decking components for the vessel. Natural gas supplier PinPoint was also involved in the engineering, procurement and construction (EPC) works for the bunker station at the island.

<http://www.marinelink.com/news/capability-managing-ferry413117.aspx>

### Ferry Capability is More Than Managing an Asset

By Trevor Dove

Wednesday, July 27, 2016



Fig 1. Capability Inputs (Source: BMT Design & Technology)

Ferry operations are extremely complex with a combination of inputs that will all impact the ferry's ability to deliver effective operational capability – the asset itself forms only a small part of a system for transporting people and vehicles between two points. All inputs to the ferry transportation system need to be considered to deliver the system's capability and ensure the service is successful.

**Too much emphasis is often placed on the acquisition of a ferry, rather than on the remaining operational inputs, resulting in an ineffective, inefficient and unsuccessful operation.** Only by robust management of all of the capability inputs can an operation be effectively maintained.

To develop a better understanding of the inputs to capability, lessons can be taken from organizations which operate complex systems, such as the defense forces. There are a range of available frameworks that define inputs to maritime system capability which may include the following elements: **personnel, logistics, equipment, infrastructure, policies and procedures, organization and training.**

Each of these elements forms part of a capability. The physical asset, in this case a **ferry, is just one of the seven inputs that needs to be considered.**

Although significant investment is made in equipment, **when considering the through life costs of vessel ownership, the remaining capability elements, as shown in Figure 1, represent a large portion of the overall investment.**

As such, **greater emphasis should be placed on this.**

---

Beyond equipment, the operational coverage of capability elements includes issues relating to recruitment, retention, training and development of people; spares, administrative and training supplies; systems and infrastructure put in place to support an operation, such as transport; procedures and processes, security, command and responsibilities; those parts of the organizational structure which undertake critical tasks, other than operation and maintenance of the asset; buildings, docks, maintenance facilities, training facilities and wharves; and the maintenance of competency of the organization.

**Throughout the lifecycle of a ferry, a comprehensive understanding of associated costs is crucial for business planning and reporting.** For this reason, it's important for stakeholders to duly consider the capability elements aforementioned at all stages of the ferry's lifecycle. **Taking the time to understand these elements at the beginning of a project will allow organizations to manage the costs effectively throughout.** However, if there are major changes in capability this may trigger the need for a review.

A capability upgrade can not only trigger substantial, physical modifications to a ferry, it can mean additional, hidden costs related to the other capability elements, which in turn can become significant if not addressed and managed accordingly.

As an example, consider a ferry modification which has resulted in an additional five meters being added to its length to allow an extra 20 passengers to be transported. The costs associated with such a modification should not just centre on the physical asset itself – organizations must look at all of the capability elements and the impact of such a modification.

Considerations of associated cost issues could include crew numbers and ensuring competencies are sufficient in light of the upgrade; making sure adequate spares are available; other systems which may be affected by the upgrade (i.e. portable water capacity); whether sufficient wharf space is available; if there will be an increase in berthing fees; ensuring the maintenance facilities being used have capacity to deal with a larger vessel.

In addition to a capability upgrade, an assessment of capability elements is also critical when investigating the potential to extend the life of an asset. Although there may not be a change in the ferry's capability, **understanding the costs for a life extension period is important, given that any business case made at project inception has been made with an assumption of ferry life.**

If this assumption changes, **it is then necessary to assess the capability elements to help validate whether or not there is a strong business case for life extension and identify the costs of doing so.**

**Life extension studies are best used as part of the decision making process when considering a vessel's future, as it nears the end of its service life.** Organizations will be looking at two options: to dispose of a vessel at its designated end of service date and replace with a new capability or, extend the life of the current vessel and delay the purchase of a new capability.

In most cases, this decision will simply be down to whether or not it is more cost effective to carry out a replacement project or invest resources into a heightened maintenance regime or major upgrade – **it will not remove the need for eventual replacement.**

**Regardless of the decision, consideration of all capability elements is crucial in developing an accurate picture of costs.**

There are a range of similar approaches used by organizations around the world which could be considered suitable depending on the operation in question. Whether it is in consideration of capability upgrade, life extension or in gaining an initial understanding of the cost of ownership of a ferry, it is recommended that a holistic approach is taken to defining the operation, extending well beyond the acquisition of the asset.

BMT Design & Technology Pty Ltd (BMT) has recently completed a design project for the South Australian Government's Department of Planning, Transport and Infrastructure (DPTI). Working in partnership with the

---

DPTI, BMT has developed a replacement design for ferries that operate on the River Murray, the third longest navigable river in the world, after the Amazon and Nile.

The steel hull, built by local firm Bowhill Engineering, was fit out by the Departments Morgan dockyard. The first ferry has now gone into service in Lyrup with another three scheduled for completion by July 2016, 2017 and 2018 respectively. **These ferries are heavily relied upon by the local communities** for safe passage across the River Murray. BMT delivered a robust design, a critical factor for a service that operates 24 hours a day, 365 days a year.

The team at BMT provided structural engineering and naval architecture services to deliver a detailed design which aligned with the customer requirements. BMT also carried out condition surveys on a further four timber hulled ferries which were nearing end of life. Following the surveys, the Department applied weight restrictions to help maintain the longevity of these ferries for safe operation until they are replaced. Constructed of steel and 22m long, these cable driven ferries can take two lanes of cars or trucks of up to 50 metric tons, or a maximum of 70 passengers.



Fig 2. Iceberg Analogy for Vessel Operating Costs (Source: BMT Design & Technology)

---

## Ferry Fares:

Ferry **deck space** needs to be charged by **actual space used**.

---

With technology vehicles can be measured as they enter the ticketing area. Charging by the foot is more equitable due to the various lengths of vehicles. This would encourage ferry users to use shorter vehicles.

<https://bctrucking.com/bulletin/2015/02/06/horseshoe-bay-terminal-new-vehicle-classification-system-pilot>

---

## Horseshoe Bay Terminal: New Vehicle Classification System Pilot

Posted on Fri, 2015-02-06 15:19

A six-month **Vehicle Classification System pilot** is in place at the **Horseshoe Bay terminal** until July 31, 2015. The VCS uses lasers and radar measurement sensors to measure the length, height, ground clearance, and classification of vehicles, including commercial trucks, buses, other over length vehicles (RVs) and trailers. **The VCS is intended to speed up the ticketing process** and **provide consistent results**. The system is installed just before the commercial vehicle ticket booths between lanes 1 and 2, and automatically measures approaching vehicles over 20 feet in length. BC Ferries says that all components are CSA approved and safe for people.

If you have comments about the VCS pilot, please contact BCTA's Policy Director, Greg Kolesniak, by e-mail at [gregk@bctrucking.com](mailto:gregk@bctrucking.com). There is information about this pilot on the BC Ferries [project site](#).



Site of VCS Pilot at Horseshoe Bay

---

<http://www.nsnews.com/news/scanners-installed-for-oversize-vehicles-at-horseshoe-bay-ferry-terminal-1.1752862>

## **Radar and laser sensors measure oversize vehicles at ferry terminal**

Jane Seyd / North Shore News FEBRUARY 4, 2015 03:53 PM



Photo supplied B.C. FERRIES

Anyone driving a commercial truck, bus, oversize camper or towing a boat trailer departing from the Horseshoe Bay ferry terminal will now have their vehicles automatically scanned and measured before they get to the toll booth.

The move is part of a pilot project that starts Wednesday (Feb. 4) at the Horseshoe Bay ferry terminal and runs six months, until the end of July.

A new scanner — which **uses radar and laser sensors** — **will automatically measure vehicle length, height and ground clearance and provide an electronic display to ticket agents of vehicles over 20 feet in length.**

The scanner will be placed to measure vehicles on the approach to the commercial ticket booth between lanes 1 and 2 at the terminal.

The pilot project is intended to **speed up the process of ticketing for plus-size vehicles and trailers.** It is also meant to ensure consistent measurements and fares for those vehicles, according to B.C. Ferries spokeswoman Deborah Marshall. Currently, ticket agents either rely on the driver's word about their vehicle length or get out of their booths to manually measure the vehicles.

Marshall said there has been some suggestion in the past that some over-length vehicles may have been under-measured or reported and therefore under-charged. The ferry corporation is hoping the scanners will result in an increase in revenue, as well as faster service. Marshall refused to divulge the cost of the scanner, describing it as "commercially sensitive." If the pilot project works as anticipated, the ferry corporation will look to installing the measuring scanners at all of its terminals serving major ferry routes, said Marshall.

Marshall added the ferry corporation has no plans to start charging vehicles under 20 feet in length by measurement.

According to the ferry corporation, the scanners have been CSA approved as safe for people.

Marshall said if any driver has strong objections to the scanner, they can choose to go through a different toll booth and be manually measured.

-----



<http://www.sanjuanjournal.com/news/144057656.html#>

### Locked and loaded: Ferries now laser-equipped



A state ferry worker measures vehicle length using **WSF's new laser-equipped measuring device.**  
— image credit: Courtesy of Washington State Ferries

by SCOTT RASMUSSEN, Journal of the San Juans Editor Mar 24, 2012 at 12:00PM updated Mar 27, 2012 at 4:39PM

Have no fear. The lasers are here.

Washington State Ferries is going high-tech, swapping **measuring tape** for laser-equipped devices, as it embarks on a new era of ticket pricing.

WSF Director of Operations Steve Rogers acknowledges that Ferries found a few flies in the ointment when tickets began to be bought and sold for the new 14-foot-and-under category of vehicles. The 14-foot-or-less category became effective in October, along with a 2.5 percent fare increase, as did an extension of two feet on the standard vehicle category, which now measures up to 22 feet.

"I have to admit in the beginning we had a few difficulties to work out," he said. "I think we have things moving pretty smoothly now."

Saturday, April 28, 2018 Doug Rauh's Bainbridge Island comments on WSF 2040 Long Range Plan Page 35 of 43



---

Rogers said that tape measures could prove imprecise in cases where it came down to inches, and the length of different auto models and brands may change from year to year. He added that owners' manuals generally measure a vehicle's length in inches while Ferries calculates its ticket prices in feet.

What Ferries found, Rogers said, was it needed more precision pumped into the system in order to clear up some of the confusion.

According to Customer Service Manager Susan Harris, WSF has refunded roughly 400 tickets to people — systemwide — who bought a 14-foot or under fare and then later found out that their vehicle failed to measure up. About 25 to 30 of those refunds went to those who bought a ticket for a San Juan sailing, Harris said.

"We're talking about vehicles under 168 inches," Harris said. "When you say 14 feet that sounds pretty big. But when you say it as 168 inches, it doesn't sound quite as large. I think that's one of the reasons that people initially were confused." The solution? Apparently two-fold.

Rogers said a portable **"laser-measuring device" was designed in-house by WSF engineers at the agency's maintenance facility in Eagle Harbor**. The devices have been deployed to "measuring stations" throughout the system, including the Anacortes terminal, and he expects that the measuring process, if needed, will be more efficient and precise. Then, there's also a 14-foot-or-under sticker for your windshield. Have your vehicle measured by WSF and then receive a decal signifying which category your car belongs in and that can be displayed on the interior of your windshield. Rogers said Ferries "encourages" use of the sticker as a way to avoid delay or confusion at the ticket booth.

Harris encourages early arrival at the ferry terminal for those thinking or needing to have a vehicle measured, or schedule an appointment. In Anacortes, notify a ticket booth operator if you wish to have your vehicle measured.

A list of pre-approved 14-foot makes and models also can be found on Washington State Ferries website. Ferries spring sailing schedule goes into (went into) effect Sunday, March 25. It marks the third change in the Anacortes/San Juan sailing schedule with the 14-foot category in place. The cost of a car-and-driver 14-foot fare, from Anacortes to Friday Harbor, is \$41.25. The price of 14-foot or less is \$37.15. For more info about fares; visit, [www.wsdot.wa.gov/ferries/fares/](http://www.wsdot.wa.gov/ferries/fares/)

---

---

### **Ferry Financial Model:**

Current WSF financial model is based on shifting a larger percentage of fare increases from people to vehicles.

**Will this vehicle biased revenue model be sustainable as autonomous vehicles replace privately owned vehicles?**

Where one autonomous vehicle drops off a passenger at a ferry terminal and another autonomous vehicle picks that passenger up at the other ferry terminal.

---

The introduction of autonomous cars and electric bikes/motorcycles will change **the space utilized on the ferry vehicle deck.**

Autonomous vehicles could deliver passengers directly to the ferry terminal and pick them up at the other terminal. Thus removing the need to take a vehicle onto a ferry deck.

Tourist going from Anacortes to Friday Harbor may prefer to use a shared autonomous vehicle compared to the hassle and expense of taking their own private vehicle.

<https://electrek.co/2018/04/27/harley-davidson-electric-motorcycles-younger/>

Micah Toll

Harley Davidson's upcoming electric motorcycles seek to expand to younger, urban riders

- Apr. 27th 2018 8:48 am ET



Harley Davidson's CEO Matt Levatich just confirmed that **the company is on track to meet its goal of releasing a fully electric motorcycle in 2019.**

According to Levatich, Harley Davidson wants to use the **new line of electric motorcycles** to help reach a younger audience focused more on utilitarian, urban transportation.

---

Doug Rauh's comment as of 2018 05 01:

**"How would a 20% reduction in vehicles due to Congestion Pricing affect WSF financial model?"**

<https://www.seattletimes.com/opinion/give-congestion-pricing-a-test-drive/>

**Seattle, give congestion pricing a test drive**

Originally published April 30, 2018 at 4:06 pm Updated April 30, 2018 at 4:19 pm

Saturday, April 28, 2018

Doug Rauh's Bainbridge Island comments on WSF 2040 Long Range Plan

Page 37 of 43

---

**Once people figure out how to take the bus or ride a bike, many find they actually enjoy leaving their car at home.**

By [Sharon Shewmake](#) *Special to The Times*

SEATTLE would likely benefit from congestion pricing, which charges fees to drivers entering downtown areas at peak periods, especially if the city uses the revenues to fund public transportation. But before the city is asked to vote on any congestion-pricing plan, residents should be allowed to experience congestion pricing through a seven-month trial period.

Building more roads, tunnels and bridges, widening lanes, adding HOV lanes, or even expanding light rail does not relieve congestion in the long run. In the short term, there might be more space on the road and fewer delays, but multiple studies have shown that eventually drivers find reasons to take trips and traffic congestion returns.

**The only way to relieve congestion long term is to make driving costly.** Transportation economists advocate for congestion pricing because the revenues can be used to fund transit and provide an alternative to driving.

Stockholm dealt with this opposition by holding a seven-month trial where revenues from congestion pricing were invested into improved transit service. Before the trial, support for congestion pricing in the city was as low as 36 percent, but after the trial, the referendum passed with 53 percent of the vote.

Twelve years later, congestion pricing has become an accepted part of life in Stockholm.

Traffic has [decreased by more than 20 percent](#), air quality has improved, and greater numbers of residents use well-funded public transit subsidized by those who still drive through central Stockholm. The charge was so popular in Stockholm that nearby Gothenburg emulated Stockholm's model despite being a smaller, less-congested city.

Seattle could benefit from congestion pricing too, but voters will have a hard time valuing congestion pricing without a direct experience. Psychology and behavioral economics research shows that humans are loss averse — overestimating the costs of a change in policy and discounting any benefits. This likely explains the change in sentiment cities like Stockholm have seen.

Another reason public opinion changed in Stockholm is that driving in traffic is more stressful than we realize. Directly after Stockholm's trial, traffic was still down 5 to 10 percent despite there no longer being a fee. Once people figure out how to take the bus or ride a bike, many find they actually enjoy leaving their car at home. The city benefits from fewer hours wasted in traffic, better access for emergency vehicles, improved reliability of travel, better air quality, quieter and safer streets and more money invested in the transit system.

Democracy only works if voters understand what they are voting for, and in today's political climate it is hard to know whom to trust. Seattle should run a seven-month congestion-price trial before having a referendum so voters can trust their own experiences. This will help answer many questions about congestion pricing and residents will see what reducing traffic congestion looks like.

Drivers will see exactly how easy or difficult it is for some to give up driving (meaning less stress and wasted time for those still in their cars). The city will have a chance to better understand how congestion pricing with improved transit will impact all residents.

Most important, at the end of the seven-month trial, residents will be able to have an informed vote on whether to keep congestion pricing.

**Sharon Shewmake**, an associate professor of economics and faculty member of the Institute for Energy Studies at Western Washington University, studies how housing and transportation policies impact our environment. London, Stockholm, Singapore, Milan, Gothenburg and other cities all have successful congestion-pricing programs, most of which faced fierce initial political opposition but have now become an accepted part of city life.

**Ferry System Demographics:**

**As Baby Boomer ferry users age out of the work force will peak demand for service shift to mid-day?**

<http://wstc.wa.gov/Meetings/AgendasMinutes/agendas/2018/April17/documents/0417-BP1-WSF2040LongRangePlan.pdf>

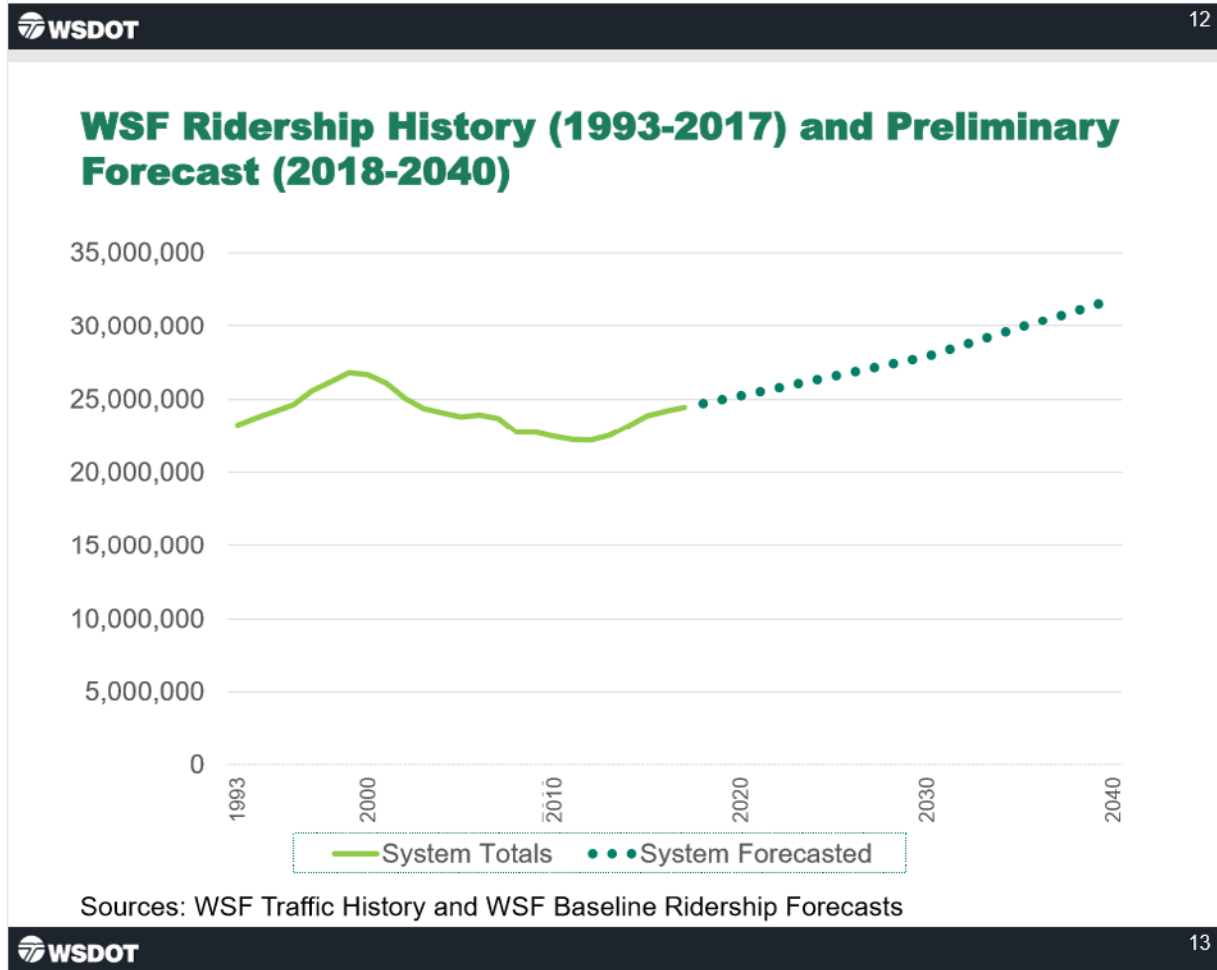

Doug Rauh's comments on WSF Ridership:

**Why does WSF future ridership predictions only go up** when in the recent past WSF ridership went down for years?

**To me this graph is not realistic.**

**There will be a recession in the next 20 years plus many of today's "Baby Boomers" won't be riding the ferry in 20 years.**

---

**Terminal Automation:**

**The Vehicle Ticketing process from highway to holding needs more automation.**

All passenger turnstiles need to accommodate commuters with computer roller cases and travelers with luggage.

---

**Old Coleman Dock turnstiles did not allow wheeled computer cases or luggage to go thru all but one special turnstile.**

Software Developer is the largest job title in Seattle.

**WSF needs to match their equipment to their customers.**

**The turnstiles may have been great for Disneyland but WSF Bainbridge route is the mass transit from the West Sound to the East Sound for Software Developers and other office workers.**

Many WSF customers (commuters, students, consultants, other) haul their computer in a roller case between home and office.

**WSF design of turnstile layout did not allow for ticketed passengers to pass thru the turnstile until the ferry was unloaded.**

**This only allowed 10 minutes for the loading passengers to pass thru the turnstiles.**

On the Bainbridge route peak period there could be 1,500 passengers waiting to load.

Any little glitch becomes a major problem and unnecessary stress for WSF customers.

---

---

### Terminal to Ferry Loading:

Needs to be **more efficient** and **safer** for both passengers and vehicles.

---

WSF passenger gangway at the BI terminal needs to **allow unload/offload** to both the North/South sides of Olympic Drive (SR-305) in order to **eliminated the need for pedestrians to cross** at traffic signal next to the toll booths. This is both a safety problem and an efficiency problem.

Sync the traffic signal next to the toll booths to the SR-305/Winslow Way traffic signal and disable the pedestrian override.

Convert the traffic signals from time of day (old) to the newer Adaptive Control which are capable of changing the signal timing based on demand.

Ferry traffic peaks just before and after a ferry arrives but the old style traffic signal do not adjust for the change in traffic demand thus making the highway infrastructure less efficient causing unnecessary congestion.

Change both lights to **Adaptive Control Traffic Signals** and **increase the green time** during the ferry unload. This could be funded under a Federal Highway Administration **Accelerated Innovation Deployment** (AID) Demonstration and/or Tiger Grant of the interface between marine/land transportation systems. <https://www.fhwa.dot.gov/innovation/grants/>

It appears as if WSF terminal operations designs inefficiencies into the process.

At Texel, Netherlands the TESO ferry loading process uses **automatic gates** and **traffic signals** to manage the vehicle loading and unloading.

This is all done from a single control building.

---

<https://www.youtube.com/watch?v=s9U7UalARxA>

Veerboot Ferry Boat Fähre Den Helder ~ Texel TESO Bootdienst 06 **2017**

**Unload reload 350 cars in 10 minutes** by loading both upper and lower decks simultaneously  
**WSF unload reload 202 cars in 20 minutes.**

Time efficiency is all in the design.

Teso is a private company while WSF is a government service subsidized thru tax revenue.

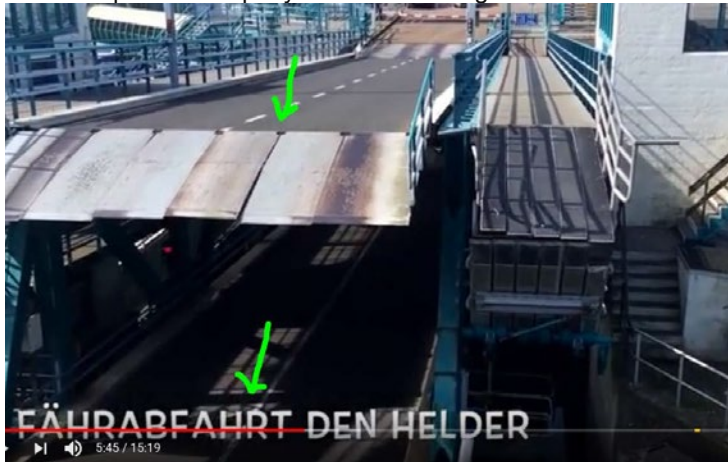

<https://www.youtube.com/watch?v=sOKZ2NLFvQQ>

Texel Island dual vehicle loading ramps allows 350 cars to be unloaded and reloaded in less than 10 minutes.

---

Saturday, April 28, 2018

Doug Rau's Bainbridge Island comments on WSF 2040 Long Range Plan

Page 41 of 43



---

## Online Ticket sales

Seniors are not allowed to buy discounted senior ticket online per WSF policy.

WSF ticket process should validate the right to use a particular ticket at time of use **NOT** at the time of purchase.

---

Using virtual ticket agents at the terminals would allow better coverage thus spreading the demand for tickets. At night a couple of ticket agents would be able to cover all the WSF terminals during times of low demand. Using remote audio/video WSF could provide language translation for those customers who do not speak and/or read English.

---

<http://www.railwaygazette.com/news/technology/single-view/view/virtual-ticket-agents-aim-to-boost-ticket-machine-use.html>

### Virtual ticket agents aim to boost ticket machine use

22 Dec 2017



UK: Greater Anglia says it is the first train operator in England to roll out **Scheidt & Bachmann's FareGo VITA 'virtual ticket agents'** across its ticket machines, **enabling passengers who have a query to press a button to contact staff via a two-way audio link.**

The 196 Scheidt & Bachmann ticket machines on the Greater Anglia network have been upgraded with a speaker, microphone, software updates and a connection to the **in-house call centre** in Essex which is **staffed by 13 ticket sellers and operates 24/7.** The ticket agent can give advice and information, and they can also **remotely control the machine on behalf of the customer,** with the exception of the card payment screen.

During the pilot phase from September 8 to October 29 the centre received an average of 250 calls per day, of which 30% came from London Liverpool Street station.

'We know that customers sometimes feel apprehensive about buying tickets from a machine as they are unsure of how it works or which is the best ticket for their journey, so being able to connect straight to a friendly voice who can help will really improve the service we offer', said Customer Service Director Andrew Goodrum.

**'We hope it will result in ticket machines being used more, helping to reduce queuing time at ticket offices** and offering customers a better level of customer service, enabling them to buy with ease and confidence.'

---

---

<http://www.masstransitmag.com/article/12011573/cubic-displays-number-of-customer-ticketing-solutions>

## **Cubic Displays Number of Customer Ticketing Solutions**

ARTICLE OCT 20, 2014



The **Cubic NextAgent Video Ticket Office** can provide **out-of-hours ticketing** and **pool specialists skills such as foreign languages** or unusual ticketing requirements, allowing customers to interact with a real ticketing agent **remotely**.

**Photo credit:** Mass Transit

---

<https://vimeo.com/112308494> 6 minute video showing how Next Agent works

### **Next Agent: The Next-gen Ticket Office, Call Center & Ticket Vending Machine** **Cubic Transportation SystemsPRO** Published on Feb 5, 2014

Introducing the next generation of ticket vending machine: NextAgent by Cubic. Transport operators are continuously faced with pressure to reduce costs, to maintain excellent customer service and to look after staff...as well as deliver their regular travel services. At the same time, travelers want to know that they are buying the right ticket at the right price, and they want real-time, reliable information to help with their journeys whenever they need it.

**NextAgent by Cubic** is a blend of **traveler information center, call center and ticket vending machine**, designed to complement existing ticketing facilities.

---

---

Doug Rauh  
12266 Kenneth Place NE  
Bainbridge Island, WA 98110  
206 842-7046  
[rauh01@msn.com](mailto:rauh01@msn.com)

## Comments on the WSF 2040 Long Range Plan.

---

WSF's needs to convert the ferry fleet to a **lighter aluminum LNG** and/or battery ferry using **azimuth propulsion system** and a **single pilot house** similar to the Norwegian **Ampere** design.

The **design life** should be reduced from 60 to **30 years**.

The size should be reduced to allow 3 or 4 ferries per route compared to the current 2 ferries per route.

---

An out of service maintenance period of 12 weeks or 3 months per years is excessive.

**WSF should not plan to have a ferry in maintenance for 15 years of a 60 year life.**

[https://www.marinelink.com/news/tote-touts-lngasfuel-experience-442751?utm\\_source=MR-ENews-Weekdays-2018-10-18&utm\\_medium=email&utm\\_campaign=MR-ENews](https://www.marinelink.com/news/tote-touts-lngasfuel-experience-442751?utm_source=MR-ENews-Weekdays-2018-10-18&utm_medium=email&utm_campaign=MR-ENews)

Totem Ocean Trailer Express expects their LNG vessels to work 51 weeks out of 52 weeks per year.

Why should I expect WSF to work our ferries only 40 out of 52 weeks.

---

**Build smaller aluminum ferries that more than one shipyard (Vigor) can build and/or perform maintenance on.**

---

**Change WSF policy to all anyone to buy any ticket WSF sells.**

Validate eligibility for the ticket being used at the time of boarding.

Restricting seniors from purchasing ticket online needs to stop.

---

**Don't convert the Mark II class to electric propulsion; it is a waste of time and money.**

The Mark II class is too heavy for cost effective electric propulsion.

Now is the time to design an electric ferry for the Puget Sound.

Building the fifth Olympic class ferry would only commit Washington State to another 60 years of buying diesel.

**With five Olympic class ferries Washington State would have committed to buying 300 ferry years of diesel.**

To bring fuel costs down WSF needs to switch to some other source than diesel.

In 2020 when the low sulfur regulations go into effect worldwide the price and availability of low sulfur diesel may become an issue for WSF.

[https://www.marinelink.com/news/maritime-rule-change-stirs-fears-diesel-443064?utm\\_source=MT-ENews-2018-10-25&utm\\_medium=email&utm\\_campaign=MT-ENews](https://www.marinelink.com/news/maritime-rule-change-stirs-fears-diesel-443064?utm_source=MT-ENews-2018-10-25&utm_medium=email&utm_campaign=MT-ENews)

---

***The International Maritime Organization (IMO) has so far resisted pressure to soften or postpone the implementation of new regulations requiring ships to use bunker fuels with a lower sulphur content from the start of 2020.***

That has prompted warnings from some analysts that the regulations will squeeze the availability of low-sulphur diesel and jet kerosene required by trucks, trains, aircraft, farmers and industry, **resulting in big price increases.**

---

**With the Southern Puget Sound Orcas in danger of going extinct WSF needs to reduce its ferries noise pollution.**

---

At Bainbridge all passengers (5,000,000+) are unloaded to the north than they have to cross thru the unloading cars to get to the south side of Olympic Drive.

**WSF should unload to both sides in order to reduce the turnaround time while improving pedestrian safety.**

---

Thursday, October 25, 2018

Doug Rauh's comments on the WSF 2040 Plan as of 2018 10 25

Page 1 of 2

---

The policy of unloading bikes first needs to be changed in order to reduce the time it takes to turn a ferry around. Holding the cars on the ferry deck while bikes climb up hill on Bainbridge does not appear to be the most efficient process for unloading a ferry.

**Why does it take 20 minutes for WSF to turn around a 202 autos and 2000 passengers?**

**The 340 autos and 1750 passenger Texelstroom ferry is turned around in less than 10 minutes.**

<https://worldmaritimeneews.com/archives/202536/texelstroom/>

The design of Texelstroom ...This leaves a very short time of **less than ten minutes for loading and unloading of the vehicle decks.**

[https://nl.wikipedia.org/wiki/Texelstroom\\_\(schip,\\_2015\)](https://nl.wikipedia.org/wiki/Texelstroom_(schip,_2015)) (340 autos and 1750 passengers)

---

At Bainbridge the WSF customers travel down SR-305 to get to the terminal.

WSDOT is planning on building 6 roundabouts to reduce the highway speed from 50mph to 15-20mph.

This will directly impact access to the Bainbridge terminal for off Islanders and may encourage off Island traffic to use local Island roads to get around the queue waiting to get through the Day Road roundabout.

**WSF should not wait till land side infrastructure is built to get involved in how ferry customers are going to access the boat.**

It would be to WSF's advantage to have **adaptive control traffic signals** instead of roundabouts in order to use artificial intelligence to manage traffic for maximum efficiency on the highway system.

WSDOT has already put in several adaptive control traffic signals on the east side of the Puget Sound.

**WSF should be concerned that all ferries leave with the highest gross revenue the ferry can generate.**

When a ferry leaves with a partial load while customers are not able to access the boat due to long queues at roundabout this would be a very poor long term strategy.

This will also affect the walk-ons using buses.

Note: Roundabouts fail at about 85% of design capacity. Due to the pulsing effect from ferry unloads once per hour all 6 roundabout should fail every hour creating long queues waiting to get thru.

When a roundabout fails it will act like a stop sign on the leg where the queue has been created.

---

**Vehicle and revenue growth** does not appear to consider the effect **autonomous vehicles** will have on both.

---

Improve technology everywhere.

**Add more traffic cameras along routes to ferry terminals.**

**Allow pre-ticketed vehicles to use WSF scanner to enter holding area.**

Design/build ferries with power plugs and tables to accommodate electronic devices.

---

**Allow musicians and other entertainers to work the ferries especially on weekends.**

**Design/build ferries with kids and older adults in mind.**

**Vary the height of seats to accommodate the different heights of your customers.**

---

Simplify the fare system.

**Charge all vehicles the same amount based on the length of deck space used.**

---

Please see comments on the draft WSF 2040 Long Range Plan for additional comments.

F J Nelson Comments WSF Draft 2

20181025

Section	Title	Page	Topic	Comment	#
0	Summary		First Impression	Plan is well put together, covers themes, but, is NOT COMPELLING – Lacks clear picture of why reliability is the prime issue. Need to Show why fleet needs to be Stabilized, through numbers, and Consequences if not stabilized.	1
				Lacks sums, 1 or 2 examples of vessel planned and unplanned maintenance, deferred maintenance cut from budget, unexpended maintenance budget, and cost of moving vessels to perform unplanned maintenance per biennium or year since 2007. A highlight block or chart, prior to recommendations, is needed to show the “instability” of the fleet (and why Issaquah class will not reach planned 60 year useful life).	2
				A section, Consequences, needs to be added to briefly outline, for each theme, how failure to accomplish recommendations will adversely affect system and aggravate the conditions that have created the public recognition of these themes, and increase the system O&M costs and the farebox recovery to beyond the 80% this Plan projects.	3
				While having read and compiled almost 40 pages of notes on Plan, comments here primarily address things I offer as needing to be improved, or really impressed me and so want you to know.	4
				1 <sup>st</sup> ¶ Recommend replace “support” with “will deliver” - neither reliable, sustainable nor resilient at present, but execution of this plan WILL make it so. “Supports” make the Plan a secondary player.	5
		2	Proposal	Identifying the groups you successfully brought into development of the Plan is excellent. Why did you not include your consultant Team? Makes it clear you are taking full advantage of expertise.	6
		2	Development	Last ¶ Make the themes stand out! This is a significant accomplishment in Plan development!	7
		2	Themes	Like this!	8
		3	Theme Graphic		

**F J Nelson Comments WSF Draft 2**

20181025

This is where a highlight block or chart should show how deferred maintenance is piling up and unplanned maintenance is increasing due to insufficient reserve vessels and at least a reference to its impact on other themes as well.

3	Fleet Stability		9
3	Reliable Svc: Vessels	Very Good. Suggest on 60-yr bullet, suggest change to Re-examine.	10
3	Reliable Svc: Vessels	Very Good. Suggest change Issaquah bullet: "will shorten" to "is shortening" as this is happening.	11
3	Reliable Svc: Vessels	On maintenance bullet, suggest change "Allow for" to "Provide for the needed" - Reliable doesn't happen because it is allowed, it happens because the needed steps are taken.	12
3	Reliable Service: Vessels	In grow the fleet sub-bullet, add "in order to keep routes in service when maintenance needed" - not everyone will make the connection.	13
4	Reliable Service: Terminals	You missed the two biggest arguments for working on terminals: seismic risk and ocean level rising. Suggest you make that a sub-bullet under Plan for	14
4	Reliable Service: Workforce	You should be updating salary survey data already – but you may not be partnering with Navy, Vigor, Tote and other maritime operators for recruiting and training. You might consider adding this.	15
5	Customer Experience	Suggest you modify bullet to upgrade systems to include "with intent to then combine into a unified system" .	16
5	Customer Experience	One item missing: WSF will work with local agencies and business to push for parking facilities near terminals. As you have seen, this is a customer issue, and a local agency issue as well.	17



## F J Nelson Comments WSF Draft 2

20181025

6	Manage Growth	18
6	Manage Growth	19
7	Sustainability	20
7	Sustainability	21
8	Resilience	22
9	Progress of 2009 Plan	23
9	Invest & Implement	24
10	Invest & Implement	25
10	Invest & Implement	26

One item missing: WSF will work with local agencies and business to push for parking facilities near terminals. If you want to use ALS to reduce number of vehicles, you need a reliable, safe place to park. I have such, by taking 0620 ferry and arriving early. And I walk a mile each way on Seattle side to/from work. Without parking, I would forgo that well-paying work.

Bullet on fare structure and pricing needs to include: "in coordination with ORCA development to make shift to walk-on from drive-on more attractive."

This section is weak. Sustainability is the deliberate choice to use materials and processes that take the least from the earth, do the least harm to the earth and its occupants, and provides a needed service at an affordable cost (in fares and taxes). You have many of the pieces, but they are generic, not concrete, so they do not have meaning to many, including Legislators.

Tie in with Reliability (A fleet is unsustainable if unreliable. An unsustainable fleet makes providing service unsustainable. Loss of ferry service makes west sound communities unsustainable.) Recommend a bullet "Achieve sustainable fleet size, to permit necessary maintenance and improvements to minimize negative impact on Puget Sound environment and customer service."

Also weak, but excited that this is included. Consider replacing "to enhance preparedness" with "to prepare for likely events" Detail bullets very good.

Ok. But it looks like a continuation of the last theme. Need a way to make it stand out.

Same.

1st ¶ Recommend you make last sentence its own paragraph and start it with "The key steps" - to show legislative decisions on finance are critical .

The bar charts are great! They show you have been managing O&M funds well and will be just a bit shy of needs. The part not in your court, capital investments, needs rapid and serious attention by the Legislature.

	Asking for \$6.3 billion will be a shock, especially compared to dedicated capital of \$1.3 billion. The \$330 million per year is potentially not as disturbing, especially if you point out, a stabilized fleet of 26 needs 1 vessel replaced every 2 years or \$75 million per year. Another \$25 million [?] per year for terminal capital points to only a \$100 million or so capital funding stream after 2040. {You could add, if such a capital stream had existed for last 30 years, there would not be a need for the \$330 million stream over next 20 years.}	27
10	Invest & Implement	
10	Invest & Implement	28
11	Summary	29
13	Plan provides	30
14	Implementation	31
14	Vessel chart	32
15	Purpose	33
16	2009 Plan	34
<b>1 Introduction</b>		
17	Approach 2040 Plan	35
18	Advisory Groups	36

## F J Nelson Comments WSF Draft 2

20181025

20	Outreach Results	Because you made it easy to provide input, you ended up with serious comments that emerged as clear themes you could use. Interaction with customers proved this was a useful endeavor.	37
22	Consultant Team	Agree engaging underrepresented is important, but as you look at your highlighted block and compare that to the lion's share of work that is listed below it, you feel something is amiss. You might consider putting the block on pg 21 and using 22 just for your Consultant's efforts.	38
24	Phase 2: review draft	Bullets are Very Good.	39
27	Ridership forecast by route	Map with forecasts shown by route is Excellent.	40
28	Ridership & regional growth	Recommend reword to: WSF Mission is to connect customers ... and to effectively meet ... long-term needs ... by accommodating anticipated growth in ridership.	41
28	Review local plans	Recommend add ", such as parking, " after facilities.	42
29	Traffic congestion near terminals	Highlighted practical solution at Kingston is excellent! It shows how stakeholders can successfully work together to deal with this increasingly more common problem.	43
30	Triangle route study	You should examine adding this report to the Task 16 Route Operational Analysis references, and expand the highlight to include synopsis of key findings,	44
32	Reliable service	Recommend adding "to customers." end of 1 <sup>st</sup> ¶. Agree it appear redundant, but clearly ties into Customer Experience, which is needed.	45
32	Customer Experience	Highlight is good. But paragraph misses the one point brought up frequently in your outreach: Reliable cell and wifi service. Paragraph is very generic. Needs to identify at least one or two specifics being looked at, even if never adopted, such as weigh-in-motion type drive through fare collection (measuring vehicle type and length instead of weight).	46

## 2 Plan Elements

	Too lean. Highlight should have bullet for Examining ways to increase vehicle and pax capacity of vessels. This gives you the opening to look at considering the new 144s to be 150 or 155 with pax capacity of 1800, either as built or with provisions to enable hull extension.	47
33	Manage growth	
	Also too lean. Highlight should include bullets for Invest in infrastructure to maintain reliable service in changing climate, Invest in 2 <sup>nd</sup> slip if not present to facilitate maintenance and inspection while providing service and to enable two vessels when needed, Keep vessels and terminals in good condition so meet service needs and avoid damage to environment, Replace creosote protected wood facilities with steel or prestressed concrete, with rubber facing for fender pilings, and plan vessels and terminals to adapt to changing ridership patterns and volumes.	48
	Sustainability and resilience	
33		
34	Plan by route	49
	Proposed enhancements map	
35		50
	Good synopsis. Excellent! Clearly identifies actions for vessels, terminals and operational changes.	
	Ties in with customer experience - "Reliable service is by far the greatest priority for customers". Suggest a small change – degrading condition of the aging fleet will "continue the decline in service reliability unless" ... This helps show this is a continuing problem, and a Consequence of not funding the recommended investments.	
37	Stabilize the system	51
	<b>3 Reliable Service</b>	
	Disagree on one item. Recommend that you do not retire the Hyak until the first vessel is delivered off the proposed extension of the Olympic contract. The Tillikum is not capable of relief service for any routes except InterIsland and Pt Defiance. Not a sustainable or resilient or reliable option.	52
37	Vessels	
	Recommendation paragraph is very good. As in previous comments, suggest remove "help" and replace "can" with "will" to make this stronger.	53
38	Vessels	

## F J Nelson Comments WSF Draft 2

20181025

38	Vessels	Excellent chart! Shows clearly why over 50% of the fleet needs replacing in this period, 3 need midlife overhaul and what others may not catch is that the seven newest vessels will need midlife overhaul in the decade after this plan period ends. Recommend you make the footnote on Hyak say "retired when 1 <sup>st</sup> vessel delivered from the Olympic contract extension."	54
38	Vessels	Since you are following the chart with an action to replace the Issaquah class at 50 years, suggest you show the last 10 years on each in this class in a lighter color	55
39	Fleet limitations	Does not say that the one vessel that is typically available for emergency relief is the Tillikum, which is at 60 years already and does not have the speed or capacity to fill in for any central sound vessel needing unplanned maintenance.	56
40	Maintenance and preservation needs	2 <sup>nd</sup> ¶ should say "adequately meet" instead of "fully meet", given the disruptions.	57
40	Maintenance and preservation needs	2 <sup>nd</sup> ¶ should end with "U.S. Navy and the U.S. Army, which awarded a 10 year \$1 billion contract for aluminum tank landing craft," ...	58
40	Maintenance and preservation needs	3 <sup>rd</sup> ¶ should indicate that the funding provided was less than what was needed. That resulted in deferred maintenance that shifted to the 2015-2017 budget request. The Governor's budget cut \$35 million of maintenance budget which deferred other work to the 2017-2019 budget. Lack of vessels will prevent using all of the current budget, again. This is shown nicely in the cycle of backlog and risk. But it is not circular; that implies it somehow evens out. It is actually a "death spiral, the risk keeps growing as maintenance is not performed until we have of fleet of "Steel Electric" vessels.	59
41	Plan recommendations	Bullet 1: suggest making it "two to stabilize the fleet with relief vessels so overdue critical maintenance can be performed and three to replace vessels, in 5 to 7 years, because of their condition and scheduled retirement."	60



**F J Nelson Comments WSF Draft 2**

20181025

41	Plan recommendations	Bullet 2: Recommend "Re-examine" ... "in particular the Issaquah class." Bullet 3: "Make 12 weeks the standard for" ... "the goal of 60 years of reliable service." I know this is what you intend, so say it. This ties the 12 weeks to Reliability.	61
41	Plan recommendations	Bullet 4: "Invest in new vessels to replace retiring vessels in line with the Vessel retirement outlook chart in this Section, or earlier, if needed to provide scheduled service reliably, and avoid a repeat of Steel Electrics."	63
41	Extend open Olympic contract	2 <sup>nd</sup> ¶ "Three relief vessels will only permit two-thirds of the needed 12 weeks" ... Relief vessel do not support – they are the REASON maintenance can be performed!	64
42	Extend open Olympic contract	4 <sup>th</sup> ¶ Recommend break up into two. Start new with "The three replacement vessels would each receive some minor modifications for hybrid electric propulsion, and at least one slightly modified for certification as an international vessel (SOLAS compliant) to replace the Elwha on the Sidney, British Columbia route.	65
42	Extend open Olympic contract bullet	Recommend: ... "WSF would immediately use the first two delivered to rearrange 144 car vessels to result in two additional relief vessels to release two in-service vessels for needed maintenance and preservation. The next three would replace vessels that need to be retired prior to 2027."	66
42	Re-Examine 60-year life expectancy	Recommend recommendation title be "Re-examine ..." as this is something an owner should be periodically doing, and has been a topic for at 11 years that I know. The caveat included is good. It shows application of logic.	67
42	Re-Examine 60-year life expectancy	1 <sup>st</sup> ¶ Service reliability will be a high risk during within the first 10 to 15 years of the Plan, in part" ... "experiencing reliability issues and steel degradation that is significantly shortening their attainable service life." ...	68

## F J Nelson Comments WSF Draft 2

20181025

	Bullet: Agree with the statement about syncing up with planned improvements. But what needs to be said first is: "Retirement at age 50 forces replacement vessels to be delivered around the year 2030, vice 2040. Approval will be needed to start development of the design and contract for their replacements by 2022. Make original bullet a second bullet.	
42	Retire the Issaquah Class early, at 50	69
43	12 weeks of annual out-of-service maintenance	70
43	12 weeks of annual out-of-service maintenance	71
44	12 weeks of annual out-of-service maintenance	72
44	12 weeks of annual out-of-service maintenance	73
44	Grow the fleet from 22 to 26	74
45	Invest in new vessels	75

Bullet: Agree with the statement about syncing up with planned improvements. But what needs to be said first is: "Retirement at age 50 forces replacement vessels to be delivered around the year 2030, vice 2040. Approval will be needed to start development of the design and contract for their replacements by 2022.  
Make original bullet a second bullet.

Recommend retitle as Make 12 weeks of annual out-of-service maintenance and preservation time the standard to achieve a 60 year life expectancy of reliable service"

A standard is something one must meet and report deviations, where a goal is what we would like to meet. Reporting failure due to lack of vessels shifts risk to where it belongs.

1st ¶ Well said. Except. If you are going to state other ferry systems have shorter life expectancy standards to you need to show their figures and provide reference(s) where they could be checked (in reference list at back). You might consider "reliable life" over "useful life"  
Remaining are also great as is.

1st ¶ Recommend "WSF will monitor and re-evaluate" ...  
2<sup>nd</sup> ¶ Recommend "To perform the needed maintenance and preservation" ...

Bullets are perfect. Clearly outline purpose!

1st ¶ Needs to lead with: "The condition of the fleet is of such concern, that it drives the critical decision to extend the existing Olympic contract to produce 5 vessels as quickly as physically possible. But even with that, the factors in restarting will result in delivery in 2022, possibly 2021, and at least year later for the second. So customers will not perceive much change in reliability until 2023 at the earliest."  
Then fit in "Meanwhile ... reliability is realized.",  
And end with "The bottom line is vessels need to be replaced as laid out in the Vessel retirement outlook chart."

45	Retire and replace	<p>Bullet: Recommend “Retire and Replace 13 vessels by 2040 as per the Vessel retirement outlook chart: This recommended retirement schedule will result in an overall younger, more energy-efficient, better-maintained and more reliable fleet.”</p> <p>following after 1st paragraph:                  The existing 2018 WSF has seven classes:                  * Jumbo Mark II                  * Jumbo                  * Super                  * Olympic                  * Issaquah                  * Kwa-di Tabil                  * Evergreen</p> <p>Will become the five classes of the WSF 2040 Fleet:                  * Jumbo Mark II Hybrid                  * Olympic                  * New 144-Car Hybrid                  * New 124-Car Hybrid                  * Kwa-di Tabil Hybrid</p>	76
45	Streamline the fleet	Other than above, streamlining well-defined.	77
45	Streamline the fleet	Recommend start with “Provided the capital investments recommended by this Plan are approved to permit timely execution of the vessel replacements on schedule, the 2040 fleet” ...	78
46	2040 WSF fleet	<p>Since the Plan has indicated a need to accommodate some growth in ridership, and even allowing for significant walk-on growth on routes that already have high walk-on counts, many routes will have difficulty in making this shift, resulting in a growth of vehicles. A way to counteract that, would be to make the new 124-Car ferry, a 130-Car ferry. Worth considering now, even if only as an option to discuss in the replacement contract scope. Too stay within standardization, it would be all or none.</p>	79
46	New 124-Car vessels		80

	Similarly, with the Kingston/Edmonds route possibly going to 3 vessels, you should seriously consider this new class to be 150, 152 or even 154, approx a 5% increase in deck space. Stretched in the middle, with 11 lanes, adding 1 car length would add 11 vehicles to make 155. The current Olympic has space for 1400 pax. That is barely working with the Brementon run. 1800 would be an improvement. The Kaleetan has space for 2000, which works well, and would handle projected increases. Chimicum could not.	81
47	New 144-Car vessels	81
47	New 144-Car vessels	82
47	2040 WSF fleet	83
48	Terminals	84
48	Terminals	85

48	Plan recommendations	<p>Recommend placing Invest in Eagle Harbor at the top of the list. The additional relief vessels will need parking places, as will vessels coming in for work. If Eagle Harbor facilities are not up to handling the 14 week per year maintenance and preservation, then the investment in the vessels will not have gained much.</p>	86
48	Plan recommendations	<p>Recommend Plan 2<sup>nd</sup>, Program 3<sup>rd</sup> and Monitor 4<sup>th</sup>.</p> <p>Recommendation is weak. You need to point out problems or opportunities. If you want to improve your model, it is so you can better identify critical work sooner and to better document what is needed and why. Maybe figure in a mechanism to include local politics and community concerns. Feel free to use any of this. It is based on U.S. Navy planning for facilities.</p>	87
49	Plan for reliable terminal	<p>Informative, yet simple chart! It also tells me that Eagle Harbor investments ought to be highest priority in this topic. But. To show that effort has been spent on those in worst condition a second chart tracking annual condition back 10 years for the 3 you want to "sell" would be an excellent addition. Condition vs year, three line types (or 4 if you chose 4).</p>	88
50	Monitor terminal maint	<p>2<sup>nd</sup> ¶ Very good. You should branch from it to show how monitoring has already identified Faunteroy and Southworth Work, plus Anacortes, and the two under construction, Colman Dock and Mukilteo.</p>	89
50	Monitor terminal maint	<p>Also, please add a statement about second slips wherever both useful and practical, and space for side loading, again where useful and practical.</p>	90
50	Monitor terminal maint	<p>Also, please add a statement about second slips wherever both useful and practical, and space for side loading, again where useful and practical.</p>	91



	<p>This does not follow from the section. Do not disagree paint is an issue, but woud put bullet to identify timber pilings at risk and consider restressed precast concrete piles, steel core recycled plastic piles and recycled plastic steel reinforced waters to reduce corrosion or boring damage and not create painting requirements, (Have done this on movable bridges and ship piers).</p>	92
Terminal recommendation		92
	<p>You have a bullet for Fauntleroy, but it says "Plan for"; should say "Program and execute critical" ... Fauntleroy is significant enough, and complicated enough to deserve a paragraph to discuss piling deterioration, deck level too low for sea level, insufficient deck space for holding area, for efficient toll collection and for new technology drive thru lanes, traffic control for reduced dwell times, ...</p>	93
Program terminal projects		93
Program terminal projects	<p>You should have a bullet, or two, to cover Program preservation and improvements at Friday Harbor and Southworth.</p>	94
Program terminal projects	<p>Have heard Anacortes needs work as well. If true, should have bullet for Plan or Program for it, as appropriate.</p>	95
Invest in Eagle Harbor	<p>Since this warrants its own topic, needs to be #1 on your list – Comment 86.</p>	96
Invest in Eagle Harbor	<p>Bullet is appropriate. Is it "Plan" work or "Program" work. I think the later, since it needs funds.</p>	97
Invest in Eagle Harbor	<p>A second bullet is necessary. Given the age of the facility, I am sure the shops and storage facilities do not meet current standards. Likely the same with roof, windows, doors, pavements, weight handling equipment ... Potentially the same with slips. Recommend at least one bullet to upgrade the maintenance facility itself.</p>	98

53	Workforce	<p>Topic Invest in attracting and strengthening the workforce does an excellent job describing what it takes to be a master/mate or a chief/assistant engineer. Well done. What is missing however, is a similar description of maritime trades. Shipyards, such as Eagle Harbor have need for pipefitters, machinists, carpenters, painters, equipment operators, equipment mechanics, electricians and electronics techs – but with knowledge and skills in working on vessels – which are not the same as buildings, bridges or tunnels. And local agencies and private yards pay much more for tradesmen than the state typically can.</p>	99
55	Workforce	<p>Plan recommendations do not really address the issues presented in the writeup. Need a bullet to address Plan to attract, assign and develop seamen with potential to become quartermasters or licensed mates per industry standards, and include paying costs for training to encourage them to stay with WSF and ultimately become licensed masters.</p>	100
55	Workforce	<p>Need a similar bullet to address licensed engineers, oilers and wipers.</p>	101
55	Workforce	<p>You brought up the delta between where crews live and where vessels start their service day. You did not provide a bullet to address this. It may not yield to a resolution, but add a bullet to try: Survey crews whether they would be open to relocating closer to start points if WSF could assist in some way. An incentive to live in Kitsap or Jefferson county for instance. Also ask if commuting by water, a service craft like a small POV would help. Put in a placeholder bullet: WSF will work with crews to ease the burden of commuting to vessel start points.</p>	102

## F J Nelson Comments WSF Draft 2

20181025

55	Workforce	Assuming you added a subsection for shipyard maintenance workers at Eagle Harbor, provide a bullet for Elevate recruiting, training, and retention of maintenance workforce to the level necessary to acquire and retain the skilled workforce needed to keep WSF vessel reliable without excessive turnover. This should be a metric with Secretary level attention.	103
55	Workforce	The three bullets listed under Establish workforce development plan do not show any recognition of maritime conditions or even condition within WSF. They are generic enough to apply to McDonalds. And you should be doing them whether this Plan exists or not.	104
55	Retain skilled labor at Eagle Harbor	You have identified the major challenge in keeping skilled labor in WSF. People with skills have a need to be valued, to be recognized and to influence the place where they work. They also seek a camaraderie with their peers. If these elements exist, it takes a significant amount of money to entice them too leave. You need a bullet to develop a working environment at Eagle Harbor that talented and skilled workers want to join, and not leave. Since I now WSF fights for pay raises, add a bullet that says you will constantly survey regional salary data to ensure their wages are always competitive.	105
55	Retain skilled labor at Eagle Harbor	Agree with apprentice bullet.	106
55	Retain skilled labor at Eagle Harbor	What is missing? A bullet to develop journeymen and masters in their trade. Please discuss and add this if staff at Eagle Harbor thinks it would make a difference.	107
57	Enhance connections & technology for easier trip	1st ¶ an excellent lead in.	108
4	<b>Customer Exp</b>		

As a side note, representing those who are not as interested in high tech customer interfaces, my first experience is the overhead loading operator who gets us on board with a big smile, the seamen who smiles and says good morning when we get on board, whether cell service is present when I sit down to work, and the ramp operator who smiles every time I debark at Colman dock. I buy my tickets AFTER I get off since as a senior I must buy them in person. Not a problem and I am always helped by a very nice person. The few times I drive, the Bremerton ticket booth operator is always very nice and gets me through quickly. When I am smart enough and check for ferry alerts before I get in my car, I do really appreciate that

57	Enhance connections & technology for easier trip	109
57	Enhance connections & technology for easier trip	110
58	Plan recommendations	111
59	Invest in tech	112
59	Invest in tech	113
61	Modernize fare collection	114

61	Modernize fare collection	Agree that auto length detect and autocoount of pax in vehicle would be two technologies to watch, and to participate in development/adaptation to ferry traffic.	115
62	Enhance mobility by improving ped, bike & transit connections	West Sound Bicycle Club has initiated a collaborative with WSF, City of Bremerton and Kitsap Transit to provide signage, lane marking and education to provide safer routes into and out from Bremerton ferries.	116
62	Enhance mobility by improving ped, bike & transit connections	Traffic control is definitely an are that needs improvement, and requires coordination agencies who place, on and synchronize traffic lights.	117
62	Enhance mobility by improving ped, bike & transit connections	What is missing? Partnering with local governments, communities and business to establish parking and safe, convenient drop off spots so that the expected increase in ridership will be walk-ons and not vehicles.	118
63	Plan recommendations	Add parking to 2 <sup>nd</sup> bullet.	119
64	Plan vessel and terminal spaces to be flexible	OK. What is already here is Car2Go. Requires a parking space, where you could step off ferry, walk to location and drive vehicle. After your trip, you return it to some allowed parking space, lock and walk to the ferry. These will continue to increase and may become a similar problem to the rental bikes, although they are not faring well economically. So the Plan needs to point out the parking for such rigs, like taxi waiting, bus stops, pick-up/drop-off areas need to be jointly planned by WSF, the cities and the service providers. Please work this into your bullet.	120
64	Plan vessel and terminal spaces to be flexible	OK. But autonomous vehicles will have to position themselves in a herd of non-autonomous vehicles, which will not talk with them. That leaves camera and infra-red positioning to center left to right and tuck up within 12 inches of vehicle in front. But if they all tuck in that tight occupants will have difficult exiting to use the main cabin and its comforts. So be cautious about amount of space gained.	121



	Agree with the strategy, but changing vehicle space to pax is not as simple as on an Air Force cargo plane. And changing pax space to vehicle space does not appear possible without such a complicated vessel it could be prohibitively expensive, costly to maintain and would waste a lot of space in ramps only used when pax space is opened up to vehicles and close off to rest of cabin, which would eliminate window seating. Sounds like a white elephant. On the other hand, making the main cabin so portions could be closed without loss of regular and emergency exit paths, is possible. As is a COI that lists one crew size and pax count for open and one for closed. Think you may want to focus on that. It adjusts the ratio, but not the max vehicle capacity.	122
64	Plan recommendations	
	Like the highlighted synopsis of the Plan approach – integrates ways to accommodate physical growth with AMS strategies. Nicely done!	123
65	Manage growth	
	Also like the highlighted dwell time factors that put service schedule and ridership growth in conflict. I see this on a regular basis as the Bainbridge vessel struggles to get loaded up and underway.	124
65	Manage growth	
	Text does a good job identifying local communities desires for pax to walk to and from ferry or take transit to not add vehicles on their roadways. WSF is working to help through encouraging mode shift and to ride off peak. Although WSF has not created peak and non peak fares.	125
65	Manage growth	
	With the transit agencies trying to reduce the number of fares charged, they are attempting to get back one price, any time, any distance, with monthly fares and senior fares reduced. WSF is already at that point, and now may not be the time to move in that direction.	126
65	Manage growth	

## F J Nelson Comments WSF Draft 2

20181025

		The two goals identified are to look at incentives for walk-ons and to offer vehicle discounts for off-peak. The second has no conflict with transit. The first is just keeping the cost of being a walk-on low so that it is attractive to walk at the other end (I walk a mile after I get off the ferry) as opposed to drive on (has to be something very special for me to take a vehicle into Seattle). So these strategies are very agreeable.	127
66	Manage growth	Like the highlighted Regional POV discussion. Partnering with them will shift some of the walk-on growth to them and ease the strain on the WSF ferries.	128
66	Manage growth		
67	Map reservations by route	Like the map showing current reservations and incremental approach being considered route by route with deliberate emphasis on not making travel difficult for commuters.	129
68	Plan recommendations	Like the balance among the three recommendations: Metrics for better decision-making data, Traditional AMS, and modest service hour and physical capacity increases. Very Good!	130
68	Refine existing & define new metrics	Current LOS metric for vehicles is only. Tier 1 and 2 triggers covered.	131
69	Plan recommendations	Establish pax LOS. Tier 1 seated capacity of vessel. Tier 2 max vessel pax capacity on USCG COI. "Tier 1 is alert to WSF that customer experience is degrading and that action will be needed in near future" is better description. Tier 2 requires increasing svc hours, adding staff or lifeboats, or alteration of vessel to expand cabin capacity (which would require a new COI that would require additional staff). Suggest you put in this order, increasing cost and difficulty, and include note about new COI and staff.	132

## F J Nelson Comments WSF Draft 2

20181025

70	Plan recommendations	Adjust Tier 1 to number of vehicles reservations possible for vessel, down from number of vehicle positions on vessel for routes with reservations. No change rest. Establish vehicle wait time as a performance metric. Yes! Agree with descriptions.	133
70	Maximize system utilization thru AMS	WSF should look to AMS first, but as noted in the text move on to modification of vessels when second tier is reached. OK.	134
71	AMS Toolbox	Graphic nicely sums up areas AMS methods WSF has chosen to use.	135
72	Expand vehicle reservations	Highlight identifies 3 criteria for selection of a route for reservations.	136
72	Edmonds/Kingston	Criteria 1: forecast demand puts at tier 1 in 2030 Criteria 2: Meets on-time requirement except summer Criteria 3: Needs increased vehicle holding space	137
72	Mukilteo/Clinton	Will meet all 3 when Mukilteo terminal opens in 2020 Lane configurations make reservations difficult. Needs increased vehicle holding at Clinton and reconfiguration of long queuing lanes at Mukilteo. This will be extremely difficult to do and will yield little benefit. Better off working with Boeing for shuttle service.	138
73	Lopez and Shaw	As only terminals not offering eastbound reservations, San Juans' reservation system would be complete with their addition. Requires increased vehicle holding. As an addition to an existing system, logical and should not be difficult. However there are still issues with the way the current system was modified after it was put in place. Those issues will have to be worked out to gain acceptance.	139

## F J Nelson Comments WSF Draft 2

20181025

73	Seattle/Bainbridge	Does not meet criteria but might be worth considering for summer and holiday weekends. Like Bremerton below, will have to sell to those who drive to weekend ball games, a higher percentage than Bremerton.	140
73	Seattle/Bremerton	Like Bainbridge does not meet criteria, but could be considered for summer and holiday weekends. Maybe. Only time I could not get on board as a walk-on was the Seattle Seahawks Superbowl Parade. I would just avoid going to Seattle on weekends. Commuters may not care, so those you need to convince are those going to weekend sporting events.	141
73	Triangle route	Does not meet any of the criteria. Need vessel reliability, terminal/ticker booth and operational changes before reservations could work on this route. Possible consideration post 2030. Eastbound maybe. Fauntleroy looks just plain impossible.	142
74	Fare structure	Simplifying the fare structure to eliminate non-driver fares could have an unexpected effect – a reverse shift from walk-on to drive-on. Instead of four adult fares there would be two vehicle fares. Currently not a great difference. So a significant drop in pax fare or significant increase in vehicle fare may be needed to prevent this. Which will be controversial and may have to be done after the effect is realized, i.e. revenue lost.	143
74	Fare structure	As a retiree, I could easily shift my times to non-peak, however you define it. Many do not have this luxury, as their employer sets expected core time they must be present, which would be what you would end up calling non peak. So no change. Some routes which are neither commuter nor commercial might benefit, but that narrows down to a small number of vehicles. You can model the effects, but I think you need to try it on a target route, see what happens – which groups shifted, which did not, and what was the impact in revenue. Then modify your model based on this and relook at other routes.	144

- 75 2<sup>nd</sup> ¶ covers two key points well. Service hour enhancements are return to pre I-695 hours, and work within crew work windows and existing capacity enhancements schedule. The new vessels can provide enhanced capacity. 145
- 75 Agree that until vessels are built so that 12 weeks of maintenance can be performed as the norm, extended service hours will not be possible. If two planned events occur: 1. the recommended construction is executed through the existing Olympic contract and 2. The 12 weeks per year standard is approved, along with the budget to perform the work, then some service hours could be increased by 2020. And more by 2030. 146
- 75 Enhanced capacity was brought up in comments 80 and 81, making the New 144-Car ferry actually hull and deck sized for 150 or 152, and the New 124-Car ferry 130. It is less costly to build in the enhanced capacity at new construction time and pricing than much later as a retrofit, even if it coincides with a midlife overhaul. That would be a logical Plan B. 147
- 75 Note that the highlighted comment on capacity only refers to pax. This is logical. However as noted above could be done in advance. The 144 and 124 car sizes are left over from the 1970-1980 period, and have not been updated in 40 years, where as WSDOT and FHWA have increased the lanes on the majority of replacement bridges built since the 1950s. The 2009 Plan was partially released from the no build directive from the legislature through efforts to educate the Legislature. This Plan is freer yet, but logic holds that you attempt AMS wherever practical and non-damaging. A 5% increase in deck space is not a de minimis cost, as 5% applied to two classes of vessels adds up. 148



## F J Nelson Comments WSF Draft 2

20181025

Six factors at least:

1. Need two slips.
  2. Vehicle holding capacity and configuration
  3. Loading vehicles simultaneously or separately
  4. Others such as ped activity, exit lanes, traffic signals
  5. Ticket booth procedures and staffing
  6. Dealing with reservations vs non-reservations
- The last two need to be added.

Terminal operational  
efficiencies

149

76

Ridership is expected to increase significantly to 2040. Most, but not all in walk-on and bicycle.

Recommendation for 1800 vice current 1500 is needed.

Recommendation to encourage mode shift at Bremerton terminal after Colman Dock may offer a small increase. Most walk-ons arrive by bus which drops then off within few feet of the loading ramp and within 5 to 20 minutes of sailing. Only problem is for those living outside of Kitsap Transit service routes.

Bremerton

150

76

Walk-on and bicycle expected to grow at high rate by 2040. Vehicle traffic clogs up SR305 slowing access to and from terminal.

Recommendation to increase pax to 2400 is needed!

Will need to be incorporated in midlife overhaul/hybrid propulsion project. Recommendation to replace overhead loading needed!

Bainbridge also has a high vehicle count, which will attempt to increase.

Bainbridge

151

77

Both will meet or exceed vessel COI pax capacity.

Pax LOS is required.

Chart is interesting, but driver plus pass does not make sense. 144 cars with 4 occupants is 576. 202 with 4 is 808. So triangle should be below

Bremerton &amp; Bainbridge

152

77

500 for each. Why are they connected?

	<p>Fauntleroy has less than one 124 car vessel's holding space, a single slip, no overhead loading and horrible traffic control. Southworth has a single slip and no overhead loading, but does have adequate holding space. Vashon has two slips but no overhead loading, and inadequate holding space.                  Recommendations for service hours, capacity and terminal efficiency are valid. The Southworth work should be identified as programmed or planned.</p>	153
78	<p>Triangle route                  Vehicle demand expected to reach tier 1 in 2030.                  Also high rate of commercial truck, expected to rise.                  Scenario A: increase service freq to 30 min between ferries from 45 min. Replace 2 ferries with 3 144 car. Examine options to increase holding capacity                  Scenario B: maintain existing service frequency. Replace ferries with new 202 car. Same effort Edmonds.                  Agree with scenarios. Agree decision needed nlt 2025.                  Should be joint decision two cities, FAC, Kitsap Cty, WSF                  Capacity: replace 124 car Issaquah class with 144 car Olympic by 2019 for summer season and by 2035 all.                  Terminal: Overhead loading for Clinton, examine options for holding space.                  Recommendations ok.                  Has reservations, but has still tripped tier 1 trigger.                  Projected to reach tier 2 in 2040.                  Service: Add 1 daily rt in summer. When relief vessels delivered, add 4 additional daily rt. 2 boats in spring.                  Look for holding space both PT and Keystone.                  Agree with recommendations.</p>	154
79	Kingston	154
80	Mukilteo/Clinton	155
80	Port Townsend	156

## F J Nelson Comments WSF Draft 2

20181025

		<p>Long routes, varying between 50 and 75 min each dir.          Multiple stops, complex load/off load at each, difficult queuing and poor holding capacity at Fri Harbor, so on-time performance is low.          Service enhancements: extend summer into May &amp; Oct.          Restore interisland in winter.          Go to simplified 2 season schedule from 4, easier transit          Capacity: New 114-Car variant fm 144 for interisland</p>	
		<p>Terminal: New terminal at Anacortes – Should have been mentioned earlier!</p>	
		<p>Overhead loading and second slip at Friday Harbor. Expand vehicle holding Lopez.</p>	
81	Anacortes/San Juans	<p>Recommendations ok but add Anacortes back in Terminals and define whether planning action or programming.</p>	157
		<p>Summer only. International run          Service: Expand summer to May and Oct.          Terminal efficiency: relocate all customs to Sidney          Capacity is missing. Will get new SOLAS 144-Car vessel. No more cars.          Will have 1800 pax capacity with SOLAS should be a slight benefit. Will also get new 124-Car SOLAS if people do not forget Chelan is SOLAS          Can agree with modified recommendations.</p>	158
		<p>Highlighted subtitle needs to be changed from “maintain” to “achieve” reliable service. Not reliable now.          Goals do relate to mission in a secondary way: environmental stewardship and survive emergencies and climate change. Not as direct or powerful as operate, maintain, design and construct vessels and terminals to provide the level of reliable service the public expects of us while minimizing our impact on the environment by using the least amount of nonrenewable material and least amount of energy and causing no harm to flora and fauna that share our Puget Sound with us.</p>	159
<b>6 Sustain &amp; Resilient</b>	Invest in infrastructure		159
	Plan recommendations	The 4 recommendations are ok.	160

## F J Nelson Comments WSF Draft 2

20181025

85	Highlight sustainability through organization	<p>A position or a department could guide and educate decision making staff to engrain the concept of environmental stewardship and sustainability within them and their own staff pays off well. Dreaming up sustainability initiatives and projects, not so much.</p> <p>Terminal operational efficiencies can reduce the wait times with engines running.</p> <p>The 5 recommended strategies are all valid. The second, improve traffic at terminals, where WSF is a customer, requires collaboration to achieve results, which WSF can and does do.</p>	161
86	Reduce vehicle emissions	<p>The three strategies are valid. There is a theme unfolding here. Actions which remove or reduce vehicle usage contribute to sustainability. But there is a flaw here. This points to WSF becoming a statewide passenger only ferry system. The marine highways are in fact highways, not sidewalks. Like other highways they share the road between vehicles, bikes and transit – only the ferry vessels that are the moving highway that carries vehicles are the transit vehicle themselves. WSF needs to make the marine highway sustainable, which does include minimizing the fuel the vessels use minimizing the fuel consumed by vehicles waiting to get on board or waiting to get off because of traffic problems near the terminal. So as long these recommendations stay framed in that environment, great.</p>	162
87	Promote mode shift	<p>This gets to the real matter of sustainability. Can the fleet achieve sustainability? Electric hybrid propulsion will definitely help. With the 2040 fleet 22 hybrids and 4 diesels, that is a significant change. Reaching the 2050 goal to have reduced carbon dioxide emissions 57.5% by the 2030's will demonstrate that WSF is serious about environmental stewardship. The four strategies presented for vessels are valid.</p>	163
89	Design vessels and terminals	<p>These four strategies are valid.</p>	164
90	Design vessels and terminals	<p>These four strategies are valid.</p>	165

## F J Nelson Comments WSF Draft 2

20181025

91	Resilience	<p>The three Plan recommendations are good. It is not clear that the recommendation to increase the number of relief vessels was considered in the establishment of the 2040 fleet. I would think, even if not, compared to what is available now, the system could definitely play a significant part in a regional emergency response.</p> <p>Strategies are good. You might want to note that second and third factor significantly into the first. Fourth should play into electrification plans, where some redundancy could be built into each or at least one terminal per route.</p>	166
92	Emergency response plan	<p>Fifth strategy, plan for disruptive events, may well be available within WSDOT. Emergency contracting procedures exist, which could be utilized here. But the identification of what could go wrong, terminal by terminal, and the likely problems with getting staff, temporary utilities, and other resources while the local agency and businesses are dealing with their similar problems will be unique to each site. Their are likely local agreements in place. The Washington State Office of Emergency Management can help.</p>	167
93	Emergency response plan	<p>1st ¶ good synopsis. 2nd ¶ needs an "a" before "major highway". No interstate is sole access to a population or facility, but some major highways are. Working with local agencies to determine how to maintain life lines from I-5 to terminals is good, but you are writing off west sound communities. Not so good. Need to include SR 3, SR 305, SR 16 and the complex of state routes that get from Kingston, Pt Townsend, and Hood Canal Bridge if tsunami devastated waterfront within the Sound. Recommendations are ok. Although recommend you include water, power and communications alternate sources along with coastal design standards to increase resiliency.</p>	168
93	Prioritize terminal risk maintenance & upgrades	<p>Recommendation ok. Clears up question of whether number of relief vessels included emergency response. Good.</p>	169
94	Plan recommendations	<p>Recommendation ok. Clears up question of whether number of relief vessels included emergency response. Good.</p>	170
94	Increase relief vessels	<p>Recommendation ok. Clears up question of whether number of relief vessels included emergency response. Good.</p>	171

## F J Nelson Comments WSF Draft 2

20181025

7	<b>Implement &amp; Invest</b>	95	Implementation, investments and financial outlook	1 <sup>st</sup> sentence needs to be stronger. A step up would be to remove “will” and replace “broad” with “strong”. You might also add “starting immediately” at the end.	172
		95	Implementation, investments and financial outlook	You should consider removing “will: almost universally in this section, as it softens and makes less certain of what you are trying to communicate.	173
		95	Implementation, investments and financial outlook	Last ¶ Recommend “The Plan invests heavily through 2017 in fixing” the reliability of the system through ...	174
		96	Implementation, investments and financial outlook	Very god. “will achieve” appropriate as a future action. Gutsy, but necessary, to be “unconstrained to current, known (and crippling inadequate) revenue sources.”	175
		96	Implementation, investments and financial outlook	Use of near, medium and long term goals with time frames and titles, and as bold bullets gets attention. But the 0-2 year Near term DOES NOT stabilize the fleet. You either need to provide a name that correctly describes what it is doing or redefine the near term to 0-5 or 0-7 or the completion of delivery of at least the first two Olympics. The latter is better, but not in line with use of time frames. And it would be most correct with what you define under midterm: the 5 Olympics and the 1 <sup>st</sup> New 124-Car ferry, which replace the highest maintenance vessels make the relief fleet grow by at least 3 vessels.	176
		97	2040 Plan implementation chart	Still struggle with the chart. Like the four themes to break it up horizontally. The background triple gradation does not help. You said that up to 2027 you are stabilizing, which define as a short term immediate goal and also building infrastructure, medium term. Yet for 0-2 years you are converting the Mark IIs to hybrid. Then for 3 years you are building 5 Olympics. The chart does not agree with your definitions on previous page. This is FATAL.	177



## F J Nelson Comments WSF Draft 2

20181025

	<p>The chart shows 3 years to deliver 5 Olympics. Based on current contract, and assuming no competitive work, it would take 7-8 years for the contract to deliver 5. With a heavy workload and having to keep aluminum and steel work separate, and having to rebuild the ferry fabrication team, low probability of even 8 years.</p> <p>You need to look at figuring out how to do hybrid conversion and construct 5 Olympics simultaneously or</p> <p>Redefining the short term as first step hybridization and medium term as stabilizing the fleet, which removes the urgency for executing this plan..This would likely be FATAL.</p>	178
97	2040 Plan implementation chart	
	<p>A way to fix this is to provide a line for Hybrid Conversion. You in effect have it, with the Kwa-di Tabil ferries being converted during the New 144-Car (and New Mark IIs if so decided) It is taken up at the left side by the two lines for decision Milestone on Olympics. Make the chart deeper, provide space below bullet, move up Mark II and in the vacated space, extend the Olympic Class over to under the N in the bullet.</p> <p>Then you can add the remaining two Mark IIs, which are not on the chart to a block above the New 124-Cars. All hybridization of existing will be on one line.</p>	179
97	2040 Plan implementation chart	
	<p>Vessel retirements. With above, strongly you suggest you keep the Hyak in the plan, up through delivery of first Olympic. Not everyone's favorite but does deliver on central sound which Tillikum cannot.</p> <p>Also, need to link Elwha's retirement to first SOLAS delivered, either from Olympic contract, where two SOLAS required per Anacortes/San Juan Route Plan implementation p 108. The second is to replace the Chelan, per p108.</p>	180
97	2040 Plan implementation chart	
	<p>Fix chart to agree with this. Also, keep Hyak as reserve vessel. Works on Bremerton and Vashon, Tillikum does not.</p>	181
98	Near term vessels	

## F J Nelson Comments WSF Draft 2

20181025

100	medium term	Vessels describe the work that actually stabilizes the fleet. It also shows that two of the Mark II hybridization conversions are missing from the chart. See comment 179. Fixing the chart requires fixing the smaller version in the Exec Summary, obviously,	182
100	medium term	Terminals: Good.	183
101	medium term	Last sentence pretty much defines reaching stability. You need to fix the time frames or this Plan is in big trouble.	184
102	long term	OK.	185
104	Route Bremerton	NO. Kaleetan should be replaced with hybrid and put in maintenance relief. Bremerton supers burn diesel in the longest run except Sidney. Modify both 144s to make 1800 pax in 2028. Then replace diesel Olympic with hybrid in long term action. Make sure it is 1800 pax.	186
105	Route Bainbridge	OK. OK. Run down for 124-car Hybrids	187
		1 Triangle Med Term	
		2 Triangle Long Term	
		3 Total 124s per route plan	
		1 Mukilteo replaced by 144 Current Oly	
		1 Sidney replaced by 144 Med Term	
		1 InterIsland Sealth by 114 Long Term	
105	Route Triangle	3 124s replaced by 144 ( or 90 by 114)	188
106	Route Pt Defiance	OK.	189

## F J Nelson Comments WSF Draft 2

20181025

106	Route Kingston	If you invest in the conversion of the Puyallup, you will run into difficulty if you decide to replace it with a new vessel, or keep it as a spare for Bainbridge. You may want to either push the decision, delay the hybridization, or prepare a plan for what to do if you are constrained to buy only one new 202 car hybrid for this route.	190
107	Route Mukilteo	OK.	191
108	Route Port Townsend	OK.	192
108	Route Anacortes	Confirms two of the 5 Olympic extension are SOLAS hybrid electric. Good. That helps stabilize the fleet.	193
		Gets 2 New 144-Car ferries. Route run down for 144 Hybrids	
		1 Bremerton Med Term 1 Bremerton Long term 3 Kingston Long Term 2 Mukilteo Long Term 2 Sidney (1 replaces a 124) Med Term 2 Anacortes Long Term	
		11 Total 144s per route plan	
		1 Interisland (144 car derived) Long Term (chart includes w lng term 144)	194
109	Route Anacortes		
111	2040 Financial Capital Program Costs	Near term as defined here, does not include stabilize the fleet as its title, nor does it state any vessel actions other than M/V Tacoma hybridization. Medium term does describe the extension of the Olympic contract and 4 vessels and the first of the 124 car contract.	195

	Fleet at end of 2040 Plan	
	5 144-car hybrid 2 SOLAS Olympic Med Term	
	6 144-car hybrid Long Term	
	1 124-car hybrid Med Term	
	4 124-car hybrid Long Term	
	1 114-car hybrid (144 based) Long Term	
	2 Mark II hybrid Med Term	
	3 64-car hybrid Long Term	
	4 144-car diesel Orig Oly	
	26 Total Fleet per Financial Plan includes Kingstn	
	4 144-car diesel in reserve	
	2 124-car hybrid in reserve	
112	2040 Financial Capital Program Costs	196
115	2040 Financial Capital Program Costs	197
121	Fuel/energy savings	198
122	Operating revenue.	199
124	Financial Overview	200

Overall ok. A lot of topics to draw on for conclusions. What is misses, though is very telling.

This Plan is attempting to correct several decades on significantly insufficient capital investment in maintaining and replacing assets, and make the marine highways once again as well kept as the rest of Washington State's highway system.

This Plan is the road map to do just that.

201

Conclusion

125

8

- App A**      **2009 Plan Summary**
- App B**      **Final LRP Scope**
- App C**      **Community Engage**
- App D**      **Spring Engage Sum**
- App E**      **Ridership Forecast**
- App F**      **Financial**
- App G**      **References**

This appendix is missing. Many excellent statements have been made about increasing costs and reliability issues. But having the data which confirms the condition we see, available to review, adequately organized, goes a long way to making the case that vessels have passed the “knee” in cost records and are increasing at an unsustainable rate. Such records facilitate the “fix or replace” decision, which when capital funds are required are beyond the ability of the maintenance form to make such as decision.

**APP H**      **Vessel Maint Costs**      202

A Plan such as this must provide such data to ensure it is adopted.