



**Washington State
Department of Transportation**

Washington State Bridge Inspection Manual

M 36-64.06

December 2015

Bridge Preservation Office/Local Programs

Americans with Disabilities Act (ADA) Information

Materials can be made available in an alternate format by emailing the WSDOT Diversity/ADA Compliance Team at wsdotada@wsdot.wa.gov or by calling toll free, 855-362-4ADA (4232). Persons who are deaf or hard of hearing may make a request by calling the Washington State Relay at 711.

Title VI Notice to the Public

It is Washington State Department of Transportation (WSDOT) policy to ensure no person shall, on the grounds of race, color, national origin, or sex, as provided by Title VI of the Civil Rights Act of 1964, be excluded from participation in, be denied the benefits of, or be otherwise discriminated against under any of its federally funded programs and activities. Any person who believes his/her Title VI protection has been violated may file a complaint with WSDOT's Office of Equal Opportunity (OEO). For Title VI complaint forms and advice, please contact OEO's Title VI Coordinator at 360-705-7082 or 509-324-6018.

To get the latest information on WSDOT publications, sign up for individual email updates at www.wsdot.wa.gov/publications/manuals.

Washington State Department of Transportation
Bridge Preservation Office
PO Box 47340
Olympia, WA 98504-7340
www.wsdot.wa.gov/eesc/bridge/

Foreword

The *Washington State Bridge Inspection Manual* (WSBIM) is published jointly by the Bridge and Structures and the Local Programs offices of the Washington State Department of Transportation (WSDOT). This manual is the primary source of information and guidance for those who inspect bridges subject to the National Bridge Inspection Standards (NBIS) managed by state and local agencies within Washington State.

This publication is the official source for all information relevant to Washington State's compliance with the NBIS, the National Bridge Inventory, and the Washington State Bridge Inventory. It is also the official source of information for the inspection of bridges and selected structures on state right of way that are not subject to the NBIS, and for the recordkeeping requirements for these bridges and selected structures in the Washington State Bridge Inventory.

The WSBIM is managed by the Bridge Inspection Committee composed of individuals listed in this document. Suggestions for improvement and updating the manual are always welcome. All questions and comments regarding this manual will be reviewed by this committee and incorporated into subsequent revisions as appropriate.

Approved:

Approved:

Harvey Coffman, P.E, S.E.
WSDOT Bridge Preservation Engineer/
Statewide Program Manager

Debbie Lehmann, P.E.
FHWA Washington Division Bridge Engineer

Bridge Inspection Committee Members

Roman Peralta, Co-Chair, P.E.
Local Programs Bridge Engineer
WSDOT Local Programs
PO Box 47390
Olympia, WA 98504-7390
peraltr@wsdot.wa.gov
360-705-7870

Jody Bywater, P.E.
Quality Assurance Engineer
WSDOT Bridge Preservation
PO Box 47341
Olympia, WA 98504-7341
bywaterj@wsdot.wa.gov
360-570-2530

George Comstock P.E.
Coding & Appraisal Engineer
WSDOT Bridge Preservation
PO Box 47341
Olympia, WA 98504-7341
comstog@wsdot.wa.gov
360-570-2540

Glen Scroggins, Co-Chair, P.E., S.E.
Bridge Preservation Supervisor
WSDOT Bridge Preservation
PO Box 47341
Olympia, WA 98504-7341
scroggg@wsdot.wa.gov
360-570-2557

Bruce Thill, P.E.
Bridge Asset Manager
WSDOT Bridge and Structures
PO Box 47340
Olympia, WA 98504-7340
thillb@wsdot.wa.gov
360-705-7393

Debbie Lehmann, P.E.
WA Division Bridge Engineer
FHWA
711 South Capitol Way
Olympia, WA 98501
debbie.lehmann@dot.gov
360-753-9482

WSBIM Contributors

Mohamad Al-Salman, P.E.
Heath Bright
Dave Bruce, P.E.
David Churchill, P.E.
Spencer Hand
Barbara Johnstone
Dan McCarthy
Duane Stone, P.E.
Larry Veden
Craig Yasuda, P.E.

Comment Request Form

Date: _____

From: _____

Phone: _____

Email: _____

To: Bridge Preservation Engineer
Washington State Department of Transportation
PO Box 47340
Olympia, WA 98504-7340

Subject: *Bridge Inspection Manual* Comment

Recommendation for Improvement:

Chapter 1	Bridge Inspection Organization Requirements	1-1
1.01	General	1-1
1.02	Description of Bridge Inspection Organization	1-4
1.03	Bridge Inspection Programs	1-5
1.04	Bridge Inspection Organization Roles and Responsibilities	1-6
1.05	Bridge Inspection Certification	1-7
1.06	Bridge Inspection Certification Probation, Suspension, Decertification and Reinstatement	1-9
1.07	Appendices	1-10
Appendix 1.07-A	WSDOT Bridge Inspector Experience and Training Record Form	1.07-A-1
Appendix 1.07-B	Continuing Education Course List	1.07-B-1
Appendix 1.07-C	SPM Delegation Letter	1.07-C-1
Appendix 1.07-D	DPM Delegation Letter	1.07-D-1
Chapter 2	Bridge Files and Documentation	2-1
2.01	General	2-1
2.02	Maintaining Bridge Files and Documentation	2-2
2.03	Maintaining a State Bridge Inventory – WSBIS	2-5
2.04	FHWA Data Submittal Process	2-12
2.05	Responding to FHWA	2-13
2.06	Appendices	2-15
Appendix 2.06-A	WSDOT BPO Floor Plan with File Locations	2.06-A-1
Appendix 2.06-B	Record Change Form	2.06-B-1
Appendix 2.06-C	Washington State Bridge Inventory System Coding Guide	2.06-C-1
Appendix 2.06-D	Local Agency Bridge Inventory Coding Guide	2.06-D-1
Appendix 2.06-E	WSDOT BMS to NBE Translation	2.06-E-1
Appendix 2.06-F	Border Bridge Information	2.06-F-1
Appendix 2.06-G	Sufficiency Rating Calculation	2.06-G-1
Appendix 2.06-H	WSDOT/FHWA Communication Protocol Flowchart	2.06-H-1

Chapter 3	Inspections and Reports	3-1
3.01	General	3-1
3.02	Inspection Types and Reporting	3-1
3.03	Bridge Inspection Orientation	3-29
3.04	Policy and Procedures	3-33
3.05	Forms	3-43
3.06	Appendices	3-95
Appendix 3.06-A1	Bridge With Fill on Deck	3.06-A1-1
Appendix 3.06-A2	Bridge With No Fill on Deck	3.06-A2-1
Appendix 3.06-A3	Culvert With Fill on Deck	3.06-A3-1
Appendix 3.06-B	UBIT Inspections and Procedures	3.06-B-1
Appendix 3.06-C	FHWA Letter for Routine Extended Frequency Inspections	3.06-C-1
Appendix 3.06-D	FHWA Letter for Bridge Special Feature Inspections ..	3.06-D-1
Chapter 4	WSDOT Bridge Elements	4-1
4.01	List of WSDOT Elements by Number	4-1
4.02	List of WSDOT Elements by Subject	4-4
4.1	Introduction	4-7
4.2	Bridge Decks	4-13
4.3	Superstructure	4-19
4.4	Substructure	4-41
4.5	Culverts	4-59
4.6	Tunnels	4-61
4.7	Sidewalk and Supports	4-62
4.8	Bearings	4-64
4.9	Bridge Approach	4-66
4.10	Bridge Rail	4-67
4.11	Pedestrian Rail	4-68
4.12	Smart Flags	4-69
4.13	Seismic Restrainers	4-72
4.14	Expansion Joint Elements	4-76
4.15	Movable Bridges	4-86
4.16	Other Bridge Elements	4-86
4.17	WSDOT Bridge Deck Overlay Elements	4-88
4.18	Protective Coatings	4-91

Chapter 5	Load Rating and Scour	5-1
5.01	General	5-1
5.02	Bridge Load Rating	5-1
5.03	Scour Evaluation	5-7
5.04	Appendices	5-15
Appendix 5.04-A	WSDOT Scour Summary Sheet Instructions	5.04-A-1
Appendix 5.04-B	WSDOT Plan of Action Template	5.06-B-1
Appendix 5.04-C	Instructions for Completing WSDOT Plan of Action	5.04-C-1
Appendix 5.04-D	FHWA Plan of Action Template	5.04-D-1
Appendix 5.04-E	Instructions for Completing FHWA Plan of Action	5.04-E-1
Chapter 6	Damage and Repairs	6-1
6.01	General	6-1
6.02	Critical Damage Bridge Repair Report (CDBRR)	6-1
6.03	Other Damage Reports	6-7
6.04	Bridge Repairs	6-8
6.05	Maintenance – Bridge Repair Report (MBRR)	6-16
6.06	Forms	6-17
Chapter 7	Quality Control/Quality Assurance	7-1
7.01	General	7-1
7.02	WSDOT Bridge Preservation Office Quality Control Program	7-3
7.03	Coding and Appraisal Unit	7-4
7.04	Risk Reduction Unit (Load Rating)	7-7
7.05	Risk Reduction Unit (Scour Group)	7-8
7.06	Regional and Special Structures Inspection Units	7-8
7.07	Underwater Inspection Unit	7-11
7.08	WSDOT Bridge Preservation Office Quality Assurance Program	7-11
7.09	WSDOT LP Quality Control/Quality Assurance Program	7-15
7.10	WSDOT LP Quality Control Program	7-15
7.11	WSDOT LP Quality Assurance Program	7-20
7.12	Appendices	7-23
Appendix 7.12-A	Bridge Letter File Contents for State Bridges	7.12-A-1
Appendix 7.12-B	Flowchart for Tracking New Bridges	7.12-B-1
Appendix 7.12-C	WSBIS Fields Maintained With Other WSDOT Database Source Information	7.12-C-1
Appendix 7.12-D	Bridge Preservation Office Lead Approval Criteria	7.12-D-1
Appendix 7.12-E	Bridge Preservation Office Quality Control Review Tracking Form	7.12-E-1

Appendix 7.12-F	Bridge Preservation Office Quality Control Report Review Tracking Form	7.12-F-1
Appendix 7.12-G	Bridge Preservation Office Quality Control Field Review Form.	7.12-G-1
Appendix 7.12-H	Bridge Preservation Office Quality Assurance Bridge Selection Process	7.12-H-1
Appendix 7.12-I	Bridge Preservation Office Field Review	7.12-I-1
Appendix 7.12-J	LP Quality Assurance Deficiencies.	7.12-J-1

Chapter 8	Electrical and Mechanical	8-1
8.01	General.	8-1
8.02	Description of Complex Bridges and Tunnels.	8-2
8.03	Inspections	8-3
8.04	Complex Bridge and Tunnel QC/QA Program	8-6
8.05	Tunnel Inspection Duties	8-7
8.06	Complex Bridge and Tunnel Records	8-7
8.07	Bridge Damage/Emergency Responsibilities.	8-8
8.08	Plans, Specifications and Estimates	8-8
8.09	Appendices.	8-9
Appendix 8.09-A	BPO Memo for Blue Ribbon Inspection Schedule Alteration.	8.09-A-1
Appendix 8.09-B	Guideline for Writing Electrical and Mechanical Inspection Reports	8.09-B-1
Appendix 8.09-C	Numerical Rating Condition Description	8.09-C-1
Appendix 8.09-D	Continued Certification of Complex Bridge Inspection Personnel	8.09-D-1
Appendix 8.09-E	Complex Bridge and Tunnel Inspection List	8.09-E-1
Appendix 8.09-F	Operations, Inspections, and Maintenance Manual List.	8.09-F-1

Purpose

The *Washington State Bridge Inspection Manual* (WSBIM) has been developed to provide specific guidance, offer needed technical details, and serve as an information source to both state and local agency staff related to and involved with bridge inspections within the state of Washington. The intent of this manual is to serve as an operations manual for the collection, processing and reporting of bridge inspection information.

The WSBIM is currently divided up into eight chapters. Chapters 1 – 3 explain the responsibilities within the bridge inspection organization, provide guidance to the structure of the Washington State Bridge Inventory System (WSBIS), and it further explains the types of inspections and the reports required to meet the federal mandate outlined in the Code of Federal Regulations. Chapter 4 describes the Washington State Bridge Management System (BMS) and defines the element level inspection used by both state and local agency bridge inspectors. Chapters 5 – 7 provide more detailed information to the inspector in regard to load ratings, scour, damage/repair reporting, and quality control/quality assurance. Chapter 8, currently written as a stand-alone chapter, is a new addition to the manual and covers the aspects of mechanical and electrical inspections of moveable structures.

References

Bridge inspection staff may also refer to the most current editions of the following:

- *Bridge Inspector's Reference Manual* (BIRM), Publication No. FHWA NHI 12-049
- *The Manual for Bridge Evaluation* (MBE), 2nd Edition, AASHTO
- *The Manual for Bridge Element Inspection*, 1st Edition, AASHTO
- *Evaluating Scour at Bridges*, Hydraulic Engineering Circular (HEC) No. 18, 5th Edition, FHWA
- *Stream Stability at Highway Structures*, Hydraulic Engineering Circular (HEC) No. 20, 4th Edition, FHWA
- *Bridge scour and stream instability countermeasures*, Hydraulic Engineering Circular No. 23, 3rd Edition, FHWA
- Title 23 CFR 650 Subchapter C – National Bridge Inspection Standards
- Title 23 CFR 500 Subchapter F – Transportation Infrastructure Officials
- *Recording and Coding Guide for the Structure Inventory and Appraisal of the Nation's Bridges*, Report No. FHWA-PD-96-001, December 1995, FHWA available at www.fhwa.dot.gov/bridge/mtguide.pdf.

- *Transportation Engineering Technology Highway Design – Program Detail Manual*, 5th Edition, NICET (Requirements for NICET certification) available at www.nicet.org/default/assets/File/hwydes.pdf.
- *Bridge Design Manual (BDM) M 23-50*, WSDOT
- *Transportation Structures Preservation Manual M 23-11*, WSDOT
- *Local Agency Guidelines (LAG) M 36-63*, WSDOT
- *Bridge List M 23-09*, WSDOT
- *Moveable Bridge Inspection, Evaluation, and Maintenance Manual*, 1st Edition, AASHTO
- *Dive Safety Manual*, WSDOT (currently an internal BPO Manual)

Revisions

The WSBIM is a dynamic document that is updated periodically to incorporate revisions based on new requirements from the Federal Highway Administration (FHWA), as well as newly adopted practices by either state or local agencies within the state. We encourage the user to submit to the Bridge Inspection Committee any proposed revisions or new material, by using the Comment Request Form provided.

In the event of conflicting information or requirements between the WSBIM and NBIS, the NBIS will govern. Agencies are not relieved of the responsibility of complying with the NBIS even when a conflict exists. If a conflict is discovered, notify the WSDOT Bridge Preservation Supervisor or the Local Agency Bridge Engineer.

Chapter 1 Bridge Inspection Organization Requirements

1.01 General

The National Bridge Inspection Standards (NBIS) are published in the Code of Federal Regulations, 23 CFR 650, Subpart C. The NBIS sets the national standard for the proper safety inspection and evaluation of bridges and it applies to all structures defined as reportable structures located on all public roads. Washington State's bridge inspection organization is required to meet the NBIS and functions under the authority of the Federal Highway Administration (FHWA) and state law.

Washington State's bridge inspection organization, however, is only responsible for state and local agency-owned bridges. Federally-owned bridges are inventoried and managed by federal agencies. Privately-owned highway bridges are not included in this requirement, although WSDOT encourages private bridge owners to inspect and maintain their bridges in conformance with the NBIS and this manual. There is an open invitation for private bridge owners to submit bridge records to the Washington State Bridge Inventory System (WSBIS).

A. Definitions

BEIS – Bridge Engineering Information System. The WSDOT internal website that holds electronic bridge files.

Bridge – See definition of Reportable Structure below.

BridgeWorks – The software application that is used to record, process and report bridge inspections and which updates data in the inventory databases.

Bridge Condition Inspection Training (BCIT) – A comprehensive ten day training course offered by WSDOT based on the 2012 FHWA “*Bridge Inspectors Reference Manual (BIRM)*”. The BCIT is an FHWA accepted equivalent to the course offered by the National Highway Institute (NHI), entitled “Safety Inspection of In-Service Bridges” with a course code of FHWA-NHI-130055.

Bridge File – A file containing historic and current information about a bridge, and meeting the intent of Chapter 2 of the *AASHTO Manual for Bridge Evaluation*.

Bridge Inspection – The act to assess the structural condition and collect pertinent data while on site of in-service bridges.

Bridge Inspection Certification – A process by which a Program manager, Team Leader and Underwater Bridge Inspection Diver is certified in the state of Washington to perform bridge inspections. See Section 1.05.

Bridge Inspection Committee (BIC) – A committee of state and local agency representatives that provides overall advisory input to the bridge inspection manual content and organization within the state of Washington. The current list of committee members is located within the Foreword of this manual.

Bridge Inspection Organization – See Section 1.02

Bridge Inspection Program – An organizational unit that functions as part of the Bridge Inspection Organization and that meets the requirements of 23 CFR 650.307 and this manual. Agencies involved with the Bridge Inspection Program are led by delegated program managers, who work in coordination with the Statewide Program Manager.

Bridge Inspection Refresher Training (BIRT) – A training course designed to refresh the skills of practicing bridge inspectors. The course is offered by the National Highway Institute (NHI). The course code is FHWA-NHI-130053.

Bridge Preservation Office Bridge Inventory – The inventory of state bridges kept in the BPO database. The Bridge Reporting Database draws data from this database regularly for inclusion into WSBIS.

Bridge Reporting Database (BRD) – The database which stores the Washington State Bridge Inventory System (WSBIS) data, combining data from the Bridge Preservation Office (BPO) and Local Programs (LP) databases.

Critical Finding – The NBIS gives the following definition: “A structural or safety related deficiency that requires immediate follow-up inspection or action.” This is also known as “critical damage” in the state of Washington.

Culvert – A curved or rectangular buried conduit for conveyance of water, vehicles, utilities, pedestrians or animals.

Delegated Program Manager (DPM) – See Section 1.04.B

Fracture Critical Member – A steel load path member in tension, or with a tension element, whose failure would probably cause a portion of or the entire bridge to collapse.

Highway LID – A structure built with green space which interconnects neighborhoods otherwise cut off or impacted by freeways, with or without local roads. If carrying local roads, the structure must have a deck area at least twice the area of the roads it carries. Highway “LIDS” shall be inventoried as tunnels under the NTIS.

Local Programs Bridge Inventory – The inventory of local agency bridges kept in the LP database. The Bridge Reporting Database draws data from this database regularly for inclusion into the Washington State Bridge Inventory System (WSBIS).

Inventory Record – Data which has been coded according to this manual for each structure carrying public road traffic and/or for each inventory route which goes under a structure.

Inventory Route – The route for which the applicable inventory data is to be recorded. The inventory route may be on the structure or under the structure. Generally inventories along a route are made from west to east and south to north.

Local Agency – Generally refers to city or county bridge owners but also includes all bridge owners other than state and federal.

National Bridge Inspection Standards (NBIS) – Title 23 Code of Federal Regulations 650 Subpart C defines the NBIS regulations, and establishes requirements for inspection procedures, frequency of inspections, qualifications of personnel, inspection reports, and preparation and maintenance of a state bridge inventory. The NBIS apply to all structures defined as bridges located on all public roads.

National Bridge Inventory (NBI) – The aggregation of structure inventory and appraisal data collected nationally to fulfill the requirements of the National Bridge Inspection Standards. The state of Washington shall prepare and maintain an inventory of all bridges subject to the NBIS.

National Tunnel Inspection Standards (NTIS) – Title 23 Code of Federal Regulations 650 Subpart E defines the NTIS regulations, and establishes requirements for inspection procedures, frequency of inspections, qualifications of personnel, inspection reports, and preparation and maintenance of a state tunnel inventory. The NTIS apply to all structures defined as highway tunnels located on all public roads.

Public Road – Any road under the jurisdiction of and maintained by a public authority and open to public travel.

Reportable Structure – The NBIS gives the following definition: “A structure including supports erected over a depression or an obstruction, such as water, highway, or railway, and having a track or passageway for carrying traffic or other moving loads, and having an opening measured along the center of the roadway of more than 20 feet between undercopings of abutments or spring lines of arches, or extreme ends of openings for multiple boxes; it may also include multiple pipes, where the clear distance between openings is less than half of the smaller contiguous opening.”

The State – The Washington State Department of Transportation (WSDOT).

Statewide Program Manager (SPM) – See Section 1.04.A

Tunnel – The term “tunnel” means an enclosed roadway for motor vehicle traffic with vehicle access limited to portals, regardless of type of structure or method of construction, that requires, based on the owner’s determination, special design considerations that may include lighting, ventilation, fire protection systems, and emergency egress capacity. The term “tunnel” does not include bridges or culverts inspected under the National Bridge Inspection Standards (Title 23 Code of Federal Regulations 650 Subpart C). The state of Washington shall prepare and maintain an inventory of all tunnels subject to the NTIS.

Washington State Bridge Inventory System (WSBIS) – The aggregation of structure inventory, and appraisal data collected and used to fulfill the requirements of the NBIS and additional data used to manage the state and local bridge inventories. This data is stored in the Bridge Reporting Database.

1.02 Description of Bridge Inspection Organization

In Washington State, the bridge inspection organization is structured as a collaborative effort between the Washington State Department of Transportation (WSDOT) Bridge Preservation Office (BPO), WSDOT Local Programs Office (LP), and local agency bridge owners with the Federal Highway Administration (FHWA) as a primary stakeholder. Collectively, all state and local agency owned bridges subject to the NBIS are managed under this organization. The inspection organization is led by the State Bridge Preservation Engineer (who serves as the Statewide Program Manager) and is advised by the Bridge Inspection Committee.

The bridge inspection organization has the following responsibilities:

- Establishing an organizational structure within the state that clearly defines the roles and responsibilities of those agencies required to participate.
- Maintaining personnel qualification records and a certification program for program managers, team leaders, load raters and underwater bridge inspection divers.
- Performing regularly scheduled in-service bridge inspections. This includes, but is not limited to, routine (low/high risk), underwater (low/high risk) and fracture critical inspections.
- Establishing state specific load rating procedures and maintaining load ratings based on current conditions of all NBI reportable structures.
- Following MBE criteria for load posting/restricting bridges.
- Establishing and specifying written inspection procedures for:
 - Fracture Critical Bridge Members
 - Underwater Bridge Elements
 - Complex Bridge Features
- Performing scour evaluations for all bridges over water.
- Maintaining scour Plan of Action (POA) documents for all bridges documented to be vulnerable to scour.
- Establishing quality control and quality assurance procedures to maintain a high degree of accuracy and consistency within the inspection program.
- Responding to and reporting of significantly damaged bridges to the FHWA Washington Division Bridge Engineer.
- Maintaining an inventory of bridges for the entire state.
- Maintaining a bridge file (electronic and/or physical) for every bridge in the inventory.
- Maintaining National Bridge Inventory (NBI) data that follows the Federal Coding Guide criteria or can be translated into that system during the annual submittal of data.
- Maintaining Bridge Management System data that follows the National Bridge Element (NBE) condition assessment criteria or can be translated into that system during the annual submittal of data.

- Submitting required Washington bridge inventory data to FHWA for incorporation into the National Bridge Inventory (NBI)

The bridge inspection organization's activities also include the following which although are not explicitly required by the NBIS, but are either strongly implied or required by other FHWA policies:

- Responding to FHWA Technical Advisories, FHWA Action Memoranda, and other policy or information requirements provided by the FHWA Washington Division Bridge Engineer.

The bridge inspection organization is also responsible for the following activities which are clearly part of managing bridges but not required by the NBIS.

- Bridge repair management.
- Managing non-NBIS structures.

1.03 Bridge Inspection Programs

The composition and size of each bridge inspection program varies widely, generally depending on the number of bridges managed by each agency. Two state offices play key roles in the organization:

- **Bridge Preservation Office (BPO)** – This office is dedicated to running the bridge inspection program for all state owned bridges. This includes bridges managed by State Parks, General Administration, and other state agencies with bridges subject to the NBIS. BPO also co-manages bridges on the border with Oregon and Idaho. The BPO is led by the Bridge Preservation Engineer who also functions as the Statewide Program Manager.
- **Local Programs (LP)** – This office provides support and services to local agency bridge inspection programs. In particular, LP provides training, manages the inspector certification program, and many aspects of the local agency bridge inventory data. The WSDOT Local Programs Bridge Engineer (LPBE) functions as a delegated program manager for all local agency bridges.

Local agencies have a wide variety of bridge inspection programs, which generally fall into the following categories:

- Local agencies with a delegated program manager and bridge inspection staff working directly for them.
- Local Agencies with a delegated program manager and agency contracts out to other agencies or consultants for completion of bridge inspection work.
- Local agencies without a delegated program manager but with bridge inspection staff.
- Local agencies without a bridge inspection program. These agencies generally have agreements with other agencies or consultants to inspect and manage their bridges.

1.04 Bridge Inspection Organization Roles and Responsibilities

The bridge inspection organization, and the various programs within it, are staffed by individuals who have defined roles and responsibilities described as follows.

A. *Statewide Program Manager (SPM)*

The Statewide Program Manager is the individual in Washington State who leads the bridge inspection organization. This position is held by the Bridge Preservation Engineer, who must ensure that the organization fulfills its NBIS responsibilities, see Appendix 1.07-C. To qualify as the SPM, WSDOT requires this individual to have both a current Structural Engineering and Professional Engineering license and qualify as a certified team leader. The SPM must also be recertified on a regular basis by attending a refresher training class according to state policy. The certification process is described in detail in Section 1.05.

B. *Delegated Program Manager (DPM)*

A delegated program manager assumes duties of the program manager for the selected subset of bridges under their direct control, See Appendix 1.07-D. To qualify as a delegated program manager, the individual must meet, at a minimum, the program manager requirements as described in the NBIS. Delegated program managers must be recertified on a regular basis by attending a refresher training class according to state policy. The certification process is described in detail in Section 1.05.

Note: Although delegated program managers perform duties for the bridge inspection organization, overall responsibility for NBIS compliance still resides with the Statewide Program Manager as defined by the NBIS.

C. *Team Leader (TL)*

A team leader is in charge of an inspection team and responsible for planning, preparing, and performing the field inspection of bridges. The team leader also makes repair recommendations and is responsible for initiating the critical damage procedures including full bridge closure if deemed necessary. To qualify as a team leader, the individual must meet, at a minimum, the team leader requirements as described in the NBIS. Team leaders must be recertified on a regular basis by attending a refresher training class according to state policy. The certification process is described in detail in Section 1.05.

D. *Assistant Inspector*

An assistant inspector (Co-Inspector) may accompany the team leader during field bridge inspections. Typical duties include helping to organize bridge inspection trips, taking measurements, compiling notes, and taking photographs. When assistant inspectors also fully participate in the inspection process and prepare inspection reports under the direct supervision of a team leader, this work provides qualifying experience towards certification as a team leader.

Note: The NBIS does not set specific training or educational requirements for assistant inspectors. However, bridge inspector training is recommended and available to all assistant bridge inspectors to serve as a good foundation for beginning inspectors as well as being a requirement for advancement to team leader.

E. Load Rating Engineer (LRE)

A load rating engineer manages all aspects of maintaining current and accurate load ratings for bridges they are responsible for in their inventory. Responsibilities include reviewing inspection reports for changed conditions that warrant revisions to the load ratings on file, revising load ratings as needed, creating new load ratings for new bridges, and ensuring that the findings from load ratings are implemented. In particular, the load rating engineer must track bridges that require posting and ensure that the bridge inventory has current data from the load ratings.

Note: To qualify as a load rating engineer in the BPO, the individual must have 4 years of bridge design or load rating experience and a current Professional Engineering license.

F. Underwater Bridge Inspection Diver (UBID)

To qualify as an underwater bridge inspection diver, the individual must meet, at a minimum, the underwater bridge inspection diver requirements as described in the NBIS. The certification process is described in detail in Section 1.05.

Note: The BPO has a Dive Safety Manual that regulates the diving activities for the BPO UBID's.

G. FHWA Division Bridge Engineer (DBE)

The Washington Division Office of the FHWA has assigned a Division Bridge Engineer to work collaboratively with the bridge inspection organization. The DBE works directly with the SPM and LPBE on resolving issues of compliance and is an active member of the BIC. The DBE has federal authority to approve the policy and procedures of this manual as noted in the Foreword of this manual.

1.05 Bridge Inspection Certification

Certification for bridge inspection work within the state of Washington is a two-fold process that consists of the initial certification and subsequent certification renewals for the SPM, DPM's, TL's, and UBID's. For the purposes of simplifying the explanation of this procedure, the general term program manager (PM) will be used in place of SPM and DPM. The following requirements will pertain to both positions unless otherwise noted.

A. Initial Certification

The minimum qualifications for prospective individuals are described within Section 309 of 23 CFR 650, Subpart C of the NBIS. To ensure that these requirements are met, the following steps outline the process for those individuals seeking initial certification.

- Fill out the WSDOT Bridge Inspector Experience and Training Record form, see Appendix 1.07-A.
- Submit an electronic copy of the completed form along with the following applicable documents to the WSDOT Local Programs Bridge Engineer (LPBE) for review:
 - Higher education degree(s), certification as a Level III or IV Bridge Safety Inspection Inspector, or qualifying bridge inspection experience.

- Registered professional engineering license(s).
- Certificate of completion of an FHWA approved comprehensive bridge inspection course such as the *WSDOT Bridge Condition Inspection Training (BCIT)* course or the *NHI Safety Inspection of In-Service Bridges* course.
- Certificates of completion for any special technical courses related to in-service bridge condition inspection.
- Any additional information documenting the bridge inspection experience of the applicant.
- Approved applicants are issued a WSDOT Inspection Identification Number that is acknowledged through an email response from the LPBE.
- In addition to the minimum qualifications, the SPM, TL's within the BPO, and the LPBE, are all required to be registered professional engineers in Washington State. The SPM must also be licensed in the state of Washington as a structural engineer.

B. Certification Renewal

Certification renewal ensures that the PM's, TL's, and UBID's in any agency maintain a minimum level of training in the latest practices and technology in the area of bridge inspections. The training may consist of inspection related courses, conferences, seminars and other sources of education deemed qualified by the SPM and LPBE. A list of approved courses is located in Appendix 1.07-B. This process within the State of Washington consists of a fixed five year period established for each individual PM, TL and UBID. Within this five year period, the following course credit hours are required for continuing education training.

- State PM and TL's and UBID's are required to have 80 hours.
- Local Agency PM's and TL's and UBID's are required to have 40 hours.

Five year certification period

- The five year certification period is to be managed between the individual and the designated PM.
- Depending on the individual's need, the *NHI Bridge Inspection Refresher Training (BIRT) course or other State, local or other federally developed instruction* course must be taken at least once during each 5 year certification period.
- The hours for these two particular courses can only be counted once as credit during each 5 year certification period.
- The hours from BIRT course count toward completion of the designated hours of continuing education training required to maintain certification.
- For purposes of ensuring enrollment in a BIRT course, the BIRT can be taken within six months either side of the established certification expiration date of the current five year period for each employee to extend certification for the next 5 year period. The employee should be placed under probation and a plan of corrective action created if the expiration date is exceeded by going beyond the five year period. See Section 1.06.

C. Certification Roles and Responsibilities

1. Employee Responsibilities:
 - a. The PM, TL and UBID are responsible for maintaining an individual accounting of the approved training courses they have taken in the established five year re-certification period.
 - b. The PM, TL and UBID are responsible to attend training when scheduled and to seek out attendance when needed.
 - c. Continuing education courses, seminars or conferences pertaining to bridge inspection work, that are not pre-approved as qualifying classes are to be submitted to the SPM or LPBE for consideration. The following information is needed when submitting a class to the SPM or LPBE for approval.
 1. Course/Conference title
 2. Course/Conference description
 3. Course/Conference duration
 4. Course/Conference date
 5. Explanation of how the course/conference provides the latest practices and/or technology in the area of bridge inspections.

Upon PM approval, the class will be added to the pre-approved class list.

2. Supervisor Responsibilities:
 - a. Meet annually during the employee's annual evaluation to discuss training completed and overall status for re-certification.
 - b. Ensure the employees have opportunity to attend training that qualifies for recertification.

1.06 Bridge Inspection Certification Probation, Suspension, Decertification and Reinstatement

To couple the process of certification above in Section 1.05, a process for decertification has been established to ensure that all PM's, TL's, UBID's are following the proper conduct of their respective positions.

Key Terms:

Appointing Authority – The designated authority that oversees the sanctions of probation, suspension or decertification of a PM, TL and UBID.

Probationary Period – A PM, TL or UBID is allowed to continue their duties for a prescribed timeframe in order to complete an approved Plan of Corrective Action.

Plan of Corrective Action – A personalized plan approved by the Appointing Authority that identifies criteria the PM, TL, or UBID must complete within an established timeframe for inspection re-certification.

Suspension – Temporary removal of inspection certification as PM, TL or UBID.

Decertification – Permanent removal of inspection certification as PM, TL or UBID until a formal Plan of Corrective Action is administered by the Appointing Authority and fulfilled by the PM, TL or UBID.

Three examples in which a certified PM, TL or UBID may be placed on probation or suspended are listed below. Decertification can result immediately upon knowledge of conduct presented below or if the PM, TL or UBID does not meet the terms agreed upon in the plan of corrective action:

1. If a PM, TL or UBID does not fulfill the requirements for recertification (Section 1.05).
2. If a PM, TL or UBID is found to be using poor inspection practices or producing inadequate inspection documents as assessed by the QC/QA process.
3. If a PM, TL or UBID is found to be falsifying bridge inspection records, misrepresenting bridge hours on site or otherwise failing to meet general ethical standards.

Reinstatement of certification from suspension or completing probation requirements will require a formal plan of corrective action. This may be a simple process or more complex based on the nature of the situation.

This formal plan of corrective action consists of the following:

- The suspended PM, TL, or UBID will be notified in writing by the appointing authority that a plan of corrective action is needed.
- A plan of corrective action developed by the employee is to be approved by the appointing authority.
- Based on the circumstances in examples 1 and 2 above, the PM, TL, or UBID may be required to attend additional Bridge Inspector training classes beyond the continuing education requirements of Section 1.05 as specified by the appointing authority involved in the formal review. The PM, TL or UBID may also be required to receive additional field instruction by the direct supervisor.
- For the circumstance in example 3 above, the PM, TL or UBID may be subjected to more strict consequences as determined by the appointing authority.

A PM, TL or UBID who successfully completes the plan of corrective action will be considered to be in good standing. A PM, TL or UBID who does not satisfactorily complete the plan of corrective action may be decertified.

The DPM will notify the SPM when a PM, TL or UBID in a Local Agency is placed on probation or is suspended, as well as the resulting reinstatement or decertification.

1.07 Appendices

- | | |
|-----------------|--|
| Appendix 1.07-A | WSDOT Bridge Inspector Experience and Training Record form |
| Appendix 1.07-B | Continuing Education Course List |
| Appendix 1.07-C | SPM delegation letter |
| Appendix 1.07-D | DPM delegation letter |

WSDOT Bridge Inspector Experience and Training Record Form



Bridge Inspector Experience and Training Record

Applicant for Bridge Inspector Certification	Date
--	------

Organization

Education			
Institution	Major	Years	Degree

Professional Registration		
State	Branch/Agency	Registration Number

Bridge Inspection Training			
Course	Hours	Sponsor	Dates

Special Technical Course			
Course	Hours	Sponsor	Dates

Bridge Inspection Experience		
Organization	Bridge Duties	Years

To the best of my knowledge, the above information is true and accurate.

Applicant's Signature _____ Date _____

Having reviewed the above information, I conclude that this individual meets the minimum qualifications for a bridge inspection team leader as specified in the current National Bridge Inspection Standards.

Team Leader's Signature _____ Date _____

Team Leader's Name (Print) _____ Title _____

DOT Form 234-100 EF
Revised 08/2012

Appendix 1.07-B

Continuing Education Course List

For the purpose of continued certification as the SPM, TL, or UBID within the Bridge Preservation Office, the following list of courses are examples of qualifying courses with estimated hours to acquire the necessary continuing education hours in an established 5 year period for each individual employee.

WSDOT/LTAP – Bridge Condition Inspection Fundamentals (BCIF)	24 hours
WSDOT/LTAP – Bridge Condition Inspection Training (BCIT)	72 hours
WSDOT/LTAP – Bridge Condition Inspection Update (BCIU)	16 hours
WSDOT/LTAP – Bridge Inventory Coding	18 hours
NHI Safety Inspection of In Service Bridges	74 hours
NHI Bridge Inspection Refresher Training	18 - 20 hours
NHI Stream Stability and Scour at Highway Bridges for Bridge Inspectors	8 hours
NHI Stream Stability and Scour at Highway Bridges	24 hours
NHI Underwater Bridge Inspection	24 hours
NHI Fracture Critical Inspection Techniques for Steel Bridges	32 hours
NDT – Dye Penetrant Testing	12 hours
NDT – Magnetic Particle Testing	20 hours
NDT – Ultrasonic Testing	32 hours
PNW Bridge Maintenance Conference	Credit as appropriate
PNW Bridge Inspection Conference	Credit as appropriate
Annual Inspection Process Change Meeting	Credit as appropriate
Western Bridge Engineers Seminar	Credit as appropriate

Additional courses, seminars or conferences of similar content can be considered for approval by the SPM or LBPE.

Documents available as reference and training material include but are not limited to the following:

- *Washington State Bridge Inspection Manual (WSBIM)*
- *Bridge Inspection Reference Manual (BIRM)*
- *The Manual for Bridge Evaluation (MBE)*
- *Timber Bridges Manual (USDA)*



**Washington State
Department of Transportation**
Paula J. Hammond, P.E.
Secretary of Transportation

Transportation Building
310 Maple Park Avenue S E
P O Box 47300
Olympia, WA 98504-7300

360-705-7000
TTY: 1-800-833-6388
www.wsdot.wa.gov

June 27, 2011

Harvey L. Coffman
Bridge & Structures Office
PO Box 47340
Olympia, WA 98504-7340

Dear Mr. Coffman:

This is to advise you that as the Bridge Preservation Engineer of the Bridge and Structures Office, you are hereby delegated authority as Program Manager for the statewide bridge inspection program, as defined in the National Bridge Inspection Standards 23 CFR 650.307(e), §650.307(c) (1), and §650.307(c) (2).

These duties may be further delegated to individuals meeting the qualifications of 23 CFR 650.309(a). However, the responsibility must remain with you as the Program Manager in accordance with 23 CFR 650.307(d).

Sincerely,



J. C. Lenzi, P.E.
Chief Engineer

JCL:gv

cc: Jugesh Kapur
Steve Reinmuth
Kathleen Davis
Debbie Lehmann, FHWA



Memorandum

May 16, 2013

TO: Roman Peralta, P.E.
Highways & Local Programs Bridge Engineer
MS: 47390

FROM: Harvey L. Coffman, P.E., S.E. *HLC*
Bridge Preservation Engineer
MS: 47340

SUBJECT: Sub-delegation of Bridge Inspection Program Manager
for Local Agencies

By authority granted to me by Jerry Lenzi's letter dated June 27, 2011, as the Statewide Program Manager, I am sub-delegating to you as the new Highways and Local Programs Bridge Engineer, Program Manager duties, as defined in the National Bridge Inspection Standards (NBIS) 23 CFR 650.307(e), §650.307(c) (1), and §650.307(c) (2), for all the local agency bridge inspection programs.

These duties can be further sub-delegated by you to any local agency representative who meets the qualifications stated in §650.309(a). This action must be done in writing.

Please note, that the overall bridge inspection program responsibility must remain with the Bridge Preservation Engineer as the Statewide Program Manager in accordance with 23 CFR 650.307(d).

HLC:hc

cc: Todd Harrison, Bridge and Structures Engineer (acting)
Katy Taylor, Chief of Staff (acting)
Kathleen Davis, Highway and Local Programs
Debbie Lehmann, FHWA

2.01 General

This chapter establishes policies on how the Washington State Department of Transportation (WSDOT) and local agencies maintain bridge files, both to meet Federal Highway Administration (FHWA) requirements and effectively manage physical assets (also sometimes referred to as physical features) on WSDOT right of way. These policies apply to structures that are generally called bridges, culverts, tunnels, lids, detention vaults, overpasses, and undercrossings when they meet certain criteria commonly based on structure geometry, location, and use which will be described in more detail below.

These policies also apply differently depending on bridge ownership and location and fall into three main categories:

1. WSDOT-owned structures on WSDOT right of way.
2. Local agency-owned structures on WSDOT right of way.
3. Local agency-owned structures on local agency right of way.

Unless otherwise specifically noted below, all policies apply to WSDOT and local agency owned structures on WSDOT right of way. However, only those policies directly associated with FHWA requirements apply to local agency owned structures on local agency right of way. There are occasionally special circumstances in which WSDOT owns a structure on local agency right of way. This chapter has no specific policies in this case, except that the bridge file must be maintained under all circumstances.

This chapter addresses the following topics associated with bridge files:

- Maintaining physical paper and electronic bridge files.
- Maintaining a state bridge inventory.
- Submitting state bridge inventory data to FHWA.
- Responding to FHWA and Statewide Program Manager (SPM) requests for information.

Each topic has components that are mandated by FHWA and components that are required by WSDOT policy. The following sections clearly identify the authorizing environment.

2.02 Maintaining Bridge Files and Documentation

This section is largely based on requirements established by Section 2 of the AASHTO *Manual for Bridge Evaluation* (MBE) with Interim Revisions. The MBE emphasizes three main points for maintaining a bridge file:

- A. Bridge owners should maintain a complete, accurate, and current file of each bridge under their jurisdiction.
- B. A bridge file always contains the current and sometimes the cumulative information about an individual bridge.
- C. A bridge file may be stored electronically, on paper, or a mixture of both.

The remainder of this Section 2.02 describes WSDOT Bridge Preservation Office policy for maintaining bridge records.

Electronic Files

Electronic bridge files are maintained on the BEIS internal website:
<http://beist/InventoryAndRepair/Inventory/BRIDGE>

This website contains the following:

1. Scanned copies of signed inspection reports in pdf format dating back to approximately the year 1998.
2. Scanned copies of the Washington State Structural Inventory and Appraisal (SIA) sheet dating back to 2011.
3. Current inspection photographs in jpg format.
4. Current and historic repair recommendations displayed directly from the BPO database (See Section 2.03), dating back to approximately the year 2002.
5. Scanned copies of contract plans, as-builts when available, otherwise award plans. Note that the plan sheets on BEIS are not the official plans, which are owned by the WSDOT regions where the bridge is located.
6. In-house repair plans dating back to 2013.
7. Scanned copies of correspondence, historic repair and maintenance reports, miscellaneous studies, and other records are scanned from the paper files and loaded onto BEIS for selected bridges. This is generally done in response to a public disclosure request or a legal discovery requirement.

Paper Files

Appendix 2.06-A has a plan of the WSDOT Bridge Preservation Office indicating where paper files are maintained. Paper files must be maintained on WSDOT owned or maintained structures, including:

1. All signed bridge inspection reports, including but not limited to routine, fracture critical, underwater, and special report types. Original signed reports are stored in paper files and digital copies are stored electronically. Signed damage inspections in response to fires, floods, earthquakes, etc shall also be included.

2. Any and all miscellaneous special inspections, studies, investigations, or file reviews. Examples include but are not limited to: load testing documentation, findings from FHWA technical advisory requests for information, survey results, or ground/slope stability studies.
3. A current printout of any specific inspection requirements/procedures, usually but not necessarily associated with fracture critical, underwater, or special inspection reports.
4. A stamped Load Rating Summary sheet which shows the controlling ratings shall be placed in the letter file. The original load rating calculations for state owned bridges shall be filed in the Risk Reduction section at the WSDOT Bridge Preservation Office.
5. Scour files are located in the Risk Reduction section at the WSDOT Bridge Preservation Office.
6. All current agreements with other agencies for maintenance, rehabilitation, or shared ownership.

Note: The inspection reports, miscellaneous studies and inventory data is cumulative, meaning that all historic as well as current data must be kept in the bridge file. All documents listed above, and others listed in the MBE, may be stored electronically as a supplement to the paper files. WSDOT bridge files stored electronically have a backup system intended to protect the electronic data for the life of the structures.

Other Files – Some bridge records are not available electronically at the BEIS internal website or in paper files as indicated in Appendix 2.06-A. The WSDOT *Bridge Design Manual* M 23-50 provides some guidance on where these records are located. The following provides some additional information:

Contract Documents – For contracts let thru WSDOT Contract Ad and Award, Washington State Archive maintains a paper cumulative file by contract number of awarded contracts and construction documents as required by the *Construction Manual* M 41-01, Section 10-3. WSDOT Records and Information maintains electronic copies of finalized As-Built Contract Plans.

WSDOT Bridge and Structures Office maintains structural plans and selected shop drawings which are stored electronically. Structural plans include culvert shop drawings that contain plan and design information along with plan contracts from other agencies that complete work on the WSDOT system. Shop drawings include: steel structures, expansion joints, specialized bearings (such as pot or seismic isolation bearings), prestressed girders, post-tensioned structures, and special structural designs (such as pontoon, suspension, or movable bridges).

WSDOT maintains a Contract History database that records all contract work completed on a structure. This database correlates contract number and contract work to structures maintained by the WSDOT bridge inventory. Contract work includes: new bridges, resurfacing bituminous pavement, expansion joints, rail retrofits, bridge widening, bridge painting, scour mitigation, contract bridge repairs, maintenance work by contract, other agency contract work, and concrete deck overlays and replacements.

In-House Repair Documents – WSDOT maintains a cumulative file of all in-house repair recommendations made by the Bridge Preservation Office, and follow-up verification information when repairs are completed. If maintenance reports prepared by region maintenance crews are provided to the bridge record, they are also permanently retained. In-house drawings and specifications supplementing the repair recommendations are also retained in the electronic record starting in 2013.

Correspondence on Significant Actions or Findings – WSDOT maintains a cumulative file of correspondence (letters, emails, memos, etc) related to significant actions or findings, including but not limited to:

- Urgent or emergency actions including posting, restricting or closing a bridge
- Critical findings, including Critical Damage Bridge Repair Reports (see WSBIM Chapter 6)
- Special reports, including deck delamination/chloride testing, settlement/movement monitoring, and life cycle studies

This correspondence may need a “summary memo to file” after the significant actions or findings are fully addressed. This memo is intended to provide full context and the final disposition of the actions or findings for the record.

2.02.01 Transferring Bridge Ownership

Whenever a bridge transfers ownership and/or program manager responsibility, the entire bridge file, both paper and electronic, must be transferred to the new owner/program manager. Bridge transfers must be acknowledged and documented by both program managers involved along with any additional deeds, agreements, plans or other documentation available. All transfer documentation must be retained in the bridge file. See Appendix 2.06-B for a checklist and SPM signoff sheet. In some cases, the acknowledgement of the transfer by the program managers may be the only documentation available.

In cases where WSDOT transfers a bridge file to another agency, a complete electronic copy of the entire bridge file is made and retained permanently. Other agencies are encouraged to follow this practice, but are not required to.

For more information about transferring electronic files in the WSBIS, see Section 2.03.03.

2.02.02 Dead / Obsolete Bridge Files

When a bridge is demolished or permanently removed from service and no longer considered appropriate for inclusion in the bridge inventory, the program manager for the “dead” bridge shall add documented acknowledgement of the removal from the inventory into the bridge file which then must be retained for a minimum of five years. WSDOT maintains dead bridge files permanently. Local agencies are encouraged to maintain permanent dead bridge files as well, though there is no requirement to do so.

See Section 2.03.04 for more information on processing “dead” bridge electronic records in the WSBIS.

2.02.03 Structures on WSDOT Right of Way

WSDOT shall maintain a bridge file for all structures considered appropriate for inclusion in the WSBIS that are on the WSDOT right of way, including local agency bridges passing over state routes or adjacent to state routes, whether or not the structure is subject to the NBIS or reported to the NBI. For more information, see Section 2.03.05.

2.03 Maintaining a State Bridge Inventory – WSBIS

Washington State is required by 23 CFR 650.315 to maintain an inventory of all bridges (structures) subject to the National Bridge Inspection Standards (NBIS), from which selected data is reported to FHWA as requested for entry into the National Bridge Inventory (NBI). FHWA has a Stewardship Agreement with Washington State to submit NBI data on April 1 and October 1 each year.

The Moving Ahead for Progress in the 21st Century Act by the US Congress (MAP-21) has partially superseded 23 CFR Part 500, and mandates that National Bridge Elements be submitted to FHWA for all NBI bridges carrying National Highway System (NHS) routes. See www.fhwa.dot.gov/map21 for more information about MAP-21.

Federal law under 23 CFR Part 500 provides an option for state agencies to maintain a Bridge Management System (BMS), with the incentive that federal funding can be used with more flexibility. Washington State has chosen to implement a BMS and integrally incorporate it into the state inventory for bridges managed under the WSDOT bridge program. In addition, Washington State maintains an inventory to meet WAC 136-20-020, which requires that each county maintain an inventory of bridges in the state inventory. The Washington State Bridge Inventory System (WSBIS) is maintained to meet these federal and state laws and regulations. The WSBIS is also maintained to meet the WSDOT mission statement with respect to operating the state bridge structures, and provides a means for local agencies to do the same.

In Washington State, there are currently two separate databases which hold bridge information, one mostly holding state owned structures (BPO database) and a second mostly holding local agency owned structures (LP database). A third database (the Bridge Reporting Database) draws data from these two databases and is the source for data reported to FHWA. This third BRD database is maintained by the WSDOT Information Technology Division (ITD). The Washington State Bridge Inventory System (WSBIS) consists of all the data held in the BRD.

The BPO database is maintained by the WSDOT Bridge Preservation Office, which maintains an associated coding guide available in Appendix 2.06-C. The LP database is maintained by the WSDOT Local Programs Office, which also maintains an associated LP coding guide available in Appendix 2.06-D. These coding guides are intended to define the fields maintained in the respective databases for use by bridge inspectors and inventory managers. These coding guides are largely based on the federal coding guide and must meet the following requirements:

1. Whenever a database field has to be translated to match the federal coding guide, this translation must be clearly defined.
2. The state or local agency coding guides cannot contradict the federal coding guide. In cases where the federal coding guide is either inconsistent with other FHWA requirements or vague, the state or local agency coding guide needs to clearly identify the issue and describe how the field should be coded into WSBIS.
3. Required and optional fields must be clearly identified.
4. Every field must clearly state whether or not it is required for under records, and if so, exactly how it is coded for these under records.
5. When bridge records are neither “on” nor “under” (pedestrian bridge adjacent to a highway bridge for example). The coding guide must provide clear and consistent guidance on how these are to be coded.

2.03.01 WSBIS Inventory and Data

The WSBIS needs to be understood clearly in two ways – which structures are included in the inventory and what data associated with these structures is maintained. Each of these categories has both mandated and optional components.

Beginning in October 2014 there is a requirement, from MAP-21, to collect National Bridge Element data for bridges carrying NHS routes. WSDOT is meeting this mandate by requiring these bridges to have BMS elements in WSBIS, which in turn will be translated into National Bridge Elements for submittal. See Appendix 2.06-E for the WSDOT BMS to NBE translation specifications. See www.fhwa.dot.gov/map21 for more information about MAP-21.

Mandated Structures in the WSBIS – Reported to the NBI

In general, a structure that is subject to the NBIS and must be reported to the NBI when it meets all of the following:

- Carries highway traffic.
- Is owned by a public agency or built on public right of way for a public agency. Bridges owned by road associations or individual property owners on private right of way do not qualify.
- Is open to the public. Bridges posted “no trespassing” or otherwise clearly identified that they are privately owned or restricted to authorized users are not considered public. Bridges behind locked gates are also not considered public.
- Has a clear span along centerline of roadway greater than 20 feet.

Utility and Detention Vaults – Based on an agreement between Washington State and FHWA, vaults under roadways are considered subject to the NBIS when the minimum clear span along the centerline of the roadway exceeds 20 feet AND is wider than 12 feet, including any structure that has any portion directly under a lane or shoulder.

There are a few special circumstances that affect whether or not a bridge is subject to the NBIS and reported to the NBI not mentioned above (see Section 2.03.06).

Structures over federal aid or STRAHNET highways must include an “under” record(s) in the WSBIS and be reported to the NBI.

Optional Structures in the WSBIS – Not reported to the NBI

Optional structures include any structure that the state or local agency manages as part of their bridge inventory, but which do not qualify for reporting to the NBI. Typically this will include bridges with span lengths less than 20 feet (short spans), pedestrian structures that do not cross over or under a highway, and “under” records for a route that is neither federal aid nor STRAHNET.

Note: Local agency structures on WSDOT right of way have special requirements as noted in Section 2.03.05.

Mandated Data in the WSBIS

All data fields defined in the FHWA Coding Guide are required in the WSBIS. In cases where structures are maintained in WSBIS but not reported to the NBI, it is still required to complete all these fields in some consistent manner defined in a coding guide.

The following additional fields or clarifications of NBI fields are required:

- **Bridge Number** – A 10-digit alphanumeric code that must always be populated.
- **Bridge Name** – A 24-digit alphanumeric code that must always be populated.
- **Washington State Region Code (Federal Coding Guide Item 2)** – Consist of the following 2 digit alphanumeric codes that always must be populated:
 - NW – Northwest Region
 - EA – Eastern Region
 - NC – Northcentral Region
 - OL – Olympic Region
 - SC – Southcentral Region
 - SW – Southwest Region
- **County Code (Federal Coding Guide Item 3)** – Consists of the numeric code representing the alphabetic order of Washington State counties. This field must always be populated. These codes are available in an Excel spreadsheet within the “County and City Codes” tab at www.ofm.wa.gov/pop/annex

Use the 2-digit COUNTYN column in the County Codes spreadsheet tab.

Examples:	Adams	01
	Yakima	39

- **City Code** – Consists of the 1990 federal census place code, updated by OFM for cities incorporated after 1999. These codes are available in an Excel spreadsheet within the “County and City Codes” tab at www.ofm.wa.gov/pop/annex

Use the 4-digit Place_1990 column in the City Codes spreadsheet tab.

Examples:	Aberdeen	0005
	Zillah	1500

National Bridge Element (NBE) Data

Beginning October 2014, all bridges subject to the NBIS and carrying NHS routes are required to include WSDOT Bridge Management System (BMS) elements. Starting with the April 1, 2015 data submittal to FHWA, these BMS elements will be translated to National Bridge Elements and included with the annual NBI data submittal. See Appendix 2.06-E for detailed information on the translation process.

Optional Data in the WSBIS

All other data, including BMS elements for bridges not on NHS routes, condition states, repairs, notes, and electronic photos and documents are not required in the WSBIS, and are not reported to the NBI.

2.03.02 New Bridge Inventory in the WSBIS

Newly built bridges must be added to the bridge inventory (WSBIS) and the Structure Inventory & Appraisal (SI&A) data entered within 90 days after the bridge is opened to public traffic in the anticipated final configuration as per 23 CFR 650.315(c).

New bridges to the inventory must have a unique Structure Identifier (Federal Coding Guide Item 8) in the WSBIS. In particular, when a bridge is replaced – either temporarily or permanently – with a new structure, this new structure must have a new Structure Identifier. The same Bridge Number and Bridge Name fields can be used.

Individuals who create new inventory records in the WSBIS need to be familiar with a wide variety of information sources. In preparation for creating a new inventory record, the following information should be available:

- Bridge plans.
- Load rating calculations, or summary information to correctly code selected fields.
- Scour calculations, or summary information to correctly code selected fields when bridge is over water.
- Route information, including current State and/or Local Agency Linear Referencing System (LRS) data.
- GIS location information
- Traffic information

Additional specific information may be required in many cases, including but not limited to maintenance agreements, navigable waterway permits, replacement cost estimates, and historical significance.

Individuals who create new inventory records need to coordinate closely with the inspectors who perform the initial routine/inventory inspection to ensure that all the data is collected. See Chapter 3 for inspection procedures and policies.

Temporary bridges that carry public traffic for less than 90 days or which are less than 20 feet in length do not need to be inventoried or inspected in accordance with the NBIS. In **all** other circumstances temporary bridges carrying public traffic must be inventoried and inspected in accordance with the NBIS, including:

- Temporary bridges installed either as an emergency response by agency staff or as a stand-alone contract without any other substantial work performed in the immediate vicinity of the bridge site.
- Temporary bridges that are an integral part of a larger construction project, located within that project, and maintained by a contractor.

2.03.03 Transferring Bridge Ownership in the WSBIS

Transferring bridge ownership between local agencies and state agencies requires transferring electronic records between the LP and BPO databases. This will be a manual process whereby the record will be “obsoleted” in the originating database, and a new record created in the receiving database. This new record will be created based on printouts of the established record in the originating database, and all associated electronic files (.jpg photos, .pdf images, plans, etc.) transmitted along with paper records on DVD or other compatible format. These electronic files will be associated with the database record and stored electronically.

2.03.04 Deleting (Obsoleting) Bridges in the WSBIS

Both the BPO and LP databases are designed to retain historical data indefinitely, including files of bridges that have been removed from service and no longer part of the current bridge inventory. These bridges are called “obsolete” in the WSBIS and are called “dead” in the paper files (see Section 2.02.02).

WSDOT policy guides the requirements for deleting (obsoleting) structures in the WSBIS, but in this case the policy applies to all bridges in the WSBIS that are reported to the NBI, including local agency bridges on local agency right of way. Obsoleting bridge records in both databases shall include the following steps:

- Create a new informational report describing the circumstances of the removal and the replacement structure information if appropriate.
- The informational report is signed by the Statewide Program Manager (SPM).
- The paper bridge file (record), including the last signed informational report documenting removal from the bridge inventory, shall be retained for a minimum of five years.

See Section 2.02.02 for more information on maintaining “dead” bridge files.

2.03.05 Bridges with Multi-Agency Responsibility in the WSBIS

There are several ways in which a single bridge can have more than one agency responsible for the bridge inventory data. This section describes four cases where the responsibility is shared between WSDOT and a local agency, and where either WSDOT or a local agency shares responsibility with another state.

Shared Responsibility between WSDOT and Local Agencies

There are the four cases of shared responsibility between WSDOT and a local agency, based on the principle of assigning data responsibility to the agency in the best position to maintain and report the data. These cases are WSDOT policy for all structures on WSDOT right of way. However, they can apply equally to any two agencies (a county and a city, for example). Regardless of how local agencies address these cases, it is a requirement that all bridge data in WSBIS that is reported to the NBI must be complete, accurate and current. This WSDOT policy is superseded by any written agreement between two agencies regarding bridge inventory record keeping.

Case 1: WSDOT-Owned Bridges on WSDOT Right of Way – WSDOT will be responsible for maintaining all bridge inventory data and federal reporting in this situation.

Note: This situation applies to any combination of “on” and “under” records, route owners, and federal reporting status. However, WSDOT will ask local agencies for specific data regarding local agency route and traffic, both for routes “on” and “under” the bridge as applicable.

Case 2: Local Agency-Owned Bridges Carrying Highway Traffic Over State Routes

– This situation assumes that the bridge must have a federally reported “on” record and at least one federally reported “under” record. The “on” record shall be maintained by the local agency and the “under” record(s) shall be maintained by WSDOT.

Case 3: Local Agency-Owned Pedestrian Bridges Over State Routes – This addresses all situations in which there is no federally reported “on” record, and assumes that there is a federally reported “under” record, and possibly additional “under” records for the *Bridge List M 23-09*. The “under” record(s) shall be maintained by WSDOT. If the local agency chooses to maintain a record, it cannot be federally reported.

Case 4: Local Agency-Owned Bridges on State Right of Way Adjacent to a State Route – This addresses all situations in which a local agency owns a structure (usually a pedestrian bridge) on state right of way that does not cross over or under any routes, and is deemed appropriate by WSDOT for inclusion in the bridge inventory. In this case, no records are federally reported

In all situations where there is shared responsibility between WSDOT and a local agency, both the BPO and LP database must use the same structure identifier (Federal Coding Guide Item 8) and coordinate the on/under code (Federal Coding Guide Item 5A) to maintain a unique combination of these fields (a composite key) for all bridge records in both databases, regardless of which ones are reported to the NBI. The BPO and LP data stewards shall coordinate closely to ensure these bridge files are kept complete, accurate and current. Any situations that do not fit into these four cases listed above shall be considered on a case-by-case basis by the program managers involved and should address the following questions:

- Does the bridge record include a federally reported “on” record? These are bridges that are subject to the NBIS.
- Does the bridge record include one or more federally reported “under” records? These are bridges with federal aid or STRAHNET routes under the bridge.
- Is this a bridge that doesn’t qualify for either an “on” or “under” record? These are pedestrian or other bridges that are not subject to the NBIS, and do not cross over a highway.
- Who owns the bridge?
- What agency owns the route on the bridge, if applicable? It is relatively common for a state owned structure to carry a local agency route, usually over a state route.
- What agency owns the route (or routes) under the bridge, if applicable?
- Does either agency need to maintain “on” or “under” records that are not federally reported? WSDOT often maintains “under” records that are not reported to hold data for the *Bridge List M 23-09*.
- Are there any interagency agreements relevant to inspection and reporting responsibility?

Any interagency agreement should address these questions, and clearly assign bridge inspection and inventory responsibilities.

Shared Responsibility with Other States

WSDOT shares bridge recordkeeping and FHWA reporting responsibility for all bridges that cross state lines. For all but one bridge this shared responsibility also extends to bridge ownership and maintenance. For all bridges, responsibility to perform inspections is assigned to one state agency as established by agreement.

One local agency bridge crosses the state line between Washington and Idaho. Inspection, FHWA reporting, ownership, and maintenance responsibility is established by agreement.

See Appendix 2.06-F for bridge specific information.

2.03.06 Reporting WSBIS Data to the NBI – Special Circumstances

Section 2.03.01 outlined requirements for bridges subject to the NBIS and reported to the NBI. However, there are several special circumstances that warrant additional discussion.

Bridges Owned by Public Agencies That Are Not Open to the Public – Public agencies can own bridges that are not part of the public right of way, intended only for access by agency staff or other authorized personnel. In general, these bridges should not be reported to the NBI, and these bridges should be signed or gated so the public either does not have access to the bridge or is clearly warned that the bridge is not part of the public way. WSDOT bridges are posted “No Trespassing” at the entrance to the bridge if they are not gated.

Bridges Owned by Public Agencies That Are Closed – Bridges that are permanently closed to highway traffic but still in place may be retained in the WSBIS, but cannot be reported to the NBI. Bridges that are closed but the agency plans to either re-open or replace with a new structure can be federally reported for up to five years.

Privately-Owned Bridges – These bridges may belong to individuals, community road associations, railroads, or corporations, and may be open to the public. One relatively common example is a bridge in a shopping mall parking lot. FHWA and WSDOT promote the incorporation of these bridges in the WSBIS and recommend they be reported to the NBI if they qualify, but there is no federal or state requirement that they be inventoried.

Public Transit Bridges – Bridges carrying public transit buses in service (carrying passengers) are subject to the NBIS, even if these bridges are restricted to only public transit vehicles. Bridges carrying light rail public transit rolling stock without any vehicular or bus traffic are not currently subject to the NBIS.

Whenever a special circumstance affects the reporting of a structure, a brief explanation of the reporting status shall be kept in the electronic bridge record for all bridges inventoried in the WSBIS.

In any situation where it is unclear if a bridge should be included in the WSBIS and reported to the NBI, please consult with the SPM.

2.03.07 Washington State Bridge List M 23-09

The WSBIS is the source of data for the *Bridge List M 23-09* published by the Bridge and Structures Office. It is a list of structures carrying or intersecting Washington State highways, and structures for which WSDOT has a maintenance responsibility. Data specific to this list is maintained for nearly all structures on WSDOT right of way, including local agency owned structures.

For more information on the data maintained for the *Bridge List M 23-09*, see the Washington State Bridge Inventory System Coding Guide in Appendix 2.06-C.

2.04 FHWA Data Submittal Process

The WSDOT Bridge Preservation Office extracts data from the WSBIS and submits it to FHWA for inclusion in the NBI twice per year. Submittals may also happen at other times at the request of the Washington Division of the FHWA. The scheduled submittals are April 1 and October 1, or the first work days following these dates. The data submitted includes all the data defined by the federal coding guide, and is provided in a very specific format also defined in Appendix E of this same federal coding guide. In addition, beginning with the April 1, 2015 submittal, selected NBI reportable bridges also must include BMS element data, which is translated to NBE data and submitted to FHWA. Both of these submittals are performed by the Bridge Preservation Office with data taken from the Bridge Reporting Database (BRD) and submitted to the FHWA User Profile and Access Control System (UPACS) under the authority of the SPM.

Data drawn for submittal to the NBI is taken only from the most current “released” data from the BRD, meaning that each bridge record has been through the quality control process described in Chapter 7, including acceptance by the BPO and LP data stewards. However, in addition to this quality control process, prior to the scheduled NBI submittals both the BPO and LP data stewards run systemic checks of the data to identify and correct data errors. In particular, these checks are intended to ensure the following:

- Bridges added to the inventory are reviewed to determine if they should be reported to the NBI.
- Bridges removed from the inventory are reviewed to determine if they should be reported to the NBI and to ensure the electronic records accurately and sufficiently document the obsolete record.
- Bridges that are transferred between agencies are reviewed to ensure the electronic records accurately document the transfer.
- Bridges with shared responsibility are reviewed to ensure the electronic records are complete and accurate.

The intent is to submit error free data each submittal. In cases when errors are found but cannot be corrected because a field visit is required, the intent is that these errors will be corrected at the next regularly scheduled inspection.

Data submitted to the NBI is used for performance measurements after the submittal, both by FHWA and WSDOT. Verifying timely inspections for the four federally reported inspection types (routine, fracture critical, underwater, and special feature) is a primary focus of these performance measures. For the April 1 data submittal, all inspection work due through December 31 of the previous year must be “released” into the BPO and LP databases prior to April 1; for the October 1 data, all inspection work due through June 30 of the same year must be “released” prior to October 1.

2.05 Responding to FHWA

Information Requests – FHWA requests bridge inspection information from WSDOT on a periodic basis. The information that is requested can be in response to national technical advisories, FHWA’s oversight of the NBIS program in Washington State, or based on the WSDOT/FHWA Stewardship Agreement.

The bridge inspection requests for information from FHWA will typically be in the form of an email request with an assigned completion date based on the specific request, but can be in any format. The FHWA Division Bridge Engineer will submit the information request to the SPM. The SPM will review the FHWA information request and forward/disseminate the request to the necessary individuals for response. All information will be provided back to the SPM who will then forward the requested information to the Washington FHWA Division Bridge Engineer by the deadline in the original request.

Communication Between FHWA and WSDOT – Appendix 2.06-H identifies the standard communication protocol for normal operations. There is no protocol for urgent or emergency situations. The Washington SPM will be included in all written and email communications to or from FHWA regarding any bridge inspection, bridge emergency, or critical finding issues within the state of Washington. The WSDOT LP DPM and the Washington SPM will be included in all written and email communications to or from FHWA where local agency bridges are involved.

Annual NBIS Program Review – FHWA conducts an annual review of the bridge inspection organization within the state of Washington. The purpose of this review is to assure compliance with the NBIS. The review examines all facets of the inspection program – the effectiveness of the overall organization, delegated functions, inspection personnel, inspection procedures, bridge records and files, and the inventory of bridge data. It is intended to identify and correct any weaknesses while building upon existing strengths. In addition, site reviews of bridge inspections and interviews of inspection personnel are conducted. FHWA also conducts reviews of NBI data that is submitted for Washington by WSDOT.

Additional information on the NBI and NBIS can be found on the FHWA Office of Bridges and Structures website at www.fhwa.dot.gov/bridge/nbis.htm.

2.06 Appendices

Appendix 2.06-A	WSDOT BPO Floor Plan with File Locations
Appendix 2.06-B	Record Change Form
Appendix 2.06-C	Washington State Bridge Inventory System Coding Guide
Appendix 2.06-D	Local Agency Bridge Inventory Coding Guide
Appendix 2.06-E	WSDOT BMS to NBE Translation
Appendix 2.06-F	Border Bridge Information
Appendix 2.06-G	Sufficiency Rating Calculation
Appendix 2.06-H	WSDOT/FHWA Communication Protocol Flowchart

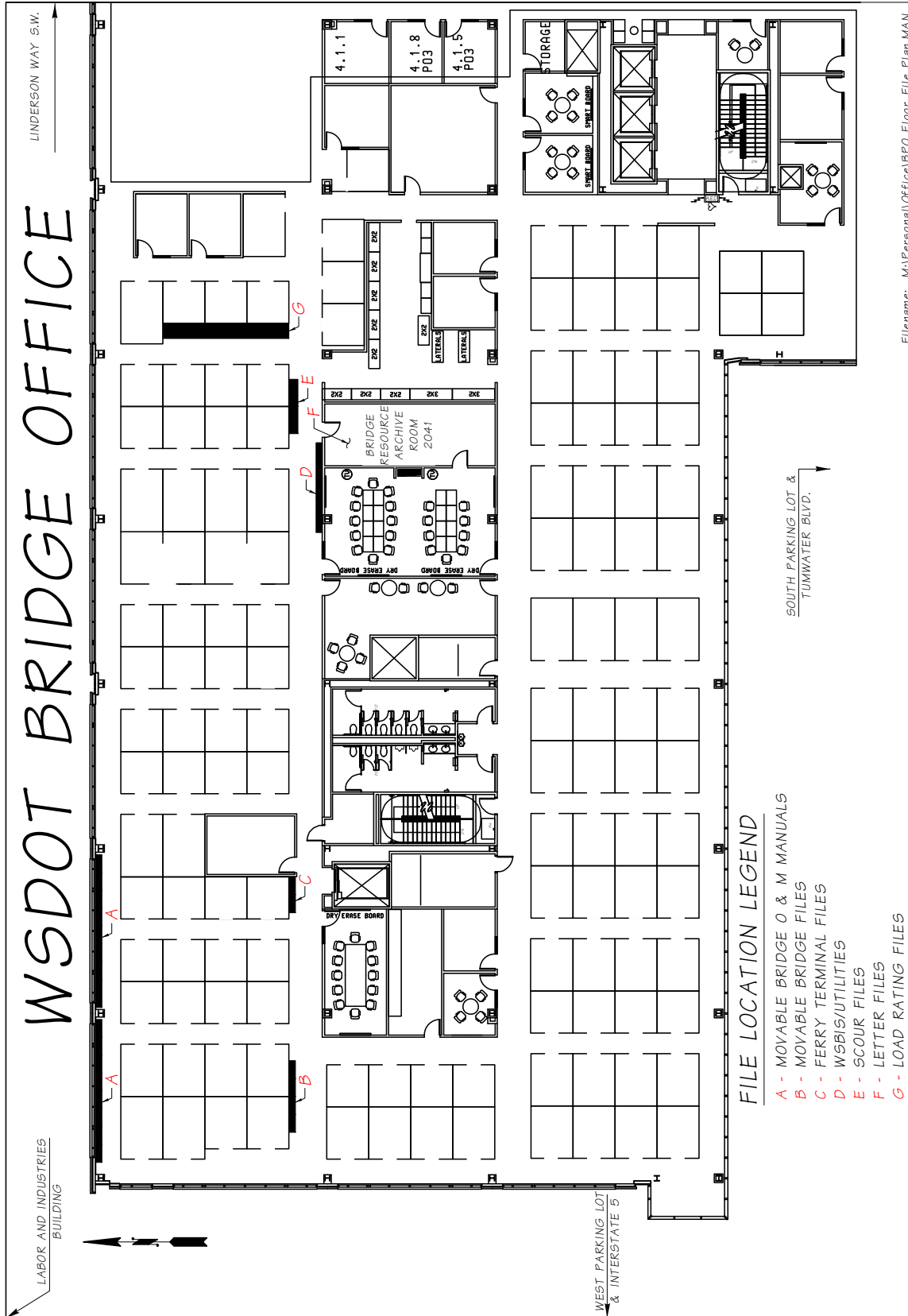

Filename: M:\Personal\Office\BPO Floor File Plan.MAN



Record Change Form

Record change requiring Statewide Program Manager (SPM) approval

Structure Identifier	Structure Number
Structure Name	Date of Record Change
This structure has been obsoleted <input type="checkbox"/> Yes <input type="checkbox"/> No	
If replaced with new structure, provide new structure identifier, number and name	
Is obsoleted structure demolished, moved, repurposed as pedestrian, or other? Describe	
This structure ownership has been transferred. <input type="checkbox"/> Yes <input type="checkbox"/> No	
If Yes: Transferred from _____ to _____	
If replaced with new structure, provide new structure identifier, number and name	
Agreement Number (attach signed agreement)	

Delegated Program Manager, if local agency record obsoleted

Date

Statewide Program Manager

Date

WSDOT Form 222-033 EF
Revised 10/9/2014

Appendix 2.06-C

Washington State Bridge Inventory System Coding Guide

WSBIS Item No.	WSBIS Item Name	FHWA Item No.	Page No.
Report Types Tab			
2920	Report Type		2.06-C-11
2921	Inspection Type		2.06-C-11
1990	Routine Inspection Date	90	
1991	Routine Inspection Frequency	91	
1991	Fracture Critical Inspection Frequency	92A	
1990	Fracture Critical Inspection Date	93A	
1991	Underwater Inspection Frequency	92B	
1990	Underwater Inspection Date	93B	
1991	Special Feature Inspection Frequency	92C	
1990	Special Feature Inspection Date	93C	
2646	Inspector Initials		2.06-C-12
2649	Inspector Certification Number		2.06-C-12
2654	Co-Inspector Initials		2.06-C-12
2642	Inspection Hours		2.06-C-12
2643	Inspection Overtime Hours		2.06-C-12
2900	Program Manager Oversight		2.06-C-12
NBI Tab			
1657	Structural Evaluation	67	2.06-C-14
1658	Deck Geometry	68	2.06-C-15
1659	Underclearances	69	2.06-C-18
1661	Alignment	72	2.06-C-19
1662	Waterway	71	2.06-C-20
1660	Operating Level	70	2.06-C-21
1293	Open, Closed or Posted	41	2.06-C-22
1663	Overall Deck Condition	58	2.06-C-24
1671	Superstructure Overall	59	2.06-C-25
2675	Number of Utilities		2.06-C-25
1676	Substructure Condition	60	2.06-C-26
1677	Channel Protection	61	2.06-C-27
1678	Culvert Condition	62	2.06-C-28
1679	Pier/Abutment Protection	111	2.06-C-30
1680	Scour	113	2.06-C-31
2610	Asphalt Depth		2.06-C-33
2611	Design Curb Height		2.06-C-33
2612	Bridge Rail Height		2.06-C-33
1684	Bridge Rails	36A	2.06-C-34
1685	Transitions	36B	2.06-C-36
1686	Guardrails	36C	2.06-C-37
1687	Terminals	36D	2.06-C-37
2688	Revise Rating Flag		2.06-C-37
2691	Photos Flag		2.06-C-37
2693	Soundings Flag		2.06-C-38
2694	Clearance Flag		2.06-C-38
2710	Sufficiency Rating		2.06-C-38

WSBIS Item No.	WSBIS Item Name	FHWA Item No.	Page No.
2711	Structurally Deficient/Functionally Obsolete		2.06-C-39
2614	Subject to NBIS Flag		2.06-C-40
2620	Bridge Account Manager – Work Order		2.06-C-41
2621	Bridge Account Manager – Cost Category		2.06-C-41
2622	Bridge Account Manager – Weekend		2.06-C-41
2623	Bridge Account Manager – Per Diem		2.06-C-41
Bridge ID Tab (formerly WB71)			
1001	Structure Identifier	8	2.06-C-43
2009	Bridge Number		2.06-C-44
2010	Bridge Sort Number		2.06-C-45
2400	Program Manager		2.06-C-45
1019	Owner	22	2.06-C-46
1021	County Code	3	2.06-C-47
2023	City		2.06-C-48
2132	Bridge Name		2.06-C-48
1156	Location (used for Main Listings)	9	2.06-C-48
2181	Section		2.06-C-49
2183	Township		2.06-C-49
2185	Range		2.06-C-49
1188	Latitude	16	2.06-C-49
1196	Longitude	17	2.06-C-49
Facilities Tab (formerly WB72)			
1232	Features Intersected	6	2.06-C-51
1256	Facilities Carried	7	2.06-C-51
1274	Region code	2	2.06-C-51
1276	FIPS Code	4	2.06-C-52
1285	Toll	20	2.06-C-52
1286	Custodian	21	2.06-C-53
1288	Parallel Structure	101	2.06-C-54
1289	Temporary Structure	103	2.06-C-54
1292	Historical Significance - NRHP	37	2.06-C-55
Layout Tab (Formerly WB73)			
1332	Year Built	27	2.06-C-57
1336	Year Rebuilt	106	2.06-C-57
1340	Structure Length	49	2.06-C-58
2346	NBIS Length		2.06-C-60
1348	Maximum Span Length	48	2.06-C-60
1352	Lanes On	28A	2.06-C-60
1356	Curb-to-Curb Width	51	2.06-C-61
1360	Out-to-Out Deck Width	52	2.06-C-62
1364	Sidewalk/Curb Width Left	50A	2.06-C-62
1367	Sidewalk/Curb Width Right	50B	2.06-C-63
1370	Minimum Vertical Clearance Over Deck	53	2.06-C-65
1374	Minimum Vertical Clearance Under Bridge	54B	2.06-C-66
1378	Vertical Underclearance Code	54A	2.06-C-67
1379	Minimum Lateral Underclearance Right	55B	2.06-C-67
1382	Lateral Underclearance Code	55A	2.06-C-70
1383	Minimum Lateral Underclearance Route Left	56	2.06-C-70
1386	Navigation Control	38	2.06-C-71

WSBIS Item No.	WSBIS Item Name	FHWA Item No.	Page No.
1387	Navigation Vertical Clearance	39	2.06-C-71
1390	Navigation Horizontal Clearance	40	2.06-C-72
1394	Vertical Lift Minimum Navigation Clearance	116	2.06-C-72
1397	Approach Roadway Width	32	2.06-C-74
1291	Median	33	2.06-C-73
1310	Skew	34	2.06-C-74
1312	Flared Flag	35	2.06-C-75
Crossing Tab (Formerly WB74)			
1432	Inventory Route On/Under	5A	2.06-C-77
1433	Inventory Route Highway Class	5B	2.06-C-78
1434	Inventory Route Service Level	5C	2.06-C-78
1435	Route	5D	2.06-C-78
2440	Milepost		2.06-C-79
2436	Route Sequencer		2.06-C-79
2437	Bridge List Milepost Override		2.06-C-79
2438	Milepost Sequencer		2.06-C-79
2468	Directional Indicator		2.06-C-79
2470	Ahead/Back Indicator		2.06-C-80
1467	Linear Referencing System Route	13A	2.06-C-80
1477	Linear Referencing System Sub Route	13B	2.06-C-80
1469	LRS Milepost	11	2.06-C-81
1483	National Highway System	104	2.06-C-81
1484	Base Highway Network	12	2.06-C-82
1485	STRAHNET Highway	100	2.06-C-82
1486	Federal Lands Highways	105	2.06-C-82
1487	Functional Classification	26	2.06-C-83
1489	National Truck Network	110	2.06-C-83
1490	Lane Use Direction	102	2.06-C-84
1354	Lanes Under	28B	2.06-C-84
1445	ADT	29	2.06-C-85
1451	ADT Truck Percentage	109	2.06-C-85
1453	ADT Year	30	2.06-C-85
1457	Future ADT	114	2.06-C-85
1463	Future ADT Year	115	2.06-C-86
1413	Detour Length	19	2.06-C-86
2410	Federally Reportable Flag		2.06-C-87
2411	Bridge List		2.06-C-87
1491	Horizontal Clearance, Route Direction	47	2.06-C-87
1495	Horizontal Clearance, Reverse Direction	47	2.06-C-88
1499	Maximum Vertical Clearance, Route Direction	10	2.06-C-89
2500	Minimum Vertical Clearance, Route Direction		2.06-C-90
2501	Maximum Vertical Clearance, Reverse Direction		2.06-C-90
2502	Minimum Vertical Clearance, Reverse Direction		2.06-C-90
1156	Location (used for Secondary Listings)	9	2.06-C-48
1157	Description (used for Secondary Listings)		2.06-C-91
2401	Crossing Manager		2.06-C-91

WSBIS Item No.	WSBIS Item Name	FHWA Item No.	Page No.
Design Tab (Formerly WB75)			
1532	Main Span Material	43A	2.06-C-93
1533	Main Span Design	43B	2.06-C-94
1535	Approach Span Material	44A	2.06-C-95
1536	Approach Span Design	44B	2.06-C-95
2537	Alphabetic Span Type		2.06-C-96
1538	Number of Main Spans	45	2.06-C-96
1541	Number of Approach Spans	46	2.06-C-97
1544	Service On	42A	2.06-C-97
1545	Service Under	42B	2.06-C-97
1546	Deck type	107	2.06-C-98
1547	Wearing Surface	108A	2.06-C-99
1548	Membrane	108B	2.06-C-99
1549	Deck Protection	108C	2.06-C-99
1550	Design Load	31	2.06-C-100
1551	Operating Rating Method	63	2.06-C-105
1552	Operating Rating Tons	64	2.06-C-106
1553	Operating Rating Factor	64	2.06-C-107
1554	Inventory Rating Method	65	2.06-C-107
1555	Inventory Rating Tons	66	2.06-C-107
1556	Inventory Rating Factor	66	2.06-C-107
1585	Border Bridge State Code	98A	2.06-C-108
1588	Border Bridge Percent	98B	2.06-C-108
1590	Border Bridge Structure Identifier	99	2.06-C-108
Prop Imp Tab (Formerly WB78)			
1844	Proposed Improvement Work Type	75A	2.06-C-109
1846	Proposed Improvement Work Method	75B	2.06-C-109
1847	Proposed Improvement Length	76	2.06-C-110
2853	Proposed Improvement Roadway Width		2.06-C-110
2860	Proposed Improvement Cost Per SF of Deck		2.06-C-110
1867	Proposed Improvement Structure Cost	94	2.06-C-110
1873	Proposed Improvement Roadway Cost	95	2.06-C-110
2870	Proposed Improvement Eng. and Misc. Cost		2.06-C-110
1861	Proposed Improvement Total Cost	96	2.06-C-111
1879	Proposed Improvement Estimate Year	97	2.06-C-111
2883	Proposed Improvement Calculation		2.06-C-111
Table of WSBIS Item Coding Requirements			
Table of WSBIS Item Database Definitions			

This list is sorted by WSBIS item number.

WSBIS Item No.	WSBIS Item Name	FHWA Item No.	Page No.
1001	Structure Identifier	8	2.06-C-43
1019	Owner	22	2.06-C-46
1021	County Code	3	2.06-C-47
1156	Location (used for Main Listings)	9	2.06-C-48
1156	Location (used for Secondary Listings)	9	2.06-C-48
1157	Description (used for Secondary Listings)		2.06-C-91
1188	Latitude	16	2.06-C-49
1196	Longitude	17	2.06-C-49
1232	Features Intersected	6	2.06-C-51
1256	Facilities Carried	7	2.06-C-51
1274	Region code	2	2.06-C-51
1276	FIPS Code	4	2.06-C-52
1285	Toll	20	2.06-C-52
1286	Custodian	21	2.06-C-53
1288	Parallel Structure	101	2.06-C-54
1289	Temporary Structure	103	2.06-C-54
1291	Median	33	2.06-C-73
1292	Historical Significance - NRHP	37	2.06-C-55
1293	Open, Closed or Posted	41	2.06-C-22
1310	Skew	34	2.06-C-74
1312	Flared Flag	35	2.06-C-75
1332	Year Built	27	2.06-C-57
1336	Year Rebuilt	106	2.06-C-57
1340	Structure Length	49	2.06-C-58
1348	Maximum Span Length	48	2.06-C-60
1352	Lanes On	28A	2.06-C-60
1354	Lanes Under	28B	2.06-C-84
1356	Curb-to-Curb Width	51	2.06-C-61
1360	Out-to-Out Deck Width	52	2.06-C-62
1364	Sidewalk/Curb Width Left	50A	2.06-C-62
1367	Sidewalk/Curb Width Right	50B	2.06-C-63
1370	Minimum Vertical Clearance Over Deck	53	2.06-C-65
1374	Minimum Vertical Clearance Under Bridge	54B	2.06-C-66
1378	Vertical Underclearance Code	54A	2.06-C-67
1379	Minimum Lateral Underclearance Right	55A	2.06-C-67
1382	Lateral Underclearance Code	55B	2.06-C-70
1383	Minimum Lateral Underclearance Route Left	56	2.06-C-70
1386	Navigation Control	38	2.06-C-71
1387	Navigation Vertical Clearance	39	2.06-C-71
1390	Navigation Horizontal Clearance	40	2.06-C-72
1394	Vertical Lift Minimum Navigation Clearance	116	2.06-C-72
1397	Approach Roadway Width	32	2.06-C-74
1413	Detour Length	19	2.06-C-86
1432	Inventory Route On/Under	5A	2.06-C-77
1433	Inventory Route Highway Class	5B	2.06-C-78
1434	Inventory Route Service Level	5C	2.06-C-78
1435	Route	5D	2.06-C-78
1445	ADT	29	2.06-C-85

WSBIS Item No.	WSBIS Item Name	FHWA Item No.	Page No.
1451	ADT Truck Percentage	109	2.06-C-85
1453	ADT Year	30	2.06-C-85
1457	Future ADT	114	2.06-C-85
1463	Future ADT Year	115	2.06-C-86
1467	Linear Referencing System Route	13A	2.06-C-80
1469	LRS Milepost	11	2.06-C-81
1477	Linear Referencing System Sub Route	13B	2.06-C-80
1483	National Highway System	104	2.06-C-81
1484	Base Highway Network	12	2.06-C-82
1485	STRAHNET Highway	100	2.06-C-82
1486	Federal Lands Highways	105	2.06-C-82
1487	Functional Classification	26	2.06-C-83
1489	National Truck Network	110	2.06-C-83
1490	Lane Use Direction	102	2.06-C-84
1491	Horizontal Clearance, Route Direction	47	2.06-C-87
1495	Horizontal Clearance, Reverse Direction	47	2.06-C-88
1499	Maximum Vertical Clearance, Route Direction	10	2.06-C-89
1532	Main Span Material	43A	2.06-C-93
1533	Main Span Design	43B	2.06-C-94
1535	Approach Span Material	44A	2.06-C-95
1536	Approach Span Design	44B	2.06-C-95
1538	Number of Main Spans	45	2.06-C-96
1541	Number of Approach Spans	46	2.06-C-97
1544	Service On	42A	2.06-C-97
1545	Service Under	42B	2.06-C-97
1546	Deck type	107	2.06-C-98
1547	Wearing Surface	108A	2.06-C-99
1548	Membrane	108B	2.06-C-99
1549	Deck Protection	108C	2.06-C-99
1550	Design Load	31	2.06-C-100
1551	Operating Rating Method	63	2.06-C-105
1552	Operating Rating Tons	64	2.06-C-106
1553	Operating Rating Factor	64	2.06-C-107
1554	Inventory Rating Method	65	2.06-C-107
1555	Inventory Rating Tons	66	2.06-C-107
1556	Inventory Rating Factor	66	2.06-C-107
1585	Border Bridge State Code	98A	2.06-C-108
1588	Border Bridge Percent	98B	2.06-C-108
1590	Border Bridge Structure Identifier	99	2.06-C-108
1657	Structural Evaluation	67	2.06-C-14
1658	Deck Geometry	68	2.06-C-15
1659	Underclearances	69	2.06-C-18
1660	Operating Level	70	2.06-C-21
1661	Alignment	72	2.06-C-19
1662	Waterway	71	2.06-C-20
1663	Overall Deck Condition	58	2.06-C-24
1671	Superstructure Overall	59	2.06-C-25
1676	Substructure Condition	60	2.06-C-26
1677	Channel Protection	61	2.06-C-27

WSBIS Item No.	WSBIS Item Name	FHWA Item No.	Page No.
1678	Culvert Condition	62	2.06-C-28
1679	Pier/Abutment Protection	111	2.06-C-30
1680	Scour	113	2.06-C-31
1684	Bridge Rails	36A	2.06-C-34
1685	Transitions	36B	2.06-C-36
1686	Guardrails	36C	2.06-C-37
1687	Terminals	36D	2.06-C-37
1844	Proposed Improvement Work Type	75A	2.06-C-109
1846	Proposed Improvement Work Method	75B	2.06-C-109
1847	Proposed Improvement Length	76	2.06-C-110
1867	Proposed Improvement Structure Cost	94	2.06-C-110
1873	Proposed Improvement Roadway Cost	95	2.06-C-110
1861	Proposed Improvement Total Cost	96	2.06-C-111
1879	Proposed Improvement Estimate Year	97	2.06-C-111
1990	Routine Inspection Date	90	
1990	Fracture Critical Inspection Date	93A	
1990	Underwater Inspection Date	93B	
1990	Special Feature Inspection Date	93C	
1991	Routine Inspection Frequency	91	
1991	Fracture Critical Inspection Frequency	92A	
1991	Underwater Inspection Frequency	92B	
1991	Special Feature Inspection Frequency	92C	
2009	Bridge Number		2.06-C-44
2010	Bridge Sort Number		2.06-C-45
2023	City		2.06-C-48
2132	Bridge Name		2.06-C-48
2181	Section		2.06-C-49
2183	Township		2.06-C-49
2185	Range		2.06-C-49
2346	NBIS Length		2.06-C-60
2400	Program Manager		2.06-C-45
2401	Crossing Manager		2.06-C-91
2410	Federally Reportable Flag		2.06-C-87
2411	Bridge List		2.06-C-87
2436	Route Sequencer		2.06-C-79
2437	Bridge List Milepost Override		2.06-C-79
2438	Milepost Sequencer		2.06-C-79
2440	Milepost		2.06-C-79
2468	Directional Indicator		2.06-C-79
2470	Ahead/Back Indicator		2.06-C-80
2500	Minimum Vertical Clearance, Route Direction		2.06-C-90
2501	Maximum Vertical Clearance, Reverse Direction		2.06-C-90
2502	Minimum Vertical Clearance, Reverse Direction		2.06-C-90
2537	Alphabetic Span Type		2.06-C-96
2610	Asphalt Depth		2.06-C-33
2611	Design Curb Height		2.06-C-33
2612	Bridge Rail Height		2.06-C-33
2614	Subject to NBIS Flag		2.06-C-40
2620	Bridge Account Manager – Work Order		2.06-C-41

WSBIS Item No.	WSBIS Item Name	FHWA Item No.	Page No.
2621	Bridge Account Manager – Cost Category		2.06-C-41
2622	Bridge Account Manager – Weekend		2.06-C-41
2623	Bridge Account Manager – Per Diem		2.06-C-41
2642	Inspection Hours		2.06-C-12
2643	Inspection Overtime Hours		2.06-C-12
2646	Inspector Initials		2.06-C-12
2649	Inspector Certification Number		2.06-C-12
2654	Co-Inspector Initials		2.06-C-12
2675	Number of Utilities		2.06-C-25
2688	Revise Rating Flag		2.06-C-37
2691	Photos Flag		2.06-C-37
2693	Soundings Flag		2.06-C-38
2694	Clearance Flag		2.06-C-38
2710	Sufficiency Rating		2.06-C-38
2711	Structurally Deficient/Functionally Obsolete		2.06-C-39
2853	Proposed Improvement Roadway Width		2.06-C-110
2860	Proposed Improvement Cost Per SF of Deck		2.06-C-110
2870	Proposed Improvement Eng. and Misc. Cost		2.06-C-110
2900	Program Manager Oversight		2.06-C-12
2920	Report Type		2.06-C-11
2921	Inspection Type		2.06-C-11

Coding Guide Instructions

1. Throughout this appendix, each item heading potentially has two parts. The text above the line is the WSBIS item number and name. The equivalent FHWA item number and name (if they exist) are below the line.
2. With the exception of WSBIS Item 1435 – Route Number, WSBIS does not record leading zeroes. When leading zeroes are required for FHWA items, they are added in the translation for the NBI submittal.
3. For any item, where WSDOT has created a set of codes that differ from the NBI codes, the code will be automatically translated for the NBI data submittal.
4. The following is a discussion of On and Under records.

Each bridge has data elements related to the structure. This data describes the bridge itself, including the structure type, quantities and dimensions, location, etc.

In addition, each bridge has data elements related to the roadway associated with the bridge. This data describes the roadway that is either on or under the structure, including route number, highway classifications, vertical and horizontal clearances, etc. This data is called a crossing record. A bridge will have either one or two National Bridge Inventory (NBI) reportable crossing records.

A bridge that carries vehicular traffic will have an On crossing record. This On record exists for any public roadway on the bridge, whether it is a state route or a local agency route.

A bridge that crosses a state route roadway, regardless of what is on the bridge, will have an Under crossing record in the Bridge Preservation Office (BPO) database. (A local agency may or may not have an Under crossing record for a state owned bridge that crosses a local route. That record would reside in the Local Programs database, not in the BPO database.)

For crossing records, a flag known as the Main Listing or Secondary Listing is used. All structure data elements are related to the Main Listing. A Secondary Listing, if it exists, is reported to the NBI in a record separate from the structure record. For state owned structures, Secondary Listings are coded by the BPO Information Group, and are displayed in the BridgeWorks application in Inventory Management mode.

The Structural Inventory and Appraisal (SI&A) sheet will display the data relevant to the structure and to the Main Listing. If a Secondary Listing exists, a second SI&A sheet will display only the data relevant to that crossing record.

State owned bridges that meet the NBIS definition, and are located over a state route, are reported to the NBI by BPO. This includes all the structural and inspection data, as well as the crossing record for the roadway on and the crossing record for the roadway under.

Local agency owned bridges that meet the NBIS definition, and are located over a state route, are reported to the NBI. The structural and inspection data, and the crossing record for the roadway on the bridge, are reported by the local agency. The crossing record for the roadway under the bridge is reported by BPO.

Bridges that do not meet the NBIS definition, but are located over a state route, are reported to the NBI but with a truncated amount of structural data, no inspection data, and the crossing record for the roadway under.

Examples:

Bridge 90/327 Schoessler Rd Over I-90 – This bridge has an On crossing record for Schoessler Rd (the Main Listing) and an Under crossing record for I-90 (the Secondary Listing). Both these records are reported to the NBI.

Bridge 90/531N I-90 Over Abbott Rd – This bridge has an On crossing record for I-90 (the Main Listing). There is not an Under crossing record for Abbott Rd. in the BPO database. The On crossing record is reported to the NBI.

Bridge 90/564P Pedestrian Br Over I-90 – This bridge has an Under crossing record for I-90 (the Main Listing). This crossing record is reported to the NBI.

Bridge 90/179.25 Schnebly Coulee – This bridge, a short span, has an On crossing record for I-90 (the Main Listing). This record is not reported to the NBI because short span bridges are not NBIS bridges. WSDOT maintains a crossing record by BPO policy.

For Main or Secondary Listing Under records, only the following items are submitted to the NBI:

Description	WSBIS Code	NBI Code	Description	WSBIS Code	NBI Code
Structure Identifier	1001	8	ADT On Inventory Route	1445	29
Location	1156	9	Truck ADT PCT	1451	109
Latitude	1188	16	ADT Year	1453	30
Longitude	1196	17	LRS Route	1467	13A
County Code	1021	3	LRS Sub Route	1477	13B
Features Intersected	1232	6A	LRS Milepost	1469	11
Facilities Carried	1256	7	National Highway System	1483	104
FIPS Place Code	1276	4	Base Highway Network	1484	12
Toll	1285	20	Strahnet	1485	100
Parallel Structure	1288	101	Fed Funct Class	1487	26
Temporary Structure	1289	103	National Truck Net	1489	110
Year Built	1332	27	Lane Use Direction	1490	102
Bridge Length	1340	49	Horizontal Clearance Route Dir	1491	47
Maximum Span Length	1348	48	Horizontal Clearance Reverse Dir	1495	47
Lanes On	1352	28A	Max Vertical Clearance Route Dir	1499	10
Lanes Under	1354	28B	Detour Length	1413	19
On/Under	1432	5A	Main Span Material	1532	43A
Highway Class	1433	5B	Main Span Design	1533	43B
Service Level	1434	5C	Service On	1544	42A
Route Number	1435	5D	Service Under	1545	42B

Report Types

WSBIS Item 2920 – Report Type

WSBIS Item 2921 – Inspection Type

Report Type	Code	Inspection Type	FHWA Item Number	
			Insp. Date	Insp. Freq.
Routine ¹	N/A		90	91
Fracture Critical	N/A		93A	92A
Underwater	N/A		93B	92B
Special Feature	1	Movable	93C	92C
	2	Floating	93C	92C
	3	Suspension	93C	92C
	4	Redundant Pin and Hanger	93C	92C
	5	Segmental	93C	92C
	6	Ferry Terminal	93C	92C
	7	High Strength Steel	93C	92C
	8	Structure with Temporary Support	93C	92C
	9	Cable Stayed	93C	92C
	0	Other	93C	92C
Interim	N/A		N/A	N/A
In-Depth	N/A		N/A	N/A
UW Interim	N/A		N/A	N/A
Equipment	N/A		N/A	N/A
Damage	A	Overheight	N/A	N/A
	E	Flood	N/A	N/A
	G	Earthquake	N/A	N/A
	O	Other	N/A	N/A
	R	Reported by Others	N/A	N/A
Safety	N/A		N/A	N/A
Short Span	N/A		N/A	N/A
2 Man UBIT	N/A		N/A	N/A
Informational	N/A		N/A	N/A
Inventory	N/A		N/A	N/A
Geometric	N/A		N/A	N/A

1. Routine report types are only used for NBIS bridges. If a bridge does not meet NBIS criteria, another report type must be used (usually Short Span or Safety report types).

Refer to Chapter 3 for more detailed descriptions of the Report Types.

WSBIS Item 2646 – Inspector Initials

(Cannot be null.)

These are the initials of the team leader at the bridge site performing the inspection for the designated report type.

WSBIS Item 2649 – Inspector Certification Number

(Cannot be null.)

This is the certification number of the team leader.

WSBIS Item 2654 – Co-Inspector Initials

(May be null only for Damage, Informational and Inventory report types.)

These are the initials of the individual who assisted the team leader in performing the inspection for the designated report type.

WSBIS Item 2642 – Inspection Hours

(Null only for Informational and Inventory report types.)

This is the total number of inspection hours (to the nearest half hour), excepting overtime hours, that the inspection team spent on the bridge while performing an inspection of the designated report type.

WSBIS Item 2643 – Inspection Overtime Hours

(Null unless overtime hours utilized during inspection.)

This is the total number of overtime inspection hours (to the nearest half hour) that the inspection team spent on the bridge while performing an inspection of the designated report type.

WSBIS Item 2900 – Program Manager Oversight

The Program Manager Oversight information is made of up the following three fields:

Late Inspection Explanation

For any NBI reportable inspection type, when an inspection is, or is to be, performed later than the calculated month due, an explanation must be provided for the delinquency.

Program Manager Response Date

Enter the date of the Program Manager's response to the Late Inspection Explanation.

Program Manager Approval

Enter a Y – Approved or N – Disapproved to indicate the Program Manager's response.

NBI

Adequacy Appraisals

WSBIS Items 1657, 1658, 1659, 1661, and 1662

FHWA Items 67, 68, 69, 71, and 72

The items in the appraisal section are used to evaluate a bridge in relation to the level of service which it provides on the highway system of which it is a part. The structure will be compared to a new one which is built to current standards for that particular type of road as further defined in this section except for WSBIS Item 1661 – Approach Roadway Alignment. See WSBIS Item 1661 for special criteria for rating that item.

WSBIS Items 1657, 1658, 1659, 1661, and 1662 will be coded with a 1-digit code that indicates the appraisal rating for the item. The ratings and codes are as follows:

WSBIS Code	NBI Code	Description
9	N	Not applicable
8	9	Superior to present desirable criteria
8	8	Equal to present desirable criteria
7	7	Better than present minimum criteria
6	6	Equal to present minimum criteria
5	5	Better than minimum tolerable limits
4	4	Meets minimum tolerable limits to be left in place as is
3	3	Basically intolerable requiring high priority corrective action
2	2	Basically intolerable requiring high priority replacement
1	1	This value of rating code not used
0	0	Bridge closed

WSBIS Items 1657, 1658, 1659 are calculated automatically based on other coded items.

Completed bridges not yet opened to traffic, if rated, shall be appraised as if open to traffic. Design values, for example ADT, shall be used for the evaluation. The data provided will include a code of G for WSBIS Item 1293 – Structure Open, Posted, or Closed to Traffic.

NBI Commentary:

WSBIS uses the 9 code to indicate “Not applicable,” which is translated to N when reported to the NBI. WSBIS uses code 8 for “Superior or equal to present desirable criteria,” which is a combination of NBI codes 8 and 9. (WSBIS does not submit a code 9 to the NBI.)

WSBIS Item 1657 Structural Evaluation**FHWA Item 67 Structural Evaluation**

This item is calculated automatically and cannot be edited.

Structural Evaluation rates the adequacy of the structure's condition, taking into account any major structural deficiencies. This rating is based on the overall condition of the superstructure, substructure, the inventory rating, and the ADT.

Table WSBIS-1657 explains how the inventory rating and Proposed Improvements may further lower this code. The code for this item is no higher than the lowest of the condition codes for Superstructure Overall, Substructure Condition, or Culvert Condition.

ADT			Structural Adequacy Appraisal Rating Code
0-500	501-5000	>5000	
Inventory Rating HS Truck (Tons)			
Not Applicable			9
36	36	36	8
31	31	31	7
23	25	27	6
18	20	22	5
12	14	18	4
Inventory rating less than value in rating code of 4 and requiring corrective action.			3
Inventory rating is less than above and bridge requires replacement (WSBIS Item 1844, Proposed Improvement Work Type, is coded 31 or 32).			2
Bridge is closed and requires replacement.			0

Structural Adequacy Appraisal Rating**Table WSBIS-1657**

NBI Commentary:

The use of the Proposed Improvement Work Type code in the calculation is not documented in the FHWA Coding Guide.

WSBIS Item 1658 – Deck Geometry

FHWA Item 68 – Deck Geometry

This item is calculated automatically and cannot be edited.

The level of service provided by the bridge is evaluated with respect to the highway system of which it is a part. This appraisal is based on the number of traffic lanes, the curb-to-curb width, the minimum vertical clearance over the bridge deck, the ADT, and the federal functional classification.

The following tables explain how the values are determined with respect to the highway system of which the bridge is a part. The lowest code determined from the tables is used.

Use this guide to determine which table to use.

Direction of Traffic	Number of Lanes	Curb to Curb Width	Table to Use
2 way non-interstate	3+		WSBIS-1658C
2 way non-interstate	2		WSBIS-1658A
2 way non-interstate	1	< 16'	WSBIS-1658B
2 way non-interstate	1	≥16'	WSBIS-1658A
1 way non-interstate	1		WSBIS-1658A
1 way non-interstate	2 or more		WSBIS-1658C
Ramp	any		WSBIS-1658D
1 way interstate	any		WSBIS-1658C
2 way interstate	any		WSBIS-1658C

For all bridges with a vertical clearance restriction over the deck, also use Table WSBIS-1658E. Use whichever rating code is lower.

Curb-to-Curb Bridge Roadway Width (in feet)						Deck Geometry Appraisal Rating Code
Average Daily Traffic (ADT) (both directions)						
0-100	101-400	401-1000	1001-2000	2001-5000	>5000	
Not Applicable						9
≥32	≥36	≥40	≥44	>44	>44	8
28	32	36	40	44	44	7
24	28	30	34	40	44	6
20	24	26	28	34	38	5
18	20	22	24	28	32(28)	4
16	18	20	22	26	30(26)	3
Bridge is open and has a width less than required for a rating code of 3.						2
Bridge is closed.						0

Notes:

- For bridges longer than 200 feet, use the values shown in parentheses.
- Use the lower rating code for roadway widths between those shown.

Deck Geometry Appraisal Rating

Table WSBIS-1658A

Curb-to-Curb Bridge Roadway Width (in feet)		Deck Geometry Appraisal Rating Code
Average Daily Traffic (ADT) (both directions)		
0-100	>100	
Not Applicable		9
<16	-	8
15	-	7
14	-	6
13	-	5
12	-	4
11	<16	3
Bridge is open and has a width less than required for a rating code of 3.		2
Bridge is closed.		0

Note:

1. Use the lower rating code for roadway widths between those shown.

Deck Geometry Appraisal Rating**Table WSBIS-1658B**

Curb-to-Curb Bridge Roadway Width (in feet) Two or More Lanes in Each Direction				Deck Geometry Appraisal Rating Code
Number of Lanes (N) (Interstate)		Number of Lanes (N) (Other Roadways)		
2 Lanes	> 2 Lanes	2 Lanes	> 2 Lanes	
Not Applicable				9
≥ 42	$\geq 12N + 24$	≥ 42	$\geq 12N + 18$	8
40	$12N + 20$	38	$12N + 15$	7
38	$12N + 16$	36	$12N + 12$	6
36	$12N + 14$	33	$11N + 10$	5
34 (29)	$11N + 12$ ($11N + 7$)	30	$11N + 6$	4
33 (28)	$11N + 11$ ($11N + 6$)	27	$11N + 5$	3
Bridge is open and has a width less than required for rating code of 3.				2
Bridge is closed.				0

Notes:

1. Use the lower rating code for roadway widths between those shown.
2. For bridges longer than 200 feet, use the values shown in parentheses.

Deck Geometry Appraisal Rating**Table WSBIS-1658C**

Curb-to-Curb Ramp Bridge Roadway Width (in feet)		Deck Geometry Appraisal Rating Code
Number of Lanes (N)		
1 Lane	> 1 Lane	
Not Applicable		9
≥ 26	≥ 12N + 12	8
24	12N + 10	7
22	12N + 8	6
20	12N + 6	5
18	12N + 4	4
16	12N + 2	3
Bridge is open and has deck width less than required for a rating code of 3.		2
Bridge is closed.		0

Notes:

- Use the lower rating code for a roadway width between those shown.

Deck Geometry Appraisal Rating**Table WSBIS-1658D**

Functional Class				Deck Geometry Appraisal Rating Code
Interstate and Other Freeway		Other Principal and Minor Arterials	Major and Minor Collectors and Locals	
Designated Routes*	Undesignated Routes*			
Minimum Vertical Clearance				
Not Applicable				9
≥ 17'0"	≥ 16'0"	≥ 16'6"	≥ 16'6"	8
16'9"	15'6"	15'6"	15'6"	7
16'6"	14'6"	14'6"	14'6"	6
15'8"	14'3"	14'3"	14'3"	5
15'0"	14'0"	14'0"	14'0"	4
Vertical clearance is less than value for rating of 4; corrective action is required.				3
Vertical clearance is less than value for rating of 4 and bridge requires replacement (WSBIS Item 1844, Proposed Improvement Work Type, is coded 31 or 32).				2
Bridge is closed.				0

Notes:

*Use the first column (Designated Routes) for all routes except designated routes in urban areas where there is an alternative interstate or freeway facility with a minimum clearance of at least 16' 0". Use the second column (Undesignated Routes) for all undesignated interstate or freeway facilities.

- Use the lower rating code for any vertical clearance measurements between those shown.

Deck Geometry Appraisal Rating**Table WSBIS-1658E**

WSBIS Item 1659 – Underclearances**FHWA Item 69 – Underclearances, Vertical and Horizontal**

This item is calculated automatically and cannot be edited.

This appraisal is based on the vertical and lateral underclearances beneath the bridge as related to the federal functional classification of the roadway carried beneath the bridge. If the bridge is not over a highway or a railroad, the field will be set to 9.

Minimum vertical underclearance, minimum lateral underclearance on right, and minimum lateral underclearance on left are used to evaluate this item.

See the following tables for an explanation of how the values are calculated.

The functional classification used in the tables is for the route under the bridge. If no Under record exists, it is assumed that the route under the bridge is a major or minor collector or a local road for the purpose of using the tables.

Functional Class					Underclearance Adequacy Appraisal Rating Code
Interstate and Other Freeway		Other Principal and Minor Arterials	Major and Minor Collectors and Locals	Railroads	
Designated Routes*	Undesignated Routes*				
Minimum Vertical Underclearance					
Not Applicable					9
≥ 17'0"	≥ 16'0"	≥ 16'6"	≥ 16'6"	≥ 23'0"	8
16'9"	15'6"	15'6"	15'6"	22'6"	7
16'6"	14'6"	14'6"	14'6"	22'0"	6
15'9"	14'3"	14'3"	14'3"	21'0"	5
15'0"	14'0"	14'0"	14'0"	20'0"	4
Vertical Clearance is less than value for rating of 4; corrective action is required.					3
Vertical clearance is less than value for rating of 4 and bridge requires replacement (WSBIS Item 1844, Proposed Improvement Work Type, is coded 31 or 32).					2
Bridge closed.					0

Notes:

*Use the first column (Designated Routes) for all routes except designated routes in urban areas where there is an alternative interstate or freeway facility with a minimum clearance of at least 16' 0". Use the second column (Undesignated Routes) for all undesignated interstate or freeway facilities.

1. Use the lower rating code for any vertical clearance measurements between those shown.

Vertical Underclearance Adequacy Appraisal Rating**Table WSBIS-1659A**

Functional Class							Underclearance Adequacy Appraisal Rating Code
1-Way Traffic				2-Way Traffic		Railroads	
Principal Arterials (Interstate, etc.)				Other Principal and Minor Arterials	Major and Minor Collectors and Locals		
Main Line		Ramp					
Lt.	Rt.	Lt.	Rt.				
Minimum Lateral Underclearance (Feet)							
Not Applicable							9
≥ 30	≥ 30	≥ 4	≥ 10	≥ 30	≥ 12	≥ 20	8
18	21	3	9	21	11	17	7
6	12	2	8	12	10	14	6
5	11	2	6	10	8	11	5
4	10	2	4	8	6	8	4
Underclearance is less than value for rating of 4; corrective action is required.							3
Underclearance is less than value for rating of 4 and bridge requires replacement (WSBIS Item 1844, Proposed Improvement Work Type, is coded 31 or 32).							2
Bridge is closed.							0

Notes:

1. Use the lower rating code for any underclearance measurements between those shown.
2. Use the value from the Right Ramp column to determine the rating code when acceleration or deceleration lanes or ramps are provided under 2-way traffic.

Lateral Underclearance Adequacy Appraisal Rating

Table WSBIS-1659B

WSBIS Item 1661 – Alignment

FHWA Item 72 – Approach Roadway Alignment

(Cannot be null.)

Code the rating based on the adequacy of the approach roadway alignment. This item identifies those bridges which do not function properly or adequately due to the alignment of the approaches. It is not intended that the approach roadway alignment be compared to current standards but rather to the existing highway alignment. This concept differs from other appraisal evaluations. The establishment of set criteria to be used at all bridge sites is not appropriate for this item. The basic criteria is how the alignment of the roadway approaches to the bridge relate to the general highway alignment for the section of highway the bridge is on.

Speed reductions necessary because of structure width and not alignment shall not be considered in evaluating this item.

Code	Description
9	Not applicable (non-vehicular traffic on the structure).
8	No reduction in speed required for vehicle as it approaches the bridge.
6	Minor reduction in speed required for vehicle (less than 10 mph) as it approaches the bridge.
3	Horizontal or vertical curvature of approach roadway requires substantial reduction in the speed of vehicle (10 mph or greater) as it approaches the bridge.

WSBIS Item 1662 – Waterway

FHWA Item 71 – Waterway Adequacy

(Cannot be null.)

This item appraises the waterway opening with respect to passage of flow through the bridge. Site conditions may warrant somewhat higher or lower ratings than indicated by the table (e.g., flooding of an urban area due to a restricted bridge opening).

Where overtopping frequency information is available, the descriptions given in the table for chance of overtopping mean the following:

- Remote – greater than 100 years
- Slight – 11 to 100 years
- Occasional – 3 to 10 years
- Frequent – less than 3 years

Adjectives describing traffic delays mean the following:

- Insignificant – Minor inconvenience. Highway passable within hours.
- Significant – Traffic delays of up to several days.
- Severe – Long term delays to traffic.

WSBIS Item 1487 – Functional Class			Description
01, 11, 12	02, 06, 07, 14, 16, 17	08, 09, 19	
Waterway Adequacy Appraisal Rating Code			
9	9	9	Bridge not over a waterway.
8	8	8	Bridge deck and roadway approaches above flood water elevations. Remote chance of overtopping. OR Bridge deck above roadway approaches. Slight chance of overtopping roadway approaches.
6	6	7	Slight chance of overtopping bridge deck and roadway approaches.
4	5	6	Bridge deck above roadway approaches. Occasional overtopping of roadway approaches with insignificant traffic delays.
3	4	5	Bridge deck above roadway approaches. Occasional overtopping of roadway approaches with significant traffic delays.
2	3	4	Occasional overtopping of bridge deck and roadway approaches with significant traffic delays.
2	2	3	Frequent overtopping of bridge deck and roadway approaches with significant traffic delays.
2	2	2	Occasional or frequent overtopping of bridge deck and roadway approaches with severe traffic delays.
0	0	0	Bridge closed.

Waterway Adequacy Appraisal Rating

Table WSBIS-1662

BPO Specific Instructions:

BPO inspection staff inspecting bridges with records maintained by BPO do not code this field, which is maintained by the BPO Scour Engineer. If an inspector has information relevant to this code, that information should be brought to the attention of the Scour Engineer and entered into the notes for this field under his/her direction.

NBI Commentary:

WSBIS uses the 9 code to indicate “Not applicable,” which is translated to N when reported to the NBI.

WSBIS Item 1660 – Operating Level

FHWA Item 70 – Bridge Posting*(Cannot be null.)*

The National Bridge Inspection Standards require the posting of load limits if the operating rating factor (RF) for any of the legal load configurations in the State is less than 1 based on the Load Factor Method (LFR) or the Allowable Stress Method (ASR); and less than 1 based on the Load and Resistance Factor Method. If the load capacity is such that posting is required, this item shall be coded 4 or less. If no posting is required at the operating rating, this item shall be coded 5.

This item evaluates the load capacity of a bridge in comparison to the State legal loads.

Although posting a bridge for load-carrying capacity is required only when the RF for any of the legal loads is less than 1, highway agencies may choose to post at a lower level. This posting practice may appear to produce conflicting coding when WSBIS Item 1293 – Structure Open, Posted or Closed to Traffic is coded to show the bridge as actually posted at the site and WSBIS Item 1660 – Bridge Posting is coded as bridge posting is not required. Since different criteria are used for coding these 2 items, this coding is acceptable and correct.

The use or presence of a temporary bridge affects the coding. The actual operating rating of the temporary bridge should be used to determine this item. However, the highway agency may choose to post at a lower level. This also applies to bridges shored up or repaired on a temporary basis.

The coding shall be based on the lowest rating factor of the legal loads.

The following are Washington State maximum legal load configurations and tonnages:

Configuration	Tonnage
AASHTO Type 3	25 Tons
AASHTO Type 3-2	36 Tons
AASHTO Type 3-3	40 Tons
SU4	27 Tons
SU5	31 Tons
SU6	34.7 Tons
SU7	38.7 Tons

See the Washington State *Bridge Design Manual* M 23-50 Chapter 13 for more information.

The Load Rating Engineer shall make the change to the code, and not the field inspector.

Code	Operating Rating Factors based on LFR or ASR Methods or Rating Factors based on LRFR
5	RF ≥ 1
4	1 < RF ≥ 0.9
3	0.9 < RF ≥ 0.8
2	0.8 < RF ≥ 0.7
1	0.7 < RF ≥ 0.6
0	0.6 < RF
N	No rating analysis performed (structure does not carry traffic)

NBI Commentary:

WSDOT added code N to address structures which do not carry traffic.

Text supplemented to explicitly list Washington State legal loads and tonnages.

WSBIS Item 1293 – Open, Closed or Posted**FHWA Item 41 – Structure Open, Posted, or Closed to Traffic**

(Cannot be null if bridge has an On record, must be null if the bridge does not have an On record.)

This item provides information about the actual operational status of a structure. One of the following codes shall be used:

Code	Description
A	Open, no restriction
B	Open, posting recommended but not legally implemented (all signs not in place or not correctly implemented)
D	Open, would be posted or closed except for temporary shoring, etc., to allow for unrestricted traffic
E	Open, temporary structure in place to carry legal loads while original structure is closed and awaiting replacement or rehabilitation
G	New structure not yet open to traffic
K	Bridge closed to all traffic
P	Posted for load (may include other restrictions such as temporary bridges which are load posted)
R	Posted for other load-capacity restriction (speed, number of vehicles on bridge, etc.)

Condition Ratings

WSBIS Items 1663, 1671, 1676, 1677, and 1678

FHWA Items 58, 59, 60, 61, and 62

In order to promote uniformity between bridge inspectors, these guidelines will be used to rate and code WSBIS Items 1663, 1671, 1676, 1677, and 1678.

Condition ratings are used to describe the existing, in-place bridge as compared to the as-built condition. Evaluation is for the materials related, physical condition of the deck, superstructure, and substructure components of a bridge. The condition evaluation of channels and channel protection and culverts is also included. Condition codes are properly used when they provide an overall characterization of the general condition of the entire component being rated. Conversely, they are improperly used if they attempt to describe localized or nominally occurring instances of deterioration or disrepair. Correct assignment of a condition code must, therefore, consider both the severity of the deterioration or disrepair and the extent to which it is widespread throughout the component being rated.

The load-carrying capacity will not be used in evaluating condition items. The fact that a bridge was designed for less than current legal loads and may be posted shall have no influence upon condition ratings.

Portions of bridges that are being supported or strengthened by temporary members will be rated based on their actual condition; that is, the temporary members are not considered in the rating of the item. (See WSBIS Item 1289 – Temporary Structure Designation for the definition of a temporary bridge.)

Completed bridges not yet opened to traffic, if rated, shall be coded as if open to traffic.

The following general condition ratings shall be used as a guide in evaluating WSBIS Items 1663, 1671 and 1676:

Code	Description
9	Not applicable
8	Very good condition – no problems noted.
7	Good condition – some minor problems.
6	Satisfactory condition – structural elements show some minor deterioration.
5	Fair condition – all primary structural elements are sound but may have minor section loss, cracking, spalling or scour.
4	Poor condition – advanced section loss, deterioration, spalling or scour.
3	Serious condition – loss of section, deterioration, spalling or scour have seriously affected primary structural components. Local failures are possible. Fatigue cracks in steel or shear cracks in concrete may be present.
2	Critical condition – advanced deterioration of primary structural elements. Fatigue cracks in steel or shear cracks in concrete may be present or scour may have removed substructure support. Unless closely monitored it may be necessary to close the bridge until corrective action is taken.
1	“Imminent” failure condition – major deterioration or section loss present in critical structural components or obvious vertical or horizontal movement affecting structure stability. Bridge is closed to traffic but corrective action may put back in light service.
0	Failed condition – out of service beyond corrective action.

NBI Commentary:

WSBIS uses the 9 code to indicate “Not applicable,” which is translated to N when reported to the NBI. WSDOT uses condition code 8 for all cases where a bridge is in “Excellent” or “Very good” condition.

WSBIS Item 1663 – Deck

FHWA Item 58 – Deck*(Cannot be null.)*

This item describes the overall condition rating of the deck. Rate and code the condition in accordance with the above general condition ratings.

The following structures shall be coded 9:

- Culverts
- Filled arch bridges
- Buried structures (bridges with fill depth greater than **B/2**, using **B** as defined in WSBIS Item 1340 Structure Length)

Bridges with fill depth less than **B/2** shall be considered to have a deck and coded appropriately.

Deck condition ratings are also associated with deck BMS elements as shown in WSBIM Chapter 4. If the inspector determines a deck code should be different from that indicated in Chapter 4 guidance, an explanation for this difference should be noted in the inspection report.

Concrete decks should be inspected for cracking, scaling, spalling, leaching, chloride contamination, potholing, delamination, and full or partial depth failures. Steel grid decks should be inspected for broken welds, broken grids, section loss, and growth of filled grids from corrosion. Timber decks should be inspected for splitting, crushing, fastener failure, and deterioration from rot.

The condition of the wearing surface/protective system, joints, expansion devices, curbs, sidewalks, parapets, fascias, bridge rail, and scuppers shall not be considered in the overall deck evaluation. However, their condition should be noted on the inspection form under the appropriate BMS element note.

Decks integral with the superstructure will be rated as a deck only and not how they may influence the superstructure rating (for example, rigid frame, slab, deck girder or T-beam, voided slab, box girder, etc.). Similarly, the superstructure of an integral deck type bridge will not influence the deck rating.

Inspection report comments are required when the condition is coded 5 or less.

NBI Commentary:

This item has been modified to incorporate BMS deck element condition states into the coding criteria.

WSBIS Item 1671 – Superstructure

FHWA Item 59 – Superstructure

(Cannot be null.)

This item describes the physical condition of all structural members. Rate and code the condition in accordance with the previously described general condition ratings. Code 9 for culverts.

The structural members should be inspected for signs of distress which may include cracking, deterioration, section loss, and malfunction and misalignment of bearings.

The condition of bearings, joints, paint system, etc., shall not be included in this rating, except in extreme situations, but should be noted on the inspection form under the appropriate BMS element note.

On bridges where the deck is integral with the superstructure, the superstructure condition rating may be affected by the deck condition. The resultant superstructure condition rating may be lower than the deck condition rating where the girders have deteriorated or been damaged.

Fracture critical components should receive careful attention because failure could lead to collapse of a span or the bridge.

Inspection report comments are required when the condition is coded 5 or less.

WSBIS Item 2675 – Number of Utilities

(Null only when there is no On record associated with the bridge.)

This field indicates the number of franchise utilities attached to the bridge. Utilities include, but are not limited to, water pipes, sewer lines, telephone lines, power lines, and gas lines. Conduit for electricity used on the bridge is not considered a utility. A conduit cluster (e.g., a telephone cluster) is considered one utility. This field is not used to evaluate the condition of utilities on the bridge, only the number of utilities present. If more than nine utilities are attached to the bridge, code 9. If there are no utilities, code 0.

WSBIS Item 1676 – Substructure

FHWA Item 60 – Substructure

(Cannot be null.)

This item describes the physical condition of piers, abutments, piles, fenders, footings, or other components. Rate and code the condition in accordance with the previously described general condition ratings. Code 9 for culverts.

All substructure elements should be inspected for visible signs of distress including evidence of cracking, section loss, settlement, misalignment, scour, collision damage, and corrosion.

The substructure condition rating shall be made independent of the deck and superstructure.

Integral-abutment wingwalls to the first construction or expansion joint shall be included in the evaluation. For non-integral superstructure and substructure units, the substructure shall be considered as the portion below the bearings. For structures where the substructure and superstructure are integral, the substructure shall be considered as the portion below the superstructure.

In all cases, if WSBIS Item 1680 – Scour is 2 or less, WSBIS Item 1676 – Substructure shall be coded the same.

Inspection report comments are required when the condition is coded 5 or less.

NBI Commentary:

This item has been modified based on an April 27, 2001, FHWA memo regarding FHWA Items 60 and 113 (WSBIS Items 1676 and 1680). This memo is available at www.fhwa.dot.gov/engineering/hydraulics/policymemo/revguide.cfm.

WSBIS Item 1677 – Channel Protection

FHWA Item 61 – Channel and Channel Protection*(Cannot be null.)*

This item describes the physical conditions associated with the flow of water through the bridge such as stream stability and the condition of the channel, riprap, slope protection, or stream control devices including spur dikes. The inspector should be particularly concerned with visible signs of excessive water velocity which may affect undermining of slope protection, erosion of banks, and realignment of the stream. Accumulation of drift and debris on the superstructure and substructure should be noted on the inspection form but not included in the condition rating.

Inspection report comments are required when the condition is coded 7 or less.

Note: A bridge with no scour potential (piles founded or on bedrock) can have a very low channel rating based on a threat to the approach fill. In this situation this code is the only way to flag the problem. Also note that roadway embankment erosion due to bridge or roadway runoff is NOT included in this field. These issues are addressed in the abutment BMS field.

Rate and code the condition in accordance with the following descriptive codes:

Code	Description
9	Not applicable. Use when bridge is not over a waterway (channel).
8	There are no noticeable or noteworthy deficiencies. Banks are protected or well vegetated. River control devices such as spur dikes and embankment protection are not required or are in a stable condition.
7	Bank protection is in need of minor repairs. River control devices and embankment protection have a little minor damage. Banks and/or channel have minor amounts of drift.
6	Bank is beginning to slump. River control devices and embankment protection have widespread minor damage. There is minor stream bed movement evident. Debris is restricting the channel slightly.
5	Bank protection is being eroded. River control devices and/or embankment have major damage. Trees and brush restrict the channel.
4	Bank and embankment protection is severely undermined. River control devices have severe damage. Large deposits of debris are in the channel.
3	Bank protection has failed. River control devices have been destroyed. Stream bed aggradation, degradation or lateral movement has changed the channel to now threaten the bridge and/or approach roadway.
2	The channel has changed to the extent the bridge is near a state of collapse.
1	Bridge closed because of channel failure. Corrective action may put back in light service.
0	Bridge closed because of channel failure. Replacement necessary.

WSBIS Item 1678 – Culvert

FHWA Item 62 – Culverts*(Cannot be null.)*

This item evaluates the alignment, settlement, joints, structural condition, scour, and other items associated with culverts. The rating code is intended to be an overall condition evaluation of the culvert. Integral wingwalls to the first construction or expansion joint shall be included in the evaluation.

Inspection report comments are required when the condition is coded 5 or less.

Defining culverts:

- Any structure subject to the NTIS shall not be coded as a culvert but rather as a tunnel.
- Culverts always carry water, to distinguish them from tunnels which never carry water. There is one exception: if a tunnel-like structure is subject to NBIS based on the roadway above and the clear span, but is NOT subject to NTIS, it shall be coded as a culvert even if it doesn't carry water.
- Tunnel-like pedestrian or animal undercrossings not subject to either the NTIS or NBIS shall be coded as tunnels, not culverts.
- Detention Vaults shall be coded as culverts.
- Concrete Boxes (continuous 4-sided) with or without roadway fill that carry water are coded as culverts.
- Circular and arch shaped structures with fill that carry water are coded as culverts.
- Other structures that carry water with a fill depth greater than B/2 (using B as defined in WSBIS Item 1340 Structure Length) shall be considered buried structures and are coded as culverts. For the purpose of this guideline, fill depth shall be the minimum depth under the roadway including the usable shoulders.
- For Culverts, code Deck, Superstructure and Substructure (WSBIS Items 1663, 1671, and 1676) as 9.
- Code Bridge Rails and Transitions (WSBIS Items 1684 and 1685) N if there is sufficient roadway fill that there is no attachment to the structure. Guardrails and Terminals (WSBIS Items 1686 and 1687) are to be coded 0 or 1 as appropriate.
- When inspecting culverts, document the depth of the fill on both ends of the culvert. For cases where there is a significant amount of fill compared to the span length of the culvert, or total length of culverts where there are multiple barrels, estimate and document the depth of fill.

Rate and code the condition in accordance with the following descriptive codes:

Code	Description
9	Not applicable. Bridge is not a culvert.
8	No noticeable or noteworthy deficiencies which affect the condition of the culvert. Insignificant scrape marks caused by drift.
7	Shrinkage cracks, light scaling, and insignificant spalling which does not expose reinforcing steel. Insignificant damage caused by drift with no misalignment and not requiring corrective action. Some minor scouring has occurred near curtain walls, wingwalls or pipes.
6	Minor deterioration or initial disintegration, minor chloride contamination, minor cracking with some leaching, or spalls on concrete or masonry walls and slabs. Local minor scouring at curtain walls, wingwalls or pipes.
5	Moderate to major deterioration or disintegration, extensive cracking and leaching, or spalls on concrete or masonry walls and slabs. Minor settlement or misalignment. Noticeable scouring or erosion at curtain walls, wingwalls or pipes.
4	Major deterioration (large spalls, heavy scaling, wide cracks, considerable efflorescence, or opened construction joint permitting loss of backfill). Considerable settlement or misalignment. Considerable scouring or erosion at curtain walls, wingwalls or pipes.
3	Excessive deterioration (any condition described in Code 4 but which is excessive in scope). Severe movement or differential settlement of the segments, or loss of fill. Holes may exist in walls or slabs. Integral wingwalls nearly severed from culvert. Severe scour or erosion at curtain walls, wingwalls or pipes.
2	Integral wingwalls collapsed, severe settlement of roadway due to loss of fill. Section of culvert may have failed and can no longer support embankment. Complete undermining at curtain walls and pipes. Corrective action required to maintain traffic.
1	Bridge closed – corrective action may put back in light service.
0	Bridge closed – replacement necessary.

Rating for Concrete Culverts

Table WSBIS-1678A

Code	Description
9	Not applicable. Bridge is not a culvert.
8	No noticeable or noteworthy deficiencies which affect the condition of the culvert. Insignificant scrape marks caused by drift. Bolts are in good condition, in place and tight.
7	Insignificant damage caused by drift with no misalignment and not requiring corrective action. Some minor scouring has occurred near wingwalls or pipes. Smooth, symmetrical curvature with superficial corrosion and no pitting. Bolts may have superficial corrosion, are in place and tight.
6	Smooth curvature, non-symmetrical shape, and significant corrosion or moderate pitting. Bolts may have significant corrosion and 10 percent of the bolts in a panel seam may be missing or loose. Local minor scouring at wingwalls or pipes.
5	Minor settlement or misalignment. Noticeable scouring or erosion at wingwalls or pipes. Significant distortion and deflection in one section. Significant corrosion or deep pitting. Bolts may have significant corrosion and 20 percent of the bolts in a panel seam may be missing or loose.
4	Considerable settlement or misalignment. Considerable scouring or erosion at wingwalls or pipes. Significant distortion and deflection throughout. Extensive corrosion or deep pitting. Bolts may have extensive corrosion and 30 percent of the bolts in a panel seam may be missing or loose.
3	Any condition described in Code 4 but which is excessive in scope. Severe movement or differential settlement of the segments, or loss of fill. Wingwalls nearly severed from culvert. Severe scour or erosion at wingwalls or pipes. Extreme distortion and deflection in one section. Extensive corrosion or deep pitting with scattered perforations. Bolts may have extensive corrosion and 40 percent of the bolts in a panel seam may be missing or loose.
2	Wingwalls collapsed, severe settlement of roadway due to loss of fill. Section of culvert may have failed and can no longer support embankment. Complete undermining at curtain walls and pipes. Corrective action required to maintain traffic. Extreme distortion and deflection throughout with extensive perforations due to corrosion. Bolts may have extensive corrosion and 50 percent of the bolts in a panel seam may be missing or loose.
1	Bridge closed – corrective action may put back in light service.
0	Bridge closed – replacement necessary.

Rating for Metal Culverts

Table WSBIS-1678B

Code	Description
9	Not applicable. Bridge is not a culvert.
8	No noticeable or noteworthy deficiencies which affect the condition of the culvert. Insignificant scrape marks caused by drift.
7	Insignificant damage caused by drift with no misalignment and not requiring corrective action. Some minor scouring has occurred near curtain walls, wingwalls, Insignificant decay with no structural loss.
6	Minor deterioration or decay. All primary structural elements are sound. Local minor scouring at curtain walls or wingwalls.
5	Moderate deterioration or decay. All primary structural elements are sound but have some section loss. Minor settlement or misalignment. Noticeable scouring or erosion at curtain walls or wingwalls.
4	Major deterioration or decay. Considerable scour or erosion at curtain walls or wingwalls. Advanced section loss or scour that affects the load capacity of the structure. Considerable settlement or misalignment.
3	Any condition described in Code 4 but which is excessive in scope. Severe movement or differential settlement of the segments, or loss of fill. Wingwalls nearly severed from culvert. Severe scour or erosion at curtain walls or wingwalls. Extensive deterioration or decay. Advanced section loss or scour that significantly affects the load capacity of the structure.
2	Severe deterioration or decay. Wingwalls collapsed, severe settlement of roadway due to loss of fill. Section of culvert may have failed and can no longer support embankment. Complete undermining at curtain walls. Corrective action required to maintain traffic. Critical structural members have obvious vertical or horizontal movement affecting structural stability.
1	Bridge closed – corrective action may put back in light service.
0	Bridge closed – replacement necessary.

Rating for Timber Culverts
Table WSBIS-1678C

WSBIS Item 1679 – Pier/Abutment Protection

FHWA Item 111 – Pier or Abutment Protection (for Navigation)

(Cannot be null.)

If WSBIS Item 1386 – Navigation Control has been coded 1, use the codes **1 through 5** below to indicate the presence and adequacy of pier or abutment protection features such as fenders, dolphins, etc. The condition of the protection devices may be a factor in the overall evaluation of WSBIS Item 1676 – Substructure.

If WSBIS Item 1386 is coded 0, code N for this field.

WSDOT Code	NBI Code	Description
1	1	Navigation protection not required
2	2	In place and functioning
3	3	In place but in a deteriorated condition
4	4	In place but reevaluation of design suggested
5	5	None present but reevaluation suggested
N	[blank]	Not applicable, not a navigable waterway

NBI Commentary:

WSDOT codes N where the NBI codes a blank. This field is translated in the NBI text file.

WSBIS Item 1680 – Scour**FHWA Item 113 – Scour Critical Bridges***(Cannot be null.)*

Code as indicated below to identify the current status of the bridge regarding its vulnerability to scour:

Code	Description
N	Bridge not over waterway.
U	Bridge with unknown foundation that has not been evaluated for scour. Until risk can be determined, a plan of action should be developed and implemented to reduce the risk to users from a bridge failure during or immediately after a flood event (see HEC 23).
T	Bridge over tidal waters that has not been evaluated for scour, but considered low risk. Bridge will be monitored with regular inspection cycle and with appropriate underwater inspections. (Unknown foundations in tidal waters should be coded U.)
9	Bridge foundations (including piles) on dry land well above flood water elevations.
8	Bridge foundations determined to be stable for the assessed or calculated scour conditions. Scour is determined to be above top of footing (Example A) by: <ul style="list-style-type: none"> • assessment (e.g., bridge foundations are on rock formations that have been determined to resist scour within the service life of the bridge), or • calculation, or • installation of properly designed countermeasures (see HEC 23).
7	Countermeasures have been installed to mitigate an existing problem with scour and to reduce the risk of bridge failure during a flood event. Instructions contained in a plan of action have been implemented to reduce the risk to users from a bridge failure during or immediately after a flood event.
6	Scour calculation/evaluation has not been made.
5	Bridge foundations determined to be stable for assessed or calculated scour conditions. Scour is determined to be within the limits of footing or piles (Example B) by: <ul style="list-style-type: none"> • assessment (e.g., bridge foundations are on rock formations that have been determined to resist scour within the service life of the bridge), or • calculations, or • installation of properly designed countermeasures (see HEC 23).
4	Bridge foundations determined to be stable for assessed or calculated scour conditions; field review indicates action is required to protect exposed foundations (see HEC 23).
3	Bridge is scour critical; bridge foundations determined to be unstable for assessed or calculated scour conditions: <ul style="list-style-type: none"> • Scour within limits of footing or piles (Example B) • Scour below spread-footing base or pile tips (Example C)
2	Bridge is scour critical; field review indicates that extensive scour has occurred at bridge foundations, which are determined to be unstable by: <ul style="list-style-type: none"> • a comparison of calculated scour and observed scour during the bridge inspection, or • an engineering evaluation of the observed scour condition reported by the bridge inspector in WSBIS Item 1676 – Substructure.
1	Bridge is scour critical; field review indicates that failure of piers/abutments is imminent. Bridge is closed to traffic. Failure is imminent based on: <ul style="list-style-type: none"> • a comparison of calculated and observed scour during the bridge inspection, or • an engineering evaluation of the observed scour condition reported by the bridge inspector in WSBIS Item 1676 – Substructure.
0	Bridge is scour critical. Bridge has failed and is closed to traffic.

These codes are generally determined based on scour analyses made by hydraulic, geotechnical, or structural engineers. However, bridge inspectors play a key role in determining selected scour codes:

- Scour code 4 can be determined by the bridge inspector regardless of any previous higher scour code, based on observed conditions.
- For scour codes of 2 or less, the WSBIS Item 1676 – Substructure code must have a matching code.

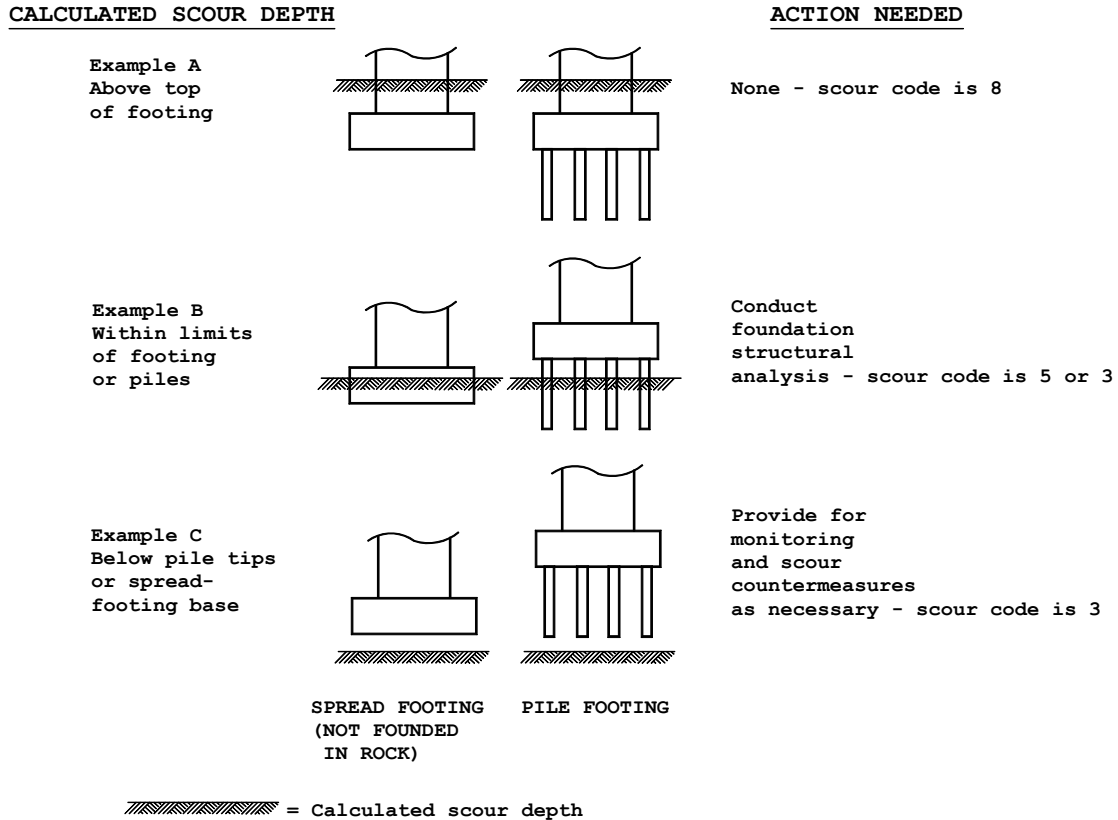

Figure WSBIS-1680

NBI Commentary:

This item has been modified based on an April 27, 2001 FHWA memo regarding FHWA Items 60 and 113 (WSBIS Items 1676 and 1680). This memo is available at www.fhwa.dot.gov/engineering/hydraulics/policymemo/revguide.cfm.

WSBIS Item 2610 – Asphalt Depth**(XX.XX inches)**

(Null only when there is no On record associated with the bridge.)

Code the average depth of asphalt in inches on the deck as observed from field measurements, or as determined from comparing the design curb height against the measured curb height from the top of asphalt. **In cases where there is ballast, such as on timber decks, enter the full thickness of ballast and asphalt.**

Code 0 when:

There is no asphalt on the deck.

When the structure does not have a deck, including when asphalt pavement is placed on fill over a culvert. In cases where there is ballast, such as on timber decks, enter the full thickness of ballast and asphalt.

WSBIS Item 2611 – Design Curb Height**(XX.XX inches)**

(Null only when there is no On record associated with the bridge.)

Code the curb height shown on current bridge plans in inches. Code 0 when there is no curb.

WSBIS Item 2612 – Bridge Rail Height**(XX.XX inches)**

(Null only when there is no On record associated with the bridge.)

Code the rail height as measured in the field, from the top of the rail system to the bridge deck.

WSBIS Items 1684, 1685, 1686, 1687 – Traffic Safety**FHWA 36 – Traffic Safety Features**

(Cannot be null.)

Bridge inspection shall include the recording of information on traffic safety features so that the evaluation of their adequacy can be made.

Use the following codes for each of the four traffic safety segments:

Code	Description
0	Inspected feature does not meet currently acceptable standards or a safety feature is required and none is provided.
1	Inspected feature meets currently acceptable standards.
N	Not applicable (structure does not carry traffic) or a safety feature is not required (see item description for requirements).

NBI Commentary:

WSDOT has applied state safety standards to determine how these fields are coded.

WSBIS Item 1684 – Bridge Rails

FHWA 36A – Traffic Safety Features, Bridge Railings

Bridge railings should be coded to reflect the current WSDOT standards. Refer to *Design Manual M 22-01*, Section 1610.04(3) Bridge Traffic Barriers.

Acceptable crash tested bridge rails fall into two general categories.

Thrie-beam Retrofit

- Thrie-beam mounted to baluster rail
- Steel truss and Thrie-beam
- Edge mounted Thrie-beam
- Thrie-beam mounted to steel posts on concrete deck
- Thrie-beam mounted to open girder

Concrete Rail

- New Jersey style rail
- F-shaped concrete rail
- Single slope concrete rail
- 32” vertical concrete parapet
- Type 7 concrete rail

Bridge rails are coded as N when there is sufficient roadway fill that there is no attachment to the structure.

THRIE BEAM RETROFIT

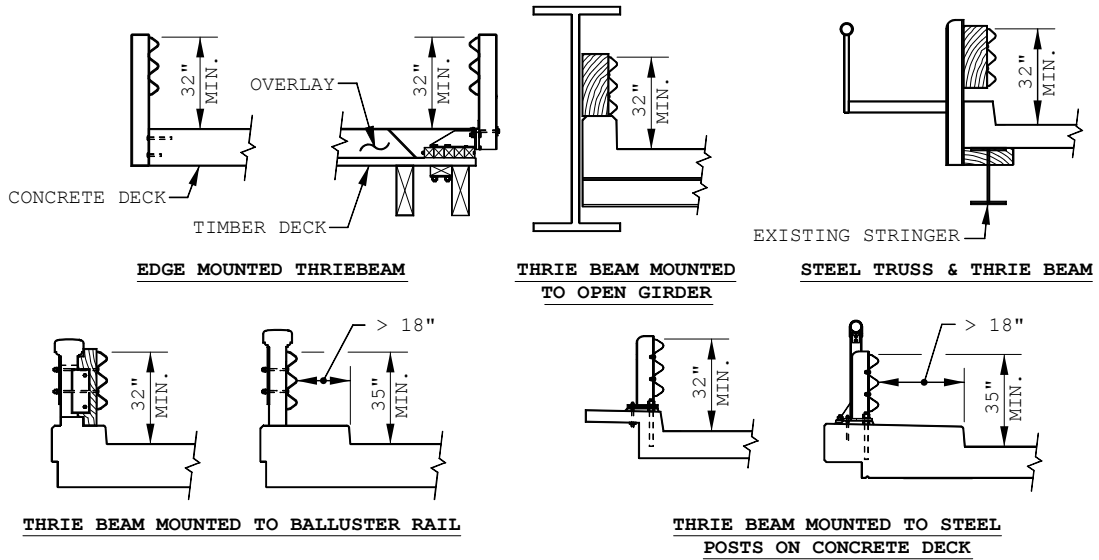

CONCRETE RAIL

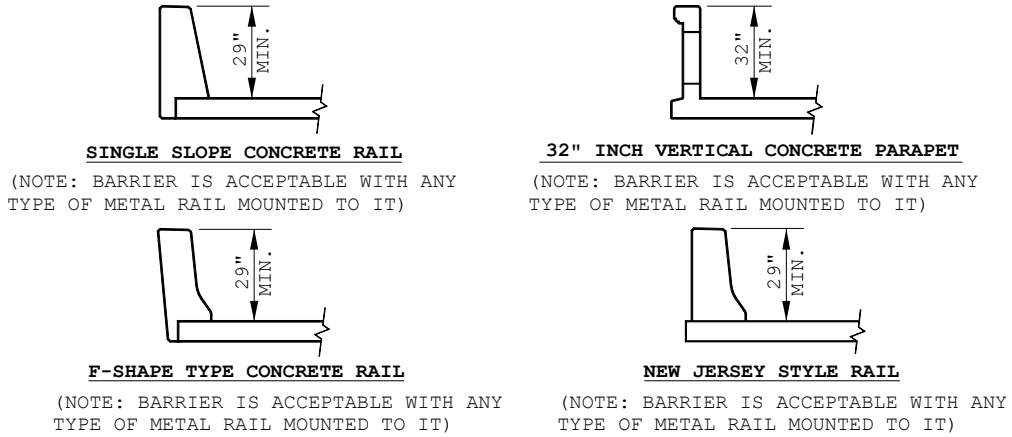

TYPE 7 BRIDGE RAIL

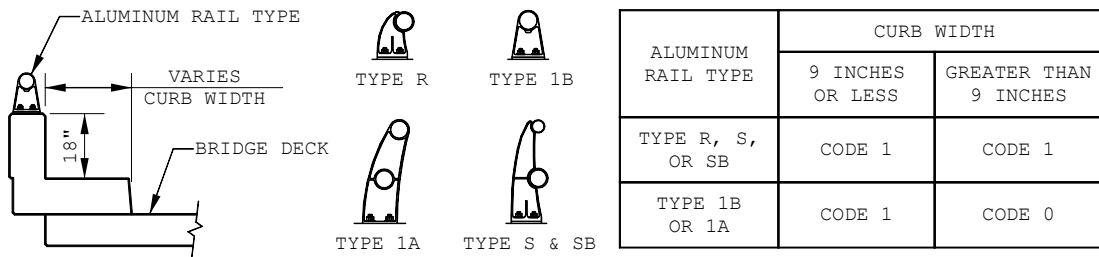

Figure WSBIS-1684

WSBIS Item 1685 – Transitions

FHWA 36B – Traffic Safety Features, Transitions

Transition details are shown in WSDOT Standard Plans **Section C**. Features that the inspector should note are:

- If guardrails are not required, the absence of transitions is automatically acceptable and coded as 1.
- Transitions must be nested (two layers). In most cases this will be Thriebeam. W-beam is allowed only when there is insufficient bridge rail height to accommodate the Thrie-beam transition, **for example Type 7 bridge rail**.
- Post spacing should decrease in the transition resulting in gradual stiffening as a vehicle moves along the transition from a flexible guardrail to the more rigid concrete bridge rail.
- Type III transitions (hollow steel post) have generally been retrofitted, but are only acceptable if they have been retrofitted with a block out **less than or equal to 1' – 6" from rail to anchor**. On oneway highways, the non-retrofitted posts are acceptable on the trailing edge. Unless further investigation shows that it meets current standards, this is the criteria for acceptance that will be used.
- Transitions are coded as N when there is sufficient roadway fill that there is no attachment to the structure.

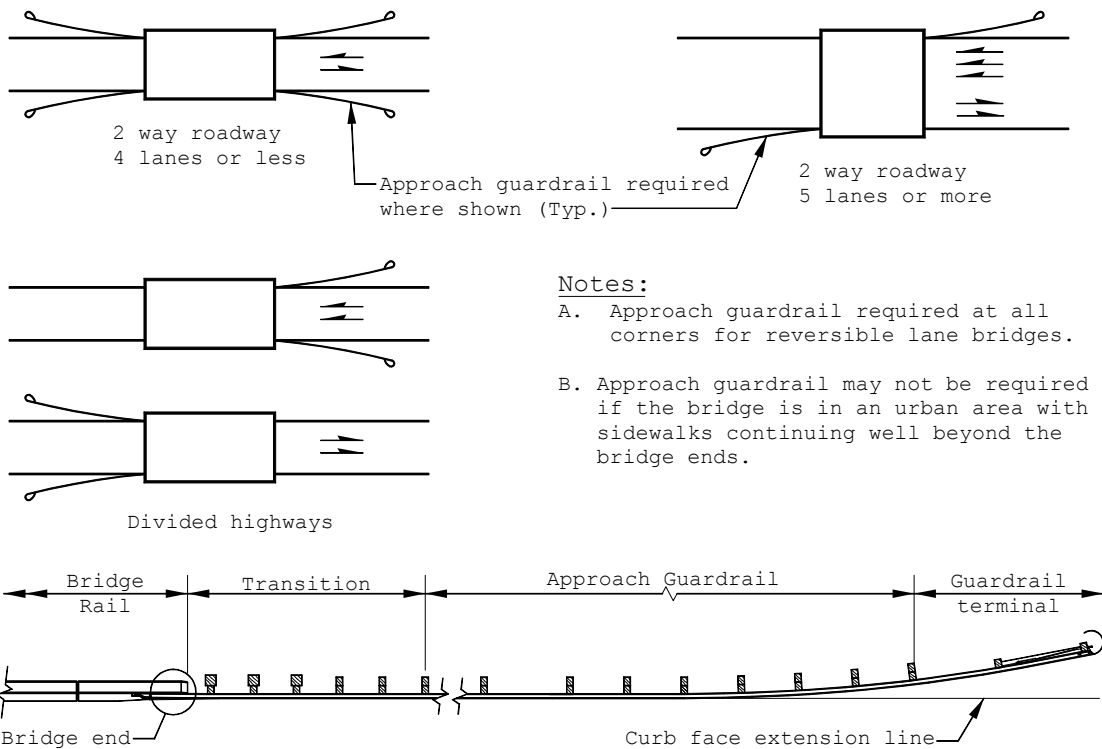

Figure WSBIS-1685

WSBIS Item 1686 – Guardrails

FHWA 36C – Traffic Safety Features, Approach Guardrail

W-beam and Thrie-beam are acceptable rail types. Details of these rails are shown in Standard Plans **Section C**. Features that the inspector should pay close attention to while inspecting the approach rail are:

- Rails are not necessarily required at all four corners of the bridge. Code Guardrails as 1 when not required.
- Posts should be 6" x 8" timber (nominal), or W6x9's, spaced at 6' 3" o.c. Nested Thrie-beam is also acceptable but requires lower post spacing.
- Guardrail height (from ground to top of W-beam) should be between 26" and 28".
- Guardrail height (from ground to top of Thrie-beam) should be 32".
- Concrete rail is acceptable.

WSBIS Item 1687 – Terminals

FHWA 36D – Traffic Safety Features, Approach Guardrail Ends

- Terminals are to be coded as 1 or 0 if they are within a reasonable distance of the bridge. On a fill embankment, this would be near the bottom of the fill slope (*Design Manual M 22-01*). Otherwise they will be coded as an N.
- If guardrails are not required, the absence of terminals is automatically acceptable and coded as 1.
- Acceptable guardrail terminals are shown in the Washington State Standard Plans **Section C** or *Design Manual M 22-01*.

WSBIS Item 2688 – Revise Rating Flag

This code indicates whether or not the bridge should be reviewed for a revised rating based on field conditions. A note shall be added by the inspector identifying the reason/condition that prompts reevaluation of the load rating.

- | | |
|---|---|
| Y | Yes, review rating |
| * | Null field, rating review is not required |

See Section 5.02.

WSBIS Item 2691 – Photos Flag

This code indicates whether or not the bridge needs photos taken.

- | | |
|---|-------------------------------------|
| D | Deck photo needed |
| E | Elevation photo needed |
| P | Deck and Elevation photos needed |
| * | Null field, photos are not required |

WSBIS Item 2693 – Soundings Flag

This code indicates whether or not soundings of the streambed (streambed cross sections at the bridge) are required.

- Y Soundings need to be taken.
- * Null field, soundings are not required

This field is coded as part of the inspection planning process, and instructs the inspector to take soundings. When soundings are taken, the flag should be changed to null.

Note: Pedestrian bridges over waterways are managed for soundings and may be coded Y as appropriate.

WSBIS Item 2694 – Clearance Flag

This field identifies which clearances need to be checked on a bridge.

- C Measure horizontal/lateral and vertical clearances.
- H Measure horizontal/lateral clearances.
- V Measure vertical clearances.
- * Null field, measurements are not required

This field is coded as part of the inspection planning process, and instructs the inspector to take, document and code clearance measurements. Unless otherwise instructed, vertical and horizontal clearances on the bridge are to be verified, and vertical, horizontal and lateral clearances under the bridge are to be verified. When measurements are taken, documented and coded, this field should be made null.

WSBIS Item 2710 – Sufficiency Rating

This item is calculated automatically and cannot be edited.

The Sufficiency Rating (SR) formula provides a method of evaluating highway bridge data by calculating four separate factors to obtain a numeric value which is indicative of bridge sufficiency to remain in service. The result of this method is a percentage in which 100 percent would represent an entirely sufficient bridge and zero percent would represent an entirely insufficient or deficient bridge. The formula considers the structural adequacy, functional obsolescence, level of service and essentiality for public use.

See Appendix 2.06-G for the Sufficiency Rating formula.

WSBIS Item 2711 – Structurally Deficient/Functionally Obsolete

This item is calculated automatically and cannot be edited.

Bridges are considered Structurally Deficient (SD) if significant load carrying elements are found to be in poor condition due to deterioration and/or damage, or the adequacy of the waterway opening provided by the bridge is determined to be extremely insufficient to the point of causing overtopping with intolerable traffic interruptions.

SD is numerically defined as follows:

- A bridge component (deck, superstructure, substructure or culvert) having a condition rating of 4 or less (poor condition).
- or
- Structural Evaluation or Waterway Adequacy rated 2 or less (a bridge with a very low load rating capacity, or a bridge that is subject to overtopping with significant or severe traffic delays).

For a structure to be considered SD, one of the following items must be true:

WSBIS Item	Condition/Appraisal Rating
1657 – Structural Evaluation	≤ 2
1662 – Waterway Adequacy	≤ 2
1663 – Deck	≤ 4
1671 – Superstructure	≤ 4
1676 – Substructure	≤ 4
1678 – Culvert	≤ 4

Bridges are considered Functionally Obsolete (FO) when the deck geometry, load carrying capacity (comparison of the original design load to the current State legal load), clearance or approach roadway alignment no longer meet the usual criteria for the system of which it is an integral part. In general, FO means that the bridge was built to standards that are not used today. Examples of characteristics leading to an FO classification:

- Low load carrying capacity
- Low waterway adequacy
- Deck geometry (insufficient deck roadway width)
- Insufficient horizontal and vertical clearances
- Poor approach roadway alignment

For a structure to be considered FO, one of the following items must be true:

WSBIS Item	Appraisal Rating
1657 – Structural Evaluation	=3
1658 – Deck Geometry	≤ 3
1659 – Underclearances	≤ 3
1661 – Approach Roadway Alignment	≤ 3
1662 – Waterway Adequacy	= 3

WSBIS Item 2614 – Subject to NBIS Flag

(Cannot be null.)

This field identifies whether or not the bridge is subject to the National Bridge Inspection Standards (NBIS).

- Y Bridge is subject to the NBIS
- N Bridge is not subject to the NBIS.

This field is based on 23 CFR 650.305, found at www.fhwa.dot.gov/legisregs/directives/fapg/cfr0650c.htm, and the Questions and Answers paragraphs Q303-1 through Q303-6, found at www.fhwa.dot.gov/bridge/nbis/index.cfm. Structures subject to the NBIS include all publicly owned highway structures carrying public roads over a depression or obstruction and having an opening measured along the center of the roadway of more than 20 feet between one of the following:

- Undercopings of abutments
- Spring lines of arches
- Extreme ends of openings for multiple box culverts
- Extreme ends of openings for multiple pipe culverts where the clear distance between pipes is less than half of the smaller contiguous pipe

Structures not subject to the NBIS include:

- Sign support structures
- High mast lighting
- Retaining walls
- Noise barrier structures
- Overhead traffic signs
- Tunnels
- Structures carrying only pedestrians
- Structures carrying only railroad

Ownership and access are also important factors. To be subject to the NBIS, a structure must be both publicly owned and publicly accessible. Structures not subject to the NBIS include:

- Privately owned structures accessible to the public (e.g., road association structures)
- Publicly owned bridges that are not accessible to the public (e.g., structures behind gates used to access dams for agency employees and contractors)

WSBIS Items 2620 – 2623 – Bridge Account Manager (BAM)

(Cannot be null when an inspection has been performed. Will be null for Informational and Inventory report types.)

BAM codes are used to track and categorize inspection costs.

WSBIS Item 2620 – Work Order

This field identifies the bridge owner responsible for inspection costs:

Code	Description
0	WSDOT and GA owned bridges (WSBIS Item 1019 codes 01 and 21)
1	Local Agency bridges (WSBIS Item 1019 codes 02, 04, 12, 13, 24, 25)
2	State Ferry bridges (WSBIS Item 1019 code of 22)
3	State Parks (WSBIS Item 1019 code of 11)
9	No charges (includes Underwater inspections)

WSBIS Item 2621 – Cost Category

This field identifies the staffing and equipment used for inspections:

Code	Description
0	All inspections performed by a lead inspector and a co-inspector team from BPO (2 man routine). This category includes inspections that use bucket trucks, man lifts, and attenuators or traffic control provided by region maintenance.
1	All inspections performed by a lead inspector, co-inspector, and equipment operator team from BPO (3 man UBIT). Generally the equipment will be a UBIT, but this category includes any other equipment that involves a BPO equipment operator.
2	All inspections performed by a co-inspector and equipment operator team from BPO (2 man UBIT). Generally these inspections will be done for local agencies who provide their own lead inspector.
3	All underwater inspections performed by the BPO dive team.

WSBIS Item 2622 – Weekend

This field identifies the overtime status of the inspection:

Code	Description
0	Inspection performed on weekday(s) Monday–Thursday
1	Inspection performed on weekend(s) Friday–Sunday

Any inspection performed on both weekdays and weekends shall be considered weekend work.

WSBIS Item 2623 – Per Diem

This field identifies the State lodging rate applied to the inspection:

Code	Description
0	No overnight stay associated with inspection.
1	Minimum lodging rate associated with inspection.
2	Other than minimum lodging rate associated with inspection.

Lodging rates are available at www.ofm.wa.gov/resources/travel.asp

Note: Rates are determined by the location of the hotel. Lodging rates are associated with all bridges inspected while on travel status when at least one inspector is staying in a hotel that evening or stayed in a hotel the previous evening. Lodging rates are applied based on where the hotel is located at the end of the day. On the last day of a multi-day inspection trip, the lodging rate is based on the previous night's location.

Bridge ID Tab (formerly WB71)

WSBIS Item 1001 – Structure Identifier

FHWA Item 8 – Structure Number

(Cannot be null.)

This field must be unique for every structure in the Washington State Bridge Inventory, and cannot change for the life of the structure. Furthermore, when a new bridge replaces an old bridge, a new unique structure identifier must be coded. The old identifier cannot be recycled.

The WSDOT Inventory Engineer at the Bridge Preservation Office assigns the structure identifier when the original bridge inventory record is processed. When initially creating a new structure in BridgeWorks, a temporary structure ID is generated with an X as the first character. This temporary structure ID will be changed when the record is “released” into the database.

NBI Commentary:

This field is translated to the NBI by adding 7 zeroes to the end of the 8-digit WSBIS code.

This translation is done automatically with the generation of the NBI text file. The NBI coding guide states that all structures with a closed median should be considered one structure, not two, presumably even in cases when they are actually structurally distinct. In some instances WSDOT has coded these structures separately.

WSBIS Item 2009 – Bridge Number

(Cannot be null.)

This is a unique (to the owner agency) alphanumeric code assigned by the owner of the bridge. This field does not require all spaces to be filled; however, the field cannot be left blank.

WSDOT owned structure bridge numbers are formatted as follows:

[route number] / [alphanumeric character string]

WSDOT bridge numbers follow several rules:

1. The forward slash (/) is always in the 4th position, with leading blanks as needed. For example, bridges on I-5 are coded with two leading blanks followed by a 5 and a forward slash. Bridges on US 395 have no leading blanks.
2. In general, every bridge must have a unique bridge number. The exception is when bridges are replaced the bridge number usually doesn't change. In this case, the obsoleted bridge will have the same bridge number.
3. The alphanumeric character string following the forward slash is numerically sequenced by increasing route milepoint, and is often followed by letter characters:

Characters providing route-related information:

E	east bridge of a pair on a divided south-north route
W	west bridge of a pair on a divided south-north route
N	north bridge of a pair on a divided west-east route
S	south bridge of a pair on a divided west-east route
E-N	ramp carrying from eastbound to northbound (vary as needed)
ECD	eastbound collector distributor (vary as needed)
A	bridge not on mainline
F	bridge on frontage road
ALT	bridge on alternate route mainline
SP	bridge on spur route

Characters providing structure design type information:

C	culvert
P	pedestrian bridge
DV	detention vault
LID	structure intended to reconnect severed residential areas

Examples:

90/43S	Eastbound I-90 bridge at Mercer Slough in South Bellevue
5/26N-N	Ramp carrying northbound I-5 traffic to northbound 139th St.
5/313P	Pedestrian bridge over I-5 in Tumwater

4. Short span structure bridge numbers are followed by a decimal point and a two digit number, e.g. 5/300.25.
5. The second portion of WSDOT bridge numbers range from 1 to 99 within the first county in which the route occurs, 100 to 199 in the second county, 200 to 299 in the third county, and so on.

WSBIS Item 2010 – Bridge Sort Number

(Cannot be null.)

This field is used for sorting bridge numbers within the application and in various database queries.

The Bridge Sort Number uses three digits for the route number and three digits for the bridge number, with leading zeroes as necessary. Any following alpha characters are included. A total of 20 characters can be used.

When a decimal place is used in the bridge number, the character z is used in the bridge sort number. This facilitates correct sorting.

Many local agency Bridge Sort Numbers begin with a 99 and a space.

Examples:

Bridge Number	Bridge Sort Number
97/140W	097140W
97/285.6C	097285z6C
5/344S-E	005344S-E
241/2	241002
1135-2	99 1135-2

For state owned structures, this item is coded by the BPO Information Group and is visible in the BridgeWorks Inventory Management mode.

WSBIS Item 2400 – Program Manager

(Cannot be null.)

This field identifies the individual responsible for bridge inspection and reporting as described in the National Bridge Inspection Standards Title 23 CFR 650.307. Both the NBI program manager and delegated program managers are listed in this field as appropriate.

In cases when the bridge is not subject to the NBIS, this field identifies who is responsible for inspecting the bridge and maintaining the bridge records in accordance with WSDOT policies.

WSBIS Item 1019 – Owner**FHWA Item 22 – Owner***(Cannot be null.)*

The actual name of the owner of the bridge shall be recorded on the inspection form. The code shall be used to represent the type of agency that is the primary owner of the structure. If more than one agency has equal ownership, code one agency in the hierarchy of State, Federal, county, city, railroad, and other private.

WSDOT Code	NBI Code	Description
1	001	State Highway Agency
2	002	County Highway Agency
4	004	City or Municipal Highway Agency
11	011	State Park, Forest, or Reservation Agency
12	012	County Park, Forest, or Reservation Agency
13	012	City Park, Forest, or Reservation Agency
21	021	Other State Agencies
22	001	Washington State Ferries
24	025	Other County Agency
25	025	Other City or Local Agencies
26	026	Private (other than railroad)
27	027	Railroad
28	027	Light Rail
31	031	State Toll Authority
32	032	County Toll Authority
33	032	City or Other Toll Authority
60	060	Other Federal Agencies (not listed below)
61	061	Indian Tribal Government
62	062	Bureau of Indian Affairs
63	063	Bureau of Fish and Wildlife
64	064	U.S. Forest Service
66	066	National Park Service
68	068	Bureau of Land Management
69	069	Bureau of Reclamation
70	070	Corps of Engineers (Civil)
71	071	Corps of Engineers (Military)
72	072	Air Force
73	073	Navy/Marines
74	074	Army
80	080	Unknown
92	001	Idaho maintenance responsibility
93	001	Oregon maintenance responsibility

NBI Commentary:

Selected codes have been eliminated because they are not used by any bridges in Washington State (NSA, Pentagon, etc.). Selected codes were added, generally to differentiate county agencies from other local agencies, provide a unique code for Washington State Ferries, and codes for Oregon and Idaho border bridges maintained by these other state agencies.

WSBIS Item 1021 – County Code

FHWA Item 3 – County Code*(Cannot be null.)*

This code identifies the county in which the bridge is located. If this is a jointly owned bridge, the county that is responsible for reporting the data to the inventory should be entered here.

WSBIS Code	NBI Code	County Name	WSBIS Code	NBI Code	County Name
1	001	Adams	21	041	Lewis
2	003	Asotin	22	043	Lincoln
3	005	Benton	23	045	Mason
4	007	Chelan	24	047	Okanogan
5	009	Clallam	25	049	Pacific
6	011	Clark	26	051	Pend Oreille
7	013	Columbia	27	053	Pierce
8	015	Cowlitz	28	055	San Juan
9	017	Douglas	29	057	Skagit
10	019	Ferry	30	059	Skamania
11	021	Franklin	31	061	Snohomish
12	023	Garfield	32	063	Spokane
13	025	Grant	33	065	Stevens
14	027	Grays Harbor	34	067	Thurston
15	029	Island	35	069	Wahkiakum
16	031	Jefferson	36	071	Walla Walla
17	033	King	37	073	Whatcom
18	035	Kitsap	38	075	Whitman
19	037	Kittitas	39	077	Yakima
20	039	Klickitat			

NBI Commentary:

The WSBIS county code is translated to the NBI county code using the formula
 $(\text{WSBIS Code} \times 2) - 1 = \text{NBI code}$ and as shown above.

WSBIS Item 2023 – City

(Cannot be null.)

This is the 1990 federal census place code, updated by OFM for cities incorporated after 1999. These codes are available in an Excel spreadsheet within the “County and city codes” tab at www.ofm.wa.gov/pop/geographic/codes/geographic_codes.xlsx.

Use the 4-digit Place_1990 column in the City Codes spreadsheet tab.

If the bridge is not in a city, code all zeroes.

Examples:

Aberdeen = 0005

Zillah = 1500

WSBIS Item 2132 – Bridge Name

(Cannot be null.)

This is the name of the bridge, either as determined by legislative action or as determined by the bridge owner. If the bridge name is more than one word, separate words with a blank space. If the name of the bridge is too long to fit in the field, use abbreviations to shorten it.

WSBIS Item 1156 – Location

FHWA Item 9 – Location

(Cannot be null.)

This item contains a narrative description of the bridge location for the inventory route. Descriptions should be oriented ahead on station whenever possible. Do not use city limits, as these boundaries may move. This item shall be left justified.

Examples:

19.3 E JCT SR 203

14.7 E MASON CO

On the BridgeID tab, this item is used to code the location for all Main Listings. Secondary Listings are coded on the Crossing tab, and are visible in BridgeWorks Inventory Management mode.

WSBIS Items 2181, 2183, and 2185 – Section, Township, and Range

(Cannot be null.)

Section, township, and range numbers are location markers established by survey mapping. If the bridge runs along a section, township, or range line, use the smaller of the two numbers. If a bridge crosses any line, use the number at the beginning of the bridge.

WSBIS Item 2181 – Section

This is the number of the section in which the bridge is located. Enter a numeric code from 01 to 36.

WSBIS Item 2183 – Township

This is the number of the township in which the bridge is located. Enter a numeric code from 01 to 41. Township designations carry a directional suffix (north or south); however, since all townships in Washington are north, this directional indicator need not be entered.

WSBIS Item 2185 – Range

This is the number of the range in which this bridge is located. There are two parts to this field. In the first two places, enter the number of the range in which the bridge is located. Valid ranges are:

- 01 through 47 if the third column is E
- 01 through 16 If the third column is W.

In the third place, enter the directional suffix which indicates the position of the range in relation to the Willamette Meridian. Enter one of the following codes:

- E East
- W West

A map of section, township and range information is available at www.wsdot.wa.gov/data/tools/geoportal/.

WSBIS Item 1188 – Latitude **(XX degrees XX minutes XX.XX seconds)**

WSBIS Item 1196 – Longitude **(XXX degrees XX minutes XX.XX seconds)**

FHWA Item 16 – Latitude

FHWA Item 17 – Longitude

(Cannot be null.)

Code the latitude and longitude in degrees, minutes and seconds to the nearest hundredth of a second using the NAD 83/91 - North American Datum of 1983, with 1991 adjustments.

Accurate data can be acquired using internet resources such as Google Maps or Bing Maps. For On records, the reading should be taken at the beginning of the bridge at centerline. When the route being inventoried has a Linear Referencing System (LRS) designation, the beginning of the bridge is the lower milepoint for the LRS route. For Under records, the reading should be taken at the centerline of the roadway under the bridge.

When data is acquired in the field, note that GPS devices will show the longitude as a negative number, but this field must be coded as a positive number. For On records, the reading should be taken at the beginning of the bridge at the centerline of the roadway if traffic allows, at the shoulder as necessary. For Under records, the reading should be taken at the centerline of the inventory route where it crosses under the bridge. Generally this can be most easily taken from the deck of the bridge crossing over the route.

Facilities Tab (formerly WB72)

WSBIS Item 1232 – Features Intersected

FHWA Item 6 – Features Intersected

(Cannot be null.)

This item contains a description of the features intersected by the structure. The data in this segment shall be left justified and is limited to 24 characters. When one of the features intersected is another highway, the signed number or name of the highway shall appear first in the field. The names of any other features shall follow, separated by a comma.

Examples:

SR 99, BLUE R, RR
I-405 N-E & N-W RAMPS
GOOSE CREEK
SR 524 SPUR/44TH AVE W

NBI Commentary:

The NBI coding guide separates this field into two segments (6A with 24 characters and 6B with 1 character). However, it's also stated that 6B is not used. The WSBIS coding guide eliminates any reference to 6B, but a blank space is created automatically in the NBI text file.

WSBIS Item 1256 – Facilities Carried

FHWA Item 7 – Facility Carried by Structure

(Cannot be null.)

The facility being carried by the structure shall be recorded and coded. In all situations this item describes the use on the structure. This item shall be left justified and is limited to 18 characters.

Examples:

US 12	RAILROAD
MAIN STREET	PEDESTRIANS
ISRAEL RD	

WSBIS Item 1274 – Region Code

FHWA Item 2 – Highway Agency District

(Cannot be null.)

This is the WSDOT region in which the bridge is located.

WSDOT Code	NBI Code	Region Name
NW	01	Northwest Region
NC	02	North Central Region
OL	03	Olympic Region
SW	04	Southwest Region
SC	05	South Central Region
EA	06	Eastern Region

A region boundary map can be found at www.wsdot.wa.gov/mapsdata/products/digitalmapsdata.htm.

WSBIS Item 1276 – Federal Information Processing Standards (FIPS) Code

FHWA Item 4 – Place Code*(Cannot be null.)*

Code all zeroes for this 5-digit field.

NBI Commentary:

Federal Information Processing Standards were withdrawn by the National Institute of Standards and Technology on January 1, 2006, with the intent to replace them with the Geographic Names Information System (GNIS). On this basis, WSDOT has chosen not to maintain FIPS codes. See the following links for more information:

http://geonames.usgs.gov/docs/fips55_change.pdf

<http://nhd.usgs.gov/gnis.html>

WSBIS Item 1285 – Toll

FHWA Item 20 – Toll*(Cannot be null.)*

The toll status of the structure is indicated by this item. Interstate toll segments under Secretarial Agreement (Title 23 - United States Code - Highways Section 129 as amended by 1991 ISTEA and prior legislation) shall be identified separately. Use one of the following codes:

Code	Description
1	Toll bridge. Tolls are paid specifically to use the structure.
2	On toll road. The structure carries a toll road, that is, tolls are paid to use the facility, which includes both the highway and the structure.
3	On free road. The structure is tollfree and carries a tollfree highway.
4	On Interstate toll segment under Secretarial Agreement. Structure functions as a part of the toll segment.
5	Toll bridge is a segment under Secretarial Agreement. Structure is separate agreement from highway segment.

WSBIS Item 1286 – Custodian**FHWA Item 21 – Maintenance Responsibility***(Cannot be null.)*

The codes below shall be used to represent the type of agency that has primary responsibility for maintaining the structure. If more than one agency has equal maintenance responsibility, code one agency in the hierarchy of State, Federal, county, city, railroad, and other private.

WSDOT Code	NBI Code	Description
1	001	State Highway Agency
2	002	County Highway Agency
4	004	City or Municipal Highway Agency
11	011	State Park, Forest, or Reservation Agency
12	012	County Park, Forest, or Reservation Agency
13	012	City Park, Forest, or Reservation Agency
21	021	Other State Agencies
22	001	Washington State Ferries
24	025	Other County Agency
25	025	Other City or Local Agencies
26	026	Private (other than railroad)
27	027	Railroad
28	027	Light Rail
31	031	State Toll Authority
32	032	County Toll Authority
33	032	City or Other Toll Authority
60	060	Other Federal Agencies (not listed below)
61	061	Indian Tribal Government
62	062	Bureau of Indian Affairs
63	063	Bureau of Fish and Wildlife
64	064	U.S. Forest Service
66	066	National Park Service
68	068	Bureau of Land Management
69	069	Bureau of Reclamation
70	070	Corps of Engineers (Civil)
71	071	Corps of Engineers (Military)
72	072	Air Force
73	073	Navy/Marines
74	074	Army
80	080	Unknown
92	001	Idaho maintenance responsibility
93	001	Oregon maintenance responsibility

NBI Commentary:

Selected codes have been eliminated because they are not used by any bridges in Washington State (NSA, Pentagon, etc.). Selected codes were added, generally to differentiate county agencies from other local agencies, provide a unique code for Washington State Ferries, and codes for Oregon and Idaho border bridges maintained by these other state agencies.

WSBIS Item 1288 – Parallel Structure**FHWA Item 101 – Parallel Structure Designation***(Cannot be null.)*

Code this item to indicate situations where separate structures carry the inventory route in opposite directions of travel over the same feature. The lateral distance between structures has no bearing on the coding of this item. One of the following codes shall be used:

Code	Description
R	The right structure of parallel bridges carrying traffic in the direction of increasing mileposts.
L	The left structure of parallel bridges carrying traffic in the direction of decreasing mileposts.
N	No parallel structure exists.

WSBIS Item 1289 – Temporary Structure**FHWA Item 103 – Temporary Structure Designation***(Leave this field blank unless there are a temporary structure or conditions.)*

Code this item to indicate situations where a temporary structure or conditions exist.

Code	Description
T	Temporary structure or conditions exist.

A temporary structure or conditions are those which are required to facilitate traffic flow. This may occur either before or during the modification or replacement of a structure found to be deficient. Such conditions include the following:

- Bridges shored up, including additional temporary supports.
- Temporary repairs made to keep a bridge open.
- Temporary structures, temporary runarounds or bypasses.
- Other temporary measures, such as barricaded traffic lanes to keep the bridge open.

Any repaired structure or replacement structure which is expected to remain in place without further project activity, other than maintenance, for more than 5 years shall not be considered temporary. Under such conditions, that structure, regardless of its type, shall be considered the minimum adequate to remain in place and evaluated accordingly.

If this item is coded T, then all data recorded for the structure shall be for the condition of the structure without temporary measures, except for the following items which shall be for the temporary structure:

WSBIS Item

- 1499 – Inventory Route, Minimum Vertical Clearance
- 1293 – Structure Open, Posted, or Closed to Traffic
- 1491 – Inventory Route, Total Horizontal Clearance
- 1370 – Minimum Vertical Clearance Over Bridge Roadway
- 1374 – Minimum Vertical Underclearance
- 1379 – Minimum Lateral Underclearance on Right
- 1383 – Minimum Lateral Underclearance on Left
- 1660 – Bridge Posting

NBI Commentary:

WSDOT has defined a 5 year time period for which temporary structures or conditions can be in place and still considered temporary. The NBI coding guide refers to “a significant period of time.”

WSBIS Item 1292 – Historic Significance - NRHP

FHWA Item 37 – Historical Significance

(Cannot be null.)

Bridges are considered historically significant based on a review and listing on the National Register of Historic Places (NRHP). Generally this review is performed by the Washington State Department of Archaeology and Historic Preservation (DAHP).

Use one of the following codes:

WSDOT Code	NBI Code	Description
1	1	Bridge is on the NRHP.
2	2	Bridge is eligible for the NRHP.
3	3	Bridge is possibly eligible for the NRHP but requires further investigation before determination can be made. Alternately, bridge is on a State or local historic register.
4	4	Historical significance has not been determined at this time. (This code should be used for all new structures.)
5	5	Bridge is not eligible for the NRHP – reviewed by the DAHP.
6	5	Bridge is not eligible for the NRHP – reviewed by agency other than the DAHP.

Layout Tab (Formerly WB73)

WSBIS Item 1332 – Year Built

FHWA Item 27 – Year Built

(Cannot be null.)

Code all 4 digits of the year in which construction of the structure was completed. If the year built is unknown, code 1900. If the year built is earlier than 1900, code 1900.

WSBIS Item 1336 – Year Rebuilt

FHWA Item 106 – Year Reconstructed

(Cannot be null.)

Code the year of the last major rehabilitation of the structure. Code all four digits of the year in which reconstruction was completed. If there has been no reconstruction, code 0000.

For a bridge to be defined as rebuilt, the type of work performed, whether or not it meets current minimum standards, must have been eligible for funding under any of the federal aid funding categories. The eligibility criteria would apply to the work performed regardless of whether all state or local funds or federal aid funds were used.

Some types of work to be considered as rebuilt are widenings and retrofits designed to increase the original structural capacity.

Some types of eligible work **not** to be considered as rebuilt are:

- Safety feature replacement or upgrading (for example, bridge rail, approach guardrail or impact attenuators).
- Painting of structural steel.
- Overlay of bridge deck as part of a larger highway surfacing project (for example, overlay carried across bridge deck for surface uniformity without additional bridge work).
- Utility work.
- Emergency repair to restore structural integrity to the previous status following an accident.
- Retrofitting to correct a deficiency which does not substantially alter physical geometry or increase the load-carrying capacity.
- Work performed to keep a bridge operational while plans for complete rehabilitation or replacement are under preparation (for example, adding a substructure element or extra girder).

WSBIS Item 1340 – Structure Length

(XXXX feet)

FHWA Item 49 – Structure Length

(Cannot be null.)

The structure length is recorded in whole feet. The measurement is taken along the centerline of the bridge and back to back of backwalls of abutments or from paving notch to paving notch. **Structure lengths shall be rounded up. For example 22.1 feet measured shall be coded as 23 feet.**

Culvert lengths are measured from inside face to inside face of the exterior walls or from spring line to spring line. When the culvert is not perpendicular to the roadway, the centerline length must be calculated.

Tunnel lengths are measured along the centerline of roadway from opening to opening.

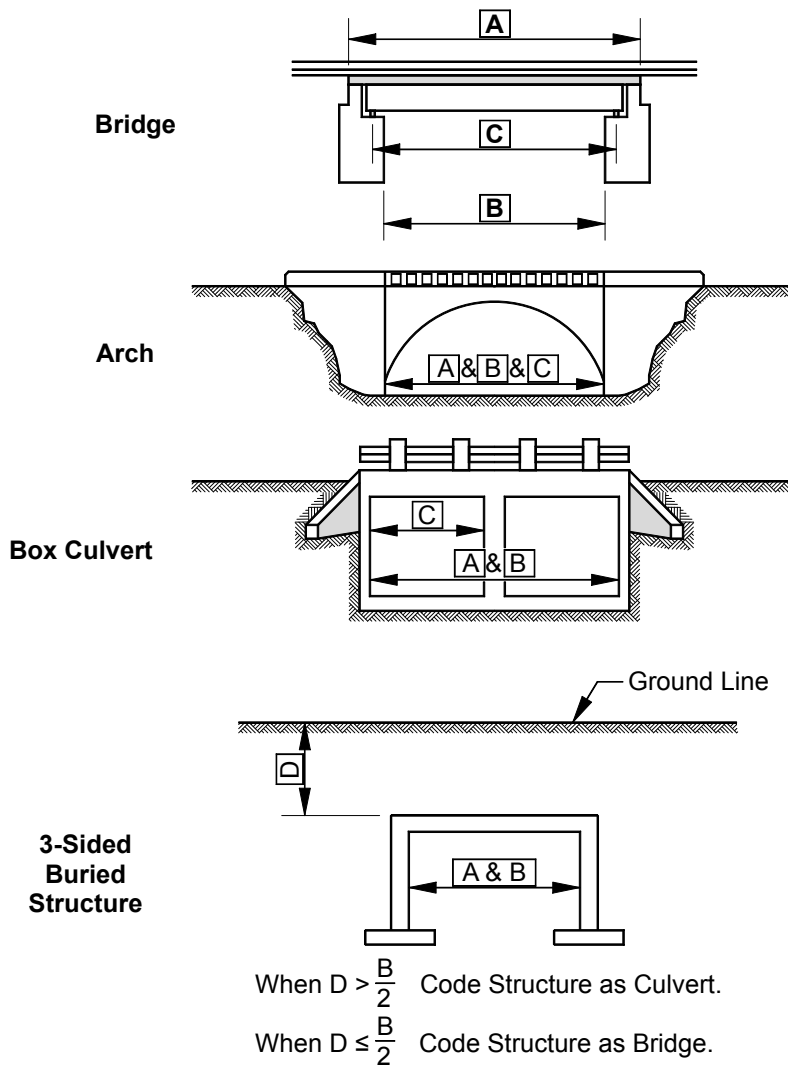

- A** = Structure Length (WSBIS Item 1340)
- B** = NBIS Length (WSBIS Item 2346)
- C** = Maximum Span Length (WSBIS Item 1348)
- D** = Fill Depth

Figure WSBIS-1340a

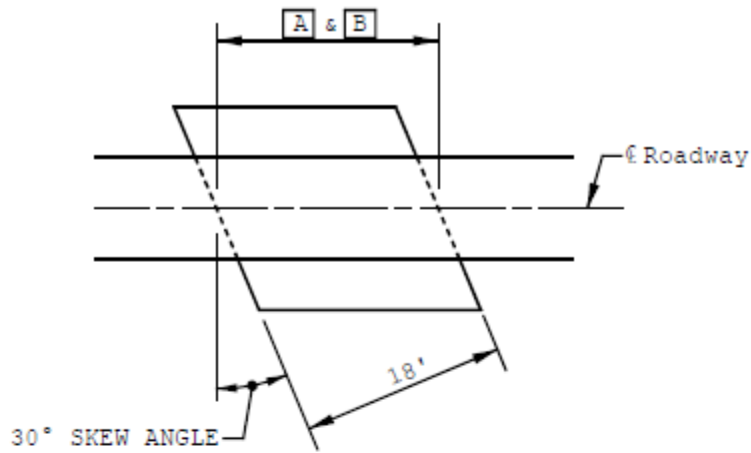

$$A \ \& \ B = \frac{18'}{\cos 30^\circ} = 20.78'$$

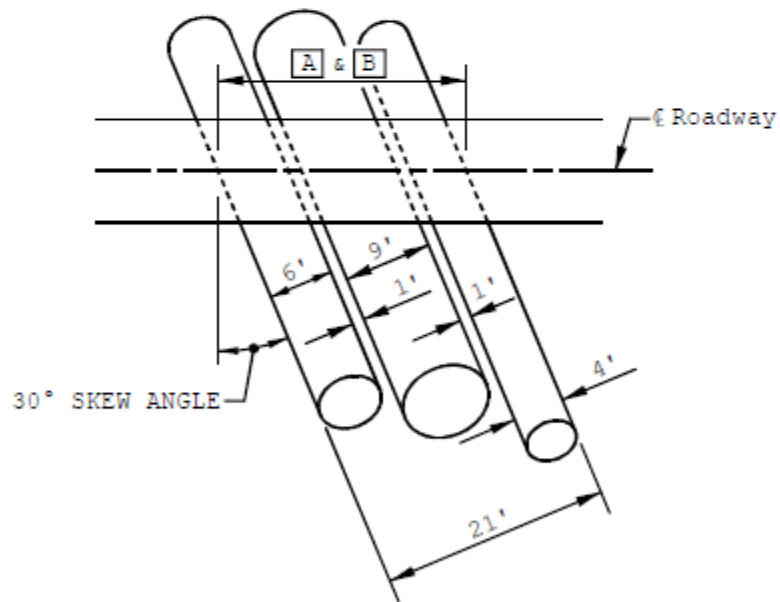

$$A \ \& \ B = \frac{21'}{\cos 30^\circ} = 24.25'$$

Note: The distance between consecutive pipes must be = or < the diameter of the smallest pipe in the series for the series to be considered one structure.

Figure WSBIS-1340b

WSBIS Item 2346 – NBIS Length**(XX.X feet)**

(Leave this field blank if the measurement as entered in Structure Length is less than 19 feet or greater than 23 feet.)

The NBIS bridge length is a measurement along the center of the roadway between undercopings of abutments, spring lines of arches, or the extreme ends of openings for multiple boxes. This measurement is coded to the nearest tenth of a foot and may be different from the measurement entered in WSBIS Item 1340 – Structure Length. See Structure Length for examples on how to determine the NBIS Length. **If a measurement is even very minimally over 20 feet long, round up to the next 10th of a foot.**

If the measurement as entered in Structure Length is between 19 and 23 feet inclusive, a measurement of the NBIS length shall be coded in this field. The NBIS criteria defines a bridge as being greater than 20 feet in length. The NBIS length is used to assist in determining if the structure meets the NBIS definition.

WSBIS Item 1348 – Maximum Span Length**(XXXX feet)****FHWA Item 48 – Length of Maximum Span**

(Cannot be null.)

The length of the maximum span shall be recorded in whole feet. The measurement shall be along the centerline of the bridge. Measure center to center of bearing points or clear open distance between piers, bents, or abutments otherwise.

A span that contains a drop-in span with cantilevers is counted as one span, and the length shall be measured from pier to pier.

See WSBIS Item 1340 – Structure Length for examples on how to determine the length of maximum span.

WSBIS Item 1352 – Lanes On**FHWA Item 28A – Lanes On the Structure**

(Cannot be null.)

Code the number of lanes being carried on the structure.

Include all lanes carrying highway traffic (e.g., cars, trucks, buses) which are striped or otherwise operated as a full width traffic lane for the entire length of the structure. This shall include any full width merge lanes and ramp lanes, and shall be independent of directionality of usage (e.g., a 1-lane bridge carrying 2-directional traffic is still considered to carry only one lane on the structure).

It should be noted here that for the purpose of evaluating WSBIS Item 1658 Deck Geometry, any 1-lane bridge, not coded as a ramp (WSBIS Item 1434 = 7), which has a WSBIS Item 1356 Curb-to-Curb coded 16 feet or greater shall be evaluated as 2 lanes.

Double deck bridges may be coded as 1 or 2 structures, but all related data must be compatible with the method selected.

WSBIS Item 1356 – Curb-to-Curb Width**(XXX.X feet)****FHWA Item 51 – Bridge Roadway Width, Curb-to-Curb***(Cannot be null.)*

Code the curb-to-curb width to the nearest tenth of a foot. The information to be recorded is the most restrictive minimum distance between curbs or rails on the structure roadway. The measurement should be exclusive of flared areas for ramps.

For structures with closed medians and usually for double decked structures, coded data will be the sum of the most restrictive minimum distances for all roadways carried by the structure*. The data recorded for this item must be compatible with other related route and bridge data (e.g., Lanes On, Lanes Under, ADT, etc.). See examples in WSBIS Items 1364 and 1367.

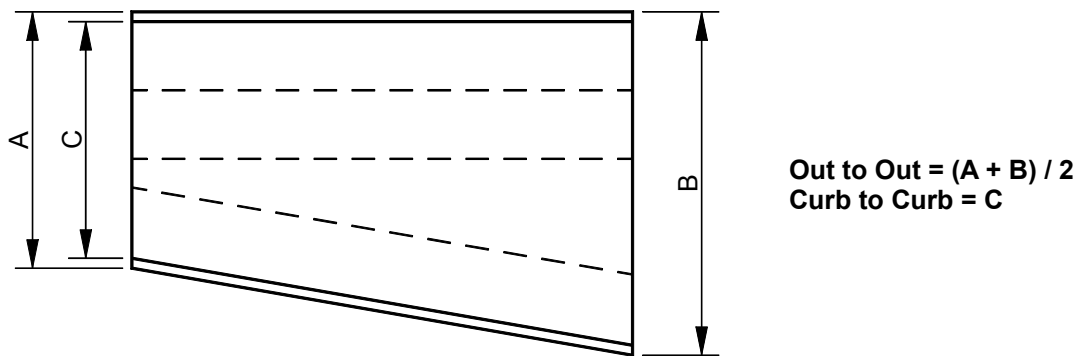
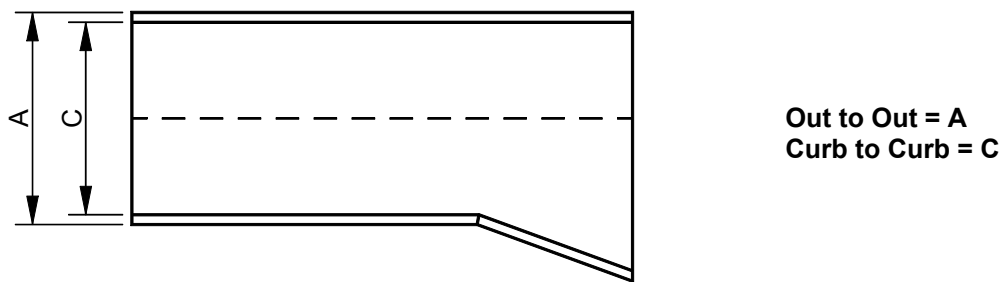
**Example 1****Example 2****Figure WSBIS-1356a**

Where traffic runs directly on the top slab (or wearing surface) of a culvert-type structure (e.g., an R/C box without fill), code the actual roadway width (curb-to-curb or rail-to-rail). This will also apply where the fill is minimal and headwalls or parapets affect the flow of traffic.

Where the roadway is on fill carried across a structure and the headwalls or parapets do not affect the flow of traffic, code 0. This is considered proper inasmuch as a filled section simply maintains the roadway cross section.

*Raised or non-mountable medians, open medians, and barrier widths are to be excluded from the summation along with barrier-protected bicycle and equestrian lanes.

Coding a sidehill viaduct (half bridge):

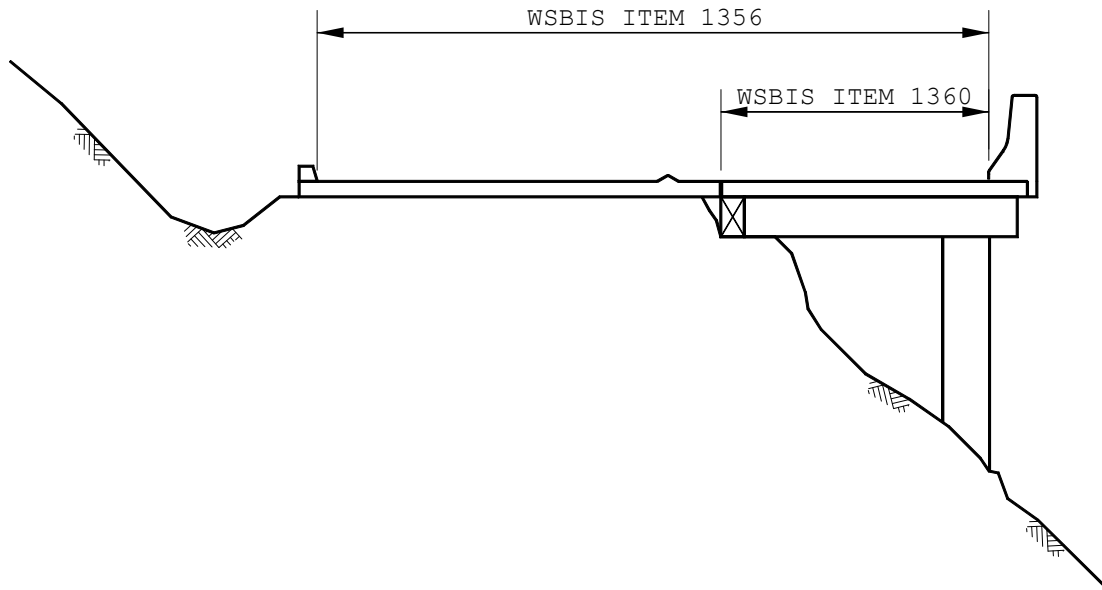

Figure WSBIS-1356b

WSBIS Item 1360 – Out-to-Out Deck Width
(XXX.X feet)

FHWA Item 52 – Deck Width, Out-to-Out
(Cannot be null.)

Code the out-to-out width to the nearest tenth of a foot. If the structure is a through structure, the number to be coded will represent the lateral clearance between superstructure members. See example in Figure WSBIS-1364a.

The measurement will be the most representative out-to-out width on the bridge, and should be exclusive of flared areas for ramps. See examples in Figures WSBIS-1356a and -1364b.

Where traffic runs directly on the top slab (or wearing surface) of the culvert (e.g., an R/C box without fill) code the actual width (out-to-out). This will also apply where the fill is minimal and the culvert headwalls affect the flow of traffic. However, for sidehill viaduct structures code the actual out-to-out structure width. See Figure WSBIS-1356b.

Where the roadway is on a fill carried across a pipe or box culvert and the culvert headwalls do not affect the flow of traffic, code 0. This is considered proper inasmuch as a filled section over a culvert simply maintains the roadway cross-section.

WSBIS Item 1364 – Sidewalk/Curb Width Left
(XX.X feet)

WSBIS Item 1367 – Sidewalk/Curb Width Right**(XX.X feet)****FHWA Item 50A – Curb or Sidewalk Widths****FHWA Item 50B – Curb or Sidewalk Widths***(Cannot be null.)*

Code the widths of the left and right curbs or sidewalks to the nearest tenth of a foot. Code zeroes when there are no curbs or sidewalks.

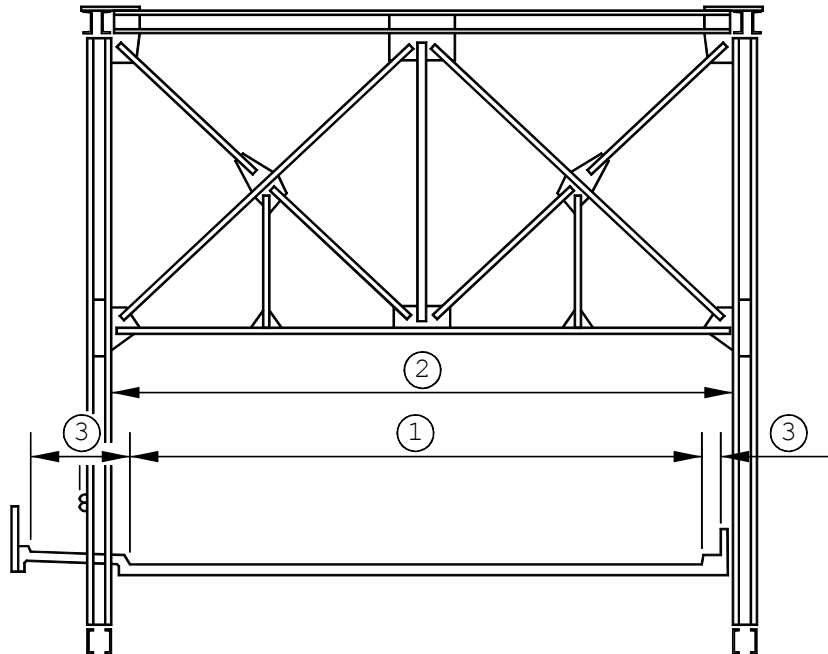

- (1) WSBIS 1356 – Bridge Roadway Width, Curb-to-Curb
- (2) WSBIS 1360 – Deck Width, Out-to-Out
- (3) WSBIS 1364 and 1367 – Curb or Sidewalk Width

Figure WSBIS-1364a

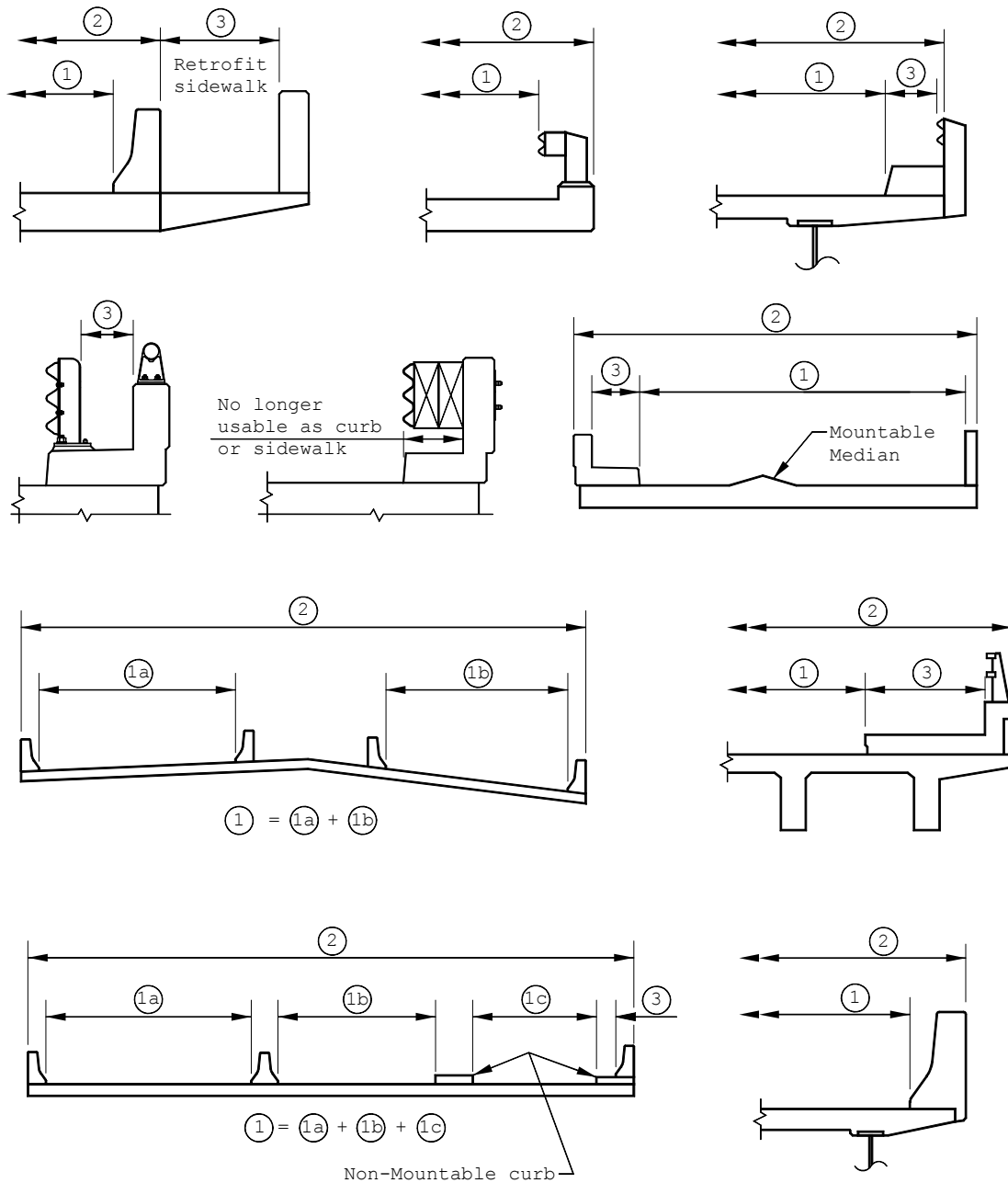

- (1) WSBIS Item 1356 – Bridge Roadway Width, Curb-to-Curb
- (2) WSBIS Item 1360 – Deck Width, Out-to-Out
- (3) WSBIS Items 1364 and 1367 – Curb or Sidewalk Width

Figure WSBIS-1364b

WSBIS Item 1370 – Minimum Vertical Clearance Over Deck**(XXXX feet and inches)****FHWA Item 53 – Minimum Vertical Clearance Over Bridge Roadway***(Cannot be null.)*

The information to be recorded for this item is the actual minimum vertical clearance over the bridge roadway, including shoulders, to any superstructure restriction, in feet and inches, rounded to the lesser inch (e.g., 16' 3³/₄" is to be coded 1603). For double decked structures code the minimum, regardless whether it is pertaining to the top or bottom deck. When no superstructure restriction exists above the bridge roadway code 9999. When a restriction is 100 feet or greater code 9912.

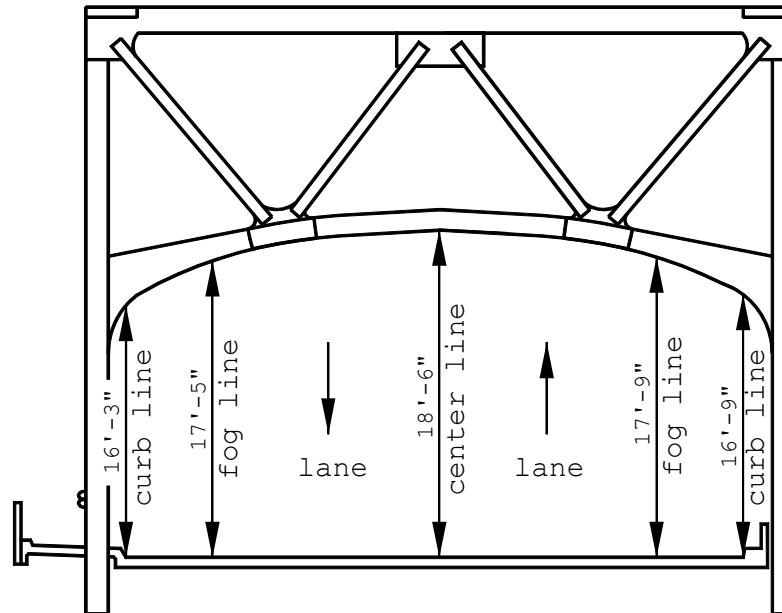
**STEEL TRUSS**

Code: 1603

Figure WSBIS-1370

WSBIS Item 1374 – Minimum Vertical Clearance Under Bridge

(XXXX feet and inches)

FHWA Item 54B – Minimum Vertical Underclearance

(Cannot be null.)

Code the minimum vertical clearance from the roadway (travel lanes only) or railroad track beneath the structure to the underside of the superstructure. Traveled way, or travel lanes, is between fog lines and excludes shoulders or gore areas.

If the bridge crosses both a highway and a railroad, code the highway clearance UNLESS the railroad has a substandard clearance based on current design criteria and the roadway is NOT substandard.

The information to be recorded is the actual minimum vertical clearance over the traveled way to the structure, in feet and inches, rounded to the lesser inch (e.g., 16' 3¾" is to be coded 1603). When a restriction is 100 feet or greater, code 9912.

If the feature is not a highway or railroad, code the minimum vertical clearance 0. A highway is to be considered any functionally classified, public road. Private roads are not to be included.

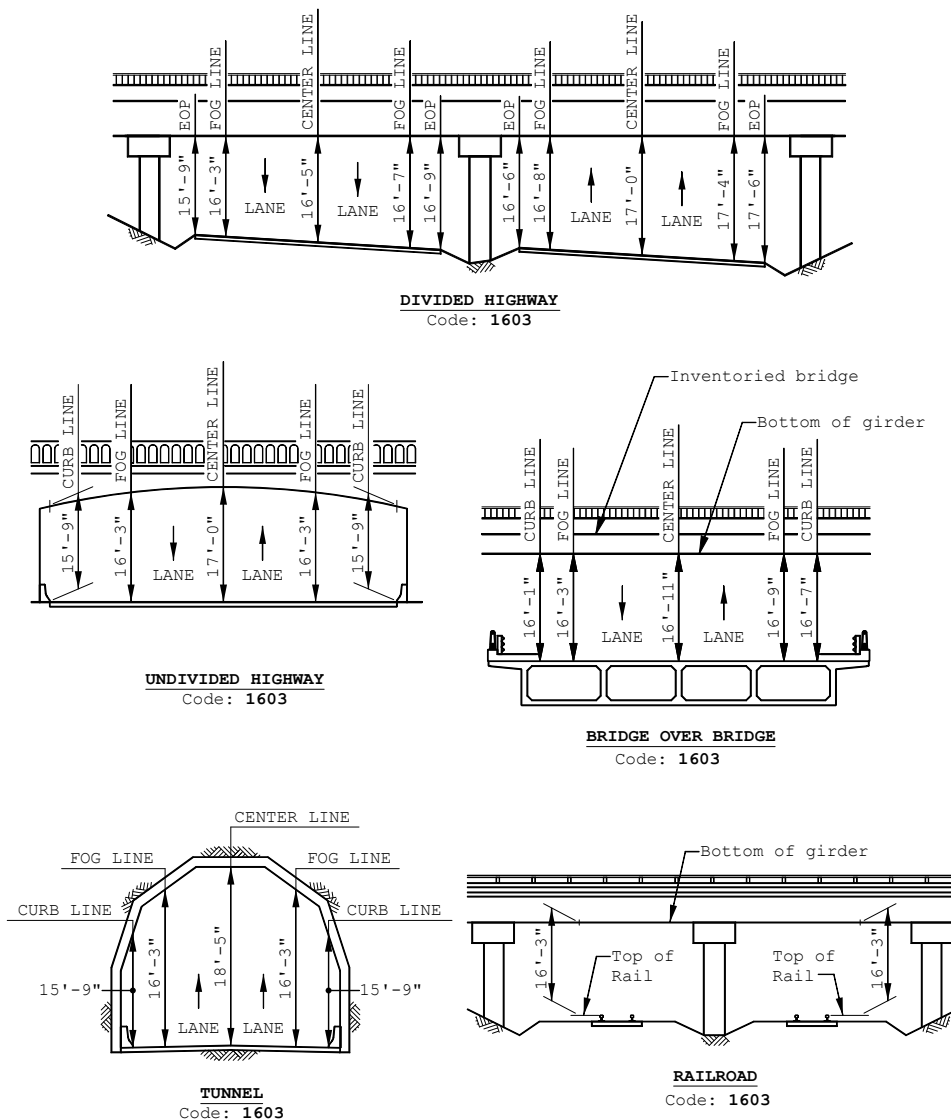

Figure WSBIS-1374

WSBIS Item 1378 – Vertical Underclearance Code**FHWA Item 54A – Reference feature***(Cannot be null.)*

Code the reference feature from which the clearance measurement is taken:

Code	Description
H	Highway beneath structure
R	Railroad beneath structure
N	Feature not a highway or railroad

WSBIS Item 1379 – Minimum Lateral Underclearance Right**(XX.X feet)****FHWA Item 55B – Minimum Lateral Underclearance on Right***(Cannot be null if bridge has an On record, must be null if the bridge does not have an On record.)*

The purpose of this item is to identify the lateral restrictions caused by the structure on the railroad or roadway underneath.

Code the minimum lateral underclearance on the right to the nearest tenth of a foot. When both a railroad and highway are under the structure, code the most critical dimension.

The lateral clearance should be measured from the right edge of the roadway excluding shoulders (fog line) or from the centerline (between rails) of the right-hand track of a railroad to the nearest substructure unit (pier, abutment, etc.), a retaining wall or to a slope. If no fog line exists on the roadway, assume a 12 foot lane. The right/left orientation is based on traffic direction. The clearance measurements to be recorded will be the minimum after measuring the clearance in both directions of travel, perpendicular to the centerline of the undercrossing.

If two related features are below the bridge, measure both and record the lesser of the two. An explanation should be written on the inspection form as to what was recorded. When the clearance is 100 feet or greater, code 99.9.

If the feature beneath the structure is not a railroad or highway, code 0 to indicate not applicable.

The presence of ramps and acceleration or turning lanes is not considered in this item; therefore, the minimum lateral clearance on the right should be measured from the right edge of the through roadway.

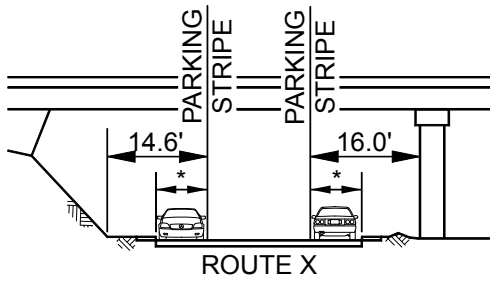

CITY STREET

2-way traffic: RT. = 14.6 LT. = 0.0
 1-way traffic looking in the direction of traffic: RT. = 16.0 LT. = 14.6
 * = Parking area, inspectors please document dimension.

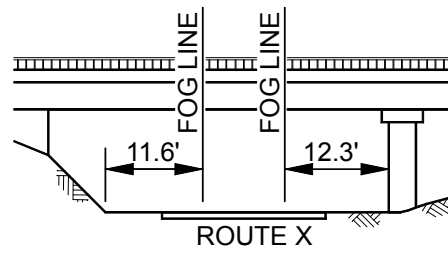

HIGHWAY

2-way traffic: RT. = 11.6 LT. = 0.0
 1-way traffic looking in the direction of traffic: RT. = 12.3 LT. = 11.6

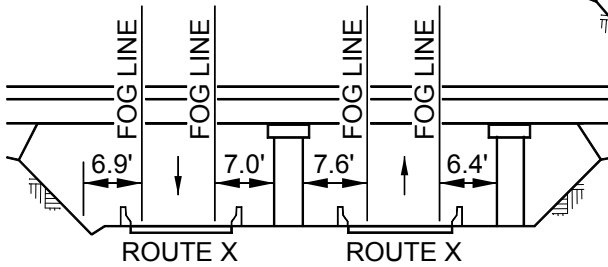

FREEWAY PIER MEDIAN

RT. = 6.4 LT. = 7.0

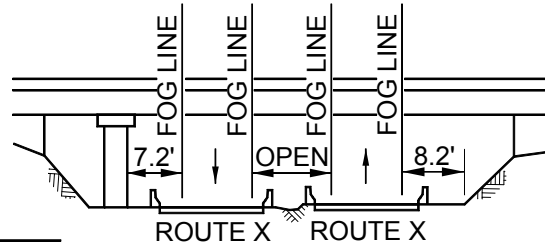

FREEWAY OPEN MEDIAN

RT. = 7.2 LT. = 99.9

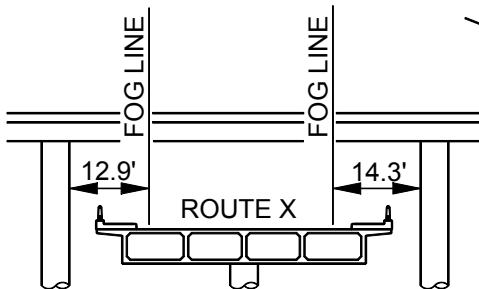

MULTIPLE LEVEL INTERCHANGE

2-way traffic: RT. = 12.9 LT. = 0.0
 1-way traffic looking in the direction of traffic: RT. = 14.3 LT. = 12.9

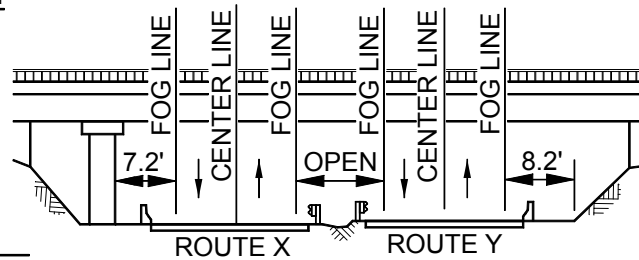

DUAL HIGHWAY OPEN MEDIAN

RT. = 7.2 LT. = 99.9

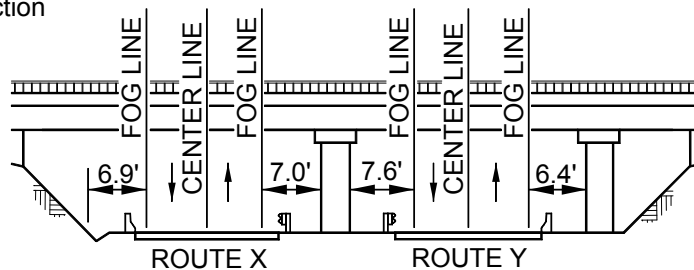

DUAL HIGHWAY PIER MEDIAN

RT. = 6.4 LT. = 0.0

Figure WSBIS-1379a

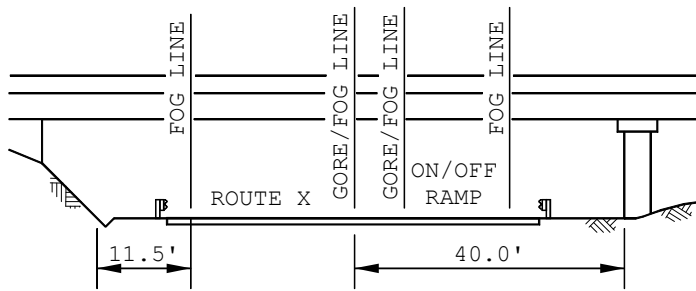

FREWAY ON/OFF RAMP

2-way traffic: RT. = 11.5 LT. = 000
 1-way traffic looking in the direction
 of traffic: RT. = 40.0 LT. = 11.5

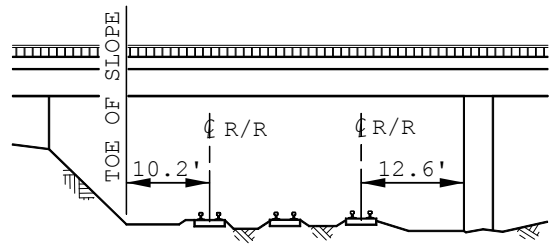

RAILROAD MULTIPLE TRACK

RT. = 10.2 LT. = 000

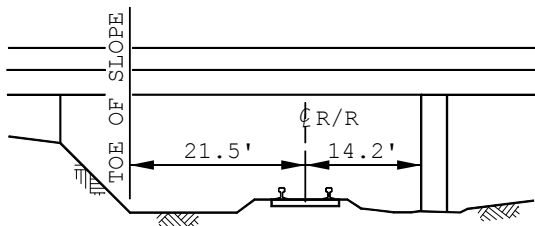

RAILROAD SINGLE TRACK

RT. = 14.2 LT. = 000

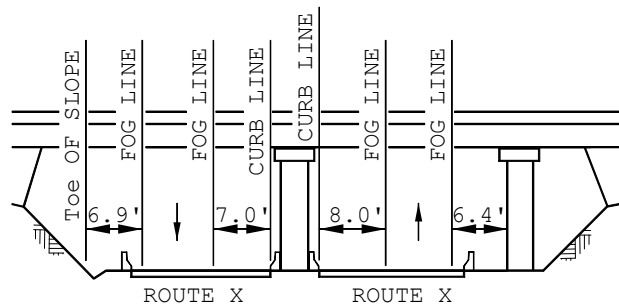

**FREWAY PIER MEDIAN WITH
BARRIER ADJACENT TO SUBSTRUCTURE**

RT. = 6.4 LT. = 7.0

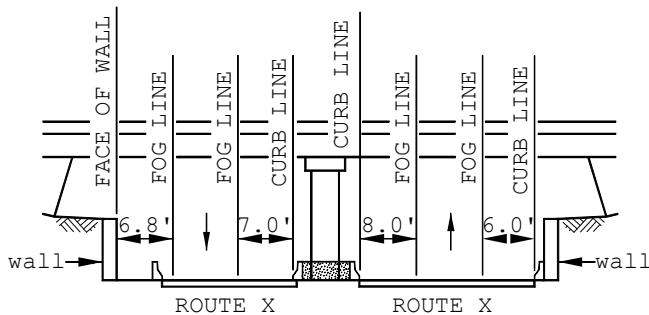

**FREWAY PIER MEDIAN WITH CONCRETE/DIRT FILL
BETWEEN BARRIERS AROUND SUBSTRUCTURE**

RT. = 6.0 LT. = 7.0

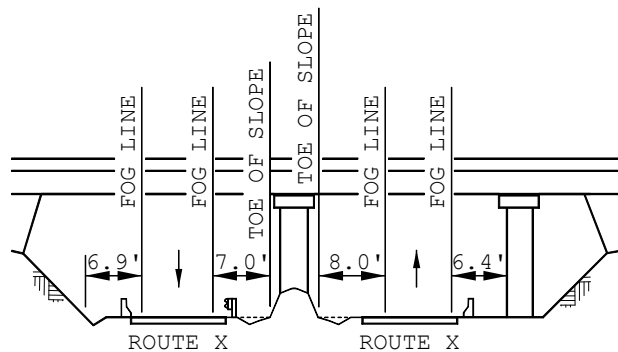

**FREWAY PIER MEDIAN WITH
MOUNDED DIRT AROUND SUBSTRUCTURE**

RT. = 6.4 LT. = 7.0

Figure WSBIS-1379b

NBI Commentary:

The NBI coding guide text and drawings are not clear or consistent, particularly with respect to determining whether or not the lateral measurements extend to guardrails, concrete rails, non-mountable curbs, substructure units, or slopes. Attempts to define the steepness of slopes was also problematic. This coding guide clarifies that all measurements are to substructure units or "slopes" without defining the steepness. In addition, the NBI coding guide was not entirely clear about how to code dual highways in relation to substructure units or medians. This coding guide clarifies this through illustration.

WSBIS Item 1382 – Lateral Underclearance Code**FHWA Item 55A – Minimum Lateral Underclearance on Right**

(Cannot be null if bridge has an On record, must be null if the bridge does not have an On record.)

This code identifies the type of reference feature from which the clearance measurement is taken.

Code	Description
H	Highway beneath structure
R	Railroad beneath structure
N	Feature beneath the bridge is neither a highway or railroad

WSBIS Item 1383 – Minimum Lateral Underclearance Route Left**(XX.X feet)****FHWA Item 56 – Minimum Lateral Underclearance on Left**

(Cannot be null if bridge has an On record, must be null if the bridge does not have an On record.)

The purpose of this code is to identify the lateral restrictions caused by the structure on the railroad or roadway underneath.

This field is intended to record measurements on the left side of highway based on traffic direction for divided highways, 1 way streets, and ramps. For railroads and all 2 direction, 2 lane routes which are undivided, code 000.

Code the minimum lateral underclearance on the left (median side for divided highways) to the nearest tenth of a foot. The lateral clearance should be measured from the left edge of the roadway (excluding shoulders) to the nearest substructure unit, or to a slope. Refer to examples for WSBIS Item 1379 – Minimum Lateral Underclearance on Right.

For clearances greater than 100 feet, code 99.8.

In cases where there is an open median (no piers in median), code 99.9.

Code 0 to indicate not applicable (railroads and other non highway undercrossings).

NBI Commentary:

See WSBIS Item 1379 NBI Commentary.

WSBIS Item 1386 – Navigation Control**FHWA Item 38 – Navigation Control***(Cannot be null.)*

Indicate for this item whether or not navigation control (a bridge permit for navigation) is required. Use one of the following codes:

Code	Description
N	Not applicable, no waterway
0	No navigation control on waterway (bridge permit not required or bridge has received advance approval by the USCG, see below for more information)
1	Navigation control on waterway (bridge permit required)

Advance Approval:

This item should be coded 0 when Title 33, Code of Federal Regulations, Section 115.70, as amended states that the U.S. Coast Guard Commandant has given advance approval to the location and plans of bridges to be constructed across reaches of waterways navigable in law, but not actually navigated other than by logs, log rafts, rowboats, canoes and small motorboats.

For state owned structures, this item is coded by the BPO Information Group.

NBI Commentary:

This coding guide provides additional guidance on how to code bridges crossing advance approval waterways.

WSBIS Item 1387 – Navigation Vertical Clearance**(XXX feet)****FHWA Item 39 – Navigation Vertical Clearance***(Cannot be null.)*

If WSBIS Item 1386 – Navigation Control has been coded 1, record the minimum vertical clearance imposed at the site as measured above a datum that is specified on a navigation permit issued by a control agency. The measurement shall be coded to the foot. This measurement will show the clearance that is allowable for navigational purposes. In the case of a swing or bascule bridge, the vertical clearance shall be measured with the bridge in the closed position (i.e., open to vehicular traffic). The vertical clearance of a vertical lift bridge shall be measured with the bridge in the raised or open position. Also, WSBIS Item 1394 – Vertical Lift Minimum Navigation Clearance shall be coded to provide clearance in a closed position. If WSBIS Item 1386 – Navigation Control has been coded 0 or N, code 0 to indicate not applicable.

For state owned structures, this item is coded by the BPO Information Group.

WSBIS Item 1390 – Navigation Horizontal Clearance**(XXXX feet)**

FHWA Item 40 – Navigation Horizontal Clearance*(Cannot be null.)*

If WSBIS Item 1386 – Navigation Control has been coded 1, record the horizontal clearance measurement imposed at the site that is shown on the navigation permit. This may be less than the structure geometry allows. If a navigation permit is required but not available, use the minimum horizontal clearance between fenders, if any, or the clear distance between piers or bents. Code the clearance to the foot. If WSBIS Item 1386 – Navigation Control has been coded 0 or N, code 0 to indicate not applicable.

For state owned structures, this item is coded by the BPO Information Group.

WSBIS Item 1394 – Vertical Lift Minimum Navigation Clearance**(XXX feet)**

FHWA Item 116 – Minimum Navigation Vertical Clearance, Vertical Lift Bridge*(Code this item only for vertical lift bridges in the dropped or closed position, otherwise leave blank.)*

Code the minimum vertical clearance to the nearest lesser foot imposed at the site as measured above a datum that is specified on a navigation permit issued by a control agency.

For state owned structures, this item is coded by the BPO Information Group.

NBI Commentary:

Per 3/6/2013 email from Debbie Lehmann, FHWA, ferry terminal structures coded as lift spans should have 000 coded in this field.

WSBIS Item 1291 – Median

FHWA Item 33 – Bridge Median

(Cannot be null.)

Indicate with a 1-digit code if the median is nonexistent, open or closed. The median is closed when the area between the 2 roadways at the structure is bridged over and is capable of supporting traffic. All bridges that carry either 1-way traffic or 2-way traffic separated only by a centerline will be coded 0 for no median.

WSDOT Code	NBI Code	Description
0	0	No median (undivided highway)
1	1	Open median
2	2	Closed median – painted only
3	2	Closed median – mountable curb (less than 6" vertical surface, or sloped surface)
4	3	Closed median – flex or thrie beam
5	3	Closed median – box beam guardrail
6	3	Closed median – concrete barrier
8	3	Closed median – non-mountable curb (6" or greater vertical surface)
9	3	Other median

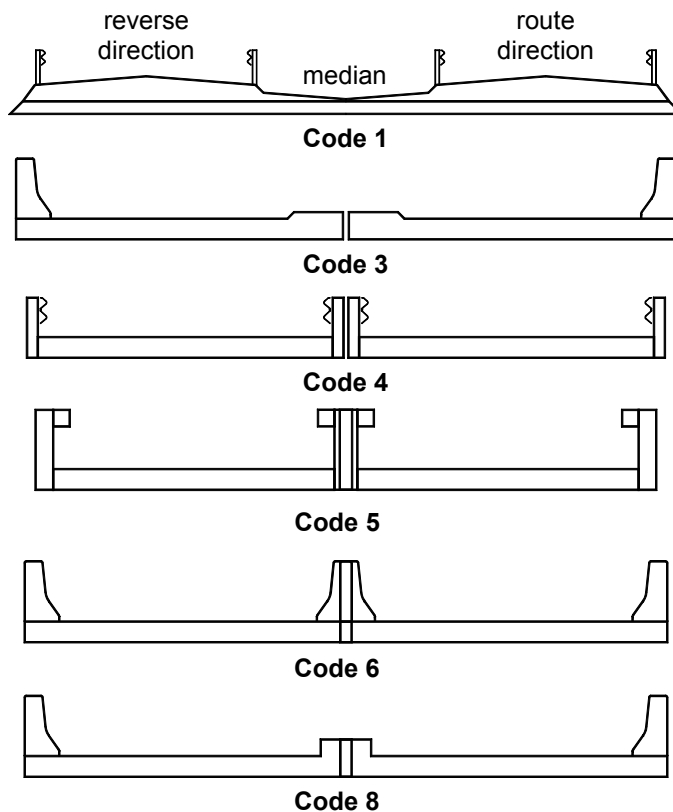

Figure WSBIS-1291

NBI Commentary:

This coding guide split out various types of medians that are translated to the NBI coding guide as described above.

WSBIS Item 1397 – Approach Roadway Width**(XXX feet)****FHWA Item 32 – Approach Roadway Width**

(Cannot be null if bridge has an On record, must be null if the bridge does not have an On record.)

Code the normal width of usable roadway approaching the structure measured to the nearest foot. Usable roadway width will include the width of traffic lanes and the widths of shoulders where shoulders are defined as follows:

Shoulders must be constructed and normally maintained flush with the adjacent traffic lane, and must be structurally adequate for all weather and traffic conditions consistent with the facility carried. Unstabilized grass or dirt, with no base course, flush with and beside the traffic lane, is not to be considered a shoulder for this item.

For structures with medians of any type and double decked structures, this item should be coded as the sum of the usable roadway widths for the approach roadways (i.e., all median widths which do not qualify as shoulders should not be included in this dimension). When there is a variation between the approaches at either end of the structure, code the most restrictive of the approach conditions.

If a ramp is adjacent to the through lanes approaching the structure, it shall be included in the approach roadway width.

WSBIS Item 1310 – Skew**(XX degrees)****FHWA Item 34 – Skew**

(Cannot be null.)

The skew angle is the angle between the centerline of a pier and a line normal to the roadway centerline. When plans are available, the skew angle can be taken directly from the plans. If no plans are available, the angle is to be field measured if possible. Record the skew angle to the nearest degree. If the bridge piers are perpendicular to roadway centerline, code 0. When the structure is on a curve or if the skew varies for some other reason, the average skew should be recorded, if reasonable. Otherwise, record 99 to indicate a major variation in skews of substructure units.

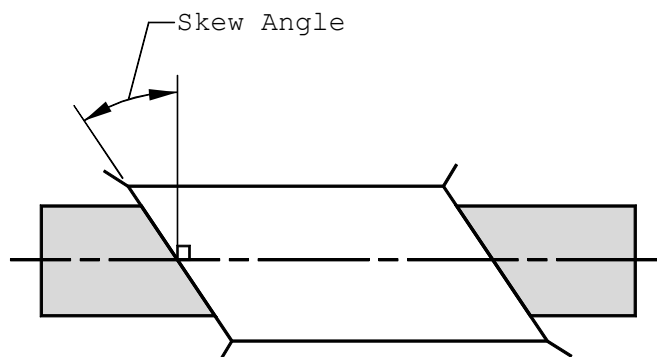

Figure WSBIS-1310

WSBIS Item 1312 – Flared Flag

FHWA 35 – Structure Flared*(Cannot be null.)*

Code this item to indicate if the structure is flared (i.e., the width of the structure varies). Generally, such variance will result from ramps converging with or diverging from the through lanes on the structure, but there may be other causes. Minor flares at ends of structures should be ignored.

WSDOT Code	NBI Code	Description
N	0	No flare
Y	1	Yes flared

Crossing Tab (Formerly WB74)

WSBIS Item 2000 – Main Listing Flag

See Coding Guide Clarifications for a description of the Main Listing Flag.

This item is visible in the BridgeWorks Inventory Management mode.

WSBIS Items 1432, 1433, 1434, and 1435

FHWA Item 5 – Inventory Route

The inventory route is a 9-digit code composed of 5 segments.

Segment	Description
5A	Record Type
5B	Route Signing Prefix
5C	Designated Level of Service
5D	Route Number
5E	Directional Suffix

WSBIS Item 1432 – Inventory Route On/Under

FHWA 5A – Record type

(Cannot be null.)

There are two types of National Bridge Inventory records: On and Under

Code	Description
1	Route carried on the structure
2	Single route goes under the structure
A – Z	Multiple routes go under the structure
0	No route on or under the structure

On signifies that the inventory route is carried on the structure. All of the NBI data items must be coded, unless specifically excepted, with respect to the structure and the inventory route on it.

Under signifies that the inventory route goes under the structure. If an inventory route beneath the structure is a Federal-aid highway, is a STRAHNET route or connector or is otherwise important, a record must be coded to identify it. The type code must be 2 or an alphabetic letter A through Z. Code 2 for a single route under the structure. If two or more routes go under a structure, code A, B, C, D, etc., consecutively for multiple routes on separate roadways under the same structure. STRAHNET routes shall be listed first. When this item is coded 2 or A through Z, only selected items are coded, as specified in the item descriptions and in the list in the Coding Guide Clarifications.

It cannot be overemphasized that all route-oriented data must agree with the coding as to whether the inventory route is on or under the structure.

Tunnels shall be coded only as an Under record; that is, they shall not be coded as a structure carrying highway traffic.

There are situations of a route under a structure, where the structure does not carry a highway, but may carry a railroad, pedestrian traffic, or even a building. These are coded the same as any other Under record and no On record shall be coded.

For additional clarification of On and Under records, refer to the Coding Guide Instructions.

NBI Commentary:

WSDOT created code 0 to indicate the bridge does not carry nor cross over a highway. An example would be a pedestrian structure over a waterway. These are not NBI bridges but may be included in the inventory at each agency's discretion.

WSBIS Item 1433 – Inventory Route Highway Class

FHWA Item 5B – Route Signing Prefix

(Cannot be null.)

Identify the highway class for the inventory route using one of the following codes:

Code	Description
1	Interstate highway
2	U.S. numbered highway
3	State highway
4	County road
5	City street
6	Federal lands road
7	State lands road
8	Other (include toll roads not otherwise identifiable above)

When 2 or more routes are concurrent, the highest class of route will be used. The hierarchy is in the order listed above.

WSBIS Item 1434 – Inventory Route Service Level

FHWA Item 5C – Designated Level of Service

(Cannot be null.)

Identify the service level for the inventory route using one of the following codes:

Code	Description
1	Mainline (includes reversible routes)
2	Alternate
3	Bypass
4	Spur
6	Business
7	Ramp, Wye, Connector, etc.
8	Service and/or unclassified frontage road
0	None of the above

WSBIS Item 1435 – Route

XXXXX

FHWA Item 5D – Route Number

(Cannot be null.)

Code the route number of the inventory route. This value shall be a five digit number, right justified with leading zeroes filled in.

If concurrent routes are of the same hierarchy level, denoted by the highway class, the lowest numbered route shall be coded. Code 00000 for bridges on roads without route numbers.

FHWA Item 5E – Directional Suffix

Washington State does not maintain directional suffixes to route numbers, so this information is not maintained in the Washington State Bridge Inventory. This code is not editable, and is automatically generated as 0 (not applicable) for the NBI text file.

WSBIS Item 2440 – Milepost

(XXX.XX) miles

(Cannot be null.)

The milepost is displayed on the inspection report header with the associated route (WSBIS Item 1435). Both are intended to provide information about the location of the bridge on the primary route used for inspection access, and should represent the bridge milepost relative to nearby milepost signs.

WSBIS Item 2436 – Route Sequencer

XX

(Cannot be null.)

The route sequencer is a two digit number used for placement of crossing records in the WSDOT *Bridge List M 23-09*.

For state owned structures, this item is coded by the BPO Information Group and is visible in BridgeWorks Inventory Management mode.

WSBIS Item 2437 – Bridge List Milepost Override

(XXX.XX) miles

(Cannot be null.)

The bridge list milepost override is used for placement of crossing records in the Bridge List.

For state owned structures, this item is coded by the BPO Information Group and is visible in the BridgeWorks Inventory Management mode.

WSBIS Item 2438 – Milepost Sequencer

XX

(Cannot be null.)

The milepost sequencer is a two digit number used for placement of crossing records in the Bridge List.

For state owned structures, this item is coded by the BPO Information Group and is visible in BridgeWorks Inventory Management mode.

WSBIS Item 2468 – Directional Indicator

(Cannot be null.)

The directional indicator specifies if the inventory route carries traffic in the direction of increasing mileposts, decreasing mileposts or both.

- I Increasing
- D Decreasing
- B Both
- * Null field, does not apply

For state owned structures, this item is coded by the BPO Information Group and is visible in BridgeWorks Inventory Management mode.

WSBIS Item 2470 – Ahead/Back Indicator

(Cannot be null.)

The ahead/back indicator specifies whether a milepost value is the ‘back’ (B) duplicate of a milepost value ‘ahead’ (A) on the route.

For state owned structures, this item is coded by the BPO Information Group and is visible in BridgeWorks Inventory Management mode.

WSBIS Item 1467 – Linear Referencing System Route

XXXXXXXXXXXX**FHWA Item 13A – LRS Inventory Route Number**

(Cannot be null.)

Linear Reference is coded to correspond to the location of the crossing as it relates to the WSDOT standard Linear Referencing System (LRS). The LRS used must correspond to the LRS reported by our state’s Highway Performance Monitoring System (HPMS).

Primarily the State Route LRS representation will be seen in this field, but there will be some form of a local LRS to use as well. For the State Route mainline, code the LRS as a three digit number (e.g., 090, 002). When coding other State Route types (e.g., ramps, couplets, spurs) maintain the 3 digit route designator along with additional information signifying a related route.

Examples:

599S500035

529SPEVERET (reported to NBI as 529SPEVERE)

005

005LX10130

NBI Commentary:

WSDOT maintains a 12 character, alphanumeric LRS route number, but the NBI receives only 10 digits. In most cases WSDOT does not use the 11th or 12th character. For the NBI submittal, any additional characters to the right of the 10th character are trimmed. Route numbers with fewer than 10 characters get reported with no additional leading zeroes added.

WSDOT codes LRS route numbers for all crossing records, but only routes on the Base Highway Network are submitted to the NBI.

WSBIS Item 1477 – Linear Referencing System Subroute

FHWA Item 13B – LRS Subroute Number

(Cannot be null.)

The LRS subroute number is always coded 00.

NBI Commentary:

WSDOT codes LRS subroute numbers for all crossing records, but only routes on the Base Highway Network are submitted to the NBI.

WSBIS Item 1469 – LRS Milepost**(XXX.XX) miles****FHWA Item 11 – Kilometerpoint***(Cannot be null.)*

The linear referencing system (LRS) milepost is used to establish the location of the bridge on the Base Highway Network (see WSBIS Item 1484). It must be from the same LRS route and milepost system as reported in the Highway Performance Monitoring System (HPMS). The milepost coded in this item directly relates to WSBIS Item 1467 – LRS Route.

This item records the milepost at the beginning of the structure (the lowest milepost on the structure). When the LRS Route goes under the structure (WSBIS Item 1432 coded 2 or A-Z), then code the milepost on the under passing route where the structure is first encountered.

Code to two decimal places. Code all zeroes in this field if the milepost is not available.

WSBIS Item 1483 – National Highway System**FHWA Item 104 – Highway System of the Inventory Route***(Cannot be null.)*

For the inventory route identified in WSBIS Item 1435, indicate whether the route is on the National Highway System (NHS) or not on that system. **Ramps associated with NHS routes are included as NHS routes.** Use one of the following codes:

Code	Description
0	Inventory Route is not on the NHS
1	Inventory Route is on the NHS

NBI Commentary:

WSDOT codes ramps as NHS routes when the associated mainline route is also NHS, in accordance with the federal coding guide. However, in accordance with the FHWA Highway Performance Monitoring System (HPMS), ramps are coded 0.

WSBIS Item 1484 – Base Highway Network**FHWA Item 12 – Base Highway Network***(Cannot be null.)*

The Base Highway Network includes the mainline portions of the NHS (WSBIS Item 1483 is coded 1), rural/urban principal arterial system and rural minor arterial system (WSBIS Item 1487 is coded 01, 02, 06, 11, 12 or 14). Ramps, frontage roads and other roadways are not included in the Base Network. For the inventory route identified in WSBIS Item 1435 – Inventory Route, use one of the following codes:

Code	Description
0	Inventory Route is not on the Base Network
1	Inventory Route is on the Base Network

WSBIS Item 1485 – STRAHNET Highway**FHWA Item 100 – STRAHNET Highway Designation***(Cannot be null.)*

This item shall be coded for all records in the inventory that are designated as part of the Strategic Highway Network. For the purposes of this item, the STRAHNET Connectors are considered included in the term STRAHNET. For the inventory route identified in WSBIS Item 1435, indicate STRAHNET highway conditions using one of the following codes:

Code	Description
0	The inventory route is not a STRAHNET route
1	The inventory route is on an Interstate STRAHNET route
2	The inventory route is on a Non-Interstate STRAHNET route
3	The inventory route is on a STRAHNET connector route

WSBIS Item 1486 – Federal Lands Highways**FHWA Item 105 – Federal Lands Highways***(Cannot be null.)*

Code zeroes for this field.

NBI Commentary:

WSDOT has not been able to identify a source for this data, and will code zeroes until an information source is identified.

WSBIS Item 1487 – Functional Classification

FHWA Item 26 – Functional Classification of Inventory Route

(Cannot be null.)

For the inventory route, code the functional classification using one of the following codes:

Code	Description
01	Rural Principal Arterial – Interstate
02	Rural Principal Arterial – Other
06	Rural Minor Arterial
07	Rural Major Collector
08	Rural Minor Collector
09	Rural Local
11	Urban Principal Arterial – Interstate
12	Urban Principal Arterial – Other Freeways or Expressways
14	Urban Other Principal Arterial
16	Urban Minor Arterial
17	Urban Collector
19	Urban Local

The bridge shall be coded rural if not inside a designated urban area. The urban or rural designation shall be determined by the bridge location and not the character of the roadway. The WSDOT Functional Classification Map is available at www.wsdot.wa.gov/mapsdata/travel/hpms/functionalclass.htm.

WSBIS Item 1489 – National Truck Network

FHWA Item 110 – Designated National Network

(Cannot be null.)

The national network for trucks includes most of the Interstate System and those portions of Federal-aid highways identified in the Code of Federal Regulations (23 CFR 658). The national network for trucks is available for use by commercial motor vehicles of the dimensions and configurations described in these regulations. For the inventory route identified in WSBIS Item 1435, indicate conditions using one of the following codes:

WSDOT Code	NBI Code	Description
N	0	The inventory route is not part of the national network for trucks
Y	1	The inventory route is part of the national network for trucks

WSBIS Item 1490 – Lane Use Direction

FHWA Item 102 – Direction of Traffic*(Cannot be null.)*

Code the direction of traffic of the inventory route identified in WSBIS Item 1435 as a 1-digit number using one of the codes below. This item must be compatible with other traffic-related items such as WSBIS Item 1352 – Lanes on the Structure, WSBIS Item 1445 – Average Daily Traffic, WSBIS Item 1491 – Total Horizontal Clearance and WSBIS Item 1356 – Curb-to-Curb.

WSDOT Code	NBI Code	Description
0	0	No highway traffic on inventory route
1	1	1 way traffic on inventory route
2	2	2 way traffic on inventory route
3	2	2 way and reversible traffic on inventory route
4	1	Reversible traffic only on inventory route
5	3	2 way traffic on 1 lane bridge (curb-to-curb must be <16 ft.)

NBI Commentary:

WSDOT provides additional codes to address reversible traffic lanes, which are translated to NBI codes as shown above.

WSBIS Item 1354 – Lanes Under

FHWA Item 28B – Lanes Under the Structure*(Cannot be null.)*

Code the number of lanes under the structure.

For On records, code WSBIS Item 1354 for all lanes under the bridge for all routes that are functionally classified (see WSBIS Item 1487).

For Under records, code WSBIS Item 1354 for only the lanes associated with the inventory route under.

Include all lanes carrying highway traffic (e.g., cars, trucks, buses) which are striped or otherwise operated as a full width traffic lane under the structure. This shall include any full width merge lanes and ramp lanes, and shall be independent of directionality of usage.

WSBIS Item 1445 – ADT**XXXXXX****FHWA Item 29 – Average Daily Traffic***(Cannot be null.)*

Code the average daily traffic (ADT) volume for the inventory route. Code the most recent ADT counts available. Included in this item are the trucks referred to in WSBIS Item 1451 – Average Daily Truck Traffic. If the bridge is closed, code the actual ADT from before the closure occurred.

The ADT must be compatible with the other items coded for the bridge. For example, parallel bridges with an open median are coded as follows: if WSBIS Item 1352 – Lanes On the Structure and WSBIS Item 1356 – Curb-to-Curb are coded for each bridge separately, then the ADT must be coded for each bridge separately (not the total ADT for the route).

ADT information is available at www.wsdot.wa.gov/mapsdata/tools/traffictrends/.

WSBIS Item 1451 – ADT Truck Percentage**(XX percent)****FHWA Item 109 – Average Daily Truck Traffic***(Cannot be null.)*

Code the percentage of WSBIS Item 1445 – Average Daily Traffic that is truck traffic on the inventory route. Do not include vans, pickup trucks and other light delivery trucks in this percentage.

NBI Commentary:

The NBI does not require data for Average Daily Truck Traffic if WSBIS Item 1445, ADT, is less than 100. WSDOT requires this data for all routes, regardless of ADT.

WSBIS Item 1453 – ADT Year**FHWA Item 30 – Year of Average Daily Traffic***(Cannot be null.)*

Record the year represented by the ADT in WSBIS Item 1445. Code all four digits of the year.

ADT Year information is available at the link in WSBIS Item 1445.

WSBIS Item 1457 – Future ADT**FHWA Item 114 – Future Average Daily Traffic***(Cannot be null if inventory route is on the bridge, must be null if inventory route is under the bridge.)*

Code the forecasted average daily traffic (ADT) for the inventory route. This shall be projected at least 17 years but no more than 22 years from the last year of routine inspection. If planning data is not available, use the best estimate based on site familiarity.

The future ADT must be compatible with the other items coded for the bridge. For example, parallel bridges with an open median are coded as follows: if WSBIS Item 1352 – Lanes On the Structure and WSBIS Item 1356 – Curb-to-Curb are coded for each bridge separately, then the future ADT must be coded for each bridge separately (not the total for the route).

WSBIS Item 1463 – Future ADT Year**FHWA Item 115 – Year of Future Average Daily Traffic**

(Cannot be null if inventory route is on the bridge, must be null if inventory route is under the bridge.)

Code the year represented by the future ADT in WSBIS Item 1457. The projected year of future ADT shall be at least 17 years but no more than 22 years from the year of routine, short span, or safety inspection.

WSBIS Item 1413 – Detour Length**(XX miles)****FHWA Item 19 – Bypass, Detour Length**

(Cannot be null.)

Indicate the actual length to the nearest mile of the detour length, which is considered the additional travel needed to return to the original route if the bridge is closed.

If a ground level bypass is available at the structure site for the inventory route (ramps at a diamond interchange, for example), code the detour length as 0.

If the detour exceeds 99 miles, code 99.

If the bridge is one of twin bridges and is not at an interchange, code 1 where the other twin bridge can be used as a temporary bypass with a reasonable amount of crossover grading.

Code 0 for routes under the structure, on the basis that a failed bridge over the route can be removed to allow passage.

To the extent practical, the detour route should match the capacity and functionality of the original route. When this is not possible the following minimum standards shall apply:

1. The detour route cannot have weight restrictions lower than the original route.
2. The detour route cannot have vertical clearance limits over the roadway lanes less than 14 feet 3 inches (as measured) unless the original route also has vertical clearance restrictions, in which case the detour cannot further restrict clearances.

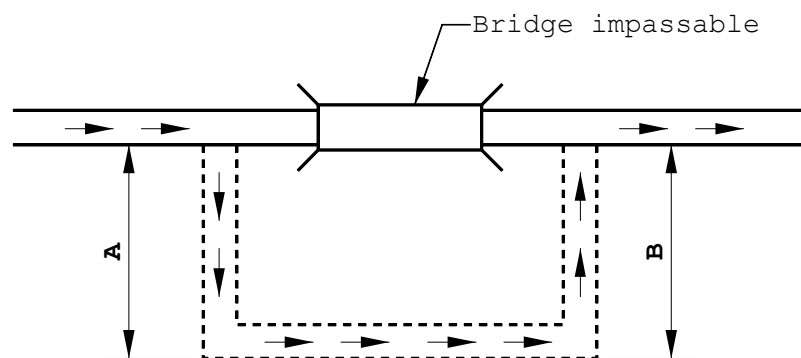

$$\text{Detour Length} = A + B$$

Figure WSBIS-1413

NBI Commentary:

This coding guide provides additional direction on how to code routes under the structure, and additional criteria for determining acceptable detour routes.

WSBIS Item 2410– Federally Reportable Flag*(Cannot be null.)*

Indicate if the crossing record is to be included in the National Bridge Inventory data submittal or not.

For state owned structures, this item is coded by the BPO Information Group and is visible in BridgeWorks Inventory Management mode.

WSBIS Item 2411– Bridge List*(Cannot be null.)*

Indicate if the crossing record is to be included **or not** in the *Bridge List Manual M 23-09*.

For state owned structures, this item is coded by the BPO Information Group and is visible in BridgeWorks Inventory Management mode.

Code	Description
1	The crossing record is included in the Bridge List.
2	The crossing record is NOT included in the Bridge List.

WSBIS Item 1491 – Horizontal Clearance, Route Direction**(XXXX feet & inches)**

WSBIS Item 1495 – Horizontal Clearance, Reverse Direction (XXXX feet & inches)

FHWA Item 47 – Inventory Route, Total Horizontal Clearance
(Cannot both be null.)

The horizontal clearance for the inventory route should be measured and recorded for each opening between restrictive features – curbs, rails, guardrails, walls, piers, slopes, or other structural features limiting the roadway (surface and shoulders).

The purpose of this item is to give the largest available clearance for the movement of wide loads. Flush and mountable medians are not considered to be restrictions. This clearance is defined in two ways:

1. Clear distance between restrictions of the inventory route either on or under the structure.
2. Roadway surface and shoulders when there are no other restrictions.

When the entire inventory route passes through a single opening, code the measurement in WSBIS Item 1491 and WSBIS Item 1495 blank.

When the inventory route passes through multiple openings, code WSBIS Item 1491 and WSBIS Item 1495 for the mainline as appropriate.

When a restriction is 100 feet or greater, code 9912.

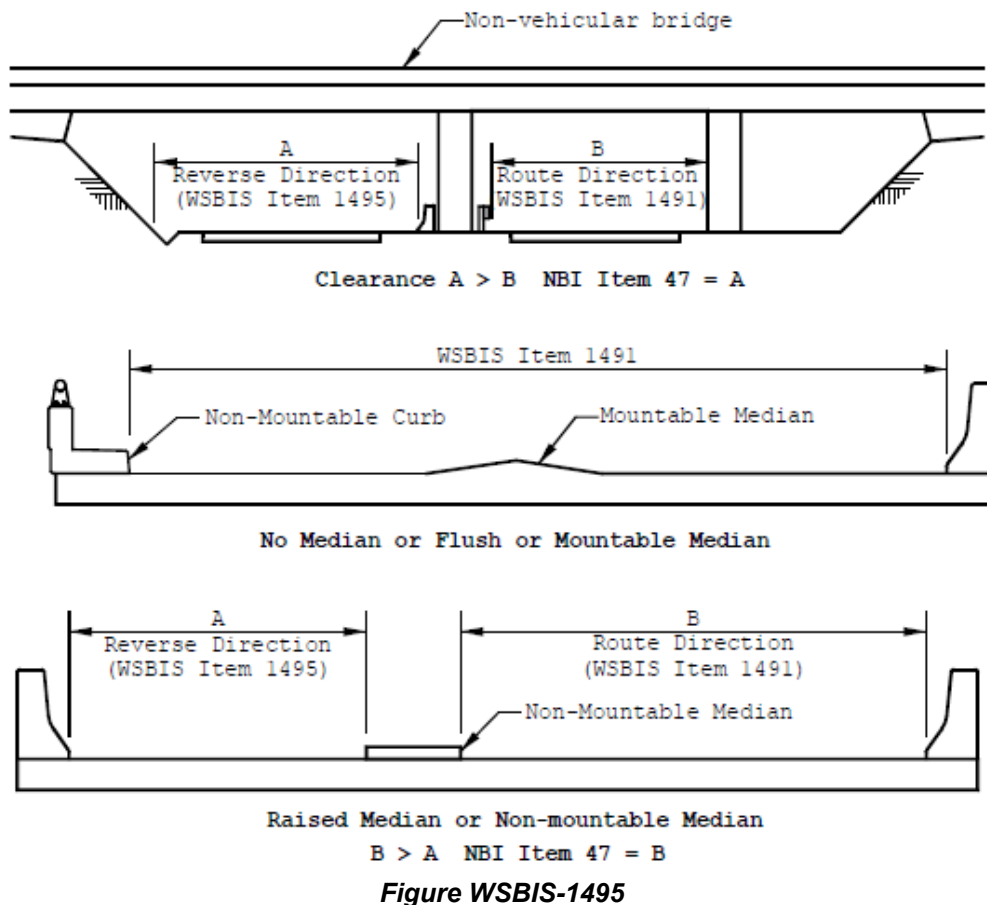

NBI Commentary:

The NBI requires coding only the maximum horizontal clearance for divided highways. WSBIS has two fields. When the NBI submittal is prepared, the largest dimension is selected and reported.

WSBIS Item 1499 – Maximum Vertical Clearance Route Direction

(XXXX feet & inches)

FHWA Item 10 – Inventory Route, Minimum Vertical Clearance

(Null when no restriction exists.)

Code the practical maximum vertical clearance over the inventory route identified in WSBIS Item 1435, in the direction of increasing mileposts, whether the route is on the structure or under the structure. This field identifies the minimum vertical clearance for the lane that will carry the highest load, regardless of the direction of travel. When no restriction exists leave this item blank. When the restriction is 100 feet or greater code 9912.

To accurately code this field, all vertical clearance measurements for the inventory route must be collected over all lane stripes and at edges of pavement, recorded in a vertical clearance card, and kept on file.

Example:

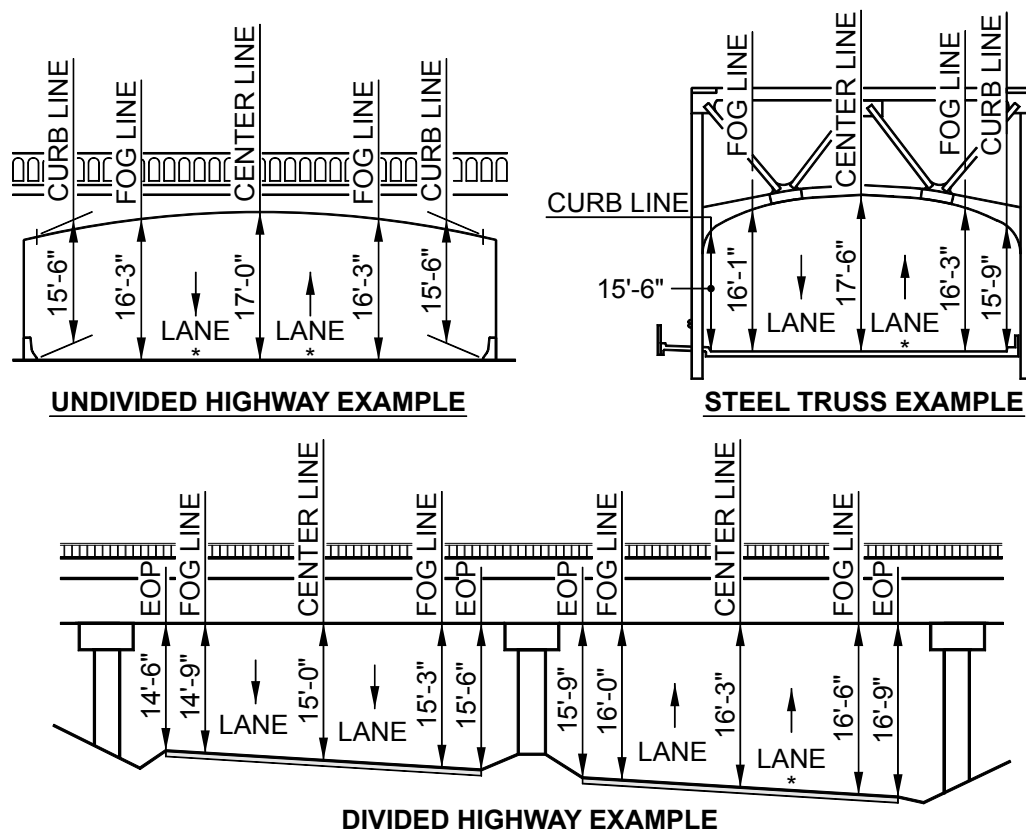

Code "1603": The maximum vertical height allowed in any 10 foot roadway width is the least vertical clearance in the lane of roadway with the maximum vertical clearance.

* Controlling Lane.

Figure WSBIS-1499

NBI Commentary:

The NBI coding guide indicates that this measurement should be the minimum clearance for a 10 foot width of pavement or travelled part of the roadway. However, from a practical perspective this has been interpreted in this coding guide as the clearance for the lane that will pass the tallest load. The lanes are defined by striping.

WSBIS Item 2500 – Minimum Vertical Clearance Route Direction (XXXX feet & inches)

(Null when no restriction exists.)

Code the practical minimum vertical clearance over the inventory route identified in WSBIS Item 1435, in the direction of increasing mileposts, whether the route is on the structure or under the structure.

For state owned structures, this item is coded by the BPO Information Group and is visible in BridgeWorks Inventory Management mode.

WSBIS Item 2501 – Maximum Vertical Clearance Reverse Direction (XXXX feet & inches)

(Null when route is an undivided highway or when no restriction exists.)

Code the practical maximum vertical clearance over the inventory route identified in WSBIS Item 1435, in the direction of decreasing mileposts, whether the route is on the structure or under the structure.

For state owned structures, this item is coded by the BPO Information Group and is visible in BridgeWorks Inventory Management mode.

WSBIS Item 2502 – Minimum Vertical Clearance Reverse Direction (XXXX feet & inches)

(Null when route is an undivided highway or when no restriction exists.)

Code the practical minimum vertical clearance over the inventory route identified in WSBIS Item 1435, in the direction of decreasing mileposts, whether the route is on the structure or under the structure.

For state owned structures, this item is coded by the BPO Information Group and is visible in BridgeWorks Inventory Management mode.

WSBIS Item 1156 – Location

FHWA Item 9 – Location

(Cannot be null.)

This item contains a narrative description of the bridge location for the inventory route. Descriptions should be oriented ahead on station whenever possible. Do not use city limits, as these boundaries may move. This item shall be left justified.

Examples:

19.3 E JCT SR 203
14.7 E MASON CO

On the Crossing tab, this item is used to code the location for all Secondary Listings for publication of the *Bridge List* M 23-09. Main Listings are coded on the Bridge ID tab.

For state owned structures, this item is coded by the BPO Information Group and is visible in BridgeWorks Inventory Management mode.

WSBIS Item 1157– Description

(Cannot be null.)

This item is used to code the description for all Secondary Listings and is visible in BridgeWorks Inventory Management mode. (Main Listings are coded as the bridge name, WSBIS Item 2132.) The description should be relevant to the inventory route, whether it is on or under the bridge.

Examples:

MAIN ST OVER I-405
I-405 UNDER MAIN ST
NBCD UNDER MAIN ST
I-405 UNDER NE 80TH ST PED
NORTH CREEK

The description is used in the publication of the Bridge List. Therefore, this item is coded for all crossing records for state owned bridges.

For state owned structures, this item is coded by the BPO Information Group.

WSBIS Item 2401– Crossing Manager

(Cannot be null.)

The Crossing Manager is the Program Manager responsible for the route identified in WSBIS Item 1435, whether that route is on or under the structure.

For state owned structures, this item is coded by the BPO Information Group and is visible in BridgeWorks Inventory Management mode.

Design Tab (Formerly WB75)

WSBIS Item 1532 – Main Span Material

FHWA Item 43A – Structure Type, Main, Kind of Material

(Cannot be null.)

Indicate the kind of material and/or design for the main span.

Code	Description
1	Concrete
2	Concrete continuous
3	Steel
4	Steel continuous
5	Prestressed and/or post-tensioned concrete
6	Prestressed and/or post-tensioned concrete continuous
7	Wood or Timber
8	Masonry
9	Aluminum, Wrought Iron, or Cast Iron
0	Other (also to be used when not applicable for approach spans)

WSBIS Item 1533 – Main Span Design**FHWA Item 43B – Structure Type, Main, Type of Design***(Cannot be null.)*

Indicate the predominant type of design and/or type of construction.

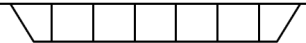
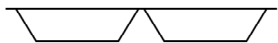
Code	Description	
01	Slab	
02	Stringer/Multibeam or Girder	
03	Girder and Floorbeam System	
04	Tee Beam	
05	Box Beam or Girders – Multiple	
06	Box Beam or Girders – Single or Spread	
07	Frame (except frame culverts)	
08	Orthotropic	
09	Truss – Deck	
10	Truss – Thru	
11	Arch – Deck	
12	Arch – Thru	
13	Suspension	
14	Stayed Girder	
15	Movable – Lift	
16	Movable – Bascule	
17	Movable – Swing	
18	Tunnel	
19	Culvert (includes frame culverts)	
20*	Mixed types	
21	Segmental Box Girder	
22	Channel Beam (Bathtub Unit)	
00	Other (also to be used when not applicable for approach spans)	

*Applicable only to approach spans – WSBIS Item 1536

Examples:

Wood or Timber Through Truss = 710

Masonry Culvert = 819

Steel Suspension = 313

Continuous Concrete Multiple Box Girders = 205

Simple Span Concrete Slab = 101

Tunnel in Rock = 018

WSBIS Item 1535 – Approach Span Material

FHWA Item 44A – Structure Type, Approach Spans, Kind of Material

(Cannot be null.)

Indicate the type of structure for the approach spans to a major bridge or for the spans where the structural material is different. The codes are the same as for WSBIS Item 1532. If the kind of material is varied, code the most predominant.

Code 0 if this item is not applicable.

WSBIS Item 1536 – Approach Span Design

FHWA Item 44B – Structure Type, Approach Spans, Type of Design

(Cannot be null.)

Indicate the type of structure for the approach spans to a major bridge or for the spans where the structural material is different. The codes are the same as for WSBIS Item 1533. Use code 20 when no one type of design and/or construction is predominant for the approach units.

Code 00 if this item is not applicable.

WSBIS Item 2537 – Alpha Span Type*(Cannot be null.)*

The alphabetic span type is coded in BridgeWorks application in Inventory Management mode. Use one of the following acronyms:

Alpha Span Type	Description	Alpha Span Type	Description
3SCCulv	3 Sided Concrete Culvert	PRCB	Precast Reinforced Concrete Beam
3STCulv	3 Sided Timber Culvert	PTCBox	Post-Tensioned Concrete Box Girder
BAS	Bascule Lift Span	PTCSeg	Post-Tensioned Segmental Box Girder
CA	Concrete Arch	PTCTB	Post-Tensioned Concrete T-Beam
CBox	Concrete Box Girder	SA	Steel Arch
CCulv	Concrete Culvert	SBox	Steel Box Girder
CEFA	Concrete Earth Filled Arch	SCulv	Steel Culvert
CESB	Concrete Encased Steel Beam	SFP	Steel Floating Pontoon
CFP	Concrete Floating Pontoon	SG	Steel Girder (weld or rivet)
CG	Concrete Girder	SLS	Steel Lift Span
CLTun	Concrete Lined Tunnel	SRB	Steel Rolled Beam
CS	Concrete Slab	SSCG	Steel Stayed Concrete Girder
CSS	Cable Stayed Span	SSusS	Steel Suspension Span
CSTP	Concrete Slab on Timber Piling	SSwS	Steel Swing Span
CTB	Concrete T-Beam	STA	Steel Tied Arch
CTrus	Concrete Truss	STrus	Steel Truss
CVS	Concrete Voids Slab	TCulv	Timber Culvert
LIDTun	Cut and Cover (LID) Tunnel	TLTun	Timber Lined Tunnel
MCulv	Masonry Culvert	TS	Timber Slab
PCB	Prestressed Concrete Beam (superseded by PCG)	TTC	Treated Timber (Creosote) Bridge
PCBTG	Prestressed Concrete Bulb-T Girder	TTLB	Treated Timber Laminated Beam
PCG	Prestressed Concrete Girder	TTS	Treated Timber (Salts) Bridge
PCMWG	Prestressed Concrete Multi-Web Girder	TTTrus	Treated Timber Truss
PCS	Prestressed Concrete Slab	UT	Untreated Timber Bridge
PCTG	Prestressed Concrete Trapezoidal Girder	UTLB	Untreated Timber Laminated Beam
Plaza	Park Plaza Structures	UTTrus	Untreated Timber Truss
POBX	Post-Tensioned Box Girder (superseded by PTCBox)	UTun	Unlined Tunnel
		WSBox	Weathering Steel Box Girder
		WSG	Weathering Steel Girder

WSBIS Item 1538 – Number of Main Spans**FHWA Item 45 – Number of Spans in Main Unit***(Cannot be null.)*

Record the number of spans in the main or major unit. This item will include all spans of most bridges, the major unit only of a sizable structure, or a unit of material or design different from that of the approach spans.

A span that contains a drop-in span with cantilevers, or two cantilever spans with a hinge, is counted as one span (from pier to pier). Cantilever end spans are counted separately.

WSBIS Item 1541 – Number of Approach Spans**FHWA Item 46 – Number of Approach Spans***(Cannot be null.)*

Record the number of approach spans to the major bridge, or the number of spans of material different from that of the major bridge.

Code 0 if this item is not applicable.

NBI Commentary:

This coding guide requires coding zeroes when there are no approach spans. The NBI coding guide doesn't provide guidance.

WSBIS Item 1544 – Service On**FHWA Item 42A – Type of Service On Bridge***(Cannot be null.)*

Code	Description
1	Highway
2	Railroad
3	Pedestrian-bicycle
4	Highway-railroad
5	Highway-pedestrian
6	Overpass structure at an interchange or second level of a multilevel interchange
7	Third level (Interchange)
8	Fourth level (Interchange)
9	Building or plaza
0	Other

WSBIS Item 1545 – Service Under**FHWA Item 42B – Type of Service Under Bridge***(Cannot be null.)*

Code	Description
1	Highway, with or without pedestrian
2	Railroad
3	Pedestrian-bicycle
4	Highway-railroad
5	Waterway
6	Highway-waterway
7	Railroad-waterway
8	Highway-waterway-railroad
9	Relief for waterway
0	Other

WSBIS Item 1546 – Deck Type

FHWA Item 107 – Deck Structure Type

(Cannot be null.)

Record the type of deck system on the bridge. If more than one type of deck system is on the bridge, code the most predominant. Code **A** for a filled culvert or arch with the approach roadway section carried across the structure.

Main Listing Under records (e.g., railroad bridges and pedestrian bridges) are to be coded N, with the following exception: WSDOT owned pedestrian bridges are to be coded with the appropriate Deck Type.

Use one of the following codes:

WSDOT Code	NBI Code	Description
1	1	Concrete Cast-in-Place
2	2	Concrete Precast Panels
3	3	Steel Grating – Open
4	4	Steel Grating – Filled with Concrete
5	5	Steel plate (includes orthotropic)
6	6	Corrugated Steel
7	7	Aluminum
8	8	Treated timber
9	8	Untreated timber
0	9	Other
A	9	Filled arches
B	9	Precast integral with beam
N	N	Not applicable (no deck)

NBI Commentary:

WSDOT provides additional codes which are translated to NBI codes as shown above.

FHWA Item 108 – Wearing Surface/Protective System

(Cannot be null.)

Information on the wearing surface and protective system of the bridge deck shall be coded using a 3-digit code composed of three segments, WSBIS Items 1547, 1548 and 1549.

Main Listing Under records (e.g., railroad bridges and pedestrian bridges) are to be coded N, with the following exception: WSDOT owned pedestrian bridges are to be coded with the appropriate Wearing Surface/Protective system codes.

WSBIS Item 1547 – Wearing Surface**FHWA Item 108A – Type of Wearing Surface**

Code	Description
1	Monolithic Concrete (concurrently placed with structural deck)
2	Integral Concrete (separate non-modified layer of concrete added to structural deck)
3	Latex Concrete or similar additive
4	Low Slump Concrete
5	Epoxy Overlay
6	Bituminous (ACP or BST)
7	Timber
8	Gravel
9	Other
0	None (no additional concrete thickness or wearing surface is included in the bridge deck)
N	Not Applicable (applies only to structures with no deck)

WSBIS Item 1548 – Membrane**FHWA Item 108B – Type of Membrane**

Code	Description
1	Built-up
2	Preformed Fabric
3	Epoxy
8	Unknown
9	Other
0	None
N	Not Applicable (applies to structures with no deck)

WSBIS Item 1549 – Deck Protection**FHWA Item 108C – Deck Protection**

Code	Description
1	Epoxy Coated Reinforcing
2	Galvanized Reinforcing
3	Other Coated Reinforcing
4	Cathodic Protection
6	Polymer Impregnated
7	Internally Sealed
8	Unknown
9	Other
0	None
N	Not Applicable (applies to structures with no deck)

WSBIS Item 1550 – Design Load**FHWA Item 31 – Design Load**

(Cannot be null if bridge has an On record, must be null if the bridge does not have an On record.)

Use the codes below to indicate the live load for which the structure was designed. The numerical value of the railroad loading should be recorded on the form. Classify any other loading, when feasible, using the nearest equivalent of the loadings given below.

Code	Metric Description	English Description
0	Unknown	Unknown
1	M 9	H 10
2	M 13.5	H 15
3	MS 13.5	HS 15
4	M 18	H 20
5	MS 18	HS 20
6	MS 18 + Mod	HS 20 + Mod
7	Pedestrian	Pedestrian
8	Railroad	Railroad
9	MS 22.5 or greater	HS 25 or greater
A	HL 93	HL 93
B	Greater than HL 93	Greater than HL 93
C	Other	Other

NBI Commentary:

This field has been revised based on a February 2, 2011 FHWA memo available at www.fhwa.dot.gov/bridge/110202.cfm.

**TEMPLATE
To
UPDATE LOAD RATINGS**

(Actual Summary Sheets may vary)

BRIDGE RATING SUMMARY

Bridge Name: WSBIS Item 2132 – check for accuracy
 Bridge Number: WSBIS Item 2009 – check for accuracy
 Structure ID: WSBIS Item 1001 – check for accuracy
 Span Types: WSBIS Item 2537 – check for accuracy
 Bridge Length: WSBIS Item 1340 – check for accuracy
 Design Load: WSBIS Item 1550 – check for accuracy
 Rated By: WSBIS Item 2582 – code/update
 Checked By: _____
 Date: WSBIS Item 2581 – code/update

Inspection Report Date: <u>2580 – code/update</u>	Deck Condition	<input type="text"/>
Rating Method: <u>1551 – code/update</u>	Superstructure Condition	<input type="text"/>
Overlay Thickness: _____	Substructure Condition	<input type="text"/>

<u>Truck</u>	<u>RF (INV)</u>	<u>RF (OPR)</u>	<u>Controlling Point</u>
AASHTO 1		WSBIS Item 2587 – code/update	
AASHTO 2		WSBIS Item 2588 – code/update	
AASHTO 3		WSBIS Item 2589 – code/update	
NRL		WSBIS Item 2590 – code/update	
SU4		WSBIS Item 2591 – code/update	
SU5		WSBIS Item 2592 – code/update	
SU6		WSBIS Item 2593 – code/update	
SU7		WSBIS Item 2594 – code/update	
OL-1		WSBIS Item 2595 – code/update	
OL-2		WSBIS Item 2596 – code/update	

<u>NBI Rating</u>	<u>RF</u>	<u>TONS</u>	<u>Controlling Point</u>
Inventory (HS20)		WSBIS Items 1552 and/or 1553 – code/update	
Operating (HS20)		WSBIS Items 1555 and/or 1556 – code/update	

Remarks:

WSBIS Item 2580 – Reference Inspection Date

(Cannot be null if bridge has an On record and must be null if the bridge does not have an On record.)

Code the inspection report date used for the load rating calculations. Usually this field will be coded or updated by transcribing information from the most current Load Rating Summary Sheet, see Figure WSBIS 2580.

WSBIS Item 2581 – Load Rating Date

(Cannot be null if bridge has an On record and must be null if the bridge does not have an On record.)

Code the load rating calculation date. Usually this field will be coded or updated by transcribing information from the most current Load Rating Summary Sheet, see Figure WSBIS 2580.

WSBIS Item 2582 – Rated By

(Cannot be null if bridge has an On record and must be null if the bridge does not have an On record.)

Code the initials or engineering firm name indicating who performed the load rating. Usually this field will be coded or updated by transcribing information from the most current Load Rating Summary Sheet, see Figure WSBIS 2580.

WSBIS Item 2587 – Type 3 Rating Factor

(XX.XX rating factor)

(Cannot be null if bridge has an On record and must be null if the bridge does not have an On record.)

Code the rating factor for the AASHTO Type 3 legal load truck as defined within the AASHTO Manual for Bridge Evaluation (MBE)-Section 6. If the Load Factor or Working Stress method is used to rate this structure, enter the Operating Rating factor only.

Usually this field will be coded or updated by transcribing information from the most current Load Rating Summary Sheet, see Figure WSBIS 2580.

WSBIS Item 2588 – Type 3S2 Rating Factor

(XX.XX rating factor)

(Cannot be null if bridge has an On record and must be null if the bridge does not have an On record.)

Code the rating factor for the AASHTO Type 3S2 legal load truck as defined within the AASHTO Manual for Bridge Evaluation (MBE)-Section 6. If the Load Factor or Working Stress method is used to rate this structure, enter the Operating Rating factor only.

Usually this field will be coded or updated by transcribing information from the most current Load Rating Summary Sheet, see Figure WSBIS 2580.

WSBIS Item 2589 – Type 3-3 Rating Factor**(XX.XX rating factor)**

(Cannot be null if bridge has an On record and must be null if the bridge does not have an On record.)

Code the rating factor for the AASHTO Type 3-3 legal load truck as defined within the AASHTO Manual for Bridge Evaluation (MBE)-Section 6. If the Load Factor or Working Stress method is used to rate this structure, enter the Operating Rating factor only.

Usually this field will be coded or updated by transcribing information from the most current Load Rating Summary Sheet, see Figure WSBIS 2580.

WSBIS Item 2590 – Notional Rating Load (NRL) Rating Factor**(XX.XX rating factor)**

(Cannot be null if bridge has an On record and must be null if the bridge does not have an On record.)

Code the rating factor for the AASHTO Notional Rating Load (NRL) as defined within the AASHTO Manual for Bridge Evaluation (MBE)-Section 6. If the Load Factor or Working Stress method is used to rate this structure, enter the Operating Rating factor only.

Usually this field will be coded or updated by transcribing information from the most current Load Rating Summary Sheet, see Figure WSBIS 2580.

WSBIS Item 2591 – Single Unit 4 (SU4) Rating Factor**(XX.XX rating factor)**

(Must be null if the bridge does not have an On record, see below for other Null conditions.)

Code the rating factor for the AASHTO SU4 legal load truck as defined within the AASHTO Manual for Bridge Evaluation (MBE)-Section 6. If the Load Factor or Working Stress method is used to rate this structure, enter the Operating Rating factor only.

Usually this field will be coded or updated by transcribing information from the most current Load Rating Summary Sheet, see Figure WSBIS 2580.

This field can be null if WSBIS Item 2590 (NRL) is populated and equal to or greater than 1.00.

WSBIS Item 2592 – Single Unit 5 (SU5) Rating Factor**(XX.XX rating factor)**

(Must be null if the bridge does not have an On record, see below for other Null conditions.)

Code the rating factor for the AASHTO SU5 legal load truck as defined within the AASHTO Manual for Bridge Evaluation (MBE)-Section 6. If the Load Factor or Working Stress method is used to rate this structure, enter the Operating Rating factor only.

Usually this field will be coded or updated by transcribing information from the most current Load Rating Summary Sheet, see Figure WSBIS 2580.

This field can be null if WSBIS Item 2590 (NRL) is populated and equal to or greater than 1.00.

WSBIS Item 2593 – Single Unit 6 (SU6) Rating Factor (XX.XX rating factor)

(Must be null if the bridge does not have an On record, see below for other Null conditions.)

Code the rating factor for the AASHTO SU6 legal load as defined within the AASHTO Manual for Bridge Evaluation (MBE)-Section 6. If the Load Factor or Working Stress method is used to rate this structure, enter the Operating Rating factor only.

Usually this field will be coded or updated by transcribing information from the most current Load Rating Summary Sheet, see Figure WSBIS 2580.

This field can be null if WSBIS Item 2590 (NRL) is populated and equal to or greater than 1.00.

WSBIS Item 2594 – Single Unit 7 (SU7) Rating Factor (XX.XX rating factor)

(Must be null if the bridge does not have an On record, see below for other Null conditions.)

Code the rating factor for the AASHTO SU7 legal load as defined within the AASHTO Manual for Bridge Evaluation (MBE)-Section 6. If the Load Factor or Working Stress method is used to rate this structure, enter the Operating Rating factor only.

Usually this field will be coded or updated by transcribing information from the most current Load Rating Summary Sheet, see Figure WSBIS 2580.

This field can be null if WSBIS Item 2590 (NRL) is populated and equal to or greater than 1.00.

WSBIS Item 2595 – Overload 1 (OL-1) Rating Factor (XX.XX rating factor)

(Cannot be null if bridge has an On record and must be null if the bridge does not have an On record.)

Code the rating factor for the WSDOT Overload 1 (OL-1) permit load as defined within the WSDOT Bridge Design Manual (M23-50.14), Chapter 13. If the Load Factor or Working Stress method is used to rate this structure, enter the Operating Rating factor only.

Usually this field will be coded or updated by transcribing information from the most current Load Rating Summary Sheet, see Figure WSBIS 2580.

WSBIS Item 2596 – Overload 2 (OL-2) Rating Factor (XX.XX rating factor)

(Cannot be null if bridge has an On record and must be null if the bridge does not have an On record.)

Code the rating factor for the WSDOT Overload 2 (OL-2) permit load as defined within the WSDOT Bridge Design Manual (M23-50.14), Chapter 13. If the Load Factor or Working Stress method is used to rate this structure, enter the Operating Rating factor only.

Usually this field will be coded or updated by transcribing information from the most current Load Rating Summary Sheet, see Figure WSBIS 2580.

WSBIS Item 1551 – Operating Rating Method

FHWA Item 63 – Method Used to Determine Operating Rating

(Cannot be null if bridge has an On record, must be null if the bridge does not have an On record.)

FHWA Item 063

Code this field with one of the following codes to indicate which load rating method was used to determine the rating for this bridge.

Codes used by WSDOT	Codes used by Local Agencies	Description
0	0	Field evaluation and documented engineering judgment reported in tons using HS20 loading
1	1	Load Factor (LF) reported in tons using HS20 loading
2	2	Allowable Stress (AS) reported in tons using HS20 loading
-	3	Load and Resistance Factor (LRFR) reported in tons
4	4	Load Testing reported in tons using HS20 loading
5	5	No rating analysis or evaluation performed
-	6	Load Factor (LF) rating reported by rating factor method using HS20 loading
-	7	Allowable Stress (AS) rating reported by rating factor method using HS20 loading
8	8	Load and Resistance Factor Rating (LRFR) reported by rating factor method using HL93 loading
F	-	Assigned rating method based on Load and Resistance Factor Design (LRFD) reported by rating factor using HL93 loading

Note: WSDOT uses codes 0, 1, 2, 4, 5, 8 and F. Local Agencies shall use codes 0 through 8.

Code 0 is to be used when the load rating is determined by field evaluation and documented engineering judgment, typically done when plans are not available for concrete structures or in cases of severe deterioration. Field evaluation and engineering judgment ratings must be documented. See Chapter 5 for additional guidance.

Code 5 is to be used when the bridge has not been load rated or load rating documentation does not exist.

NBI Commentary:

WSBIS Item 1551 has been modified based on a November 15, 2011 FHWA Memo available at www.fhwa.dot.gov/bridge/nbi/111115.cfm.

Codes A through E are not available in WSBIS because there are no agencies which use these methods.

WSBIS Item 1552 – Operating Rating Tons

(XX tons)**FHWA Item 64 – Operating Rating**

(Cannot be null if bridge has an On record and WSBIS Item 1551 is coded 0 through 4. Must be null if the bridge does not have an On record, or WSBIS Item 1551 is coded 5 through 8 or F.)

WSDOT enters rating data into the database as English tonnage for all cases noted in WSBIS Items 1551 and 1554 which have methods coded 0 through 4. For methods coded 5 through 8 or F, use WSBIS Items 1553 and 1556 to enter the rating factor.

The following text defines both WSBIS Item 1552 – Operating Rating Tons and WSBIS Item 1555 – Inventory Rating Tons.

WSDOT enters rating tons as a 2-digit number. For values greater than 99 tons, enter 99.

If the bridge will not carry a minimum of 3 tons of live load, the operating rating tons shall be coded 0; and, consistent with the direction of the AASHTO Manual, it shall be closed.

The use or presence of a temporary bridge requires special consideration in coding. In such cases, since there is no permanent bridge, the inventory and operating rating tons should be coded 0 even though the temporary structure is rated for as much as full legal load.

A bridge shored up or repaired on a temporary basis is considered a temporary bridge and the inventory and operating rating tons shall be coded as if the temporary shoring were not in place. See WSBIS Item 1289 – Temporary Structure Designation for definition of a temporary bridge.

For a bridge that is closed (WSBIS Item 1293 is coded K), operating and inventory rating tons shall be coded 0.

Code 99 for a structure under sufficient fill such that, according to AASHTO design, the live load stress on the structure is insignificant in the structure load capacity.

NBI Commentary:

WSBIS Items 1552 and 1555 have been modified based on a March 22, 2004, FHWA Memo available at www.fhwa.dot.gov/bridge/032204.htm.

Note: This field is no longer restricted to reporting HS20 loads only – by WSBIS Item 1551 definition, in some cases HL93 load cases are reported here. Additional clarification on how to code these fields was also added.

For reporting to the FHWA, this 2-digit number is converted to metric tons and reported as a 3-digit number, rounded to tenths.

WSBIS Item 1553 – Operating Rating Factor**(X.XX rating factor)****FHWA Item 64 – Operating Rating**

(Cannot be null if bridge has an On record and WSBIS Item 1551 is coded 5 through 8 or F. Must be null if the bridge does not have an On record, or WSBIS Item 1551 is coded 0 through 4.)

WSDOT enters rating data as factors for all cases noted in WSBIS Items 1551 and 1554 which have methods coded 5 through 8 or F. For methods coded 0 through 4, use WSBIS Items 1552 and 1555 to enter rating tonnage.

If WSBIS Item 1551 – Operating Rating Method has been coded 5, for new structures, the operating rating shall be coded with a rating factor of 1.30.

If WSBIS Item 1554 – Inventory Rating Method has been coded 5, for new structures, the inventory rating shall be coded with a rating factor of 1.00.

NBI Commentary:

When this 3-digit number is reported in the NBI submittal, the FHWA multiplies it by 32.4 and rounds it to tenths. This number represents metric tons. Due to the fact the FHWA cannot currently process metric tons greater than 99.9, any rating factor greater than 3.08 is truncated to 99.9 metric tons upon conversion.

WSBIS Item 1554 – Inventory Rating Method**FHWA Item 65 – Method Used to Determine Inventory Rating**

See WSBIS Item 1551 for coding instructions.

WSBIS Item 1555 – Inventory Rating Tons**(XX tons)****FHWA Item 66 – Inventory Rating**

For Inventory Rating Methods coded 0 through 4, see WSBIS Item 1552 for rating tons coding instructions.

WSBIS Item 1556 – Inventory Rating Factor**(X.XX rating factor)****FHWA Item 66 – Inventory Rating**

For Inventory Rating Methods coded 5 through 8 or F, see WSBIS Item 1553 for rating factor coding instructions.

WSBIS Item 1585 – Border Bridge State Code

FHWA Item 98A – Border Bridge, Neighboring State Code

(If the bridge is not on a border, leave blank.)

Use this item to indicate structures crossing to Oregon or Idaho. Code a 3-digit number specifying which border state.

The neighboring state codes are:

Oregon 410
Idaho 160

NBI Commentary:

This field has been limited to codes relevant to Washington State.

WSBIS Item 1588 – Border Bridge Percent

FHWA Item 98B – Border Bridge, Percent Responsibility

(If the bridge is not on a border, leave blank.)

Code a 2-digit number specifying the percent responsibility for any bridge improvements born by the border state.

WSBIS Item 1590 – Border Bridge Structure Identifier

FHWA Item 99 – Border Bridge Structure Number

(If the bridge is not on a border, leave blank.)

Code the neighboring State's 15-digit National Bridge Inventory structure number for any structure noted in WSBIS Item 1585 – Border Bridge. This number must match exactly the neighboring State's submitted NBI structure number. The entire 15-digit field must be accounted for including zeroes and blank spaces whether they are leading, trailing, or embedded in the 15-digit field.

Proposed Improvements Tab (Formerly WB78)

The following Proposed Improvement items must be coded for bridges eligible for the Highway Bridge Replacement and Rehabilitation Program. To be eligible, a bridge must carry highway traffic, be structurally deficient and have a sufficiency rating of 80.0 or less. This item may be coded for other bridges at the option of the highway agency.

WSDOT maintains all proposed improvement data for all bridges. These codes are automatically populated for every bridge, but can be manually overridden as appropriate. If manual entry is to be done, use WSBIS Item 2883 to prevent automatic calculation.

NBI Commentary:

WSBIS allows up to seven digits each for Structure, Roadway and Total Costs (in thousands of dollars). Amounts coded greater than six digits will be converted to 999999 for the NBI data submittal.

WSBIS Item 1844 – Work Type

FHWA Item 75A – Type of Work Proposed Use one of the following codes to represent the proposed work type:

Code	Description
31	Replacement of bridge or other structure because of substandard load carrying capacity or substandard bridge roadway geometry.
32	Replacement of bridge or other structure because of relocation of road.
33	Widening of existing bridge or other major – structure without deck rehabilitation or replacement; includes culvert lengthening.
34	Widening of existing bridge with deck rehabilitation or replacement.
35	Bridge rehabilitation because of general structure deterioration or inadequate strength.
36	Bridge deck rehabilitation with only incidental widening.
37	Bridge deck replacement with only incidental widening.
38	Other structural work, including hydraulic replacements.

WSBIS Item 1846 – Work Method

FHWA Item 75B – Work Done By

Use one of the following codes to indicate whether the proposed work is to be done by contract or by force account:

Code	Description
1	Work to be done by contract
2	Work to be done by owner's forces

WSBIS Item 1847 – Structure Length (XXXX feet)

FHWA Item 76 – Length of Structure Improvement

Code the length of the proposed bridge improvement to the nearest foot. For replacement or rehabilitation of the entire bridge, the length should be back to back of backwalls of abutments or from pavement notch to pavement notch. For replacement or rehabilitation of only part of the structure, use the length of the portion to be improved.

For culvert improvements, use the proposed length measured along the centerline of the barrel regardless of the depth below grade. The measurement should be made between the inside faces of the top parapet or edge-stiffening beam of the top slab.

WSBIS Item 2853 – Roadway Width (XXX feet)

Code the curb-to-curb width of the roadway on the proposed bridge. This measurement is coded to the nearest foot.

WSBIS Item 2860 – Cost per S.F. of Deck (XXX dollars)

Code the estimated cost per square foot of proposed deck. For State bridges, this number is provided by the WSDOT Bridge Management Engineer.

WSBIS Item 1867 – Structure Cost (XXXXXX in thousands of dollars)

FHWA Item 94 – Bridge Improvement Cost

Code a number to represent the estimated cost of the proposed bridge improvements (including replacement) in thousands of dollars. Numbers exceeding 6 digits will be converted to 999999 for the NBI submittal. This cost does not include roadway, right of way, detour, demolition, or preliminary engineering costs.

WSBIS Item 1873 – Roadway Cost (XXXXXX in thousands of dollars)

FHWA Item 95 – Roadway Improvement Cost

Code a number to represent the cost of the proposed roadway improvement in thousands of dollars. Numbers exceeding 6 digits will be converted to 999999 for the NBI submittal. This shall include only roadway construction costs, excluding bridge, right-of-way, detour, extensive roadway realignment costs, preliminary engineering, etc. Do not use this item for estimating maintenance costs.

WSBIS Item 2870 – Engineering and Miscellaneous Cost (in thousands of dollars)

Code the estimated cost of engineering and other miscellaneous items. For State bridges, this number is provided by the WSDOT Bridge Management Engineer.

WSBIS Item 1861 – Total Cost**(XXXXXX in thousands of dollars)****FHWA Item 96 – Total Project Cost**

Code a number to represent the total project cost in thousands of dollars, including incidental costs not included in Structure Cost and Roadway Cost. Numbers exceeding 6 digits will be converted to 999999 for the NBI submittal. This item should include all costs normally associated with the proposed bridge improvement project. The Total Project Cost will therefore usually be greater than the sum of Structure and Roadway Costs.

WSBIS Item 1879 – Estimate Year**FHWA Item 97 – Year of Improvement Cost Estimate**

Code the year that the costs of proposed work were estimated. The data provided for these items must be current; that is, the estimate year shall be no more than 8 years before the current year.

WSBIS Item 2883 – Proposed Improvement Calculation

This checkbox directs the WSBIS system to compute costs for any proposed bridge improvements. It is checked by default for all structures. To prevent automatic calculation and to perform manual entry, uncheck the box.

The following method is used to perform the automatic calculation:

If Work Type 31 or 32 is chosen:

Work Method = 1

Structure Length = Bridge Length + 10 feet

Roadway Width = (Lanes On x 12 feet) + 14 feet

Cost per SF of Deck = \$800 (as of 2014)

Structure Cost = 0.50 x Total Cost

Roadway Cost = 0.10 x Total Cost

Engineering & Misc Cost = 0.4 x Total Cost

Total Cost = (Structure Imp Length x Prop Roadway Width) x Cost Per SF of Prop Deck

Estimate Year = (current year)

If Work Type 33 through 38 is chosen:

Work Method = 1

Structure Length = Bridge Length

Roadway Width = Approach Roadway Width + 2 feet

Cost per SF of Deck = \$400 (as of 2014)

Structure Cost = 0.50 x Total Cost

Roadway Cost = 0.10 x Total Cost

Engineering & Misc Cost = 0.40 x Total Cost

Total Cost = (Structure Imp Length x Prop Roadway Width) x Cost Per SF of Prop Deck

Estimate Year = (current year)

FHWA Items not maintained in the WSBIS

FHWA Item 1 – State Code

The Washington State Code is 530, and is created automatically for insertion in NBI reports. This data field is not maintained in the Washington State Bridge Inventory.

FHWA Item 112 – NBIS Bridge Length

The NBIS bridge length = Y for all On records reported to the NBI by definition, and is created automatically for insertion in NBI text file. This data field is not maintained in the Washington State Bridge Inventory.

Use the following table to determine the coding requirements for each field:

WSBIS Item No.	WSBIS Item Name	FHWA Item No.	Coded for Main Listing On record		Coded for Main Listing Under record		Coded for Secondary Listing Under record		Crossing record match
			NBI	WSBIS	NBI	WSBIS	NBI	WSBIS	
1001	Structure Identifier	8	Y	Y	Y	Y	N	N	Y
1019	Owner	22	Y	Y	N	Y	N	N	Y
1021	County Code	3	Y	Y	Y	Y	N	N	Y
1156	Location (used for Main Listings)	9	Y	Y	Y	Y	Y	Y	N
1156	Location (used for Secondary Listings)	9	Y	Y	Y	Y	Y	Y	N
1188	Latitude	16	Y	Y	Y	Y	N	N	Y
1196	Longitude	17	Y	Y	Y	Y	N	N	Y
1232	Features Intersected	6	Y	Y	Y	Y	N	N	Y
1256	Facilities Carried	7	Y	Y	Y	Y	N	N	Y
1274	Region code	2	Y	Y	N	Y	N	N	Y
1276	FIPS Code	4	Y	Y	Y	Y	N	N	Y
1285	Toll	20	Y	Y	Y	Y	N	N	Y
1286	Custodian	21	Y	Y	N	Y	N	N	Y
1288	Parallel Structure	101	Y	Y	Y	Y	N	N	Y
1289	Temporary Structure	103	Y	Y	Y	Y	N	N	Y
1291	Median	33	Y	Y	N	N	N	N	Y
1292	Historical Significance - NRHP	37	Y	Y	N	Y	N	N	Y
1293	Open, Closed or Posted	41	Y	Y	N	N	N	N	Y
1310	Skew	34	Y	Y	N	Y	N	N	Y
1312	Flared Flag	35	Y	Y	N	Y	N	N	Y
1332	Year Built	27	Y	Y	Y	Y	N	N	Y
1336	Year Rebuilt	106	Y	Y	Y	Y	N	N	Y
1340	Structure Length	49	Y	Y	Y	Y	N	N	Y
1348	Maximum Span Length	48	Y	Y	Y	Y	N	N	Y
1352	Lanes On	28A	Y	Y	Y	Y	N	N	Y
1354	Lanes Under	28B	Y	Y	Y	Y	Y	Y	N
1356	Curb-to-Curb Width	51	Y	Y	N	Y	N	N	Y
1360	Out-to-Out Deck Width	52	Y	Y	N	Y	N	N	Y
1364	Sidewalk/Curb Width Left	50A	Y	Y	N	Y	N	N	Y
1367	Sidewalk/Curb Width Right	50B	Y	Y	N	Y	N	N	Y
1370	Minimum Vertical Clearance Over Deck	53	Y	Y	N	Y	N	N	Y
1374	Minimum Vertical Clearance Under Bridge	54B	Y	Y	N	Y	N	N	Y
1378	Vertical Underclearance Code	54A	Y	Y	N	Y	N	N	Y
1379	Minimum Lateral Underclearance Right	55A	Y	Y	N	N	N	N	Y
1382	Lateral Underclearance Code	55B	Y	Y	N	N	N	N	Y
1383	Minimum Lateral Underclearance Route Left	56	Y	Y	N	N	N	N	Y

WSBIS Item No.	WSBIS Item Name	FHWA Item No.	Coded for Main Listing On record		Coded for Main Listing Under record		Coded for Secondary Listing Under record		Crossing record match
			NBI	WSBIS	NBI	WSBIS	NBI	WSBIS	
1386	Navigation Control	38	Y	Y	N	Y	N	N	Y
1387	Navigation Vertical Clearance	39	Y	Y	N	Y	N	N	Y
1390	Navigation Horizontal Clearance	40	Y	Y	N	Y	N	N	Y
1394	Vertical Lift Minimum Navigation Clearance	116	Y	Y	N	N	N	N	N
1397	Approach Roadway Width	32	Y	Y	N	Y	N	N	Y
1413	Detour Length	19	Y	Y	Y	Y	Y	Y	N
1432	Inventory Route On/Under	5A	Y	Y	Y	Y	Y	Y	N
1433	Inventory Route Highway Class	5B	Y	Y	Y	Y	Y	Y	N
1434	Inventory Route Service Level	5C	Y	Y	Y	Y	Y	Y	N
1435	Route	5D	Y	Y	Y	Y	Y	Y	N
1445	ADT	29	Y	Y	Y	Y	Y	Y	N
1451	ADT Truck Percentage	109	Y	Y	Y	Y	Y	Y	N
1453	ADT Year	30	Y	Y	Y	Y	Y	Y	N
1457	Future ADT	114	Y	Y	N	N	N	N	N
1463	Future ADT Year	115	Y	Y	N	N	N	N	N
1467	Linear Referencing System Route	13A	Y	Y	Y	Y	Y	Y	N
1469	LRS Milepost	11	Y	Y	Y	Y	Y	Y	N
1477	Linear Referencing System Sub Route	13B	Y	Y	Y	Y	Y	Y	N
1483	National Highway System	104	Y	Y	Y	Y	Y	Y	N
1484	Base Highway Network	12	Y	Y	Y	Y	Y	Y	N
1485	STRAHNET Highway	100	Y	Y	Y	Y	Y	Y	N
1486	Federal Lands Highways	105	Y	Y	Y	Y	Y	Y	N
1487	Functional Classification	26	Y	Y	Y	Y	Y	Y	N
1489	National Truck Network	110	Y	Y	Y	Y	Y	Y	N
1490	Lane Use Direction	102	Y	Y	Y	Y	Y	Y	N
1491	Horizontal Clearance, Route Direction	47	Y	Y	Y	Y	Y	Y	N
1495	Horizontal Clearance, Reverse Direction	47	Y	Y	Y	Y	Y	Y	N
1499	Maximum Vertical Clearance, Route Direction	10	Y	Y	Y	Y	Y	Y	N
1532	Main Span Material	43A	Y	Y	N	Y	N	N	Y
1533	Main Span Design	43B	Y	Y	N	Y	N	N	Y
1535	Approach Span Material	44A	Y	Y	N	Y	N	N	Y
1536	Approach Span Design	44B	Y	Y	N	Y	N	N	Y
1538	Number of Main Spans	45	Y	Y	N	Y	N	N	Y
1541	Number of Approach Spans	46	Y	Y	N	Y	N	N	Y
1544	Service On	42A	Y	Y	Y	Y	N	N	Y
1545	Service Under	42B	Y	Y	Y	Y	N	N	Y

WSBIS Item No.	WSBIS Item Name	FHWA Item No.	Coded for Main Listing On record		Coded for Main Listing Under record		Coded for Secondary Listing Under record		Crossing record match
			NBI	WSBIS	NBI	WSBIS	NBI	WSBIS	
1546	Deck type	107	Y	Y	N	Y	N	N	Y
1547	Wearing Surface	108A	Y	Y	N	Y	N	N	Y
1548	Membrane	108B	Y	Y	N	Y	N	N	Y
1549	Deck Protection	108C	Y	Y	N	Y	N	N	Y
1550	Design Load	31	Y	Y	N	N	N	N	Y
1551	Operating Rating Method	63	Y	Y	N	N	N	N	Y
1552	Operating Rating Tons	64	Y	Y	N	N	N	N	Y
1553	Operating Rating Factor	64	Y	Y	N	N	N	N	Y
1554	Inventory Rating Method	65	Y	Y	N	N	N	N	Y
1555	Inventory Rating Tons	66	Y	Y	N	N	N	N	Y
1556	Inventory Rating Factor	66	Y	Y	N	N	N	N	Y
1585	Border Bridge State Code	98A	Y	Y	N	N	N	N	Y
1588	Border Bridge Percent	98B	Y	Y	N	N	N	N	Y
1590	Border Bridge Structure Identifier	99	Y	Y	N	N	N	N	Y
1657	Structural Evaluation (calculated)	67	n/a	n/a	n/a	n/a	n/a	n/a	n/a
1658	Deck Geometry (calculated)	68	n/a	n/a	n/a	n/a	n/a	n/a	n/a
1659	Underclearances (calculated)	69	n/a	n/a	n/a	n/a	n/a	n/a	n/a
1660	Operating Level	70	Y	Y	N	N	N	N	Y
1661	Alignment	72	Y	Y	N	N	N	N	Y
1662	Waterway	71	Y	Y	N	Y	N	N	Y
1663	Overall Deck Condition	58	Y	Y	N	Y	N	N	Y
1671	Superstructure Overall	59	Y	Y	N	Y	N	N	Y
1676	Substructure Condition	60	Y	Y	N	Y	N	N	Y
1677	Channel Protection	61	Y	Y	N	Y	N	N	Y
1678	Culvert Condition	62	Y	Y	N	Y	N	N	Y
1679	Pier/Abutment Protection	111	Y	Y	N	Y	N	N	Y
1680	Scour	113	Y	Y	N	Y	N	N	Y
1684	Bridge Rails	36A	Y	Y	N	N	N	N	Y
1685	Transitions	36B	Y	Y	N	N	N	N	Y
1686	Guardrails	36C	Y	Y	N	N	N	N	Y
1687	Terminals	36D	Y	Y	N	N	N	N	Y
1844	Proposed Improvement Work Type	75A	Y	Y	N	Y	N	N	Y
1846	Proposed Improvement Work Method	75B	Y	Y	N	Y	N	N	Y
1847	Proposed Improvement Length	76	Y	Y	N	Y	N	N	Y
1861	Proposed Improvement Total Cost	96	Y	Y	N	Y	N	N	Y
1867	Proposed Improvement Structure Cost	94	Y	Y	N	Y	N	N	Y
1873	Proposed Improvement Roadway Cost	95	Y	Y	N	Y	N	N	Y

WSBIS Item No.	WSBIS Item Name	FHWA Item No.	Coded for Main Listing On record		Coded for Main Listing Under record		Coded for Secondary Listing Under record		Crossing record match
			NBI	WSBIS	NBI	WSBIS	NBI	WSBIS	
1879	Proposed Improvement Estimate Year	97	Y	Y	N	Y	N	N	Y
2009	Bridge Number	n/a	N	Y	N	Y	N	N	Y
2023	City	n/a	N	Y	N	Y	N	N	Y
2132	Bridge Name	n/a	N	Y	N	Y	N	N	Y
2181	Section	n/a	N	Y	N	Y	N	N	Y
2183	Township	n/a	N	Y	N	Y	N	N	Y
2185	Range	n/a	N	Y	N	Y	N	N	Y
2346	NBIS Length	n/a	N	Y	N	N	N	N	Y
2400	Program Manager	n/a	N	Y	N	Y	N	N	Y
2401	Crossing Manager		Y	Y	Y	Y	Y	Y	N
2440	Milepost	n/a	N	Y	N	Y	N	Y	N
2500	Minimum Vertical Clearance, Route Direction		Y	Y	Y	Y	Y	Y	N
2501	Maximum Vertical Clearance, Reverse Direction		Y	Y	Y	Y	Y	Y	N
2502	Minimum Vertical Clearance, Reverse Direction		Y	Y	Y	Y	Y	Y	N
2610	Asphalt Depth	n/a	N	Y	N	N	N	N	Y
2611	Design Curb Height	n/a	N	Y	N	N	N	N	Y
2612	Bridge Rail Height	n/a	N	Y	N	N	N	N	Y
2614	Subject to NBIS Flag	n/a	N	Y	N	Y	N	N	Y
2620	Bridge Account Manager	n/a	N	Y	N	Y	N	N	Y
2675	Number of Utilities	n/a	N	Y	N	N	N	N	Y
2688	Revise Rating Flag	n/a	N	Y	N	N	N	N	Y
2691	Photos Flag	n/a	N	Y	N	N	N	N	Y
2693	Soundings Flag	n/a	N	Y	N	Y	N	N	Y
2694	Clearance Flag	n/a	N	Y	N	Y	N	N	Y
2920	Report Type		N	Y	N	Y	N	N	n/a
1990	FC Insp Date	93A	Y	Y	N	N	N	N	n/a
1990	UW Insp Date	93B	Y	Y	N	Y	N	N	n/a
1990	Spec Insp Date	93C	Y	Y	N	Y	N	N	n/a
1991	FC Insp Freq	92A	Y	Y	N	N	N	N	n/a
1991	UW Insp Freq	92B	Y	Y	N	Y	N	N	n/a
1991	Spec Insp Freq	92C	Y	Y	N	Y	N	N	n/a
1990	Routine Insp Date	90	Y	Y	N	N	N	N	n/a
1991	Routine Insp Freq	91	Y	Y	N	N	N	N	n/a
2642	Insp Hours		N	Y	N	Y	N	N	n/a
2643	Insp OT Hours		N	Y	N	Y	N	N	n/a
2646	Inspector Initials		N	Y	N	Y	N	N	n/a
2649	Inspector Cert No		N	Y	N	Y	N	N	n/a
2654	Co-Insp Initials		N	Y	N	Y	N	N	n/a

The following table lists the database definitions of the WSBIS fields:

WSBIS Item No.	WSBIS Item Name	FHWA Item No.	BridgeInventory table	Field Name	Data Type
1001	Structure Identifier	8	tblBridges	structure_id	varchar
1019	Owner	22	tblBridges	agency_id	integer
1021	County Code	3	tblBridges	county_id	integer
1156	Location (used for Main Listings)	9	tblCrossing	location	varchar
1156	Location (used for Secondary Listings)	9	tblCrossing	location	varchar
1157	Description (used for Secondary Listings)		tblCrossing	crossing description	varchar
1188	Latitude	16	tblBridges	latitude	computed, real
1188	Latitude Degrees	n/a	tblBridges	latitude_degree	numeric
1188	Latitude Minutes	n/a	tblBridges	latitude_minute	numeric
1188	Latitude Seconds	n/a	tblBridges	latitude_second	numeric
1196	Longitude	17	tblBridges	longitude	computed, real
1196	Longitude Degrees	n/a	tblBridges	longitude_degree	numeric
1196	Longitude Minutes	n/a	tblBridges	longitude_minute	numeric
1196	Longitude Seconds	n/a	tblBridges	longitude_second	numeric
1232	Features Intersected	6	tblBridges	feature_intersected	varchar
1256	Facilities Carried	7	tblBridges	facilities_carried	varchar
1274	Region code	2	tblBridges	region_code	varchar
1276	FIPS Code	4	tblBridges	fips_code	varchar
1285	Toll	20	tblBridges	toll_code	varchar
1286	Custodian	21	tblBridges	custodian_id	integer
1288	Parallel Structure	101	tblBridges	parallel_structure_code	varchar
1289	Temporary Structure	103	tblBridges	temporary_structure_code	varchar
1291	Median	33	tblBridges	median_code	varchar
1292	Historical Significance - NRHP	37	tblBridges	hist_signif	varchar
1293	Open, Closed or Posted	41	tblBridges	open_closed_code	varchar
1310	Skew	34	tblBridges	nominal_skew_angle	numeric
1312	Flared Flag	35	tblBridges	flared_flag	varchar
1332	Year Built	27	tblBridges	built_year	numeric
1336	Year Rebuilt	106	tblBridges	rebuilt_year	numeric
1340	Structure Length	49	tblBridges	structure_length	numeric
1348	Maximum Span Length	48	tblBridges	max_span_length	numeric
1352	Lanes On	28A	tblBridges	lane_on_qty	numeric
1354	Lanes Under	28B	tblCrossing	lane_under_qty	numeric
1356	Curb-to-Curb Width	51	tblBridges	curb_to_curb_width	numeric
1360	Out-to-Out Deck Width	52	tblBridges	out_to_out_width	numeric
1364	Sidewalk/Curb Width Left	50A	tblBridges	sdwk_curb_left	numeric
1367	Sidewalk/Curb Width Right	50B	tblBridges	sdwk_curb_right	numeric
1370	Minimum Vertical Clearance Over Deck	53	tblBridges	min_vert_deck	numeric
1374	Minimum Vertical Clearance Under Bridge	54B	tblBridges	min_vert_under	numeric
1378	Vertical Underclearance Code	54A	tblBridges	vert_under_code	varchar
1379	Minimum Lateral Underclearance Right	55A	tblBridges	lateral_route_right	numeric
1382	Lateral Underclearance Code	55B	tblBridges	lateral_route_code	varchar
1383	Minimum Lateral Underclearance Route Left	56	tblBridges	lateral_route_left	numeric

WSBIS Item No.	WSBIS Item Name	FHWA Item No.	BridgeInventory table	Field Name	Data Type
1386	Navigation Control	38	tblBridges	nav_control_code	varchar
1387	Navigation Vertical Clearance	39	tblBridges	nav_vert_clrnc	numeric
1390	Navigation Horizontal Clearance	40	tblBridges	nav_horiz_clrnc	numeric
1394	Vertical Lift Minimum Navigation Clearance	116	tblBridges	vert_lift_min_clrnc	numeric
1397	Approach Roadway Width	32	tblBridges	aprch_width	numeric
1413	Detour Length	19	tblCrossing	detour_length	numeric
1432	Inventory Route On/Under	5A	tblCrossing	on_under_code	varchar
1433	Inventory Route Highway Class	5B	tblCrossing	hwy_class	varchar
1434	Inventory Route Service Level	5C	tblCrossing	serv_level_code	varchar
1435	Route	5D	tblCrossing	inv_route	varchar
1445	ADT	29	tblCrossing	adt	numeric
1451	ADT Truck Percentage	109	tblCrossing	adt_truck_pct	numeric
1453	ADT Year	30	tblCrossing	adt_year	numeric
1457	Future ADT	114	tblCrossing	future_adt	numeric
1463	Future ADT Year	115	tblCrossing	future_adt_year	numeric
1467	Linear Referencing System Route	13A	tblCrossing	lrs_route	varchar
1469	LRS Milepost	11	tblCrossing	lrs_traffic_flow	numeric
1477	Linear Referencing System Sub Route	13B	tblCrossing	lrs_sub_route	varchar
1483	National Highway System	104	tblCrossing	fed_hwy_system_code	varchar
1484	Base Highway Network	12	tblCrossing	base_hwy_net	varchar
1485	STRAHNET Highway	100	tblCrossing	strahnet_hwy	varchar
1486	Federal Lands Highways	105	tblCrossing	fed_lands_hwy_code	varchar
1487	Functional Classification	26	tblCrossing	fed_functional_class	varchar
1489	National Truck Network	110	tblCrossing	nat_truck_ntwrk_flag	varchar
1490	Lane Use Direction	102	tblCrossing	lane_direction_code	varchar
1491	Horizontal Clearance, Route Direction	47	tblCrossing	horiz_clrnc_route	numeric
1495	Horizontal Clearance, Reverse Direction	47	tblCrossing	horiz_clrnc_rvrs	numeric
1499	Maximum Vertical Clearance, Route Direction	10	tblCrossing	vert_clrnc_route_max	numeric
1532	Main Span Material	43A	tblBridges	fed_main_material_code	varchar
1533	Main Span Design	43B	tblBridges	fed_main_design_code	varchar
1535	Approach Span Material	44A	tblBridges	fed_aprch_material_code	varchar
1536	Approach Span Design	44B	tblBridges	fed_aprch_design_code	varchar
1538	Number of Main Spans	45	tblBridges	main_span_qty	numeric
1541	Number of Approach Spans	46	tblBridges	aprch_span_qty	numeric
1544	Service On	42A	tblBridges	serv_on_code	varchar
1545	Service Under	42B	tblBridges	serv_under_code	varchar
1546	Deck type	107	tblBridges	fed_deck_type	varchar
1547	Wearing Surface	108A	tblBridges	fed_wear_surf	varchar
1548	Membrane	108B	tblBridges	fed_membrane	varchar
1549	Deck Protection	108C	tblBridges	fed_deck_prot	varchar
1550	Design Load	31	tblBridges	design_load_code	varchar
1551	Operating Rating Method	63	tblBridges	oper_rtng_meth	varchar
1552	Operating Rating Tons	64	tblBridges	oper_rtng_tons	numeric
1553	Operating Rating Factor	64	tblBridges	op_rating_factor	numeric
1554	Inventory Rating Method	65	tblBridges	invrt_rtng_meth	varchar

WSBIS Item No.	WSBIS Item Name	FHWA Item No.	BridgeInventory table	Field Name	Data Type
1555	Inventory Rating Tons	66	tblBridges	inv_rtng_tons	numeric
1556	Inventory Rating Factor	66	tblBridges	inv_rating_factor	numeric
1585	Border Bridge State Code	98A	tblBridges	border_state_code	varchar
1588	Border Bridge Percent	98B	tblBridges	border_pct	varchar
1590	Border Bridge Structure Identifier	99	tblBridges	border_structure_id	varchar
1657	Structural Evaluation	67	tblInspectionReports	structural_adqcy	varchar
1658	Deck Geometry	68	tblInspectionReports	deck_geometry_aprsl	varchar
1659	Underclearances	69	tblInspectionReports	underclnc_aprsl	varchar
1660	Operating Level	70	tblInspectionReports	safe_load_code	varchar
1661	Alignment	72	tblInspectionReports	alignment_aprsl	varchar
1662	Waterway	71	tblInspectionReports	waterway_aprsl	varchar
1663	Overall Deck Condition	58	tblInspectionReports	deck_overall_cond	varchar
1671	Superstructure Overall	59	tblInspectionReports	superstructure_cond	varchar
1676	Substructure Condition	60	tblInspectionReports	substructure_cond	varchar
1677	Channel Protection	61	tblInspectionReports	channel_prot	varchar
1678	Culvert Condition	62	tblInspectionReports	culvert_cond	varchar
1679	Pier/Abutment Protection	111	tblInspectionReports	pier_abutment_prot	varchar
1680	Scour	113	tblInspectionReports	scour_code	varchar
1684	Bridge Rails	36A	tblInspectionReports	bridge_rail_adqcy	varchar
1685	Transitions	36B	tblInspectionReports	rail_trans_adqcy	varchar
1686	Guardrails	36C	tblInspectionReports	aprch_rail_adqcy	varchar
1687	Terminals	36D	tblInspectionReports	rail_end_adqcy	varchar
1844	Proposed Improvement Work Type	75A	tblProposeImprovements	prpsed_work_type	varchar
1846	Proposed Improvement Work Method	75B	tblProposeImprovements	prpsed_work_method_code_override	varchar
1847	Proposed Improvement Length	76	tblProposeImprovements	prpsed_length_override	numeric
1861	Proposed Improvement Total Cost	96	tblProposeImprovements	prpsed_total_cost	numeric
1867	Proposed Improvement Structure Cost	94	tblProposeImprovements	prpsed_structure_cost	numeric
1873	Proposed Improvement Roadway Cost	95	tblProposeImprovements	prpsed_roadway_cost	numeric
1879	Proposed Improvement Estimate Year	97	tblProposeImprovements	prpsed_estimate_year	numeric
1990	Routine Insp Date	90	tblInspectionsPerformed	(combination): report_type = RTN + inspn_date	varchar + datetime
1990	FC Insp Date	93A	tblInspectionsPerformed	(combination): report_ type = FC + inspn_date	varchar + datetime
1990	UW Insp Date	93B	tblInspectionsPerformed	(combination): report_ type = UW + inspn_date	varchar + datetime
1990	Spec Insp Date	93C	tblInspectionsPerformed	(combination): report_type = SPEC + inspn_date	varchar + datetime
1991	Routine Insp Freq	91	tblInspectionsPerformed	(combination): report_ type = RTN + inspn_freq	varchar + numeric
1991	FC Insp Freq	92A	tblInspectionsPerformed	(combination): report_ type = FC + inspn_freq	varchar + numeric
1991	UW Insp Freq	92B	tblInspectionsPerformed	(combination): report_ type = UW + inspn_freq	varchar + numeric
1991	Spec Insp Freq	92C	tblInspectionsPerformed	(combination): report_type = SPEC + inspn_freq	varchar + numeric

WSBIS Item No.	WSBIS Item Name	FHWA Item No.	BridgeInventory table	Field Name	Data Type
2009	Bridge Number	n/a	tblBridges	bridge_no	varchar
2023	City	n/a	tblBridges	city_id	integer
2132	Bridge Name	n/a	tblBridges	bridge_name	varchar
2181	Section	n/a	tblBridges	section	varchar
2183	Township	n/a	tblBridges	township	varchar
2185	Range	n/a	tblBridges	range	varchar
2346	NBIS Length	n/a	tblBridges	nbi_length	numeric
2400	Program Manager	n/a	tbl6ControEntity	program_manager_gid	uniqueidentifier
2401	Crossing Manager		tblCrossing	crossing_manager_gid	uniqueidentifier
2410	Federally Reportable Flag		tblCrossing	fed_report_flag	varchar
2411	Bridge List		tblCrossing	list_form	varchar
2436	Route Sequencer	n/a	tblCrossing	route_seq	numeric
2437	Bridge List MP Override	n/a	tblCrossing	bl_traffic_flow_override	numeric
2438	Milepost Sequencer	n/a	tblCrossing	traffic_flow_seq	numeric
2440	Milepost	n/a	tblCrossing	traffic_flow	numeric
2468	Directional Indicator	n/a	tblCrossing	directional_indicator	varchar
2470	Ahead/Back Indicator	n/a	tblCrossing	ahead_back_indicator	varchar
2500	Minimum Vertical Clearance, Route Direction		tblCrossing	vert_clrnc_route_min	numeric
2501	Maximum Vertical Clearance, Reverse Direction		tblCrossing	vert_clrnc_rvrs_max	numeric
2502	Maximum Vertical Clearance, Reverse Direction		tblCrossing	vert_clrnc_rvrs_min	numeric
2537	Alpha Span Type		tblBridges	alphabetic_span	varchar
2610	Asphalt Depth	n/a	tblBridges	asphalt_depth	numeric
2611	Design Curb Height	n/a	tblBridges	design_curb_height	numeric
2612	Bridge Rail Height	n/a	tblBridges	bridge_rail_height	numeric
2614	Subject to NBIS Flag	n/a	tblInspectionReports	nbi_bridge	varchar
2620	BAM Work Order	n/a	tblBATS	work_order	varchar
2621	BAM Cost Cat	n/a	tblBATS	cost_category	varchar
2622	BAM Weekend	n/a	tblBATS	weekend_rate	varchar
2623	BAM Per Diem	n/a	tblBATS	per_diem	varchar
2642	Insp Hours		tblInspectionsPerformed	inspn_hours	numeric
2643	Insp OT Hours		tblInspectionsPerformed	inspn_overtime_hours	numeric
2646	Inspector Initials		tblInspectionsPerformed	inspr_initials	varchar
2649	Inspect Cert No		tblInspectionsPerformed	cert_no	varchar
2654	Co-Insp Initials		tblInspectionsPerformed	co_inspr_initials	varchar
2675	Number of Utilities	n/a	tblInspectionReports	utilities_qty	varchar
2688	Revise Rating Flag	n/a	tblInspectionReports	rating_calc_flag	varchar
2691	Photos Flag	n/a	tblInspectionReports	inspn_photo_flag	varchar
2693	Soundings Flag	n/a	tblInspectionReports	inspn_soundings_flag	varchar
2694	Clearance Flag	n/a	tblInspectionReports	measure_clrnc_flag	varchar
2710	Sufficiency Rating	n/a	tblInspectionReports	sufficiency_rating	numeric
2711	SD/FO	n/a	tblInspectionReports	def_obs_code	varchar
2920	Report Type		tblInspectionsPerformed	report_type	varchar
2921	Inspection Type		tblInspectionsPerformed	inspn_type	varchar

General

This appendix describes how to create a Washington State Bridge Inventory System (WSBIS) record (Inventory Record). It also describes the procedures which must be followed in order to add, update, and/or delete this inventory information.

The National Bridge Inspection Standards (NBIS) require that a bridge inventory record be established and maintained for each bridge in the state meeting certain qualifications.

1. An inventory record must be kept for all bridges greater than 20 feet* in length and located on public roads which carry vehicular traffic. This is regardless of whether or not the bridge is on the Federal Aid System. Bridges less than 20 feet in length may be inventoried when they meet the qualifications enumerated in Chapter 7. However these records will not be reported to the Federal Highway Administration (FHWA).

*(6.1 meters)

2. An inventory record must also be kept for all bridges over a federal aid route, Strategic Highway Corridor Network (STRAHNET) route, or any otherwise important route. This can include a pedestrian bridge, a tunnel or even a pipeline. An Agency may also choose to maintain a record for bridges over public routes not listed above.

Bridges that do not intersect a public road must be carefully coded to avoid submittal to the FHWA.

In Washington, to facilitate the collection and storage of such a volume of information, a computer system called the Washington State Bridge Inventory System (WSBIS) has been developed. WSBIS is composed of two distinct databases and data management applications. The data management applications are known as Bridge Works. This computer system allows the bridge inventory records for every bridge in the state to be stored in their respective computer database, One for State owned Bridges and one for Local Agency owned bridges. This system was developed by the Washington State Department of Transportation (WSDOT) so that all public bridge information in the state could be coded and stored in a standard, consistent, and accessible format. The bridge inventory data from these two databases is then combined in a central database managed by the WSDOT Office of Information Technologies (OIT). From this central database, information can easily be gathered into reports or transferred to the national database called the National Bridge Inventory (NBI).

The correctness of the bridge information stored in WSBIS is the responsibility of the owner agency. Maintaining the databases' is the responsibility of the WSDOT Bridge Preservation Office (BPO) for State owned bridges and WSDOT Local Programs (LP) for local agency owned bridges. BPO and LP each maintain a version of BridgeWorks to be used by bridge program personnel to enter inspection data, correct inventory information, attached files and photos, and submit updated information to the WSBIS.

In some instances, a local agency will contract with WSDOT or a consultant to inspect and update the inventory for a local agency bridge (i.e., when the local agency does not have the equipment or resources needed). In both cases, the inspection information shall be entered in the Local Agency Bridge Inventory through the Local Agency BridgeWorks application. No matter who does the bridge inspection, the Local Agency bridge owner is responsible for the accuracy of all of their bridge data. It is ultimately the owner's responsibility to ensure that all inspection data is correctly entered into the Local Agency Bridge Inventory. The Local Agency Bridge Inventory is the only valid source of Local Agency bridge data used to populate the overall bridge inventory managed by WSDOT OIT. Failure to enter updated inspection data in the Local Agency Bridge Inventory will cause the inspection data to be omitted from the overall bridge inventory and omitted from subsequent submittals to the NBI. This failure will also cause discontinuities in the inspection history available through BridgeWorks and will, in effect, corrupt the Local Agency Bridge Inventory.

The first part of this chapter describes the procedures which must be followed to add, update, and delete an individual bridge inventory record.

The second part provides a field-by-field description of the WSBIS Inventory Report, defining each field and giving the acceptable coding values which may be entered.

The last part describes the computer editing process performed by the WSBIS system to check the values entered on the report as the inventory record is added or updated.

WSBIS Inventory Report

A WSBIS Inventory Report is produced for every bridge record that has been established in the WSBIS database. This report is the hard copy record of an individual bridges' inventory information and should be reviewed for accuracy whenever updates to the record have been made.

The format of this report is a holdover from a time when coding was submitted on paper forms for entry into the database. To make information easier to enter and retrieve, the form was arranged into four distinct sections: Control Fields, card indicator boxes, data entry fields, and a space for error notifications. While data is no longer collected on a paper form an understanding of the reports' layout is useful.

The first three sections are composed of boxes called fields. Each field is uniquely named. Each has numbered tic marks denoting columns, which indicates the number of characters each field is allowed.

A. Control Fields

Along the top of the report (columns 1 to 27) are six fields known as Control Fields. They uniquely identify the individual bridge record in the following manner. First a unique alphanumeric number is assigned to the record called the Structure Identification (SID) Number. The Bridge Number uniquely identifies the bridge within each agency's system. The Owner Code, County Code and City Code uniquely identify the political subdivision which has control over that bridge. The Update Code is no longer used.

There is one other control field that is made up of several fields from the Inventory Report. This field is called the crossing key. It is a 14-character field that combines the owner code, route, and milepost to create a unique address for Main and Secondary Listing records (see WB74-32).

B. Card Indicator Boxes

Along the left-hand side of the Report (columns 28 to 31) are eight boxes (called Cards) numbered WB71 to WB78. These numbered boxes identify information on the Report as belonging to the WSBIS Inventory. These Cards (WB71, etc.) are duplicated on the forms (Tabs) in BridgeWorks where the data is entered. They are also used in field call-outs.

C. Data Display Fields

The data display fields are stacked directly beneath the Control Fields. This has been done so that all the information can be contained on a single page. The data display fields are where the coding information specific to the given bridge is displayed. They are a reflection of the data entered in the BridgeWorks on the forms indicated by that Card Indicator Box. The middle row of each field displays the data as it is recorded in the WSBIS. The bottom row will display any updates made during a specific inspection or informational update when the report is printed from the BridgeWorks application. These fields will be blank again after the next update to the WSBIS and only current changes will be displayed in the bottom row.

D. Error Reporting

The BridgeWorks application calculates and displays error codes to indicate that inventory information is incorrect. If an error code is reported, the record should be reviewed and the error(s) corrected before the submittal is made. In the rare case where an error code is incorrectly reported it can be ignored.

An example of such a case would be the recording of a side hill viaduct (half bridge). The quality control program will return the error code E489, Curb-to-Curb Width is greater than Out-to-Out Deck Width. However, since the correct coding of the Curb-to-Curb Width is the roadway width and the Out-to-Out Width is the actual deck width the coding is not in error. The quality control program simply cannot recognize this record as a half bridge which has unique coding requirements.

Coding Procedures

To establish and maintain the bridge inventory information, the inspector must enter the information into the BridgeWorks application. Currently two versions of the BridgeWorks application are used in Washington State, One maintained by BPO and one maintained by LP. The Local Agency version of BridgeWorks is available for download at www.wsdot.wa.gov/localprograms/bridge/bridgeworks.htm.

This section provides instructions for proper preparation of an Inventory Report.

The Inventory Report is a valuable reference of the bridges' recorded inventory information. It is also useful for determining the number of characters each field allows. The Report format is used as a method of locating the named field on the report, as well as the forms in the BridgeWorks application and Item call out numbers in the error descriptions.

This method combines the last number of the Card identification from the boxes on the left margin with the column number listed below the field being referenced. For example, the field “Bridge Name” would be referenced as (132), and would be found in BridgeWorks under the WB71 tab and referenced in parenthesis as 132 to the right of the field label. The field “ADT Year” would be referenced as (453), and found under the WB74 tab in BridgeWorks with 453 in parenthesis.

Usually, numeric coded values will be right-justified and alpha coded entries will be left-justified. Some fields must have all columns filled in, others do not.

Examples:

1. For ROUTE NUMBER, the value 101 shall be entered as 00101.
2. For BRIDGE NAME, the name Tule Creek Bridge would be left justified. It has 17 characters so there would be 7 trailing spaces (it is not required to enter trailing spaces in Bridge Works).

Special characters from a keyboard should be limited (i.e., the slash (/), the apostrophe (’), or the ampersand (&) are allowable but others should be avoided). Abbreviations may also be used where space is limited, but the abbreviations must be kept meaningful.

Refer to the descriptions of each field to determine the proper code to enter. Each description should be read carefully as a code having a particular meaning in one field may mean something else entirely in another field. For example, when information does not apply, in some instances a nine will be entered in the field, in other instances a zero will be entered, and in still other instances, the field will be left blank. The field description will explain the proper procedure to follow.

A. Establishing/Reestablishing the Inventory Record

The original inventory record needs to be established only once and is required when:

- A new bridge has been built (usually before it is placed in service).
- An existing bridge has been replaced with a new bridge (**it is required that the existing record and its’ SID be deleted before a new record for the bridge is established with a new unique SID**).
- A detour bridge has been built and remains in service for more than three years or beyond the life of the contract under which it was built.
- An existing bridge not previously inventoried is added to the statewide inventory.

A bridge’s original inventory record can be established by the following steps.

1. In Bridge Works, select “Database/Create Structure” from the menu at the top of the main page. A new window will pop up with twelve data entry fields. Two of these fields are automatically filled in by the BridgeWorks application. First, the Provisional (or temporary) SID will be assigned. Second, the “Sort Bridge Number” will be created when you fill the “Bridge Number” field. The last two digits of the Provisional SID are for sequencing the creation of multiple new records (i.e., “01”, 02). The permanent SID is assigned by WSDOT when the new record is released to the WSBIS. Enter valid data in all of the other fields.

After completing all fields, click in the “Sort Bridge Number” field to activate the “Create Structure” button. Click the “Create Structure” button to close the window and add the new record to your inventory list. You can then choose the new record off the bridge list and continue adding the required inventory information.

2. Enter appropriate values in the data entry fields on the application forms.

The following conditions will apply:

- Information must be entered in all Fatal Fields. These fields are reviewed during the update process for values that are within a predetermined range. If a Fatal Field is blank or out of range, the record cannot be created.
- Required Fields should be completed if the information is known. These fields are cross-referenced by the program for relational logic and valid range entries. Normally if the information for one of these fields is unknown, it should be left blank until the correct information can be determined. There are some exceptions that are noted in the field descriptions.

The Sufficiency Rating generator (described in the appendix) uses a number of the Fatal and Required fields to generate some of the Adequacy Appraisals, the Sufficiency Rating and Deficiency Status. Therefore for accurate ratings these fields must be entered.

- Other information should then be entered in the Optional Fields, as applicable, to create a complete record. Information entered here is not edited. (See the field descriptions on the following pages for an explanation of what information can be entered in these Optional Fields.)

3. A copy of this Inventory Report shall be kept in the bridge file.

Reestablishing the Inventory Record

If an Inventory record for a bridge has been mistakenly deleted or obsoleted (as sometimes happens when a bridge has changed ownership), it can be recovered by emailing a request to the Local Agency Bridge Inventory Engineer for local agency bridges or to the BPO Bridge Inventory Engineer for State owned bridges. In the request, be sure to provide correct control field information.

Once the record has been recovered, it must be reviewed for errors and corrected. Submit the updated data in the manner described for updating the inventory.

B. Updating the Inventory

The original bridge inventory record needs to be updated whenever new data must be added or whenever changes must be made to the existing record.

Updates to the original inventory data may be required as a result of damage to the bridge, changed conditions noted during an inspection, safety improvements or rehabilitation, when new computations or measurements are made, or when the bridge changes ownership. Updates to a bridges’ inventory record must be reported to the Local Agency Bridge Inventory Engineer or the BPO Bridge Inventory Engineer within 90 days. Updates that have not been Released to their respective inventories will not be included in the data for the overall bridge inventory managed by WSDOT OIT and will not be included in any submittals and reports prepared using that data.

To start the update process, select the bridge record from the Bridge List you want to change. Be sure the latest Master Control Data (MCD) in the Control Data Grid is highlighted and then click “edit” to create an updatable copy. This new copy will be in a state of “work” and is called an Update Control Data (UCD). To complete an update, this procedure will be followed.

1. Review the data displayed in the BridgeWorks forms (tabs). All of the forms except BMS, Notes, Repairs, Photos, Files, and Letters are arranged with two data fields after the field name. The left side data field will display existing information. The right side data field is for entering update information.
2. Enter new coding values in each Data Entry Field that must be updated. Make sure your entry is complete. Choosing F9 from your keyboard or clicking the “Check Control Data” button on the NBI tab will cause BridgeWorks to run the error checking process for the selected Control Data (CD). BridgeWorks will then provide you with a list of errors or will let you know that no errors were found. This process can be run on UCD’s or MCD’s.
 - If you are entering new data, simply enter the appropriate values in the field.
 - If you are making a change to existing data, the entire field must be re coded. For example, if the name shown in Item 232 - Features Intersected, has been misspelled, the entire name must be reentered, not just one or two letters corrected.
 - If you want to blank out an entire field, type an asterisk (*) in the update field. If the field is not a fatal field, the existing data contained in that field will be erased and the field will be blank after the record is processed. Fatal Fields can only be updated.
4. When all updates are complete to the satisfaction of the Team Leader responsible for the bridge inspection, the report is submitted to the state of “review.” At this point it is forwarded to the Team Leader’s Program Manager or supervisor for their review. This internal review falls under the heading of Quality Control (QC) and is an important step in the release process. Once the Program Manager or supervisor is satisfied with the UCD it is submitted to the state of “Approved.”
5. Next, a Selection Set of approved UCD’s are sent to the Local Agency Bridge Inventory Engineer for review. The UCD’s are then reviewed during a Quality Assurance (QA) process to ensure correctness and consistency before the data is released to the Inventory.

Any errors found will be noted and returned to the bridge owner for corrections. Once the corrections are made, the UCD is again submitted for review. Once the Inventory Engineer is satisfied with the correctness of the UCD it is released to the Bridge Inventory. At this point, the UCD becomes an MCD and can no longer be changed. An MCD is a permanent part of the bridge record history and further changes must be made through the UCD process.

6. After release, the Bridge Inspection Report and the WSBIS Bridge Inventory Report are printed. The final validation of the inspection report is completed when the Bridge Inspection Team members sign the report. The report is then added to the inspection history in the official bridge file and the previous WSBIS Inventory Report is replaced with the current report.

This process must be completed within 90 days but it is recommended that the release is done as soon as possible. The quality of the inspection report tends to degrade through an extended review. Instead, complete the release process on the UCD and make any later corrections through an Informational UCD.

C. Deleting/Transferring the Inventory Record

When an inventory record becomes obsolete, it needs to be changed from “Active” to “Inactive” status in the WSBIS database. The reasons a record may become obsolete include:

- A bridge has been bypassed and is no longer in use, or
- A bridge has been demolished, or
- A bridge has been permanently closed to traffic.

If a new bridge is built on the site of an old bridge, the agency should first obsolete the old record before establishing a new inventory record. (This will ensure that each new bridge is assigned a unique Structure Identifier.)

To obsolete the inventory record:

1. An email listing the control data for each bridge to be deleted shall be sent to the Local Agency Bridge Inventory Engineer. This email shall include the Structure Identification Number and Bridge Name along with instructions that the record is to be deleted.

If the jurisdiction of a bridge is being transferred from one agency to another, **the bridge record shall not be obsoleted.**

Instead, the Owner Code, Custodian Code and, if necessary, the City Code shall be updated by the original owner prior to sending the bridge records to the new owner. For example:

The city of Selah has expanded its boundaries and annexed a bridge from Yakima County.

Yakima County would update the Owner Code from 02 to 04, the Custodian Code the same if appropriate, and the City Code from 0000 to 1155 prior to the data being submitted for update. Selah would then be responsible to correct the Bridge Number and all other data for the Inventory record.

This will ensure that a given bridge retains its unique Structure Identifier throughout the life of the bridge.

A sample of the entire WSBIS Inventory Report is shown in the forms section.

D. Type of Records

In general, there are two distinct types of Crossing Records (how a highway relates to a bridge and the feature it crosses). The most common is a bridge that carries a highway and the other is a bridge that crosses a highway. Since the design of the Inventory Report only allows the recording of one highway the determination of how that highway relates to the bridge must be made so that all of the Inventory Report fields are consistent.

Structures that carry a public highway are considered “On Records” regardless of the feature crossed. Route information shall be recorded for the highway carried.

An “On Record” shall also be recorded for those bridges that carry a public highway and cross a public highway. Route information shall be recorded for the route on the bridge regardless of classification.

Structures that do not carry a public highway are considered “Under Records” and information about the route the bridge crosses shall be recorded.

Before entering information for a new record, a determination must be made as to whether the record applies to a route “on” the bridge or a route “under” the bridge. There is a distinct difference between the two, and the coding requirements are not the same (see Item 432).

With that in mind, the following is a field-by-field description of the WSBIS Inventory Report.

2.04 Inventory Coding Fields

The following describes the valid codes that may be used and the purpose of each field. It also defines the control fields, fatal fields, required fields, and optional fields.

structure_id Control Field FHWA Item 8A	Structure Identifier (<i>Fatal</i>) This is a unique, eight-character code assigned by the WSDOT Inventory Engineer when the original bridge inventory record is processed. The Structure Identifier is a Primary Key which ties all tables with related information for that bridge together in the WSBIS database. It will not change throughout the life of the bridge.
bridge_no Control Field	Bridge Number (<i>Fatal</i>) This is a unique (to the owner agency) alphanumeric code assigned by the owner of the bridge. This field does not require all spaces to be filled; however, the field cannot be left blank. For local agencies, the bridge number should conform to their agency’s numbering system. The inspector should be aware that special characters can cause undesirable results; therefore, the bridge number should be limited to an alpha-numeric code as much as possible. However, the characters ‘/’ and ‘-’ are acceptable.

Owner Code

Control Field

FHWA Item 022

agency_id

Owner Code (Fatal)

This code identifies the agency of record which owns the bridge. Jointly-owned bridges must be reported by only one of the owner agencies.

There will need to be an agreement between the owner agencies as to which agency will be reporting the bridge to WSBIS. This will prevent both agencies from reporting the same bridge under a different Structure Identifier.

Use one of the following codes.

- 01 State Highway Agency
- 02 County Highway Agency
- 03 Town or Township Highway Agency
- 04 City or Municipal Highway Agency
- 11 State Park, Forest, or Reservation Agency
- 12 County Park, Forest, or Reservation Agency
- 13 City/Other Park, Forest, or Reservation Agency
- 21 Other State Agencies
- 24 Other County Agencies
- 25 Other City or Local Agencies
- 26 Private (Ports and non-Railroad)
- 27 Railroad
- 28 Light Rail
- 31 State Toll Authority
- 32 County Toll Authority
- 33 City or Other Toll Authority
- 60 Other Federal Agencies (not listed below)
- 61 Indian Tribal Government
- 62 Bureau of Indian Affairs
- 63 Bureau of Fish and Wildlife
- 64 U.S. Forest Service
- 66 National Park Service
- 68 Bureau of Land Management
- 69 Bureau of Reclamation
- 70 Corps of Engineers (Civilian)
- 71 Corps of Engineers (Military)
- 72 Air Force
- 73 Navy/Marines
- 74 Army
- 75 NASA
- 76 Metropolitan Washington Airport Services
- 80 Unknown
- 91 Canada
- 92 Idaho
- 93 Oregon

county_id

Control Field

FHWA Item 003

County Number (*Fatal*)

This is a two-digit code which identifies the county in which the bridge is located. If this is a jointly owned bridge, the county that is responsible for reporting the data to the inventory should be entered here. Use one of the following codes.

County Name	County Code	Region Code
Adams	01	EA
Asotin	02	SC
Benton	03	SC
Chelan	04	NC
Clallam	05	OL
Clark	06	SW
Columbia	07	SC
Cowlitz	08	SW
Douglas	09	NC
Ferry	10	EA
Franklin	11	SC
Garfield	12	SC
Grant	13	NC
Grays Harbor	14	OL
Island	15	NW
Jefferson	16	OL
King	17	NW
Kitsap	18	OL
Kittitas	19	SC
Klickitat	20	SW
Lewis	21	SW
Lincoln	22	EA
Mason	23	OL
Okanogan	24	NC
Pacific	25	SW
Pend Oreille	26	EA
Pierce	27	OL
San Juan	28	NW
Skagit	29	NW
Skamania	30	SW
Snohomish	31	NW
Spokane	32	EA
Stevens	33	EA
Thurston	34	OL
Wahkiakum	35	SW
Walla Walla	36	SC
Whatcom	37	NW
Whitman	38	EA
Yakima	39	SC

city_id

Control Field

City Number (Fatal)

This is the city in which the bridge is located. (Codes for cities and towns are identified according to the most recent U.S. Bureau of the Census Identification Schedule.) Contact the Bridge Engineer for Local Agencies for newly incorporated municipalities.

If the bridge is outside of corporate limits or in an unincorporated city, code all zeros. Use the following codes.

City	Code	City	Code	City	Code	City	Code
Unincorporated	0000	Chehalis	0190	Entiat	0405	Kenmore	0609
Aberdeen	0005	Chelan	0195	Enumclaw	0410	Kennewick	0610
Airway Heights	0010	Cheney	0200	Ephrata	0415	Kent	0615
Bucoda	0013	Chewelah	0205	Everett	0420	Kettle Falls	0620
Albion	0015	Clarkston	0215	Everson	0425	Kirkland	0625
Algona	0020	Cle Elum	0220	Fairfield	0430	Kittitas	0630
Almira	0025	Clyde Hill	0225	Farmington	0440	Krupp	0635
Anacortes	0030	Colfax	0230	Federal Way	0443	La Center	0640
Arlington	0045	College Place	0235	Ferndale	0445	Lacey	0643
Asotin	0050	Colton	0240	Fife	0450	La Conner	0650
Auburn	0055	Colville	0250	Fircrest	0455	La Crosse	0655
Bainbridge Island	0058	Conconully	0255	Forks	0465	Lake Forest Park	0657
Battle Ground	0060	Concrete	0260	Friday Harbor	0470	Lake Stevens	0664
Beaux Arts Village	0070	Connell	0265	Garfield	0480	Lakewood	0665
Bellevue	0075	Cosmopolis	0270	George	0489	Lamont	0668
Bellingham	0080	Coulee City	0275	Gig Harbor	0490	Langley	0670
Benton City	0085	Coulee Dam	0280	Gold Bar	0495	Latah	0675
Bingen	0090	Coupeville	0290	Goldendale	0500	Leavenworth	0680
Black Diamond	0095	Creston	0295	Grand Coulee	0510	Liberty Lake	0684
Blaine	0100	Cusick	0300	Grandview	0515	Lind	0685
Bonney Lake	0105	Darrington	0305	Granger	0520	Long Beach	0690
Bothel	0110	Davenport	0310	Granite Falls	0525	Longview	0695
Bremerton	0115	Dayton	0315	Hamilton	0535	Lyman	0705
Brewster	0120	Deer Park	0320	Harrah	0540	Lynden	0710
Bridgeport	0125	Des Moines	0325	Harrington	0545	Lynnwood	0715
Brier	0127	Dupont	0330	Hartline	0550	Mabton	0725
Buckley	0130	Duval	0335	Hatton	0555	Mccleary	0728
Burien	0138	East Wenatchee	0350	Hoquiam	0560	Malden	0730
Burlington	0140	Eatonville	0360	Hunts Point	0570	Mansfield	0735
Camas	0145	Edgewood	0364	Ilwaco	0575	Marcus	0740
Carbonado	0150	Edmonds	0365	Index	0580	Marysville	0745
Carnation	0155	Electric City	0375	Ione	0585	Mattawa	0750
Cashmere	0165	EllensbuRg	0380	Issaquah	0590	Medical Lake	0755
Castle Rock	0170	Elma	0385	Kahlotus	0595	Medina	0760
CaThlamet	0175	Elmer City	0390	Kalama	0600	Mercer Island	0763
Centralia	0180	Endicott	0395	Kelso	0605	Mesa	0765

City	Code	City	Code	City	Code	City	Code
Metaline	0770	Port Orchard	1000	Spokane Valley	1221	Winthrop	1465
Metaline Falls	0775	Port Townsend	1005	Sprague	1225	Woodinville	1469
Mill Creek	0778	Poulsbo	1010	Springdale	1230	Woodland	1470
Millwood	0780	Prescott	1015	Stanwood	1235	Woodway	1475
Milton	0785	Prosser	1020	Starbuck	1240	Yacolt	1480
Monroe	0790	Pullman	1025	Steilacoom	1245	Yakima	1485
MOntesano	0795	Puyallup	1030	Stevenson	1250	Yarrow Point	1490
Morton	0800	Quincy	1040	Sulton	1255	Yelm	1495
Moses Lake	0805	Rainier	1050	Sumas	1265	Zillah	1500
Mossyrock	0810	Raymond	1055	Sumner	1270		
Mountlake Terrace	0815	Reardan	1060	Sunnyside	1275		
Mount Vernon	0820	Redmond	1065	Tacoma	1280		
Moxee City	0825	Renton	1070	Tekoa	1285		
Mukilteo	0830	Republic	1075	Tenino	1290		
Naches	0835	Richland	1080	Tieton	1295		
Napavine	0840	Ridgefield	1085	Toledo	1300		
Nespelem	0855	Ritzville	1090	Tonasket	1305		
Newcastle	0858	Riverside	1095	Toppenish	1310		
Newport	0860	Rockford	1100	Tukwila	1320		
Newcastle	0861	Rock Island	1105	Tumwater	1325		
Nooksack	0865	Rosalia	1115	Twisp	1330		
Normandy Park	0870	Roslyn	1120	Union Gap	1335		
North Bend	0875	Roy	1125	Uniontown	1340		
North Bonneville	0877	Royal City	1127	University Place	1343		
Northport	0885	Ruston	1130	Vader	1345		
Oakesdale	0890	St John	1135	Vancouver	1350		
Oak Harbor	0895	Sammamish	1136	Waitsburg	1360		
Oakville	0900	Seatac	1139	Walla Walla	1365		
Ocean Shores	0907	Seattle	1140	Wapato	1375		
Odessa	0910	Sedro-Woolley	1150	Warden	1380		
Okanogan	0915	Selah	1155	Washougal	1385		
Olympia	0920	Sequim	1160	Washtucna	1390		
Omak	0925	Shelton	1165	Waterville	1395		
Oroville	0935	Shoreline	1169	Waverly	1400		
Orting	0940	SKYkomish	1175	Wenatchee	1405		
Ohello	0945	Snohomish	1180	Westport	1420		
Pacific	0950	Snoqualmie	1185	West Richland	1425		
Palouse	0955	Soap Lake	1190	White Salmon	1435		
Pasco	0960	South Bend	1195	Wilbur	1440		
Pateros	0970	South Cle Elum	1205	Wilkeson	1445		
Pe Ell	0975	South Prairie	1210	Wilson Creek	1450		
Pomeroy	0985	Spangle	1215	Winlock	1455		
Port Angeles	0990	Spokane	1220	Winslow	1460		

WB71**bridge_name**
WB71-32**Bridge Name** (*Fatal*)

This is the name of the bridge.

If the bridge name is more than one word, separate words with a blank space. If the name of the bridge is too long to fit in the field, use abbreviations to shorten it. Left-justify the entry and leave following columns blank. This field does not require a complete entry, but must **not** be left blank.

location
WB71-56**Location** (*Fatal*)

FHWA Item 009

This field gives a narrative description of the physical location of the bridge with respect to the route being inventoried. The location should be keyed to a permanent, distinguishable feature, such as a road junction or a county line. Descriptions should be oriented ahead on station whenever possible. Do not use city limits, as these boundaries may move.

Left-justify this description and do not enter zeroes in remaining blank spaces (otherwise, the zeroes will be considered part of the location description). This field does not require a complete entry, but must **not** be left blank.

section
WB71-81**Section** (*Fatal*)

This is the number of the section in which the bridge is located. Enter a numeric code from '01' to '36'.

Section, township, and range numbers are location markers established by survey mapping.

If the bridge runs along a section, township, or range line, use the smaller of the two numbers. If a bridge crosses any line, use the number at the beginning of the bridge.

township
WB71-83**Township** (*Fatal*)

This is the number of the township in which the bridge is located. Enter a numeric code from '01' to '41'.

Township designations carry a directional suffix (north or south); however, since all townships in Washington are north, this directional indicator need not be entered.

range

WB71-85

Range (Fatal)

This field contains the number of the range in which this bridge is located.

There are two parts to this field. In the first two columns, enter the number of the range in which the bridge is located. Valid ranges are:

01 through 47 If the third column is E

01 through 16 If the third column is W

In the third column, enter the directional suffix which indicates the position of the range in relation to the Willamette Meridian. Enter one of the following codes:

E East

W West

latitude

WB71-88

FHWA Item 016

Latitude (Fatal)

This field contains the degrees of latitude at the centerline of the bridge at its beginning milepost. Latitude is designated in degrees, minutes, and seconds to the hundredth of a second. Since all of Washington is located in northern latitudes, the directional suffix (N) need not be entered. It is recommended this field be coded using GPS or an accurate digital mapping program.

longitude

WB71-96

FHWA Item 017

Longitude (Fatal)

This field contains the degrees of longitude at the centerline of the bridge at its beginning milepost. Longitude is indicated in degrees, minutes, and seconds to the hundredth of a second. Since all of Washington is located in western longitudes, the directional suffix (W) need not be entered. It is recommended this field be coded using GPS or an accurate digital mapping program.

WB72**feature_intersected** **Features Intersected** (*Fatal*)

WB72-32

FHWA Item 006A This is the name or names of the features intersected by the bridge, i.e., the features under the bridge. If full names will not fit in the field, abbreviations may be used where necessary but an effort shall be made to keep them meaningful. Left-justify the name or names entered without using trailing zeroes. This field does not require a complete entry, but must not be left blank.

If one of the features intersected is another roadway, indicate the signed route number or name of the highway (i.e., SR 99).

If there is an alternate name for a feature, enclose this second identifier in parentheses. For example a signed number route that is also a named memorial route (i.e., SR 99 (Aurora Avenue)).

If more than one feature is intersected, give both names, signed route first separated by a comma (i.e., SR 99, Blue R, UPR).

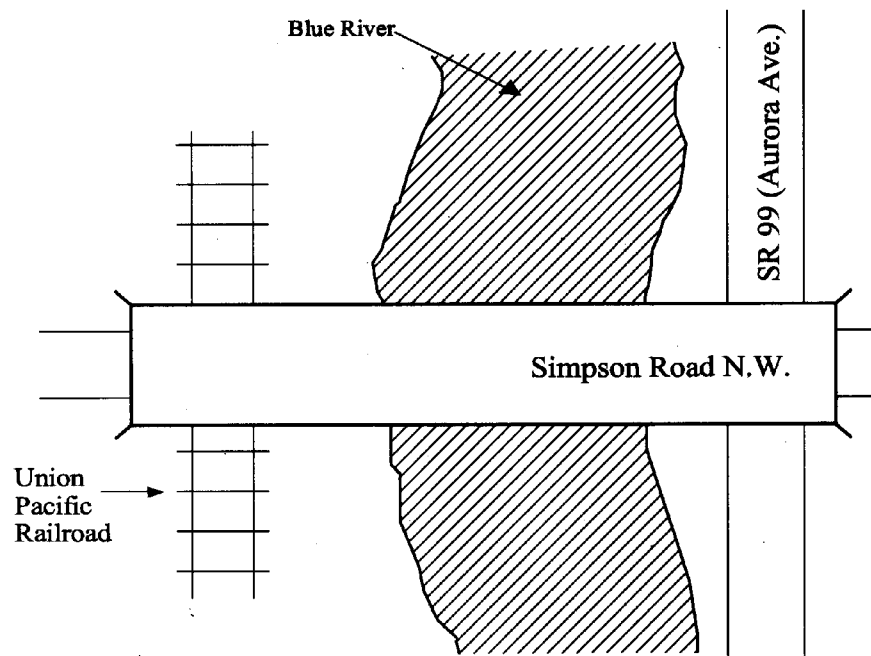

Figure WB72-32

facilities_carried **Facilities Carried** (*Fatal*)

WB72-56

FHWA Item 007

This is the name (or names) of the facility carried by the bridge. In all situations this describes the use “on” the bridge.

Left-justify the roadway name or names (use abbreviations If necessary) and do not enter trailing zeroes.

If there is an alternate name for a feature, enclose this second identifier in parentheses. For example a signed number route that is also a named memorial route (i.e., SR 99 (Aurora Avenue)).

This field does not require a complete entry, but must not be left blank.

region_code

WB72-74

FHWA Item 002

WSDOT Region (*Fatal*)

This is the WSDOT region in which the bridge is located. Use the following codes. Some counties may be shared by more than one region. Local Agencies should use the regions assigned below.

Region Names (Code)	County Names	Region Names (Code)	County Names
Eastern Region (EA)	Adams	South Central Region (SC)	Asotin
	Ferry		Benton
	Lincoln		Columbia
	Pend Oreille		Franklin
	Spokane		Garfield
	Stevens		Kittitas
	Whitman		Walla Walla
North Central Region (NC)	Chelan		Yakima
	Douglas		Southwest Region (SW)
	Grant	Cowlitz	
Okanogan	Klickitat		
Northwest Region (NW)	Island	Lewis	
	King	Pacific	
	San Juan	Skamania	
	Skagit	Wahkiakum	
	Snohomish		
Olympic Region (OL)	Whatcom		
	Clallam		
	Grays Harbor		
	Jefferson		
	Kitsap		
	Mason		
Pierce			
Thurston			

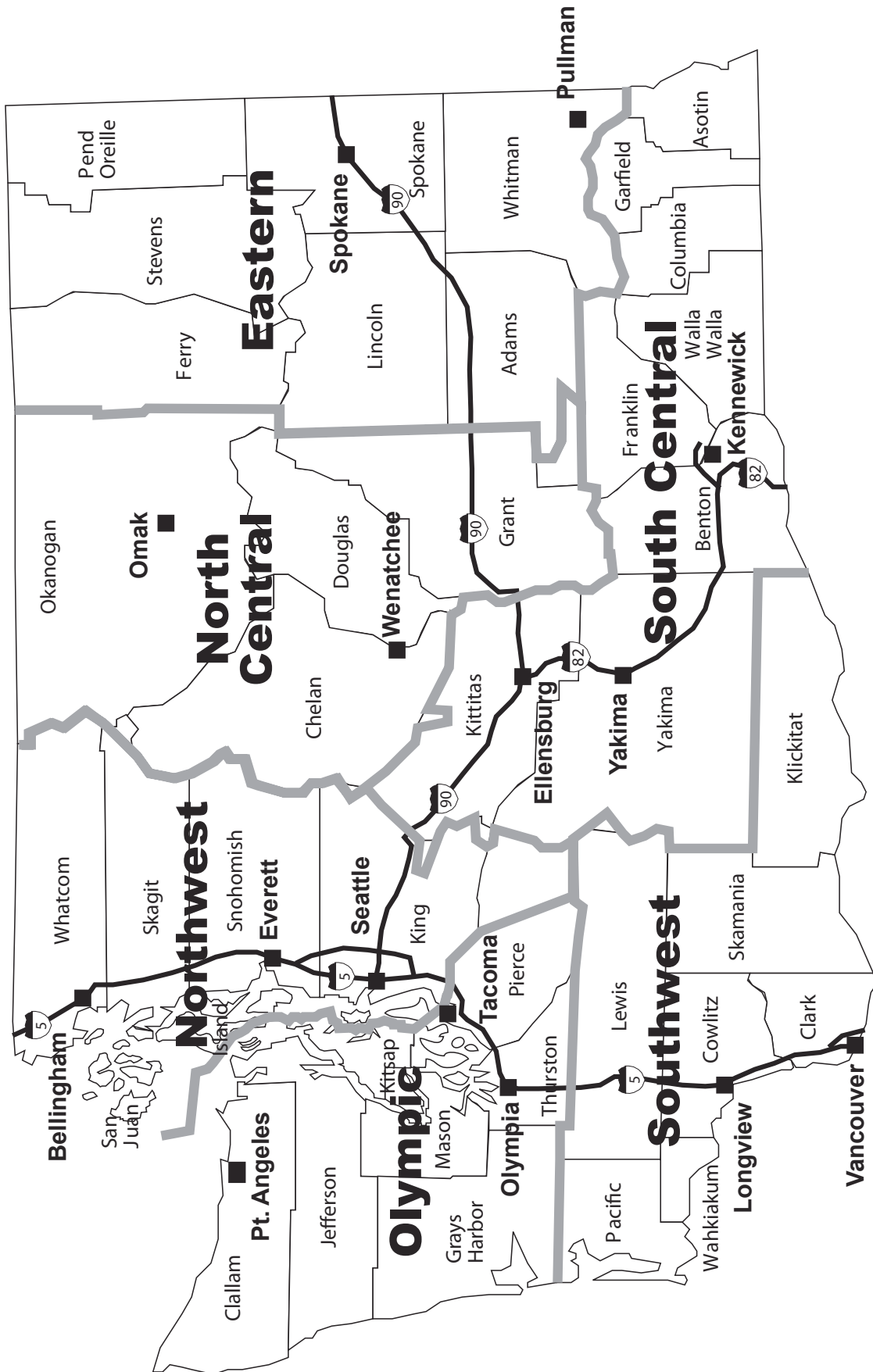

fips_code WB72-76 FHWA Item 004	FIPS Place Code <i>(Required)</i> This field identifies the census-designated place in which the bridge is located using the Federal Information Processing Standards (FIPS 55) code, given in the current version of the Census of Population and Housing – Geographic Identification Code Scheme. If no code is applicable, enter all zeroes.
leg_dist_code_1 WB72-81 WSBIS Item 7281	Legislative District Number (1) <i>(Required)</i> This field identifies the first or only State Legislative District in which the bridge is located (see Section 2.08). If the legislative district number is followed by a letter (District 19A, for example), disregard the letter and enter the two-digit number only.
leg_dist_code_2 WB72-83 WSBIS Item 7283	Legislative District Number (2) <i>(Required)</i> For bridges which span a State Legislative District dividing line, use this field to identify the second State Legislative District number. Use both this and the Legislative District Number (1) field to enter the two separate State Legislative District numbers. If no code is applicable, enter all zeroes.
toll_code WB72-85 FHWA Item 020	Toll <i>(Fatal)</i> This code indicates if a toll is required for use of the bridge. One of the following codes will apply: <ol style="list-style-type: none"> 1. Toll bridge – a toll must be paid specifically to use the bridge. 2. On toll road – a toll must be paid to use the roadway carried by the bridge. 3. Non-toll bridge – no tolls are paid to use the bridge or the roadway carried by the bridge. 4. On interstate toll segment under secretarial agreement. Bridge functions as a part of the toll segment. 5. Toll bridge is a segment under secretarial agreement. Bridge is separate agreement from highway segment.

custodian_id**Custodian** (*Fatal*)

WB72-86

FHWA Item 021

This code describes the type of agency that has primary responsibility for maintaining the bridge (may not be the same as the owner). Acceptable values to enter in this field are as follows:

- 01 State Highway Agency
- 02 County Highway Agency
- 03 Town or Township Highway Agency
- 04 City or Municipal Highway Agency
- 11 State Park, Forest, or Reservation Agency
- 12 County Park, Forest, or Reservation Agency
- 13 City/Other Park, Forest, or Reservation Agency
- 21 Other State Agencies
- 24 Other County Agencies
- 25 Other City or Local Agencies
- 26 Private (other than Railroad)
- 27 Railroad
- 28 **Light Rail**
- 31 State Toll Authority
- 32 County Toll Authority
- 33 City or Other Toll Authority
- 60 Other Federal Agencies (not listed below)
- 62 Bureau of Indian Affairs
- 63 Bureau of Fish and Wildlife
- 64 U.S. Forest Service
- 66 National Park Service
- 68 Bureau of Land Management
- 69 Bureau of Reclamation
- 70 Corps of Engineers (Civilian)
- 71 Corps of Engineers (Military)
- 72 Air Force
- 73 Navy/Marines
- 74 Army
- 75 NASA
- 76 Metropolitan Washington Airport Services
- 80 Unknown
- 91 Canada
- 92 Idaho
- 93 Oregon

parallel_structure_ Parallel Structure (Fatal)

WB72-88

FHWA Item 101 This field contains a code to identify situations in which separate bridges carry the same inventory route in opposite directions of travel over the same feature. The lateral distance between bridges has no bearing on the coding of this field.

Right and left are determined by facing in the direction of increasing mileposts or, in the absence of milepost markers, by facing north or east.

- R To indicate the right-hand bridge of the pair
- L To indicate the left-hand bridge of the pair
- N To indicate the bridge is not a parallel bridge

temporary_structure_ Temporary Structure (Required)

WB72-89

FHWA Item 103 This code indicates If a temporary bridge has been built or temporary measures have been taken on an existing bridge to maintain a flow of traffic. Temporary bridges or temporary repair measures may be required during the modification or replacement of a bridge found to be deficient.

Any one of the following conditions will require that a code of “T” be entered in this field:

- The bridge has been shored up or additional temporary supports have been installed.
- Temporary repairs have been made to keep the bridge open.
- A temporary bridge has been built to provide an interim bypass that is not under the control of a contractor, such as an emergency bailey type bridge.
- Other temporary measures have been taken, such as barricaded traffic lanes, to keep the bridge open to traffic.

If none of these conditions exist, leave the field blank.

Any repaired bridge or replacement bridge expected to remain in service without further project activity (other than maintenance) for a significant period of time shall not be considered temporary. Under such conditions, that bridge, regardless of its type, shall be considered the minimum adequate to remain in place and shall be evaluated accordingly.

If this item is coded T, then all data recorded for the bridge shall be for the condition of the bridge without temporary measures, except for the following items which shall be coded for the temporary bridge:

- WB72-93 Structure Open, Posted, or Closed to Traffic
- WB73-70 Minimum Vertical Clearance Over Bridge Deck
- WB73-74 Minimum Vertical Clearances Under Bridge
- WB73-79 Minimum Lateral Under clearance Right
- WB73-83 Minimum Lateral Under clearance Left
- WB74-91 Horizontal Clearance Route Direction
- WB74-95 Horizontal Clearance Reverse Direction
- WB76-60 Operating Level

median_code **Median** (*Fatal*)

WB72-91

FHWA Item 033

This code indicates If there is a median on the bridge. By definition, a bridge median can only exist on divided highways.

A divided highway can be identified by the use of traffic control devices separating the route and reverse route directions of travel. Devices such as a concrete barrier, or yellow crosshatching between solid double yellow lines 18 inches or more apart, or others, such that vehicles are restricted to the right-hand lanes unless directed or permitted in the left-hand lanes by a police officer, or other official traffic control devices.

If a structure has been divided into a left and a right bridge so that the median is between the two structures then no median is considered to be on the bridge. Culverts will often have a median similar to the diagram for Code 1.

Use the following diagrams to identify the median device on the bridge.

- 0 No median (undivided roadway).
- 1 Open median.
- 2 Closed median – painted (Traffic lanes are separated only by painted median).
- 3 Closed median – mountable curb or center island.
- 4 Closed median – flex or thrie beam guardrail.
- 5 Closed median – box beam guardrail.
- 6 Closed median – Concrete (i.e., NJB, Type F barrier).
- 7 Open median – with safety modifications (i.e., a net has been installed).
- 9 Other type of median.

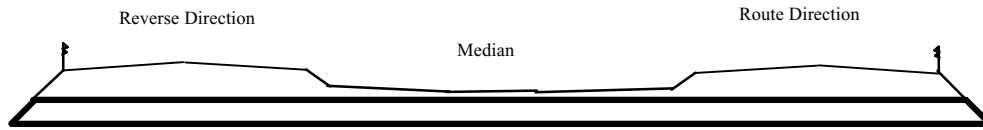

Code 1



Code 3

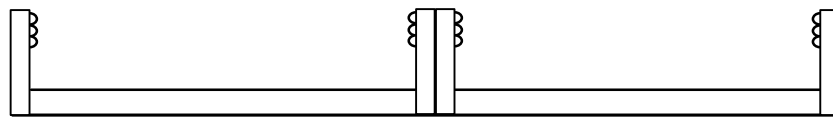

Code 4

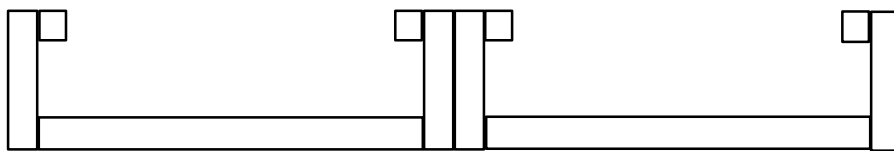

Code 5

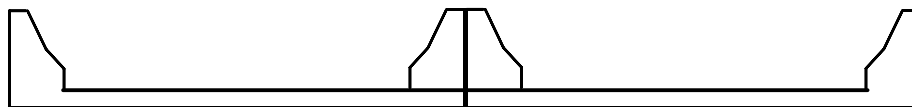

Code 6

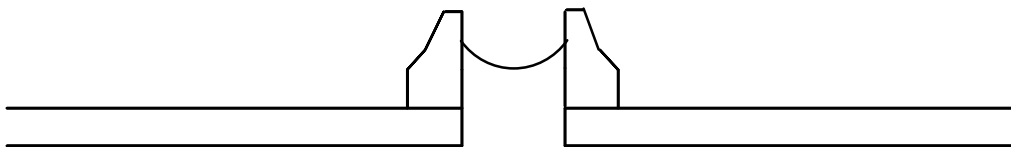

Code 7

Figure WB72-91

hist_signif WB72-92 FHWA Item 037	<p>Historical Significance (<i>Fatal</i>)</p> <p>A bridge may be considered historically significant if it is a particularly unique example of the history of engineering, the crossing itself is historically significant, the bridge is associated with historical property, or the bridge was involved in events of historical significance.</p> <p>If the bridge is only on the National Register of Historic Places (NRHP) list, use the numeric code. If the bridge is only on the Historical American Engineering Record (HAER) list, use the alpha code. If the bridge is on both NRHP and HAER lists, use the numeric code.</p> <p>1 or A Bridge is on the NRHP or HAER.</p> <p>2 or B Bridge is eligible for the NRHP or HAER.</p> <p>3 or C Bridge is possibly eligible for the NRHP or HAER. (Further investigation is required before a determination can be made.)</p> <p>4 Bridge's historical significance has not been determined at this time. (This code should be used if the bridge is less than 50 years old.)</p> <p>5 Bridge has been reviewed by the State Office of Archaeology and Historic Preservation and is not eligible for the NRHP, HAER.</p> <p>6 Bridge has been reviewed and a determination has been made that this bridge has no historical significance.</p>
open_closed WB72-93 FHWA Item 041	<p>Open, Closed, or Posted (<i>Fatal</i>)</p> <p>This field provides information about the actual weight capacity status of a bridge. The field review could show that a structure is posted, but WB76-60 Operating Level may indicate that posting is not required. This is possible and acceptable coding since WB76-60 is based on the operating stress level and the governing agency's posting procedures may specify posting at some stress level less than the operating rating. One of the following codes shall be used:</p> <p>A Bridge is open with no restrictions.</p> <p>B Bridge is open. Posting has been recommended but has not been legally implemented (all signs are not in place).</p> <p>D Bridge is open. It would be posted or closed except that temporary shoring, etc., has been used to allow for unrestricted traffic flow. If this code is used, WB72-89 shall be coded T.</p> <p>E Bridge is open, but it is a temporary bridge carrying traffic while the original bridge is being replaced or rehabilitated. If this code is used, WB72-89 shall be coded T.</p> <p>G Bridge is new and not yet open to traffic.</p> <p>K Bridge is closed to traffic.</p> <p>P Bridge is posted for weight restrictions.</p> <p>R Bridge is posted for other load-capacity restrictions such as speed or limiting the number of vehicles allowed on the bridge at one time.</p>

program_year **Program Year** (*Required*)
WB72-94 If the bridge has been included in an approved six-year construction program, this field contains the year that work is to start on the project, including preliminary engineering.

Work to be performed on the bridge must be major construction or reconstruction. If the bridge is not included in a six-year program, code zeroes in this field.

Hist_signif_LP **Historical Significance – Local Programs**

WB72-96

WSBIS Item 7296 This item only applies to a Local Agency registry. The definition for WB72-92 applies here but only as it relates to criteria set forth by a Local Agency. Use one of the following codes.

- 0 Neither bridge or crossing are on the Local Agencies registry or a determination has not been made.
- 1 Bridge is on the Local Agencies registry
- 2 Crossing is on the Local Agencies registry

WB73**built_year**

WB73-32

FHWA Item 027

Year Built (*Fatal*)

This is the year that original construction of the bridge was completed.

If the year the bridge was built is not known, enter an estimate of that date. If the bridge was built during or before the year 1900, enter 1900 in the field.

There are cases where a careful evaluation of the year built and year rebuilt must be made. The first is when an existing bridge has been moved to a new site. The second is when parts of a dismantled bridge from another site are used at a new site. And the third is when parts of the old bridge are used at the same site.

Excluding engineering and safety considerations, an evaluation of the impact on future funding is a factor. The year built and year rebuilt are key fields used to determine if a bridge is eligible for federal funding. Another consideration would be the percentage of used material in relation to new material. The greater the percentage of new material used in the bridge the less need there is of capturing the original date of construction in the inventory.

Since every occasion of these instances will be unique in its application guidance should be sought from your Program Manager when there is question as to the proper year to use.

rebuilt_year

WB73-36

FHWA Item 106

Year Rebuilt (*Fatal*)

This is the year in which the last major rehabilitation of the existing bridge was completed.

Record and code the year of most recent reconstruction of the structure. Code all four digits of the latest year in which reconstruction of the structure was completed. If there has been no reconstruction, code 0.

For a bridge to be defined as rebuilt, the type of work performed, whether or not it meets current minimum standards must have been eligible for funding under any of the federal aid funding categories. The eligibility criteria would apply to the work performed regardless of whether all state or local funds or federal aid funds were used.

Some types of eligible work not to be considered as rebuilt are listed:

- Safety feature replacement or upgrading (for example, bridge rail, approach guardrail, or impact attenuators).
- Painting of structural steel.
- Overlay of bridge deck as part of a larger highway surfacing project (for example, overlay carried across bridge deck for surface uniformity without additional bridge work).
- Utility work.
- Emergency repair to restore structural integrity to the previous status following an accident.

- Retrofitting to correct a deficiency which does not substantially alter physical geometry or increase the load-carrying capacity.
- Work performed to keep a bridge operational while plans for complete rehabilitation or replacement are under preparation (for example, adding a substructure element or extra girder).

Example	Code
Rebuild completed 1970	1970
Bridge has NOT been Rebuilt	0

structure_length
WB73-40
FHWA Item 49

Bridge Length (*Fatal*)

This is the measurement for the length of roadway supported by the bridge. This measurement is taken along the center of the roadway from the back of the backwall of each abutment or from the back of paving notch (seat) to paving notch (seat). Culvert lengths are measured along the centerline of the roadway from inside face to inside face of the exterior walls, or from spring line to spring line, regardless of depth below grade. When the culvert is not perpendicular to the roadway, the centerline length must be calculated. Code this measurement to the nearest foot.

The bridge length entered in this field is considered the length when determining eligibility for federal funding, except when the bridge length is near 20 feet. If that is the case, the length of the bridge as entered in NBIS Length will be used. See Figure WB73-40A and Figure WB73-40B.

nbi_length
WB73-46
FHWA Item 112

NBIS Length (*Fatal, If WB73-40 is between 20 and 23 feet*)

The NBIS bridge length is a measurement along the center of the roadway between undercopings of abutments, spring lines of arches, or the extreme ends of openings for multiple boxes.

This measurement is coded to the nearest tenth of a foot and may be different from the measurement entered in Bridge Length.

If the measurement as entered in Bridge Length is between 20 and 23 feet, a measurement of the NBIS length shall be coded in this field.

If the measurement as entered in Structure Length is greater than 23 feet, this field shall be left blank. See Figure WB73-40A and Figure WB73-40B.

max_span_length Maximum Span Length (*Fatal*)

WB73-48

FHWA Item 048

This is the number of feet which the bridge spans at its maximum opening. This length is measured along the centerline of the bridge. The span length is measured either as the center-to-center distance between bearings or the clear distance between piers, bents, or abutments. The preferred measurement to enter is the center-to-center distance between bearings. The span may be either a main span or approach span. See Figure WB73-40A and Figure WB73-40B.

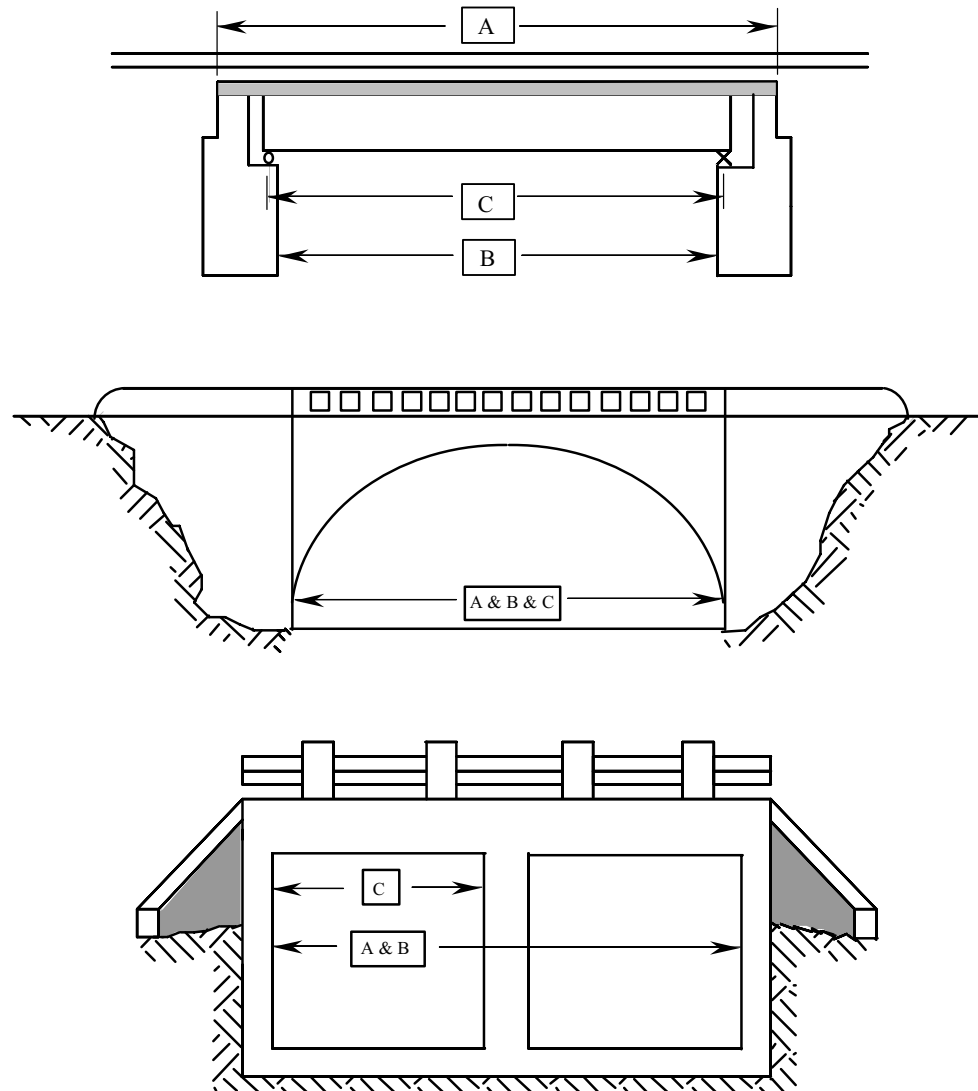

- A = Structure Length (WB73-40)
- B = NBIS Length (WB 73-46)
- C = Maximum Span Length (WB73-48)

For a culvert, it doesn't matter if the roadway is on the slab or on ballast, "A" will remain unchanged.

Figure WB73-40A

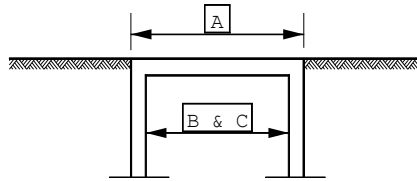

For a structure with ballast (where the ballast is $> A/2$) such that the live load is not transferred into the deck "A" will be inside the face of the exterior walls.

- A = Structure length (WSBIS Item 340)
- B = NBIS Length (WSBIS Item 346)
- C = Maximum span length (WSBIS Item 348)
- D = the distance between consecutive pipes which must be \leq or $<$ the diameter of the smallest pipe in the series

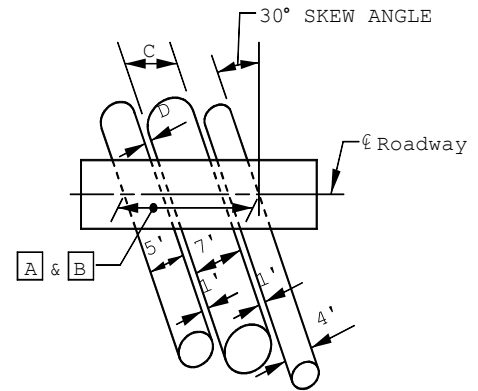

$$\text{Opening Distance} = 18' = 5' + 1' + 7' + 1' + 4'$$

$$A \text{ (normal to the pipes)} = \frac{18'}{\cos(30)} = \frac{18'}{.867} = 20.76' \text{ (Code 21')}$$

$$C = \frac{7}{\cos(30)} = 8.08' \text{ (code 8')}$$

Figure WB73-40B

lane_on WB73-52 FHWA Item 028A	Lanes On (<i>Fatal</i>) The number of lanes of motor vehicle traffic carried by the bridge must be entered in this field. It includes all traffic lanes which are striped or otherwise marked as full-width lanes for the entire length of the ridge. Include any full-width merge lanes or ramp lanes carried on the bridge. The number of traffic lanes is independent of the direction in which these lanes carry traffic. That is, a one-lane bridge which carries traffic in two directions is considered to have only one lane on the bridge. It should be noted here for purposes of the Deck Geometry Evaluation any one-way bridge (excluding ramps, WB74-34 coded 7) which has a curb-to-curb width 16 feet or greater shall be evaluated as two lanes. Also, If the curb-to-curb is less than 16 feet and the bridge carries two way traffic, then WB73-52 is coded Ø1 and WB74-90 is coded 5. For information to code a half bridge, see Figure WSBIS-1356b.
lane_under WB73-54 FHWA Item 028B	Lanes Under (<i>Fatal</i>) This field contains the number of lanes of motor vehicle traffic carried by the highway or highways which pass underneath the bridge. If the bridge carries highway traffic (WB74-32 is coded 1, regardless of ownership and/or maintenance responsibility), it is the total number of lanes of all inventory routes passing underneath. If the route being inventoried is under the bridge (WB74-32 coded 2 or A-Z), this is the number of lanes of the inventoried route only. There may be a separate record of some or all of the routes located under the bridge (see WB74-32 for routes requiring a record in the NBI).
curb_to_curb_width WB73-56 FHWA Item 051	Curb-to-Curb Width (<i>Fatal</i>) The curb-to-curb width is the measurement, in feet, of the most restrictive width of the structure from curb-to-curb (or inside face of rail to inside face of rail if no curb). This is a Fatal Field. This measurement is recorded to the nearest tenth of a foot. For structures that carry lanes of traffic separated by a median barrier, the curb-to-curb width is the sum of the most restrictive minimum widths of each roadway carried on the structure. The widths of any open medians, raised or non-mountable medians, barrier-protected horse or bicycle lanes, or flared ramps should be excluded from this measurement. When the roadway runs directly on the top slab or wearing surface of a culvert (such as a reinforced concrete box without fill), the actual roadway width from curb-to-curb or from rail-to-rail is entered in this field. This is also the case If the fill is minimal and the culvert headwalls reduce the roadway width. When there are no lateral restrictions such as curbs or rails the actual usable roadway width is recorded as the curb-to-curb measurement.

When the roadway is carried on sufficient fill covering a pipe or box culvert so that the load is not transferred into the structure, and when headwalls or parapets do not affect the flow of traffic, a value of Ø should be entered in this field. The filled section over the culvert simply maintains the roadway cross-section, the structure itself is considered to have no deck and thus no curb-to-curb width.

It should be noted, however, that for purposes of Sufficiency Rating calculations the program will default to a curb-to-curb width of 36' for the S2, D, and E calculations.

For the correct coding of a Side Hill Viaduct (Half Bridge), see Figure WSBIS-1356b.

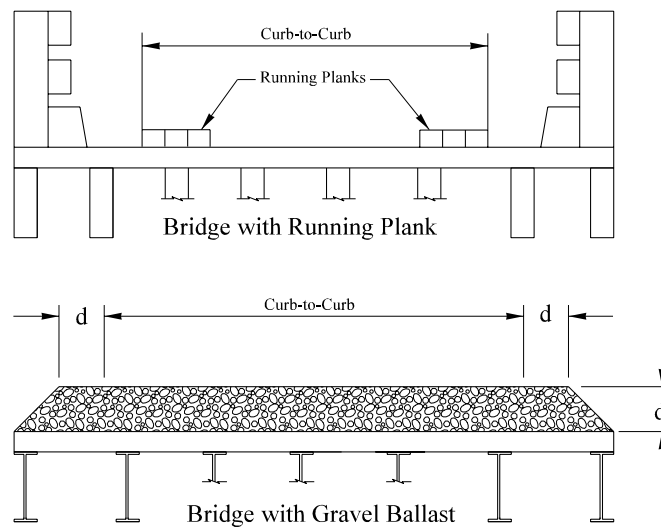

Curb-to-Curb Roadway Width
Figure WB73-56

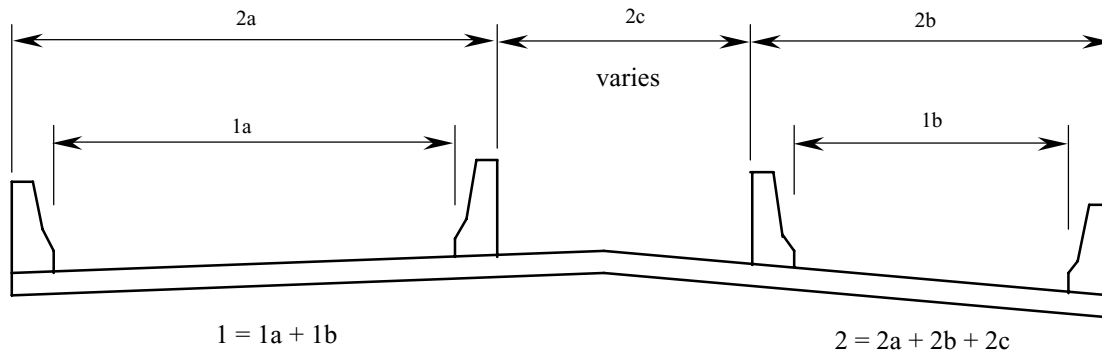
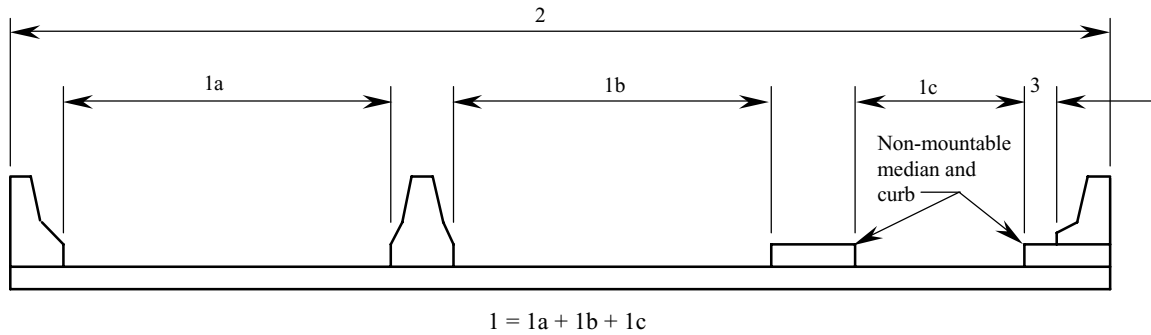
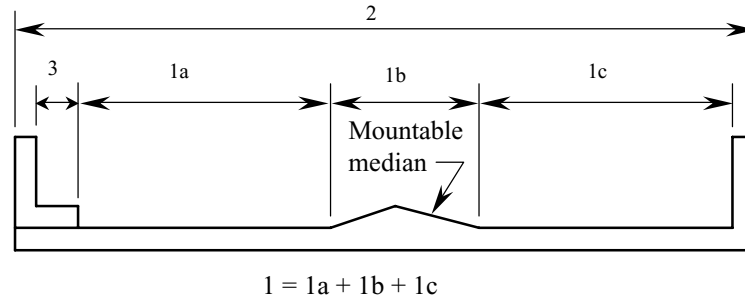

WB73-56 (1) Bridge Roadway Width, Curb-to-Curb
 WB73-60 (2) Deck Width, Out-to-Out
 WB73-64 (3) Curb or Sidewalk Width

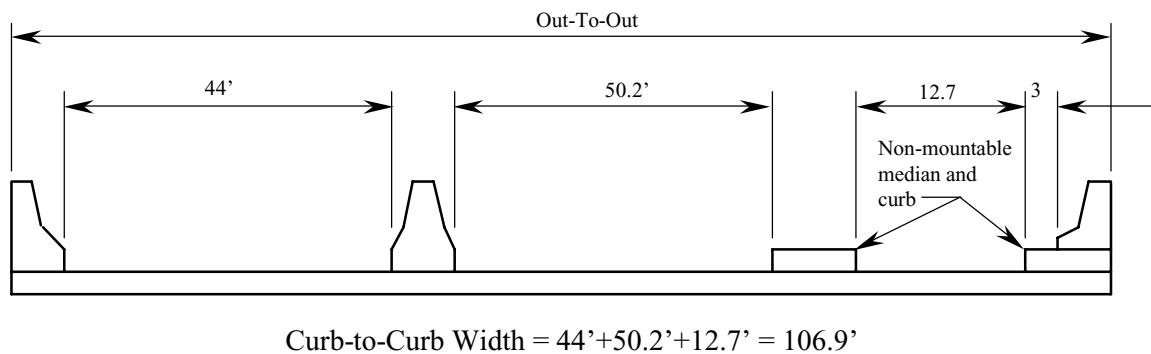

Curb-to-Curb Roadway Width
Figure WB73-56

out_to_out_width **Out-to-Out Deck Width** (*Fatal*)

WB73-60

FHWA Item 052

This field contains the measurement of the most representative out-to-out width on the bridge. This measurement should be taken normal to centerline from the outside edges of each side of the deck and coded to the nearest tenth of a foot. The widths of any open medians, or flared ramps should be excluded from this measurement. For through structures, the out-to-out width is a measurement of the lateral clearance between superstructure members. See Figures WB73-56 and WB73-60.

When the roadway runs directly on the culvert (as described in Curb-to-Curb Width), the width of the culvert itself, from outside edge to outside edge, should be entered in this field. When the roadway is carried on fill over a buried culvert (also described in Curb-to-Curb Width), a value of zero should be entered.

See Figure WSBIS-1356b for Side Hill Viaduct (Half Bridge) coding.

HORIZONTAL / VERTICAL MEASUREMENTS

(Looking Ahead on Mileposts)

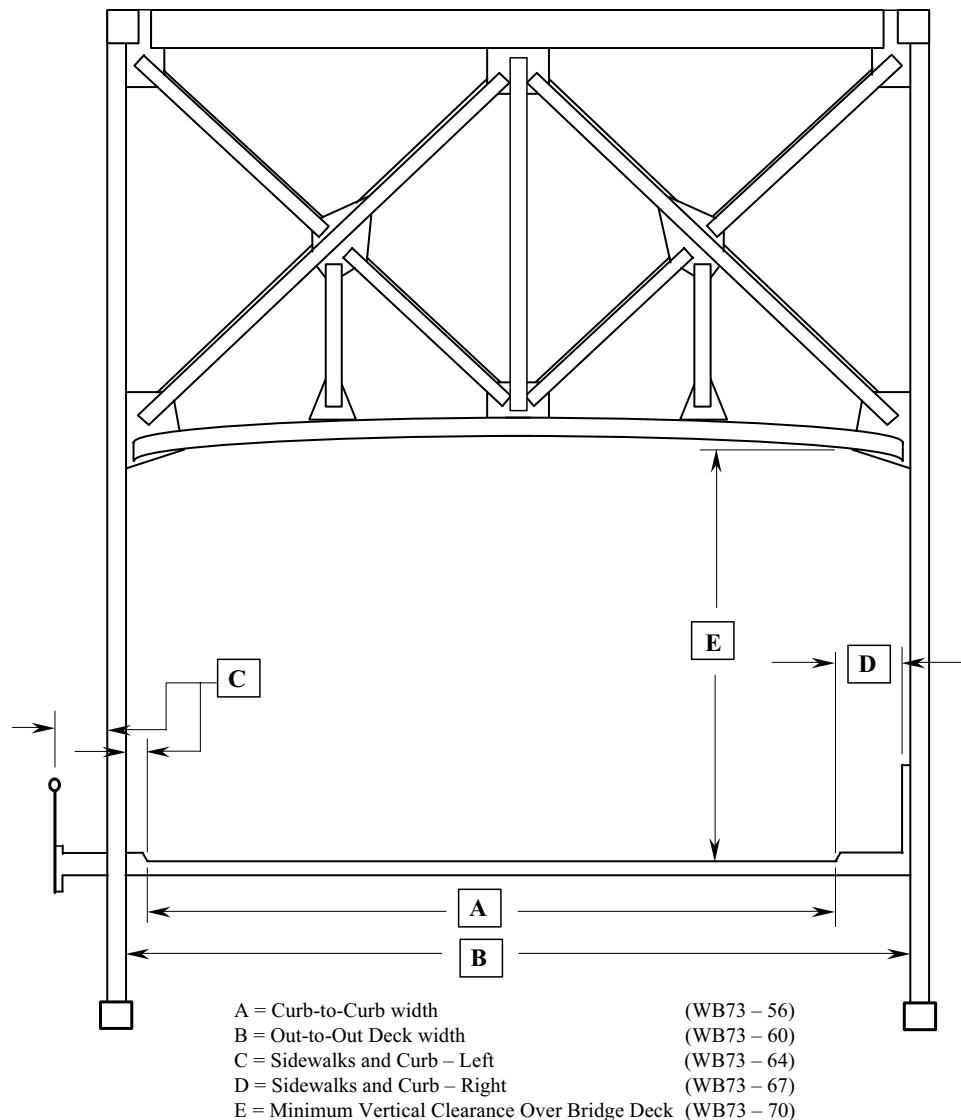

Figure WB73-60

sdwk_curb_left Sidewalk/Curb Width, Left (Required)

WB73-64

FHWA Item 050A The combined usable width of the left-hand sidewalk and curb on the bridge is entered in this field. The left-hand side of the bridge is determined by facing in the direction of increasing mileposts. If no mileposts are in use, left is determined by facing north or east. See Figure WB73-64.

This measurement is coded to the nearest tenth of a foot.

If the bridge has no functional sidewalks and/or curbs, code zeroes in this field. If the bridge has concrete barriers for rails and no sidewalks, also code zeroes.

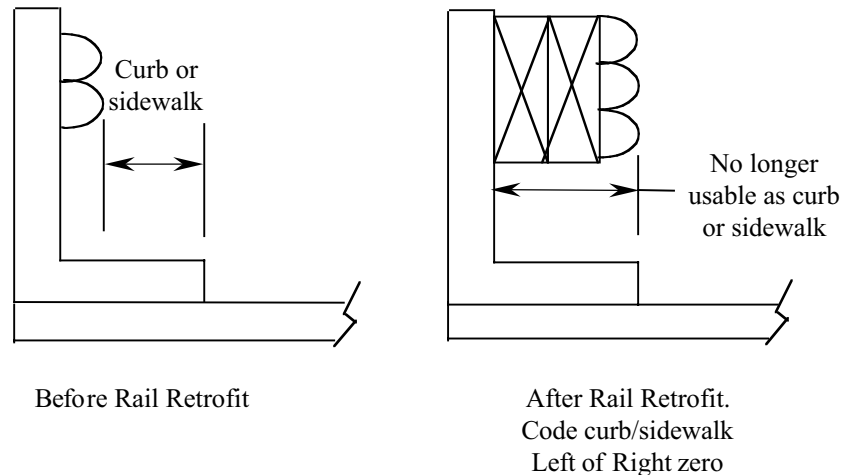

Figure WB73-64

sdwk_curb_right Sidewalk/Curb Width, Right (Required)

WB73-67

FHWA Item 050B The combined usable width of the right-hand sidewalk and curb on the bridge is entered in this field. The right-hand side of the bridge is determined by facing in the direction of increasing mileposts. If no mileposts are in use, right is determined by facing north or east.

This measurement is coded to the nearest tenth of a foot.

If the bridge has no functional sidewalks and/or curbs, code zeroes in this field. If the bridge has concrete barriers for rails and no sidewalks, also code zeroes.

min_vert_deck Minimum Vertical Clearance Over Deck (Required)

WB73-70

FHWA Item 053 The minimum vertical clearance over the bridge deck is entered in this field. This measurement is coded to the nearest lesser inch and should be taken from the top of the traffic lane or shoulder to a point where the clearance is the most restrictive to include bridge mounted elements. The foot (') and inch (") symbols are already marked in the field. See Figure WB73-60.

If there is no restriction, code 9999 in this field. If the minimum restriction is a distance greater than 100 feet, code 9912.

min_vert_under Minimum Vertical Clearance Under Bridge

WB73-74

(Required)

FHWA Item 054B

This field contains the minimum vertical clearance measured under the bridge. This is the minimum vertical clearance from the roadway (travel lanes only) or railroad track beneath the bridge to the underside of the superstructure. See Figure WB73-74.

The value is coded to the nearest lesser inch. The posted clearance is typically less than the measured value. The measured value should be reported in this field. WSDOT typically posts bridges with clearance less than 15'-3".

If the bridge does not cross a highway or a railroad, zeroes should be entered. If the bridge crosses both a highway and a railroad, code the most critical dimension and note why it is the one recorded in the inspection report. See Figure WB73-78.

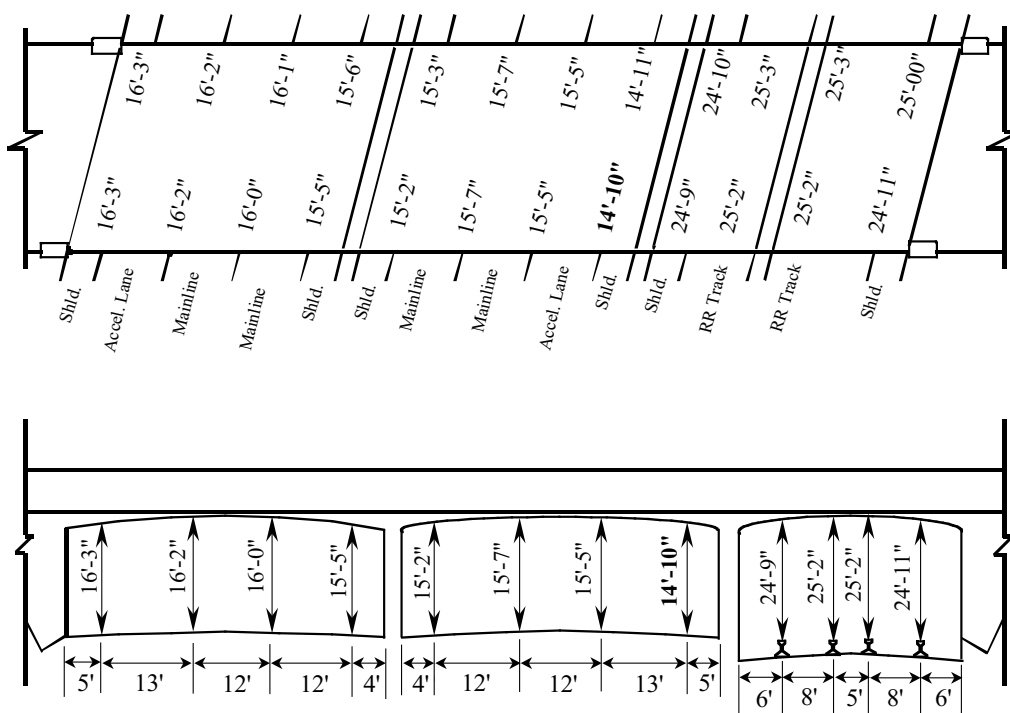

Code the most Restrictive Clearances:

WB73 – 74 would be coded **1410**

WB73 – 78 would be coded **H**

Figure WB73-74 and WB73-78

vert_under **Vertical Underclearance Code** *(Required)*

WB73-78

FHWA Item 054A The code in this field identifies the feature from which the minimum vertical underclearance was taken. If the bridge does not cross a highway or a railroad, the letter "N" shall be entered. If the bridge crosses both a highway and a railroad, the measurement of the minimum vertical underclearance should be taken to the most critical feature. See Figure WB73-78.

H Highway
 R Railroad
 N Neither

From the WSDOT Design Manual 1120.03(5) revised December 1997, the minimum clearance over railroad is 22 feet 6 inches, and minimum clearance over a roadway is 14 feet 6 inches. Select the most restrictive measurement.

The current coding for WB73-74 and WB73-78 is as follows:

- If the bridge crosses neither a highway nor a railroad, code 0000N.
- If the bridge crosses a highway with a minimum vertical underclearance of 18 feet 5 inches, code 1805H.
- If the bridge crosses a railroad with a minimum vertical underclearance of 23 feet 9 inches, code 2309R.
- If the bridge crosses both a highway and a railroad, and the highway has a clearance greater than minimum design standards but the railroad is less than design standards, code the measurement to the railroad.

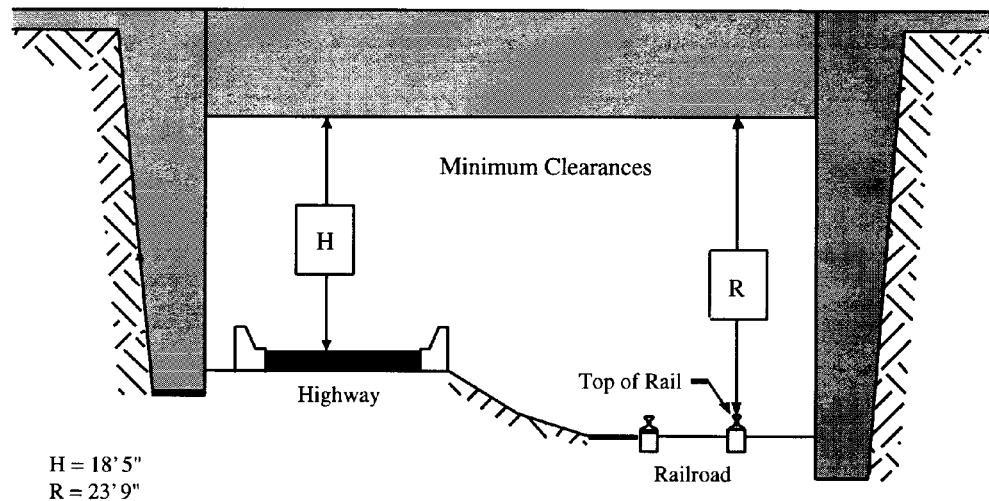

Vertical Clearances
Figure WB73-78

lateral_route_right **Minimum Lateral Underclearance Right** *(Required)*

WB73-79

FHWA Item 055B Using a three-digit number and a one-digit code (WB73-82), record the minimum lateral underclearance on the right to the nearest tenth of a foot (with an assumed decimal point). When both a railroad and highway are under the bridge, code the most critical dimension. This measurement is determined while facing the direction the traffic flows.

The lateral clearance should be measured from the right edge of the roadway (excluding shoulders) or from the centerline (between rails) of the right hand track of a railroad to the nearest substructure unit (pier, abutment, etc.), to a rigid barrier (concrete bridge rail, etc.), or to the toe of a slope steeper than 3:1. The clearance measurements to be recorded will be the minimum after measuring the clearance in both directions of travel. In the case of a divided highway, this would mean the outside clearances of both roadways should be measured and the smaller distance recorded and coded (see Figures WB73-79 through WB73-83).

If two related features are below the bridge, measure both and record the lesser of the two. An explanation should be written on the inspection form as to what was recorded. When the clearance is 100 feet or greater, code 999.

If the feature beneath the bridge is not a railroad or highway, code ØØØN to indicate not applicable.

The presence of ramps and acceleration or turning lanes is not considered in this item; therefore, the minimum lateral clearance on the right should be measured from the right edge of the **through** roadway.

Examples	Code
Railroad 6.22 feet centerline to pier	062
Highway 6.16 feet edge of pavement to pier	062
Creek beneath bridge	000

lateral_route

WB73-82

Lateral Underclearance Code *(Required)*

FHWA Item 055A This code identifies the type of reference feature from which the minimum lateral underclearance measurement on the right was taken. See Figures WB73-79 through WB73-83.

- H Highway beneath bridge.
- R Railroad beneath bridge.
- N Feature beneath the bridge is neither a highway nor a railroad.

lateral_route_left Minimum Lateral Underclearance Route Left

WB73-83

(Required)

FHWA Item 056

Code only for divided highways, one way streets, and ramps. This is not applicable to railroads or two-way roads with closed medians. Using a three-digit number, record and code the minimum lateral underclearance on the left (median side for divided highways) to the nearest tenth of a foot (with an assumed decimal point). The lateral clearance should be measured from the left edge of the roadway (excluding shoulders) to the nearest substructure unit, to a rigid barrier, or to the toe of slope steeper than 1 to 3. Refer to Figures WB73-79 through WB73-83.

In the case of a divided highway, the median side clearances of both roadways should be measured and the smaller distance recorded and coded. If there is no obstruction in the **median area**, a notation of “open” should be recorded and 999 should be coded. For clearances greater than 100 feet, code 998. Code 000 to indicate not applicable.

Code Description

- 000 Not applicable.
- 998 Clearance equal to 99.8 feet or greater.
- 999 Divided highway with no obstructions.

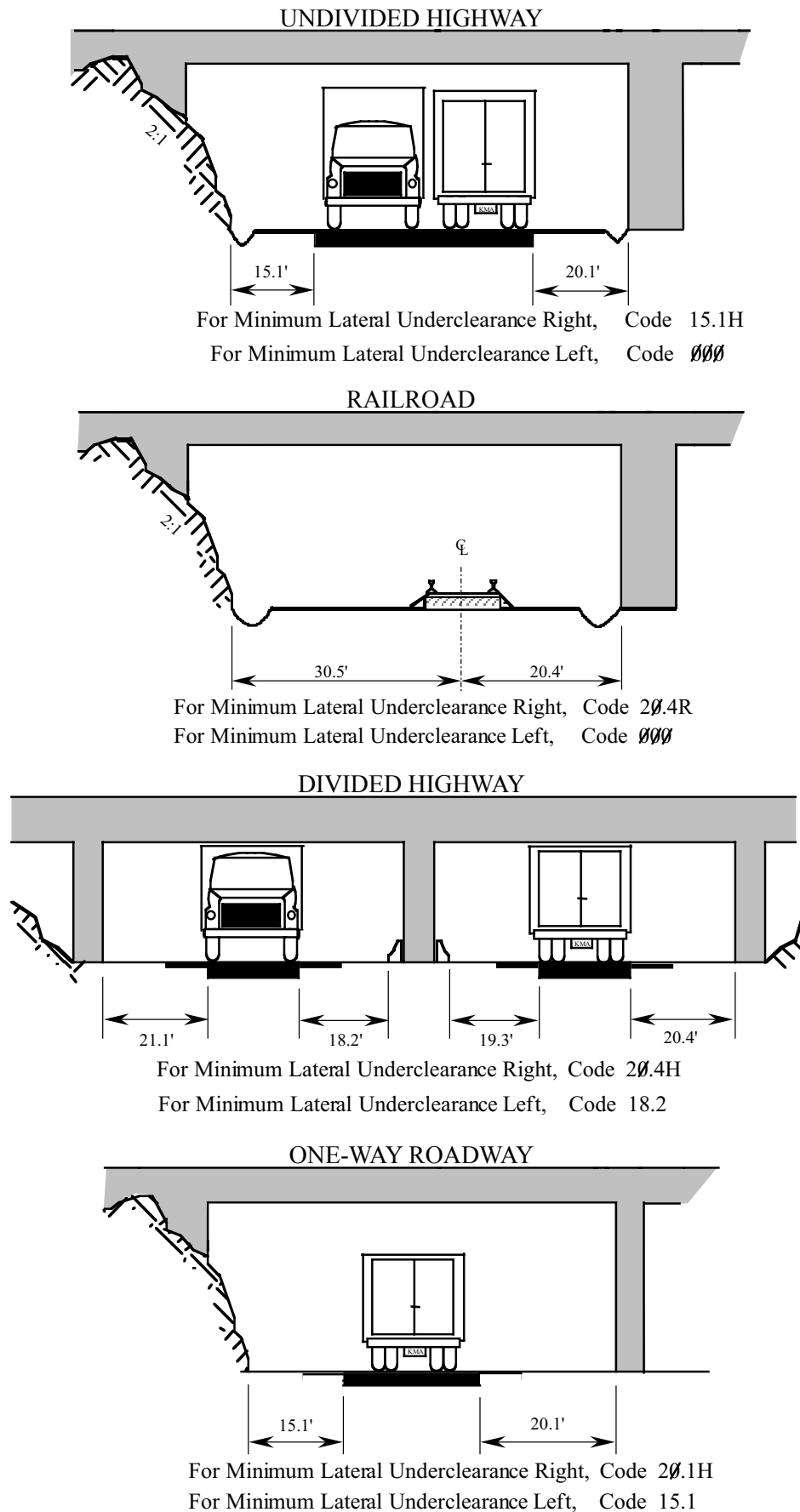

Figures WB73-79 through WB73-83

nav_control_code Navigation Control Code (*Fatal*)

WB73-86

FHWA Item 038 This field indicates whether or not a navigation control (a bridge permit for navigation as issued by the United States Coast Guard) is required.

- 0 No navigation control on waterway (bridge permit does not exist).
- 1 Yes, navigation control on waterway (a bridge permit exists).
- N Not applicable (bridge does not cross a waterway).

nav_vert_clrnc Navigation Vertical Clearance (*Required*)

WB73-87

FHWA Item 039 This field contains the minimum vertical clearance allowable for navigational purposes. If the Navigation Control code has been coded 1, this field will show the number of feet (to the nearest foot rounded down) of minimum vertical clearance imposed at the site. This is not a field measurement but is the number of feet as measured above a datum point specified on the navigation permit.

In the case of a swing or bascule bridge, the clearance should be measured with the bridge in the closed position. In the case of a vertical lift bridge, the clearance should be measured with the bridge in the raised or open position.

If the Navigation Control code has been coded Ø or N, enter zeros in this field to indicate there is no navigational clearance.

nav_horiz_clrnc Navigation Horizontal Clearance (Required)

WB73-90

FHWA Item 040

This field contains the minimum horizontal clearance allowable for navigational purposes. If the Navigation Control code has been coded 1, this field will show the number of feet (to the nearest foot rounded down) of minimum horizontal clearance between fenders (If any), or the minimum clear distance between piers or bents. This is the measurement shown on the navigation permit and may be less than the actual clearance distance measured on site.

If the Navigation Control code has been coded Ø or N, enter zeros in this field to indicate there is no navigational clearance.

UNDIVIDED HIGHWAY
(as approach roadway)

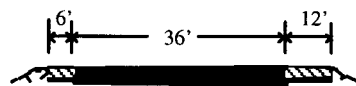

Left Shoulder	Main Roadway	Right Shoulder	Code
6.0	36.0	12.0	054

If the approach roadway is an undivided highway, measure and code the full width of the roadway, including shoulders.

Code: 054

DIVIDED HIGHWAY
(as approach roadway)

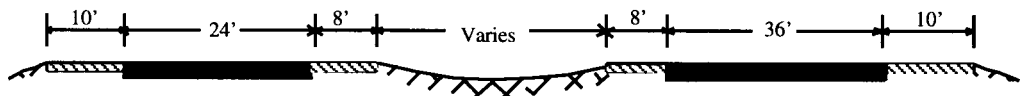

Left Shoulder	Left Roadway	Median Width	Right Roadway	Right Shoulder
10.0	24.0	16.0	36.0	10.0

If the approach roadway is part of a divided highway carried on parallel bridges, there will be two records. Code the width of the approach roadway for the appropriate bridge record.

Code: 042 - for left bridge

Code: 054 - for right bridge

If the approach roadway is part of a divided highway with a median (one structure record), measure and code the width of the left shoulder and roadway, the right shoulder and roadway, plus the average median width of the approach roadway.

Code: 096 (34' + 46' + 16')

Figure WB73-97

vert_lift_min_clrnc Vertical Lift Minimum Navigation Clearance (*Required*)

WB73-94

FHWA Item 116 For vertical lift bridges, this value indicates the minimum vertical clearance for navigational purposes when the bridge is in the closed position (that is, when the bridge allows vehicular traffic to cross).

If the Navigation Control code has been coded 1 and the bridge is a vertical lift bridge, this field will show the number of feet (to the nearest foot rounded down) of minimum vertical clearance imposed at the site. This is the number of feet as measured above a datum point specified on a navigation permit.

If the Navigation Control code has been coded 1, but the bridge is not a vertical lift bridge, leave the field blank.

aprch_width Approach Roadway Width (*Fatal*)

WB73-97

FHWA Item 032 This is the normal width to the nearest foot of the roadway approaching the bridge. This measurement should include the width of shoulders. If the shoulders have been constructed so that they are maintained flush with the adjacent traffic lane and are structurally consistent with these traffic lanes.

This measurement should disregard localized widening. Grass or dirt adjacent to the traffic lanes but not within the maintained roadway should not be considered part of the approach roadway for this item.

For bridges with closed medians, the normal width of the median between the roadways approaching the bridge should not be included in this measurement. Where there is a variation between the approach widths at either end of the bridge, code the narrowest of the approach widths in this field. See Figure WB73-97.

nominal_skew_angle **Skew Angle** (*Fatal*)

WB73-100

FHWA Item 034

The skew angle is a measurement of the angle of intersection between the centerline of a pier and a line drawn perpendicular to the roadway centerline. This angle is coded to the nearest whole degree. See Figure WB73-100.

If the bridge is not skewed, enter 00 in this field. If the skew angle varies from pier to pier, enter the average skew angle, provided it is a representative figure. If it is not, code 99 in this field to indicate that a major variation exists in the skew angles measured from the separate piers supporting the bridge.

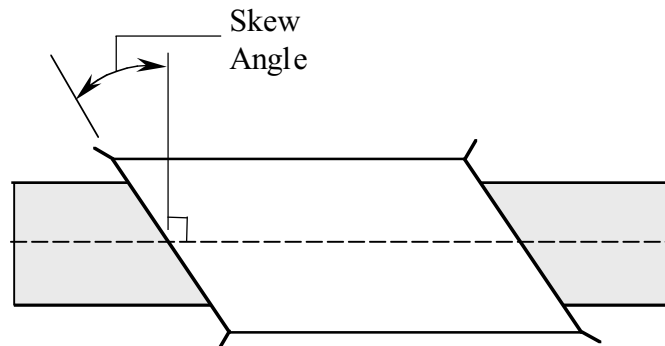
**Figure WB73-100****flared_flag**

WB73-102

FHWA Item 035

Flared Flag (*Fatal*)

This code indicates whether or not the width of the bridge varies (or flares). Although there may be other causes, generally such variance is the result of ramps converging or diverging from the structure's through lanes. Minor widening at the four corners of the bridge (i.e., for aesthetic reasons) is not to be considered a flare.

- N No, bridge does not flare.
- Y Yes, bridge flares.

WB74**on_under_code** **Inventory Route On/Under** (*Fatal*)

WB74-32

FHWA Item 005A

This field identifies whether the route being inventoried is carried on or is under the bridge. It cannot be overemphasized that all route-oriented data must agree in the coding as to whether the route being inventoried is “on” or “under” the bridge.

For all records, there are data elements related to the structure and data elements related to the inventory route. The data elements related to the structure (structure data) will not change whether you are coding for the route on the bridge or for the route under the bridge. However, the data elements related to the inventory route (crossing data) are related to the specific route being inventoried.

These two data element types are maintained in two separate tables in the database and are related to each other by the Structure Identifier and a Crossing Key. The Crossing Key is created from the owner code, route number, and mile post to create a unique addressing code for each crossing. Therefore, each bridge will have only one structure record but may have multiple crossing records.

In order for the computer to keep multiple crossings related to their structure elements, it uses a flag known as the Main listing and Secondary listing flag. All structure records are related to the Main listing. The first or only crossing record for a route is also related to the Main listing. The same is true for under routes where no “on” record is coded, such as a tunnel.

However, where a record for a route is coded “on” a bridge and another record(s) will be coded for a route(s) under the same bridge, there must be a Secondary listing(s) created. This Inventory Coding Form was not designed to report Secondary listings. Regardless of whether the code in this field is 1 or 2, this report always displays the Main listing information.

For Secondary listings, another form must be used. If your agency has a bridge over a federal aid route that fits into this category, contact the Bridge Engineer for Local Agencies for the proper procedures.

For entering the code in this field for the Main listing, use one of the following codes:

Code	Description
0	Highways not carried On or Under structure.
1	Route being inventoried is On the bridge.
2	Route being inventoried is Under the bridge. This would be the code for a single route under the bridge, for tunnels, pedestrian, and railroad undercrossings or even a building.
A-Z	Multiple routes go Under the bridge. The code A will be used for the most important of the multiple routes on separate roadways under the bridge. Z will be for the 26th route under the bridge. The level of importance is determined by STRAHNET designation and the highway class.

If the code entered here is 0, 2 or A-Z, only the following fields need to be entered:

Field Name	WSBIS Code	FHWA No.
Location	WB71-56	009
Latitude	WB71-88	016
Longitude	WB71-96	017
Features Intersected	WB72-32	006A
Facilities Carried	WB72-56	007
FIPS Place Code	WB72-76	004
Toll	WB72-85	020
Parallel Structure	WB72-88	101
Temporary Structure	WB72-89	103
Critical	WB72-90	06B
Year Built	WB73-32	027
Bridge Length	WB73-40	049
NBIS Length	WB73-46	112
Maximum Span Length	WB73-48	048
Lanes On	WB73-52	028A
Lanes Under	WB73-54	028B
Min Vertical Clearance Under Bridge	WB73-74	054B
Vertical Underclearance Code	WB73-78	054B
Minimum Lateral Underclearance Right	WB73-79	055B
Lateral Underclearance Code	WB73-82	055A
Minimum Lateral Underclearance Route Left	WB73-83	056
On/Under	WB74-32	005A
Highway Class	WB74-33	005B
Service Level	WB74-34	005C
Route Number	WB74-35	005D
Mile Post	WB74-40	01}
ADT On Inventory Route	WB74-45	029
Truck ADT PCT	WB74-51	109
ADT Year	WB74-53	030
National Highway System	WB74-83	104
Base Highway Network	WB74-84	012
Strahnet	WB74-85	100
Fed Functional Class	WB74-87	026
National Truck Net	WB74-89	110
Lane Use Direction	WB74-90	102
Horizontal Clearance Route Dir	WB74-91	047
Horizontal Clearance Reverse Dir	WB74-95	047
Max Vertical Clearance Route Dir	WB74-99	110
Detour Length	WB74-103	119
Main Span Material	WB75-32	043A
Main Span Design	WB75-33	043B
Service On	WB75-44	042A
Service Under	WB75-45	042B

Tunnels shall be coded as an “under” record only; that is, they shall not be coded as a bridge carrying highway traffic.

hwy_class **Inventory Route Highway Class** (*Fatal*)

WB74-33

FHWA Item 005B This code identifies what type of highway the inventoried route is on using the following:

- 1 Interstate highway
- 2 U.S. numbered highway
- 3 State highway
- 4 County road
- 5 City street
- 6 Federal lands road
- 7 State lands road
- 8 Other (include toll roads not otherwise identified.)

When two or more routes are concurrent, the highest class of route will be used. The hierarchy is in the order listed above.

serv_level_ **Inventory Route Service Level** (*Fatal*)

WB74-34

FHWA Item 005C This code describes the designated level of service provided by the inventoried route:

- 1 Mainline (most local agency bridges)
- 2 Alternate
- 3 Bypass
- 4 Spur
- 6 Business
- 7 Ramp or "Y"
- 8 Service and/or unclassified Frontage Road
- Ø None of the above

route **Route** (*Fatal*)

WB74-35

FHWA Item 005D The number of the inventory route on (or under) the bridge must be entered in this field. County agencies should enter the County Road Log Number as the inventory route number. City agencies should enter a route number if one has been assigned. If not, the city can enter any unique number in this field; however, rather than arbitrarily assigning a random number, it is recommended that city agencies enter their city number code. This will ensure that two cities within the same county will not enter an identical route number.

Example:

If the bridge is located on highway 14, code **00014**.

If the bridge is located in Sprague, code **01225**.

traffic_flow

WB74-40

FHWA Item 01

Milepost (*Fatal*)

The Linear Referencing System (LRS) milepost is used to establish the location of the bridge on the Base Highway Network (see WB74-84). It must be from the same LRS Inventory Route and milepost system as reported in the Highway Performance Monitoring System (HPMS). The milepost coded in this item directly relates to WB74-67 and WB74-77, the LRS Inventory Route, and Subroute Number.

This item must be coded for all bridges reportable to the NBI. Code a five-digit number to represent the milepost distance in miles to the nearest hundredth (with an assumed decimal point). For bridges carrying the Inventory Route, code the milepost at the beginning of the bridge (i.e., the lowest milepost on the bridge). When the Inventory Route goes under the bridge (WB74-32 coded 2 or A-Z), then code the milepost on the underpassing route where the bridge is first encountered.

For records where mileposts are not provided, use a logical referencing system. Mileposts of zero are undesirable. Mileposts may be coded for bridges that are not located on the Base Highway Network; however, WB74-84, Base Highway Network shall be coded 0 for these records.

Examples	Code
milepost is 130.34	13034
milepost is 9.60	960

adt

WB74-45

FHWA Item 029

ADT on the Inventory Route (*Required*)

This is the Average Daily Traffic (ADT) volume carried on the route being inventoried. If bridges on a divided highway are coded as parallel, then the ADT is the volume carried on the individual bridge, not the cumulative volume carried on the route. The determined ADT volume must be **no more than four (4) years old**. Add leading zeros to fill all spaces in the field.

adt_truck_pct

WB74-51

FHWA Item 109

Truck ADT Percentage (*Required*)

This is the percentage of the ADT volume that is truck traffic. It does not include vans, pickups, or other light delivery trucks. Code to the nearest whole percent.

adt_year

WB74-53

FHWA Item 030

ADT Year (*Required*)

This is the year in which the estimate of the ADT volume was determined. If the year entered in this field is more than four years in the past, a new ADT volume must be determined and entered in the **ADT (WB74-45)** and the year the ADT was determined in this field.

<p>future_adt WB74-57 FHWA Item 114</p>	<p>Future ADT (Required)</p> <p>This is the ADT volume that the inventory route is expected to carry 20 years in the future. This field may be updated whenever a new projection is made. The field must be updated any time the projected date of this forecast is less than 17 years, but not more than 22 years from the current year.</p> <p>This volume is intended to provide a basis for forecasting future construction needs.</p>
<p>future_adt_year WB74-63 FHWA Item 115</p>	<p>Future ADT Year (Required)</p> <p>This is the year for which WB74-57 has been projected.</p> <p>This date must be at least 17, but no more than 22 years from the current year. If the date in this field is outside these limits, then a new value will be required for WB74-57 and a new year will need to be entered in this field.</p>
<p>lrs_route WB74-67 FHWA Item 013A</p>	<p>Linear Referencing System Route (Required)</p> <p>If WB74-84, Base Highway Network, has been or is to be coded Ø, then this field should be left blank.</p> <p>The LRS inventory route and subroute numbers are a 12-digit code composed of two segments. These items must correspond to the LRS inventory route and subroute numbers reported by Washington State for the Highway Performance Monitoring System (HPMS).</p> <p>If WB74-84, Base Highway Network, has been coded 1, the LRS inventory route number is ten digits, right justified, and zero filled. The code can be alphanumeric but cannot contain blanks. The LRS inventory route number is not necessarily the same as the route number posted along the roadway, but is a number used to uniquely identify a route within at least a county and perhaps throughout the state.</p> <p>George will identify where this can be located.</p> <p>Example 1: WB74-84 has been coded zero, structure carries route 99 WB74-67 LRS code will be: blank</p> <p>Example 2: WB74-84 has been coded one, structure carries route 99 WB74-67 LRS code will be: 0000000099</p>
<p>lrs_sub_route WB74-77 FHWA Item 013B</p>	<p>LRS Sub Route (Required)</p> <p>If WB74-84, Base Highway Network, has been or is to be coded 0, then this two-digit field should be left blank.</p> <p>This is the second segment of the LRS inventory route number. It is a number that uniquely identifies portions of an inventory route sections where duplicate mileposts occur or where a route passes through another agencies jurisdiction. If there is no sub route number, code 00 in this segment.</p>

fed_aid_route WB74-79 WSBIS Item 7479	Federal Aid Route Number <i>(Required)</i> If the route being inventoried is a federal aid highway, enter its federal aid route number in this field. Federal Aid Route Numbers are shown on the Statewide National Functional Classification System Maps. These maps are located at local agency planning departments or at WSDOT Service Center Planning. If the bridge is not on a federal aid highway, the field should be filled with zeros.
fed_hwy_system WB74-83 FHWA Item 104	National Highway System <i>(Required)</i> This item shall be coded for all records in the inventory. For the inventory route identified in WB74-35, indicate whether the inventory route is on the NHS or not on that system. This code shall reflect an inventory route on the NHS as described in the TRANSPORTATION EQUITY ACT FOR THE 21ST CENTURY (TEA21). State of Washington National Highway System Maps are located at local agency planning departments or at WSDOT Planning. If more than one federal aid highway is carried on or under the bridge, indicate only the classification of the more primary route. 0 Inventory Route is not on the NHS. 1 Inventory Route is on the NHS.
base_hwy_net WB74-84 FHWA Item 012	Base Highway Network <i>(Fatal)</i> This item shall be coded for all records in the inventory, both on and under records. For the inventory route identified in WB74-35 (Route), indicate whether or not the inventory route is a part of the Base Highway Network. The Base Highway Network includes the through lane (mainline) portions of the NHS system, rural and urban principal arterials, and rural minor arterials. Ramps, frontage roads, and other roadways are not included in the Base Highway Network. If WB74-87 (Federal Function Class) is coded one of the following: 01, 02, 06, 11, 12, 14, this field should be coded 1. 0 Inventory route is not on the Base Highway Network. 1 Inventory route is on the Base Highway Network.

strahnet_hwy

WB74-85

FHWA Item 100

STRAHNET Highway *(Required)*

This item shall be coded for all records in the inventory.

For identification of STRAHNET routes, see the State of Washington National Highway System map. State of Washington Highway System maps are located at local agency planning departments or at WSDOT Service Center Planning.

For the inventory route identified in WB74-35, indicate STRAHNET highway status using one of the following codes:

- 0 The inventory route is not a STRAHNET highway.
- 1 The inventory route is an Interstate STRAHNET highway.
- 2 The inventory route is a non-Interstate STRAHNET highway.
- 3 The inventory route connects with a Department of Defense facility.

fed_lands_hwy_

WB74-86

FHWA Item 105

Federal Lands Highway *(Required)*

This code identifies bridges on roads which lead to and traverse through federal lands. These bridges may be eligible to receive funding from the Federal Lands Highway Program.

Washington State Forest Highways maps can be found in the Emergency Relief chapter of the *Local Agencies Guidelines* (LAG) manual.

As of January 1, 2000, there are three Land Management Systems. There are two in Douglas County and one in Lincoln County.

Use one of the following codes:

- 0 Not Applicable
- 1 Indian Reservation Road (IRR)
- 2 Forest Highway (FH)
- 3 Land Management Highway System (LMHS)
- 4 Both IRR and FH
- 5 Both IRR and LMHS
- 6 Both FH and LMHS
- 9 Combined IRR, FH, and LMHS

For definition of IRR (Indian Reservation Roads), see Title 23 USC Chapter 1, Part 973

fed_functional_class Federal Functional Class (Required)

WB74-87

FHWA Item 026 This code describes the Federal Functional classification of the inventory route as classified according to Statewide National Functional Classification System maps. Statewide National Functional Classification System maps are located at local agency planning departments or online at www.wsdot.wa.gov/mapsdata/travel/hpms/functionalclass.htm.

Separate codes are used to distinguish roadways located in rural or in urban areas. Routes shall be coded rural if they are not inside a designated urban area. Codes 08, 09, and 19 are for roads off the Federal Aid System. See WB74-79, Federal Aid Route Number to reference whether the bridge is on or off the Federal Aid Route system.

Rural Codes		Urban Codes	
01	Principal Arterial-Interstate	11	Principal Arterial-Interstate
02	Principal Arterial-Other	12	Principal Arterial-Other Freeway or Expressway
06	Minor Arterial	14	Other Principal Arterial
07	Major Collector (Federal Aid Secondary)	16	Minor Arterial
08	Minor Collector	17	Collector
09	Local	19	Local

nat_truck_ntwrk_ National Truck Network (Required)

WB74-89

FHWA Item 110 A one letter code is entered in this field to indicate whether the inventory route carried on or under the bridge is part of the National Network for Trucks. This network includes the Interstate System and the Federal Aid Primary System. Routes considered to be a part of the Federal Aid Primary System are “rural arterials and their extensions into or through urban areas in existence on June 1, 1991” (as identified in the Code of Federal Regulations (23 CFR 658)). Roadways on this network are available for use by commercial motor vehicles of the dimensions and configurations described in the Code of Federal Regulations.

- Y Inventory route is part of the National Truck Network.
- N Inventory route is not part of the National Truck Network.

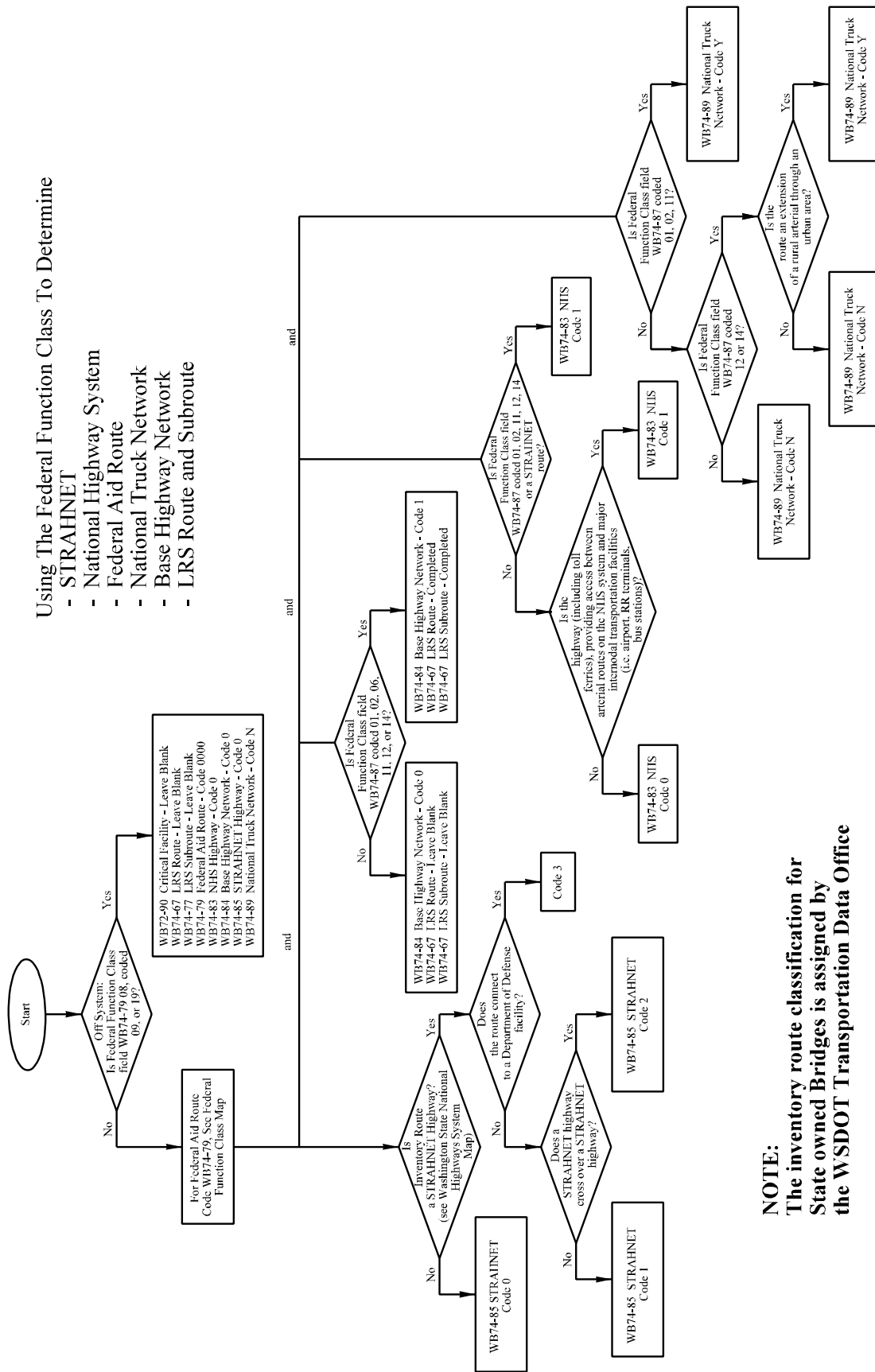

NOTE:
 The inventory route classification for State owned Bridges is assigned by the WSDOT Transportation Data Office

Figure WB74-67 through 89

lane_direction_ WB74-90 FHWA Item 102	Lane Use Direction <i>(Required)</i> Code the direction of traffic on the inventory route identified in WB74-35 as a one-digit number using one of the codes below. This item must be compatible with other traffic-related items such as WB73-52, WB73-56, WB74-45, and WB74-91. <ul style="list-style-type: none"> 0 No highway traffic carried. 1 One-way traffic carried. 2 Two-way traffic carried. 3 Two-way and reversible traffic carried. 4 Reversible traffic only carried. 5 Two-way traffic carried on one-lane bridge (curb-to-curb distance must be < 16').
horiz_clrnc_route WB74-91 FHWA Item 047	Horizontal Clearance, Route Direction <i>(Required)</i> This clearance is the maximum horizontal distance available for wide loads moving across (or under) the bridge or culvert. This measurement shall be coded in feet and inches. See Figure WB74-91. For undivided highways (or one-way ramps or streets), the measurement of horizontal clearance is taken from one side of the roadway to the other. The measurement of horizontal clearance for divided highways is taken only for one side of the roadway, which carries traffic in the direction of increasing mileposts or, in the absence of mileposts, toward the east or north. The measurement of horizontal clearance for the lanes carrying traffic in the opposite direction, called the Reverse Direction, is entered in WB74-95 (Horizontal Clearance Reverse Direction). If the inventory route is carried on the bridge, measure and code the smallest distance between the inside faces of the bridge rail, nonmountable curbs, or the truss members. If the inventory route is carried under the bridge, measure and code the smallest distance between a substructure element and the median barrier. (If the horizontal clearance is restricted by an embankment, measure to the toe of the slope.)

UNDIVIDED HIGHWAY

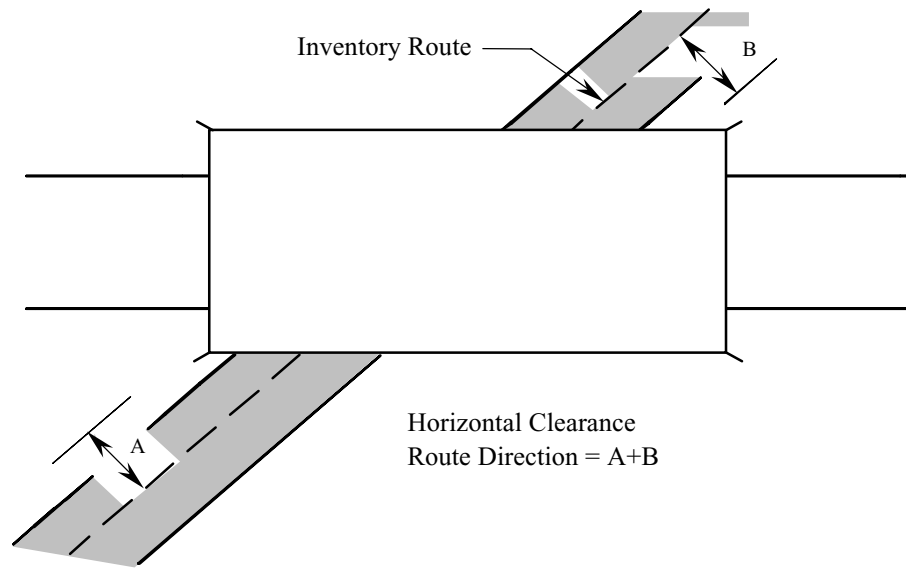

DIVIDED HIGHWAY

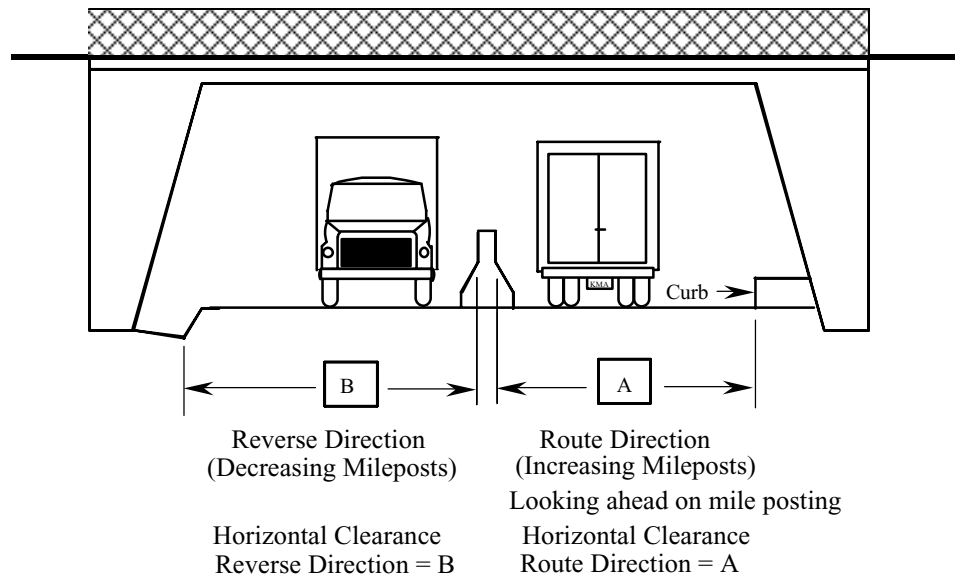

Figure WB74-91 through WB74-95

horiz_clrnc_rvrs **Horizontal Clearance, Reverse Direction** *(Required)*

WB74-95

FHWA Item 047

This is the minimum horizontal clearance for that side of the divided roadway which carries traffic in the direction of decreasing mileposts, or, in the absence of mileposts, to the south or west (see Figure WB74-91). This is called the reverse direction. The measurement shall be coded in feet and inches.

If the inventory route is not a divided highway, leave this field blank.

vert_clrnc_route_max **Maximum Vertical Clearance Route Direction**

WB74-99

FHWA Item 010

A value must be entered in this field to indicate if any height restrictions (imposed by a structural member such as sway bracing on trusses, a bridge passing over this route, the mouth of a tunnel) apply to loads carried **on the inventory** route. This measurement is coded in feet and inches. If the inventory route is carried **on or under the bridge**, code the vertical clearance for the 10-foot width of the traveled part of the roadway which will allow passage of the highest vehicle without striking the bridge. The maximum vertical height allowed in any 10 foot roadway width is the least vertical clearance in the 10 foot width of the roadway with the maximum vertical clearance. If there is no vertical restriction leave the field blank (see Figure WB74-99).

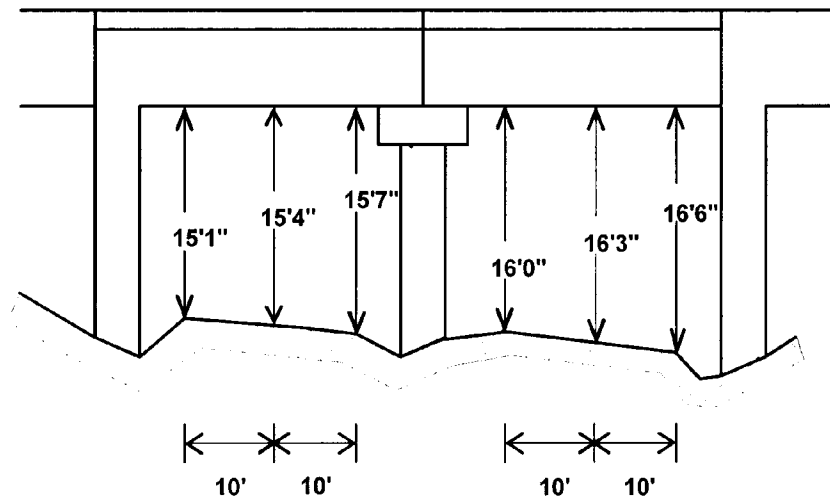

Code "1603": The maximum vertical height allowed in any 10 foot roadway width is the least vertical clearance in the 10 foot width of roadway with the maximum vertical clearance.

Figure WB74-99

detour_length

WB74-103

FHWA Item 019

Detour Length (Fatal)

The detour length is the distance a vehicle, when starting at one end of the bridge, must travel along the shortest alternate route to reach the opposite end of the bridge. The total detour length is coded to the nearest mile. To be an acceptable detour, an alternate route must be a public road and must be able to provide a similar level of load-carrying capacity as the inventory route (see Figure WB74-103).

If the bridge is at an interchange and a ground-level bypass or the other side of a parallel bridge can be used as the detour route, code \emptyset in this field.

If the bridge is not at an interchange and a ground level bypass or parallel bridge can be used as a detour route, code $\emptyset 1$.

If the bridge is on a dead-end road where there is no alternate route, or if the distance that must be traveled is greater than 98 miles, code 99 in the field.

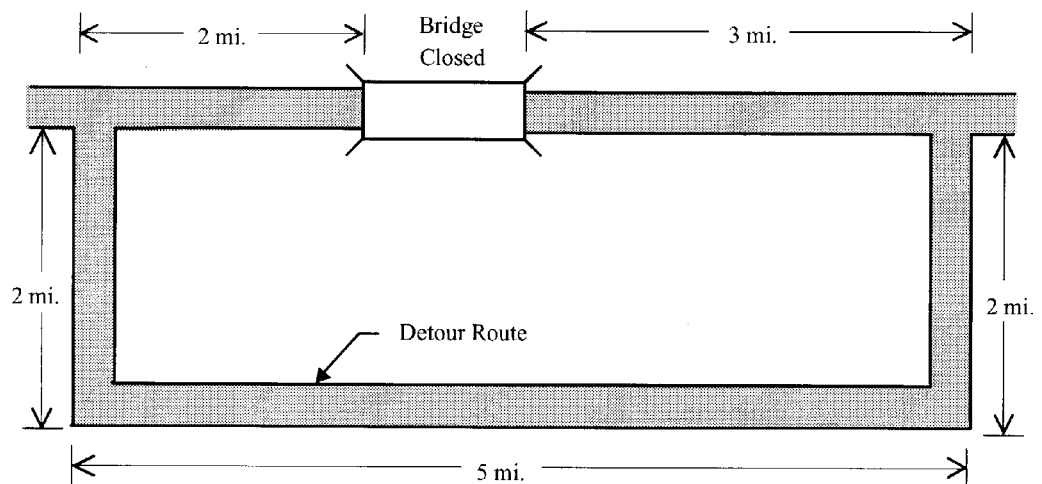

$$\text{Detour Length} = 2 + 2 + 5 + 2 + 3 = 14 \text{ miles}$$

Figure WB74-103

WB75**fed_main_material_ Main Span Material (Required)**

WB75-32

FHWA Item 043A This code describes the kind of material and /or design used in the bridge's main span.

When coding this field, indicate the composition of the superstructure's main load carrying member. That is, if the bridge has a concrete deck carried on timber stringers, code 7 (for timber). Or, if the bridge has a concrete deck carried on steel beams, code 3 (for steel).



- | | |
|---|-----------------------------------|
| 1 | Concrete |
| 2 | Concrete continuous |
| 3 | Steel |
| 4 | Steel continuous |
| 5 | Prestressed concrete |
| 6 | Prestressed concrete continuous |
| 7 | Timber |
| 8 | Masonry |
| 9 | Aluminum, wrought iron, cast iron |
| 0 | Other |

Both pre-tensioned concrete and post-tensioned concrete are considered prestressed concrete.

fed_main_design_ Main Span Design (Required)

WB75-33

FHWA Item 043B This code describes the predominant type of design and/or type of construction used in the bridge's main span. This is a Fatal Field for WSDOT only.

- | | | |
|----|---|---|
| 01 | Slab | |
| 02 | Stringer/multi-beam or girder | |
| 03 | Girder and floorbeam system | |
| 04 | Tee beam | |
| 05 | Box beam/box girder-multiple |  |
| 06 | Box beam/box girder-single or spread |  |
| 07 | Rigid frame | |
| 08 | Orthotropic | |
| 09 | Truss-deck | |
| 10 | Truss – through (Includes Pony Truss) | |
| 11 | Arch-deck | |
| 12 | Arch – through (With or without overhead lateral bracing) | |
| 13 | Suspension | |
| 14 | Stayed girder | |
| 15 | Movable-lift | |
| 16 | Movable-bascule | |
| 17 | Movable-swing | |
| 18 | Tunnel | |
| 19 | Culvert | |
| 21 | Segmental box girder | |
| 22 | Channel beam (bathtub unit) | |
| 00 | Other | |

fed_aprch_material_ Approach Span Material (Required)

WB75-35

FHWA Item 044A This code identifies the kind of material used in the bridge's approach spans.



- 1 Concrete
- 2 Concrete continuous
- 3 Steel
- 4 Steel continuous
- 5 Prestressed concrete
- 6 Prestressed concrete continuous
- 7 Timber
- 8 Masonry
- 9 Aluminum, wrought iron, cast iron
- 0 Other or Not Applicable

When coding this field, indicate the composition of the superstructure's main load carrying member. That is, If the bridge has a concrete deck carried on timber stringers, code 7 (for timber). Or, if the bridge has a concrete deck carried on steel beams, code 3 (for steel).

fed_aprch_design_ Approach Span Design (Required)

WB75-36

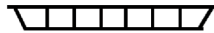
FHWA Item 044B This code identifies the predominant type of design and/or type of construction used in the bridge's approach spans. BMS element descriptions may differ from the following approach span design types.

- 01 Slab
- 02 Stringer/multi-beam or girder
- 03 Girder and floorbeam system
- 04 Tee beam
- 05 Box beam/box girder-multiple 
- 06 Box beam/box girder-single or spread 
- 07 Rigid frame
- 08 Orthotropic
- 09 Truss-deck
- 10 Truss-through
- 11 Arch-deck
- 12 Arch-through
- 13 Suspension
- 14 Stayed girder
- 15 Movable-lift
- 16 Movable-bascule
- 17 Movable-swing
- 18 Tunnel
- 19 Culvert
- 20 Mixed types
- 21 Segmental box girder
- 22 Channel beam (bathtub unit)
- 00 Other or Not Applicable

main_span_qty WB75-38 FHWA Item 045	Number of Main Spans (Required) This is the number of spans in the main or major unit of the bridge. A bridge will contain at least one span. Most bridges will contain a main unit with no approach spans. In such cases, code the number of spans in this field and enter zero in WB75-41. If the bridge contains a main section and approach sections, code the number of spans in the main section only in this field, and code the number of spans in the approach section(s) in WB75-41.
aprch_span_qty WB75-41 FHWA Item 046	Number of Approach Spans (Required) This is the number of spans in the approach(es) to the main section of the bridge. If the bridge has no approach spans, enter zero.
serv_on_code WB75-44 FHWA Item 042A	Service On (Fatal) This field describes the type of service carried on the bridge. <ul style="list-style-type: none"> 1 Highway 2 Railroad 3 Pedestrian exclusively 4 Highway and railroad 5 Highway and pedestrian 6 Overpass bridge at an interchange or second level of a multilevel interchange 7 Third level of a multilevel interchange 8 Fourth level of a multilevel interchange 9 Building or plaza 0 Other
serv_under_code WB75-45 FHWA Item 042B	Service Under (Required) This field describes the type of service under the bridge. <ul style="list-style-type: none"> 1 Highway, with or without pedestrian traffic 2 Railroad 3 Pedestrians exclusively 4 Highway and railroad 5 Waterway 6 Highway and waterway 7 Railroad and waterway 8 Highway, waterway, and railroad 9 Relief for waterway 0 Other

fed_deck_type	Deck Type (Required)
WB75-46	
FHWA Item 107	This is the federal code for the type of deck system on the bridge.
	If the deck is composed of more than one type of material, indicate what type of material is the most predominant.
	If the bridge is a culvert and the roadway is carried on fill, code N to indicate that the deck type is not applicable. WB75-47, Wearing Surface, WB75-48, Membrane, and WB75-49, Deck Protection will also be coded N in this case.
	<ul style="list-style-type: none"> 1 Concrete cast-in-place 2 Concrete precast panels 3 Steel grating-open 4 Steel grating-filled with concrete 5 Steel plate (including orthotropic) 6 Corrugated steel 7 Aluminum 8 Treated timber 9 Untreated timber Ø Other A Filled arches B Precast integral with beam N Not applicable (bridge has no deck)
fed_wear_surf	Wearing Surface (Required)
WB75-47	
FHWA Item 108A	This is the federal code for the type of wearing surface on the bridge deck.
	<ul style="list-style-type: none"> 1 Concrete (also monolithic decks) 2 Integral concrete (non-modified concrete layer added) 3 Latex modified or other modified concrete 4 Low slump concrete 5 Protective overlays (epoxy, methyl methacrylate, polyester) 6 Bituminous (i.e., ACP or BST) 7 Timber 8 Gravel (ballast) 9 Other Ø None (traffic does not ride on wearing surface) N Not applicable (bridge has no deck)
fed_membrane	Membrane (Required)
WB75-48	
FHWA Item 108B	This is the federal code for the type of deck membrane used on the bridge.
	<ul style="list-style-type: none"> 1 Built-up (roofing tar or liquid asphalt) 2 Preformed fabric 3 Epoxy 8 Unknown 9 Other Ø None N Not applicable (bridge has no deck)

fed_deck_prot **Deck Protection** (*Required*)
 WB75-49
 FHWA Item 108C This is the federal code for the type of deck-protective system on the bridge.

- 1 Epoxy coated reinforcing
- 2 Galvanized reinforcing
- 3 Other coated reinforcing bar
- 4 Cathodic protection
- 6 Polymer impregnated
- 7 Internally sealed
- 8 Unknown
- 9 Other
- Ø None
- N Not applicable (bridge has no deck)

design_load_ **Design Load** (*Required*)
 WB75-50
 FHWA Item 031 This code expresses the type and amount of live load the bridge has been designed to carry. Classify any other loading, when feasible, using the nearest equivalent valid code.

- 1 H 10
- 2 H 15
- 3 HS 15
- 4 H 20
- 5 HS 20
- 6 HS 20 + Military Mod
- 7 Pedestrian
- 8 Railroad
- 9 HS 25 or Greater
- 0 Unknown
- A HL-93
- B Greater than HL-93
- C Other

oper_rtng_meth **Operating Rating Method** (*Required*)
 WB75-51
 FHWA Item 063 Code this field with one of the following codes to indicate which load rating method was used to determine the Operating Rating for this bridge. FHWA has chosen the Load Factor Method as the standard for computing Operating and Inventory ratings reported to the NBI. For proper coding, see load rating section of Chapter 5.

- F Load Factor reported in tons
- W Working Stress reported in tons
- L Load and Resistance Factor reported in tons
- T Load Testing
- N No rating analysis was performed
- A Administrative
- 6 Load Factor Rating reported by Rating Factor using HS-20 loading
- 7 Working Stress Rating reported by Rating Factor using HS-20 loading
- 8 Load and Resistance Factor reported by Rating Factor using HL-93 loading

oper_rtng_tons WB75-52 FHWA Item 064	Operating Rating Tons <i>(Required)</i> This field contains a value which indicates the absolute maximum gross weight (in tons) to which the bridge may be subjected for the type of vehicle used in the operating rating. HS loading shall be used in the rating. The following conditions will apply: <ul style="list-style-type: none"> • If the bridge will not carry a minimum of 3 tons of live load, code zero, and consistent with the direction of the AASHTO Manual for Bridge Evaluation, it shall be closed. • If the bridge is a temporary bridge, code zero in this field (since there is no permanent bridge) even though the temporary bridge is rated for as much as a full legal load. • If the bridge is shored up or repaired on a temporary basis, it is considered a temporary bridge and should be coded as If the shoring were not in place. • Code 99 for a bridge under sufficient fill such that according to AASHTO design the live load is insignificant in the bridge load capacity.
invrt_rtng_meth WB75-54 FHWA Item 065	Inventory Rating Method <i>(Required)</i> Code this field with one of the codes listed below to indicate which load rating method was used to determine the Inventory Rating coded for this bridge. FHWA has chosen the Load Factor Method as the standard for computing Operating and Inventory rating reported to the NBI. <ul style="list-style-type: none"> F Load Factor reported in tons W Working Stress reported in tons L Load and Resistance Factor reported in tons T Load Testing N No rating analysis was performed A Administrative 6 Load Factor Rating reported by Rating Factor using HS-20 loading 7 Working Stress Rating reported by Rating Factor using HS-20 loading 8 Load and Resistance Factor reported by Rating Factor using HL-93 loading
invrt_rtng_tons WB75-55 FHWA Item 066	Inventory Rating Tons <i>(Required)</i> This is the capacity rating, in tons, which results in a load level which can safely utilize an existing bridge for an indefinite period of time. HS loading shall be used in the rating. The following conditions will apply: <ul style="list-style-type: none"> • If the bridge is a temporary bridge, code zero in this field (since there is no permanent bridge) even though the temporary bridge is rated for as much as a full legal load. • If the bridge is shored up or repaired on a temporary basis, it is considered a temporary bridge and should be coded as If the shoring were not in place. • Code 99 for a bridge under sufficient fill such that according to AASHTO design the live load is insignificant in the bridge load capacity.

op_rating_factor **Operating Rating Factor**

If Item 551 is coded 6, 7, or 8, the operating rating factor is entered here as a 3-digit number without the decimal point.

inv_rating_factor **Inventory Rating Factor**

If Item 554 is coded 6, 7, or 8, the inventory rating factor is entered here as a 3-digit number without the decimal point.

design_exception_date **Design Exception Date** *(Optional)*

WB75-57

WSBIS Item 7557 If a design exception has been granted by the FHWA to permit a deviation from required standards, this is the effective date of FHWA approval.

For example, if approval to build a one-lane bridge on a low volume road was granted, enter the date approval was given for this exception. Indicate the date in the MMDDYYYY format. If no design exception has been granted, leave the field blank.

fed_aid_project **Federal Aid Project** *(Optional)*

WB75-65

WSBIS Item 7565 This is the most recent federal aid project number under which federal funds have been used for construction or reconstruction from the year 1970 forward.

Left justify and leave unused columns blank. If the construction work has been assigned more than one federal aid project number, enter the number for the most recently completed (or current) portion of the project. If federal funds have not been used, leave the field blank.

border_state_code **Border Bridge State Code** *(Required)*

WB75-85

FHWA Item 098A For bridges which do not cross a Washington State border, leave this field blank.

This is the code of the neighboring state with which Washington State, or a Local Agency within Washington State, shares responsibility for improvements on the existing bridge which crosses state borders. Valid codes are:

160 Idaho
410 Oregon
CAN Canada

border_pct **Border Bridge Percent** *(Required)*

WB75-88

FHWA Item 098B For bridges which do not cross a Washington State border, leave the field blank.

This is the percentage of responsibility a neighboring state accepts for improvements on an existing bridge which crosses state borders.

Code the percentage of square footage of the existing bridge that the neighbor is responsible for funding.

border_structure_id **Border Bridge Structure Identifier** *(Required)*

WB75-90

FHWA Item 099 If the bridge does not cross a Washington State border, leave this field blank.

This is the neighboring state's 15 character National Bridge Inventory Structure Number.

The entire 15 character field must be filled in exactly, including any blank spaces and any leading, trailing, or imbedded zeros.

The Bridge Inspection Report (BIR) NBI section has numbers in parentheses that reflect the inventory form WB76. For example, WB76-57, Structural Adequacy Appraisal, is (657) on the BIR.

WB76**alphabetic_span** **Alphabetic Span Type(s) (Optional)**

Use the table below to identify each group of span types that make up the entire bridge. Separate each span group by a space. List the Main Span first. The sequence for listing the Approach Spans should be longest to shortest but is somewhat arbitrary. The Alphabetic Span type for the Main and Approach spans must be compatible with Items 532, 533, 535 and 536 respectively.

As an example suppose you have a Steel Through Truss with a 140' Creosote Treated Timber approach at one end of the truss and a 30' Concrete t-beam at the other approach.

Items 532 would = 3 and 533 would = 10. Items 535 would = 1 or 7 and 536 would = 04 or 02 depending on which approach you choose to list.

The Alphabetic Span would be entered as follows:

STrus TTC CTB

Alphabetic Span	Definition	Alphabetic Span	Definition
Aculv	Aluminum Culvert	PRCB	Precast Reinforced Concrete Beam
BAS	Bascule Lift Span	SA	Steel Arch
CA	Concrete Arch	STA	Steel Tied Arch
CEFA	Concrete Earth Filled Arch	SRB	Steel Rolled Beam
CBox	Concrete Box Girder	SBG	Steel Box Girder
CCulv	Concrete Culvert	SCulv	Steel Culvert
CFP	Concrete Floating Pontoon	SFP	Steel Floating Pontoon
CG	Concrete Girder	SG	Steel Girder (weld or rivet)
CS	Concrete Slab	SLS	Steel Lift Span
CSS	Cable Stayed Span	SSCG	Steel Stayed Concrete Girder
CVS	Concrete Voided Slab	SSwS	Steel Swing Span
CSTP	Concrete Slab on Timber Piling	Strus	Steel Truss
CTB	Concrete T-Beam	SSusS	Steel Suspension Span
CTrus	Concrete Truss	TCulv	Timber Culvert
CTun	Concrete Lined Tunnel	TS	Timber Slab
CESB	Concrete Encased Steel Beam	TTLB	Treated Timber Laminated Beam
LIDTun	Cut and Cover (LID) Tunnel	TTTrus	Treated Timber Truss
MCulv	Masonry Culvert	TTS	Treated Timber (Salts) Bridge
PCG	Prestressed Concrete Girder	TTC	Treated Timber (Creosote) Bridge
PCS	Prestressed Concrete Slab	TLTun	Timber Lined Tunnel
PCBTG	Prestressed Concrete Bulb-T Girder	UTun	Unlined Tunnel
PCMWG	Prestressed Concrete Multi-Web Girder	Plaza	Park Plaza Structures
PCTG	Prestressed Concrete Trapezoidal Girder	UTTrus	Untreated Timber Truss
PTCTB	Post-Tensioned Concrete T-Beam	UT	Untreated Timber Bridge
PTCBox	Post-Tensioned Concrete Box Girder	UTLB	Untreated Timber Laminated Beam
PTCSeg	Post-Tensioned Segmental Box Girder	WSG	Weathering Steel Girder

Type	Field Name	WSBIS	FHWA
Item Inspection Elements			
Reqd.	Routine Inspection Frequency	WB76-32	091
Fatal	Date of Last Routine Inspection	WB76-34	090
Reqd..	Routine Inspection Hours on Site	WB76-42	
Reqd.	Inspector's Initials	WB76-46	
Fatal	Inspector's Certification Number	WB76-49	
Optl.	Co-Inspector's Initials	WB76-54	
Adequacy Appraisals			
Gen.	Structural	WB76-57	067
Gen.	Deck Geometry	WB76-58	068
Gen.	Underclearance	WB76-59	069
Reqd.	Operating Level	WB76-60	070
Reqd.	Alignment	WB76-61	072
Reqd.	Waterway	WB76-62	071
Inspection Conditions			
Reqd.	Overall Deck Condition	WB76-63	058
Optl.	Drain Condition	WB76-64	
Optl.	Drain Status	WB76-65	
Optl.	Deck Scaling Severity	WB76-66	
Optl.	Deck Scaling Percent	WB76-67	
Optl.	Deck Rutting	WB76-69	
Optl.	Deck Exposed Steel Code	WB76-70	
Reqd.	Superstructure Overall	WB76-71	059
Optl.	Curb Condition	WB76-72	
Optl.	Sidewalk Condition	WB76-73	
Optl.	Paint Condition	WB76-74	
Optl.	Number of Utilities	WB76-75	
Reqd.	Substructure Condition	WB76-76	060
Reqd.	Channel Protection	WB76-77	061
Reqd.	Culvert Condition	WB76-78	062
Reqd.	Pier / Abutment Protection	WB76-79	111
Reqd.	Scour	WB76-80	113
Reqd.	Approach Roadway Condition	WB76-81	
Optl.	Retaining Walls Condition	WB76-82	
Optl.	Pier Protection Condition	WB76-83	
Reqd.	Traffic Safety, Bridge Rails	WB76-840	36A
Reqd.	Traffic Safety, Bridge Rails	WB76-850	36B
Reqd.	Traffic Safety, Bridge Rails	WB76-860	36C
Reqd.	Traffic Safety, Bridge Rails	WB76-870	36D

Bridge Condition Inspection Fields
Table WB76-32

inspn_freq WB76-32 FHWA Item 091	Routine Inspection Frequency (Required) This is the number of months between consecutive routine inspections. The standard maximum frequency of NBI bridges for Routine Inspections is 24 months.
last_inspn_date WB76-34 FHWA Item 090	Date of Last Routine Inspection (Fatal) This is the date the most recent routine inspection was performed on this bridge.
inspn_hours WB76-42	Routine Inspection Hours on Site (Optional) This is the total number of inspection hours (to the tenth of an hour) that the inspection team spent on the bridge during a Routine Inspection.
inspr_initials WB76-46	Inspector's Initials (Required) These are the initials of the inspector whose certification number appears in WB76-49.
cert_no WB76-49	Inspector's Certification Number (Fatal) This is the certification number of the lead inspector at the bridge site performing the routine inspection.
co_inspn_initials WB76-54	Co-Inspector's Initials (Optional) These are the initials of the individual who assisted the lead inspector in performing a routine inspection.
Adequacy Appraisal	<p>There are six fields used to appraise the adequacy of the bridge in relation to the level of service it provides on the highway system of which it is a part. To make this appraisal, the present condition of the bridge is compared to the condition of a new bridge built to current standards for that particular classification of road (with the exception of underclearance).</p> <p>The appraisal codes for Structural Adequacy Appraisal, Deck Geometry Appraisal, and Underclearance Adequacy Appraisal are computed automatically by the WSBIS system.</p> <p>The appraisal codes for Operating Level, Alignment Adequacy Appraisal, and Water Way Adequacy Appraisal are not computed automatically and must be entered by the bridge inspector. See the field descriptions that follow.</p>

structure_adqcy **Structural Adequacy Appraisal** (*Generated*)

WB76-57

FHWA Item 067

The value in this field is generated by the WSBIS system and rates the adequacy of the structure’s condition, taking into account any major structural deficiencies. This rating is based on the overall condition of the superstructure, substructure, the inventory rating, and the ADT.

Table WB76-57 explains how the inventory rating may further lower this code. The code for this item is no higher than the lowest of the condition codes for Superstructure Overall, Substructure Condition, or Culvert Condition.

ADT			Structural Adequacy Appraisal Rating Code
0-500	501-5000	>5000	
Inventory Rating HS Truck (Tons)			
	Not Applicable		9
36	36	36	8
31	31	31	7
23	25	27	6
18	20	22	5
12	14	18	4
Inventory rating less than value in rating code of 4 and requiring corrective action.			3
Inventory rating is less than above and bridge requires replacement, WB78-44 is coded 31 or 32.			2
Bridge is closed and requires replacement.			∅

Structural Adequacy Appraisal Rating
Table WB76-57

deck_geometry_aprsl Deck Geometry Appraisal (Generated)

WB76-58

FHWA Item 068 The value in this field is generated by the WSBIS system. This is the adequacy appraisal rating of the bridge's deck geometry. The level of service provided by the bridge is evaluated with respect to the highway system of which it is a part. This appraisal is based on the number of traffic lanes, the curb-to-curb width, the minimum vertical clearance over the bridge deck, the ADT, and the federal functional classification.

The following Tables, WB76-58A through E, explain how the values are determined with respect to the highway system of which the bridge is a part. The lowest code determined from the tables is used.

Curb-to-Curb Bridge Roadway Width (In Feet)						Deck Geometry Appraisal Rating Code
Average Daily Traffic (ADT) (Both Directions)						
0-100	101-400	401-1000	1001-2000	2001-5000	>5000	
Not Applicable						9
≥ 32	≥ 36	≥ 40	≥ 44	> 44	> 44	8
28	32	36	40	44	44	7
24	28	30	34	40	44	6
20	24	26	28	34	38	5
18	20	22	24	28	32 (28)	4
16	18	20	22	26	30 (26)	3
Bridge is open and has a width less than required for a rating code of 3 and WB78-44 is coded 31.						2
Bridge is closed.						∅

Notes:

1. For bridges longer than 200 feet, use the values shown in parentheses.
2. Use the lower rating code for roadway widths between those shown.
3. For bridges with three or more undivided lanes of two-way traffic, use Table WB76-58C under the column NUMBER of LANES (Other Roadways).
4. For bridges with one-lane and one-way traffic.

**Deck Geometry Appraisal Rating Two-Lane Bridge With Two-Way Traffic or
One-Lane With One-Way Traffic**

Table WB76-58A

Curb-to-Curb Bridge Roadway Width (In Feet)		Deck Geometry Appraisal Rating Code
Average Daily Traffic (ADT) (Both Directions)		
0-100	>100	
Not Applicable		9
15'11"	–	8
15	–	7
14	–	6
13	–	5
12	–	4
11	15'11"	3
Bridge is open and has a width less than required for a rating code of 3 and WB78-44 is coded 31.		2
Bridge is closed.		∅

Notes:

1. Use the lower rating code for a roadway widths between those shown.
2. All single lane bridges with a deck width less than 16 feet and an ADT > 100 should be rated at 3 or below.

Deck Geometry Appraisal Rating One-Lane Bridge With Two-Way Traffic
Table WB76-58B

Curb-to-Curb Bridge Roadway Width (In Feet)				Deck Geometry Appraisal Rating Code
Two or More Lanes in Each Direction				
Number of Lanes (Interstate)		Number of Lanes (Other Roadways)		
2 Lanes	> 2 Lanes	2 Lanes	> 2 Lanes	
Not Applicable				9
≥ 42	≥ 12N + 24	≥ 42	≥ 12N + 18	8
40	12N + 20	38	12N + 15	7
38	12N + 16	36	12N + 12	6
36	12N + 14	33	11N + 10	5
34 (29)	11N + 12 (11N + 7)	30	11N + 6	4
33 (28)	11N + 11 (11N + 6)	27	11N + 5	3
Bridge is open and has a width less than required for rating code of 3 and WB78-44 is coded 31.				2
Bridge is closed				∅

Notes:

1. N = Number of traffic lanes.
2. Use the lower rating code for roadway widths between those shown.
3. For bridges longer than 200 feet, use the values shown in parentheses.

Deck Geometry Appraisal Rating Bridges With Two-Way Traffic
Table WB76-58C

Bridge/Ramp Width (In feet)		Deck Geometry Appraisal Rating Code
Number of Lanes		
1 Lane	> 1 Lane	
Not applicable		9
≥ 26	≥ 12N + 12	8
24	12N + 10	7
22	12N + 8	6
20	12N + 6	5
18	12N + 4	4
16	12N + 2	3
Bridge is open and has deck width less than required for a rating code of 3 and WB78-44 is coded 31.		2
Bridge is closed.		∅

Notes:

1. N = Number of traffic lanes.
2. Use the lower rating code for a roadway width between those shown.

Deck Geometry Appraisal Rating for Ramps With One-Way Traffic (Service Level = 7)
Table WB76-58D

Functional Class				Deck Geometry Appraisal Rating Code
Interstate and Other Freeway		Other Principal and Minor Arterials	Major and Minor Collectors and Locals	
Designated Routes*	Undesignated Routes*			
Minimum Vertical Clearance				
Not Applicable				9
≥ 17'0"	≥ 16'0"	≥ 16'6"	≥ 16'6"	8
16'9"	15'6"	15'6"	15'6"	7
16'6"	14'6"	14'6"	14'6"	6
15'9"	14'3"	14'3"	14'3"	5
15'0"	14'0"	14'0"	14'0"	4
Vertical clearance is less than value for rating of 4; corrective action is required.				3
Vertical clearance is less than value for rating of 4 and WB78-44 is coded 31; replacement is required.				2
Bridge is closed.				∅

Notes:

*Use the first column (Designated Routes) for all routes except designated routes in urban areas where there is an alternative interstate or freeway facility with a minimum clearance of at least 16' 0". Use the second column (Undesignated Routes) for all undesignated interstate or freeway facilities.

1. Use the lower rating code for any vertical clearance measurements between those shown.

Deck Geometry Appraisal Rating
Table WB76-58E

underclrnc_aprsl Underclearance Adequacy Appraisal (Generated)

WB76-59

FHWA Item 069 The code for this field is generated by the WSBIS system.

It rates the adequacy of the bridge's underclearance. This appraisal is based on the vertical and lateral underclearances beneath the bridge as related to the federal functional classification of the roadway carried beneath the bridge. If the bridge is not over a highway or a railroad, the field will be set to 9.

See Tables WB76-59A and B for an explanation of how the values are calculated.

Functional Class					Under-Clearance Adequacy Appraisal Rating Code
Interstate and Other Freeway		Other Principal and Minor Arterials	Major and Minor Collectors and Locals	Railroads	
Designated Routes*	Undesignated Routes*				
Minimum Vertical Underclearance					
Not Applicable					9
≥ 17'0"	≥ 16'0"	≥ 16'6"	≥ 16'6"	≥ 23'0"	8
16'9"	15'6"	15'6"	15'6"	22'6"	7
16'6"	14'6"	14'6"	14'6"	22'0"	6
15'9"	14'3"	14'3"	14'3"	21'0"	5
15'0"	14'0"	14'0"	14'0"	20'0"	4
Vertical clearance is less than value for rating of 4; corrective action is required.					3
Vertical clearance is less than value for rating of 4 and WB78-44 is coded 31; replacement is required.					2
Bridge is closed.					Ø

Notes:

*Use the first column (Designated Routes) for all routes except designated routes in urban areas where there is an alternative interstate or freeway facility with a minimum clearance of at least 16' 0". Use the second column (Undesignated Routes) for all undesignated interstate or freeway facilities.

1. Use the lower rating code for any vertical clearance measurements between those shown.

**Underclearance Adequacy Appraisal Rating
Table WB76-59A**

Functional Class							Under-clearance Adequacy Appraisal Rating Code
One-Way Traffic				Two-Way Traffic			
Principal Arterials (Interstate, etc.)				Other Principal and Minor Arterials	Major and Minor Collectors and Locals	Railroads	
Main Line		Ramp					
Lt.	Rt.	Lt.	Rt.				
Minimum Lateral Underclearance (Feet)							
Not Applicable							9
≥ 30	≥ 30	≥ 4	≥ 10	≥ 30	≥ 12	≥ 20	8
18	21	3	9	21	11	17	7
6	12	2	8	12	10	14	6
5	11	2	6	10	8	11	5
4	10	2	4	8	6	8	4
Underclearance is less than value for rating of 4; corrective action is required.							3
Underclearance is less than value for rating of 4 and WB78-44 is coded 31; replacement is required.							2
Bridge is closed.							∅

Notes:

1. Use the lower rating code for any underclearance measurements between those shown.
2. Use the value from the Right Ramp column to determine the rating code when acceleration or deceleration lanes or ramps are provided under two-way traffic.

Underclearance Adequacy Rating
Table WB76-59B

safe_load_code
WB76-60
FHWA Item 070

Operating Level (Required)

This appraisal is a consideration of the relationship between the load that may legally use the bridge and the desired load capacity for this type of bridge in the state of Washington. It is to be based on the bridge’s operating rating.

When the maximum legal load allowed in the state exceeds the operating rating, the bridge must be posted. This is in accordance with the requirements of the NBIS. Agencies, however, may elect to post bridges at lower rating capacities. If this is done, WB72-93 may show that the bridge is posted while the field may show that posting is not required. Such coding information is not in conflict but is acceptable and correct.

If the bridge is a temporary bridge, the operating level appraisal rating must reflect its actual load-carrying capacity at the operating rating. The rating should be made based on the loads the bridge is actually carrying. This also applies to bridges which have been shored up or repaired on a temporary basis.

Refer to the Operating Rating Factors Table on page 2.06-C-21 to determine the proper code to enter in this field.

alignment_aprsl **Alignment Adequacy Appraisal** *(Required)*

WB76-61

FHWA Item 072

The evaluation of the approach roadway alignment is based on an assessment of how that alignment relates to the general alignment of the section of highway the bridge is on. The approach roadway alignment is not intended for comparison to current standards, but rather to the existing highway alignment. This field identifies bridges which do not function properly or safely due to the alignment of their approach roadways.

Speed reductions necessary because of the width of the bridge deck will not be considered.

The following codes are to be used:

- 9 Not applicable (non-vehicular traffic use).
- 8 No reduction in speed required for vehicle as it approaches the bridge.
- 6 Minor reduction in speed required for vehicle as it approaches the bridge.
- 3 Horizontal or vertical curvature of approach roadway requires substantial reduction in the speed of vehicle as it approaches the bridge.

waterway_aprsl **Waterway Adequacy Appraisal** *(Required)*

WB76-62

FHWA Item 071

This item appraises the waterway opening with respect to passage of flow beneath the bridge. The following codes shall be used in evaluating waterway adequacy (interpolate where appropriate). Site conditions may warrant somewhat higher or lower rating than indicated by Table WB76-62 (i.e., flooding of an urban area due to a restricted bridge opening).

The frequency of overtopping means the following:

- | | |
|------------|------------------------|
| Remote | greater than 100 years |
| Slight | 11 to 100 years |
| Occasional | 3 to 10 years |
| Frequent | less than 3 years |

Adjectives describing traffic delays mean the following:

Insignificant Minor inconvenience. Highway passable in a matter of hours.
 Significant Traffic delays of up to several days.
 Severe Long-term delays to traffic with resulting hardship.

Description	Functional Class*		
	1	2	3
	Code		
Bridge not over a waterway	9	9	9
Bridge deck and roadway approaches above flood (high) water elevations. Chance of overtopping remote.	8	8	8
Bridge deck above roadway approaches. Slight chance of over topping roadway approaches.	7	7	8
Slight chance of over topping bridge deck and roadway approaches.	6	6	7
Bridge deck is higher than approaches. Occasional over topping of roadway approaches with insignificant delays.	4	5	6
Bridge deck is higher than approaches. Occasional overtopping of roadway approaches with significant delays.	3	4	5
Occasional overtopping of both bridge deck and roadway approaches with significant delays.	2	3	4
Frequent overtopping of both bridge deck and roadway approaches with significant delays.	2	2	3
Occasional or frequent overtopping of both bridge deck and roadway approaches with severe delays.	2	2	2
Bridge closed – hydraulics problem	Ø	Ø	Ø

*Functional Class:

1 = Principal arterials, interstates, freeways, or expressways.

2 = Other principal arterials, minor arterials, and major collectors.

3 = Minor collectors and local roadways.

Waterway Adequacy Appraisal Rating

Table WB76-62

Condition Rating Codes

Codes are entered in WB76-63 to WB76-83 to describe (rate) the current condition of the existing, in-place bridge as compared to its as built condition. WB76-71 and WB76-76 are based on the overall condition of the bridge elements that comprise either the superstructure or substructure.

Condition codes are properly used when they provide an overall characterization of the general condition of the entire set of components being rated. They are improperly used if they attempt to describe localized or nominally occurring instances of deterioration or disrepair. In assigning condition codes, therefore, the engineer should consider both the severity of deterioration or disrepair and the extent to which it is widespread throughout the components being rated.

The existing condition of the bridge should be the only consideration in making these evaluations. The fact that a bridge may be posted or may have been designed for less than the current legal load should have no bearing on the evaluation of its present condition. Similarly, the fact that portions of a bridge are being supported or strengthened by temporary braces should not be considered. In such instances, the bridge is to be rated **as if the temporary braces were not in place.**

A completed bridge not yet open to traffic should be coded as If it were open to traffic.

Use Table WB76-63A to determine the proper code to enter for all primary load carrying bridge members (i.e., superstructure, substructure). Use Table WB76-64 to determine the proper code to enter for all secondary bridge members (i.e., curbs, sidewalks, rails). Where other coding values are appropriate, the field description will specify what codes to enter.

deck_overall_cond Overall Deck Condition (Required)

WB76-63

FHWA Item 058

This item describes the overall condition rating of the deck. BMS will address local conditions (see Chapter 4). Rate and code the deck condition in accordance with the general condition ratings by using Table WB76-63 Condition Codes for Primary Bridge Members (Deck) based on a visual inspection.

Use a code of “9” for culverts and other bridges without a deck (i.e., filled arch bridge).

The condition of the wearing surface/protective system, joints, expansion devices, curbs, sidewalks, parapets, facias, bridge rail, and scuppers shall not be considered in the overall deck evaluation. However, their condition should be noted on the inspection form.

Decks integral with the superstructure will be rated as a deck only and may influence the superstructure rating (for example, rigid frame, slab, deck girder or T-beam, voided slab, box girder, etc.). The superstructure of an integral deck-type bridge will not influence the deck rating.

9	Not Applicable.
8	Very Good Condition. No problems noted.
7	Good Condition. Some minor problems.
6	Satisfactory Condition. Structural elements show some minor deterioration.
5	Fair Condition. All primary structural elements are sound but may have deficiencies such as minor section loss, deterioration, cracking, spalling, or scour.
4	Poor Condition. Advanced deficiencies such as section loss, deterioration, cracking, spalling, or scour.
3	Serious Condition. Loss of section, deterioration, spalling, or scour have seriously affected primary structural components. Local failures are possible. Fatigue cracks in steel or shear cracks in concrete maybe present.
2	Critical Condition. Advanced deterioration of primary structural elements. Fatigue cracks in steel or shear cracks in concrete maybe present or scour may have removed substructure support. Unless closely monitored, it may be necessary to close the bridge until corrective action is taken.
1	Imminent Failure Condition. Major deterioration or section loss present in critical structural components or obvious vertical or horizontal movement affecting structure stability. Bridge is closed to traffic but corrective action may put back in light service.
Ø	Failed Condition. Out of service. Beyond corrective action.

Condition Rating for Primary Bridge Members (Deck)

Table WB76-63

drain_cond **Drains Condition** (Optional)

WB76-64

WSBIS Item 7664 This is the condition rating of the drains in the bridge deck.

A rating of 5 should be used to indicate the drains are completely plugged with dirt and debris. Use Table WB76-64 Condition Rating for Secondary Bridge Members (Drains).

9	Not Applicable.
8	Very Good Condition. No problems noted.
7	Good Condition. Some minor problems.
6	Satisfactory Condition. Structural elements show some minor deterioration.
5	Fair Condition. All primary structural elements are sound but may have deficiencies such as minor section loss, deterioration, cracking, spalling, or scour.
4	Poor Condition. Advanced deficiencies such as section loss, deterioration, cracking, spalling, or scour.
Condition Rating for Secondary Bridge Members (Drains) <i>Table WB76-64</i>	

drain_status **Drains Status** (Optional)

WB76-65

WSBIS Item 7665 This code describes the present status of the drains on the bridge.

- 0 Drains do not exist
- 1 Drains exist as built
- 2 Drains have been permanently blocked
- 3 Drains have been replaced by another type
- 4 Drains have been disconnected
- 9 Drains status is unknown

deck_scaling **Deck Scaling Severity** (Optional)

WB76-66

WSBIS Item 7666 This code describes the severity of any deck scaling present.

The amount and type of deterioration present in the top surface of concrete bridge decks is to be rated. If the bridge does not have a concrete deck (for example, it has an asphalt overlay or a steel or timber deck), code N.

- N None
- L Light (scaling up to ¼" deep)
- M Moderate (scaling up to ½" deep)
- H Heavy (scaling or spalls up to 1" deep)
- S Severe (over 1" deep)

deck_scaling_pct **Deck Scaling Percent** (Optional)

WB76-67

WSBIS Item 7667 This value is the percentage of the total deck area where scaling and/or spalling are present. It includes any areas which have been patched.

In scaled areas of more than 1 percent, estimate the percentage at 5 percent increments. The amount and type of deterioration present in the top surface of concrete bridge decks is to be calculated. If the bridge does not have a concrete deck (for example, it has an asphalt overlay or a steel or timber deck), code 00.

deck_rutting_ Deck Rutting (Optional)

WB76-69

WSBIS Item 7669 The amount and type of deterioration present in the top surface of concrete bridge decks is to be rated using the following codes. If the bridge does not have a concrete deck (i.e., it has an asphalt overlay or a steel or timber deck), code Ø.

- 8 No wear
- 7 Exposed aggregate
- 5 Visible wheel track rutting
- 3 Wheel track rutting has exposed reinforcing steel
- 0 Not applicable

deck_exposed_steel_ Deck Exposed Steel (Optional)

WB76-70

WSBIS Item 7670 This code describes the degree to which the deck area shows exposed reinforcing steel.

The amount and type of deterioration present in the top surface of concrete bridge decks is to be rated. If the bridge does not have a concrete deck (for example, it has an asphalt overlay or a steel or timber deck), code Ø.

- 8 None
- 7 Some cracking in deck over reinforcing steel
- 5 0 to 5 percent of deck area shows exposed reinforcing steel
- 3 More than 5 percent of deck area shows exposed reinforcing steel
- 0 Not applicable

superstructure_cond Superstructure Overall (Required)

WB76-71

FHWA Item 059 This item describes the physical condition of all structural members comprising the superstructure. Rate and code the condition in accordance with the previously described general condition ratings. BMS will address local conditions (see Chapter 4). Code 9 for all culverts.

The condition of secondary members such as bracing, diaphragms, bearings, joints, paint system, etc., shall not be included in this rating, except in extreme situations, but should be noted on the inspection form.

On bridges where the deck is integral with the superstructure, the superstructure condition rating may be affected by the deck condition. The resultant superstructure condition rating may be lower than the deck condition rating where the girders have deteriorated or been damaged.

Use Table WB76-71 Condition Rating for Primary Bridge Members (Superstructure).

9	Not Applicable.
8	Very Good Condition. No problems noted.
7	Good Condition. Some minor problems.
6	Satisfactory Condition. Structural elements show some minor deterioration.
5	Fair Condition. All primary structural elements are sound but may have deficiencies such as minor section loss, deterioration, cracking, spalling, or scour.
4	Poor Condition. Advanced deficiencies such as section loss, deterioration, cracking, spalling, or scour.
3	Serious Condition. Loss of section, deterioration, spalling, or scour have seriously affected primary structural components. Local failures are possible. Fatigue cracks in steel or shear cracks in concrete may be present.
2	Critical Condition. Advanced deterioration of primary structural elements. Fatigue cracks in steel or shear cracks in concrete maybe present or scour may have removed substructure support. Unless closely monitored, it may be necessary to close the bridge until corrective action is taken.
1	Imminent Failure Condition. Major deterioration or section loss present in critical structural components or obvious vertical or horizontal movement affecting structure stability. Bridge is closed to traffic but corrective action may put back in light service.
∅	Failed Condition. Out of service. Beyond corrective action.

Condition Rating for Primary Bridge Members (Superstructure)
Table WB76-71

curb_cond
WB76-72

Curb Condition (*Optional*)

This is the condition rating of any curbs located on the bridge. Use Table WB76-72 Condition Rating for Secondary Bridge Members (Curbs).

9	Not Applicable.
8	Very Good Condition. No problems noted.
7	Good Condition. Some minor problems.
6	Satisfactory Condition. Structural elements show some minor deterioration.
5	Fair Condition. All primary structural elements are sound but may have deficiencies such as minor section loss, deterioration, cracking, spalling, or scour.
4	Poor Condition. Advanced deficiencies such as section loss, deterioration, cracking, spalling, or scour.

Condition Rating for Secondary Bridge Members (Curbs)
Table WB76-72

sdwk_cond
WB76-73

Sidewalk Condition (*Optional*)

This is the condition rating of any sidewalks which are an integral part of or are attached to the bridge. This rating considers the condition of any structural members (i.e., stringers) which may support the sidewalk.

To be considered a sidewalk, the member must be greater than or equal to three feet in width. Use Table WB76-73 Condition Rating for Secondary Bridge Members (Sidewalk).

9	Not Applicable.
8	Very Good Condition. No problems noted.
7	Good Condition. Some minor problems.
6	Satisfactory Condition. Structural elements show some minor deterioration.
5	Fair Condition. All primary structural elements are sound but may have deficiencies such as minor section loss, deterioration, cracking, spalling, or scour.
4	Poor Condition. Advanced deficiencies such as section loss, deterioration, cracking or spalling.
Condition Rating for Secondary Bridge Members (Sidewalk) Table WB76-73	

paint_cond
WB76-74

Paint Condition (*Optional*)

This field contains the condition rating of any paint applied to the bridge to protect the primary structural steel members.

If paint has been applied only on secondary members such as bridge rails or light posts, code 9 in this field.

- 9 Not applicable.
- 8 Bridge has recently been painted.
- 7 Paint is in good condition with only minor weathering.
- 6 Bridge needs to be painted within five years.
- 5 Bridge needs to be painted within three years.
- 4 Bridge needs to be painted within two years.

A paint code of '5' or '4' needs to have at least one paint inspection form completed as part of the inspection report in the bridge file. The bridge is also a candidate for paint testing.

utilities_qty
WB76-75

Number of Utilities (*Optional*)

This field indicates the number of franchise utilities attached to the bridge. Utilities include — but are not limited to — water pipes, sewer lines, telephone lines, power lines, and gas lines. Conduit for electricity used on the bridge is not considered a utility. A conduit cluster (i.e., a telephone cluster) is considered one utility.

This field is not used to evaluate the condition of utilities on the bridge, only the number of utilities present.

If more than nine utilities are attached to the bridge, code 9. If there are no utilities, code Ø. If the number of utilities is not known, leave this field blank.

substructure_cond Substructure Condition *(Required)*

WB76-76

FHWA Item 060

This item describes the overall physical condition of piers, abutments, piles, fenders, footings, or other components. Rate and code the condition in accordance with the previously described general condition ratings. Code 9 for all culverts. BMS will address local conditions (see Chapter 4).

The condition of secondary members such as bracing, diaphragms, bearings, joints, paint system, etc., shall not be included in this rating, except in extreme situations, but should be noted on the inspection form.

The Substructure Condition code should be consistent with Scour code WB76-80. A Scour code of 2 or below should result in a corresponding Substructure code of 2 or below.

The substructure condition rating shall be made independent of the deck and superstructure.

Integral-abutment wing walls to the first construction or expansion joint shall be included in the evaluation. For non-integral superstructure and substructure units, the substructure shall be considered as the portion below the bearings.

Use Table WB76-76 Condition Rating for Primary Bridge Members (Substructure).

9	Not Applicable.
8	Very Good Condition. No problems noted.
7	Good Condition. Some minor problems.
6	Satisfactory Condition. Structural elements show some minor deterioration.
5	Fair Condition. All primary structural elements are sound but may have deficiencies such as minor section loss, deterioration, cracking, spalling, or scour.
4	Poor Condition. Advanced deficiencies such as section loss, deterioration, cracking, spalling, or scour.
3	Serious Condition. Loss of section, deterioration, spalling, or scour have seriously affected primary structural components. Local failures are possible. Fatigue cracks in steel or shear cracks in concrete may be present.
2	Critical Condition. Advanced deterioration of primary structural elements. Fatigue cracks in steel or shear cracks in concrete maybe present or scour may have removed substructure support. Unless closely monitored, it may be necessary to close the bridge until corrective action is taken.
1	Imminent Failure Condition. Major deterioration or section loss present in critical structural components or obvious vertical or horizontal movement affecting structure stability. Bridge is closed to traffic but corrective action may put back in light service.
Ø	Failed Condition. Out of service. Beyond corrective action.

Condition Rating for Primary Bridge Members (Substructure)*Table WB76-76*

channel_prot
WB76-77
FHWA Item 061

Channel Protection *(Required)*

This item describes the physical conditions associated with the flow of water beneath the bridge such as stream stability and the condition of the channel, riprap, slope protection, or stream control devices including spur dikes. The inspector should be particularly concerned with visible signs of excessive water velocity which may affect undermining of slope protection, erosion of banks, and realignment of the stream which may result in immediate or potential problems. Accumulation of drift and debris on the superstructure and substructure should be noted on the inspection form but not included in the condition rating.

If more than one condition is present, enter the lowest of the codes that apply. Use Table WB76-77.

Code	Devices Description
9	Bridge is not over a waterway.
8	Protected, well vegetated banks. No river control devices required or they are in stable condition.
7	Bank protection needs minor repair. River control devices/slope protection show minor damage. Banks and/or channel show minor accumulation of drift.
6	Bank beginning to slump. River control devices/slope protection show wide spread damage. Minor movement of streambed. Debris restricts waterway.
5	Eroded bank protection. River control devices/slope protection have major damage. Trees and brush restrict waterway.
4	Banks severely undermined. River control devices/slope protection have severe damage. Large deposits of debris in waterway.
3	Failed bank protection. River control devices are destroyed. Waterway has changed course so it now threatens the bridge and/or approach roadway.
2	Waterway has changed course to extent that bridge is now near collapse.
1	Bridge closed – may be able to be repaired.
0	Bridge closed – beyond repair.

Rating for Channel and Channel Protection

Table WB76-77

culvert_cond
WB76-78
FHWA Item 062

Culvert Condition *(Required)*

This is the general overall condition rating of any bridge which is a culvert.

A culvert is defined in the FHWA *Culvert Inspection Manual* as a drainage opening beneath an embankment, usually a pipe, which has been designed to allow the even flow of water beneath a roadway and designed to take advantage of submergence. This is a bridge with WB75-33 coded 19.

If the bridge is not a culvert, code 9 in this field.

Any culvert with a clear opening of more than 20 feet when measured along the center of the roadway, must be inventoried. In addition, any multiple pipes with a total span of more than 20 feet and a clear distance between openings of less than half of the smaller contiguous opening must also be inventoried. Culverts or multiple pipes which measure less than 20 feet may be inventoried at the agency's discretion.

When rating the general condition of the culvert, evaluate the alignment, degree of settlement, and structural integrity. Wingwalls which have been poured integral to the culvert's first construction or expansion joint should be included in this evaluation. Refer to the FHWA *Culvert Inspection Manual* for a detailed discussion regarding the inspection and rating of culverts. See Figure WB76-78 and Table WB76-78A Rating for Concrete Culverts or Table WB76-78B Rating for Metal Culverts.

When culvert condition is coded (not including 9), code the following fields a 9.			
Type	Field Name	WSBIS	FHWA Item
Reqd.	Overall Deck Condition	WB76-63	058
Reqd.	Superstructure Overall	WB76-71	059
Reqd.	Substructure Condition	WB76-76	060

Table WB76-78

BOX CULVERT

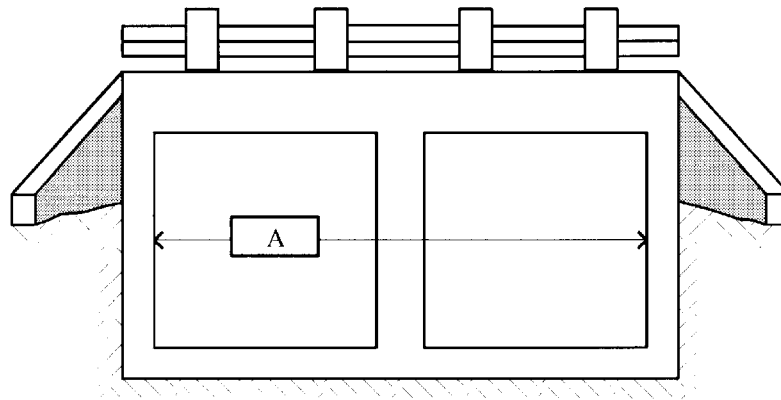

If $A > 20'$
then culvert's condition must be rated.

MULTIPLE PIPES

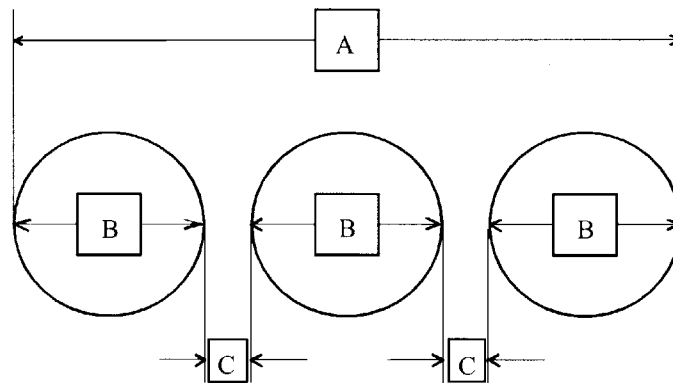

If $A > 20'$ and $B/2 > C$
then culvert's condition must be rated.

Figure WB76-78

Code	Description
9	Bridge is not a culvert.
8	No noticeable or noteworthy defects.
7	Cracking, light scaling and spalling which does not expose reinforcing steel. Minor damage from drift. Insignificant scouring near wingwalls or pipes.
6	Minor deterioration, chloride contamination cracking, leaching, or spalling. Minor scouring near wingwalls or pipes.
5	Moderate to major deterioration, cracking, leaching or spalling. Minor settlement or misalignment. Moderate scouring or erosion at wingwalls or pipes.
4	Major deterioration (large spalls, heavy scaling, wide cracks, open construction joints, etc). Considerable settlement or misalignment. Considerable scouring or erosion at wingwalls or pipes.
3	Extensive deterioration. Severe movement, differential settlement of segments, loss of fill. Holes in walls or slab. Wingwalls nearly severed. Severe scouring or erosion at wingwalls or pipes.
2	Collapsed wingwalls, severe settlement of roadway due to loss of fill. Section failure of culvert. Complete undermining at wingwalls or pipes.
1	Bridge closed – culvert may be able to be repaired.
∅	Bridge closed – culvert beyond repair.

Rating for Concrete Culverts
Table WB76-78A

Code	Description
9	Bridge is not a culvert
8	No noticeable or noteworthy defects. Bolts are in good condition, in place, and tight.
7	Smooth, symmetrical curvature with superficial corrosion and no pitting. Bolts may have superficial corrosion, are in place and tight.
6	Smooth curvature, non-symmetrical shape, and significant corrosion or moderate pitting. Bolts may have significant corrosion and 10 percent of the bolts in a panel seam maybe missing or loose.
5	Significant distortion and deflection in one section. Significant corrosion or deep pitting. Bolts may have significant corrosion and 20 percent of the bolts in a panel seam maybe missing or loose.
4	Significant distortion and deflection throughout. Extensive corrosion or deep pitting. Bolts may have extensive corrosion and 30 percent of the bolts in a panel seam maybe missing or loose.
3	Extreme distortion and deflection in one section. Extensive corrosion or deep pitting with scattered perforations. Bolts may have extensive corrosion and 40 percent of the bolts in a panel seam maybe missing or loose.
2	Extreme distortion and deflection in one section. Extensive perforations due to corrosion. Bolts may have extensive corrosion and 50 percent of the bolts in a panel seam maybe missing or loose.
1	Bridge closed – culvert may be able to be repaired.
∅	Bridge closed – culvert beyond repair.

Rating for Metal Culverts
Table WB76-78B

Code	Description
9	Bridge is not a culvert
8	No noticeable or noteworthy defects
7	Insignificant deterioration, decay or scour. No structural loss.
6	Minor deterioration, decay or scour. All primary structural elements are sound.
5	Moderate deterioration, decay or scour. All primary structural elements are sound but have some section loss.
4	Major deterioration, decay or scour. Advanced section loss or scour that affects the load capacity of the structure.
3	Extensive deterioration, decay or scour. Advanced section loss or scour that significantly affects the load capacity of the structure.
2	Severe deterioration, decay or scour. Critical structural members have obvious vertical or horizontal movement affecting structural stability.
1	Bridge closed – culvert may be able to be repaired.
∅	Bridge closed – culvert beyond repair.

Rating for Timber Culverts
Table WB76-78C

pier_abutment_prot Pier / Abutment Protection (Required)

WB76-79

FHWA Item 111

This is only required if the bridge crosses a navigable channel (Item 386 = 1). This item contains a code which indicates the presence and adequacy of pier and/or abutment navigation protection features (i.e., fenders and dolphins).

WB76-79 evaluates the adequacy of the pier protection features and is **not** an evaluation of their general condition. WB76-83 is to be used for rating their general condition. However, the adequacy evaluation of these features should correspond to condition ratings entered in WB76-83 in the manner noted.

If WB73-86 has not been coded 1, code N in this field.

- 1 No pier protection is required.
- 2 Pier protection is in place and functioning properly (it has a condition rating of 6, 7, or 8).
- 3 Pier protection is in place but is in a deteriorating condition (it has a condition rating of 4 or 5),
- 4 Pier protection is in place but a reevaluation of its design is needed.
- 5 No pier protection is present but a reevaluation of the need for it should be made.
- N Not applicable.

scour_

WB76-80

FHWA Item 113

Scour (Required)

This rating is used to identify the current status of a bridge regarding its vulnerability to scour. Details on conducting a scour analysis are included in Chapter 5. Whenever a rating factor of 4 or below is determined for this item, the rating factor for WB76-76, Substructure may need to be revised to reflect the severity of actual scour and resultant damage to the bridge. A scour critical bridge is one with abutment or pier foundations which are rated as unstable due to (1) observed scour at the bridge site or (2) a scour potential as determined from a scour evaluation study.

When a bridge inspector identifies an actual or potential scour problem, the bridge must be further evaluated to determine whether or not it should be considered scour critical. This evaluation process includes field observations by an individual (or individuals) with a knowledge of foundation, hydraulic, and geotechnical engineering and may require that calculations of anticipated scour depths be made.

See Figure WB76-80 and Table WB76-80 Rating for Scour.

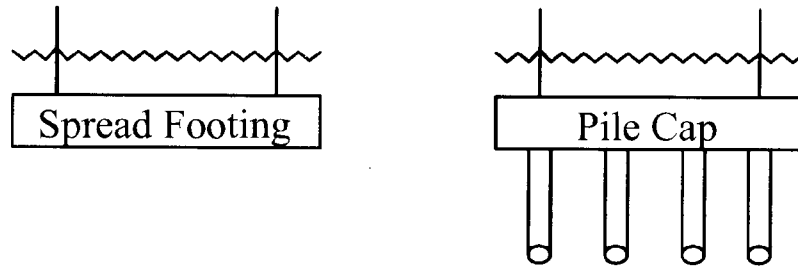

Example A: If calculated scour depth is above top of footing, code 8.
(No action is required.)

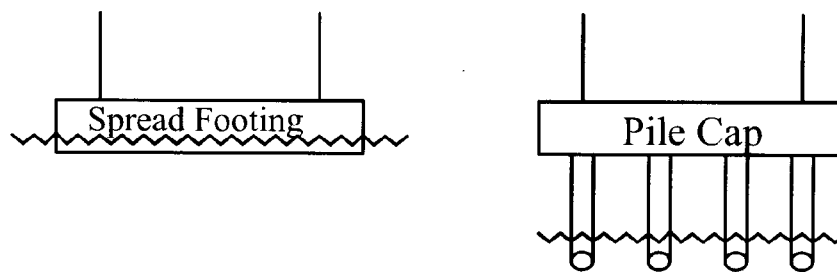

Example B: If calculated scour depth is within limits of footing,
code 5 or 3 and conduct foundation structural analysis.

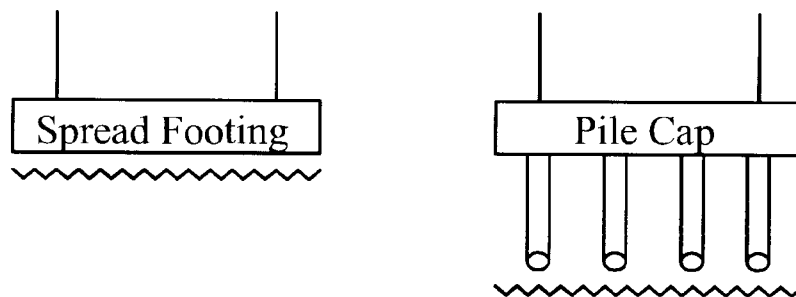

Example C: If calculated scour depth is below pile tips or spread footing base, code 3 and provide for monitoring and scour countermeasures as needed.

~~~~~ = Calculated Scour Depth

Figure WB76-80



| Code | Description                                                                                                                                                                                                                                                                                                                                                                                                   |
|------|---------------------------------------------------------------------------------------------------------------------------------------------------------------------------------------------------------------------------------------------------------------------------------------------------------------------------------------------------------------------------------------------------------------|
| N    | Bridge is not over a waterway.                                                                                                                                                                                                                                                                                                                                                                                |
| U    | Bridge with "unknown" foundation that has not been evaluated for scour. Until risk can be determined, a plan of action should be developed and implemented to reduce the risk to users from a bridge failure during and immediately after a flood event (see HEC 23).                                                                                                                                         |
| T    | Bridge over "tidal" waters that has not been evaluated for scour, but considered low risk. Bridge will be monitored with regular inspection cycle and with appropriate underwater inspections until an evaluation is performed ("Unknown" foundations in "tidal" waters should be coded U.)                                                                                                                   |
| 9    | Bridge foundations (including piles) well above flood water elevations.                                                                                                                                                                                                                                                                                                                                       |
| 8    | Bridge foundations determined to be stable for the assessed or calculated scour condition. Scour is determined to be above top of footing (Example A) by assessment (i.e., bridge foundations are on rock formations that have been determined to resist scour within the service life of the bridge), by calculation or by installation of properly designed countermeasures (see HEC 23).                   |
| 7    | Countermeasures have been installed to mitigate an existing problem with scour and to reduce the risk of bridge failure during a flood event. Instructions contained in a plan of action have been implemented to reduce the risk to users from a bridge failure during or immediately after a flood event.                                                                                                   |
| 6    | Scour calculation/evaluation has not been made.                                                                                                                                                                                                                                                                                                                                                               |
| 5    | Bridge foundations determined to be stable for assessed or calculated scour condition. Scour is determined to be within the limits of footing or piles (Example B) by assessment (i.e., bridge foundations are on rock formations that have been determined to resist scour within the service life of the bridge), by calculations or by installation of properly designed countermeasures (see HEC 23).     |
| 4    | Bridge foundations determined to be stable for assessed or calculated scour conditions; field review indicates action is required to protect exposed foundations (see HEC 23).                                                                                                                                                                                                                                |
| 3    | Bridge is scour critical; bridge foundations determined to be unstable for assessed or calculated scour conditions: <ul style="list-style-type: none"> <li>• Scour within limits of footing or piles (see Figure WB76-80B).</li> <li>• Scour below spread-footing base or pile tips (see Figure WB76-80C).</li> </ul>                                                                                         |
| 2    | Bridge is scour critical; field review indicates that extensive scour has occurred at bridge foundations, which are determined to be unstable by: <ul style="list-style-type: none"> <li>• A comparison of calculated scour and observed scour during the bridge inspection, or</li> <li>• An engineering evaluation of the observed scour condition reported by the bridge inspector in WB76-76.</li> </ul>  |
| 1    | Bridge is scour critical; field review indicates that failure of piers/abutments is imminent. Bridge is closed to traffic. Failure is imminent based on: <ul style="list-style-type: none"> <li>• A comparison of calculated and observed scour during the bridge inspection, or</li> <li>• An engineering evaluation of the observed scour condition reported by the bridge inspector in WB76-76.</li> </ul> |
| ∅    | Bridge is scour critical. Bridge has failed and is closed to traffic.                                                                                                                                                                                                                                                                                                                                         |

**Rating for Scour**  
**Table WB76-80**

**aprch\_cond**  
WB76-81

**Approach Roadway Condition (Optional)**

This is the general physical condition rating of the approach roadway. This evaluation takes into consideration visible signs of wear, cracking, spalling, etc., but does not consider the alignment or width of this roadway.

- 9 Not applicable.
- 8 Smooth approach onto the bridge structure.
- 6 Less than 1" of settlement of the approach roadway causing minor bouncing and load impact onto the bridge. Monitor the settlement.
- 3 More than 1" of settlement of the approach roadway causing bouncing and load impact onto the bridge. Needs to be ACP feather repaired to provide a smooth transition onto the bridge.

**Note:** Code 6 for well maintained gravel roads. Code 3 for gravel roads in rough condition.

**retaining\_wall\_cond**  
WB76-82

**Retaining Walls Condition (Optional)**

This field contains the general condition rating of any retaining walls associated with the bridge. This evaluation should take into consideration whether movement, cracking, or settling has occurred.

Wingwalls and curtain walls should not be considered under this code as they are considered part of the abutment. Use Table WB76-82 Condition Rating for Retaining Walls.

|   |                                                                                                                                                                                                                                                                                                  |
|---|--------------------------------------------------------------------------------------------------------------------------------------------------------------------------------------------------------------------------------------------------------------------------------------------------|
| 9 | Not Applicable.                                                                                                                                                                                                                                                                                  |
| 8 | Very Good Condition. No problems noted.                                                                                                                                                                                                                                                          |
| 7 | Good Condition. Some minor problems.                                                                                                                                                                                                                                                             |
| 6 | Satisfactory Condition. Structural elements show some minor deterioration.                                                                                                                                                                                                                       |
| 5 | Fair Condition. All primary structural elements are sound but may have deficiencies such as minor section loss, deterioration, cracking, spalling, or scour.                                                                                                                                     |
| 4 | Poor Condition. Advanced deficiencies such as section loss, deterioration, cracking, spalling, or scour.                                                                                                                                                                                         |
| 3 | Serious Condition. Loss of section, deterioration, spalling, or scour have seriously affected primary structural components. Local failures are possible. Fatigue cracks in steel or shear cracks in concrete may be present.                                                                    |
| 2 | Critical Condition. Advanced deterioration of primary structural elements. Fatigue cracks in steel or shear cracks in concrete maybe present or scour may have removed substructure support. Unless closely monitored, it may be necessary to close the bridge until corrective action is taken. |
| 1 | Imminent Failure Condition. Major deterioration or section loss present in critical structural components or obvious vertical or horizontal movement affecting structure stability. Bridge is closed to traffic but corrective action may put back in light service.                             |
| ∅ | Failed Condition. Out of service. Beyond corrective action.                                                                                                                                                                                                                                      |

**Condition Rating for Retaining Walls**  
**Table WB76-82**

**pier\_prot**  
WB76-83**Pier Protection Condition** *(Optional)*

This rating describes the general condition rating of any pier and/or abutment protection features (i.e., fenders and dolphins) which have been put in place to protect the bridge against collisions from vessels or objects in tow.

This field is used for rating the general condition of the bridge's pier protection features and does not evaluate the adequacy of those features.

If no pier protection exists, code 9. Use Table WB76-83 Condition Rating for Secondary Bridge Members (Pier Protection).

|   |                                                                                                                                                              |
|---|--------------------------------------------------------------------------------------------------------------------------------------------------------------|
| 9 | Not Applicable.                                                                                                                                              |
| 8 | Very Good Condition. No problems noted.                                                                                                                      |
| 7 | Good Condition. Some minor problems.                                                                                                                         |
| 6 | Satisfactory Condition. Structural elements show some minor deterioration.                                                                                   |
| 5 | Fair Condition. All primary structural elements are sound but may have deficiencies such as minor section loss, deterioration, cracking, spalling, or scour. |
| 4 | Poor Condition. Advanced deficiencies such as section loss, deterioration, cracking, spalling, or scour.                                                     |

**Condition Rating for Secondary Bridge Members (Pier Protection)**  
*Table WB76-83*

**bridge\_rail\_adqcy** **Traffic Safety, Bridge Rails** *(Required)*  
WB76-84

FHWA Item 036A

This code indicates whether or not the bridge railings meet current design standards as established by the AASHTO Standards Specifications for Highway Bridges. To meet current design standards, bridge railings must be capable of smoothly redirecting an impacting vehicle and meet current crash test standards. Factors which may affect this capability are bridge rail height, strength, type of material, and geometric design. See Figure WB76-84.

- 0 Does not meet currently acceptable standards or a feature is required but not provided.
- 1 Meets currently acceptable standards.
- N Not applicable, or not required, such as a non-vehicular bridge.

**rail\_trans\_adqcy** Traffic Safety, Transitions (Required)

WB76-85

FHWA Item 036B This rating indicates whether or not the transition between the bridge rail and the approach guardrail meets current design standards. See Figure WB76-87. To meet design standards, the transition must provide for the following:

- A gradual stiffening of the approach guardrail in a manner that will not cause sagging or pocketing due to vehicle impact.
- A firm attachment between the approach guardrail and the bridge by a WSDOT Type F anchor, a WSDOT Type 3 beam guardrail anchor, or extension of the concrete barrier.
- A gradual tapering out of the curb ends.

0 Does not meet currently acceptable standards or a feature is required but not provided.

1 Meets currently acceptable standards.

N Not applicable, or not required, such as a non-vehicular bridge.

**aprch\_rail\_adqcy** Traffic Safety, Guardrails (Required)

WB76-86

FHWA Item 036C This rating indicates whether or not the approach guardrail meets current design standards. To meet standards, the approach guardrail should be of adequate length, height, and structural quality to shield motorists from bridge ends or from other hazards at the bridge site. Design standards are given in the *AASHTO Roadside Design Guide*. See Figure WB76-87.

Ø Does not meet currently acceptable standards or a feature is required but not provided.

1 Meets currently acceptable standards.

N Not applicable, or not required, such as a non-vehicular bridge.

**rail\_end\_adqcy** Traffic Safety, Terminals (Required)

WB76-87

FHWA Item 036D This code indicates whether or not the terminals (guardrail ends) meet current design standards. To meet standards, the terminals should either be flared, buried, shielded, or able to break away. Design standards for terminals are given in the *AASHTO Roadside Design Guide*. See Figure WB76-87.

Ø Does not meet currently acceptable standards or a feature is required but not provided.

1 Meets currently acceptable standards.

N Not applicable, or not required, such as a non-vehicular bridge.

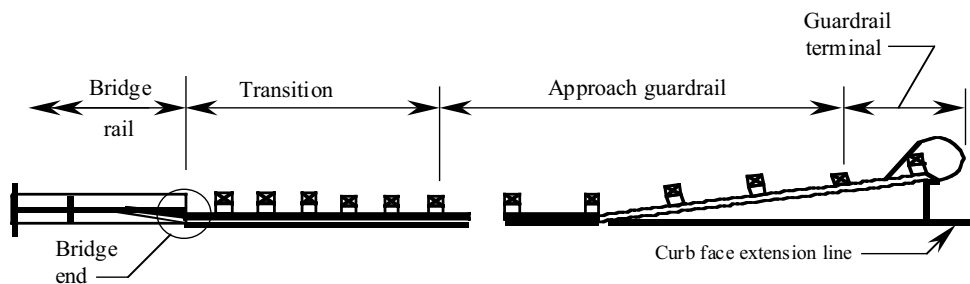
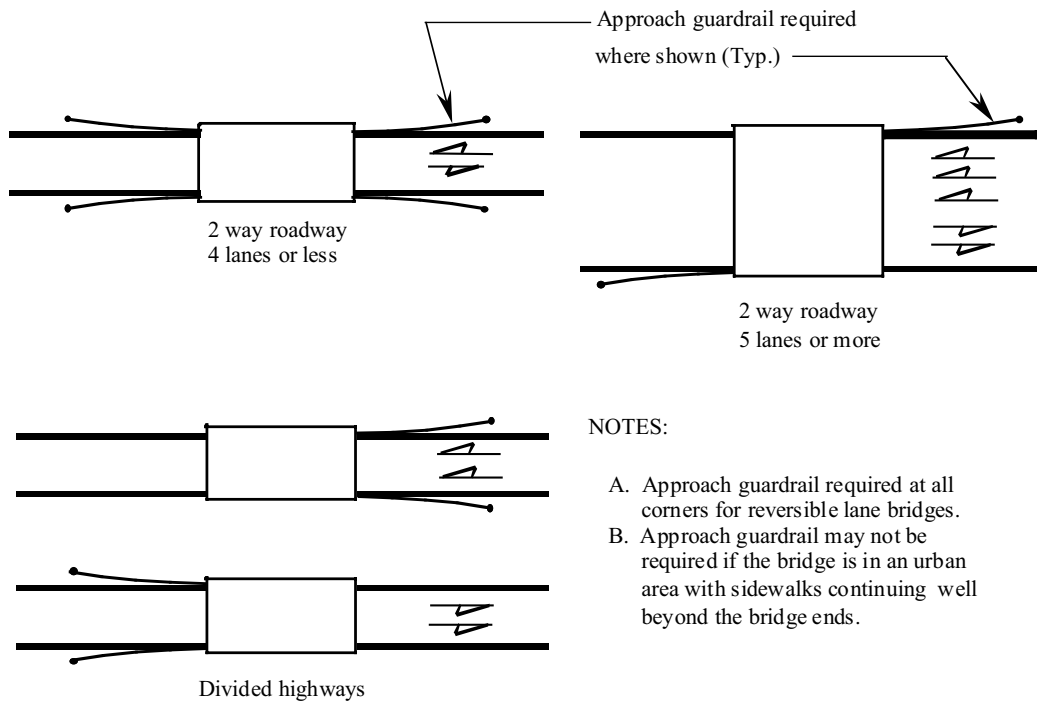

Note: See Standard Plans Section C for current standards.

**Approach Rail Requirements**  
**Figures WB76-84 through WB76-87**

rating\_calc\_  
 WB76-88

**Rating (Optional)**

This code indicates whether or not the load ratings WB75-52 and WB75-55 need to be reviewed or calculated.

- Y Yes, operating and/or inventory ratings need to be reviewed, or original ratings need to be established.
- N No, operating and/or inventory ratings need not be reviewed.

|                                                      |                                                                                                                                                                                                                                                                                                                                                                    |
|------------------------------------------------------|--------------------------------------------------------------------------------------------------------------------------------------------------------------------------------------------------------------------------------------------------------------------------------------------------------------------------------------------------------------------|
| <b>repair_status_</b><br>WB76-89                     | <p><b>Repair Status</b> <i>(Optional)</i><br/>The inspector should code this field Y If there are recommended repairs.</p> <p>Y Recommended repair add to Bridge Repair List items.<br/>N No Recommended Repairs.</p>                                                                                                                                              |
| <b>inspn_photo_</b><br>WB76-91                       | <p><b>Photographs</b> <i>(Optional)</i><br/>This code identifies the types of photographs to be taken during this inspection.</p> <p>D Take deck photographs.<br/>E Take elevation photographs.<br/>P Take both deck and elevation photographs.</p> <p>Leave this field blank If photographs are not required. Use an asterisk to remove a code.</p>               |
| <b>inspn_season_</b><br>WB76-92                      | <p><b>Season</b> <i>(Optional)</i><br/>This field specifies the time of year in which this bridge should be inspected, either summer, winter, or another seasonal inspection.</p> <p>L During low water<br/>S Summer<br/>W Winter<br/>B Outside bird nesting season<br/>F Outside fish windows<br/>K Call for utility</p> <p>Use an asterisk to remove a code.</p> |
| <b>inspn_soundings_</b><br>WB76-93                   | <p><b>Soundings</b> <i>(Optional)</i><br/>This code indicates whether or not soundings of the streambed are required.</p> <p>Y Soundings should be taken.<br/>N Soundings need not be taken.</p>                                                                                                                                                                   |
| <b>measure_clrnc_</b><br>WB76-94                     | <p><b>Clearances</b> <i>(Optional)</i><br/>This field identifies which clearances need to be checked on a bridge.</p> <p>C Measure both horizontal and vertical clearances.<br/>H Measure horizontal clearances.<br/>V Measure vertical clearances.</p> <p>Leave this field blank If clearances are not required. Use an asterisk to remove a code.</p>            |
| <b>monitor_structure_</b><br>WB76-95                 | <p><b>Monitor Structure</b> <i>(Optional)</i><br/>This field prompts the inspector to review comments from the previous inspection to identify what to monitor during an inspection.</p> <p>Y Yes<br/>N No</p>                                                                                                                                                     |
| <b>inspn_rpt_hours</b><br>WB76-42<br>WSBIS Item 7696 | <p><b>Inspection Report Hours</b> <i>(Optional)</i><br/>This is the total number of hours (to the tenth of an hour) that the inspection team spent on writing the inspection report for the most recent inspection.</p>                                                                                                                                            |

**WB77****inspn\_fracture\_type Fracture Critical/UBIT Inspection, Type (Required)**

WB77-32

FHWA Item 92A Code If a fracture critical inspection is required or whether an Under Bridge Inspection Truck (UBIT) is needed.

- U A Fracture Critical inspection is required (using a UBIT).
- Y A Fracture Critical inspection is required (without using a UBIT).
- I Requires UBIT for inspection, not Fracture Critical.
- N No Fracture Critical inspection is required.

**fracture\_inspn\_freq Fracture Critical/UBIT Inspection, Frequency (Required)**

WB77-33

FHWA Item 92A A two-digit code representing the number of months between consecutive fracture critical or UBIT inspections.

**fracture\_inspn\_date Fracture Critical/UBIT Inspection Last Inspection Date (Fatal)**

WB77-35

FHWA Item 93A The date on which the most recent fracture critical inspection was completed. Code this field in the mmddyyyy format.

**fracture\_inspn\_hours Fracture Critical/UBIT Inspection Hours (Required)**

WB77-43

The total number of inspection hours (to the nearest tenth of an hour) that the inspection team spent on the bridge during the most recent fracture critical/UBIT inspection. Use leading zeros.

**fracture\_inspn\_initials Fracture Critical/UBIT Inspection Inspector (Optional)**

WB77-47

The initials of the lead inspector of the inspection team who performed the most recent fracture critical/UBIT inspection.

**fracture\_cert\_no Fracture Critical/UBIT Inspector Identification No (Fatal)**

WB77-50

The certification number of the lead inspector at the bridge site during the most recent fracture critical /UBIT inspection.

**fracture\_co\_inspn\_initials Fracture Critical/UBIT Co-Inspector (Optional)**

WB77-55

The initials of the individual who assisted the lead inspector in performing the most recent fracture critical /UBIT inspection.

**inspn\_underwater\_type Underwater Inspection, Type (Required)**

WB77-58

FHWA Item 92B The type of underwater inspection that is required for the bridge.

- D Underwater inspection with a diver (and fathometer, If necessary) is required.
- N No underwater inspection is required.
- O Other type of underwater inspection is required (submarine, ROV, etc.).
- W Underwater inspection w/o diver (wading) is required.

**underwater\_inspn\_freq Underwater Inspection, Frequency (Required)**

WB77-59

FHWA Item 92B A two-digit code representing the number of months between consecutive underwater inspections.

**underwater\_inspn\_date Underwater Inspection Last Inspection Date (Fatal)**

WB77-61

FHWA Item 93B The date on which the most recent underwater inspection was completed. Code this field in the mmddyyyy format.

**underwater\_inspn\_hours Underwater Inspection Hours (Optional)**

WB77-69

The total number of inspection hours (to the nearest tenth of an hour) that the inspection team spent at the bridge during the most recent underwater inspection. Use leading zeros.

**underwater\_inspr\_initials Underwater Inspection Inspector (Required)**

WB77-73

The initials of the lead inspector of the inspection team who performed the most recent underwater inspection.

**underwater\_cert\_no Underwater Inspection Inspector Identification No (Fatal)**

WB77-76

The certification number of the lead inspector at the bridge site during the most recent underwater inspection.

**underwater\_co\_inspr\_initials Underwater Inspection Co-Inspector (Optional)**

WB77-81

The initials of the individual who assisted the lead inspector in performing the most recent underwater inspection.

**inspn\_special\_type Other Special Inspections, Type (Required)**

WB77-84

FHWA Item 92C This field identifies the type of special inspection that is required for the bridge.

- 1 Movable bridge.
- 2 Floating bridge.
- 3 Suspension bridge.
- 4 Redundant pin/hanger bridge.
- 5 Segmental.
- 6 Ferry terminal.
- 7 High strength steel bridge.
- 8 Bridges with temporary supports (require intermediate inspections).
- 9 Cable stayed.
- Ø Other special features.
- N No special inspection is required.

**special\_inspn\_freq Special Inspection Frequency (Required)**

WB77-85

FHWA Item 92C A two-digit code representing the number of months between consecutive special inspections.

**special\_inspn\_date Special Inspection Date (Fatal)**

WB77-87

FHWA Item 93C The date on which the most recent special inspection was completed. Code this field in the mmddyyyy format.

**special\_inspn\_hours Special Inspection Hours (Optional)**

WB77-95

The total number of inspection hours (to the nearest tenth of an hour) that the inspection team spent at the bridge during the most recent special inspection.



**special\_inspr\_initials** **Other Special Inspector's Initials** (*Required*)

WB77-99 The initials of the lead inspector of the inspection team who performed the most recent special inspection.

**special\_cert\_no** **Other Special Inspector Certification No.** (*Fatal*)

WB77-102 The certification number of the lead inspector at the bridge site during the most recent special inspection.

**special\_co\_inspr\_initials** **Other Special Co-Inspector's Initials** (*Optional*)

WB77-107 The initials of the individual who assisted the lead inspector in performing the most recent special inspection.



**WB78****water\_type**      **Water Type (Required)**

WB78-32

**WSBIS Item 7832** This field describes the type of water the bridge crosses over.

- B      Brackish (a mixture of fresh and salt water).
- F      Fresh water.
- S      Salt water.
- T      Tidal.

Leave blank if not over water.

**flood\_plain\_intrusion\_**      **Flood Plain Intrusion (Required)**

WB78-33

**WSBIS Item 7833** This code indicates whether or not the structure's approach roadway or abutment intrude into the flood plain of the waterway (i.e., whether or not previous or possible flooding could cause or has caused water to rise so it touches the structure's approach roadway embankment or abutment).

- A      No intrusion into the flood plain.
- B      Bridge or approaches intrude into the waterway causing minor backwater.
- C      Overtopping of approach roadway has occurred.
- D      A portion of the superstructure has been under water.
- U      Flood plain intrusion is unknown.

Leave blank if not over water.

**flood\_control\_**      **Flood Control (Required)**

WB78-34

**WSBIS Item 7834** This field indicates If there is any existing type of flood control on the waterway the bridge crosses. To be considered, this flood control must be in place either upstream or downstream from the bridge and must be near enough to have an effect on the bridge. Flood control may be provided by dams, dikes, fill, or other means.

- B      Both upstream and downstream.
- U      Upstream.
- D      Downstream.
- N      No flood control.

Leave blank if not over water.

**scour\_history\_**      **Scour History (Required)**

WB78-35

**WSBIS Item 7835** This code describes scour conditions at the bridge site.

- C      Current scour problems.
- H      History of scour problems but scour conditions are now stable.
- N      No history of scour.
- U      Scour history is unknown.

Leave blank if not over water.

**streambed\_material\_type Streambed Material Type (Required)**

WB78-36

**WSBIS Item 7836** This code describes the composition of the streambed at the bridge site. Enter one of the following codes to indicate the predominant type of material that is evident.

- 1 Bedrock
- 2 Sediment
- 3 Gravel
- 4 Sand
- 5 Cobbles
- 6 Lined Canal
- 7 Vegetation
- 8 Alluvial Fan
- 9 Unknown

Leave blank if not over water.

**substructure\_stability\_ Substructure Stability (Required)**

WB78-37

**WSBIS Item 7837** This code describes the type of material upon which the bridge's substructure rests. This code is used to determine the degree of stability that can be expected in the bridge substructure.

Code the lower number value If different sections of a continuous span bridge are supported by different materials.

- 1 Spread footing, simple spans.
- 2 Spread footing, continuous spans.
- 3 Pile foundation, simple spans.
- 4 Pile foundation, continuous spans.
- 5 Bedrock, simple spans.
- 6 Bedrock, continuous spans.
- 7 Unknown, simple spans.
- 8 Unknown, continuous spans

Leave blank if not over water.

**waterway\_obstruction Waterway Obstruction (Required)**

WB78-38

**WSBIS Item 7838** This code indicates any conditions in the waterway which affect the flow of water beneath the bridge.

- A Debris accumulates at the bridge.
- B Ice accumulates at the bridge.
- C The waterway is overgrown with vegetation.
- D A and C above.
- E A and B above.
- F B and C above.
- G A, B, and C above.
- N No obstruction to the flow of water beneath the bridge.

Leave blank if not over water.

**streambed\_stability\_ Streambed Stability (Required)**

WB78-39

**WSBIS Item 7839** This code describes any existing stream conditions which may influence scour at the bridge site.

- A Sharp bends.
- B Significant lateral shifts.
- C Steep slopes.
- D High water velocity.
- E Degradation.
- F Aggregation.
- G No conditions influencing scour exist.
- H Streambed conditions are unknown.

Leave blank if not over water.

**streambed\_anabranh\_ Streambed Anabranh (Required)**

WB78-40

**WSBIS Item 7840** This field indicates whether or not confluences or shifting anabranches are present in the waterway. A confluence is a flowing together of two or more streams. An anabranh is a river branch that re-enters the main stream, creating an island in the waterway.

Code only those conditions which exist near the bridge site.

- A Anabranches are present.
- B Both anabranches and confluences are present.
- C Confluences are present.
- N Neither anabranches nor confluences are present.
- U Waterway configuration is unknown.

Leave blank if not over water.

**piers\_in\_waterway Piers in Water (Required)**

WB78-41

**WSBIS Item 7841** This field contains the number of the structure's piers in the water at normal yearly high water.

If the bridge is inspected at low water, look for evidence that the piers or pile bents have been in the water.

- 0 No piers in the water.
- 1-9 Number of piers in the water.
- M More than nine piers in the water.

Leave blank if not over water.

**prpsed\_serv\_on\_code Proposed Improvement Service On (Required)**

WB78-42 This field identifies the type of service to be carried on the proposed bridge.

- 1 Highway.
- 2 Railroad.
- 3 Pedestrian exclusively.
- 4 Highway and railroad.
- 5 Highway and pedestrian.
- 6 Overpass bridge at an interchange or second level of a multilevel interchange.
- 7 Third level of a multilevel interchange.
- 8 Fourth level of a multilevel interchange.
- 9 Building or plaza.
- 0 Other or Not Applicable.

The code Ø means “Other” only If there are proposed improvements. If there are no proposed improvements to the bridge, the code Ø means “not applicable.”

**prpsed\_serv\_under\_code Proposed Improvement Service Under (Required)**

WB78-43

This field identifies the type of service under the proposed bridge.

- 1 Highway, with or without pedestrian traffic.
- 2 Railroad.
- 3 Pedestrians exclusively.
- 4 Highway and railroad.
- 5 Waterway.
- 6 Highway and waterway.
- 7 Railroad and waterway.
- 8 Highway, waterway, and railroad.
- 9 Relief.
- 0 Other or Not Applicable

The code 0 means “Other” only If there are proposed improvements. If there are no proposed improvements to the bridge, the code 0 means “not applicable.”

**prpsed\_work\_type Proposed Improvement Work Type (Required)**

WB78-44

FHWA Item 075A This field identifies the type of work to be accomplished on the proposed improvement. The proposed work should improve the bridge to the degree that it can provide the type of service needed. This field must be coded for bridges eligible for the Highway Bridge Replacement and Rehabilitation Program. To be eligible, a bridge must carry highway traffic, be deficient and have a sufficiency rating of 80.0 or less.

- 31 Replacement of bridge because of substandard load-carrying capacity or substandard bridge roadway geometry.
- 32 Replacement of bridge because of relocation of road.
- 33 Widening of existing bridge without deck rehabilitation or replacement OR lengthening of a culvert.
- 34 Widening of existing bridge with deck rehabilitation or replacement.
- 35 Rehabilitation of bridge because of general structural deterioration or inadequate strength.
- 36 Rehabilitation of bridge deck with only incidental widening.
- 37 Replacement of bridge deck with only incidental widening.
- 38 Other structural work, includes hydraulic replacements.
- 00 If there are no proposed improvements to the bridge, the code 00 means “not applicable.”

If there are no proposed improvements to the bridge, the code 00 means “not applicable.”

**prpsed\_work\_meth Proposed Improvement Work Method (Required)**

WB78-46

FHWA Item 075B This field indicates who will perform the work (as indicated in WB78-44) on the proposed improvement.

- 1 Work to be done by contract.
- 2 Work to be done by the agency which owns the bridge.

**prpsed\_length Proposed Improvement Length (Required)**

WB78-47

FHWA Item 76 This field contains the length of the proposed improvement. The measurement is to the nearest foot. This should be a measurement of the proposed length of the bridge only, not the length of the project. (Do not include the length of approach guardrails.)

If only a portion of the bridge is to be rehabilitated or replaced, the improvement length is a measurement of the portion being improved only. If the entire bridge is being rehabilitated or replaced, the improvement length is measured from back to back of abutment backwalls or from pavement notch to pavement notch. See Figure WB78-47A.

If the bridge is a pipe or culvert, the improvement length is measured along the centerline of the barrel, regardless of pipe or culvert depth below grade. For pipes, code the total length of the pipe before ends have been mitered. This is not the length as is referenced in WB74-40. See Figure WB78-47B.

If the proposed improvement is to the substructure or channel beneath the bridge, code the length of the bridge directly over, or supported by, the substructure or channel.

This field must be coded for bridges eligible for the Highway Bridge Replacement and Rehabilitation Program.

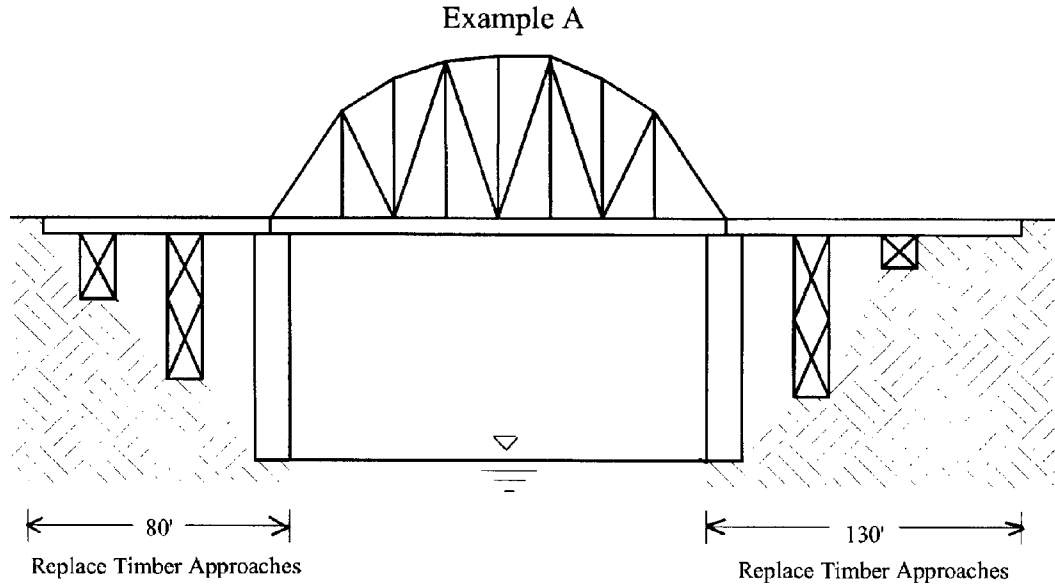

If the proposed improvement is to replace the timber approaches of both ends of the structure, the total length of improvement is:

$$80' + 130' = \text{Code } 000210$$

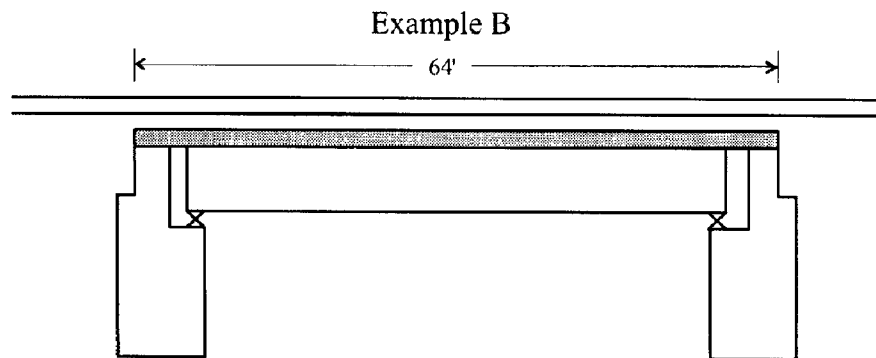

If the proposed improvement is to replace the entire structure, the total length of improvement is a measurement from paving notch to paving notch, or 64 feet, in the example above.

Code: 000064

**Figure WB78-47A**



## PIPE CULVERT CROSS SECTION

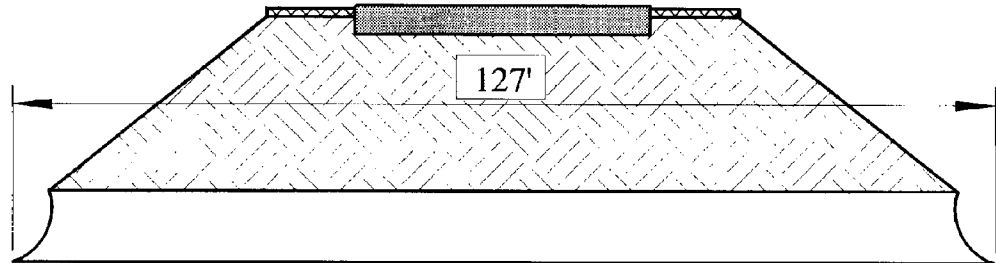

If the proposed improvement is to replace a length of pipe, the total length of improvement is the length of the pipe (before ends have been mitered).

Code: 000127

## BOX CULVERT

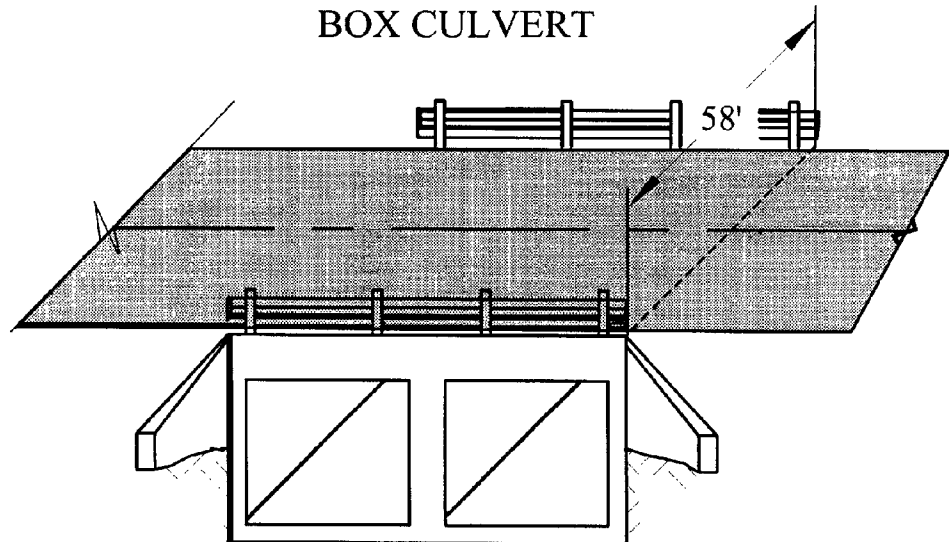

If the proposed improvement is to replace a box culvert, the total length of improvement is the length of the culvert between parapet walls.

Code: 000058

*Figure WB78-47B*

**prpsed\_roadway\_width Proposed Improvement Roadway Width (Required)**

WB78-53 This field contains the curb-to-curb width of the roadway on the proposed bridge. This measurement is coded to the nearest foot.

**prpsed\_lanes\_on Proposed Improvement Lanes On (Required)**

WB78-57 This field contains the number of through lanes the proposed bridge will carry.

**prpsed\_lanes\_under Proposed Improvement Lanes Under (Required)**

WB78-59 This field contains the number of lanes that will pass beneath the proposed bridge.

**prpsed\_total\_cost Proposed Improvement Total Cost (Required)**

WB78-61

FHWA Item 096 This field must be coded for bridges eligible for the Highway Bridge Replacement and Rehabilitation Program. This field contains the total cost of the proposed improvements in thousands of dollars. This value includes the bridge cost, the roadway cost, and all incidental costs normally associated with the proposed bridge improvement project. The total project cost will, therefore, usually be greater than the sum of the bridge and roadway costs.

If WB78-83 is coded N, the cost will not be automatically generated.

If no improvement is needed, code all zeroes.

Do not use this field to estimate maintenance costs.

**prpsed\_structure\_cost Proposed Improvement Structure Cost (Required)**

WB78-67

FHWA Item 094 This field must be coded for bridges eligible for the Highway Bridge Replacement and Rehabilitation Program. This field contains the estimated cost, in thousands of dollars, for the proposed bridge or major bridge improvements. This total should include only bridge construction costs.

It excludes any roadway, right of way, detour, demolition, preliminary engineering, maintenance, guardrail, or paving costs that are not part of the bridge cost.

If WB78-83 is coded N, the cost will not automatically be generated.

If no improvement is needed, code all zeroes.

**prpsed\_roadway\_cost Proposed Improvement Roadway Cost (Required)**

WB78-73

FHWA Item 095 This field contains the estimated cost, in thousands of dollars, for any proposed roadway improvements. This total includes all roadway construction costs, including guardrail and paving costs, but does not include bridge, right of way, detour, extensive roadway realignment, preliminary engineering, or maintenance costs.

If WB78-83 is coded N, the cost will not automatically be generated.

This field must be coded for bridges eligible for the Highway Bridge Replacement and Rehabilitation Program.

**prpsed\_estimate\_year Proposed Improvement Estimate Year (Required)**

WB78-79

FHWA Item 097 This field contains the year in which the project cost estimates have been made. If this date is more than eight years old, the cost estimates entered in WB78-61, WB78-67, and WB78-73 must be revised and a new estimate year must be entered in this field.

**prpsed\_cost\_calc Proposed Improvement Calculation (Required)**

WB78-83

This field directs the WSBIS system to compute costs for any proposed bridge improvements.

If no improvements are proposed for the bridge, this field should be left blank.

Y Yes, compute the replacement costs automatically.

N No, do not automatically compute the replacement costs.

**inspn\_agency\_id Inspecting Agency (Optional)**

WB78-84

WSBIS Item 7884

If the agency which owns the bridge does not have primary responsibility for inspecting it, this field describes the type of agency inspecting the bridge.

If the owner agency has primary responsibility for inspecting the bridge, leave this field blank, otherwise enter a code to indicate the type of agency inspecting the bridge.

When the agency which owns the bridge performs routine inspections on it and uses other agencies to perform special inspections (for example, a consultant performs underwater inspections), the primary responsibility for inspecting the bridge is still considered to rest with the owner agency. The field should be left blank. Use the following codes.

- 01 State Highway Agency
- 02 County Highway Agency
- 03 Town or Township Highway Agency
- 04 City or Municipal Highway Agency
- 11 State Park, Forest, or Reservation Agency
- 12 County Park, Forest, or Reservation Agency
- 13 City/Other Park, Forest, or Reservation Agency
- 21 Other State Agencies
- 24 Other County Agencies
- 25 Other City or Local Agencies
- 26 Private (Consultant)
- 27 Railroad
- 31 State Toll Authority
- 32 County Toll Authority
- 33 City or Other Toll Authority
- 60 Other Federal Agencies (not listed below)
- 61 Indian Tribal Government
- 62 Bureau of Indian Affairs
- 63 Bureau of Fish and Wildlife
- 64 U.S. Forest Service
- 66 National Park Service

|    |                                         |
|----|-----------------------------------------|
| 68 | Bureau of Land Management               |
| 69 | Bureau of Reclamation                   |
| 70 | Corps of Engineers (Civilian)           |
| 71 | Corps of Engineers (Military)           |
| 72 | Air Force                               |
| 73 | Navy/Marines                            |
| 74 | Army                                    |
| 75 | NASA                                    |
| 76 | Metroplitan Washington Airport Services |
| 80 | Unknown                                 |
| 91 | Canada                                  |
| 92 | Idaho                                   |
| 93 | Oregon                                  |

**city\_inspn\_no**     **Inspecting Agency Number** *(Optional)*

WB78-86

**WSBIS Item 7886**

If the agency which owns the bridge does not have primary responsibility for inspecting it, this field contains a code which indicates the entity which is performing the inspections.

Use the following criteria for determining the proper code to enter:

- 1 If the inspecting entity is a county, code that county's number in the first two field positions and leave the last two field positions blank.
- 2 If the inspecting agency is a city, code that city's four-digit number in the field.
- 3 If the inspecting entity is WSDOT or an agency outside Washington State, code all zeroes in the field.

If the owner agency is inspecting the bridge, leave this field blank

**seismic\_superstrctr\_main\_b**     **Seismic Status Superstructure Main Biennium** *(Optional)*

WB78-90

This field contains the biennium in which the superstructure main span group was fitted with seismic restraining devices.

Enter the beginning and ending years of the biennium. For example, code the 1997-1999 biennium as 9799.

Leave this field blank If the superstructure of the main span group has not been fitted with seismic restraining devices.

**seismic\_superstrctr\_aprch\_b**     **Seismic Status Superstructure Approach Biennium** *(Optional)*

WB78-94

This field contains the biennium in which the superstructure approach span group was fitted with seismic restraining devices.

Enter the beginning and ending years of the biennium. For example, code the 1997-1999 biennium as 9799.

Leave this field blank If either there are no approach spans or If the superstructure of the approach span group has not been fitted with seismic restraining devices.

**seismic\_substrctr\_main\_b Seismic Status Substructure Main Biennium (Optional)**

WB78-98 This field contains the biennium in which the substructure main span group was fitted with seismic restraining devices.

Enter the beginning and ending years of the biennium. For example, code the 1997-1999 biennium as 9799.

Leave this field blank If the substructure of the main span group has not been fitted with seismic restraining devices.

**seismic\_substrctr\_aprch\_b Seismic Status Substructure Approach Biennium (Optional)**

WB78-102 This field contains the biennium in which the substructure approach span group was fitted with seismic restraining devices.

Enter the beginning and ending years of the biennium. For example, code the 1997-1999 biennium as 9799.

Leave this field blank If either there are no approach spans or If the substructure of the approach span group has not been fitted with seismic restraining devices.



## Edit Process

The WSBIS system has been designed so that various checks of the coded values are made before the form is processed and the information stored in WSBIS. These edit checks are made each time information is added or updated. There are four different types of edit checks performed and each is described below.

### A. Valid Range Edits

Each field is edited to see if a complete entry was made and whether the coded values fall within the acceptable range of values for that field. For example, acceptable values for SECTION (WB71-81) are the numbers 01 through 36. The number 42, therefore, is an invalid entry in this field.

When a valid range error is found during processing, the error is underlined in the field and asterisks are printed in the Card Indicator Box corresponding to that field. (Card WB71 in the example above). These errors should be corrected and the form resubmitted. Refer to the VALID RANGE EDITS table on the following pages for a listing of valid values for each field.

### B. Fatal Field Edits

Certain fields are considered critical and must contain acceptable values for information to be added or updated on the form. These are called Fatal Fields. For example, COUNTY NUMBER is considered a Fatal Field. Therefore, an acceptable value (a number between 01 and 39) must be coded in the field.

If a Fatal Field error is found when data is first being added, the inventory record will not be created. When a Fatal Field error is found as the form is being updated, the original data will be left in the field and an error message will be displayed. Refer to the FATAL FIELD EDITS table on the following pages for a list of Fatal Fields, and the field descriptions.

### C. Dependency Edits

Certain fields are cross-checked against each other to confirm compatibility of codes in related fields. For example, if the MAXIMUM SPAN LENGTH has been coded 0078, then the BRIDGE LENGTH (WB73-40) must be coded as greater than 0078 (since the total length of the structure is usually greater than the length of the maximum span). Similarly, if NAVIGATION CONTROL (WB73-86) has been coded 1 (to indicate that navigation control exists) then NAVIGATION VERTICAL CLEARANCE and NAVIGATION HORIZONTAL CLEARANCE must be coded with values greater than 0 (since a navigable channel must have some vertical and horizontal clearance).

When a dependency error is found during processing of the form, the problematic fields are marked and an error message code is printed at the top of the form. These messages are preceded by the letter E and indicate the source of the problem. For a listing of the error codes which may appear on the form and what each means, refer to the ERROR CODES table on the following pages.

## **D. Logical Edits**

Values coded in certain fields are checked to see if they are reasonable. For example, for the MINIMUM VERTICAL CLEARANCE UNDER BRIDGE (WB73-74) to be coded at 8 feet, would be questionable. Values coded in certain fields are also checked against other values to see if a reasonable relationship exists between two fields. For example, if YEAR BUILT (WB73-32) has been coded to show that the bridge has been built in the past five years, it would be unreasonable for the DECK CONDITION OVERALL to be coded 0 through 4 (how could a five year old bridge deck be in such deteriorated condition?)

When logical coding errors are found during the processing of the form, the problematic fields are marked and an error message code is printed at the top of the form. These messages are preceded either by the letter R or the letter L and indicate the source of the problem. For a listing of error codes which may appear on the form and what each means, refer to the ERROR CODES table on the following pages.



## Error Codes

- E400** One of the following conditions is true:
- **National Highway System (WB74-83)** is coded “1” *and* **Highway Class (WB74-33)** is in the range “4” through “8”
- OR**
- **National Highway System (WB74-83)** is not coded “1” *and* **Highway Class (WB74-33)** is coded “1”
- E401** **On/Under (WB74-32)** is coded “2” or is in the range “A” through “Z” *and* one of the following conditions is true:
- **Lanes On (WB73-52)** is greater than “/00” *and* **Service On (WB75-44)** is coded “0”, “2”, “3”, or “9”
- OR**
- **Lanes On (WB73-52)** is coded “/00” *and* **Service On (WB75-44)** code is coded “1” or is in the range “4” through “8”
- E402** One of the following conditions is true:
- **Lanes Under (WB73-54)** is greater than “/00” *and* **Service Under (WB75-45)** is not “1”, “4”, “6”, or “8”
- OR**
- **Lanes Under (WB73-54)** is coded “/00” *and* **Service Under (WB75-45)** is not “2”, “3”, “5”, “7”, “9”, or “0”
- E403** One of the following conditions is true:
- **National Highway System (WB74-83)** is coded “0” *and* **Federal Functional Classification (WB74-87)** is coded “01”, “02”, “11”, “12”, or “14”
- OR**
- **National Highway System (WB74-83)** is coded “1” *and* **Federal Functional Classification (WB74-87)** is coded “06”, “07”, “08”, “09”, “16”, “17”, or “19”
- E404** **Deck Geometry (WB76-58)** is coded in the range “0” through “5” *and* one of the following conditions is true:
- **Year Built (WB73-32)** is within 10 years of current year
- OR**
- **Year Rebuilt (WB73-36)** is within 10 years of current year
- E405** If **Year Rebuilt (WB73-36)** > ‘ 0000’ *and* **Year Rebuilt (WB73-36)** is earlier than **Year Built (WB73-32)**
- E406** **Underclearance Adequacy (WB76-59)** is in the range “0” through “5” *and* one of the following conditions is true:
- **Year Built (WB73-32)** is within 10 years of current year
- OR**
- **Year Rebuilt (WB73-36)** is within 10 years of current year

- E407** On/Under (WB74-32) is coded “2” or is in the range “A” through “Z” and Lanes Under (WB73-54) is coded “/ØØ”
- E408** On/Under (WB74-32) is coded “1” and one of the following conditions is true:
- Navigation Control (WB73-86) is coded “1” and Navigation Horizontal Clearance (WB73-90) is coded “ØØØØ”
  - OR*
  - Navigation Control (WB73-86) is coded “Ø” or “N” and Navigation Horizontal Clearance (WB73-90) is greater than “ØØØØ”
- E409** On/Under (WB74-32) is coded “1” and one of the following conditions is true:
- Navigation Control (WB73-86) is coded “1” and Navigation Vertical Clearance (WB73-87) is coded “ØØØØ”
  - OR*
  - Navigation Control (WB73-86) is coded “Ø” or “N” and Navigation Vertical Clearance (WB73-87) is greater than “ØØØØ”
- E410** Maximum Span Length (WB73-48) is greater than Bridge Length (WB73-40)
- E411** On/Under (WB74-32) is coded “2” or is in the range “A” through “Z” and Underclearance Adequacy (WB76-59) is in the range “Ø” through “3” and none of the following are true:
- Service Under (WB75-45) is coded “1” or “6” and Minimum Vertical Clearance Under Bridge (WB73-74) is less than 15 feet and STRAHNET (WB74-85) is coded “2”
  - OR*
  - Service Under (WB75-45) is coded “1” or “6” and Minimum Vertical Clearance Under Bridge (WB73-74) is less than 14 feet and STRAHNET (WB74-85) is coded “Ø” or “1”
  - OR*
  - Service Under (WB75-45) is coded “2”, “4”, “7”, or “8” and Minimum Vertical Clearance Under Bridge (WB73-74) is less than 20 feet
  - OR*
  - Service Under (WB75-45) is coded “Ø”, “3”, “5”, or “9”
- E412** On/Under (WB74-32) is coded “2” or is in the range “A” through “Z” and Underclearance Adequacy (WB76-59) is in the range “Ø” through “3” and Service Under (WB75-45) is coded “2”, “4”, “7”, or “8” and the lesser of Horizontal Clearance Route Direction (WB74-91) and Horizontal Clearance Reverse Direction (WB74-95) is less than 8 feet.

- E415** **On/Under (WB74-32)** is coded “2” or is in the range “A” through “Z” *and Underclearance Adequacy (WB76-59)* is in the range “Ø” through “3” *and Service Under (WB75-45)* is coded “1”, “4”, “6”, or “8” *and Median (WB72-91)* is greater than “Ø” *and* either of the following is false:
- **ADT (WB74-45)** is greater than 249 *and* less than 999999 *and* **Minimum Lateral Underclearance Left (WB73-83)** is less than 2 feet  
*OR*
  - **ADT (WB74-45)** is less than 25Ø or equal to 999999 *and* **Minimum Lateral Underclearance Left (WB73-83)** is less than 1’Ø6”
- E416** **On/Under (WB74-32)** is coded “2” or is in the range “A” through “Z” *and Underclearance Adequacy (WB76-59)* is in the range “Ø” through “3” *and* **Minimum Lateral Underclearance Right Code (WB73-82)** is “H” *and* one of the following is false:
- **ADT (WB74-45)** is greater than 249 *and* less than 999999 *and* **Minimum Lateral Underclearance Right (WB73-79)** is less than 6 feet  
*OR*
  - **ADT (WB74-45)** is less than 25Ø or equal to 999999 *and* **Minimum Lateral Underclearance Right (WB73-79)** is less than 4’ Ø6”
- E417** **STRAHNET (WB74-85)** is coded “1” or “2” *and* **Horizontal Clearance Route Direction (WB74-91)** is zero *and* **Horizontal Clearance Reverse Direction (WB74-95)** is zero
- E418** **STRAHNET (WB74-85)** is coded “1” or “2” *and* **Latitude (WB71-88)** is not within range
- E419** **STRAHNET (WB74-85)** is coded “1” or “2” *and* **Longitude (WB71-96)** is not within range
- E420** **Curb to Curb Width (WB73-56)** is coded “ØØØØ” *and* **Main Span Design (WB75-33)** does not equal “19”
- E421** **Out to Out Deck Width (WB73-60)** is coded “ØØØØ” *and* **Main Span Design (WB75-33)** does not equal “19”
- E422** One of the following conditions is true:
- **Main Span Design (WB75-33)** is coded “19” *and* **Deck Overall (WB76-63)** is in the range “Ø” through “8”  
*OR*
  - **Main Span Design (WB75-33)** is not coded “19” *and* **Deck Overall (WB76-63)** is coded “9”
- E423** One of the following conditions is true:
- **Main Span Design (WB75-33)** is coded “19” *and* **Superstructure Overall (WB76-71)** is in the range “Ø” through “8”  
*OR*
  - **Main Span Design (WB75-33)** is not coded “19” *and* **Superstructure Overall (WB76-71)** is coded “9”

- E424 One of the following conditions is true:
- **Main Span Design (WB75-33)** is coded “19” *and* **Substructure Overall (WB76-76)** is in the range “Ø” through “8”  
*OR*
  - **Main Span Design (WB75-33)** is not coded “19” *and* **Substructure Overall (WB76-76)** is coded “9”
- E425 One of the following conditions is true:
- **Main Span Design (WB75-33)** is coded “19” *and* **Culvert (WB76-78)** is coded “9”  
*OR*
  - **Main Span Design (WB75-33)** is not coded “19” *and* **Culvert (WB76-78)** is in the range “Ø” through “8”
- E426 **Open Closed (WB72-93)** is coded “E” or “K” *and* **Operating Rating Tons (WB75-52)** is greater than zero
- E427 **Open Closed (WB72-93)** is coded “E” or “K” *and* **Inventory Rating Tons (WB75-55)** is greater than zero
- E428 **Proposed Improvements Total Cost (WB78-61)** is less than the sum of **Proposed Improvements Structure Cost (WB78-67)** *plus* **Proposed Improvements Roadway Cost (WB78-73)**
- E429 **Proposed Improvements Estimate Year (WB78-79)** is greater than “ØØØØ” *and* one of the following conditions is true:
- **Proposed Improvements Structure Cost (WB78-67)** is zero  
*OR*
  - **Proposed Improvements Roadway Cost (WB78-73)** is zero  
*OR*
  - **Proposed Improvements Total Cost (WB78-61)** is zero
- E430 **Main Span Design (WB75-33)** is coded “15” *and* **Vertical Lift Minimum Clearance (WB73-94)** is blank
- E431 **ADT (WB74-45)** is greater than 1ØØ *and* **Truck ADT Percent (WB74-51)** is blank
- E432 **NBIS Length (WB73-46)** is greater than or equal to 2Ø feet *and* **Bridge Length (WB73-40)** is less than 2Ø feet
- E433 One of the following conditions is not met:
- **Border State Code (WB75-85)** = spaces *and* **Border State Percent (WB75-88)** = spaces *and* **Border State Structure Identifier (WB75-90)** = spaces  
*OR*
  - **Border State Code (WB75-85)** not = spaces *and* **Border State Percent (WB75-88)** not = spaces *and* **Border State Structure Identifier (WB75-90)** not = spaces

- E437 Sufficiency Rating is less than or equal to 8  $\emptyset$ .  $\emptyset\emptyset$  and the Deficient Obsolete Status is “1” (SD) or “2” (FO) and one or more of the following fields are coded zero:
- **Proposed Improvement Work Type (WB78-44)**
  - **Proposed Improvement Work Method (WB78-46)**
  - **Proposed Improvement Structure Improvement Length (WB78-47)**
  - **Proposed Improvement Structure Cost (WB78-67)**
  - **Proposed Improvement Roadway Cost (WB78-73)**
  - **Proposed Improvement Total Cost (WB78-61)**
- E450 **On/Under (WB74-32)** is coded “1” and **Lanes On (WB73-52)** is coded “/ $\emptyset\emptyset$ ”
- E451 **On/Under (WB74-32)** is coded “1” and **Service On (WB75-44)** is coded “ $\emptyset$ ”, “2”, “3”, or “9”
- E452 **On/Under (WB74-32)** is coded “2” or is in the range “A” through “Z” and **Service Under (WB75-45)** is coded “ $\emptyset$ ”, “2”, “3”, “5”, “7”, or “9”
- E453 **Underclearance Adequacy (WB76-59)** is in the range “ $\emptyset$ ” through “8” and **Service Under (WB75-45)** is coded “ $\emptyset$ ”, “3”, “5”, or “9”
- E454 **Waterway Adequacy (WB76-62)** is in the range “ $\emptyset$ ” through “8” and **Service Under (WB75-45)** is coded “1”, “2”, “3”, or “4”
- E455 **Service Under (WB75-45)** is in the range “5” through “9” and **Substructure Stability (WB78-37)** is blank
- E456 **Service Under (WB75-45)** is in the range “5” through “9” and **Flood Control (WB78-34)** is blank
- E457 **Service Under (WB75-45)** is in the range “5” through “9” and **Flood Plain Intrusion (WB78-33)** is blank
- E459 **Service Under (WB75-45)** is in the range “5” through “9” and **Piers in Water (WB78-41)** is blank
- E460 **Service Under (WB75-45)** is in the range “5” through “9” and **Scour (WB76-80)** is “N” or blank
- E461 **Service Under (WB75-45)** is in the range “5” through “9” and **Waterway Obstruction (WB78-38)** is blank
- E462 **Service Under (WB75-45)** is in the range “5” through “9” and **Streambed Anabranch (WB78-40)** is blank
- E463 **Service Under (WB75-45)** is in the range “5” through “9” and **Streambed Material (WB78-36)** is blank
- E464 **Service Under (WB75-45)** is in the range “5” through “9” and **Scour History (WB78-35)** is blank
- E465 **Service Under (WB75-45)** is in the range “5” through “9” and **Streambed Stability (WB78-39)** is blank

- E466 **Service Under (WB75-45)** is in the range “5” through “9” *and* **Channel Protection (WB76-77)** is coded “9”
- E467 **Service Under (WB75-45)** is in the range “5” through “9” *and* **Water Type (WB78-32)** is blank
- E468 One of the following conditions is true:
- **Navigation Control (WB73-86)** is coded “1” *and* **Pier / Abutment (WB76-79)** is coded “N” or blank
- OR*
- **Navigation Control (WB73-86)** is coded “N” *and* **Pier / Abutment (WB76-79)** is in the range “1” through “5”
- E470 **Service Under (WB75-45)** is in the range “1” through “4” or “Ø” *and* **Substructure Stability (WB78-37)** is not blank
- E471 **Service Under (WB75-45)** is in the range “1” through “4” or “Ø” *and* **Flood Control (WB78-34)** is not blank
- E472 **Service Under (WB75-45)** is in the range “1” through “4” or “Ø” *and* **Flood Plain Intrusion (WB78-33)** is not blank
- E473 **Service Under (WB75-45)** is in the range “1” through “4” or “Ø” *and* **Navigation Control (WB73-86)** is coded “Ø” or “1”
- E474 **Service Under (WB75-45)** is in the range “1” through “4” or “Ø” *and* **Navigation Horizontal Clearance** is greater than zero
- E475 **Service Under (WB75-45)** is in the range “1” through “4” or “Ø” *and* **Navigation Vertical Clearance** is greater than zero
- E476 **Service Under (WB75-45)** is in the range “1” through “4” or “Ø” *and* **Pier / Abutment (WB76-79)** is in the range “1” through “5”
- E477 **Service Under (WB75-45)** is in the range “1” through “4” or “Ø” *and* **Piers in Water (WB78-41)** is not blank
- E478 **Service Under (WB75-45)** is in the range “1” through “4” or “Ø” *and* **Channel Protection (WB76-77)** is in the range “Ø” through “8”
- E479 One of the following conditions is true:
- **Service Under (WB75-45)** is in the range “1” through “4” or “Ø” *and* **Scour (WB76-80)** is coded “U” or “T” or in the range “Ø” through “9”
- OR*
- **Service Under (WB75-45)** is in the range “5” through “9” *and* **Scour (WB76-80)** is coded “N”
- E480 **Service Under (WB75-45)** is in the range “1” through “4” or “Ø” *and* **Waterway Obstruction (WB78-38)** is not blank
- E481 **Service Under (WB75-45)** is in the range “1” through “4” or “Ø” *and* **Streambed Anabranch (WB78-40)** is not blank
- E482 **Service Under (WB75-45)** is in the range “1” through “4” or “Ø” *and* **Streambed Material (WB78-36)** is not blank

- E483 **Service Under (WB75-45)** is in the range “1” through “4” or “Ø” *and* **Scour History (WB78-35)** is not blank
- E484 **Service Under (WB75-45)** is in the range “1” through “4” or “Ø” *and* **Streambed Stability (WB78-39)** is not blank
- E485 **Service Under (WB75-45)** is in the range “1” through “4” or “Ø” *and* **Water Type (WB78-32)** is not blank
- E489 **Curb to Curb Width (WB73-56)** is greater than **Out to Out Deck Width (WB73-60)**
- E490 **Inventory Rating Tons (WB75-55)** is greater than **Operating Rating Tons (WB75-52)**
- E491 **Superstructure Overall (WB76-71)** is coded “Ø” or “1” *and* **Open Closed (WB72-93)** is not coded “D”, “E”, or “K”
- E492 **Substructure Overall (WB76-76)** is coded “Ø” or “1” *and* **Open Closed (WB72-93)** is not coded “D”, “E”, or “K”
- E493 **Culvert (WB76-78)** is coded “Ø” or “1” *and* **Open Closed (WB72-93)** is not coded “D”, “E”, or “K”
- E494 One of the following conditions is true:
- **Temporary Structure (WB72-89)** is coded “T” *and* **Open Closed (WB72-93)** is not coded “D”, “E”, or “P”
- OR*
- **Open Closed (WB72-93)** is coded “D” or “E” *and* **Temporary Structure (WB72-89)** is not coded “T”
- E495 **Proposed Improvements Work Type (WB78-44)** is greater than “/ØØ” *and* **Proposed Improvements Estimate Year (WB78-79)** is coded zero or is blank
- E496 **Proposed Improvements Work Type (WB78-44)** is greater than “/ØØ” *and* **Proposed Improvements Lanes On (WB73-52)** is coded zero or is blank
- E497 **Proposed Improvements Work Type (WB78-44)** greater than “/ØØ” *and* **Proposed Improvements Structure Improvement Length (WB78-47)** is coded zero or is blank
- E499 **Proposed Improvements Work Type (WB78-44)** is greater than “/ØØ” *and* **Proposed Improvements Roadway Width (WB78-53)** is coded zero or is blank
- E500 **Proposed Improvements Work Type (WB78-44)** is greater than “/ØØ” *and* **Proposed Improvements Service On (WB75-44)** is coded zero or is blank
- E501 **Proposed Improvements Work Type (WB78-44)** is greater than “/ØØ” *and* **Proposed Improvements Structure Cost (WB78-67)** is coded zero or is blank
- E502 **Proposed Improvements Work Type (WB78-44)** is greater than “/ØØ” *and* **Proposed Improvements Total Cost (WB78-61)** is coded zero or blank

- E504** **Proposed Improvements Work Type (WB78-44)** is greater than “/00” *and* **Proposed Improvements Work Method (WB78-46)** is coded zero or is blank
- E507** One of the following conditions is true:
- **Inspecting Agency Code (WB78-84)** is in the group (“01”, “11”, “21”, “26”, “27”, “31”, “62”, “63”, “64”, “66” thru “71”, or “80”) *and* **Inspecting Agency Number (WB78-86)** does not = spaces  
**OR**
  - **Inspecting Agency Code (WB78-84)** is in the group (“02”, “12”, “24”, or “32”) *and* **Inspecting Agency Number (WB78-86)** is not in County Table  
**OR**
  - **Inspecting Agency Code (WB78-84)** is in the group (“03”, “04”, “13”, “25”, or “33”) *and* **Inspecting Agency Number (WB78-86)** is not in City Table
- E511** One of the following conditions is true:
- **Base Highway Network (WB74-84)** = “1” *and* **Linear Referencing System Route (WB74-67)** *and* **Linear Referencing System Sub Route (WB74-77)** are not coded  
**OR**
  - **Base Highway Network (WB74-84)** = “0” *and* **Linear Referencing System Route (WB74-67)** is coded or **Linear Referencing System Sub Route (WB74-77)** is coded
- E512** **Base Highway Network (WB74-84)** is coded “1” *and* **Federal Functional Classification (WB74-87)** is not coded “01”, “02”, “06”, “11”, “12”, or “14”
- E513** **Lanes On (WB73-52)** is coded “1” *and* **Lane Use Direction (WB74-90)** is not coded “1” or “5”
- E515** **On/Under (WB74-32)** is coded “2” or in the range “A” through “Z” *and* **Lanes Under (WB73-54)** is coded “1” *and* **Lane Use Direction (WB74-90)** is not coded “1” or “5”
- E516** One of the following conditions is true:
- **Lanes On (WB73-52)** is coded “/00” *and* **Service On (WB75-44)** not = “0”, “2”, “3”, or “9”  
**OR**
  - **Lanes On (WB73-52)** is greater than “/00” *and* **Service On (WB75-44)** is coded “0”, “2”, “3”, or “9”
- E603** **Owner (Control Field)** is coded “01” *and* **Service On (WB75-44)** is coded “1” or is in the range “4” through “8” *and* **Curb Condition (WB76-72)** is blank



- E605** **Owner (Control Field)** is coded “Ø1” *and* **Service On (WB75-44)** is coded “1” or is in the range “4” through “8” *and* **Sidewalk Condition (WB76-73)** is blank
- E613** **Owner (Control Field)** is coded “Ø1” *and* **Service On (WB75-44)** is coded “1” or is in the range “4” through “8” *and* **Paint Condition (WB76-74)** is blank
- E616** **Owner (Control Field)** is coded “Ø1” *and* **Service On (WB75-44)** is coded “1” or is in the range “4” through “8” *and* **Pier Protection (WB76-83)** is blank
- E617** **Owner (Control Field)** is coded “Ø1” *and* **Service On (WB75-44)** is coded “1” or is in the range “4” through “8” *and* **Number of Utilities (WB76-75)** is blank
- E618** **Owner (Control Field)** is coded “Ø1” *and* **Service On (WB75-44)** is coded “1” or is in the range “4” through “8” *and* **Scaling Severity (WB76-66)** is blank
- E619** **Owner (Control Field)** is coded “Ø1” *and* **Service On (WB75-44)** is coded “1” or is in the range “4” through “8” *and* **Scaling Percent (WB76-67)** is blank
- E620** **Owner (Control Field)** is coded “Ø1” *and* **Service On (WB75-44)** is coded “1” or is in the range “4” through “8” *and* **Deck Rutting (WB76-69)** is blank
- E621** **Owner (Control Field)** is coded “Ø1” *and* **Service On (WB75-44)** is coded “1” or is in the range “4” through “8” *and* **Exposed Reinforcing Steel (WB76-70)** is blank
- E622** **Owner (Control Field)** is coded “Ø1” *and* **Service On (WB75-44)** is coded “1” or is in the range “4” through “8” *and* **Drain Condition (WB76-64)** is blank
- E623** **Owner (Control Field)** is coded “Ø1” *and* **Service On (WB75-44)** is coded “1” or is in the range “4” through “8” *and* **Retaining Walls (WB76-82)** is blank
- E630** One of the following conditions is true
- **Lane Use Direction (WB74-90)** is coded “Ø” *and* **Lanes On (WB73-52)** is greater than zero
- OR**
- **On/Under (WB74-32)** is coded “1” *and* **Lane Use Direction (WB74-90)** is in the range “1” through “5” *and* **Lanes On (WB73-52)** is equal to zero
- L007** **Future ADT (WB74-57)** is greater than 200,000
- L008** **Future ADT Year (WB74-63)** is not in the range of 17 to 23 years in the future
- L009** **ADT (WB74-45)** is greater than 200,000
- L010** **Truck ADT Percent (WB74-51)** is greater than 40

- L011** ADT Year (WB74-53) is more than 4 years old
- L012** Alignment Adequacy (WB76-61) is coded “Ø” or “1”
- L047** Channel Protection (WB76-77) is coded “Ø” or “1”
- L085** Deck Geometry (WB76-58) is coded “Ø” or “1”
- L092** Deck Overall (WB76-63) is coded “Ø” or “1”
- L132** One of the following conditions is true:
- Main Span Design (WB75-33) is coded “/ØØ”
- OR**
- Main Span Material (WB75-32) is coded “Ø”
- L158** Horizontal Clearance Reverse Direction (WB74-95) is less than 8 feet
- L159** Horizontal Clearance Route Direction (WB74-91) is less than 8 feet
- L163** Routine Inspection Frequency (WB76-32) is greater than 24 months
- L183** Lanes On (WB73-52) is greater than 14
- L184** Lanes Under (WB73-54) is greater than 2 Ø
- L185** Routine Inspection Last Inspection Date (WB76-34) is more than three years old
- L210** Maximum Span Length (WB73-48) is greater than 984 feet
- L223** Minimum Vertical Clearance Under Bridge (WB73-74) is greater than zero *and* less than 7 feet
- L228** Navigation Horizontal Clearance (WB73-90) is greater than 984 ft.
- L229** Navigation Vertical Clearance (WB73-87) is greater than 25Ø feet.
- L231** Proposed Improvements Estimate Year (WB78-79) is more than 8 years old
- L232** Number of Main Spans (WB75-38) is greater than 5Ø
- L233** Number of Approach Spans (WB75-41) is greater than 5Ø
- L318** Operating Level (WB76-60) is coded “Ø” or “1”
- L321** Sidewalk Curb Left (WB73-64) is greater than 12 feet
- L322** Sidewalk Curb Right (WB73-67) is greater than 12 feet
- L339** Bridge Length (WB73-40) is greater than 3937 feet
- L341** Structural Adequacy (WB76-57) is coded “Ø” or “1”
- L368** Underclearance Adequacy (WB76-59) is coded “Ø” or “1”
- L378** Maximum Vertical Clearance Route Direction (WB74-99) is less than 8 feet
- L382** Waterway Adequacy (WB76-62) is coded “Ø” or “1”
- R700** On/Under (WB74-32) is coded “1” *and* Year Built (WB73-32) is within the last 5 years *and* Deck Overall (WB76-63) is less than 5

- R701** **On/Under (WB74-32)** is coded “1” *and* **Year Built (WB73-32)** is within the last 5 years *and* **Superstructure Overall (WB76-71)** is less than 5
- R702** **On/Under (WB74-32)** is coded “1” *and* **Year Built (WB73-32)** is within the last 5 years *and* **Substructure Overall (WB76-76)** is less than 5
- R703** **On/Under (WB74-32)** is coded “1” *and* **Year Built (WB73-32)** is within the last 5 years *and* **Channel Protection (WB76-77)** is less than 5
- R704** **On/Under (WB74-32)** is coded “1” *and* **Year Built (WB73-32)** is within the last 5 years *and* **Culvert (WB76-78)** is less than 5
- R705** **On/Under (WB74-32)** is coded “1” *and* **Year Built (WB73-32)** is within the last 5 years *and* **Structural Adequacy (WB76-57)** is less than 5
- R706** **On/Under (WB74-32)** is coded “1” *and* **Year Built (WB73-32)** is within the last 5 years *and* **Deck Geometry (WB76-58)** is less than 5
- R707** **On/Under (WB74-32)** is coded “1” *and* **Year Built (WB73-32)** is within the last 5 years *and* **Underclearance Adequacy (WB76-59)** is less than 5
- R708** **On/Under (WB74-32)** is coded “1” *and* **Year Built (WB73-32)** is within the last 5 years *and* **Operating Level (WB76-60)** is less than 5
- R709** **On/Under (WB74-32)** is coded “1” *and* **Year Built (WB73-32)** is within the last 5 years *and* **Waterway Adequacy (WB76-62)** is less than 5
- R710** **On/Under (WB74-32)** is coded “1” *and* **Year Built (WB73-32)** is within the last 5 years *and* **Alignment Adequacy (WB76-61)** is less than 5
- R711** **On/Under (WB74-32)** is coded “1” *and* **Year Built (WB73-32)** is within the last 5 years *and* **Inventory Rating Tons (WB75-55)** is less than 20 tons
- R712** **On/Under (WB74-32)** is coded “1” *and* **Year Built (WB73-32)** is within the last 5 years *and* **Operating Rating Tons (WB75-52)** is less than 20 tons
- R713** **On/Under (WB74-32)** is coded “1” *and* **Year Rebuilt (WB73-36)** is within 5 years *and* **Deck Overall (WB76-63)** is in the range “0” through “5”
- R714** **On/Under (WB74-32)** is coded “1” *and* **Year Rebuilt (WB73-36)** is within 5 years *and* **Superstructure Overall (WB76-71)** is in the range “0” through “4”
- R715** **On/Under (WB74-32)** is coded “1” *and* **Year Rebuilt (WB73-36)** is within 5 years *and* **Substructure Overall (WB76-76)** is in the range “0” through “4”
- R716** **On/Under (WB74-32)** is coded “1” *and* **Year Rebuilt (WB73-36)** is within 5 years *and* **Channel Protection (WB76-77)** is in the range “0” through “4”
- R717** **On/Under (WB74-32)** is coded “1” *and* **Year Rebuilt (WB73-36)** is within 5 years *and* **Culvert (WB76-78)** is in the range “0” through “4”
- R718** **On/Under (WB74-32)** is coded “1” *and* **Year Rebuilt (WB73-36)** is within 5 years *and* **Structural Adequacy (WB76-57)** is in the range “0” through “4”

- R719** **On/Under (WB74-32)** is coded “1” *and* **Year Rebuilt (WB73-36)** is within 5 years *and* **Deck Geometry (WB76-58)** is in the range “Ø” through “4”
- R720** **On/Under (WB74-32)** is coded “1” *and* **Year Rebuilt (WB73-36)** is within 5 years *and* **Underclearance Adequacy (WB76-59)** is in the range “Ø” through “4”
- R721** **On/Under (WB74-32)** is coded “1” *and* **Year Rebuilt (WB73-36)** is within 5 years *and* **Operating Level (WB76-60)** is in the range “Ø” through “4”
- R722** **On/Under (WB74-32)** is coded “1” *and* **Year Rebuilt (WB73-36)** is within 5 years *and* **Waterway Adequacy (WB76-62)** is in the range “Ø” through “4”
- R723** **On/Under (WB74-32)** is coded “1” *and* **Year Rebuilt (WB73-36)** is within 5 years *and* **Alignment Adequacy (WB76-61)** is in the range “Ø” through “4”
- R727** **Median (WB72-91)** is coded “Ø”, or in the range “2” through “7”, or “9” *and* **Minimum Lateral Underclearance Left (WB73-83)** is coded 99.9
- R729** **Service On (WB75-44)** is coded “1” or is in the range “4” through “8” *and* **Approach Roadway Width (WB73-97)** is less than 8 feet
- R730** **Service On (WB75-44)** is coded “1” or is in the range “4” through “8” *and* **Curb to Curb Width (WB73-56)** is less than 9 feet
- R731** **Service On (WB75-44)** is coded “1” or is in the range “4” through “8” *and* **Out to Out Deck Width (WB73-60)** is less than 9 feet
- R732** **Service On (WB75-44)** is coded “1” or is in the range “4” through “8” *and* **Minimum Vertical Clearance Over Deck (WB73-70)** is less than 7 feet
- R733** **Service Under (WB75-45)** is coded “1”, “2”, “4”, “6”, “7” or “8” *and* **Minimum Vertical Clearance Under Bridge (WB73-74)** is zero
- R736** **Main Span Design (WB75-33)** is in the range “/ØØ” through “18”, or “21”, or “22” *and* **Curb to Curb Width (WB73-56)** is between Ø *and* 9 feet or between 15Ø feet *and* 999 feet
- R737** **Main Span Design (WB75-33)** is in the range “/ØØ” through “18”, or “21”, or “22” *and* **Out to Out Deck Width (WB73-60)** is between Ø *and* 9 feet or between 15Ø feet *and* 999 feet.
- R738** **Bridge Length (WB73-40)** is between 19 feet *and* 23 feet *and* **NBIS Length (WB73-46)** is blank
- R742** **Open Closed (WB72-93)** is coded “A” *and* **Superstructure Overall (WB76-71)** is in the range “Ø” through “4”
- R743** **Open Closed (WB72-93)** is coded “A” *and* **Substructure Overall (WB76-76)** is in the range “Ø” through “4”
- R744** **Open Closed (WB72-93)** is coded “A” *and* **Culvert (WB76-78)** is in the range “Ø” through “4”

- R745** **Open Closed (WB72-93)** is coded “A” *and* **Superstructure Overall (WB76-71)** is greater than “4” *and* **Substructure Overall (WB76-76)** is greater than “4” *and* **Culvert (WB76-78)** is greater than “4” *and* **Operating Rating Tons (WB75-52)** is greater than 36 tons *and* **Structural Adequacy (WB76-57)** is in the range “Ø” through “3”
- R746** **Open Closed (WB72-93)** is coded “A” *and* **Operating Level (WB76-60)** is in the range “Ø” through “4”
- R747** **On/Under (WB74-32)** is coded “1” *and* **Operating Rating Tons (WB75-52)** is coded zero *and* **Open Closed (WB72-93)** is not coded “K” *and* **Temporary Structure (WB72-89)** is blank
- R762** **Routine Inspection Last Inspection Date (WB76-34)** is less than the current date minus **Routine Inspection Frequency (WB76-32)**
- R763** **Curb to Curb Width (WB73-56)** does not equal zero *and* **Lanes On (WB73-52)** is greater than 3 *and* **Approach Roadway Width (WB73-97)** is greater than 1.5 times **Curb to Curb Width (WB73-56)**
- R764** **Curb to Curb Width (WB73-56)** does not equal zero *and* **Lanes On (WB73-52)** is less or equal to 3 *and* **Approach Roadway Width (WB73-97)** is greater than or equal to 2 times **Curb to Curb Width (WB73-56)**
- R765** **Open Closed (WB72-93)** is coded “B”, “D”, “E”, “P” or “R” *and* **Routine Inspection Frequency (WB76-32)** is not less than 24 months
- R766** **Open Closed (WB72-93)** is not coded “D”, “E”, or “K” *and* any of the following fields is coded “Ø” *and* all others of this group are coded “2” or greater
- **Deck Overall (WB76-63)**
  - **Superstructure Overall (WB76-71)**
  - **Substructure Overall (WB76-76)**
  - **Culvert (WB76-78)**
  - **Structural Adequacy (WB76-57)**
  - **Deck Geometry (WB76-58)**
  - **Underclearance Adequacy (WB76-59)**
  - **Waterway Adequacy (WB76-62)**
- R767** **Operating Level (WB76-60)** is coded “5” *and* **Superstructure Overall (WB76-71)** is coded “Ø”, “1”, “2”, or “3”
- R768** **Operating Level (WB76-60)** is coded “5” *and* **Substructure Overall (WB76-76)** is coded “Ø”, “1”, “2”, or “3”
- R769** **Operating Level (WB76-60)** is coded “5” *and* **Culvert (WB76-78)** is coded “Ø”, “1”, “2”, or “3”

- R770** **Fracture Critical/UBIT Inspection Type (WB77-32)** is not coded “N” *and* **Fracture Critical/UBIT Inspection Frequency (WB77-33)** is greater than “/ØØ” *and* **Fracture Critical/UBIT Inspection Last Inspection Date (WB77-35)** is older than current date minus the **Fracture Critical/UBIT Inspection Frequency (WB77-33)**
- R771** **Underwater Inspection Type (WB77-58)** is not coded “N” *and* **Underwater Inspection Frequency (WB77-59)** is greater than “/ØØ” *and* **Underwater Inspection Last Inspection Date (WB77-61)** is older than current date minus the **Underwater Inspection Frequency (WB77-59)**
- R772** **Other Special Inspection Type (WB77-84)** is not coded “N” *and* **Other Special Inspection Frequency (WB77-85)** is greater than “/ØØ” *and* **Other Special Inspection Last Inspection Date (WB77-87)** is older than current date minus the **Other Special Inspection Frequency (WB77-85)**
- R773** **Future ADT (WB74-57)** is less than four-tenths **ADT (WB74-45)**
- R774** **Future ADT (WB74-57)** is greater than 4 times **ADT (WB74-45)**
- R775** **Minimum Vertical Clearance Under Bridge (WB73-74)** is coded “R” *and* **Minimum Vertical Clearance Under Bridge (WB73-74)** is less than 15’ Ø9”
- R776** **Minimum Lateral Underclearance Right (WB73-79)** is coded “R” *and* **Minimum Lateral Underclearance Right (WB73-79)** is less than 4ø11”
- R777** **Curb to Curb Width (WB73-56)** is less than 16’ /ØØ” *and* **Lanes On (WB73-52)** is greater than 1
- R778** The following conditions are not met:
- **Curb to Curb Width (WB73-56)** is greater than 16’ /ØØ” *and*
  - **Lanes On (WB73-52)** is 2 or greater *and*
  - **Service Level (WB74-34)** is not coded “7”
- R779** **Curb to Curb Width (WB73-56)** is less than half of **Out to Out Deck Width (WB73-60)**
- R780** One of the following conditions is true:
- **National Highway System (WB74-83)** is coded “1” *and* **Federal Functional Classification (WB74-87)** is not coded “Ø1”, “Ø2”, “11”, “12”, *and* “14”
- OR**
- **National Highway System (WB74-83)** is coded “Ø” *and* **Federal Functional Classification (WB74-87)** is not coded “Ø6”, “Ø7”, “Ø8”, “Ø9”, “16”, “17”, *and* “19”
- R781** **National Highway System (WB74-83)** is coded “1” *and* **Highway Class (WB74-33)** is coded “2” or “3”

## Appendix

2-A Half Bridges

## Forms

WSBIS Inventory Coding Form

Washington State Legislative Districts Map





# Appendix 2.06-E

# WSDOT BMS to NBE Translation

| STATE ELEMENTS |                                                    |      | TRANSLATION | NATIONAL ELEMENTS |                                        |                                 |    |
|----------------|----------------------------------------------------|------|-------------|-------------------|----------------------------------------|---------------------------------|----|
| element_id     |                                                    | unit |             | element_id        | name                                   | unit                            |    |
| 12             | Concrete Deck (See Note 9)                         | SF   |             |                   | intentionally blank                    |                                 |    |
| 8217           | Concrete Deck (See Note 9)                         | SF   |             |                   |                                        | intentionally blank             |    |
| 14             | Fully Supported Concrete Deck (See Note 9)         | SF   |             |                   |                                        | intentionally blank             |    |
| 20             | Concrete Deck - Lightweight Aggregate (See Note 9) | SF   |             |                   | 12                                     | Reinforced Concrete Deck        | SF |
| 26             | Concrete Deck w/Coated Bars (See Note 9)           | SF   |             |                   |                                        | intentionally blank             |    |
| 35             | Concrete Deck Soffit (See Note 9)                  | SF   |             |                   |                                        | intentionally blank             |    |
| 8216           | Concrete Deck Soffit (See Note 9)                  | SF   |             |                   |                                        | intentionally blank             |    |
|                | no state element equivalent                        |      |             | 13                | Prestressed Concrete Deck              | SF                              |    |
|                | no state element equivalent                        |      |             |                   | 15                                     | Prestressed Concrete Top Flange | SF |
| 13             | Bridge Deck Surface                                | SF   |             | 16                | Reinforced Concrete Top Flange         | SF                              |    |
| 8213           | Bridge Deck Surface                                | SF   |             |                   |                                        | intentionally blank             |    |
| 27             | Steel Orthotropic Deck                             | SF   |             |                   | intentionally blank                    |                                 |    |
| 30             | Deck-Corrugated or Other Steel System              | SF   |             | 30                | Steel Deck—Corrugated/Orthotropic/Etc. | SF                              |    |
| 8222           | Deck-Corrugated or Other Steel System              | SF   |             |                   | intentionally blank                    |                                 |    |
| 28             | Steel Deck Open Grid                               | SF   |             | 28                | Steel Deck—Open Grid                   | SF                              |    |
| 8218           | Steel Deck Open Grid                               | SF   |             |                   |                                        | intentionally blank             |    |
| 29             | Steel Deck - Concrete Filled Grid                  | SF   |             | 29                | Steel Deck—Concrete Filled Grid        | SF                              |    |
| 8219           | Steel Deck - Concrete Filled Grid                  | SF   |             |                   |                                        | intentionally blank             |    |
| 31             | Timber Deck                                        | SF   |             | 31                | Timber Deck                            | SF                              |    |
| 8221           | Timber Deck                                        | SF   |             |                   |                                        | intentionally blank             |    |
| 32             | Fiber Reinforced Polymer (FRP) Deck                | SF   |             | 60                | Other Deck                             | SF                              |    |
| 36             | Deck Rebar Cover Flag                              | SF   |             |                   | intentionally blank                    |                                 |    |

| STATE ELEMENTS |                                                |      | TRANSLATION | NATIONAL ELEMENTS |                     |                                              |    |
|----------------|------------------------------------------------|------|-------------|-------------------|---------------------|----------------------------------------------|----|
| element_id     |                                                | unit |             | element_id        | name                | unit                                         |    |
| 38             | Concrete Slab                                  | SF   |             |                   | intentionally blank |                                              |    |
| 49             | Concrete Hollow Slab                           | SF   |             |                   | intentionally blank |                                              |    |
| 50             | Prestressed Concrete Slab                      | SF   |             |                   | intentionally blank |                                              |    |
| 8150           | Prestressed Concrete Slab                      | SF   |             |                   | 38                  | Reinforced Concrete Slab                     | SF |
| 51             | Prestressed Conc Slab w/Coated Bars            | SF   |             |                   |                     | intentionally blank                          |    |
| 8151           | Prestressed Conc Slab w/Coated Bars            | SF   |             |                   |                     | intentionally blank                          |    |
| 52             | Concrete Slab w/Coated Bars                    | SF   |             |                   |                     | intentionally blank                          |    |
| 54             | Timber Slab                                    | SF   |             |                   | 54                  | Timber Slab                                  | SF |
|                | no state element equivalent                    |      |             | 65                | Other Slab          | SF                                           |    |
| 89             | Prestressed Concrete Girder w/Coated Strands   | LF   |             |                   | intentionally blank |                                              |    |
| 98             | Thin Flange Girder                             | LF   |             |                   |                     | intentionally blank                          |    |
| 103            | Prestressed Concrete Super Girder              | LF   |             |                   |                     | intentionally blank                          |    |
| 108            | Prestressed Concrete Bulb-T Girder             | LF   |             |                   |                     | intentionally blank                          |    |
| 8108           | Prestressed Concrete Bulb-T Girder             | LF   |             |                   | 109                 | Girder/Beam - Prestressed Concrete           | LF |
| 109            | Prestressed Concrete Multiple Web Girder Units | LF   |             |                   |                     | intentionally blank                          |    |
| 8109           | Prestressed Concrete Multiple Web Girder Units | LF   |             |                   |                     | intentionally blank                          |    |
| 115            | Prestressed Concrete Girder                    | LF   |             |                   |                     | intentionally blank                          |    |
| 8111           | Prestressed Concrete Girder                    | LF   |             |                   |                     | intentionally blank                          |    |
| 97             | Prestressed Concrete Tub Girder                | LF   |             |                   |                     | intentionally blank                          |    |
| 100            | Post-Tensioned Concrete Segmental Box Girder   | LF   |             |                   | 104                 | Closed Web/Box Girder - Prestressed Concrete | LF |
| 104            | Post-Tensioned Concrete Box Girder             | LF   |             |                   | intentionally blank |                                              |    |
| 90             | Steel Rolled Girder                            | LF   |             |                   | intentionally blank |                                              |    |
| 91             | Steel Riveted Girder                           | LF   |             |                   |                     | intentionally blank                          |    |
| 92             | Steel Welded Girder                            | LF   |             |                   | 107                 | Girder/Beam - Steel                          | LF |
| 107            | Steel Open Girder                              | LF   |             |                   |                     | intentionally blank                          |    |
| 8201           | Steel Open Girder                              | LF   |             |                   |                     | intentionally blank                          |    |
| 96             | Concrete Encased Steel Girder                  | LF   |             |                   |                     | intentionally blank                          |    |
|                | no state element equivalent                    |      |             |                   | 112                 | Girder/Beam - Other                          | LF |

| STATE ELEMENTS |                                   |      | TRANSLATION | NATIONAL ELEMENTS |                                             |                                   |
|----------------|-----------------------------------|------|-------------|-------------------|---------------------------------------------|-----------------------------------|
| element_id     |                                   | unit |             | element_id        | name                                        | unit                              |
| 102            | Steel Box Girder                  | LF   |             | 102               | Closed Web/Box Girder - Steel               | LF                                |
| 8200           | Steel Box Girder                  | LF   |             |                   |                                             | intentionally blank               |
| 105            | Concrete Box Girder               | LF   |             | 105               | Closed Web/Box Girder - Reinforced Concrete | LF                                |
|                | no state element equivalent       |      |             | 106               | Closed Web/Box Girder - Other               | LF                                |
| 110            | Concrete Girder                   | LF   |             |                   | intentionally blank                         |                                   |
| 8110           | Concrete Girder                   | LF   |             |                   | 110                                         | Girder/Beam - Reinforced Concrete |
| 114            | Concrete Multiple Web Girder Unit | LF   |             |                   | intentionally blank                         |                                   |
| 111            | Timber Glue-Lam Girder            | LF   |             |                   | intentionally blank                         |                                   |
| 117            | Timber Sawn Girder                | LF   |             |                   | 111                                         | Girder/Beam - Timber              |
| 8112           | Timber Sawn Girder                | LF   |             |                   | intentionally blank                         |                                   |
| 113            | Steel Stringer                    | LF   |             | 113               | Stringer - Steel                            | LF                                |
| 8209           | Steel Stringer                    | LF   |             |                   |                                             | intentionally blank               |
|                | no state element equivalent       |      |             | 115               | Stringer - Prestressed Concrete             | LF                                |
| 116            | Concrete Stringer                 | LF   |             | 116               | Stringer - Reinforced Concrete              | LF                                |
| 118            | Timber Stringer                   | LF   |             | 117               | Stringer - Timber                           | LF                                |
|                | no state element equivalent       |      |             | 118               | Stringer - Other                            | LF                                |
| 119            | Concrete Truss                    | LF   |             | 136               | Truss - Other                               | LF                                |
| 126            | Steel Thru Truss                  | LF   |             |                   | intentionally blank                         |                                   |
| 8204           | Steel Thru Truss                  | LF   |             |                   | 120                                         | Truss - Steel                     |
| 131            | Steel Deck Truss                  | LF   |             |                   | intentionally blank                         |                                   |
| 133            | Truss Gusset Plates               | EA   |             | 162               | Gusset Plate                                | EA                                |
| 135            | Timber Truss                      | LF   |             | 135               | Truss - Timber                              | LF                                |
| 139            | Timber Arch                       | LF   |             | 146               | Arch - Timber                               | LF                                |
| 141            | Steel Arch                        | LF   |             | 141               | Arch - Steel                                | LF                                |
| 142            | Steel Tied Arch                   | LF   |             |                   |                                             | intentionally blank               |
|                | no state element equivalent       |      |             | 143               | Arch - Prestressed Concrete                 | LF                                |
|                | no state element equivalent       |      |             | 145               | Arch - Masonry                              | LF                                |

| STATE ELEMENTS |                                                |      | TRANSLATION | NATIONAL ELEMENTS |                                              |                                     |    |
|----------------|------------------------------------------------|------|-------------|-------------------|----------------------------------------------|-------------------------------------|----|
| element_id     |                                                | unit |             | element_id        | name                                         | unit                                |    |
| 144            | Concrete Arch                                  | LF   |             | 144               | Arch - Reinforced Concrete                   | LF                                  |    |
| 145            | Earth Filled Concrete Arch                     | LF   |             |                   |                                              | intentionally blank                 |    |
|                | no state element equivalent                    |      |             | 142               | Arch - Other                                 | LF                                  |    |
| 143            | Steel Suspender - Rolled Shape (see note 7)    | EA   |             |                   | intentionally blank                          |                                     |    |
| 147            | Steel Suspender - Cable (see note 7)           | EA   |             |                   | 148                                          | Cable - Steel Secondary             | EA |
| 146            | Suspension - Main Cable (see note 8)           | EA   |             | 147               | Cable - Steel Main                           | LF                                  |    |
| 149            | Cable Stayed Bridge - Cable (see note 8)       | EA   |             |                   |                                              | intentionally blank                 |    |
| 150            | Concrete Column on Spandrel Arch               | EA   |             |                   | intentionally blank                          |                                     |    |
| 160            | Steel Column on Spandrel Arch                  | EA   |             |                   | intentionally blank                          |                                     |    |
| 152            | Steel Floor Beam                               | LF   |             |                   | intentionally blank                          |                                     |    |
| 8206           | Steel Floor Beam                               | LF   |             |                   | 152                                          | Floor Beam - Steel                  | LF |
| 8341           | Lift Beam (FC)                                 | LF   |             |                   | intentionally blank                          |                                     |    |
| 154            | Prestressed Concrete Floorbeam                 | LF   |             | 154               | Floor Beam - Prestressed Concrete            | LF                                  |    |
| 155            | Concrete Floor Beam                            | LF   |             | 155               | Floor Beam - Reinforced Concrete             | LF                                  |    |
| 156            | Timber Floor Beam                              | LF   |             | 156               | Floor Beam - Timber                          | LF                                  |    |
|                | no state element equivalent                    |      |             | 157               | Floor Beam - Other                           | LF                                  |    |
| 161            | Steel Hanger (See Note 10)                     | EA   |             |                   | intentionally blank                          |                                     |    |
| 162            | Steel Pin                                      | EA   |             |                   | 161                                          | Pin, Pin & Hanger Assembly, or both | EA |
| 8343           | Apron Two Hinge Pin System/LL Hanger Pins (FC) | EA   |             |                   |                                              | intentionally blank                 |    |
| 8342           | Live Load Hanger Bars (FC) (See Note 10)       | EA   |             |                   | intentionally blank                          |                                     |    |
| 200            | Abutment Fill                                  | EA   |             |                   | intentionally blank                          |                                     |    |
| 202            | Steel Pile/Column                              | EA   |             | 202               | Column/Pile Extension - Steel                | EA                                  |    |
| 204            | Prestressed Concrete Pile/Column               | EA   |             | 204               | Column/Pile Extension - Prestressed Concrete | EA                                  |    |
| 205            | Concrete Pile/Column                           | EA   |             |                   | intentionally blank                          |                                     |    |
| 207            | Concrete Pile/Column - w/Steel Jacket          | EA   |             | 205               | Column/Pile Extension - Reinforced Concrete  | EA                                  |    |
| 208            | Concrete Pile/Column w/Composite Wrap          | EA   |             |                   |                                              | intentionally blank                 |    |
| 206            | Timber Pile/Column                             | EA   |             | 206               | Column/Pile Extension - Timber               | EA                                  |    |

| STATE ELEMENTS |                                               |      | TRANSLATION | NATIONAL ELEMENTS |                                        |      |
|----------------|-----------------------------------------------|------|-------------|-------------------|----------------------------------------|------|
| element_id     |                                               | unit |             | element_id        | name                                   | unit |
|                | no state element equivalent                   |      |             | 203               | Column - Other                         | EA   |
|                | no state element equivalent                   |      |             | 207               | Column Tower (Trestle) - Steel         | EA   |
|                | no state element equivalent                   |      |             | 208               | Column Tower (Trestle) - Timber        | EA   |
| 209            | Submerged Concrete Pile/Column w/Steel Jacket | EA   |             |                   | intentionally blank                    |      |
| 227            | Concrete Submerged Pile/Column                | EA   |             | 227               | Submerged Pile - Reinforced Concrete   | EA   |
| 8125           | Concrete Submerged Pile/Column                | EA   |             |                   | intentionally blank                    |      |
| 210            | Concrete Pier Wall                            | LF   |             | 210               | Pier Wall - Reinforced Concrete        | LF   |
| 212            | Concrete Submerged Pier Wall                  | LF   |             |                   | intentionally blank                    |      |
| 211            | Other Pier Wall                               | LF   |             | 211               | Pier Wall - Other                      | LF   |
| 213            | Other Submerged Pier Wall                     | LF   |             |                   | intentionally blank                    |      |
| 214            | Concrete Web Wall between Columns             | LF   |             |                   | intentionally blank                    |      |
|                | no state element equivalent                   |      |             | 212               | Pier Wall - Timber                     | LF   |
|                | no state element equivalent                   |      |             | 213               | Pier Wall - Masonry                    | LF   |
| 215            | Concrete Abutment                             | LF   |             |                   | intentionally blank                    |      |
| 8102           | Concrete Abutment                             | LF   |             | 215               | Abutment - Reinforced Concrete         | LF   |
| 219            | Concrete Cantilevered Span Abutment           | LF   |             |                   | intentionally blank                    |      |
| 216            | Timber Abutment                               | LF   |             | 216               | Abutment - Timber                      | LF   |
| 8103           | Timber Abutment                               | LF   |             |                   | intentionally blank                    |      |
| 217            | Other Abutment                                | LF   |             | 218               | Abutment - Other                       | LF   |
| 218            | Steel Abutment                                | LF   |             | 219               | Abutment - Steel                       | LF   |
| 8101           | Steel Abutment                                |      |             |                   | intentionally blank                    |      |
|                | no state element equivalent                   |      |             | 217               | Abutment - Masonry                     | LF   |
| 220            | Concrete Submerged Foundation                 | EA   |             |                   | intentionally blank                    |      |
| 8136           | Concrete Submerged Foundation                 | EA   |             | 220               | Pile Cap/Footing - Reinforced Concrete | EA   |
| 221            | Concrete Foundation                           | EA   |             |                   | intentionally blank                    |      |
| 222            | Timber Foundation                             | LF   |             |                   | intentionally blank                    |      |















| STATE ELEMENTS |                                            |      | TRANSLATION | NATIONAL ELEMENTS |                                       |                     |    |
|----------------|--------------------------------------------|------|-------------|-------------------|---------------------------------------|---------------------|----|
| element_id     |                                            | unit |             | element_id        | name                                  | unit                |    |
| 225            | Steel Submerged Pile/Column                | EA   |             |                   | intentionally blank                   |                     |    |
| 8129           | Transfer Span/DHL Supercolumn              | EA   |             | 225               | Submerged Pile - Steel                | EA                  |    |
| 8128           | Steel Submerged Pile/Column                | EA   |             |                   | intentionally blank                   |                     |    |
| 226            | Prestressed Concrete Submerged Pile/Column | EA   |             | 226               | Submerged Pile - Prestressed Concrete | EA                  |    |
| 8127           | Prestressed Concrete Submerged Pile/Column | EA   |             |                   | intentionally blank                   |                     |    |
| 228            | Timber Submerged Pile/Column               | EA   |             | 228               | Submerged Pile - Timber               | EA                  |    |
| 8124           | Timber Submerged Pile/Column               | EA   |             |                   | intentionally blank                   |                     |    |
|                | no state element equivalent                |      |             | 229               | Pile - Other                          | EA                  |    |
| 229            | Timber Cap Rehab with Steel                | LF   |             |                   | intentionally blank                   |                     |    |
| 231            | Steel Pier Cap/Crossbeam                   | LF   |             | 231               | Pier Cap - Steel                      | LF                  |    |
| 8130           | Steel Pier Cap/Crossbeam                   | LF   |             |                   | intentionally blank                   |                     |    |
| 233            | Prestressed Concrete Pier Cap/Crossbeam    | LF   |             | 233               | Pier Cap - Prestressed Concrete       | LF                  |    |
| 234            | Concrete Pier Cap/Crossbeam                | LF   |             | 234               | Pier Cap - Reinforced Concrete        | LF                  |    |
| 8132           | Concrete Pier Cap/Crossbeam                | LF   |             |                   | intentionally blank                   |                     |    |
| 235            | Timber Pier Cap                            | LF   |             | 235               | Pier Cap - Timber                     | LF                  |    |
| 8131           | Timber Pier Cap                            | LF   |             |                   | intentionally blank                   |                     |    |
|                | no state element equivalent                |      |             |                   | 236                                   | Pier Cap - Other    | LF |
| 236            | Concrete Floating Pontoon                  | Cell |             |                   |                                       | intentionally blank |    |
| 237            | Pontoon Hatch/Bulkhead                     | EA   |             |                   | intentionally blank                   |                     |    |
| 238            | Floating Bridge - Anchor Cable             | EA   |             | 149               | Cable - Other Secondary               | EA                  |    |
| 240            | Metal Culvert                              | LF   |             | 240               | Culvert - Steel                       | LF                  |    |
| 241            | Concrete Culvert                           | LF   |             | 241               | Culvert - Reinforced Concrete         | LF                  |    |
| 242            | Timber Culvert                             | LF   |             | 242               | Culvert - Timber                      | LF                  |    |
|                | no state element equivalent                |      |             | 244               | Culvert - Masonry                     | LF                  |    |
| 243            | Other Culvert                              | LF   |             | 243               | Culvert - Other                       | LF                  |    |
|                | no state element equivalent                |      |             | 245               | Culvert - Prestressed Concrete        | LF                  |    |
| 250            | Tunnel - Concrete Lined                    | SF   |             |                   | intentionally blank                   |                     |    |





| STATE ELEMENTS |                                                   |      | TRANSLATION | NATIONAL ELEMENTS |                                         |      |
|----------------|---------------------------------------------------|------|-------------|-------------------|-----------------------------------------|------|
| element_id     |                                                   | unit |             | element_id        | name                                    | unit |
| 251            | Tunnel - Timber Lined                             | SF   | ↩           |                   | intentionally blank                     |      |
| 252            | Tunnel - Unlined                                  | SF   | ↩           |                   | intentionally blank                     |      |
| 253            | Tunnel Tile                                       | SF   | ↩           |                   | intentionally blank                     |      |
| 260            | Steel Open Grid Sidewalk & Supports               | SF   | ↩           |                   | intentionally blank                     |      |
| 261            | Steel Filled Grid Sidewalk & Supports             | SF   | ↩           |                   | intentionally blank                     |      |
| 8261           | Steel Filled Grid Sidewalk & Supports             | SF   | ↩           |                   | intentionally blank                     |      |
| 262            | Corrugated/Orthotropic Sidewalk & Supports        | SF   | ↩           |                   | intentionally blank                     |      |
| 8262           | Corrugated/Orthotropic Sidewalk & Supports        | SF   | ↩           |                   | intentionally blank                     |      |
| 264            | Timber Sidewalk & Supports                        | SF   | ↩           |                   | intentionally blank                     |      |
| 8264           | Timber Sidewalk & Supports                        | SF   | ↩           |                   | intentionally blank                     |      |
| 266            | Concrete Sidewalk & Supports                      | SF   | ↩           |                   | intentionally blank                     |      |
| 8266           | Concrete Sidewalk & Supports                      | SF   | ↩           |                   | intentionally blank                     |      |
| 267            | Fiber Reinforced Polymer(FRP) Sidewalk & Supports | SF   | ↩           |                   | intentionally blank                     |      |
| 8265           | Fiber Reinforced Polymer(FRP) Sidewalk & Supports | SF   | ↩           |                   | intentionally blank                     |      |
| 310            | Elastomeric Bearing                               | EA   | →           | 310               | Elastomeric Bearing                     | EA   |
| 311            | Moveable Bearing (roller, sliding, etc)           | EA   | ↔           | 311               | Moveable Bearing (roller, sliding, etc) | EA   |
| 8391           | Moveable Bearing (roller, sliding, etc)           | EA   | ↔           |                   | intentionally blank                     |      |
| 312            | Concealed Bearing or Bearing System               | EA   | →           | 312               | Enclosed/Concealed Bearing              | EA   |
| 313            | Fixed Bearing                                     | EA   | ↔           | 313               | Fixed Bearing                           | EA   |
| 8390           | Fixed Bearing                                     | EA   | ↔           |                   | intentionally blank                     |      |
| 316            | Isolation Bearing                                 | EA   | →           | 316               | Bearing - Other                         | EA   |
| 314            | Pot Bearing                                       | EA   | →           | 314               | Pot Bearing                             | EA   |
| 315            | Disc Bearing                                      | EA   | →           | 315               | Disk Bearing                            | EA   |
| 321            | Concrete Roadway Approach Slab                    | SF   | ↩           |                   | intentionally blank                     |      |
| 322            | Bridge Impact                                     | EA   | ↩           |                   | intentionally blank                     |      |
| 330            | Metal Bridge Railing                              | LF   | ↔           | 330               | Metal Bridge Railing                    | LF   |
| 8810           | Metal Bridge Railing                              | LF   | ↔           |                   | intentionally blank                     |      |

| STATE ELEMENTS |                             |      | TRANSLATION | NATIONAL ELEMENTS |                                    |                     |  |
|----------------|-----------------------------|------|-------------|-------------------|------------------------------------|---------------------|--|
| element_id     |                             | unit |             | element_id        | name                               | unit                |  |
| 331            | Concrete Bridge Railing     | LF   |             | 331               | Reinforced Concrete Bridge Railing | LF                  |  |
| 8811           | Concrete Bridge Railing     | LF   |             |                   |                                    | intentionally blank |  |
| 8812           | Concrete Bridge Railing     | LF   |             |                   |                                    | intentionally blank |  |
| 332            | Timber Bridge Railing       | LF   |             | 332               | Timber Bridge Railing              | LF                  |  |
| 8812           | Timber Bridge Railing       | LF   |             |                   |                                    | intentionally blank |  |
| 8813           | Timber Bridge Railing       | LF   |             |                   |                                    | intentionally blank |  |
| 333            | Other Bridge Railing        | LF   |             | 333               | Other Bridge Railing               | LF                  |  |
| 8813           | Other Bridge Railing        | LF   |             |                   |                                    | intentionally blank |  |
| 8814           | Other Bridge Railing        | LF   |             |                   |                                    | intentionally blank |  |
|                | no state element equivalent |      |             | 334               | Masonry Bridge Railing             | LF                  |  |
| 340            | Metal Pedestrian Railing    | LF   |             |                   | intentionally blank                |                     |  |
| 8815           | Metal Pedestrian Railing    | LF   |             |                   | intentionally blank                |                     |  |
| 341            | Concrete Pedestrian Railing | LF   |             |                   | intentionally blank                |                     |  |
| 8816           | Concrete Pedestrian Railing | LF   |             |                   | intentionally blank                |                     |  |
| 342            | Timber Pedestrian Railing   | LF   |             |                   | intentionally blank                |                     |  |
| 8817           | Timber Pedestrian Railing   | LF   |             |                   | intentionally blank                |                     |  |
| 343            | Other Pedestrian Railing    | LF   |             |                   | intentionally blank                |                     |  |
| 8818           | Other Pedestrian Railing    | LF   |             |                   | intentionally blank                |                     |  |
| 355            | Damaged Bolts or Rivets     | EA   |             |                   | intentionally blank                |                     |  |
| 8355           | Damaged Bolts or Rivets     | EA   |             |                   | intentionally blank                |                     |  |
| 356            | Steel Cracking              | EA   |             |                   | intentionally blank                |                     |  |
| 8356           | Steel Cracking              | EA   |             |                   | intentionally blank                |                     |  |
| 357            | Pack Rust                   | EA   |             |                   | intentionally blank                |                     |  |
| 8357           | Pack Rust                   | EA   |             |                   | intentionally blank                |                     |  |
| 360            | Bridge Movement             | EA   |             |                   | intentionally blank                |                     |  |
| 8360           | Bridge Movement             | EA   |             |                   | intentionally blank                |                     |  |
| 361            | Scour                       | EA   |             |                   | intentionally blank                |                     |  |
| 8361           | Scour                       | EA   |             |                   | intentionally blank                |                     |  |
| 362            | Impact Damage               | EA   |             |                   | intentionally blank                |                     |  |
| 8362           | Impact Damage               | EA   |             |                   | intentionally blank                |                     |  |











| STATE ELEMENTS |                                            |      | TRANSLATION | NATIONAL ELEMENTS |                     |                     |    |
|----------------|--------------------------------------------|------|-------------|-------------------|---------------------|---------------------|----|
| element_id     |                                            | unit |             | element_id        | name                | unit                |    |
| 366            | Undercrossing-Safety Inspection            | EA   | ↩           |                   | intentionally blank |                     |    |
| 367            | Movable Bridge                             | EA   | ↩           |                   | intentionally blank |                     |    |
| 368            | Seismic Pier Crossbeam Bolster             | EA   | ↩           |                   | intentionally blank |                     |    |
| 369            | Seismic Pier Infill Wall                   | EA   | ↩           |                   | intentionally blank |                     |    |
| 370            | Seismic - Longitudinal Restrainer          | EA   | ↩           |                   | intentionally blank |                     |    |
| 8370           | Seismic - Longitudinal Restrainer          | EA   | ↩           |                   | intentionally blank |                     |    |
| 371            | Seismic - Transverse Restrainer            | EA   | ↩           |                   | intentionally blank |                     |    |
| 8371           | Seismic - Transverse Restrainer            | EA   | ↩           |                   | intentionally blank |                     |    |
| 372            | Seismic - Link/Pin Restrainer              | EA   | ↩           |                   | intentionally blank |                     |    |
| 373            | Seismic - Catcher Block                    | EA   | ↩           |                   | intentionally blank |                     |    |
| 374            | Seismic - Column Silo                      | EA   | ↩           |                   | intentionally blank |                     |    |
| 375            | Cathodic Protection                        | EA   | ↩           |                   | intentionally blank |                     |    |
| 8375           | Cathodic Protection                        | EA   | ↩           |                   | intentionally blank |                     |    |
| 376            | Concrete Deck Delamination Testing         | SF   | ↩           |                   | intentionally blank |                     |    |
| 8376           | Concrete Deck Delamination Testing         | SF   | ↩           |                   | intentionally blank |                     |    |
| 400            | Asphalt Butt Joint Seal (see note 11)      | LF   | ↩           |                   | intentionally blank |                     |    |
| 403            | Concrete Bulb-T (see note 11)              | LF   |             |                   | 301                 | Pourable Joint      | LF |
| 417            | Silicone Rubber Joint Filler (see note 11) | LF   | ↩           |                   | intentionally blank |                     |    |
| 401            | Asphalt Open Joint Seal (see note 11)      | LF   |             |                   |                     | intentionally blank |    |
| 402            | Open Concrete Joint (see note 11)          | LF   |             |                   |                     | intentionally blank |    |
| 407            | Steel Angle Header (see note 11)           | LF   |             |                   | 304                 | Open Joint          | LF |
| 8407           | Steel Angle Header (see note 11)           | LF   |             |                   |                     | intentionally blank |    |
| 419            | Steel Angle w/Raised Bars (see note 11)    | LF   |             |                   | intentionally blank |                     |    |





| STATE ELEMENTS |                                                   |      | TRANSLATION                                                                         | NATIONAL ELEMENTS                                                                   |                                                                                   |                             |                     |    |
|----------------|---------------------------------------------------|------|-------------------------------------------------------------------------------------|-------------------------------------------------------------------------------------|-----------------------------------------------------------------------------------|-----------------------------|---------------------|----|
| element_id     |                                                   | unit |                                                                                     | element_id                                                                          | name                                                                              | unit                        |                     |    |
| 408            | Steel Sliding Plate (see note 11)                 | LF   |    |                                                                                     | intentionally blank                                                               |                             |                     |    |
| 8408           | Steel Sliding Plate (see note 11)                 | LF   |                                                                                     |                                                                                     | intentionally blank                                                               |                             |                     |    |
| 409            | Steel Sliding Plate w/Raised Bars (see note 11)   | LF   |                                                                                     |    | 305                                                                               | Assembly Joint without Seal | LF                  |    |
| 414            | Bolt Down - Sliding Plate w/Springs (see note 11) | LF   |                                                                                     |                                                                                     |                                                                                   | intentionally blank         |                     |    |
| 410            | Steel Fingers (see note 11)                       | LF   |                                                                                     |                                                                                     |                                                                                   | intentionally blank         |                     |    |
| 411            | Steel Fingers w/Raised Bars (see note 11)         | LF   |                                                                                     |                                                                                     |                                                                                   | intentionally blank         |                     |    |
| 404            | Compression Seal / Concrete Header (see note 11)  | LF   |                                                                                     |    |                                                                                   | intentionally blank         |                     |    |
| 8404           | Compression Seal / Concrete Header (see note 11)  | LF   |                                                                                     |                                                                                     |                                                                                   |                             | intentionally blank |    |
| 405            | Compression Seal / Polymer Header (see note 11)   | LF   |                                                                                     |                                                                                     |  | 302                         | Compression Seal    | LF |
| 406            | Compression Seal / Steel Header (see note 11)     | LF   |                                                                                     |                                                                                     |                                                                                   |                             | intentionally blank |    |
| 8406           | Compression Seal / Steel Header (see note 11)     | LF   |                                                                                     |                                                                                     |                                                                                   | intentionally blank         |                     |    |
| 412            | Strip Seal - Anchored (see note 11)               | LF   |   |    | 300                                                                               | Strip Seal                  | LF                  |    |
| 413            | Strip Seal - Welded (see note 11)                 | LF   |                                                                                     |                                                                                     |                                                                                   | intentionally blank         |                     |    |
| 416            | Assembly Joint Seal (Modular) (see note 11)       | LF   |  | 303                                                                                 | Assembly Joint Seal (Modular)                                                     | LF                          |                     |    |
| 415            | Bolt Down Panel - Molded Rubber (see note 11)     | LF   |  |  | 306                                                                               | Joint - Other               | LF                  |    |
| 418            | Asphalt Plug (see note 11)                        | LF   |                                                                                     |                                                                                     |                                                                                   | intentionally blank         |                     |    |
| 420            | Joint Paved Over Flag                             | LF   |                                                                                     |  |                                                                                   | intentionally blank         |                     |    |
| 501            | Movable Bridge Steel Tower                        | LF   |  |                                                                                     | intentionally blank                                                               |                             |                     |    |
| 705            | Bridge Luminaire Pole and Base                    | EA   |  |                                                                                     | intentionally blank                                                               |                             |                     |    |
| 8705           | Bridge Luminaire Pole and Base                    | EA   |  |                                                                                     | intentionally blank                                                               |                             |                     |    |
| 710            | Bridge Mounted Sign Structure                     | EA   |  |                                                                                     | intentionally blank                                                               |                             |                     |    |

| STATE ELEMENTS              |                                                      |      | TRANSLATION                                                                                                                                                         | NATIONAL ELEMENTS                                                                                                                                                      |                             |                     |                          |    |
|-----------------------------|------------------------------------------------------|------|---------------------------------------------------------------------------------------------------------------------------------------------------------------------|------------------------------------------------------------------------------------------------------------------------------------------------------------------------|-----------------------------|---------------------|--------------------------|----|
| element_id                  |                                                      | unit |                                                                                                                                                                     | element_id                                                                                                                                                             | name                        | unit                |                          |    |
| 800                         | Asphaltic Concrete (AC) Overlay (see note 11)        | SF   |   |                                                                                                                                                                        | intentionally blank         |                     |                          |    |
| 8223                        | Asphaltic Concrete (AC) Overlay (see note 11)        | SF   |                                                                                                                                                                     |                                                                                                                                                                        | intentionally blank         |                     |                          |    |
| 801                         | AC Overlay with Waterproofing Membrane (see note 11) | SF   |                                                                                                                                                                     |                                                                                                                                                                        | intentionally blank         |                     |                          |    |
| 802                         | Thin Polymer Overlay (see note 11)                   | SF   |                                                                                                                                                                     |                                                                                                                                                                        | intentionally blank         |                     |                          |    |
| 8224                        | Thin Polymer Overlay (see note 11)                   | SF   |                                                                                                                                                                     |                                                                                                                                                                        | 510                         | Wearing Surfaces    | SF                       |    |
| 803                         | Modified Concrete Overlay (see note 11)              | SF   |                                                                                                                                                                     |                                                                                                                                                                        | intentionally blank         |                     |                          |    |
| 804                         | Polyester Concrete Overlay (see note 11)             | SF   |                                                                                                                                                                     |                                                                                                                                                                        | intentionally blank         |                     |                          |    |
| 805                         | AC Over a Polymer Overlay (see note 11)              | SF   |                                                                                                                                                                     |                                                                                                                                                                        | intentionally blank         |                     |                          |    |
| 806                         | BST on Concrete (Chip Seal)                          | SF   |                                                                                                                                                                     |                                                                                       |                             | intentionally blank |                          |    |
| 901                         | Red Lead Alkyd Paint System (see note 12)            | SF   |                                                                                                                                                                     |   |                             | intentionally blank |                          |    |
| 8901                        | Red Lead Alkyd Paint System (see note 12)            | SF   |                                                                                                                                                                     |                                                                                                                                                                        |                             | intentionally blank |                          |    |
| 902                         | Inorganic-Zinc/Vinyl Paint System (see note 12)      | SF   |                                                                                                                                                                     |                                                                                                                                                                        |                             | intentionally blank |                          |    |
| 8902                        | Inorganic-Zinc/Vinyl Paint System (see note 12)      | SF   |                                                                                                                                                                     |                                                                                                                                                                        |                             | intentionally blank |                          |    |
| 903                         | Inorganic Zinc/Urethane Paint System (see note 12)   | SF   |                                                                                                                                                                     |                                                                                                                                                                        |                             | intentionally blank |                          |    |
| 8903                        | Inorganic Zinc/Urethane Paint System (see note 12)   | SF   |                                                                                                                                                                     |                                                                                                                                                                        |                             | intentionally blank |                          |    |
| 904                         | Organic Zinc/Urethane Paint System (see note 12)     | SF   |                                                                                                                                                                     |                                                                                                                                                                        |                             | intentionally blank |                          |    |
| 8904                        | Organic Zinc/Urethane Paint System (see note 12)     | SF   |                                                                                                                                                                     |                                                                                                                                                                        |                             | intentionally blank |                          |    |
| 905                         | Coal Tar Epoxy Paint System (see note 12)            | SF   |                                                                                                                                                                     |                                                                                                                                                                        |                             | 515                 | Steel Protective Coating | SF |
| 8905                        | Coal Tar Epoxy Paint System (see note 12)            | SF   |                                                                                                                                                                     |                                                                                                                                                                        |                             | intentionally blank |                          |    |
| 906                         | Metallizing (see note 12)                            | SF   |                                                                                                                                                                     |                                                                                                                                                                        | intentionally blank         |                     |                          |    |
| 907                         | Galvanizing (see note 12)                            | SF   |                                                                                                                                                                     | intentionally blank                                                                                                                                                    |                             |                     |                          |    |
| 8907                        | Galvanizing (see note 12)                            | SF   |                                                                                                                                                                     | intentionally blank                                                                                                                                                    |                             |                     |                          |    |
| 908                         | Epoxy Paint for Weathering Steel (see note 12)       | SF   |                                                                                                                                                                     | intentionally blank                                                                                                                                                    |                             |                     |                          |    |
| 909                         | Zinc Primer (see note 12)                            | SF   |                                                                                                                                                                     | intentionally blank                                                                                                                                                    |                             |                     |                          |    |
| 8909                        | Zinc Primer (see note 12)                            | SF   |                                                                                                                                                                     | intentionally blank                                                                                                                                                    |                             |                     |                          |    |
| 910                         | Weathering Steel Patina (see note 12)                | SF   |                                                                                                                                                                     | intentionally blank                                                                                                                                                    |                             |                     |                          |    |
| no state element equivalent |                                                      |      |                                                                                                                                                                     | 521                                                                                                                                                                    | Concrete Protective Coating | SF                  |                          |    |

| STATE ELEMENTS |                                                    |      | TRANSLATION | NATIONAL ELEMENTS |                     |      |
|----------------|----------------------------------------------------|------|-------------|-------------------|---------------------|------|
| element_id     |                                                    | unit |             | element_id        | name                | unit |
| 8225           | Non-skid Metal Surfacing                           | SF   | ↩           |                   | intentionally blank |      |
| 8263           | Steel Open Grid Sidewalk w/Cover Plate & Suppt.    | SF   | ↩           |                   | intentionally blank |      |
| 8301           | Apron Steel Orthotropic Deck                       | SF   | ↩           |                   | intentionally blank |      |
| 8305           | Apron Hinge Multi-Pin & Plate                      | EA   | ↩           |                   | intentionally blank |      |
| 8307           | Apron Lips & Pins                                  | EA   | ↩           |                   | intentionally blank |      |
| 8309           | Counterweight Cables for Vehicle Span or Apron     | LF   | ↩           |                   | intentionally blank |      |
| 8310           | Apron Hoist/Cables/Spool/Platform/Supports/Rigging | EA   | ↩           |                   | intentionally blank |      |
| 8312           | Span Apron/Cab Gangplank Pivot/Raise/Rams/Fittings | EA   | ↩           |                   | intentionally blank |      |
| 8348           | Span Hoist/Cables/Spool/Platform/Supports/Rigging  | EA   | ↩           |                   | intentionally blank |      |
| 8413           | Steel Tower                                        | EA   | ↩           |                   | intentionally blank |      |
| 8414           | Timber Tower                                       | EA   | ↩           |                   | intentionally blank |      |
| 8415           | Steel Headframe                                    | LF   | ↩           |                   | intentionally blank |      |
| 8416           | Timber Headframe                                   | LF   | ↩           |                   | intentionally blank |      |
| 8418           | Counterweight Guides                               | EA   | ↩           |                   | intentionally blank |      |
| 8419           | Concrete Counterweights                            | EA   | ↩           |                   | intentionally blank |      |
| 8420           | CTWT Sheaves/Shafts(FC)/Bearings/Anchor Blts.      | EA   | ↩           |                   | intentionally blank |      |
| 8421           | Counterweight Cable Protective Systems             | LF   | ↩           |                   | intentionally blank |      |
| 8423           | Steel Counterweights                               | EA   | ↩           |                   | intentionally blank |      |
| 8450           | Timber Wingwalls                                   | LF   | ↩           |                   | intentionally blank |      |
| 8451           | Steel Pile Frame Wingwalls                         | LF   | ↩           |                   | intentionally blank |      |
| 8460           | Timber Pile Dolphins                               | EA   | ↩           |                   | intentionally blank |      |
| 8462           | Steel Pile Frame Dolphins                          | EA   | ↩           |                   | intentionally blank |      |
| 8463           | Timber Floating Dolphin                            | LF   | ↩           |                   | intentionally blank |      |
| 8464           | Concrete Pontoon Floating Dolphin                  | LF   | ↩           |                   | intentionally blank |      |
| 8640           | Moveable Pedestrian Gangplank                      | LF   | ↩           |                   | intentionally blank |      |
| 8650           | Overhead Passenger Loading Cab                     | SF   | ↩           |                   | intentionally blank |      |
| 8653           | Passenger Cab Floor System and Lift Beam(FC)       | LF   | ↩           |                   | intentionally blank |      |

| STATE ELEMENTS |                                             |      | TRANSLATION                                                                       | NATIONAL ELEMENTS |                     |      |
|----------------|---------------------------------------------|------|-----------------------------------------------------------------------------------|-------------------|---------------------|------|
| element_id     |                                             | unit |                                                                                   | element_id        | name                | unit |
| 8669           | Tower Base Platform                         | SF   |  |                   | intentionally blank |      |
| 8701           | Ferry Concrete Floating Pontoon             | CELL |  |                   | intentionally blank |      |
| 8702           | Ferry Steel Floating Pontoon                | CELL |  |                   | intentionally blank |      |
| 8703           | Spud Piling & Wells                         | EA   |  |                   | intentionally blank |      |
| 8704           | Pontoon Anchors, Anchor Chain/Cables/Clamps | EA   |  |                   | intentionally blank |      |
| 8906           | Epoxy Paint System                          | SF   |  |                   | intentionally blank |      |
| 8910           | Safety Access Ladders                       | EA   |  |                   | intentionally blank |      |
| 8911           | Safety Railing & Catwalks                   | LF   |  |                   | intentionally blank |      |

**Translation Notes**

|     |                                                                                                                                                                                                                                                                                                                             |
|-----|-----------------------------------------------------------------------------------------------------------------------------------------------------------------------------------------------------------------------------------------------------------------------------------------------------------------------------|
| 1.  | State elements highlighted in light blue are used for structures owned and maintained by the Washington State Ferry system.                                                                                                                                                                                                 |
| 2.  | National bridge elements that do not have a state element equivalent are highlighted in orange.                                                                                                                                                                                                                             |
| 3.  | <p>A green arrow: </p> <p>indicates that the state element should be directly translated to the national element, including total quantities and each quantity for each condition state.</p>                                               |
| 4.  | <p>A green bracket with a green arrow: </p> <p>indicates that all state elements on a given bridge need total quantity and the quantity in each condition state to be summed prior to translation to the indicated national element.</p> |
| 5.  | <p>A green drop arrow: </p> <p>indicates the state element is not translated to a national element.</p>                                                                                                                                  |
| 6.  | <p>A red arrow: </p> <p>indicates special treatment is required for the translation. See associated note for details.</p>                                                                                                                |
| 7.  | Element 143 and 147 have been re-named to more clearly describe the existing intent of these elements. WSDOT owned bridges have 12 bridges with element 143 (for example 5/140E&W) and 3 bridges with element 147 (for example TNB 16/110E).                                                                                |
| 8.  | State Elements 146 and 149 will remain EA units. Quantities in each condition state and the total will be summed and reported in NBI element 147 as LF units without alteration.                                                                                                                                            |
| 9.  | Deck Translation Specifications - see separate worksheet                                                                                                                                                                                                                                                                    |
| 10. | Pin and Pin & Hanger Translation Specifications - see separate worksheet.                                                                                                                                                                                                                                                   |
| 11. | Joint and Wearing Surface Specifications - see separate worksheet.                                                                                                                                                                                                                                                          |
| 12. | Paint System Specifications - see separate worksheet.                                                                                                                                                                                                                                                                       |

## Note 9 - Deck Translation Specifications

For WSDOT elements 12, 14, 20, 26, and 8217, perform the following steps towards translation to NBE element 12:

| Step | Description                                                                                                                                                                |
|------|----------------------------------------------------------------------------------------------------------------------------------------------------------------------------|
| 1    | Sum total quantities and all quantities in each condition state into an NBE Temp element 12.                                                                               |
| 2    | Move all quantities in WSDOT CS4 into NBE Temp CS2, adding to the quantity of NBE Temp CS2 added in Step 1. NBE Temp CS4 will have zero quantity at this point.            |
| 3    | Move all quantities in WSDOT CS3 into NBE Temp CS4.                                                                                                                        |
| 4    | Add WSDOT elements 35 and 8216 CS2 to NBE Temp CS2.                                                                                                                        |
| 5    | Add WSDOT elements 35 and 8216 CS3 to NBE Temp CS4.                                                                                                                        |
| 6    | If NBE Temp total quantity = NBE Temp CS1 + CS2 + CS3 + CS4, go to Step 11.                                                                                                |
| 7    | If NBE Temp total quantity > NBE Temp CS1 + CS2 + CS3 + CS4, deduct difference from NBE Temp CS1 to zero limit, then go to Step 6.                                         |
| 8    | If NBE Temp total quantity > NBE Temp CS1 + CS2 + CS3 + CS4, deduct difference from NBE Temp CS2 to zero limit, then go to Step 6.                                         |
| 9    | If NBE Temp total quantity > NBE Temp CS1 + CS2 + CS3 + CS4, deduct difference from NBE Temp CS3 to zero limit, then go to Step 6. THIS STEP SEEMS REDUNDANT - GFC 7/31/14 |
| 10   | If NBE Temp total quantity > NBE Temp CS1 + CS2 + CS3 + CS4, set NBE Temp CS4 = NBE Temp total quantity, then go to Step 11.                                               |
| 11   | Move NBE Temp total quantity and all Temp CS1 through CS4 quantities to final NBE element 12.<br><b>Note:</b> CS3 will have zero quantity in the final translation.        |

For WSDOT elements 13 and 8413, perform the following steps towards translation to NBE element 16:

| Step | Description                                                                                                                                      |
|------|--------------------------------------------------------------------------------------------------------------------------------------------------|
| 1    | Sum total quantities and all quantities in each condition state into NBE element 16.                                                             |
| 2    | Move all quantities in WSDOT CS4 into NBE CS2, adding to the quantity of NBE CS2 added in Step 1. NBE CS4 will have zero quantity at this point. |
| 3    | Move all quantities in WSDOT CS3 into NBE CS4.<br><b>Note:</b> NBE CS3 will have zero quantity in the final translation.                         |

## Note 10 - Pin, Pin & Hanger Translation Specifications

For WSDOT elements 162 and 8343, perform the following steps towards translation to NBE element 161:

| Step | Description                                                                                                                        |
|------|------------------------------------------------------------------------------------------------------------------------------------|
| 1    | Sum the WSDOT elements 162 and 8243 total quantities and all condition state quantities into NBE Temp element 161.                 |
| 2    | Add the WSDOT element 161 and 8342 CS1 through CS4 to corresponding NBE Temp element 161 CS1 through CS4.                          |
| 3    | If NBE Temp total quantity = NBE Temp CS1 + CS2 + CS3 + CS4, go to Step 8.                                                         |
| 4    | If NBE Temp total quantity > NBE Temp CS1 + CS2 + CS3 + CS4, deduct difference from NBE Temp CS1 to zero limit, then go to Step 3. |
| 5    | If NBE Temp total quantity > NBE Temp CS1 + CS2 + CS3 + CS4, deduct difference from NBE Temp CS2 to zero limit, then go to Step 3. |
| 6    | If NBE Temp total quantity > NBE Temp CS1 + CS2 + CS3 + CS4, deduct difference from NBE Temp CS3 to zero limit, then go to Step 3. |
| 7    | If NBE Temp total quantity > NBE Temp CS1 + CS2 + CS3 + CS4, set NBE Temp CS4 = NBE Temp total quantity, then go to Step 8.        |
| 8    | Move NBE Temp total quantity and all Temp CS1 through CS4 quantities to final NBE element 161.                                     |

## Note 11 - Joint and Wearing Surface Translation Specifications

For WSDOT elements 400, 403 and 417, perform the following steps towards translation to NBE element 301:

| Step | Description                                                                                                           |
|------|-----------------------------------------------------------------------------------------------------------------------|
| 1    | Sum the WSDOT element total quantities and into NBE element total quantities.                                         |
| 2    | Sum the WSDOT element CS1 quantities into NBE element CS2 quantities. Note that NBE will have zero quantities in CS1. |
| 3    | Sum the WSDOT element CS2 quantities into NBE element CS3 quantities.                                                 |
| 4    | Sum the WSDOT element CS3 quantities into NBE element CS4 quantities.                                                 |

### Perform these same steps listed above for the following translations:

- WSDOT elements 401, 402, 407 8407, and 419 translated into NBE element 304
- WSDOT elements 408, 8408, 409, 414, 410 and 411 translated into NBE element 305
- WSDOT elements 404, 8404, 405, 406 and 8406 translated into NBE element 302
- WSDOT elements 412 and 413 translated into NBE element 300
- WSDOT element 416 translated into NBE element 303
- WSDOT elements 415 and 418 translated into NBE element 306
- WSDOT elements 800, 8223, 801, 802, 8224, 803, 804, and 805 translated into NBE element 510

## Note 12 - Paint/Coating Translation Specifications

For WSDOT elements 901, 8901, 902, 8902, 903, 8903, 904, 8904, 905, 8905, 906, 907, 8907, 908, 909, 8909, and 910, perform the following steps towards translation to NBE element 515:

| Step | Description                                                                                                               |
|------|---------------------------------------------------------------------------------------------------------------------------|
| 1    | Sum the WSDOT element total quantities and into NBE element total quantities.                                             |
| 2    | Sum the WSDOT element CS1 quantities into NBE element CS1 quantities.                                                     |
| 3    | Sum the WSDOT element CS2 quantities into NBE element CS2 quantities.                                                     |
| 4    | Sum the WSDOT element CS3 quantities into NBE element CS4 quantities. Note that NBE CS3 will always have zero quantities. |



**Oregon**

Send all reports and any requests for their reports to

Erick Cain, OPMA, Erick.j.cain@odot.state.or.us  
Bridge Inventory Coordinator  
4040 Fairview Industrial Dr. SE MS #4  
Salem, OR 97302  
Phone: 503 986 3384  
Fax: 503 986 3407

**Region 1 - (Longview to Hood River) –**

Joel Boothe, Joel.E.BOOTHE@odot.state.or.us  
Office 503-652-5691, Cell 503-969-1091, Fax 503-653-3085

Inspected by Oregon:

5/1E – 000000PR – Columbia R Interstate (Oregon #01377A)  
5/1W – 0005216A – Columbia R Interstate (Oregon #07333)  
205/1 – 0010833A – Glen Jackson Bridge (Oregon #09555)  
0259228300 – 08712700 – Br of the Gods (Oregon # 02592)

Inspected by Washington:

433/1 – 0003760A – Lewis & Clark (Oregon #02046)

**Region 2 -**

Bill Burns, 503-986-2659, Robert.W.BURNS@odot.state.or.us

Inspected by Oregon:

101/1 – 0007666A - Megler (Oregon #07949D) – Spans 1-4  
101/1(A) – 0007666B - Megler(A) (Oregon #07949A) – Spans 5-19  
101/1(B) – 0007666C - Megler(B) (Oregon #07949B) – Spans 20-159  
101/1(C) – 0007666D - Megler(C) (Oregon #07949C) – Span 160

**Region 4 - (Hood River to Biggs Jct.) –**

Mike Pulzone, James.M.PULZONE@odot.state.or.us  
Office 541-388-6188, Cell 541-419-1688, Fax 541-388-6108

Inspected by Oregon:

197/1 – 000000PC – The Dalles (Oregon #06635Q)

Inspected by Washington:

97/1 – 0006539A – Biggs Rapids-Sam Hill (Oregon #00849A)

Inspected by Consultants

06645 – 000000PH – Hood River (Oregon #06645)

**Region 5 -**

Kelley McAlister, Kelley.T.MCALISTER@odot.state.or.us  
541-963-1371

Inspected by Washington:

82/280N – 0012819A – Umatilla (Oregon #16424)

82/280S – 000000PD – Umatilla (Oregon #02230A)

**Oregon Underwater Reports –**

Rick Shorb, Rick.L.SHORB@odot.state.or.us

**Idaho**

Patty Fish, patty.fish@itd.idaho.gov, 208-334-8847  
cc to Kathleen Slinger, Kathleen.Slinger@itd.idaho.gov

Inspected by Washington

12/915 – 0002348A – Snake R Clarkston (ID SID 000000000010360)

Inspected by Idaho

41/10 – 00000LLV – BNRR OC (ID SID 000000000014255)

5700-1 – 08374400 – Southway Bridge (ID SID 000000000021495) –

Local Agency owned (Asotin County) – Idaho works directly with them

*Sufficiency Rating Worksheet*

**An Illustration of Sufficiency Rating (SR) Factors**

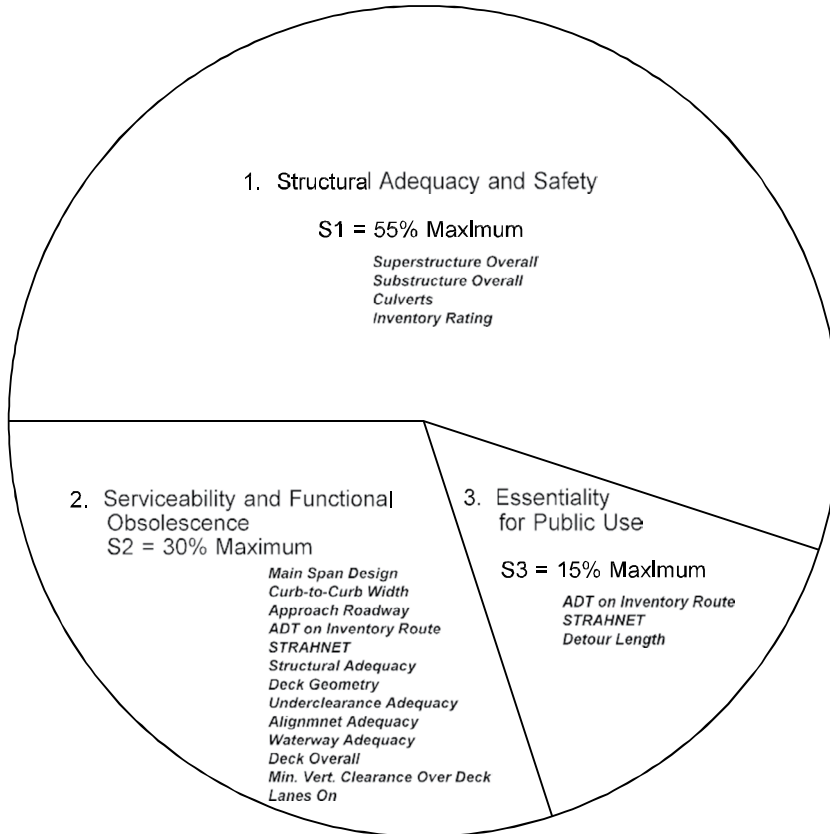

**4. Special Reductions**  
**S4 = 13% Maximum**  
*Detour Length*  
*Main Span Design*  
*Bridge Rail*  
*Transition*  
*Guardrail*  
*Terminal*

Sufficiency Rating = S1 + S2 + S3 - S4  
 Sufficiency Rating shall not be < 0 nor > 100  
 If S1 + S2 + S3 ≥ 50, then subtract S4,  
 otherwise SR = S1 + S2 + S3

|                         |                                       |
|-------------------------|---------------------------------------|
| Structure ID:           | _____                                 |
| Bridge Number:          | _____                                 |
| Bridge Name:            | _____                                 |
| Sufficiency Rating      | = S1 + S2 + S3 - S4 (Range: 0 to 100) |
|                         | = ( ) + ( ) + ( ) - ( )               |
|                         | = _____                               |
| SD/FO (WSBIS Item 2711) | = _____                               |
| Calculated by:          | _____                                 |
| Date:                   | _____                                 |

**Note:**

These calculations use English units. The final value may differ slightly from WSBIS Item 2710 as it is calculated using metric values.

**STRUCTURAL ADEQUACY & SAFETY (S1)****1. Determine the value of A:**

(a) Enter the condition codes for:

|            |                        |       |
|------------|------------------------|-------|
| WSBIS 1671 | SUPERSTRUCTURE OVERALL | _____ |
| WSBIS 1676 | SUBSTRUCTURE CONDITION | _____ |
| WSBIS 1678 | CULVERT CONDITION      | _____ |

(b) Find A:

A = 55 : If the lowest code above is less than or equal to 2

A = 40 : If the lowest code is equal to 3

A = 25 : If the lowest code is equal to 4

A = 10 : If the lowest code is equal to 5

A = 0 : If the lowest code is greater than 5

A = \_\_\_\_\_

**2. Determine the value of B:*****Either:***

when the Inventory Rating uses Tons:

(a) Enter the Inventory Rating (IR):  
WSBIS 1555 INVENTORY RATING (IR)=\_\_\_\_\_TONS

(b) Find the value of B:

$$B = (36 - IR)^{1.5} \times 0.2778$$

B = \_\_\_\_\_

***Or:***

when the Inventory Rating uses a Factor\*:

(a) Enter the Inventory Rating (IR):  
WSBIS 1556 INVENTORY RATING (IR)=\_\_\_\_\_FACTOR

(b) Find the value of B:

$$B = (36 - (IR \times 36))^{1.5} \times 0.2778$$

B = \_\_\_\_\_

**3. Determine S1:**

$$S1 = 55 - (A + B)$$

S1 = \_\_\_\_\_ (points range from 0 to 55)

\* See article at <http://www.fhwa.dot.gov/bridge/bridgeload01.cfm>

**SERVICEABILITY & FUNCTIONAL OBSOLESCENCE (S2)**

**1. Determine the value of C:**

- (a) Enter the adequacy or condition codes for the fields listed.
- (b) Determine corresponding values for these codes from Table 1.
- (c) For codes higher than those listed, use a value of 0.

**TABLE 1**

|                                      | <b>Code</b> | <b>Value</b> |
|--------------------------------------|-------------|--------------|
| If <i>STRUCTURAL EVALUATION</i> is:  | ≤ 3         | = 4          |
| <i>WSBIS 1657</i>                    | = 4         | = 2          |
|                                      | = 5         | = 1          |
|                                      |             |              |
| If <i>DECK GEOMETRY</i> is:          | ≤ 3         | = 4          |
| <i>WSBIS 1658</i>                    | = 4         | = 2          |
|                                      | = 5         | = 1          |
|                                      |             |              |
| If <i>UNDERCLEARANCES</i> is:        | ≤ 3         | = 4          |
| <i>WSBIS 1659</i>                    | = 4         | = 2          |
|                                      | = 5         | = 1          |
|                                      |             |              |
| If <i>ALIGNMENT</i> is:              | ≤ 3         | = 4          |
| <i>WSBIS 1661</i>                    | = 4         | = 2          |
|                                      | = 5         | = 1          |
|                                      |             |              |
| If <i>WATERWAY</i> is:               | ≤ 3         | = 4          |
| <i>WSBIS 1662</i>                    | = 4         | = 2          |
|                                      | = 5         | = 1          |
|                                      |             |              |
| If <i>OVERALL DECK CONDITION</i> is: | ≤ 3         | = 5          |
| <i>WSBIS 1663</i>                    | = 4         | = 3          |
|                                      | = 5         | = 1          |

- (d) Add the values to determine C.

|                                         | <u>Code</u>      | <u>Value</u>       |
|-----------------------------------------|------------------|--------------------|
| <i>WSBIS 1657 STRUCTURAL EVALUATION</i> | _____            | _____              |
| <i>WSBIS 1658 DECK GEOMETRY</i>         | _____            | _____              |
| <i>WSBIS 1659 UNDERCLEARANCES</i>       | _____            | _____              |
| <i>WSBIS 1661 ALIGNMENT</i>             | _____            | _____              |
| <i>WSBIS 1662 WATERWAY</i>              | _____            | _____              |
| <i>WSBIS 1663 OVERALL DECK CONDITON</i> | _____            | _____              |
|                                         | <b>TOTAL C =</b> | _____ (13 maximum) |

**2. Determine the value of D:**

(a) Enter measurements for the following fields:

WSBIS 1397 APPROACH ROADWAY WIDTH \_\_\_\_\_  
 WSBIS 1356 CURB-TO-CURB WIDTH \_\_\_\_\_

(b) Find the value of D: (For bridges that are not culverts (i.e., Main Span Design is not 19))

$APPROACH\ ROADWAY\ WIDTH > (CURB-TO-CURB\ WIDTH + 2.0')$ , D = 5  
 $APPROACH\ ROADWAY\ WIDTH \leq (CURB-TO-CURB\ WIDTH + 2.0')$ , D = 0

D = \_\_\_\_\_

**3. Determine the value of E:**

(a) Enter or determine the following values:

WSBIS 1352 LANES ON \_\_\_\_\_  
 WSBIS 1356 CURB-TO-CURB WIDTH \_\_\_\_\_  
 WSBIS 1445 ADT ON INVENTORY ROUTE \_\_\_\_\_  
 Lane Width (rounded to tenths):  
 CURB-TO-CURB WIDTH/LANES ON \_\_\_\_\_  
 ADT/Lane:  
 ADT ON INVENTORY ROUTE/LANES ON \_\_\_\_\_

(b) Find the value of E: (where the following conditions apply)

For One-Lane Bridges:

- Lane Width < 14, E = 15
- $14 \leq \text{Lane Width} < 18$ , E = 15  $((18 - \text{Lane Width})/4) =$  \_\_\_\_\_
- Lane Width  $\geq 18$ , E = 0

For Two or More Lane Bridges:

- LANES ON = 02 and Lane Width  $\geq 16$ , E = 0
- LANES ON = 03 and Lane Width  $\geq 15$ , E = 0
- LANES ON = 04 and Lane Width  $\geq 14$ , E = 0
- LANES ON > 05 and Lane Width  $\geq 12$ , E = 0

***If the above calculations apply, do not continue.***

- ADT/Lane > 50 and Lane Width < 9, E = 15
- ADT/Lane  $\leq 50$  and Lane Width < 9, E = 7.5
- ADT/Lane  $\leq 50$  and Lane Width  $\geq 9$ , E = 0
  
- $50 < \text{ADT/Lane} \leq 125$  and Lane Width < 10, E = 15
- $50 < \text{ADT/Lane} \leq 125$  and  $10 \leq \text{Lane Width} < 13$ ,  
 E = 15  $(13 - \text{Lane Width})/3 =$  \_\_\_\_\_
- $50 < \text{ADT/Lane} \leq 125$  and Lane Width  $\geq 13$ , E = 0
  
- $125 < \text{ADT/Lane} \leq 375$  and Lane Width < 11, E = 15
- $125 < \text{ADT/Lane} \leq 375$  and  $11 \leq \text{Lane Width} < 14$ ,  
 E = 15  $(14 - \text{Lane Width})/3 =$  \_\_\_\_\_
- $125 < \text{ADT/Lane} \leq 375$  and Lane Width  $\geq 14$ , E = 0

- $375 < \text{ADT/Lane} \leq 1350$  and Lane Width  $< 12$ ,  $E = 15$
- $375 < \text{ADT/Lane} \leq 1350$  and  $12 \leq \text{Lane Width} < 16$ ,  
 $E = 15 (16 - \text{Lane Width})/4 = \underline{\hspace{2cm}}$
- $375 < \text{ADT/Lane} \leq 1350$  and Lane Width  $\geq 16$ ,  $E = 0$
  
- $\text{ADT/Lane} > 1350$  and Lane Width  $< 15$ ,  $E = 15$
- $\text{ADT/Lane} > 1350$  and  $15 \leq \text{Lane Width} < 16$ ,  
 $E = 15 (16 - \text{Lane Width}) = \underline{\hspace{2cm}}$
- $\text{ADT/Lane} > 1350$  and Lane Width  $\geq 16$ ,  $E = 0$

$E = \underline{\hspace{2cm}}$

**4. Determine the value of F:**

(a) Enter the following values:

WSBIS 1370 MIN. VERT. CLEARANCE OVER DECK                       
 WSBIS 1485 STRAHNET                     

(b) Find the value of F: (using the following conditions)

- $\text{STRAHNET} > 0$  and  $\text{MIN. VERT. CLEARANCE OVER DECK} \geq 16.00$ ,  $F = 0$
- $\text{STRAHNET} > 0$  and  $\text{MIN. VERT. CLEARANCE OVER DECK} < 16.00$ ,  $F = 2$
- $\text{STRAHNET} = 0$  and  $\text{MIN. VERT. CLEARANCE OVER DECK} \geq 14.00$ ,  $F = 0$
- $\text{STRAHNET} = 0$  and  $\text{MIN. VERT. CLEARANCE OVER DECK} < 14.00$ ,  $F = 2$

$F = \underline{\hspace{2cm}}$

**5. Determine S2:**

$S2 = 30 - (C + (D + E) + F)$       ( $(D + E)$  cannot be more than 15)

$S2 = \underline{\hspace{2cm}}$  (points range from 0 to 30)

**ESSENTIALITY FOR PUBLIC USE (S3)**

**1. Determine the value of G:**

(a) Enter the following values:

WSBIS 1445 ADT ON INVENTORY ROUTE                       
 WSBIS 1413 DETOUR LENGTH                       
                     S1 POINTS                       
                     S2 POINTS                     

(b) Calculate the value of G:

$G = \frac{(\text{ADT ON INVENTORY ROUTE})(\text{DETOUR LENGTH})(7.5)}{[(S1 + S2)/85](100,000)}$

$G = \frac{(\underline{\hspace{2cm}})(\underline{\hspace{2cm}})(7.5)}{[(\underline{\hspace{2cm}} + \underline{\hspace{2cm}})/85](100,000)}$

$G = \underline{\hspace{2cm}}$  (15 maximum)



**2. Determine the value of H:**

(a) Enter the following value:

*WSBIS 1485 STRAHNET* \_\_\_\_\_

(b) Find the value of H:

- *STRAHNET* code is 1 or 2, H = 2
- *STRAHNET* code is 0, H = 0

**H** = \_\_\_\_\_

**3. Determine S3:**

$$S3 = 15 - (G + H)$$

**S3** = \_\_\_\_\_ (points range from 0 to 15)

**SPECIAL REDUCTIONS (S4)**

Use only if  $S1 + S2 + S3 \geq 50$

**1. Determine the value of I:**

(a) Enter the following value:

*WSBIS 1413 DETOUR LENGTH* \_\_\_\_\_

(b) Calculate the value of I:

$$I = (DETOUR LENGTH)^4(5.205)(10^{-8})$$

**I** = \_\_\_\_\_ (5 maximum)

**2. Determine the value of J:**

(a) Enter the following value:

*WSBIS 1533 MAIN SPAN DESIGN* \_\_\_\_\_

(b) Find the value of J:

- If *MAIN SPAN DESIGN* is 10, 12, 13, 14, 15, 16, or 17, then J = 5
- Otherwise, J = 0

**J** = \_\_\_\_\_

**3. Determine the value of K:**

(a) Enter the following coding values:

*WSBIS 1684 BRIDGE RAIL* \_\_\_\_\_  
*WSBIS 1685 TRANSITION* \_\_\_\_\_  
*WSBIS 1686 GUARDRAIL* \_\_\_\_\_  
*WSBIS 1687 TERMINAL* \_\_\_\_\_

(b) Find the value of K:

- If 2 of the above values are 0, then  $K = 1$
- If 3 of the above values are 0, then  $K = 2$
- If 4 of the above values are 0, then  $K = 3$

$K =$  \_\_\_\_\_

**4. Determine S4:**

$$S4 = I + J + K$$

$S4 =$  \_\_\_\_\_ (points range from 0 to 13)

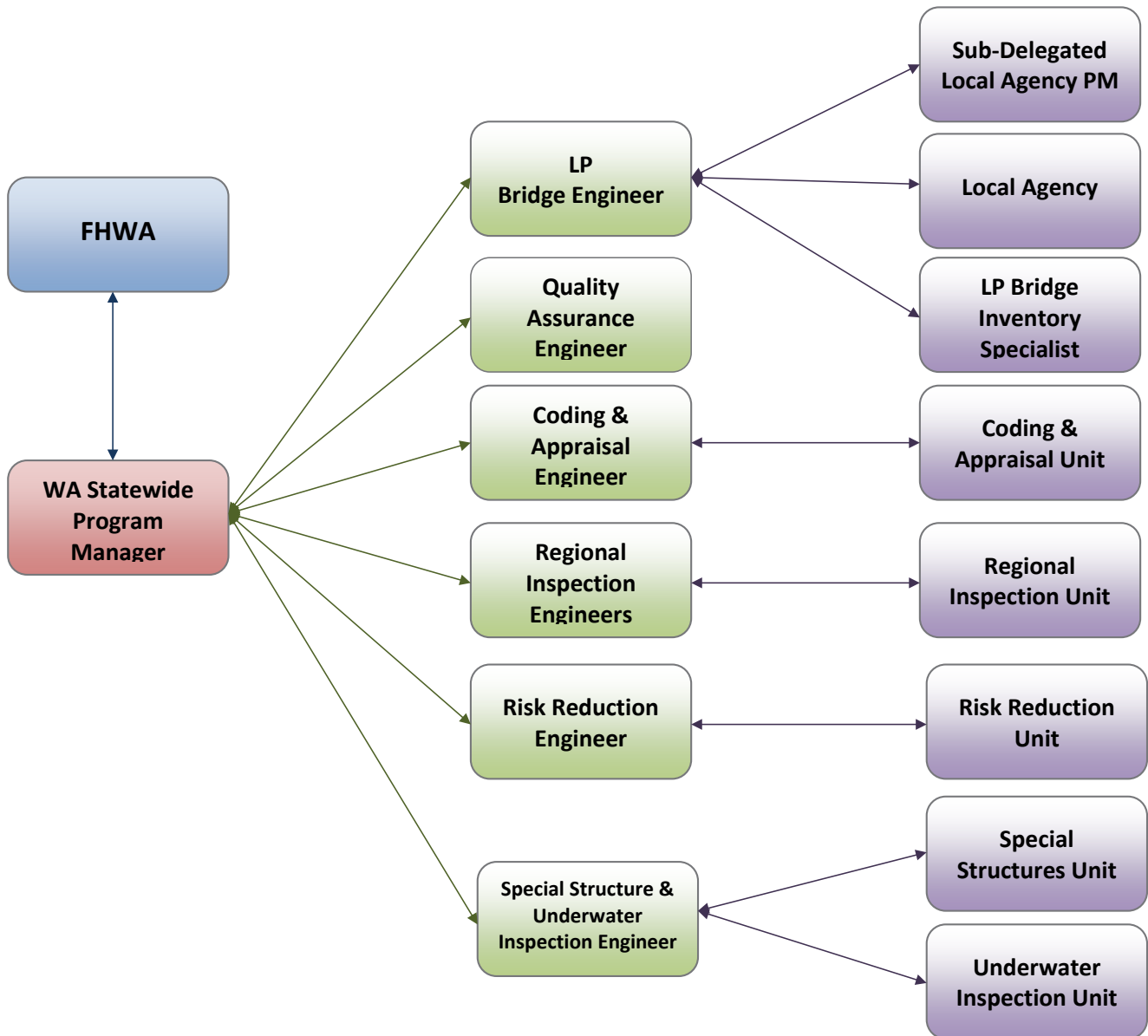



### 3.01 General

This chapter provides guidelines to inspect bridges, including documentation.

The guidelines presented herein are those in use by the WSDOT Bridge Preservation Office (BPO). Local Agencies are encouraged to follow these guidelines so as to provide a consistent basis for evaluation and reporting of inspection data. Coding for non-mandatory items may deviate according to the needs of an individual agency. Agencies are encouraged to document such deviations in a manner so as to aid in the evaluation of the associated inspection data.

The basis for bridge inspection policies and procedures are referenced throughout the chapter by the updated versions of the two following manuals: The AASHTO *Manual for Bridge Evaluation* (MBE), Section 4, provides uniformity in the procedures and policies for determining the physical condition, maintenance needs, and load capacity of the nation's highway bridges.

The FHWA NHI 12-049 *Bridge Inspector's Reference Manual* (BIRM) is a manual on programs, procedures, and techniques for inspecting and evaluating a variety of in-service bridges. It provides guidelines regarding what preparation is necessary, how to inspect, what to look for, what equipment and tools are needed, how to document the results of the inspections, and provide appropriate follow-up to the inspection.

### 3.02 Inspection Types and Reporting

A number of different types of inspections have been developed to address specific needs. This section will identify and describe the inspection types used by both the state and local agencies. Following is a summary description of the commonly used inspection types. Additional detailed information is provided in each referenced subsection in the remainder of the chapter.

**Routine (A)** – Routine Inspections are regularly scheduled inspections consisting of observations, measurements, or both, needed to determine the physical and functional condition of the bridge, to identify any changes from “Initial” or previously recorded conditions, and to ensure that the structure continues to satisfy present service requirements. Wading inspections are considered to be part of the Routine Inspection. The initial inspection is the first inspection of a bridge and is typically reported to the NBI as a Routine inspection. Routine Inspections are reported to the NBI.

**Fracture Critical (B)** – Fracture Critical members or member components (FCMs) are steel tension members or steel tension components of members whose failure would be expected to result in a partial or full collapse of the bridge (MBE 4.11). A Fracture Critical Inspection of steel bridges shall include the identification of all fracture-critical members and the development of a plan for inspecting such members. Fracture Critical Inspections are reported to the NBI.

**Underwater (C)** – An Underwater Inspection is the combined effort of soundings to locate the channel bottom, probing to locate deterioration of substructure and undermining, diving to visually inspect and measure bridge components, or some combination thereof. Underwater Inspections are reported to the NBI.

**Special Feature (D)** – Structures with Special Feature Inspections in Washington State are considered Complex bridges according to the NBIS. This inspection type is used for structures with unique design or construction such as movable bridges, floating bridges, suspension bridges and cable-stayed bridges and ferry terminals. Also included are bridges built with special materials such as high strength steel, and bridges that were built using techniques such as segmentally constructed post-tensioned concrete boxes and bridges with pin and hanger connections. Special Feature Inspections are reported to the NBI. See Appendix 3.06-D on FHWA letter for Bridge Special Feature Inspections.

**Interim (E)** – An Interim Inspection type in Washington State is referred to as a Special Inspection according to the MBE and is not reported to the NBI. This type of inspection is scheduled to monitor a known or suspected deficiency, such as foundation settlement, scour or significant member deterioration.

**Underwater Interim (F)** – Underwater Interim Inspections are similar to Interim Inspections where only a portion of the bridge or specific underwater elements are monitored more frequently than the full underwater inspection. Underwater Interim Inspections are not reported to the NBI.

**Damage (G)** – A Damage Inspection is an unscheduled one-time inspection to assess structural damage resulting from an environmental or human event. The scope of inspection should be sufficient to determine the need for emergency load restrictions or closure of the bridge to traffic, and to assess the level of effort necessary to define a repair. Depending on the specific situation, a Damage Inspection may be cause to initiate Interim inspections. This determination is typically made by the Team Leader or their supervisor. Damage Inspections are not reported to the NBI.

**Safety (H)** – This inspection type is utilized for structures crossing over public highways which could impact public safety, but are not reported to the NBI. These include railroads, pedestrian bridges, utility bridges, highway lids and tunnels. An Assistant Inspector who has 3 years of bridge condition inspection experience or the approval of their supervisor and has successfully completed a FHWA approved comprehensive bridge inspection training course can perform as a Team Leader for Safety Inspections.

**Short Span (I)** – This inspection type is used for bridges/culverts that have an opening of 20 feet or less. This is measured along the center of the roadway between undercopings of abutments, spring lines of arches, or extreme ends of openings for multiple boxes. Short Span bridges may also include multiple pipe culverts, but the clear distance between openings must be less than half of the smaller contiguous opening. Short Spans are not reported to the NBI. An Assistant Inspector who has 3 years of bridge condition inspection or the approval of their supervisor and has successfully completed a FHWA approved comprehensive bridge inspection training course can perform as a Team Leader for Short Span Inspections.

**cTwo Man UBIT (J)** – This inspection type is used when the UBIT, its driver and the UBIT operator are supplied to an outside agency by the BPO, but the responsibility for the inspection and reporting resides with the Team Leader. The sole purpose of this inspection type is to facilitate the scheduling of future inspections and the internal accounting and billing of current inspection work. This inspection type is not reported to the NBI.

**Informational (K)** – This report type is used as a means to add notes, data, files or photos to a report between scheduled inspections. Additionally the Informational Report can be used to change the inspection frequency if necessary or to just assign a next scheduled inspection date without having to change the normal inspection frequency. An Informational Report type does not involve field work and is typically used by inspection staff and the Bridge Information Group. Data that is updated through an Informational Report can be accessed from the SI&A report on BEIS. Depending on the type of data updated through an Informational Report, it may be necessary to print out and sign a new report for scanning into BEIS. This will be determined by the Team Leader and their supervisor. A typical example of an Informational Report that requires a signature is one that changes the NBI or Bridge Management System (BMS) codes. In these cases, a statement in the applicable area of the notes section of the report should state why the changes made were made. Informational Reports are not reported in the NBI. An Assistant Inspector who has 3 years of bridge condition inspection experience or the approval of their supervisor and has successfully completed a FHWA approved comprehensive bridge inspection training course can create an Information Report. This report type is not reported to the NBI.

**Inventory (L)** – This report type is used to create a bridge record for a new structure. An Inventory Report does not involve field work and is typically used by the Bridge Information Group. An Assistant Inspector who has 3 years of bridge condition inspection experience or the approval of their supervisor and has successfully completed a FHWA approved comprehensive bridge inspection training course can create an Inventory Report. This report type is not reported to the NBI.

**In-Depth (M)** – An In-Depth Inspection is a close-up, hands-on inspection of one or more members above or below the water level to identify any deficiencies not readily detectable using Routine Inspection procedures. It can also serve to supplement any inspection type.

**Geometric (N)** – This inspection type is used to collect vertical and horizontal roadway clearances for routes both on and under bridges and would also include a complete review and update of all the vertical clearance cards associated with the bridge. An Assistant Inspector can perform as a Team Leader for Geometric Inspections. Geometric data that has been collected using LIDAR can be used to update bridge inventory data as a Geometric Inspection as long as the Team Leader has reviewed the LIDAR data. This inspection type is not reported to the NBI.

**Unusual Circumstances** – Depending on the inspection type, bridges submitted to the NBI have regular inspection intervals that must adhere to the intervals as defined within the NBIS. When a bridge is inspected late, the agency must document a justifiable cause that pushed the inspection beyond the required interval. The justifiable cause, identified as an unusual circumstance in the preamble of the NBIS regulation,

should be documented within the inspection report. Some examples of unusual circumstances are as follows: severe weather, concern for inspector safety, concern for inspection quality, the need to optimize scheduling with other bridges, or other unique situations. The agency must also ensure that the next inspection is scheduled for the original inspection month during subsequent inspection cycles.

## A. Routine

1. **Initial Routine Inspection** – The first routine inspection performed on any bridge is the Initial Routine Inspection. An Initial Routine Inspection is also performed after rehabilitation work that changes a bridge's dimensions or clearances, or when there is a change in bridge ownership.

The purpose of this inspection is to add the bridge to the inventory of bridges and to establish certain baseline information.

- a. **Gathering Inventory Data** – Establishing baseline information about the bridge from the original construction plans or as-built plans can be performed in the office prior to the site inspection. Agencies shall record the required WS BIS data into BridgeWorks along with the applicable Bridge Management System (BMS) elements for the structure. Any information not known or which cannot be determined from the plans can be left blank until the site inspection.

Depending on the type of structure built, one or more of the following inspection types may also be required to be performed with the initial inspection:

- A Fracture Critical Inspection if the bridge contains fracture critical members, see Section 3.02.B.
- An Underwater Inspection is needed to inspect underwater portions of the bridge, see Section 3.02.F.
- A Special Features inspection if the bridge contains unique design or construction elements, see Section 3.02.D.

Conclusions and findings from these items should be incorporated into the Bridge Inspection Report (BIR) to support the applicable codes and ratings.

Team Leaders should coordinate the planning and timing of the inspection with the appropriate project or construction offices prior to visiting the site.

- b. **Site Inspection** – After the bridge has been built, and preferably before it is placed into service, the Team Leader must visit the bridge site to verify the inventory information that has been coded and to establish any information that was not known. At the bridge site, the Team Leader can review the information to confirm the actual bridge dimensions and clearance measurements and to verify the condition of all bridge elements.

Changes or additions to the WS BIS data, the BIR form, or BMS elements, must be noted on the inspection form and entered into BridgeWorks.

- c. **Check Coding** – The BIR form should note any inconsistencies found between the planned and the as-built bridge and should provide an explanation of any coding changes made. For example, if surface cracks have been found in a newly-poured bridge deck but these cracks do not warrant lowering the



condition coding for the deck, the Team Leader should note the location and extent of the cracking so that it can be looked for and further evaluated during future inspections.

As part of the Initial Routine Inspection, two photographs of the bridge shall be taken: an elevation and a deck photograph. The elevation photograph should be taken (looking north or east) when possible to show a view from one side of the bridge. The deck photograph should be taken (ahead on station) to show a view of the bridge looking onto the bridge deck.

See Section 3.02.A.2 for instructions on completing the remainder of the BIR form.

- d. **Updating the Bridge File** – The Inventory Record, the BIR, and the two photographs provide a record of the Initial Routine Inspection. In addition to being stored within BridgeWorks, these items must be placed in the bridge file created for the given bridge. Each time the bridge is revisited, additional inspection reports, any new photos, and any updates to the WSBS and to the BIR form are added to the file so that the bridge records remain current. See Section 2.02 for further details.
2. **Routine Inspections** – Generally, a regular inspection of the entire bridge is to be performed on regular intervals not to exceed 24 months throughout the life of the bridge. However, the NBIS does allow for extended inspection frequencies of up to 48 months provided the bridge meets specific criteria submitted by the State and approved in writing by the FHWA. Inspection intervals less than 24 months for specific reasons can be developed and documented by the inspecting agency if necessary.
    - a. **Inspecting Bridge Components** – The BIRM describes the general inspection procedures to be followed for inspecting any concrete, steel, or timber bridge, and the specific procedures to follow for inspecting a given bridge element (i.e., the bridge abutments). These steps can be used by the Team Leader as a checklist to help accomplish the inspection and to help spot particular types of problems a given bridge or bridge element will be prone to. Following these procedures will help ensure that a thorough and comprehensive inspection is achieved.

However, specific problems not covered in these general procedures may be encountered. If that is the case, the Team Leader may contact their respective WSDOT Bridge Program Support personnel.
    - b. **Inspecting for Scour** – The Routine Inspection of any bridge over water should include an assessment of existing scour conditions, the effect of scour on the bridge, effectiveness of countermeasures, and recommendations for repair, if appropriate. The following manuals, as well as the BIRM, discuss inspection procedures for bridges over water:
      - *HEC 18 Evaluating Scour at Bridges*

The field inspection is used in conjunction with the scour analysis, see Section 5.03, to identify and verify the potential of harmful effects of scour to the bridge.

The field inspection includes the specific location and extent of any deterioration, damage, or undermining in:

- The stream channel and stream banks.
- The substructure elements (i.e., intermediate piers, pier walls, web walls, columns, or shafts).
- The foundation (i.e., footings and seals).
- Channel protection devices (i.e., dams and levees).
- Scour countermeasures (i.e., riprap or shielding).

Measure and record the extent of foundation exposure and undermining.

Recommend any repairs, replacement, or maintenance required.

Perform soundings on bridges as identified by the Scour Engineer using the Scour Field Evaluation form.

The Scour Field Evaluation form was developed to supplement the BIR for water crossings by measuring the streambed cross-section (soundings) at a bridge to document observations related to scour. A copy of this form is shown in Section 3.05.

Soundings of streambed elevations should be taken during the Initial Routine Inspection and during subsequent inspections as required. The form should note the location and depth of the streambed at each point where a sounding was taken. This information should then be plotted in order to identify long term changes in the channel cross section over time.

- c. **Bridge Inspection Report** – A Bridge Inspection Report must be prepared at the completion of each Routine Inspection to record the inspection findings, provide a narrative description of conditions at the bridge site, and note any changes in the WSBS coding information. The Team Leader shall record and submit the findings of the Routine Inspection into BridgeWorks. A Routine Inspection will be included with a Fracture Critical Inspection and a Special Feature Inspection. Bridge Inspection Reports must be completed within 90 days from the start of the inspection. A completed report is defined as a report that has been “Released” in the BridgeWorks program.

The Bridge Inspection Report form will have the following preprinted information that will identify the bridge:

- **Bridge Number** – The bridge number given by the owner agency that is associated with the particular structure.
- **Bridge Name** – The bridge name given by the owner agency that is associated with the particular structure.
- **Structure ID** – The unique federal structure identification number associated with the particular structure in the NBI assigned by WSDOT for the life of the bridge.
- **Route** – The number of the inventory route carried on or under the bridge.
- **Milepost** – The bridge’s milepost location on the inventory route.
- **Intersecting** – The feature or features which intersect with the bridge.

- **Location** – The physical location of the bridge.
- **Structure Type** – The structure type (for local agency bridges, this field may be blank).

d. **Completing the Bridge Inspection Report**

- (1) At the conclusion of the Routine Inspection, confirm the condition and adequacy coding for the various bridge elements and make any changes as necessary. Review the Adequacy Appraisal codes, NBI condition codes, BMS elements and their respective condition states, and complete the narrative describing the existing conditions. Verify that the correct Program Manager is listed on the inspection report.
- (2) Enter onto the inspection report: Team Leader initials, Team Leader identification number, Assistant Inspector initials, date of inspection, and total number of crew hours at the bridge site. The Team Leader and Assistant Inspector are required to sign the approved and released copy of the BIR that is placed in the bridge file.
- (3) Prepare a list of any bridge elements in need of repair and recommend the type of repair that should be done. A photo of repair areas should be taken with each type of recommended repair. See Section 6.04 for additional repair instructions and procedures.
- (4) If it is determined that a critical bridge deficiency has been identified resulting in an emergency load restriction, lane closure, bridge closure or a failed bridge, a Damage Inspection and/or a subsequent In-Depth Inspection may have to be performed, see Section 3.02.G for Damage Inspections, and Section 3.02.M for In-Depth Inspections.

e. **Updating the Inventory Record** – Any changes that need to be made to the Inventory Record shall be entered into BridgeWorks.

After the data is processed and updated, a new Inventory Record is generated for each bridge that has changes. On all Routine Inspections, all changes/updates to NBI data shall be released into the inventory within 90 days of the date of inspection.

The updated SI&A Report and other applicable reports shall be filed in their respective bridge file.

3. **Routine Inspections with Extended Intervals** – Routine Inspections with extended inspection intervals are structures with inspection frequencies greater than 24 months not exceeding 48 months, and only with written FHWA approval. Reportable structures that have administrative load ratings (WSBIS ITEM NUMBERS 1551 & 1554 = 0) are not eligible for 48 month frequencies.

The criteria approved by FHWA shall be re-evaluated after every inspection. Refer to the WSDOT letter sent to FHWA, dated July 28, 1998, see Appendix 3.06-C for further details. Team Leaders for the State shall place the following note in the zero (0) note of the BIR within BridgeWorks for existing extended interval bridges and candidate bridges:

“Continue to validate the status of this bridge each inspection as a 48-month inspection candidate. Verify condition ratings, load ratings, vertical clearances, ADT, scour codes when applicable, and that no major maintenance has been completed in the last two years.”

The procedures and guidelines used for Routine Inspections at 24 month intervals shall be used for these structures as well.

4. **Routine Inspections with Frequencies Less than 24 Months** – Bridges or culverts should be considered for an increased inspection interval if the NBI Superstructure, Substructure or Culvert code is equal to or less than a 3 and where there are multiple elements with deficiencies that reduce capacity. The SPM will approve the need to perform routine inspections more frequently than 24 months.

## **B. Fracture Critical**

The National Bridge Inspection Standards (NBIS) require that a Fracture Critical Inspection be performed on regular intervals not to exceed 24 months on bridge members identified as fracture critical. According to the MBE, a fracture critical member is a steel tension member in a bridge whose failure could result in the partial or total collapse of the bridge.

This section provides information to assist the Team Leader in identifying fracture critical bridge members, preparing written procedures, planning and performing effective Fracture Critical Inspections and completing the required inspection report. The information presented here is meant as a summary of the main points of the Fracture Critical Inspection. A complete description of fracture critical members and Fracture Critical Inspection procedures are provided in the BIRM.

1. **General** – Each agency shall identify the bridges within its jurisdiction which contain fracture critical members. The agency can then identify, through documentation, the particular fracture critical members within each bridge. For the member to be considered fracture critical, two conditions must exist.
  - a. The member must be a steel member in tension. The area of the bridge where the member is located is subject to tensioning (expanding) forces.
  - b. There is no redundancy in the member or the bridge. There must be no other structural elements able to carry the load of the member if the given member fails.

There are three types of redundancy: load path, structural, and internal. Only load path redundancy is evaluated to determine whether a member is fracture critical. Load path redundancy is the number of supporting elements, usually parallel, such as girders or trusses. AASHTO neglects structural and internal redundancies in determining whether a member is fracture critical. For a bridge to be redundant, it must have more than two load paths. An exception to this is where steel three girder systems have pin and hangers. In this case, the pin and hangers are fracture critical.

2. **Bridge Types** – The following is a list of the types of bridges in which fracture critical members will be found. Figures are also shown which illustrate these bridge types and note the location of the fracture critical areas.

a. **Steel Two-Beam or Two-Girder Systems (Figure 3.02.B-1)**

- (1) **Simple Spans** – Each beam or girder should be considered fracture critical as failure of either one could cause the bridge to collapse (Example A).
- (2) **Continuous Spans** – In general, at the midpoint of the span, the bottom of the girder should be considered fracture critical and over the pier, the top of the girder should be considered fracture critical. A structural engineer may need to assess the bridge to determine the actual redundancy and presence of fracture critical elements (Example B).
- (3) **Cantilever-Suspended Span** – In addition to the bottom of the girder at mid-span and the top of the girder over the pier, the top flange and adjacent portion of the web in the area of the cantilevered support should be considered fracture critical (Example C).

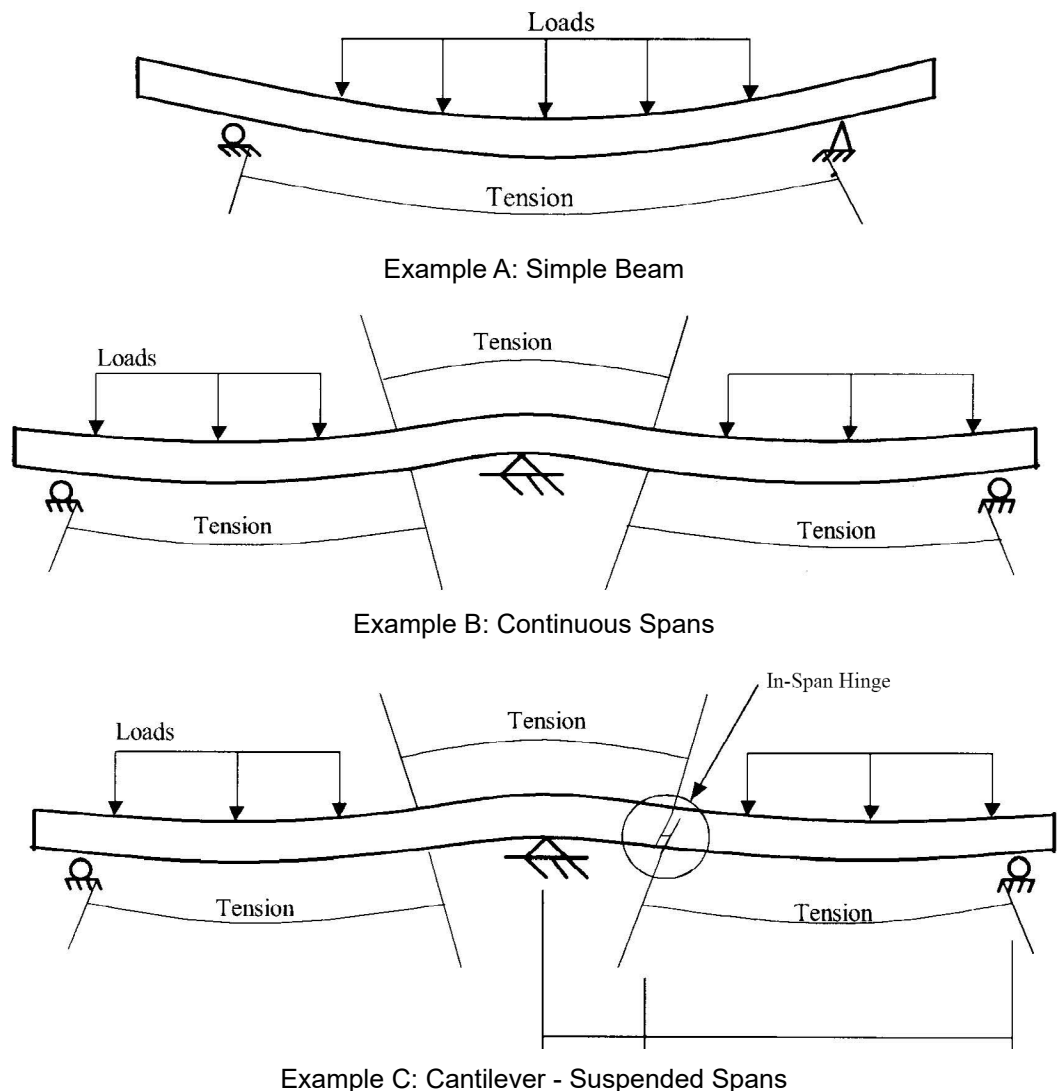
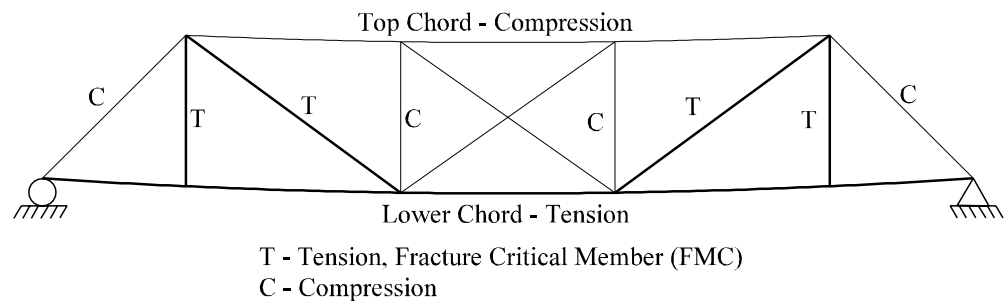

**Figure 3.02.B-1**

- b. **Steel Truss Systems (Figure 3.02.B-2)** – Most truss bridges employ only two trusses and are thus considered fracture critical. All truss members in tension should be regarded as fracture critical. The exception is, when a detailed analysis by an experienced structural engineer, verifies loss of a member would not result in collapse of the bridge or major component.

The following elements within any truss bridge should also warrant special attention:

- (1) **Pin-Connections** – Any load bearing pin connection in a fracture critical member or steel three girder system is considered fracture critical.
- (2) **Category D and E Welds** – On a truss bridge, any tension member containing a Category D or E weld.



**Figure 3.02.B-2**

- c. **Tied Arches (Figure 3.02.B-3)** – The tie girder which keeps the supports from spreading apart is in tension and should be considered fracture critical.

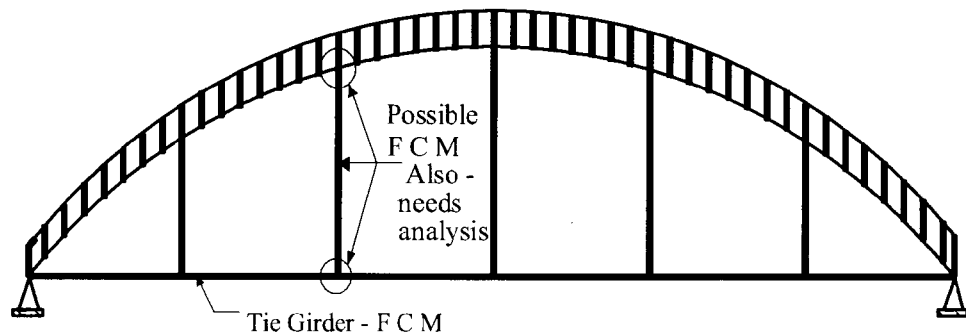

**Figure 3.02.B-3**

d. **Suspension Spans (Figure 3.02.B-4)**

- (1) **Cables** – If the main suspension member is a cable, the cable should be considered fracture critical (Example A).
- (2) **Cable Stayed Bridge** – The bridge is of such complexity that it should be reviewed by a structural engineer to determine the criticality of the various stays to fracture (Example B).

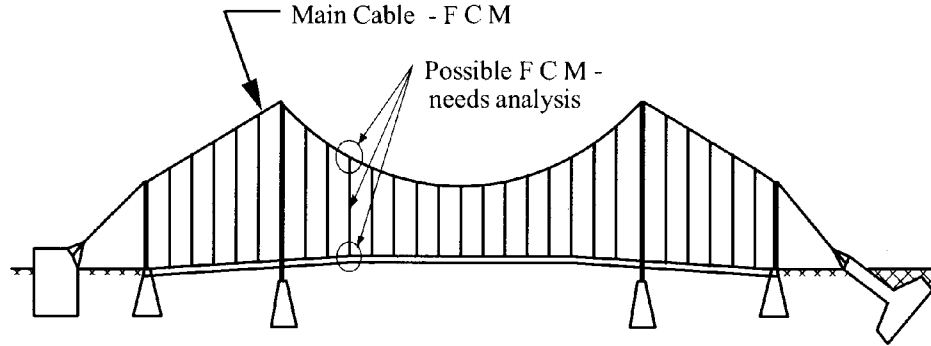

Example A: Cable Suspension Bridge

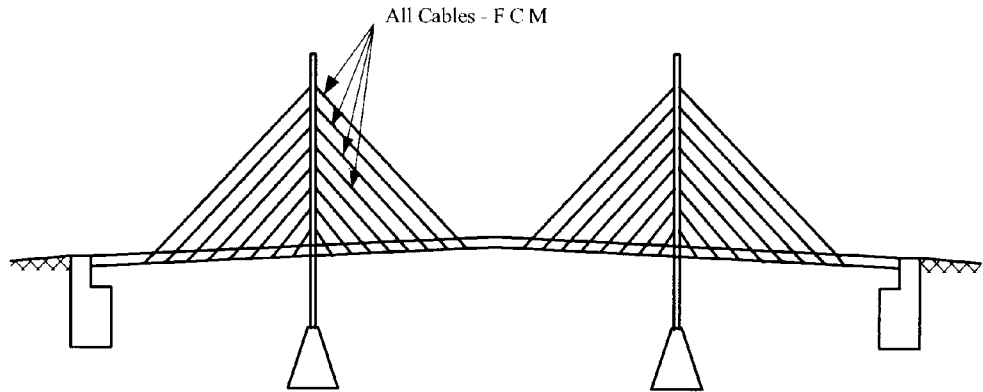

Example B: Cable Stayed Bridge

**Figure 3.02.B-4**

e. **Other Fracture Critical Bridge Details**

- (1) **Steel Cross Beams and Caps** – Tension zones of the I section or box beam should be considered fracture critical (Figure 3.02.B-5).

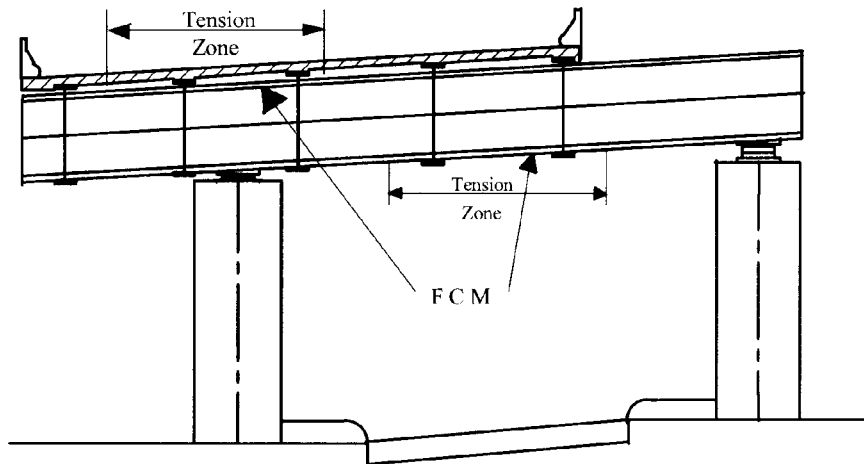

**Figure 3.02.B-5**

- (2) **Pin and Hanger Supports** – The pin and hanger connection used to support a suspended span from a cantilever span should be considered fracture critical if the member is non-redundant. The pin connection and hanger support in a two-girder or three-girder system is fracture critical as the bridge has no built in redundancy. The same connections in a multi-beam system (more than 3 beams) are not fracture critical as the bridge has a high degree of redundancy. Pin connections in such bridges should be inspected with the same techniques and methods as fracture critical pins (Figure 3.02.B-6).

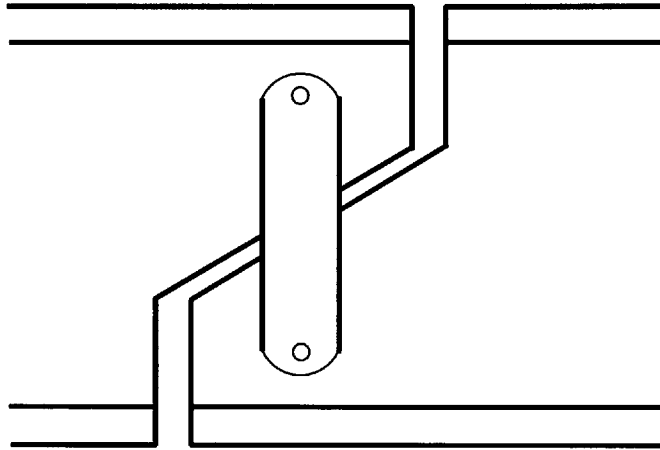

Figure 3.02.B-6

3. **Prepare Written Procedures** – Once the fracture critical members within a bridge have been identified, the agency must prepare a detailed plan as to how it will accomplish the Fracture Critical Inspection. This written procedure may be developed by others being hired to perform the Fracture Critical Inspection. However, if this is done, a qualified designee from the owner agency should carefully review the written plan to ensure that a sufficient analysis of the member will be made and that the task will be accomplished in a reasonable manner. These written inspection procedures are to be kept in each bridge file.

Fracture Critical Inspections can prove costly; therefore, in the development of the inspection plan, particular attention should be given to each of the following:

- a. **Scheduling** – Generally, it will be best to schedule a Fracture Critical Inspection during cold weather (as cracks will be more visible), at low water (if the fracture critical member is underwater at high water), during daylight hours, and when traffic on the bridge will be lightest (as some form of traffic control may be necessary).
- b. **Equipment** – The Team Leader will require close access to each fracture critical member; thus, some type of equipment may be needed to provide sufficient access. Ladders, scaffolding, aerial work platforms, or UBITs may be deemed appropriate for a given situation. The choice of equipment will depend on the cost of rental, the time needed to perform the inspection using that equipment, and equipment availability. If a UBIT is used, it should be determined, before its use, whether it could overload the bridge, operate on the bridge grade, has sufficient reach, and if it might damage the deck. Use of a UBIT may also create a need for traffic control.



- c. **Workforce** – In order to keep the amount of time spent at the bridge site to a minimum, consideration should be given to the level of manpower needed. Once the number of individuals needed is determined, the duties to be performed by each individual should be clearly defined.
- d. **Tools** – The standard tools common to any Routine Inspection should be on hand for the Fracture Critical Inspection. In particular, a wire brush, a magnifying glass, and a light source able to provide 50 to 100 lumens should be considered. In addition, specialized tools for carrying out nondestructive testing may also be warranted (i.e., a dye penetrant kit or ultrasonic testing device).
- e. **Inspection Procedures** – The fracture critical member inspection plan should identify the inspection frequency and method(s) to be used. These should be developed depending on the criticality of the feature based on experience with other similar details or structures, calculated remaining fatigue life, current indications, material properties, consequences and likelihood of rapid failure, etc.

If several types of inspection are employed, identify when, where and how they are to be used. For example, a pinned truss bridge may require each of the pins to be examined visually during each inspection, supplemented by ultrasonic testing of 1/3 of the pins during each inspection. Therefore, all of the pins would be inspected ultrasonically in a 72-month period, if the inspection frequency was 24 months.

4. **Perform the Fracture Critical Inspection** – The purpose of the Fracture Critical Inspection is to assess the structural condition of each bridge member identified as fracture critical. When inspecting these members, it is always best to err on the side of conservatism. The consequences of dismissing or failing to note a blemish on a fracture critical member are too great. Therefore, the inspection should be conducted carefully and thoroughly. Such close inspection of single members can be tedious; however, the Team Leader should work in a manner that insures the same degree of care and attention to the last area inspected as the first. The previous pages described the general areas within a bridge where fracture critical members will be located. The following pages describe the particular features to note.

First, the Team Leader must gain access to the fracture critical area. The Team Leader should be no further than 24 inches from the surface being inspected and should work with a light source of at least 50 to 100 lumens. The best viewing angle is at approximately 120°. The Team Leader will want to look for deteriorated surfaces or surface cracks. The BIRM discusses inspection procedures and the types of problems that may be found.

The following areas or members should be checked:

- Areas vulnerable to corrosion (under deck joints, on surfaces where water collects and in places where dissimilar materials meet).
- Areas where there is a change in the bridge cross section, where stress is concentrated, or which show out-of-plane bending.
- Web stiffeners (especially at the ends).

- Coped sections and/or re-entrant corners.
- Eyebars.
- Shear connectors.
- Pin and hanger assemblies.
- Punched holes.
- Rivet and bolt heads.
- Tack welds and field welds (especially at weld ends or returns).

If any cracks, blemishes, or other irregularities are found, the Team Leader will need to evaluate these further, which may include the use of a magnifying glass. A dye penetrant kit can be used to establish the limits of a crack. Use of magnetic or ultrasonic testing devices may be required to detect internal problems not apparent to the eye. The agency will need to determine which devices will be the most cost effective and reliable for the given situation.

Finally, the Team Leader will need to record the location and size of any cracks found. Mark and date the crack ends in permanent marker for follow up on the structure. In most cases, it will be helpful to take a photograph of such cracks to provide visual documentation. This information and the photographs are to be included in the Visual Fracture Critical Inspection Report.

5. **Prepare the Visual Fracture Critical Inspection Report** – At the conclusion of the Fracture Critical Inspection, a Visual Fracture Critical Inspection Report should be prepared to provide detailed verification of the inspection findings. The report should provide qualitative and quantitative information concerning the fracture critical member. This information is important for a number of reasons: it can offer insight about the condition of the member, it can provide a history of the bridge, and it can be used to substantiate the thoroughness of the inspection effort in the event of litigation arising from a bridge failure. See Section 3.05 for a copy of the Visual Fracture Critical Inspection Report form.

The inspection report should:

- Identify what parts of the bridge were inspected and the location of each fracture critical bridge member. (This can be shown on a photograph or sketch of the bridge.)
- Describe the procedures followed to inspect the fracture critical member.
- Describe the condition of the fracture critical member.
- Provide the following details about any defects found:
  - What the defect is.
  - Where the defect is located (a sketch may be used to illustrate its location relative to the ends of the member, and its position in the cross section of the member).
  - Summarize the inspection findings (addressing how individual defects affect the member's overall condition).
  - Make any appropriate recommendations (i.e., repair the fracture critical member, recalculate load ratings, close the bridge).

6. **Updating the Inventory Record** – Any changes that need to be made to the Inventory Record shall be entered into BridgeWorks.

On all Fracture Critical Inspections, all changes/updates to NBI data shall be released into the inventory within 90 days of the date of inspection.

7. **Updating the Bridge File** – Place the signed and completed Visual Fracture Critical Inspection Report within the bridge file. This report can be referred to if necessary to help determine the appropriate inspection frequency for the bridge, evaluate the degree to which bridge conditions have changed from one inspection to the next, and determine what maintenance or repair may be required on the bridge.

### **C. Underwater**

Bridges over water have special inspection requirements. If the bridge has members in water too deep to permit a visual or tactile (hands-on and/or wading) inspection from the surface at low water or during seasonal low stream flows, an underwater bridge inspection diver must conduct an Underwater Inspection. An evaluation of the bridge's susceptibility to scour also needs to be conducted, see Section 5.03. Many bridge failures are due to underwater or scour problems; therefore, the importance of these types of inspection cannot be overemphasized. There may be environmental restrictions that need to be taken into consideration prior to conducting an Underwater Inspection.

An Underwater Inspection of submerged bridge elements is required on an interval not to exceed 60 months. The purpose of the Underwater Inspection is to examine the underwater elements to the extent necessary to determine their structural condition and adequacy. At a minimum, an underwater bridge inspection diver must swim by and examine all underwater portions of the bridge. If the underwater elements are covered with marine growth, portions of the structure need to be cleaned in order to positively ascertain the condition of the element. For concrete piers, this consists of cleaning 1 square foot patches near the surface, mid height, and bottom of all piers. For multiple pile bents, a one foot band must be cleaned near the surface, mid-height and bottom of one pile per bent, but no less than 10 percent of the piles. The underwater bridge inspection diver must also perform a visual or tactile inspection of the entire bridge footing at ground line to identify if any undermining of the footing exists, as well as probing to determine if scour holes are being filled in. If significant problems are encountered during the course of the inspection, a more detailed inspection of the bridge may be needed.

Existing scour conditions must be evaluated during an Underwater Inspection. The Team Leader must assess condition and depth of the streambed, determine the susceptibility of the streambed to scour, and determine what countermeasures can be taken to safeguard the bridge. The primary requirement of the scour inspection is to establish a cross-section of the streambed. This is accomplished by sounding and can be carried out with either a fathometer (also known as a "fish finder") or a lead line. See the BIRM and the MBE for guidance on performing Underwater Inspections.

1. **Prepare Written Procedures** – Written inspection procedures need to be developed for each bridge requiring an underwater inspection. The inspection plan should detail as a minimum:
  - Type and frequency of required inspection.
  - Location of members to be inspected.
  - Type(s) of foundation.
  - Bottom of foundation elevation or pile tip elevation.
  - Identification of scour critical substructure units.
  - Special equipment requirements.
  - Follow-up actions taken on findings of last inspection.
2. **Document the Underwater Inspection** – Prepare a Daily Site Dive Log for each dive and prepare an Underwater Inspection Report when inspection of the entire underwater portion of the bridge is concluded.
  - a. **Daily Site Dive Log** – The Daily Site Dive Log must be completed by the inspection Team Leader (in concert with the diver). Section 3.05, provides a sample of the Daily Site Dive Log form. The form should summarize what equipment was used in the dive, what procedures were employed, what problems were encountered (such as strong currents or underwater obstructions or accumulations of debris), and should provide any information which may be helpful for planning future dives. At the conclusion of every dive, the diver must go over the inspection findings with the Team Leader in order to verify that the notes taken by the staff on the surface are a correct representation of what the diver found. The diver should also go over all underwater photos, making sure that the photo numbers and descriptions are correct.
  - b. **Underwater Inspection Report** – The Underwater Inspection Report must be completed by the underwater inspection Team Leader and reviewed by the diver. The report should be thorough and include the following information for the various levels of inspection performed.
    - (1) For a Routine Underwater Inspection, note:
      - What conditions were found as a result of the visual inspection or cleaning.
      - The condition of any protective coatings.
      - Evidence of any significant defects or damage.
      - Evidence of scour or the build-up of debris at the piers.
      - The location of exposed foundation elements.
      - Ground line elevations at the base of all piles or pile groups, elevations of the tops of all exposed footings and/or seals, and ground line elevations of all footings or seals at their corners.
      - The condition of the streambed around each pier, including a description of any placed rock.
      - The water flow (whether high, medium, or low) and an approximation of the velocity (ft/sec.).

- The influence of any significant environmental conditions (i.e., corrosive pollutants, salt water, etc.).
  - Any changes to the surrounding area which have or may alter the flow characteristics around the pilings or piers (i.e., logs upstream, construction going on nearby).
  - Any discrepancies between the bridge design and its actual configuration.
  - Any recommendations for repairs, a subsequent scour inspection, a change in inspection frequency, or an in-depth inspection.
- (2) For an Interim Inspection, note:
- The specific areas inspected.
  - The amount and type of testing performed.
  - Testing results and/or findings.
  - Any recommendations for repair

In addition to the written information provided in the Underwater Inspection Report, problem areas in the bridge should be carefully identified and documented with drawings, photographs, and/or video recordings. Although underwater photos and video recordings are often preferred, they may not always offer clear views of the problem areas so sketches and drawings are always needed to document findings.

3. **Updating the Inventory Record** – Any changes to the applicable inventory coding information (the date of underwater inspection, Team Leader initials, inspection hours and changes to the condition coding for the substructure) shall be entered so that the Inventory Record can be updated accordingly. On all Underwater Inspections, all changes/updates to NBI data shall be released into the inventory within 90 days of the date of inspection.
4. **Updating the Bridge File** – The completed Underwater Inspection Report and an updated copy of the Inventory Record shall be placed in the bridge file. These reports can be referenced to as necessary to help determine the appropriate inspection frequency for the bridge, to evaluate the degree to which bridge conditions have changes from one inspection to the next, and to determine what maintenance or repair may be required.

#### **D. Special Feature**

Bridges with special features include structures such as movable bridges, floating bridges, suspension and cable-stayed bridges, and ferry terminals. Also included are bridges built with special materials such as high strength steel, and bridges that were built using techniques such as segmentally constructed post-tensioned concrete boxes. Bridges with pin and hanger connections are also considered to be special feature bridges. Written procedures must be developed and included in the bridge file for all Special Features Inspections. Procedures should include:

- Type, detail, and frequency of required inspection.
- The location of members to be inspected.
- Special equipment required.

The first four bridge types listed below are considered “Complex Bridges” according to the NBIS. The remaining types are inspected as suggested by FHWA. Special Feature Inspections are performed on regular intervals not to exceed 24 months.

1. **Movable Bridges (Code ‘1’ in BridgeWorks)** – There are three basic types of movable bridges: vertical lifts, bascules, and swings. All of these structures are operated by either electro-mechanical drive systems or hydraulic systems. See the BIRM and the MBE for guidance on performing inspections on movable bridges.
2. **Suspension Bridges (Code ‘3’ in BridgeWorks)** – Suspension bridges consist of a pair of main cables hanging between and passing over two towers and anchored by backstays into large counterweights on opposite shores. Suspender ropes hang from the main cables and support a pair of stiffening trusses or girders that run the length of the suspended spans. The stiffening trusses or girders support floor beams, stringers, and a roadway deck. Orthotropic decks may be used in place of the stringers and roadway deck. See the BIRM and the MBE for guidance on performing inspections of suspension bridges.
3. **Cable-Stayed Bridges (Code ‘9’ in BridgeWorks)** – Cable-stayed bridges are very distinct structures with many unique details that require special inspection. On a cable-stayed bridge the longitudinal structural components that support the road deck are supported by inclined cables or stays that extend directly into anchors or saddles in one or two towers. One cantilevered component is balanced by another cantilevered component on the opposite side of the support tower. Typically, the deck is anchored to the ground in at least one spot to resist seismic forces and any unbalance in the cantilevered spans. See the BIRM and the MBE for guidance on performing inspections on cable-stayed bridges.
4. **Segmental Bridges (Code ‘5’ in BridgeWorks)** – Segmental bridges are unique due to their construction. A segmental girder is a single or multiple box girder that is formed from segments post-tensioned together. This type of construction takes advantage of the standardization of the manufacturing process. See the BIRM and the MBE for guidance on performing inspections of concrete segmental bridges.
5. **Floating Bridges (Code ‘2’ in BridgeWorks)** – Floating bridges in Washington State consist of concrete pontoons that are bolted together longitudinally and are held in position by steel cables connected to anchors on the bottom of the waterway. Some of the bridges are reinforced with prestressing steel. Two of Washington State’s floating bridges contain movable spans that have unique operating characteristics.
6. **Ferry Terminals (Code ‘6’ in BridgeWorks)** – Ferry Terminals (Code ‘6’ in BridgeWorks) – Ferry terminals usually have a dock or holding area built over the water and a transfer span to carry traffic onto the ferry deck. The holding area can be constructed of treated timber, concrete, or steel components. The vehicle holding area or “dock” is typically considered a standard bridge structure and receives a Routine and Underwater Inspection. The transfer spans generally are steel trusses or girders with one end supported on the fixed pier and a free end which can be raised or lowered onto the boat to accommodate tidal changes. Transfer spans typically have their own structure I.D. and these structures are the ones with unique features which require the “Special Feature” inspection. Ferry

Terminal transfer spans have enough unique features that specific BMS elements and inspection procedures have been developed to help the inspector navigate through a ferry terminal inspection. The *Ferry Terminal Inspection Procedures Manual* is published as a stand-alone document and can be found as publication M 3105 at [wwwi.wsdot.wa.gov/Publications/Manuals/M3105.htm](http://wwwi.wsdot.wa.gov/Publications/Manuals/M3105.htm)

7. **Pin and Hanger Connections (Code ‘4’ in BridgeWorks)** – A pin and hanger is a system used to connect suspended spans to cantilevered spans. The hanger is connected to a beam or girder by a pin on one or both ends. In two-girder and three-girder systems, the pin and hanger connection is fracture critical. Even when used in a multi-beam system where the bridge has a high degree of redundancy, the connection should still be inspected as closely as any fracture critical element. This is due to problems experienced in other states with pins in multi beam suspended spans. See the BIRM and the MBE for guidance on performing inspections of pin and hanger assemblies.
8. **A-514 High Performance Steel (Code ‘7’ in BridgeWorks)** – A-514 steel is used in high stress areas of larger steel bridges to reduce member size and total weight of steel. A typical location would be the top and bottom flanges of plate girders over the intermediate piers.

Bridges fabricated from A514 steel have suffered from hydrogen cracks which occurred during fabrication. Also, higher strength steels generally are subject to larger stress ranges than the lower strength steels. In tension zones, cracks may initiate and propagate faster than in the lower strength steels. It is important that Team Leaders check tension zones closely for cracks particularly at welds, bolt holes, copes, and other fatigue prone locations.

The Team Leader and Assistant Inspector are required to sign the approved and released copy of the Special Feature Report that is placed in the bridge file.

## E. Interim

Special inspections as defined in the MBE are called Interim inspections in the state of Washington. This inspection type is scheduled when a particular known or suspected deficiency needs to be monitored between Routine Inspections. Interim Inspections are not reported in the NBI.

1. **Identifying Need** – The Interim Inspection is performed to monitor a particular known or suspected deficiency and is carried out between regularly scheduled Routine Inspections. For example, if noticeable settling has occurred in the foundation, or if a particular bridge member shows signs of rapid deterioration. The Team Leader should observe and monitor this condition to determine the effect on the bridge or the danger posed to the bridge. Bridges or culverts should be considered for an Interim Inspection if the NBI Superstructure, Substructure or Culvert code is equal to or less than a 3.

The inspection interval may vary depending on the type of deficiency being inspected. Interim Inspections may occur between regularly scheduled Routine Inspections on 24 month intervals, typically on the off year of the Routine Inspection. There are cases where Interim Inspections may occur several times during a calendar year on three or six month intervals. The inspecting agency along with the Team Leader will determine the appropriate inspection interval.

Consider performing an Interim Inspection for load posted bridges. The Interim Inspection should occur in the year that the Routine Inspection is not due.

2. **Performing Inspection** – The Team Leader is free to schedule an Interim Inspection as the need arises. This type of inspection can be accomplished by any Team Leader who has some familiarity with the bridge. If someone other than the Team Leader who performed the Routine Inspection is scheduled to perform the Interim Inspection, they should be carefully instructed as to what to look for, what measurements to take, what results might be expected, and/or how the problem can affect the structural integrity of the bridge.
3. **Reporting** – A BIR documenting the inspection findings should be prepared by the individual who performed the inspection. Any of the following information may be appropriate to include:
  - The date of Interim Inspection.
  - The Team Leader’s name.
  - The applicable inspection interval.
  - The location of the element or elements inspected.
  - Any measurements taken.
  - The procedures utilized to analyze and assess the given bridge element(s).
  - The results of any testing performed.
  - Any recommendations for maintenance or repair.
4. **Updating the Inventory Record** – Any changes that need to be made to the Inventory Record shall be entered into BridgeWorks. The Routine inspection date should not be changed due to an Interim Inspection. On all Interim Inspections, all changes/updates to NBI data shall be released into the inventory within 90 days of the date of inspection
5. **Updating the Bridge File** – A copy of the report and an updated copy of the Inventory Record (if applicable) must be placed in the bridge file at the completion of the Interim Inspection and must be cross referenced to the current Bridge Inspection Report.

## ***F. Underwater Interim Inspection***

This inspection type is scheduled when a particular known or suspected deficiency needs to be monitored between the regularly scheduled Underwater Inspections. Underwater Interim Inspections are not reported in the NBI.

1. **Identifying Need** – Common examples of findings requiring a change in the Underwater Inspection frequency are extensive scour or rapidly progressing deterioration. For example, spread footings normally buried and not visible for inspection which become exposed, or pile founded footings which become undermined need to be monitored closely. Foundation deterioration or damage may also warrant a visual inspection at a frequency less than the mandatory 60 months. Bridges should be considered for an Interim Underwater Inspection if the NBI Substructure code is equal to or less than 3.



The inspection interval will vary depending on the type of deficiency being monitored, and how rapidly the deterioration may be progressing. For scour related findings where a normally buried spread footing is found exposed, or in the case of a pile supported footing which becomes undermined, the Interim Inspection is placed on a 12 month frequency. During subsequent Interim Inspections, the frequency may be adjusted upwards if the scour is determined to be stable and non-threatening to the structure. Adjusting a scour related Interim Inspection frequency upwards is done slowly over time, i.e., 12 months, 24 months, 36 months ect., until the maximum 60 month inspection frequency is reached. For non-scour related Underwater Inspection findings (i.e., foundation damage or deterioration) the Underwater Interim Inspection frequency will usually be set at 24 months. There may be cases where Interim Inspections should occur several times during a calendar year on three or six month intervals. The inspecting agency along with the Team Leader will determine the appropriate inspection interval.

Consideration should be given to performing an Underwater Interim Inspection for load posted bridges, provided the load restriction is due to element's that are only visible by Underwater Inspection techniques.

2. **Performing Inspection** – The underwater BIR will have specific language pertaining to the portions of the bridge needing the Interim Inspection, and what measurements need to be made. The Team Leader should carefully review the past inspection reports to become familiar with the bridge, and to assure that the correct portions of the bridge receive the Interim Inspection.
3. **Reporting** – A BIR documenting the inspection findings should be prepared by the individual who performed the inspection. Any of the following information may be appropriate to include:
  - The date of Interim Inspection.
  - The Team Leader's name.
  - The applicable inspection interval.
  - The location of the element(s) inspected.
  - Any measurements taken.
  - The procedures utilized to analyze and assess the given bridge element(s).
  - The results of any testing performed.
  - Any recommendations for maintenance or repair.
4. **Updating the Inventory Record** – Any changes that need to be made to the Inventory Record shall be entered into BridgeWorks. The Underwater Inspection date should not be changed due to an underwater Interim Inspection. On all Interim Inspections, all changes/updates to NBI data shall be released into the inventory within 90 days of the date of inspection.
5. **Updating the Bridge File** – A copy of the report and an updated copy of the Inventory Record (if applicable) must be placed in the bridge file at the completion of the Interim Inspection and must be cross referenced to the current bridge inspection report.

## G. Damage

Damage Inspections are categorized by type based on the damage received or how it was found or is being reported. Team Leaders should create a Damage Inspection Report in BridgeWorks and choose one of the following events:

- **Overheight (Code ‘A’ in BridgeWorks)** – Damage typically caused by over height loads.
- **Flooding (Code ‘E’ in BridgeWorks)** – Damage as a result of scour to the channel beneath the structure.
- **Earthquake (Code ‘G’ in BridgeWorks)** – Damage caused by seismic events.
- **Other (Code ‘O’ in BridgeWorks)** – Damage/defects found during normal inspection that result in loss of capacity, or for other undefined types of damage.
- **Reported by Others (Code ‘R’ in BridgeWorks)** – Minor damage typically caused by over height loads but reported by maintenance forces. This damage type is used primarily by the state to track deterioration over time. It only exists electronically and therefore is not signed.

Damage Inspections do not have scheduled inspection frequencies but subsequent In-Depth and/or Interim Inspections may be scheduled as a result of the damage to monitor the structure over time.

If called upon to perform a Damage Inspection, Team Leaders should get familiarized with the type of bridge and the location of the damage. Office review of as-built plans and photos should take place prior to inspecting the damaged structure.

1. **Assess Damage** – When damage occurs as a result of collision, earthquake, or other forces, a thorough examination of the damaged areas should be made, along with an assessment of any residual damage to other bridge components. The amount of time and effort required to make this assessment will depend upon the extent and seriousness of the damage.

If significant damage has occurred, the Team Leader will need to:

- Identify any fractured members.
- Determine any loss of foundation support.
- Compute the amount of any section loss.
- Measure the amount any member is out of alignment.
- Inform the bridge owner that an updated load rating may be necessary.

Any time flooding has occurred on the waterway the bridge crosses, an inspection should be conducted both during and immediately after the flooding to assess what effects the increased water flow is having, or had, on the bridge. The following explains these procedures:

- (a) **During Event Inspection** – An inspection during the flood can provide information about the structure’s safety and condition under adverse conditions. Observations made during the flood may help the Team Leader recommend appropriate measures to protect the bridge from failure or damage due to any future flooding.

To the extent possible during the flood, the Team Leader should look for the suggestion or the presence of any of the following:

- Streambed scour around underwater bridge elements.
- Bank erosion.
- Lateral migrations in the channel.
- Sediment transport or accumulation.
- Debris transport or accumulation (especially around piers).

(b) **Follow-up Inspection** – The bridge should be revisited immediately after the flood to assess any damage to the bridge and to provide information about the actual impact of the flood. The Team Leader should assess the impact of any of the following:

- Streambed scour around underwater bridge elements.
- Bank erosion.
- Lateral migrations in the channel.
- Sediment transport or accumulation.
- Debris transport or accumulation (especially around piers).

2. **Critical Damage-Bridge Repair Report (CDBRR)** – If the bridge has been damaged to the extent that has resulted in an emergency load restriction, lane closure, or a bridge closure, a CDBRR, which is part of the Bridge Damage Report, shall be used, see Section 6.02 for further instructions. A copy of this report shall be entered into BridgeWorks and another copy shall be sent to FHWA for initial report and any subsequent updates.
3. **Reporting** – After a Damage Inspection Report has been created within BridgeWorks, descriptions and comments shall be added under the appropriate BMS elements describing the damage. A Bridge Damage Report is also required for all Damage Inspections performed by the state, See Section 6.02 for further instructions.

For over height damage, add the BMS Element #362, Impact Damage flag, if required. Add the damage photos and revise the BMS condition state codes if necessary. The following information should also be noted:

- The location, extent, and type of any damage found.
- The amount of any section loss.
- The degree to which any members are out of alignment.
- The need for new load ratings, if applicable.
- Any recommendations for repair or maintenance.
- Vertical clearance at the point of impact and at the minimum opening of the span on over height damage inspections.

For prestressed concrete or steel bridges fill out the Prestressed Concrete and Steel Damage Report form or equivalent to supplement the Bridge Damage Report, see Section 3.05.

If the bridge is damaged as a result of the flood or if conditions have changed at the bridge site, a Bridge Damage Report and a new Scour Field Evaluation form must be completed. If the bridge is a scour critical structure, the instructions within the Plan of Action (POA) should be followed, see Section 5.03.B.

The report should provide the following information:

- Flood stage at which the bridge was visited. This information can be found at the NOAA National Weather Service website.
- Approximate streamflow volume and velocity at the time of the visit. This information can be found at the NOAA National Weather Service website.
- Location and extent of any damage to the bridge.
- Current condition of any bridge elements affected by the flood.
- Any recommendations for scour countermeasures, bank protection, channel protection, etc., which may protect the bridge from damage during future flooding or reduce the potential for future flooding.

When printing Bridge Damage Reports, only include the BMS elements, photos, repairs and files that pertain to the damage.

4. **Updating the Inventory Record** – If any changes to the Inventory Record (the inventory or load ratings, for example) are needed, they must be entered into BridgeWorks. On all Damage Inspections, all changes/updates to NBI data shall be released into the inventory within 90 days of the date of inspection.
5. **Updating the Bridge File** – A copy of the BIR and an updated copy of the Inventory Record (if applicable), a copy of the Bridge Damage Report and all other applicable forms and drawings shall be placed in the bridge file at the completion of the Damage Inspection.

## H. Safety

Safety Inspections are performed on structures such as railroad overcrossings, pedestrian bridges, utility structures, and highway lids or tunnels without traffic on top of them. These structures are not submitted to FHWA but are still inspected as they may impact public safety. On all Safety Inspections, all changes/updates to the data shall be released into the inventory within 90 days of the date of inspection

The inspection intervals will vary depending on the structure type being inspected. Recommended frequencies are as follows:

- **12 Months** – Timber bridges with red/yellow tags, any other material in poor condition needing monitoring, scour issues, load posting, etc.
- **24 Months** – All other timber structures, any other bridge material that has BMS elements in Condition States 3 or 4.
- **48 Months** – Steel structures in good condition and concrete structures with minor problems.
- **72 Months** – Concrete structures in good condition.

There are two categories that Team Leaders from the state typically perform Safety Inspections on:

1. **Non-State-Owned Bridges That are Non-Vehicular and Crossing Over State Routes** – The Deck Overall (1663), Superstructure (1671) and Substructure (1676) codes should all be coded a “9”. These bridges could be railroads, local roads, local agency pedestrian bridges, or utility bridges owned by the utility. The inspection frequency is generally 72 months. The Team Leader shall only use BMS Element (#366) – Undercrossing-Safety Inspection, documenting any details of flagged defects or damage within the element note in BridgeWorks.
2. **State-Owned Bridges** – Even if they are not NBI bridges (pedestrian, tunnels without traffic on top of them) the bridges should receive full NBI and BMS inspections.

### I. Short Span

Short span bridges are not eligible for federal replacement funding and are not reported to the NBI.

Even though short span bridges are not reported to the NBI, there remains concern about their deterioration and performance. Therefore, it is recommended that agencies inspect short span bridges similar to a full NBI inspection for informational purposes. The frequency of the inspections for these bridges will be at the discretion of the owner agency.

1. **Inspection Criteria** – Inspections are recommended for the following short span bridges:
  - Timber structures that meet the criteria in Appendix 3.06-A1 and Appendix 3.06-A2.
  - Single span concrete or metal structures, other than metal corrugated pipes that meet the criteria in Appendix 3.06-A1 and Appendix 3.06-A2.
  - Multiple span structures that meet the criteria in Appendix 3.06-A3.
  - Metal corrugated pipes with an opening greater than 8 feet.
  - Multiple pipes with a structure length from 10 feet to 20 feet, see (1340) in Appendix 2.06-C for structure length definitions.

This criteria is presented as a guideline and is not intended to replace sound engineering judgment. When in doubt, a conservative approach should be taken.

- a. **Short Span Bridges Inspected** – If the short span bridge is inspected, agencies should follow these guidelines on reporting:
  - (1) Fill in all the applicable fields listed on the WSBIS coding form. The bridge number should be unique for short span bridges.
  - (2) Take deck and elevation photographs.
  - (3) Fill out the Scour Field Evaluation form (if applicable).
  - (4) Complete a BIR.

- (5) Determine the frequency of inspection needed. Recommended frequencies are as follows:
  - **12 Months** – Timber with red/yellow tags, any other material in poor condition needing monitoring, scour issues, load posting, etc.
  - **24 Months** – All other timber structures, any other material that has BMS elements in Condition States 3 or 4.
  - **48 Months** – Metal structures in good condition and concrete structures with minor problems.
  - **72 Months** – Concrete structures in good condition.
- (6) Submit the data through normal bridge inspection reporting procedures.
- b. **Short Span Bridges Not Inspected** – If the short span bridge is not inspected, the following are some guidelines to follow:
  - (1) WSDOT Team Leaders should note the milepost, type of bridge, features carried, features intersected, take elevation and deck photographs, and notify maintenance personnel that future inspections of the bridge are their responsibility.
  - (2) Local Agency Team Leaders should note the milepost, type of bridge, features carried, features intersected, take elevation and deck photographs, and determine if the need for any future inspection of the bridge is necessary and coordinate with their maintenance personnel.
2. **Performing the Inspections** – The inspection procedures for short span bridges are the same as those for NBI bridges.

An Underwater Inspection is performed on short span bridges with structural elements underwater. If the Team Leader is unable to assess the condition of the elements either visually or by probing, an underwater bridge inspection diver must conduct the Underwater Inspection. This inspection determines the structural condition and adequacy of the short span bridges underwater elements.
3. **Updating the Inventory Record** – Following the inspection procedures used on NBI bridges insures consistency of reporting. State-owned bridges are added to the WSDOT Bridge List while local agency bridges are added to their own local inventories.

After the bridges are inspected, the procedures for creating and updating the Inventory Record are followed. On all short span inspections, all changes/ updates to the data shall be released into the inventory within 90 days of the date of inspection.
4. **Updating the Bridge File** – The minimum information maintained in the bridge file for short span bridges should include:
  - a. Inventory data, including location maps.
  - b. Completed inspection forms.
  - c. A sketch of the bridge showing dimensions and depth of fill (barrel length should be taken as one pass distance, regardless of the number of barrels).

- d. Deck and elevation photographs
- e. Scour Field Evaluation Form (if applicable).
- f. Correspondence.

## **J. Two-Man UBIT**

The Two-Man UBIT Inspection type is primarily utilized by the State for scheduling and tracking purposes when assisting Local Agencies with NBI inspections. The Two Man UBIT inspection type is not an NBI reportable inspection. The frequency for Two-Man UBIT inspections is set by the Local Agencies.

1. **Identify Need** – Through signed agreements between the State and Local Agencies, the State can assist those agencies with inspections requiring the use of specialized equipment by performing two-man UBIT inspections.

The inspection interval may vary depending on terms of the agreement between the State and the Local Agency. The Local Agency shall determine the level and inspection interval for their structures within the agreement.

2. **Performing the Inspection** – Typically, an Assistant Inspector and UBIT driver will make up the inspection team that represents the State. A Local Agency Team Leader will accompany the state team to perform the inspection. The Assistant Inspector will coordinate with the Local Agency Team Leader as to how the work will proceed for the time period assigned.
3. **Updating the Inventory Record** – The responsibility of generating the BIR and editing the WSBIS and any applicable inspection forms and entering the data into BridgeWorks shall reside with the Team Leader from the Local Agency.
4. **Assistant Inspector Responsibilities** – The Assistant Inspector from the State shall ensure that the following items are completed during and after the inspection of each local agency bridge.
  - a. While at the bridge site, take a Deck and Elevation photo of the structure.
  - b. Log the actual UBIT hours on site.
  - c. Create a Two-Man inspection type within BridgeWorks.
  - d. Enter the Local Agency Team Leader's initials as ZZZ and a certification number of Z9999.
  - e. The bucket operator's initials will be entered as the Assistant Inspector. The Assistant Inspector should attach the deck and elevation photos taken at the site into BridgeWorks.
  - f. Add the appropriate resources and dates for future inspections.

### **K. Informational**

See introduction to Section 3.02.

### **L. Inventory**

See introduction to Section 3.02.

### **M. In-Depth**

Any time a bridge element or portion of the bridge requires further evaluation, analysis, or investigation to accurately assess its condition, complete an In-Depth Inspection. This inspection may involve testing, monitoring, or conducting specific analyses of given bridge elements. In-Depth Inspections are performed as needed and do not have a set inspection frequency. They are not reported in the NBI.

1. **Identify Need** – Any time the structural condition of an element cannot be determined in the course of a Routine Inspection, an In-Depth Inspection may be required. The In-Depth Inspection is performed to obtain more sophisticated data, perform special testing, and/or bring in other experts to assess a particular problem.

The need for an In-Depth Inspection generally arises as a result of a Routine Inspection; however, such a need may also be the result of a damage, flood, or Interim Inspection. Whenever such a need is discovered, an In-Depth Inspection should be performed.

In-Depth Inspections do not have inspection intervals and are treated as one-time only inspections. If the inspecting agency feels that subsequent inspections are needed on regular intervals, Interim Inspections should be utilized instead.

2. **Performing the Inspection** – The In-Depth Inspection should include as detailed analysis as necessary to determine the condition of the given bridge element. There can be no standard set of procedures to follow or observations to be made. Many factors will influence the depth and extent of analysis required. To facilitate accomplishment of the inspection, the Team Leader should make sure that any traffic control measures or necessary special equipment will be available.
3. **Reporting** – There is no standard form to be completed for reporting In-Depth Inspection findings. When the inspection is concluded, the Team Leader should prepare a BIR along with any additional documentation to note:
  - The location of each bridge element inspected.
  - The procedures used to analyze and assess the particular bridge element.
  - The names, titles, and observations made by any specialists who were consulted.
  - The results of any testing performed.
  - Any recommendations for maintenance or repair.



4. **Updating the Inventory Record** – Any changes that need to be made in the Inventory Record shall be entered into BridgeWorks.

On all In-Depth Inspections, all changes/updates to NBI data shall be released into the inventory within 90 days of the date of inspection.

5. **Updating the Bridge File** – A copy of the report and an updated copy of the Inventory Record.

Record (if applicable) shall be placed in the bridge file at the completion of the In-Depth Inspection and must be cross referenced to the current Bridge Inspection Report.

## **N. Geometric**

See Section 3.02

### **3.03 Bridge Inspection Orientation**

Designation of the bridge orientation and a component numbering system for the bridge elements are needed for consistency within the inspection reports. Typical bridge orientation convention has the structure beginning at and going from the west end of the structure to the east, or from the south to the north, or in some cases, the direction of increasing mile post. The subcomponents of a structure are typically numbered from the left to the right looking ahead on stationing. The orientation and component numbering system typically follows the convention of the inspecting agency. If the State inspects bridges for other agencies, they will follow State convention (see Figures 3.03-A, 3.03-B, 3.03-C, and **3.03-D**) or follow established agency orientation.

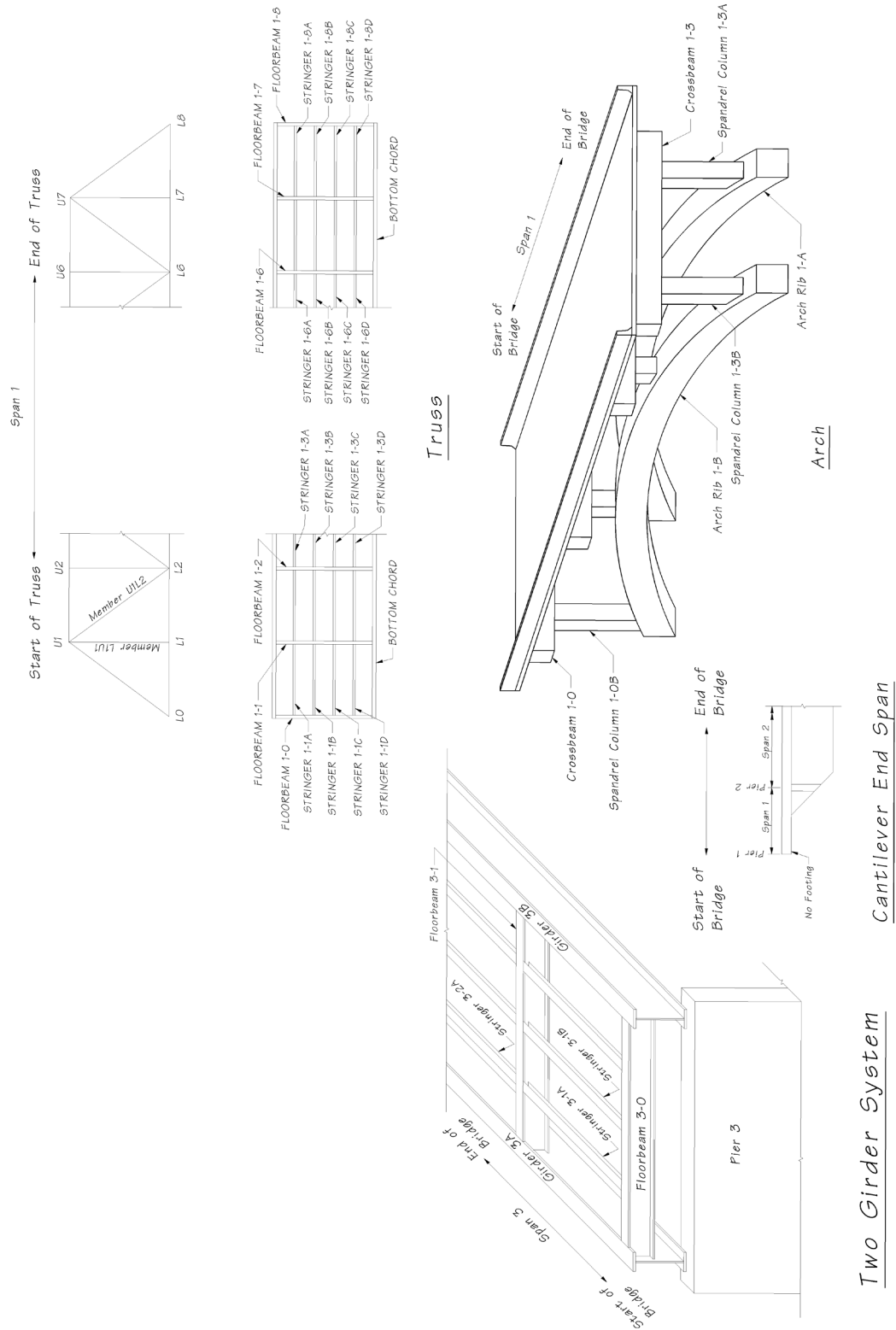
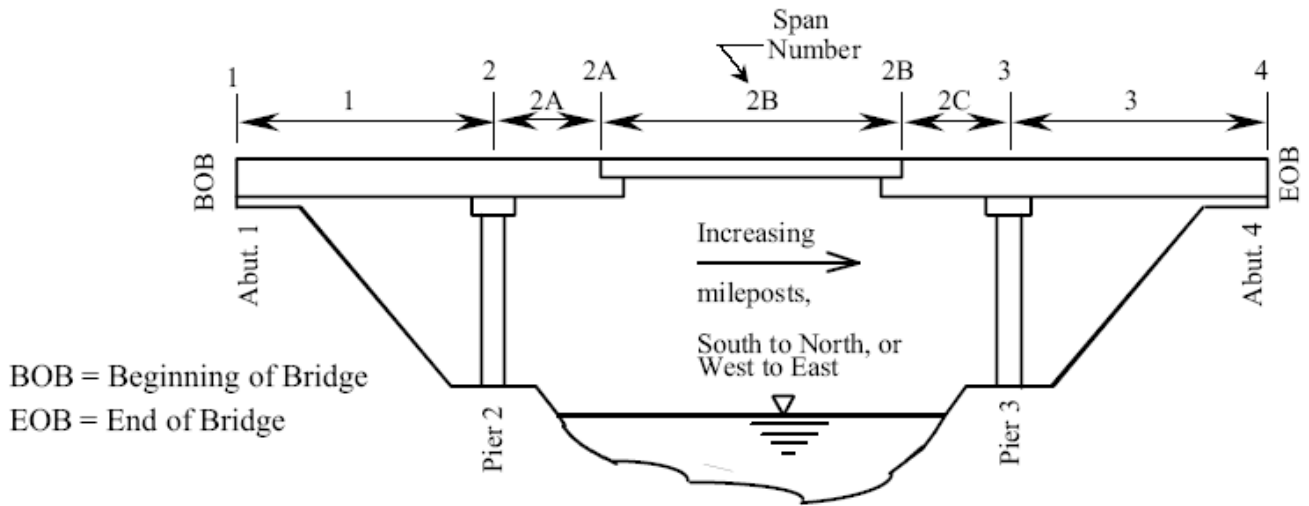

Figure 3.03-A



**Component Location**  
*Figure 3.03-B*

**Orientation:**

B.O.B. normally south or west ends following route orientation.

**Exceptions Include:**

One way ramps – B.O.B. = First end to receive traffic.

Selected bridges that follow plan orientation.

There is no golden rule about orientation except that B.O.B. Must always be identified in the '0' note along with basis for this assumption. It is helpful to refer to geographical markers (streets, rivers, etc) when describing the B.O.B.

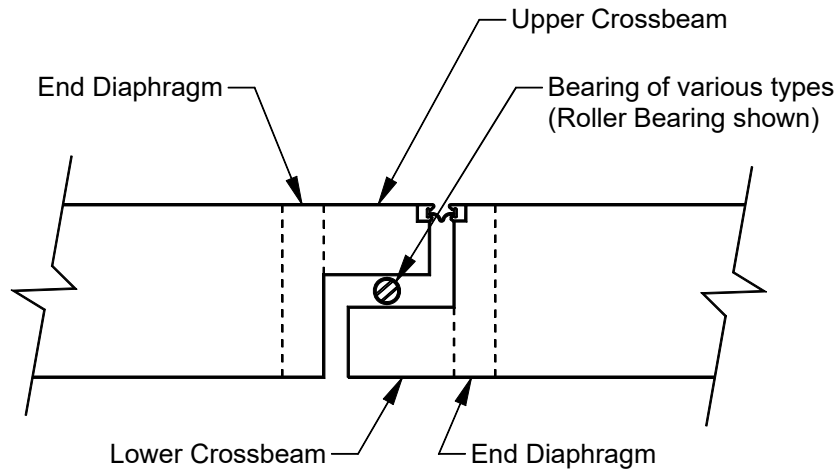

**IN-SPAN HINGE CALLOUT**

(Do not Quantify Crossbeams in BMS for Box Girder)

**Figure 3.03-C**

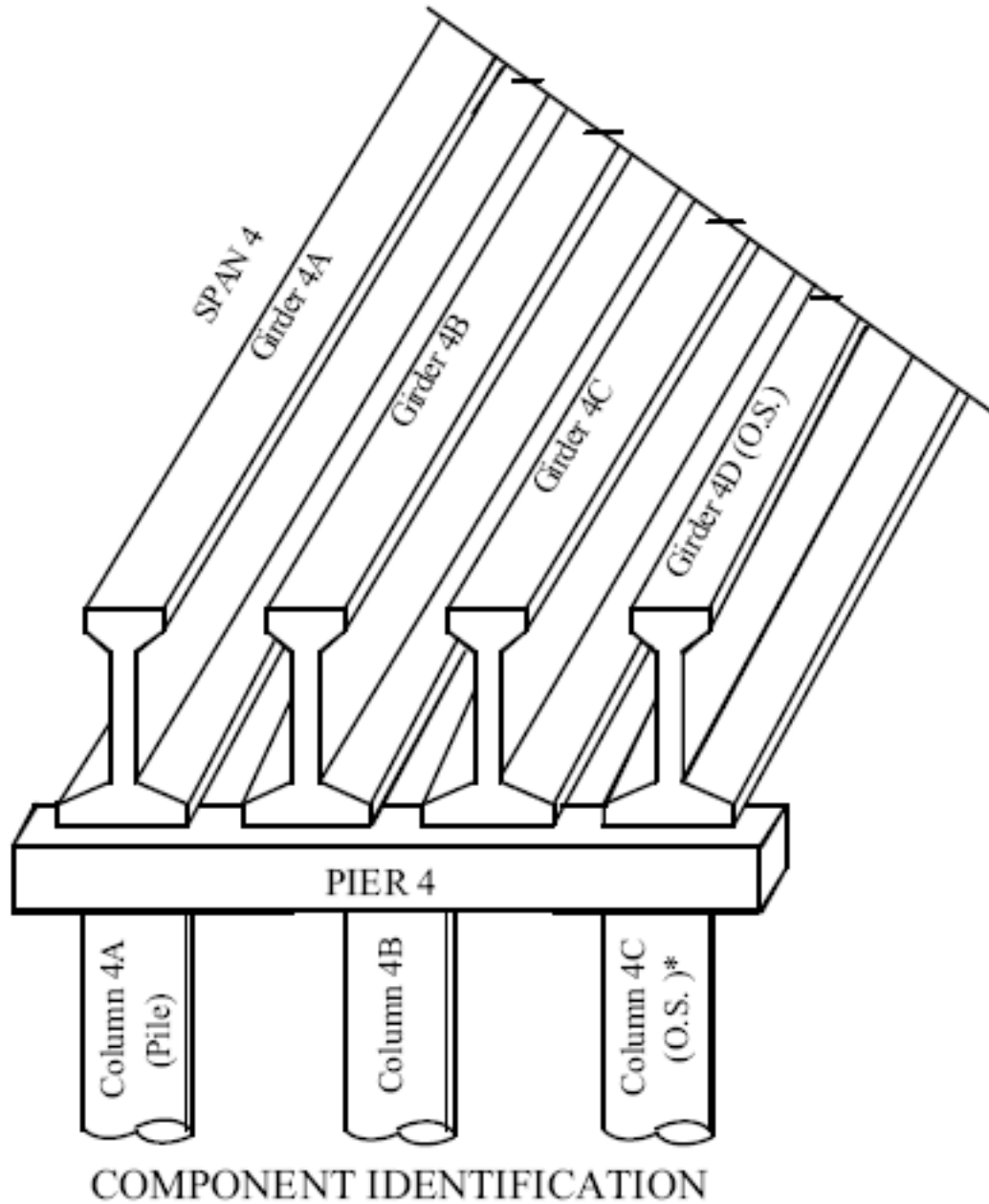

PRIMARY ELEMENTS  
 Looking Ahead on Mileposts  
 South to North or West to East

**Figure 3.03-D**

Section 3.04 provides guidelines for inspection processes and procedures specific to the State and the Office of Local Programs. These guidelines can be used as a reference or can be implemented.

## 3.04 Policy and Procedures

This section discusses the specific policies and procedures that are utilized in BPO or LP that are supplementary guidelines for field work and inspection report writing. These best management practices are utilized by inspection teams and are specific to each program.

### 3.04.1 BPO Policy and Procedures

#### A. General Inspection and Report Writing

- Columns on the first page of the BIR contain NBI and agency specific items with associated coding information for each structure within the inventory. The numbers within parenthesis next to these item titles are WSBIS item numbers and are unique to the BridgeWorks program that corresponds to FHWA items and/or agency specific items. For example, the first code at the top of the BIR form is the Structural Adequacy Appraisal code and is denoted by WSBIS item number (1657).
- When circumstances prevent any required work from being completed at the time of inspection, report this fact to your supervisor so a determination can be made whether or not the bridge needs to be rescheduled in the current inspection year. It is the responsibility of the Team Leader to ensure that the bridge inspection is completed unless the supervisor delegates the responsibility. Bridges that cannot be inspected due to high water will be rescheduled in the current inspection year during lower flows. If the supervisor determines that the bridge does not need to be rescheduled in the current inspection year, clearly identify why the work wasn't completed and what is required of the next team leader to achieve the task.
- Traffic lanes on a structure are numbered from right to left looking in the direction of traffic on one-way multilane routes. For reversible lanes assumed orientation should be described in the report.
- Whenever an in-span hinge separates two bridges, the bearings, restrainers, and joint are to be coded with the "dependent" structure. Explain any exceptions to this rule in the 0 note.
- Whenever measurements are taken, for joint openings, monitored conditions, or anything else, include in the report the date and the air temperature when the measurements were taken. Unless there is a warranted condition, only measurements from the last three inspections need to be maintained.
- Refer to specific joints by pier or span numbers instead of joint numbers. There may be unique circumstances where using joint numbers are justified. Under these circumstances, justification for using joint numbers must be documented in the report.
- Investigate fully and report any and all joint noises and their origination.
- Compare Curb to Curb Deck Width (1356) with Horizontal Clearance (1491 and 1495) and investigate differences (typically they should be the same, except for non-mountable medians).
- Detailed notes are to be entered separately under each Bridge Management System (BMS) element. NBI notes should reference the appropriate BMS element note. Maintain any details of flagged defects or damage within the BMS element note.

- Inspection report summary comments are required for any BMS element in Condition State (CS) 2, 3 or 4.
- Avoid using phrases for significant defects such as “open crack” without a further description such as width, and any repetitive nature. Mark the specific defect location on the bridge with any measurement and the date. Consider taking a photo of the marked defect to include in the inspection report. For concrete crack size guidelines, see the table in Section 4.04.
- When submitting reports for initial review, include field notes in the review package along with a clean copy of the report, the WSBIS sheet, the inspection photographs, and other relevant reports (fracture critical, soundings, etc.). The WSBIS sheet is required to reflect all current changes associated with the inspection.
- Describe photos with respect to bridge orientation, not geographic direction. Photos should identify the orientation, location, and what is photographed. All photos, except deck and elevation photos, must be numbered and referenced in the notes or in an attached file such as a Fracture Critical Report.
- Photos no longer relevant to the report should be deleted. Keep repair photos in the report for an additional inspection cycle so the Bridge Preservation Supervisor can compare them.
- Deck and Elevation Photos should be assessed at each inspection. Update photos if there are new conditions or changes to the structure.

**B. Bridge Inspection Notes Standard Practice**

- A. Cardinal directions (north, south, east, and west) are never capitalized, except at the beginning of a sentence. These directions are also not abbreviated. The directions northeast, southeast, northwest, and southwest may be abbreviated NE, SE, NW, and SW.
- B. For acronyms, follow the standard practice of spelling out the first time use with the acronym in parenthesis following (e.g., Local Programs (LP)).
- C. Use of abbreviations should be limited. Common abbreviations:

|             |                                                                              |             |                            |
|-------------|------------------------------------------------------------------------------|-------------|----------------------------|
| F           | Fahrenheit                                                                   | A.M.        | a.m.                       |
| in.<br>or " | inch (inches)                                                                | P.M.        | p.m.                       |
| ft. or ‘    | foot (feet)<br>‘ symbol only used when followed<br>by a dimension in inches. | NW NE SW SE | directions                 |
| L           | length                                                                       | D           | depth                      |
| W           | width                                                                        | etc.        | etcetera                   |
| sq. ft.     | square feet or SF                                                            | LF          | linear feet                |
| psi         | pounds per sq. in.                                                           | YT          | Yellow tagged              |
| psf         | pounds per sq. ft.                                                           | RT          | Red tagged                 |
| ACP         | asphalt concrete pavement                                                    | LMC         | latex modified<br>concrete |
| BST         | bituminous surface treatment                                                 | HMA         | hot mix asphalt            |
| SR          | State Route                                                                  | US          | National Highway           |
| I           | Interstate                                                                   | Jan         | January, etc.              |

- D. Limit the use of symbols to ° for degrees and % for percent.
- E. Dimensions are noted with a space or hyphen between feet and inches, and a hyphen between whole inches and fractions of an inch. When combined with other dimensions, a ‘0’ should precede bare fractions of an inch. Measurements greater than 12" may be listed in inches, if appropriate. Decimal inches may also be used. For example:

1' 1-1/16" × 6' 0-7/8"

6" × 14" timber stringers

8" × 14" × 1/2" deep spall

3 ft. wide × 14 ft. long × 2.5 ft. tall bridge corbel

12 ft. (L) × 15' 6" (W) × 3" (D) popout in south face of Pier 2

1' 0-3/4"(l) × 0.125"(w) crack in east face of Girder 2F

42.2" long anchor bolts

### C. Report Notes Within BridgeWorks

#### 0 Note – Orientation

- Bridge orientation and identification of the pier/span numbering system is always required, stating the basis of orientation such as “increasing mileposts,” “ramp direction,” or per plans. Any potentially confusing orientation issues or deviations from standards (west to east or south to north) must be clearly identified. Identifiable physical features at beginning or end of bridge may also be used. See Section 3.03 for bridge orientation examples.
- Place any special instructions and information that doesn’t fit anywhere else under the 0 note.
- Use the following note for bridges eligible for a 48 month frequency:  
Continue to validate the status of this bridge each inspection as a 48-month inspection candidate. Verify condition ratings, load ratings, vertical clearances, ADT, scour codes and that no major maintenance has been completed in the last two years.

**1 Note** – This note is maintained by the Team Leader and is used for explanatory information regarding bridges that are Fracture Critical and/or require a Special Feature Inspection. Use this note to explain any special features, procedures, areas to be inspected or complicated scheduling. Do not use this note to redundantly repeat resource information or dates that an inspection occurred.

**5 Note** – Program Management Engineer maintains this note. It contains information regarding scheduled rehabilitation or replacement, and other upcoming program management items.

**9 Note** – The 9 note is used to create the executive summary for an Underwater Inspection Report.

**11 Note** – The Load Rating Engineer maintains this field. It is used to explain any load posting placed on a bridge. This note is closely associated with the Revise Rating flag (2688), see Section 3.04.1.E.

**D. Operating Level Code (1660)**

- Verify that load posting signs are in place **at the bridge** and **in advance of the bridge**. **Advance load postings must be placed in advance of the nearest intersecting road, ramp or wide point in the road where a driver can detour or turn around**. **Verify that load posting signs and advance load posting signs** match the posting requirements in Note 11 and write a note within BridgeWorks under Operating Level Code (1660) to that effect. Take a photo of any existing posting **signs and advance posting signs**. **Ensure** that (1293) (open or closed) is coded appropriately.

**E. Revise Rating Flag (2688)**

- For State owned bridges, any load rating issues should be addressed within the body of the BIR in the (2688) note. Delete any notes that don't have relevance to the existing condition of the bridge.

**F. Scour Code (1680)**

- The Scour Engineer maintains the Scour code (1680) field and notes. Any scour comments by the Team Leader should be placed in BMS Element (#361) Scour Flag or Channel Protection (1677), depending upon which is most appropriate.

**G. Soundings Flag (2693)**

- When preparing for an inspection that requires soundings, print any existing stream profile file to include in your inspection field packet. The Scour Engineer determines which State bridges need stream cross sections (soundings) by placing a "Y" in the Soundings Flag (2693). When this is required as part of the inspection, perform the following:
  1. Enter data into the Scour Field Evaluation Form, see Section 3.05.
    - a. If you could not take soundings on the initial inspection trip, plan on getting them on another trip, either by coordinating with another Team Leader or by doing it yourself.
    - b. If there is a reason soundings should be taken at a different time of the year (e.g. low water, low tide, or fish windows), add a resource with an explanation under the Report Types Tab.
  2. Save the file under the bridge number (e.g., 5\_24S.xls) in the appropriate year "Soundings" folder found on the W drive at W:\Data\Bridge\RegionalInsp\Common\Soundings.
  3. Attach the completed form to the appropriate bridge inspection report File Tab, replacing any already existing form and remove the old one.
  4. Change the Soundings Flag (2693) from "Y" to "\*" for State bridges only.
  5. Place the date soundings were taken in the (2693) note (e.g., 'Soundings taken 2/1/2004').
  6. When you return to the office submit an email to the Scour Engineer stating that the soundings have been completed and that the findings are in the soundings folder for his review.



7. The Scour Engineer will email an electronic stream profile file that you will attach to the report Files tab.
  - a. Replace any existing stream profile file with the updated one and remove the old one.
  - b. Print the new stream profile file and include it with your inspection review packet.

## H. Timber Structures

- Yellow Tagged (YT) members have rot and a shell greater than or equal to 1-½". A YT member requires a **Priority 2** repair. The need for Interim Inspections is determined by the lead.
- Red Tagged (RT) members have rot and a shell less than 1-½". A RT member requires a Priority 1 repair. Schedule an Interim Inspection. Determine the extent, location and significance of decay. Provide details for the Load Rating Engineer.

## I. Culverts

- Structure Length, NBI Length and Maximum Span are determined in accordance with (1340), (2346), and (1348).
- The BMS quantity is determined by measuring from inlet to outlet of one barrel/ pipe and is not dependent upon the number of barrels or pipes.

## J. Vertical Clearances (1370 and 1374)

### When to Collect or Verify Vertical Clearances

- Whenever a clearance card is missing, incomplete or inaccurate. High traffic volumes may prevent the ability to acquire this information without traffic control.
- At bridges with vertical clearances under or over that are equal to or less than **16'6"**.
- At bridges where the clearances box has been populated with a "V".
- When Team Leader feels that over height hit damage is occurring significantly enough to check the existing clearance information.
- As a part of over height load damage inspections.

### Where to Collect or Verify Vertical Clearances

- Minimum clearances along all lane stripes, edges of pavement/curb or controlling grade breaks between these points.
- Appurtenances (lights, signs, utilities) that control minimum vertical clearances should be documented as well, but in most circumstances will be used only to create a repair recommendation to relocate appurtenance. Provide vertical clearance information to the Sign Bridge Engineer.
- For existing postings verify lowest accessible clearance location first and verify other locations as required.
- For Damage Inspections, measure all accessible lane stripe locations in the area of the damage and at the point of impact.

### Documenting Vertical Clearances

- Document all measured clearances. Drawings should be neatly transcribed and turned in to the Bridge Geometry Engineer. Photos are to be placed in the Photos/694 Clearance folder in BridgeWorks. See the Vertical Clearance Card form located in Section 3.05.
- 2694 Note should reference: Vertical clearances checked on (date). Minimum clearance below the bridge measured to be (measured minimum clearance) below (exact location). See photo #. REPAIR #00000
- Update WSBS fields (1370), (1374) and (1499). Appurtenances are not coded. Consult with the Bridge Geometry Engineer for questions.

### Posting Requirements and Recommendations

- Bridges with field measured minimum clearances over the traveled lanes equal to 14'3" up to and including 15'3" require posting on the structure at the controlling location and advance warning signs at one or both shoulders.
- All bridges with field measured minimum clearances less than 14'3" require additional advance posting signs in advance of nearest intersecting roads, ramps or a wide point in the road where a driver can detour or turn around.
- All posted clearances shall be 3" less than the actual lowest measured clearance. Consideration is given to adjusting existing clearance signage when the existing signage provides a buffer of only 1" or less to the actual measured clearance. If advance warning and/or detour signage is required and does not exist, then re-posting the structure at 3" below the actual measurement is considered good judgment.
- There are situations where bridges should be posted for minimum vertical clearances in the shoulders (outside traveled way). Check with the Bridge Geometry Engineer for details.
- When vertical clearance posting is found deficient or missing, write a "priority 1", "V repair" as follows: (Coordinate with the region traffic office to provide required correct vertical clearance posting on and in advance of the bridge. Minimum clearance measured to be (measured clearance) located at (controlling location) on (date measured). Post for (3" less than measured clearance). Posting is to be in accordance with "Vertical Clearance Repair" sheet attached to the files tab. Contact (Bridge Geometry Engineer) at Bridge Preservation 360-570-2544 with any Questions.) Fill out a "Vertical Clearance Repair" sheet, attach to the Files Tab and turn in to the Bridge Geometry Engineer. See the Vertical Clearance Repair form in Section 3.05.
- Appurtenances such as lights or signs that suspend below those bridge elements are to be noted. Those that are 15'3" or less within a traveled path or have evidence of traffic impact damage are to be written up as a repair to be removed or relocated.

### Each Inspection, Check For:

- All postings on bridge, and in advance, are in place.
- Posted clearances are consistent with existing conditions and documentation.
- Update 2694 note with the date that the vertical clearance was taken and the date that the vertical clearance card was reviewed.
- Update the WSBS.

### **K. Horizontal Clearances**

- Collect minimum shoulder widths on both sides of roadway and edge of traveled way (fog line) to permanent obstruction (columns, abutments, retaining walls, toe of slopes). See Item 1379 for ramps, gores and other more complex configuration examples.
- Collect horizontal clearances where the clearance flag has been populated with an “H”.
- Update WSBS fields (1379) and (1383) (Minimum Lateral under Clearance Right & Left).

### **L. Inspection of Structures Under Contract**

- Information organized by the Bridge Inventory Technician will include the Project Office contact and contract numbers.
- For structures under contract, the BPO inspector MUST make contact with the Project Office (Project Engineer if possible) prior to performing inspection. Do not directly talk to contractor.
- If construction defects or safety issues are found during inspection:
  - Emergency contacts:      1st – Region Project Engineer
  - 2nd – BPO
  - 3rd – HQ Bridge Construction Office
- Routine Maintenance, contact the Project Office and Regional Maintenance Staff.

### **M. Bridge Scour for Local Agency Bridge Inspections**

- Bridges with Scour Code (1680) of 2 and 3 are scour critical. For reports with a scour code of “6”, “U” or “T” the bridge is assumed to be scour critical.
- Bridges with a scour code of “6”, “U”, or “T” need a priority 1 repair called out in the (1680) note.  
 The call out in the (1680) note should read as follows: “This inspection report assumes the bridge is scour critical. REPAIR #XXXXX”  
 The Repair should read as follows: “(1680) is coded [“U”, “T”, or “6”] indicating that the bridge foundation is not known, is tidal, and/or has not been evaluated. Perform evaluation of scour potential and any required mitigation. Indicate determination and any requirements under the (1680) note.”
- Scour critical bridges, and those that are assumed to be scour critical, that have exposed footings or have a history of exposed footings due to scour, REQUIRE a priority 1 scour repair documented in the BMS Element (#361) – Scour flag note in BridgeWorks. This repair should read as follows: “Scour mitigation needs to be evaluated.”
- All scour critical bridges need soundings at every Routine Inspection. The (2693) note needs the following comment: “Take soundings every Routine Inspection on this scour critical bridge.” Also ensure that the (2693) flag is set to “Y” at all times. This will help the process stay in place over time.
- Bridges that are not scour critical do not need cross sections unless there is some specific need that is documented in the report.

## **N. Rental Equipment**

The Enterprise and Risk Management Office has declared that equipment damage insurance must be purchased when renting access equipment. If the rental company does not offer insurance, insurance can be purchased through the Department of Enterprise Services (DES). The DES insurance option can take up to two weeks to process so plan accordingly.

For rented access equipment the following is required:

- Review the paperwork, when receiving the equipment, to insure that it reflects insurance for the rented equipment.
- Review the invoice when you receive it from the BPO Accountant, making sure that the rate and time used are correct.
- Notify the rental office of any discrepancies found.
- Write the bridge number and dates used on the invoice.
- Return it to the BPO Accountant for processing.

## **O. Bridge Inspection Safety**

See Pre-Activity Safety Plan (PASP) for details. See Section 3.05.

## **P. Identifying The Purpose Of Inspections in the Bridge Inspection Report**

Indicate the purpose and schedule of any Interim or Special Inspections that are required, similar to the following format: “Interim Inspections of RT timber are done in odd numbered years and Routine Inspections of the entire bridge are done in even numbered years.” Statement should briefly describe what is to be accomplished during the Interim or Special Feature Inspection. This information is placed in the “Notes” box under the specific inspection tab, but may sometimes be more completely explained here. It can additionally be placed in the 0 note.

## **Q. Agreements Inspections**

Team Leader will provide the complete submittal package for each bridge inspected, which includes the signed inspection report, the SI&A sheet, the inventory sheet, all photos and files is given to the Bridge Resource Technician (BRT) who checks them against the scope of work. If there is anything missing, the BRT needs to check with the inspectors and follow up with the Bridge Preservation Accountant (BPA) if there are problems with providing a complete submittal package. The complete submittal package for each bridge is scanned and loaded onto BEIST, and a hardcopy filed in the unofficial letter file in the resource room. The complete submittal packages for each bridge are sent to the agency via USPS to the address in the agreement along with a transmittal letter listing all inspection reports provided. A copy of the transmittal letter is given to the BPA for filing with the invoices and agreements.

### **3.04.2 LP Policy and Procedures**

Local Agency Policy and Procedures are detailed in the *Local Agency Guidelines* (LAG). Electronic copies of the LAG are available on the WSDOT Local Programs website at [www.wsdot.wa.gov/localprograms](http://www.wsdot.wa.gov/localprograms).

Local agencies are encouraged to review the BPO Policies and Procedures in the preceding section and adopt or modify the advice to the benefit of their Bridge Program. Local Agency bridge personnel are encouraged to contact the WSDOT Local Programs personnel for guidance and advice on bridge program questions.



### 3.05 Forms

This section contains inspection forms typically used by the State. Local agencies have the option of developing their own forms with similar information or utilizing the forms in this section.

Bridge Inspection Report

WSBIS Form

Scour Field Evaluation

Daily Site Dive Log

Visual Fracture Critical Inspection Report

Prestressed Concrete Damage [Drawing Template](#)

[Girder Elevation Template](#)

Fall Protection Plan – Emergency Action Plan

Lead Exposure Control Work Plan

Respirator Record

Confined Space Entry Permit

Ultrasonic UT Inspection Report

UT Inspection Schedule

Pins Summary Sheet

Pin and Hanger Visual Inspection Report

Special Features Inspection Report

[Vertical Clearance Card Generic](#)

[Vertical Clearance Card Steel](#)

[Vertical Clearance Card Tunnel](#)

Pre-Activity Safety Plan (PASP)

**BRIDGE INSPECTION REPORT**

Page 1 of 1

WO CC WE PD  
 BAM

Status:  
 CD Guid:

Printed On:  
 CD Date:

Agency:  
 Program Mgr:

|                     |            |                    |                  |
|---------------------|------------|--------------------|------------------|
| <b>Br. No.</b>      | <b>SID</b> | <b>Br. Name</b>    |                  |
| <b>Carrying</b>     |            | <b>Route On</b>    | <b>Mile Post</b> |
| <b>Intersecting</b> |            | <b>Route Under</b> | <b>Mile Post</b> |

Inspector's Signature      Cert #      Cert Exp Date      Co-Inspector's Signature

| <input type="checkbox"/> Structural Eval (1657) | <input type="checkbox"/> Operating Tons (1552)  | <input type="checkbox"/> No Utilities (2675)   | <b>Inspections Performed:</b><br><table border="1"> <thead> <tr> <th>Freq</th> <th>Hrs</th> <th>Date</th> <th>Rep Type</th> </tr> </thead> <tbody> <tr><td></td><td></td><td></td><td>Routine</td></tr> <tr><td></td><td></td><td></td><td>Fract Crit</td></tr> <tr><td></td><td></td><td></td><td>UW</td></tr> <tr><td></td><td></td><td></td><td>Special</td></tr> <tr><td></td><td></td><td></td><td>Interim</td></tr> <tr><td></td><td></td><td></td><td>UWI</td></tr> <tr><td></td><td></td><td></td><td>Damage</td></tr> <tr><td></td><td></td><td></td><td>Safety</td></tr> <tr><td></td><td></td><td></td><td>Short Span</td></tr> <tr><td></td><td></td><td></td><td>In Depth</td></tr> <tr><td></td><td></td><td></td><td>Geometric</td></tr> </tbody> </table> | Freq       | Hrs | Date | Rep Type |  |  |  | Routine |  |  |  | Fract Crit |  |  |  | UW |  |  |  | Special |  |  |  | Interim |  |  |  | UWI |  |  |  | Damage |  |  |  | Safety |  |  |  | Short Span |  |  |  | In Depth |  |  |  | Geometric |
|-------------------------------------------------|-------------------------------------------------|------------------------------------------------|---------------------------------------------------------------------------------------------------------------------------------------------------------------------------------------------------------------------------------------------------------------------------------------------------------------------------------------------------------------------------------------------------------------------------------------------------------------------------------------------------------------------------------------------------------------------------------------------------------------------------------------------------------------------------------------------------------------------------------------------------------------------------|------------|-----|------|----------|--|--|--|---------|--|--|--|------------|--|--|--|----|--|--|--|---------|--|--|--|---------|--|--|--|-----|--|--|--|--------|--|--|--|--------|--|--|--|------------|--|--|--|----------|--|--|--|-----------|
| Freq                                            | Hrs                                             | Date                                           |                                                                                                                                                                                                                                                                                                                                                                                                                                                                                                                                                                                                                                                                                                                                                                           | Rep Type   |     |      |          |  |  |  |         |  |  |  |            |  |  |  |    |  |  |  |         |  |  |  |         |  |  |  |     |  |  |  |        |  |  |  |        |  |  |  |            |  |  |  |          |  |  |  |           |
|                                                 |                                                 |                                                |                                                                                                                                                                                                                                                                                                                                                                                                                                                                                                                                                                                                                                                                                                                                                                           | Routine    |     |      |          |  |  |  |         |  |  |  |            |  |  |  |    |  |  |  |         |  |  |  |         |  |  |  |     |  |  |  |        |  |  |  |        |  |  |  |            |  |  |  |          |  |  |  |           |
|                                                 |                                                 |                                                |                                                                                                                                                                                                                                                                                                                                                                                                                                                                                                                                                                                                                                                                                                                                                                           | Fract Crit |     |      |          |  |  |  |         |  |  |  |            |  |  |  |    |  |  |  |         |  |  |  |         |  |  |  |     |  |  |  |        |  |  |  |        |  |  |  |            |  |  |  |          |  |  |  |           |
|                                                 |                                                 |                                                |                                                                                                                                                                                                                                                                                                                                                                                                                                                                                                                                                                                                                                                                                                                                                                           | UW         |     |      |          |  |  |  |         |  |  |  |            |  |  |  |    |  |  |  |         |  |  |  |         |  |  |  |     |  |  |  |        |  |  |  |        |  |  |  |            |  |  |  |          |  |  |  |           |
|                                                 |                                                 |                                                |                                                                                                                                                                                                                                                                                                                                                                                                                                                                                                                                                                                                                                                                                                                                                                           | Special    |     |      |          |  |  |  |         |  |  |  |            |  |  |  |    |  |  |  |         |  |  |  |         |  |  |  |     |  |  |  |        |  |  |  |        |  |  |  |            |  |  |  |          |  |  |  |           |
|                                                 |                                                 |                                                |                                                                                                                                                                                                                                                                                                                                                                                                                                                                                                                                                                                                                                                                                                                                                                           | Interim    |     |      |          |  |  |  |         |  |  |  |            |  |  |  |    |  |  |  |         |  |  |  |         |  |  |  |     |  |  |  |        |  |  |  |        |  |  |  |            |  |  |  |          |  |  |  |           |
|                                                 |                                                 |                                                |                                                                                                                                                                                                                                                                                                                                                                                                                                                                                                                                                                                                                                                                                                                                                                           | UWI        |     |      |          |  |  |  |         |  |  |  |            |  |  |  |    |  |  |  |         |  |  |  |         |  |  |  |     |  |  |  |        |  |  |  |        |  |  |  |            |  |  |  |          |  |  |  |           |
|                                                 |                                                 |                                                |                                                                                                                                                                                                                                                                                                                                                                                                                                                                                                                                                                                                                                                                                                                                                                           | Damage     |     |      |          |  |  |  |         |  |  |  |            |  |  |  |    |  |  |  |         |  |  |  |         |  |  |  |     |  |  |  |        |  |  |  |        |  |  |  |            |  |  |  |          |  |  |  |           |
|                                                 |                                                 |                                                |                                                                                                                                                                                                                                                                                                                                                                                                                                                                                                                                                                                                                                                                                                                                                                           | Safety     |     |      |          |  |  |  |         |  |  |  |            |  |  |  |    |  |  |  |         |  |  |  |         |  |  |  |     |  |  |  |        |  |  |  |        |  |  |  |            |  |  |  |          |  |  |  |           |
|                                                 |                                                 |                                                |                                                                                                                                                                                                                                                                                                                                                                                                                                                                                                                                                                                                                                                                                                                                                                           | Short Span |     |      |          |  |  |  |         |  |  |  |            |  |  |  |    |  |  |  |         |  |  |  |         |  |  |  |     |  |  |  |        |  |  |  |        |  |  |  |            |  |  |  |          |  |  |  |           |
|                                                 |                                                 |                                                |                                                                                                                                                                                                                                                                                                                                                                                                                                                                                                                                                                                                                                                                                                                                                                           | In Depth   |     |      |          |  |  |  |         |  |  |  |            |  |  |  |    |  |  |  |         |  |  |  |         |  |  |  |     |  |  |  |        |  |  |  |        |  |  |  |            |  |  |  |          |  |  |  |           |
|                                                 |                                                 |                                                |                                                                                                                                                                                                                                                                                                                                                                                                                                                                                                                                                                                                                                                                                                                                                                           | Geometric  |     |      |          |  |  |  |         |  |  |  |            |  |  |  |    |  |  |  |         |  |  |  |         |  |  |  |     |  |  |  |        |  |  |  |        |  |  |  |            |  |  |  |          |  |  |  |           |
| <input type="checkbox"/> Deck Geometry (1658)   | <input type="checkbox"/> Op RF (1553)           | <input type="checkbox"/> Bridge Rails (1684)   |                                                                                                                                                                                                                                                                                                                                                                                                                                                                                                                                                                                                                                                                                                                                                                           |            |     |      |          |  |  |  |         |  |  |  |            |  |  |  |    |  |  |  |         |  |  |  |         |  |  |  |     |  |  |  |        |  |  |  |        |  |  |  |            |  |  |  |          |  |  |  |           |
| <input type="checkbox"/> Underclearance (1659)  | <input type="checkbox"/> Inventory Tons (1555)  | <input type="checkbox"/> Transition (1685)     |                                                                                                                                                                                                                                                                                                                                                                                                                                                                                                                                                                                                                                                                                                                                                                           |            |     |      |          |  |  |  |         |  |  |  |            |  |  |  |    |  |  |  |         |  |  |  |         |  |  |  |     |  |  |  |        |  |  |  |        |  |  |  |            |  |  |  |          |  |  |  |           |
| <input type="checkbox"/> Alignment (1661)       | <input type="checkbox"/> Inv RF (1556)          | <input type="checkbox"/> Guardrails (1686)     |                                                                                                                                                                                                                                                                                                                                                                                                                                                                                                                                                                                                                                                                                                                                                                           |            |     |      |          |  |  |  |         |  |  |  |            |  |  |  |    |  |  |  |         |  |  |  |         |  |  |  |     |  |  |  |        |  |  |  |        |  |  |  |            |  |  |  |          |  |  |  |           |
| <input type="checkbox"/> Deck Overall (1663)    | <input type="checkbox"/> Operating Level (1660) | <input type="checkbox"/> Terminals (1687)      |                                                                                                                                                                                                                                                                                                                                                                                                                                                                                                                                                                                                                                                                                                                                                                           |            |     |      |          |  |  |  |         |  |  |  |            |  |  |  |    |  |  |  |         |  |  |  |         |  |  |  |     |  |  |  |        |  |  |  |        |  |  |  |            |  |  |  |          |  |  |  |           |
| <input type="checkbox"/> Superstructure (1671)  | <input type="checkbox"/> Open/Closed (1293)     | <input type="checkbox"/> Asphalt Depth (2610)  |                                                                                                                                                                                                                                                                                                                                                                                                                                                                                                                                                                                                                                                                                                                                                                           |            |     |      |          |  |  |  |         |  |  |  |            |  |  |  |    |  |  |  |         |  |  |  |         |  |  |  |     |  |  |  |        |  |  |  |        |  |  |  |            |  |  |  |          |  |  |  |           |
| <input type="checkbox"/> Substructure (1676)    | <input type="checkbox"/> Waterway (1662)        | <input type="checkbox"/> Des Curb Ht (2611)    |                                                                                                                                                                                                                                                                                                                                                                                                                                                                                                                                                                                                                                                                                                                                                                           |            |     |      |          |  |  |  |         |  |  |  |            |  |  |  |    |  |  |  |         |  |  |  |         |  |  |  |     |  |  |  |        |  |  |  |        |  |  |  |            |  |  |  |          |  |  |  |           |
| <input type="checkbox"/> Culvert (1678)         | <input type="checkbox"/> Scour (1680)           | <input type="checkbox"/> Bridge Rail Ht (2612) |                                                                                                                                                                                                                                                                                                                                                                                                                                                                                                                                                                                                                                                                                                                                                                           |            |     |      |          |  |  |  |         |  |  |  |            |  |  |  |    |  |  |  |         |  |  |  |         |  |  |  |     |  |  |  |        |  |  |  |        |  |  |  |            |  |  |  |          |  |  |  |           |
| <input type="checkbox"/> Chan/Protection (1677) | <input type="checkbox"/> Soundings Flag (2693)  | <input type="checkbox"/> Year Built (1332)     |                                                                                                                                                                                                                                                                                                                                                                                                                                                                                                                                                                                                                                                                                                                                                                           |            |     |      |          |  |  |  |         |  |  |  |            |  |  |  |    |  |  |  |         |  |  |  |         |  |  |  |     |  |  |  |        |  |  |  |        |  |  |  |            |  |  |  |          |  |  |  |           |
| <input type="checkbox"/> Pier/Abut/Prot (1679)  | <input type="checkbox"/> Revise Rating (2688)   | <input type="checkbox"/> Year Rebuilt (1336)   |                                                                                                                                                                                                                                                                                                                                                                                                                                                                                                                                                                                                                                                                                                                                                                           |            |     |      |          |  |  |  |         |  |  |  |            |  |  |  |    |  |  |  |         |  |  |  |         |  |  |  |     |  |  |  |        |  |  |  |        |  |  |  |            |  |  |  |          |  |  |  |           |
|                                                 | <input type="checkbox"/> Photos Flag (2691)     |                                                |                                                                                                                                                                                                                                                                                                                                                                                                                                                                                                                                                                                                                                                                                                                                                                           |            |     |      |          |  |  |  |         |  |  |  |            |  |  |  |    |  |  |  |         |  |  |  |         |  |  |  |     |  |  |  |        |  |  |  |        |  |  |  |            |  |  |  |          |  |  |  |           |
|                                                 | <input type="checkbox"/> Measure Clrc (2694)    |                                                |                                                                                                                                                                                                                                                                                                                                                                                                                                                                                                                                                                                                                                                                                                                                                                           |            |     |      |          |  |  |  |         |  |  |  |            |  |  |  |    |  |  |  |         |  |  |  |         |  |  |  |     |  |  |  |        |  |  |  |        |  |  |  |            |  |  |  |          |  |  |  |           |

|                    |
|--------------------|
| Sufficiency Rating |
| Risk Category      |

**BMS Elements**

| Element | Element Description | Total | Units | State 1 | State 2 | State 3 | State 4 |
|---------|---------------------|-------|-------|---------|---------|---------|---------|
|         |                     |       |       |         |         |         |         |

**Notes**

|  |
|--|
|  |
|--|

**Repairs**

| Repair No | Pr | R | Repair Descriptions | Noted | Maint | Verified |
|-----------|----|---|---------------------|-------|-------|----------|
|           |    |   |                     |       |       |          |

**Inspections Performed and Resources Required**

| Report Type | Date | Frq | Hrs | Insp | CertNo | Coinsp | Note |
|-------------|------|-----|-----|------|--------|--------|------|
|             |      |     |     |      |        |        |      |



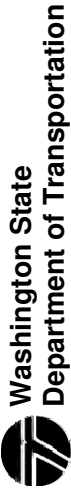

WSBIS Field Inventory Report

|              |
|--------------|
| Approved     |
| Revised      |
| RFC          |
| AAN          |
| Not Reviewed |

|              |               |             |       |        |      |          |          |           |
|--------------|---------------|-------------|-------|--------|------|----------|----------|-----------|
| 1001         | 2089          | 2132        | 1019  | 1021   | 2023 | 1156     | 1188     | 1196      |
| Structure ID | Bridge Number | Bridge Name | Owner | County | City | Location | Latitude | Longitude |
| WB71         |               |             |       |        |      |          |          |           |

|                     |                    |        |           |          |           |
|---------------------|--------------------|--------|-----------|----------|-----------|
| 1222                | 1256               | 1274   | 1286      | 1288     | 1289      |
| Feature Intersected | Facilities Carried | Region | Customian | Parallel | Temporary |
| WB72                |                    |        |           |          |           |

|            |              |               |            |                     |          |                         |                       |                |                 |                    |                |           |                     |                    |                         |                  |            |        |        |  |
|------------|--------------|---------------|------------|---------------------|----------|-------------------------|-----------------------|----------------|-----------------|--------------------|----------------|-----------|---------------------|--------------------|-------------------------|------------------|------------|--------|--------|--|
| 1332       | 1336         | 1340          | 1346       | 1352                | 1356     | 1364                    | 1367                  | 1370           | 1374            | 1378               | 1392           | 1397      | 1413                |                    |                         |                  |            |        |        |  |
| Year Built | Year Rebuilt | Bridge Length | NBS Length | Maximum Span Length | Lanes On | Curb to Curb Deck Width | Out to Out Deck Width | Staircase Left | Staircase Right | Min Vert Over Deck | Min Vert Under | Vert Code | Min Lat Under Right | Min Lat Under Left | Navigation Control Code | Approach Roadway | Skew Angle | Flared | Median |  |
| WB73       |              |               |            |                     |          |                         |                       |                |                 |                    |                |           |                     |                    |                         |                  |            |        |        |  |

|           |          |           |               |              |          |      |         |              |                    |                   |                                |                                  |                          |                          |                            |                            |          |
|-----------|----------|-----------|---------------|--------------|----------|------|---------|--------------|--------------------|-------------------|--------------------------------|----------------------------------|--------------------------|--------------------------|----------------------------|----------------------------|----------|
| 2000      | 1432     | 1433      | 1434          | 1435         | 1445     | 1451 | 1157    | 1487         | 1480               | 1354              | 1481                           | 1485                             | 1499                     | 2500                     | 2501                       | 2502                       | 1413     |
| Main Code | On Under | Hwy Class | Service Level | Route Number | Milepost | ADT  | Truck % | Funct. Class | Lane Use Direction | Total Lanes Under | Horizontal Clearance Route Dir | Horizontal Clearance Reverse Dir | Max Vert Clearance Route | Min Vert Clearance Route | Max Vert Clearance Reverse | Min Vert Clearance Reverse | Route On |
| WB74      |          |           |               |              |          |      |         |              |                    |                   |                                |                                  |                          |                          |                            |                            |          |

|           |          |           |               |              |          |      |         |              |                    |                      |                                |                                  |                          |                          |                            |                            |             |      |
|-----------|----------|-----------|---------------|--------------|----------|------|---------|--------------|--------------------|----------------------|--------------------------------|----------------------------------|--------------------------|--------------------------|----------------------------|----------------------------|-------------|------|
| 2000      | 1432     | 1433      | 1434          | 1435         | 2440     | 1445 | 1451    | 1157         | 1487               | 1480                 | 1354                           | 1481                             | 1485                     | 1499                     | 2500                       | 2501                       | 2502        | 1413 |
| Main Code | On Under | Hwy Class | Service Level | Route Number | Milepost | ADT  | Truck % | Funct. Class | Lane Use Direction | Crossing Description | Horizontal Clearance Route Dir | Horizontal Clearance Reverse Dir | Max Vert Clearance Route | Min Vert Clearance Route | Max Vert Clearance Reverse | Min Vert Clearance Reverse | Route Under |      |
| WB74      |          |           |               |              |          |      |         |              |                    |                      |                                |                                  |                          |                          |                            |                            |             |      |

|                    |                  |                    |                  |                   |                   |            |               |           |                 |                  |              |                    |                  |                    |                    |                  |
|--------------------|------------------|--------------------|------------------|-------------------|-------------------|------------|---------------|-----------|-----------------|------------------|--------------|--------------------|------------------|--------------------|--------------------|------------------|
| 1532               | 1533             | 1535               | 1536             | 1538              | 1541              | 1544       | 1545          | 1546      | 1547            | 1548             | 1549         | 1551               | 1552             | 1553               | 1554               | 1555             |
| Main Span Material | Main Span Design | Appr Span Material | Appr Span Design | Number Main Spans | Number Appr Spans | Service On | Service Under | Deck Type | Wearing Surface | Membrane Protect | Deck Protect | Oper Rating Method | Oper Rating Tons | Oper Rating Factor | Invt Rating Method | Invt Rating Tons |
| WB75               |                  |                    |                  |                   |                   |            |               |           |                 |                  |              |                    |                  |                    |                    |                  |

|                 |           |         |              |      |
|-----------------|-----------|---------|--------------|------|
| 2920            | 1900      | 2646    | 2649         | 2654 |
| Inspection Date | Inspector | Cert No | Co-Inspector |      |
| WB75            |           |         |              |      |

Sufficiency Rating:

|                 |  |
|-----------------|--|
| Item 2710 SR    |  |
| Item 2711 SD/FO |  |

|                 |           |         |              |
|-----------------|-----------|---------|--------------|
| Inspection Date | Inspector | Cert No | Co-Inspector |
|                 |           |         |              |

|                 |           |         |              |
|-----------------|-----------|---------|--------------|
| Inspection Date | Inspector | Cert No | Co-Inspector |
|                 |           |         |              |

|                 |           |         |              |
|-----------------|-----------|---------|--------------|
| Inspection Date | Inspector | Cert No | Co-Inspector |
|                 |           |         |              |

|                 |           |         |              |
|-----------------|-----------|---------|--------------|
| Inspection Date | Inspector | Cert No | Co-Inspector |
|                 |           |         |              |

|                 |           |         |              |
|-----------------|-----------|---------|--------------|
| Inspection Date | Inspector | Cert No | Co-Inspector |
|                 |           |         |              |

|                 |           |         |              |
|-----------------|-----------|---------|--------------|
| Inspection Date | Inspector | Cert No | Co-Inspector |
|                 |           |         |              |

|                 |           |         |              |
|-----------------|-----------|---------|--------------|
| Inspection Date | Inspector | Cert No | Co-Inspector |
|                 |           |         |              |

|        |           |         |              |
|--------|-----------|---------|--------------|
| Safety | Inspector | Cert No | Co-Inspector |
|        |           |         |              |

|            |           |         |              |
|------------|-----------|---------|--------------|
| Short Span | Inspector | Cert No | Co-Inspector |
|            |           |         |              |

|      |           |         |              |
|------|-----------|---------|--------------|
| Info | Inspector | Cert No | Co-Inspector |
|      |           |         |              |

|           |           |         |              |
|-----------|-----------|---------|--------------|
| Inventory | Inspector | Cert No | Co-Inspector |
|           |           |         |              |

|                 |           |         |              |
|-----------------|-----------|---------|--------------|
| Inspection Date | Inspector | Cert No | Co-Inspector |
|                 |           |         |              |

|                 |           |         |              |
|-----------------|-----------|---------|--------------|
| Inspection Date | Inspector | Cert No | Co-Inspector |
|                 |           |         |              |

|                 |           |         |              |
|-----------------|-----------|---------|--------------|
| Inspection Date | Inspector | Cert No | Co-Inspector |
|                 |           |         |              |

|                 |           |         |              |
|-----------------|-----------|---------|--------------|
| Inspection Date | Inspector | Cert No | Co-Inspector |
|                 |           |         |              |

|                 |           |         |              |
|-----------------|-----------|---------|--------------|
| Inspection Date | Inspector | Cert No | Co-Inspector |
|                 |           |         |              |

|                 |           |         |              |
|-----------------|-----------|---------|--------------|
| Inspection Date | Inspector | Cert No | Co-Inspector |
|                 |           |         |              |

WSBIS Form





# Daily Site Dive Log

|                       |                            |                      |          |
|-----------------------|----------------------------|----------------------|----------|
| <b>Inspector</b>      | Generic WSDOT UBITOperator | <b>Date</b>          | 1/1/2001 |
| <b>Bridge No.</b>     | 00000000                   | <b>Bridge Name</b>   | XGOCOUGS |
| <b>Bridge Type</b>    |                            | <b>Waterway Name</b> |          |
| <b>Dive Objective</b> |                            |                      |          |

**Diving Operation**

Type of Operation  SCUBA  Snorkel  ROV  Other \_\_\_\_\_

**Equipment**      **Suit** \_\_\_\_\_

**Air Supply** \_\_\_\_\_

**Site Access** \_\_\_\_\_

**Inspection Tools** \_\_\_\_\_

**Conditions**

**Water**       Salt     Fresh     Brackish    Temperature \_\_\_\_\_ °F    Visibility \_\_\_\_\_ ft

**Surface**       Calm     Choppy     Rough

**Surf**       Small     Medium     Large     N/A

**Tide**       High     Low     Flood     Ebb     N/A

**Current**       Fast     Moderate     Slow    Velocity \_\_\_\_\_ ft/sec

**Weather**       Sunny     Cloudy     Overcast     Rain    Air Temp \_\_\_\_\_ °F

**Thermocline**    Temperature \_\_\_\_\_ °F    Depth \_\_\_\_\_ ft

**Diver Checks**

|                                                            |                                                                 |
|------------------------------------------------------------|-----------------------------------------------------------------|
| <input type="checkbox"/> First Aid Equipment on Site       | <input type="checkbox"/> Physical Condition of Diver(s) Checked |
| <input type="checkbox"/> Communication for EMS             | <input type="checkbox"/> Communications for Diver(s) Checked    |
| <input type="checkbox"/> Dive Gear Inspected               | <input type="checkbox"/> Team Briefed and Understands Dive Plan |
| <input type="checkbox"/> Air Source Checked                | <input type="checkbox"/> Special Site Hazards Noted             |
| <input type="checkbox"/> Pre-Activity Safety Plan Reviewed |                                                                 |
| <input type="checkbox"/> _____                             | <input type="checkbox"/> _____                                  |

**Dive Plan and Dive Team Procedures**

Assess site conditions and determine type of dive operation. Hold on-site pre-dive safety meeting to discuss and plan dive operation, determine roles and responsibilities, review emergency procedures, and check physical condition of diver(s). Assemble and check dive gear. Check communication for diver(s). After completion of dive, review notes, check condition of diver(s), take soundings and photos as required.

**Daily Site Dive Log**



**Washington State  
Department of Transportation**

**VISUAL FRACTURE CRITICAL  
INSPECTION REPORT**

**Bridge Name:**  
**Bridge No:**  
**Structure ID:**  
**Structure Type:**  
**Agency:**  
**Milepost:**

**Date:**  
**Hours:**  
**Inspector ID #:**  
**Lead Inspector Initials:**  
**Co-Inspector Initials:**

**Lead Inspector Signature:** \_\_\_\_\_

**Inspected items:**

**Co-Inspector Signature:** \_\_\_\_\_

**Procedures:**

| FCM Location | FCM Type | FCM Per Girder or Truss Line | Rivet Server Plans |          |          |
|--------------|----------|------------------------------|--------------------|----------|----------|
|              |          |                              | Sh. No.            | Contract | Sh. Name |
|              |          |                              |                    |          |          |
|              |          |                              |                    |          |          |
|              |          |                              |                    |          |          |

Note: FCM = Fracture Critical Member





### Prestressed Concrete Damage Drawing Template

Bridge Number: \_\_\_\_\_ Inspected By: \_\_\_\_\_  
Bridge Name: \_\_\_\_\_ Notes: \_\_\_\_\_  
Date: \_\_\_\_\_  
Loading: \_\_\_\_\_  
Location: \_\_\_\_\_

Bulb

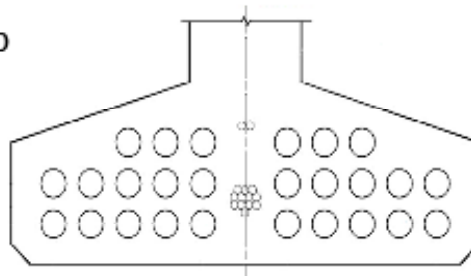

W

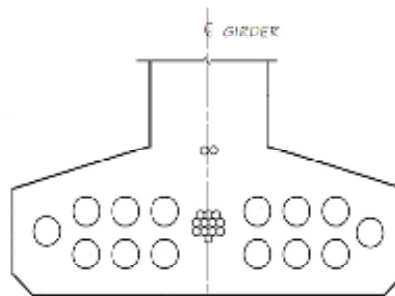

WF

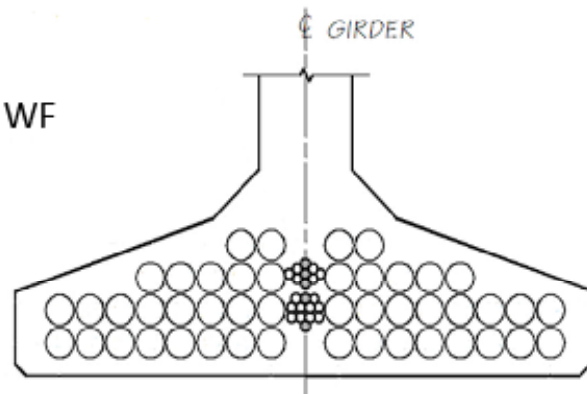

DOT Form 234-030  
Revised 10/2015

### Prestressed Concrete Damage Drawing Template DOT Form 234-030



**Washington State  
Department of Transportation**

**Girder Elevation Template**

Bridge Number: \_\_\_\_\_

Bridge Name: \_\_\_\_\_

Date: \_\_\_\_\_

Inspected By: \_\_\_\_\_

Looking: \_\_\_\_\_

Location: \_\_\_\_\_

Notes: \_\_\_\_\_

**Girder Elevation**

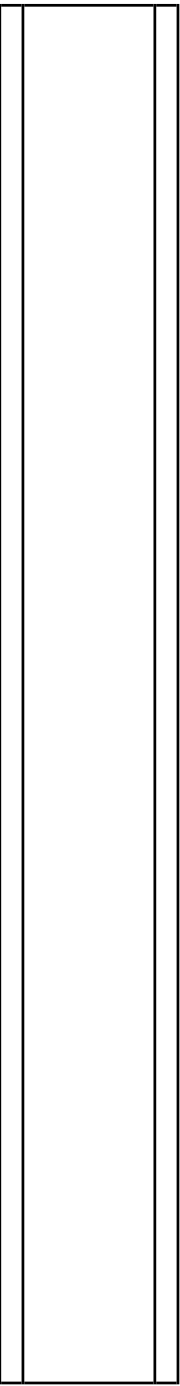

**Girder Bottom**



Drawings not to scale.

DOT Form 234-048  
Revised 10/2015

**Girder Elevation Template**  
**DOT Form 234-048**



**Washington State  
Department of Transportation**

## Fall Protection Plan

|                                                                                                                                                                                                                                                                                                                                                                                                                                                                                                                                                                                                                                                                                                                                                                                                                                                                                                                                                                                                                                                                                                                                                                                                                                                                                                                                                                                                                                          |                                                            |                                                                                                                          |                                           |                                                      |                                                                                                 |                                               |                                                         |                                                              |                                                              |                                                    |                                                                                                                          |                                            |                                                            |                                                                                  |                                      |                                                |  |                                       |  |  |                                      |  |  |
|------------------------------------------------------------------------------------------------------------------------------------------------------------------------------------------------------------------------------------------------------------------------------------------------------------------------------------------------------------------------------------------------------------------------------------------------------------------------------------------------------------------------------------------------------------------------------------------------------------------------------------------------------------------------------------------------------------------------------------------------------------------------------------------------------------------------------------------------------------------------------------------------------------------------------------------------------------------------------------------------------------------------------------------------------------------------------------------------------------------------------------------------------------------------------------------------------------------------------------------------------------------------------------------------------------------------------------------------------------------------------------------------------------------------------------------|------------------------------------------------------------|--------------------------------------------------------------------------------------------------------------------------|-------------------------------------------|------------------------------------------------------|-------------------------------------------------------------------------------------------------|-----------------------------------------------|---------------------------------------------------------|--------------------------------------------------------------|--------------------------------------------------------------|----------------------------------------------------|--------------------------------------------------------------------------------------------------------------------------|--------------------------------------------|------------------------------------------------------------|----------------------------------------------------------------------------------|--------------------------------------|------------------------------------------------|--|---------------------------------------|--|--|--------------------------------------|--|--|
| <b>Date</b>                                                                                                                                                                                                                                                                                                                                                                                                                                                                                                                                                                                                                                                                                                                                                                                                                                                                                                                                                                                                                                                                                                                                                                                                                                                                                                                                                                                                                              | <b>Location</b>                                            | <b>Supervisor</b>                                                                                                        |                                           |                                                      |                                                                                                 |                                               |                                                         |                                                              |                                                              |                                                    |                                                                                                                          |                                            |                                                            |                                                                                  |                                      |                                                |  |                                       |  |  |                                      |  |  |
| <b>Description of Work</b>                                                                                                                                                                                                                                                                                                                                                                                                                                                                                                                                                                                                                                                                                                                                                                                                                                                                                                                                                                                                                                                                                                                                                                                                                                                                                                                                                                                                               |                                                            |                                                                                                                          |                                           |                                                      |                                                                                                 |                                               |                                                         |                                                              |                                                              |                                                    |                                                                                                                          |                                            |                                                            |                                                                                  |                                      |                                                |  |                                       |  |  |                                      |  |  |
| <p><b>Recognized Fall Hazards 10' or more above ground or lower level</b><br/>(check all that apply)</p> <table style="width:100%; border:none;"> <tr> <td><input type="checkbox"/> Catwalks</td> <td><input type="checkbox"/> Drilling shafts</td> <td><input type="checkbox"/> Open-sided walking/working surface<br/>(i.e. roofs, open-sided floors)*</td> </tr> <tr> <td><input type="checkbox"/> Sloped access</td> <td><input type="checkbox"/> Work decks</td> <td><input type="checkbox"/> Skylight openings</td> </tr> <tr> <td><input type="checkbox"/> Work over water</td> <td><input type="checkbox"/> Floor opening</td> <td><input type="checkbox"/> Surfaces that do not meet the definition of a<br/>walking/working surface (i.e. top plate beam)*</td> </tr> <tr> <td><input type="checkbox"/> Welding at height</td> <td><input type="checkbox"/> Wall openings</td> <td><input type="checkbox"/> Overhead hazards<br/>(If checked, specify hazards) _____</td> </tr> <tr> <td><input type="checkbox"/> Set girders</td> <td><input type="checkbox"/> Open-sided ramps.</td> <td></td> </tr> <tr> <td><input type="checkbox"/> Leading edge</td> <td></td> <td></td> </tr> <tr> <td><input type="checkbox"/> Bridge deck</td> <td></td> <td></td> </tr> </table> <p>* Walking/working surface = any area whose dimensions are 45 inches or greater in all direction, through which workers pass or conduct work.</p> |                                                            |                                                                                                                          | <input type="checkbox"/> Catwalks         | <input type="checkbox"/> Drilling shafts             | <input type="checkbox"/> Open-sided walking/working surface<br>(i.e. roofs, open-sided floors)* | <input type="checkbox"/> Sloped access        | <input type="checkbox"/> Work decks                     | <input type="checkbox"/> Skylight openings                   | <input type="checkbox"/> Work over water                     | <input type="checkbox"/> Floor opening             | <input type="checkbox"/> Surfaces that do not meet the definition of a<br>walking/working surface (i.e. top plate beam)* | <input type="checkbox"/> Welding at height | <input type="checkbox"/> Wall openings                     | <input type="checkbox"/> Overhead hazards<br>(If checked, specify hazards) _____ | <input type="checkbox"/> Set girders | <input type="checkbox"/> Open-sided ramps.     |  | <input type="checkbox"/> Leading edge |  |  | <input type="checkbox"/> Bridge deck |  |  |
| <input type="checkbox"/> Catwalks                                                                                                                                                                                                                                                                                                                                                                                                                                                                                                                                                                                                                                                                                                                                                                                                                                                                                                                                                                                                                                                                                                                                                                                                                                                                                                                                                                                                        | <input type="checkbox"/> Drilling shafts                   | <input type="checkbox"/> Open-sided walking/working surface<br>(i.e. roofs, open-sided floors)*                          |                                           |                                                      |                                                                                                 |                                               |                                                         |                                                              |                                                              |                                                    |                                                                                                                          |                                            |                                                            |                                                                                  |                                      |                                                |  |                                       |  |  |                                      |  |  |
| <input type="checkbox"/> Sloped access                                                                                                                                                                                                                                                                                                                                                                                                                                                                                                                                                                                                                                                                                                                                                                                                                                                                                                                                                                                                                                                                                                                                                                                                                                                                                                                                                                                                   | <input type="checkbox"/> Work decks                        | <input type="checkbox"/> Skylight openings                                                                               |                                           |                                                      |                                                                                                 |                                               |                                                         |                                                              |                                                              |                                                    |                                                                                                                          |                                            |                                                            |                                                                                  |                                      |                                                |  |                                       |  |  |                                      |  |  |
| <input type="checkbox"/> Work over water                                                                                                                                                                                                                                                                                                                                                                                                                                                                                                                                                                                                                                                                                                                                                                                                                                                                                                                                                                                                                                                                                                                                                                                                                                                                                                                                                                                                 | <input type="checkbox"/> Floor opening                     | <input type="checkbox"/> Surfaces that do not meet the definition of a<br>walking/working surface (i.e. top plate beam)* |                                           |                                                      |                                                                                                 |                                               |                                                         |                                                              |                                                              |                                                    |                                                                                                                          |                                            |                                                            |                                                                                  |                                      |                                                |  |                                       |  |  |                                      |  |  |
| <input type="checkbox"/> Welding at height                                                                                                                                                                                                                                                                                                                                                                                                                                                                                                                                                                                                                                                                                                                                                                                                                                                                                                                                                                                                                                                                                                                                                                                                                                                                                                                                                                                               | <input type="checkbox"/> Wall openings                     | <input type="checkbox"/> Overhead hazards<br>(If checked, specify hazards) _____                                         |                                           |                                                      |                                                                                                 |                                               |                                                         |                                                              |                                                              |                                                    |                                                                                                                          |                                            |                                                            |                                                                                  |                                      |                                                |  |                                       |  |  |                                      |  |  |
| <input type="checkbox"/> Set girders                                                                                                                                                                                                                                                                                                                                                                                                                                                                                                                                                                                                                                                                                                                                                                                                                                                                                                                                                                                                                                                                                                                                                                                                                                                                                                                                                                                                     | <input type="checkbox"/> Open-sided ramps.                 |                                                                                                                          |                                           |                                                      |                                                                                                 |                                               |                                                         |                                                              |                                                              |                                                    |                                                                                                                          |                                            |                                                            |                                                                                  |                                      |                                                |  |                                       |  |  |                                      |  |  |
| <input type="checkbox"/> Leading edge                                                                                                                                                                                                                                                                                                                                                                                                                                                                                                                                                                                                                                                                                                                                                                                                                                                                                                                                                                                                                                                                                                                                                                                                                                                                                                                                                                                                    |                                                            |                                                                                                                          |                                           |                                                      |                                                                                                 |                                               |                                                         |                                                              |                                                              |                                                    |                                                                                                                          |                                            |                                                            |                                                                                  |                                      |                                                |  |                                       |  |  |                                      |  |  |
| <input type="checkbox"/> Bridge deck                                                                                                                                                                                                                                                                                                                                                                                                                                                                                                                                                                                                                                                                                                                                                                                                                                                                                                                                                                                                                                                                                                                                                                                                                                                                                                                                                                                                     |                                                            |                                                                                                                          |                                           |                                                      |                                                                                                 |                                               |                                                         |                                                              |                                                              |                                                    |                                                                                                                          |                                            |                                                            |                                                                                  |                                      |                                                |  |                                       |  |  |                                      |  |  |
| <p><b>Other Recognized Hazards</b></p> <p><b>Environmental</b></p> <p><input type="checkbox"/> Sun   <input type="checkbox"/> Rain   <input type="checkbox"/> Snow   <input type="checkbox"/> Heat/Ice   <input type="checkbox"/> Cold   <input type="checkbox"/> Noise   <input type="checkbox"/> Darkness</p> <p><b>Live hazards</b></p> <p><input type="checkbox"/> Birds   <input type="checkbox"/> Insects   <input type="checkbox"/> Reptiles   <input type="checkbox"/> Human   <input type="checkbox"/> Other _____</p>                                                                                                                                                                                                                                                                                                                                                                                                                                                                                                                                                                                                                                                                                                                                                                                                                                                                                                          |                                                            |                                                                                                                          |                                           |                                                      |                                                                                                 |                                               |                                                         |                                                              |                                                              |                                                    |                                                                                                                          |                                            |                                                            |                                                                                  |                                      |                                                |  |                                       |  |  |                                      |  |  |
| <p><b>Method of Fall Protection to be Used (check all that apply)</b></p> <table style="width:100%; border:none;"> <tr> <td><input type="checkbox"/> Guardrail system</td> <td><input type="checkbox"/> Personal fall arrest system</td> <td><input type="checkbox"/> Vertical life lines and rope grab</td> </tr> <tr> <td><input type="checkbox"/> Warning line (LSO)**</td> <td><input type="checkbox"/> Personal fall restraint system</td> <td><input type="checkbox"/> Appropriate anchors for system used</td> </tr> <tr> <td><input type="checkbox"/> Warn line w/ safety monitor (LSO)**</td> <td><input type="checkbox"/> Positioning device system</td> <td></td> </tr> <tr> <td><input type="checkbox"/> Catch platform</td> <td><input type="checkbox"/> Covers (floor holes and openings)</td> <td></td> </tr> <tr> <td><input type="checkbox"/> Safety net</td> <td><input type="checkbox"/> Horizontal life lines</td> <td></td> </tr> </table> <p>* Warn line other than (LSO) shall be erected not less than fifteen feet from unprotected sides of edges of the open side surface</p> <p>** LSO = (low slopes only 4:12 or less)</p>                                                                                                                                                                                                                                                                                  |                                                            |                                                                                                                          | <input type="checkbox"/> Guardrail system | <input type="checkbox"/> Personal fall arrest system | <input type="checkbox"/> Vertical life lines and rope grab                                      | <input type="checkbox"/> Warning line (LSO)** | <input type="checkbox"/> Personal fall restraint system | <input type="checkbox"/> Appropriate anchors for system used | <input type="checkbox"/> Warn line w/ safety monitor (LSO)** | <input type="checkbox"/> Positioning device system |                                                                                                                          | <input type="checkbox"/> Catch platform    | <input type="checkbox"/> Covers (floor holes and openings) |                                                                                  | <input type="checkbox"/> Safety net  | <input type="checkbox"/> Horizontal life lines |  |                                       |  |  |                                      |  |  |
| <input type="checkbox"/> Guardrail system                                                                                                                                                                                                                                                                                                                                                                                                                                                                                                                                                                                                                                                                                                                                                                                                                                                                                                                                                                                                                                                                                                                                                                                                                                                                                                                                                                                                | <input type="checkbox"/> Personal fall arrest system       | <input type="checkbox"/> Vertical life lines and rope grab                                                               |                                           |                                                      |                                                                                                 |                                               |                                                         |                                                              |                                                              |                                                    |                                                                                                                          |                                            |                                                            |                                                                                  |                                      |                                                |  |                                       |  |  |                                      |  |  |
| <input type="checkbox"/> Warning line (LSO)**                                                                                                                                                                                                                                                                                                                                                                                                                                                                                                                                                                                                                                                                                                                                                                                                                                                                                                                                                                                                                                                                                                                                                                                                                                                                                                                                                                                            | <input type="checkbox"/> Personal fall restraint system    | <input type="checkbox"/> Appropriate anchors for system used                                                             |                                           |                                                      |                                                                                                 |                                               |                                                         |                                                              |                                                              |                                                    |                                                                                                                          |                                            |                                                            |                                                                                  |                                      |                                                |  |                                       |  |  |                                      |  |  |
| <input type="checkbox"/> Warn line w/ safety monitor (LSO)**                                                                                                                                                                                                                                                                                                                                                                                                                                                                                                                                                                                                                                                                                                                                                                                                                                                                                                                                                                                                                                                                                                                                                                                                                                                                                                                                                                             | <input type="checkbox"/> Positioning device system         |                                                                                                                          |                                           |                                                      |                                                                                                 |                                               |                                                         |                                                              |                                                              |                                                    |                                                                                                                          |                                            |                                                            |                                                                                  |                                      |                                                |  |                                       |  |  |                                      |  |  |
| <input type="checkbox"/> Catch platform                                                                                                                                                                                                                                                                                                                                                                                                                                                                                                                                                                                                                                                                                                                                                                                                                                                                                                                                                                                                                                                                                                                                                                                                                                                                                                                                                                                                  | <input type="checkbox"/> Covers (floor holes and openings) |                                                                                                                          |                                           |                                                      |                                                                                                 |                                               |                                                         |                                                              |                                                              |                                                    |                                                                                                                          |                                            |                                                            |                                                                                  |                                      |                                                |  |                                       |  |  |                                      |  |  |
| <input type="checkbox"/> Safety net                                                                                                                                                                                                                                                                                                                                                                                                                                                                                                                                                                                                                                                                                                                                                                                                                                                                                                                                                                                                                                                                                                                                                                                                                                                                                                                                                                                                      | <input type="checkbox"/> Horizontal life lines             |                                                                                                                          |                                           |                                                      |                                                                                                 |                                               |                                                         |                                                              |                                                              |                                                    |                                                                                                                          |                                            |                                                            |                                                                                  |                                      |                                                |  |                                       |  |  |                                      |  |  |
| <p><b>Other Standards that Apply</b></p> <p><input type="checkbox"/> Boom lift   <input type="checkbox"/> Scaffold w/ guardrail   <input type="checkbox"/> Aerial lift   <input type="checkbox"/> Excavation/Trenching</p> <p><input type="checkbox"/> Scissor lift   <input type="checkbox"/> Ladders   <input type="checkbox"/> Forklift</p>                                                                                                                                                                                                                                                                                                                                                                                                                                                                                                                                                                                                                                                                                                                                                                                                                                                                                                                                                                                                                                                                                           |                                                            |                                                                                                                          |                                           |                                                      |                                                                                                 |                                               |                                                         |                                                              |                                                              |                                                    |                                                                                                                          |                                            |                                                            |                                                                                  |                                      |                                                |  |                                       |  |  |                                      |  |  |
| <p><b>Personal Protection Equipment (PPE) to be used at the worksite</b></p> <p><input type="checkbox"/> Hard hat   <input type="checkbox"/> Rain Gear   <input type="checkbox"/> Gloves   <input type="checkbox"/> Work boot</p> <p><input type="checkbox"/> Safety eyewear   <input type="checkbox"/> Face protection   <input type="checkbox"/> Protective clothing</p> <p><b>Securing tools</b></p> <p><input type="checkbox"/> Tool belts   <input type="checkbox"/> Tool bucket   <input type="checkbox"/> Toe boards   <input type="checkbox"/> Other _____</p>                                                                                                                                                                                                                                                                                                                                                                                                                                                                                                                                                                                                                                                                                                                                                                                                                                                                   |                                                            |                                                                                                                          |                                           |                                                      |                                                                                                 |                                               |                                                         |                                                              |                                                              |                                                    |                                                                                                                          |                                            |                                                            |                                                                                  |                                      |                                                |  |                                       |  |  |                                      |  |  |
| <p><b>Procedure for Assembly, Maintenance, Inspection, and Disassembly of System</b></p> <p>Assembly, disassembly, and maintenance of all equipment will be done according to manufacturer's recommended procedures. A visual inspection of all safety equipment will be done daily or before each use. Any defective equipment will be tagged and removed from service immediately.</p> <div style="border: 1px solid black; height: 40px; width: 100%;"></div>                                                                                                                                                                                                                                                                                                                                                                                                                                                                                                                                                                                                                                                                                                                                                                                                                                                                                                                                                                         |                                                            |                                                                                                                          |                                           |                                                      |                                                                                                 |                                               |                                                         |                                                              |                                                              |                                                    |                                                                                                                          |                                            |                                                            |                                                                                  |                                      |                                                |  |                                       |  |  |                                      |  |  |

DOT Form 750-001 EF  
Revised 10/2013

**A Copy of This Work Plan Must Be On Job Site**



**Emergency Action Plan**

**First Aid / CPR**

Names of Trained Personnel on Site

|  |  |
|--|--|
|  |  |
|--|--|

Location of First Aid Equipment

**Emergency Services** (call or radio 911 if available)

|                   |                                   |                                   |
|-------------------|-----------------------------------|-----------------------------------|
| Location of Phone | Phone Number of Sheriff or Police | Phone No. of Emergency Resp. Team |
|-------------------|-----------------------------------|-----------------------------------|

Describe Procedure for Removal of Injured Employee  
(Note: No removal will be attempted without supervision of qualified emergency rescue personnel)

Crane  Yes  No    Location \_\_\_\_\_

Hoist  Yes  No    Location \_\_\_\_\_

Winch  Yes  No    Location \_\_\_\_\_

Block / Tackle  Yes  No    Location \_\_\_\_\_

Other (Describe)

**Verification of Compliance**

|                    |                    |
|--------------------|--------------------|
| Employee Signature | Employee Signature |
| Employee Signature | Employee Signature |

DOT Form 750-001 EF  
Revised 10/2013

**Fall Protection Plan – Emergency Action Plan**  
*DOT Form 750-001 (Page 2 of 2)*

# Lead Exposure Control Work Plan



No. of People on Crew

\*Supervisor/Competent Person

Date

Project Location

Description of Work (e.g. equipment used, materials involved, special procedures/practices, responsibilities)

\*Supervisor/Competent Person means one who is capable of identifying existing and predictable lead hazards in the surrounding or working conditions and who has authorization to take prompt corrective measures to eliminate them.

| When lead is present if doing these "trigger tasks" (check all that apply)                                                                                                                                                                                                                                                                                                                                                                                            | Treat as if exposed at this level <sup>1</sup>                         | Use appropriate respiratory protection <sup>2</sup> for exposure level (check protection used)                                                                                                                                                                                                                                                                                                                                                                                                                                   | Methods to Reduce/Control Lead Exposure (check all that apply) <sup>3</sup>                                                                                                                                                                                                                                                                                                                                                     |
|-----------------------------------------------------------------------------------------------------------------------------------------------------------------------------------------------------------------------------------------------------------------------------------------------------------------------------------------------------------------------------------------------------------------------------------------------------------------------|------------------------------------------------------------------------|----------------------------------------------------------------------------------------------------------------------------------------------------------------------------------------------------------------------------------------------------------------------------------------------------------------------------------------------------------------------------------------------------------------------------------------------------------------------------------------------------------------------------------|---------------------------------------------------------------------------------------------------------------------------------------------------------------------------------------------------------------------------------------------------------------------------------------------------------------------------------------------------------------------------------------------------------------------------------|
| <input type="checkbox"/> Torch burning<br><input type="checkbox"/> Cutting<br><input type="checkbox"/> Welding<br><input type="checkbox"/> Abrasive blasting<br><input type="checkbox"/> Rivet busting<br><input type="checkbox"/> Lead burning<br><input type="checkbox"/> Power tool cleaning without dust collection systems<br><input type="checkbox"/> Using lead containing mortar<br><input type="checkbox"/> Abrasive blasting enclosure movement and removal | ≥2,500 µg/m3<br>(50 times the PEL or more)                             | <input type="checkbox"/> Full-face PAPR (tight fitting)<br><input type="checkbox"/> Hood or helmet PAPR with manufacturer confirmed APF of 1000<br><input type="checkbox"/> Full-face airline respirator in continuous flow or positive pressure mode<br><br><input type="checkbox"/> Any of the respirators listed above<br><input type="checkbox"/> Full-face respirator<br><input type="checkbox"/> Hood or helmet PAPR<br><input type="checkbox"/> Half-face airline respirator in continuous flow or positive pressure mode | <input type="checkbox"/> Prior removal with tool equipped with dust control<br><input type="checkbox"/> Ventilation (mechanical)<br><input type="checkbox"/> Employee rotation to distribute lead exposed work<br><input type="checkbox"/> Dust suppression/wet methods<br><input type="checkbox"/> Prior removal with chemical stripper<br><input type="checkbox"/> Encapsulation<br><input type="checkbox"/> Other, describe: |
| <input type="checkbox"/> Manual demolition of structures<br><input type="checkbox"/> Manual scraping<br><input type="checkbox"/> Manual sanding<br><input type="checkbox"/> Heat gun applications<br><input type="checkbox"/> Power tools cleaning with dust collection systems<br><input type="checkbox"/> Spray painting with lead paint.<br><input type="checkbox"/> Inspections<br><input type="checkbox"/> Any item not listed                                   | ≥500 µg/m3<br>(10 times the PEL or more)<br><br>≥50 µg/m3 to 500 µg/m3 | <input type="checkbox"/> Any of the respirators listed above<br><input type="checkbox"/> Half-face respirator                                                                                                                                                                                                                                                                                                                                                                                                                    | Contact your safety office for guidance prior to job<br>Contact the safety office prior to job                                                                                                                                                                                                                                                                                                                                  |

<sup>1</sup> If you have recent air monitoring on a similar job (e.g. tasks, equipment, environmental conditions, paint lead content), you can use that to determine exposure.

<sup>2</sup> Other appropriate options may be available. Contact your safety office for more information. APF = assigned protection factor (see WAC 296-842-13005)

## Lead Exposure Control Work Plan DOT Form 750-060 (Page 1 of 2)

<sup>3</sup>All feasible control options must be implemented to reduce exposures below the PEL. If respirators are the only method used to reduce exposures, describe in detail why other controls are not feasible.

---



---



---

**Requirements for all lead work**

All employees trained in lead-safe work practices

Soap, water (drinking water quality), and towels available and used before eating, drinking, smoking, or other "hand to face" activities

on site or  at facility no further than three minutes away

Area for lunch and breaks that is free of lead contamination. List location: \_\_\_\_\_

All employees have been offered/had access to initial blood testing

Other PPE (as applicable) gloves, hardhat, welding gloves, work boots, eye protection/hearing protection

No eating, drinking, smoking, or other hand to face activities conducted in lead work zone

Equipment, tools, work surfaces where lead dust may accumulate are cleaned with HEPA vacuum and/or wet cleaning methods at end of shift  project

Job will be routinely inspected by Supervisor/Competent person

Air monitoring has been performed in the last 12 months on similar job or will be treated as "trigger task" exposures levels listed on previous page

All items below are also required if exposures are at or above the PEL (50 micrograms per cubic meter of air) or doing trigger tasks with no monitoring within previous 12 months showing exposures are below the PEL

Coveralls: worn during all lead work, removed or HEPA vacuumed before entering lunch/break area or leaving work site, and removed at end of shift and placed in sealed and labeled bag or other container that will prevent dispersion of dust. Coveralls or other exposed garments must never be taken home.

Respiratory protection used selected based on either:

1. \_\_\_\_\_ As required by trigger task level

2. \_\_\_\_\_ Recent air monitoring: contact the Safety Office to identify applicable air monitoring

Employees medically cleared for respirator use and fit tested

All employees on job site must sign the lead control plan

|                                          |                                       |                          |                          |
|------------------------------------------|---------------------------------------|--------------------------|--------------------------|
| <input type="checkbox"/>                 | <input type="checkbox"/>              | <input type="checkbox"/> | <input type="checkbox"/> |
| <input type="checkbox"/>                 | <input type="checkbox"/>              | <input type="checkbox"/> | <input type="checkbox"/> |
| <input type="checkbox"/>                 | <input type="checkbox"/>              | <input type="checkbox"/> | <input type="checkbox"/> |
| <input type="checkbox"/>                 | <input type="checkbox"/>              | <input type="checkbox"/> | <input type="checkbox"/> |
| Supervisor/Competent Person Printed Name | Supervisor/Competent Person Signature | Date Signed              |                          |

DOT Form 750-060 EF  
Revised 05/2013

**Lead Exposure Control Work Plan**  
**DOT Form 750-060 (Page 2 of 2)**



# Respirator Record

|                                                                                                                                                                                                                                                                                                                           |                                     |                                                                                                                                                                                                                                                                                                                                                                                                                                              |                                                |
|---------------------------------------------------------------------------------------------------------------------------------------------------------------------------------------------------------------------------------------------------------------------------------------------------------------------------|-------------------------------------|----------------------------------------------------------------------------------------------------------------------------------------------------------------------------------------------------------------------------------------------------------------------------------------------------------------------------------------------------------------------------------------------------------------------------------------------|------------------------------------------------|
| Name                                                                                                                                                                                                                                                                                                                      |                                     | Employee ID Number                                                                                                                                                                                                                                                                                                                                                                                                                           | Organization Code                              |
| Supervisor's Name                                                                                                                                                                                                                                                                                                         |                                     | Telephone Number                                                                                                                                                                                                                                                                                                                                                                                                                             |                                                |
| <b>Exposure</b>                                                                                                                                                                                                                                                                                                           |                                     |                                                                                                                                                                                                                                                                                                                                                                                                                                              |                                                |
| <input type="checkbox"/> Welding/Cutting/Brazing                                                                                                                                                                                                                                                                          | <input type="checkbox"/> Lead       | <input type="checkbox"/> Solvents                                                                                                                                                                                                                                                                                                                                                                                                            | <input type="checkbox"/> Pigeon Droppings      |
| <input type="checkbox"/> Spray Painting                                                                                                                                                                                                                                                                                   | <input type="checkbox"/> Pesticides | <input type="checkbox"/> Bridge Maintenance                                                                                                                                                                                                                                                                                                                                                                                                  | <input type="checkbox"/> Other (Specify) _____ |
| <input type="checkbox"/> Vehicle Body Repair                                                                                                                                                                                                                                                                              | <input type="checkbox"/> Asbestos   | <input type="checkbox"/> Abrasive Blasting                                                                                                                                                                                                                                                                                                                                                                                                   |                                                |
| <input type="checkbox"/> Pavement Marking                                                                                                                                                                                                                                                                                 | <input type="checkbox"/> Silica     | <input type="checkbox"/> Grinding/Sanding                                                                                                                                                                                                                                                                                                                                                                                                    |                                                |
| <b>Fit Test</b>                                                                                                                                                                                                                                                                                                           |                                     |                                                                                                                                                                                                                                                                                                                                                                                                                                              |                                                |
| Date of Fit Test                                                                                                                                                                                                                                                                                                          |                                     | Type of Fit Test Used                                                                                                                                                                                                                                                                                                                                                                                                                        |                                                |
|                                                                                                                                                                                                                                                                                                                           |                                     | <input type="checkbox"/> Qualitative <input type="checkbox"/> Quantitative <input type="checkbox"/> N/A                                                                                                                                                                                                                                                                                                                                      |                                                |
| Tester                                                                                                                                                                                                                                                                                                                    |                                     | <input type="checkbox"/> Pass <input type="checkbox"/> Fail                                                                                                                                                                                                                                                                                                                                                                                  |                                                |
| <b>Respirator</b>                                                                                                                                                                                                                                                                                                         |                                     |                                                                                                                                                                                                                                                                                                                                                                                                                                              |                                                |
| Size<br><input type="checkbox"/> Small <input type="checkbox"/> Medium <input type="checkbox"/> Large                                                                                                                                                                                                                     |                                     | Manufacturer<br><input type="checkbox"/> North <input type="checkbox"/> Northstar<br><input type="checkbox"/> MSA <input type="checkbox"/> American Optical<br><input type="checkbox"/> Willson <input type="checkbox"/> Scott<br><input type="checkbox"/> Survivair <input type="checkbox"/> Glendale<br><input type="checkbox"/> 3M <input type="checkbox"/> Uvex<br><input type="checkbox"/> Bullard <input type="checkbox"/> Other _____ |                                                |
| Facepiece<br><input type="checkbox"/> 1/2 Mask <input type="checkbox"/> Full Face <input type="checkbox"/> Hood/Helmet                                                                                                                                                                                                    |                                     |                                                                                                                                                                                                                                                                                                                                                                                                                                              |                                                |
| Type<br><input type="checkbox"/> SCBA <input type="checkbox"/> Chemical Cartridge<br><input type="checkbox"/> PAPR <input type="checkbox"/> Gas Mask<br><input type="checkbox"/> Air Line <input type="checkbox"/> Combination<br><input type="checkbox"/> Dust / Mist<br><input type="checkbox"/> Other (Describe) _____ |                                     | Model Number <input type="checkbox"/> Approval Number                                                                                                                                                                                                                                                                                                                                                                                        |                                                |
| <b>Comments</b>                                                                                                                                                                                                                                                                                                           |                                     |                                                                                                                                                                                                                                                                                                                                                                                                                                              |                                                |
|                                                                                                                                                                                                                                                                                                                           |                                     |                                                                                                                                                                                                                                                                                                                                                                                                                                              |                                                |

DOT Form 750-090 EF  
Revised 02/2012

**Respirator Record**  
*DOT Form 750-090*



**Washington State  
Department of Transportation**

## Confined Space Entry Permit

|                                                                    |                                  |                |
|--------------------------------------------------------------------|----------------------------------|----------------|
| Location, Description and Classification of Confined Space<br><br> |                                  |                |
| Date                                                               | Purpose of Entry/Work to be done | Time Started   |
| Division/Unit                                                      |                                  | Time Completed |
| Supervisor(s) in Charge of Crew                                    | Type of Crew                     | Phone          |

**Hazards in Confined Space**  
**Check all that apply and ensure each hazard is eliminated or controlled before and during entry:**

|                                                             |                                                                                                                                                    |
|-------------------------------------------------------------|----------------------------------------------------------------------------------------------------------------------------------------------------|
| <input type="checkbox"/> (Potentially) Hazardous atmosphere | <input type="checkbox"/> Trapping or asphyxiation hazard (inwardly covering walls or floor which slopes downwards and tapers to a smaller section) |
| <input type="checkbox"/> Material with potential to engulf  | <input type="checkbox"/> Any Other hazard that is capable of impairing self rescue or presents immediate danger to life or health (describe):      |
| <input type="checkbox"/> Electrical shock                   |                                                                                                                                                    |
| <input type="checkbox"/> Moving parts                       |                                                                                                                                                    |
| <input type="checkbox"/> Temperature extremes               |                                                                                                                                                    |

| Requirements Completed (All applicable must be completed before entry) | Completed                | N/A                      | Requirements Completed (All applicable must be completed before entry) | Completed                | N/A                      |
|------------------------------------------------------------------------|--------------------------|--------------------------|------------------------------------------------------------------------|--------------------------|--------------------------|
| Lockout - De-energize                                                  | <input type="checkbox"/> | <input type="checkbox"/> | First Aid/CPR Equipment & Trained Personnel                            | <input type="checkbox"/> | <input type="checkbox"/> |
| Line(s) Broken, Capped or Blanked                                      | <input type="checkbox"/> | <input type="checkbox"/> | Communication Equipment                                                | <input type="checkbox"/> | <input type="checkbox"/> |
| Purge, Flush, and Vent                                                 | <input type="checkbox"/> | <input type="checkbox"/> | Secure area (post, flag and protect from falling objects)              | <input type="checkbox"/> | <input type="checkbox"/> |
| Ventilation                                                            | <input type="checkbox"/> | <input type="checkbox"/> | Hot Work Permit                                                        | <input type="checkbox"/> | <input type="checkbox"/> |
| Lighting (explosion proof as necessary)                                | <input type="checkbox"/> | <input type="checkbox"/> | <b>Add any other requirements necessary for entry</b>                  |                          |                          |
| Respirator (list type)                                                 | <input type="checkbox"/> | <input type="checkbox"/> |                                                                        |                          |                          |
| Protective Clothing                                                    | <input type="checkbox"/> | <input type="checkbox"/> |                                                                        |                          |                          |
| Standby Safety Personnel                                               | <input type="checkbox"/> | <input type="checkbox"/> |                                                                        |                          |                          |
| Full Body Harness with "D" Ring                                        | <input type="checkbox"/> | <input type="checkbox"/> |                                                                        |                          |                          |
| Emergency Escape/Retrieval/Rescue/Equipment                            | <input type="checkbox"/> | <input type="checkbox"/> |                                                                        |                          |                          |
| Lifelines                                                              | <input type="checkbox"/> | <input type="checkbox"/> |                                                                        |                          |                          |

| Atmospheric Checks  | Acceptable Conditions | Initial Checks | Checks After Isolation and Ventilation | Periodic Checks |      |      |      |      |      |      |      |  |
|---------------------|-----------------------|----------------|----------------------------------------|-----------------|------|------|------|------|------|------|------|--|
|                     |                       |                |                                        | Hr 1            | Hr 2 | Hr 3 | Hr 4 | Hr 5 | Hr 6 | Hr 7 | Hr 8 |  |
| % of Oxygen         | 19.5% to 23%          |                |                                        |                 |      |      |      |      |      |      |      |  |
| L.E.L. <sup>1</sup> | ≤ 10%                 |                |                                        |                 |      |      |      |      |      |      |      |  |
| Carbon Monoxide     | < 35 ppm              |                |                                        |                 |      |      |      |      |      |      |      |  |
| Hydrogen Sulfide    | < 10 ppm              |                |                                        |                 |      |      |      |      |      |      |      |  |
|                     |                       |                |                                        |                 |      |      |      |      |      |      |      |  |

Atmospheric monitoring conducted by: \_\_\_\_\_

Note: continuous/periodic tests shall be performed throughout the job. Contact Region Safety Office with questions.

<sup>1</sup> L.E.L. Lower Explosive Limit, also referred to as lower flammable limit (LFL).  
 Records must be maintained for at least one year.

DOT Form 750-094 EF  
 Revised 08/2011  
 Distribution: Original to Division/Unit, Copy to Regional Safety Office

### Confined Space Entry Permit DOT Form 750-094 (Page 1 of 2)

| Sampling Equipment | Name | Model/Type | Date Calibrated | Identification Number |
|--------------------|------|------------|-----------------|-----------------------|
|                    |      |            |                 |                       |
|                    |      |            |                 |                       |

Communication procedures between entrants and attendants

**Emergency Services**

Emergency services must be arranged **prior** to **permit-required** confined space entry (**including 911 services**). Only persons who have been trained and equipped for entry rescue may enter the space to perform rescue services. Do **not** attempt an entry rescue if you are not trained and equipped to do so. If a person is down for no apparent cause, you must assume that toxic gases or an oxygen deficiency exist.

Emergency/Rescue Service Provided by

Phone Number/Contact Information

Describe Procedures (include necessary equipment):

| Print Name | Initial | Authorized Role <sup>2</sup>                                        |
|------------|---------|---------------------------------------------------------------------|
|            |         | <input type="checkbox"/> Entrant <input type="checkbox"/> Attendant |
|            |         | <input type="checkbox"/> Entrant <input type="checkbox"/> Attendant |
|            |         | <input type="checkbox"/> Entrant <input type="checkbox"/> Attendant |
|            |         | <input type="checkbox"/> Entrant <input type="checkbox"/> Attendant |
|            |         | <input type="checkbox"/> Entrant <input type="checkbox"/> Attendant |
|            |         | <input type="checkbox"/> Entrant <input type="checkbox"/> Attendant |
|            |         | <input type="checkbox"/> Entrant <input type="checkbox"/> Attendant |

<sup>2</sup> Check the person's authorized role. Remember, a person cannot be both an attendant and entrant; they can only serve one role.

|                                                                                   |      |
|-----------------------------------------------------------------------------------|------|
| <b>Entry Supervisor Authorization - All Entry Conditions Satisfied</b>            |      |
| Signature                                                                         | Date |
| Permit expiration date and time (may not be longer than required to perform work) |      |
| Date                                                                              | Time |
| Post entry review of permit conducted by                                          | Date |

Post entry reviews must be done within one year of entry.

DOT Form 750-094 EF  
Revised 08/2011

Distribution: Original to Division/Unit, Copy to Regional Safety Office

**Confined Space Entry Permit**  
**DOT Form 750-094 (Page 2 of 2)**



**Washington State  
Department of Transportation**

**UT INSPECTION REPORT**

Bridge Name:  
 Bridge No:  
 Structure ID:  
 Structure Type:  
 Agency:  
 Milepost:

Date:  
 Hours:  
 Inspector ID #:  
 Lead Inspector Initials:  
 Co-Inspector Initials:

Inspected items:

Procedures:

- Pins**
1. When possible, test from both ends of pins.
  2. Verify pin length shown on back reflection with plans. If back reflection does not match the plans, conduct manual length measurement and document correct pin length.
  3. Start test with transducer at or near pin center for back reflection check, then run transducer around full perimeter of pin, searching for indications or significant loss of back reflection.
  4. Whenever the test suggests that there is a defect in a pin, store and print out the indication with all associated equipment and settings documented. The location of the transducer shall also be documented using a clock hand convention (1 O'clock to 12 O'clock).

| UTM Location | UTM Type | UTM Per Girder or Truss Line | Rivet Server Plans |          |          |
|--------------|----------|------------------------------|--------------------|----------|----------|
|              |          |                              | Sh. No.            | Contract | Sh. Name |
|              |          |                              |                    |          |          |
|              |          |                              |                    |          |          |
|              |          |                              |                    |          |          |

Note: UTM = Ultrasonic Tested Member

|                                               |                                                                  |                                        |
|-----------------------------------------------|------------------------------------------------------------------|----------------------------------------|
| LEFT END<br><input type="text"/> FACE         | PROFILE LOOKING AHEAD ON STATION<br>LOOKING <input type="text"/> | RIGHT END<br><input type="text"/> FACE |
|                                               |                                                                  |                                        |
| H = <input type="text"/> in.                  |                                                                  |                                        |
| STRUCTURE I.D.<br>TRUSS or GIRDER<br>PIN I.D. |                                                                  |                                        |
| DATE                                          |                                                                  |                                        |
| <<<<<<< LEFT END >>>>>>>                      |                                                                  |                                        |
| COMMENTS:                                     |                                                                  |                                        |
| <<<<<<< RIGHT END >>>>>>>                     |                                                                  |                                        |
| COMMENTS:                                     |                                                                  |                                        |

**Ultrasonic UT Inspection Report**  
(Page 2 of 2)





# Washington State Department of Transportation

## UT INSPECTION SCHEDULE

**Bridge Name:**  
**Bridge No.:**  
**Structure ID:**  
**Structure Type:**  
**Agency:**  
**Milepost:**  
**Date:**  
**Hours:**  
**Inspector ID #:**  
**Lead Inspector:**  
**Co-Inspector:**

| Truss / Girder | Span | Location | Detail Description | Redundant | Condition State |    | Freq. (Months) | UT Inspection Date | Next Inspection Date |
|----------------|------|----------|--------------------|-----------|-----------------|----|----------------|--------------------|----------------------|
|                |      |          |                    |           | VT              | UT |                |                    |                      |
|                |      |          |                    |           |                 |    |                |                    |                      |
|                |      |          |                    |           |                 |    |                |                    |                      |
|                |      |          |                    |           |                 |    |                |                    |                      |
|                |      |          |                    |           |                 |    |                |                    |                      |
|                |      |          |                    |           |                 |    |                |                    |                      |
|                |      |          |                    |           |                 |    |                |                    |                      |
|                |      |          |                    |           |                 |    |                |                    |                      |
|                |      |          |                    |           |                 |    |                |                    |                      |
|                |      |          |                    |           |                 |    |                |                    |                      |
|                |      |          |                    |           |                 |    |                |                    |                      |
|                |      |          |                    |           |                 |    |                |                    |                      |
|                |      |          |                    |           |                 |    |                |                    |                      |
|                |      |          |                    |           |                 |    |                |                    |                      |
|                |      |          |                    |           |                 |    |                |                    |                      |
|                |      |          |                    |           |                 |    |                |                    |                      |
|                |      |          |                    |           |                 |    |                |                    |                      |
|                |      |          |                    |           |                 |    |                |                    |                      |

UT Inspection Schedule





**Washington State  
Department of Transportation**

**PIN AND HANGER VISUAL  
INSPECTION REPORT**

**Bridge Name:**  
**Bridge No:**  
**Structure ID:**  
**Structure Type:**  
**Agency:**  
**Milepost:**

**Date:**  
**Hours:**  
**Inspector ID #:**  
**Lead Inspector Initials:**  
**Co-Inspector Initials:**

**Lead Inspector Signature:** \_\_\_\_\_

**Inspected Items:** Pins & Hanger Assemblies

**Co-Inspector Signature:** \_\_\_\_\_

**Procedures:**

**Hangers**

1. As required, use mirrors or other equipment to check inside surfaces of members.
2. Check for loose or unevenly loaded member sub-elements.
3. Check all rivets at connection plates, with emphasis on first row. The first row is the row closest to the edge of the connection or gusset plate.
4. Check for any welds, including plug, tack, or repair welds. Record location of welds, regardless of condition, and document weld type and category.
5. Check members and associated connection or gusset plates for areas of heavy or pitted corrosion, nicks, gouges, sharp bends, and collision damage. Record location of all these conditions and estimated section loss, if applicable.
6. Check all heat straightened or repaired areas. Record location of these areas, regardless of condition.

**Pins and Anchor Bolts**

1. As required, use mirrors or other equipment to check inside surfaces of members.
2. Check for pitting, laminar rust, surface deformation, and pack rust. It is important to check the pin, pin nuts, and all members surrounding the pin for this kind of steel deterioration.
3. Check for mobility and noise of pin and surrounding members. If the pin is physically "frozen" it is important to note this because the added stress can affect other members in the structure.
4. Observe and record abnormalities like; alignment, pin wear, loose pin nuts, and amount of nut engagement. It's important to note that full nut engagement is when the nut is flush with the pin or the pin is extending past the nut.
5. Check for paint system failure on pin nuts, pin, and surrounding members.

| Location | Type | Member Per Girder or Truss Line | Rivet Server Plans |          |          |
|----------|------|---------------------------------|--------------------|----------|----------|
|          |      |                                 | Sh. No.            | Contract | Sh. Name |
|          |      |                                 |                    |          |          |
|          |      |                                 |                    |          |          |
|          |      |                                 |                    |          |          |





**SPECIAL FEATURES  
INSPECTION REPORT**

Bridge Name:  
 Bridge No:  
 Structure ID:  
 Structure Type:  
 Agency:  
 Milepost:

Date:  
 Hours:  
 Inspector ID #:  
 Lead Inspector Initials:  
 Co-Inspector Initials:

Lead Inspector Signature: \_\_\_\_\_

Inspected items:

Co-Inspector Signature: \_\_\_\_\_

Procedures:

| Special Features | Specail Features Type | FCM Per Girder or Truss Line | Rivet Server Plans |          |          |
|------------------|-----------------------|------------------------------|--------------------|----------|----------|
|                  |                       |                              | Sh. No.            | Contract | Sh. Name |
|                  |                       |                              |                    |          |          |
|                  |                       |                              |                    |          |          |
|                  |                       |                              |                    |          |          |

Note: FCM = Fracture Critical Member

**Special Features Inspection Report  
(Page 1 of 2)**

**SPECIAL FEATURES  
INSPECTION REPORT**



**Bridge Name:**  
**Bridge No.:**  
**Structure ID:**  
**Structure Type:**  
**Agency:**  
**Milepost:**  
**Date:**  
**Hours:**  
**Inspector ID #:**  
**Lead Inspector:**  
**Co-Inspector:**

| Girder | Pier | Location | Feature Inspected | Detail Description | Remarks |
|--------|------|----------|-------------------|--------------------|---------|
|        |      |          |                   |                    |         |
|        |      |          |                   |                    |         |
|        |      |          |                   |                    |         |

|                                                                            |  |
|----------------------------------------------------------------------------|--|
| Bridge Number:                                                             |  |
| Structure ID:                                                              |  |
| Looking:                                                                   |  |
| Measurement Date:                                                          |  |
| Photo Date:                                                                |  |
| Inspection/Co Initials:                                                    |  |
| Minimum Vertical Clearance Posted For:                                     |  |
| Posting on Structure:                                                      |  |
| Posting on Shoulder:                                                       |  |
| Advance Detour Intersection Posting for Vertical Clearance 14'-0" or less: |  |

Note:

Vertical measurements are actual measures rounded down to the nearest inch. Posted clearances are typically 3 inches less than the lowest clearance for a particular through movement.

---



---



---

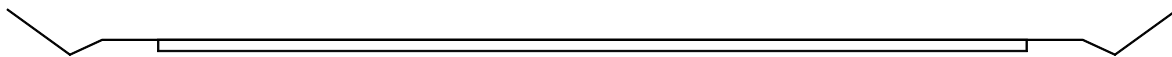



---



---

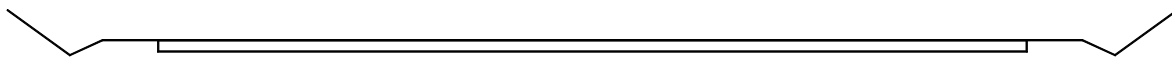

---



**Vertical Clearance Card Generic**

|                                                                            |  |
|----------------------------------------------------------------------------|--|
| Bridge Number:                                                             |  |
| Structure ID:                                                              |  |
| Looking:                                                                   |  |
| Measurement Date:                                                          |  |
| Photo Date:                                                                |  |
| Inspection/Co Initials:                                                    |  |
| Minimum Vertical Clearance Posted For:                                     |  |
| Posting on Structure:                                                      |  |
| Posting on Shoulder:                                                       |  |
| Advance Detour Intersection Posting for Vertical Clearance 14'-0" or less: |  |

Note:  
 Vertical measurements are actual measures rounded down to the nearest inch. Posted clearances are typically 3 inches less than the lowest clearance for a particular through movement.

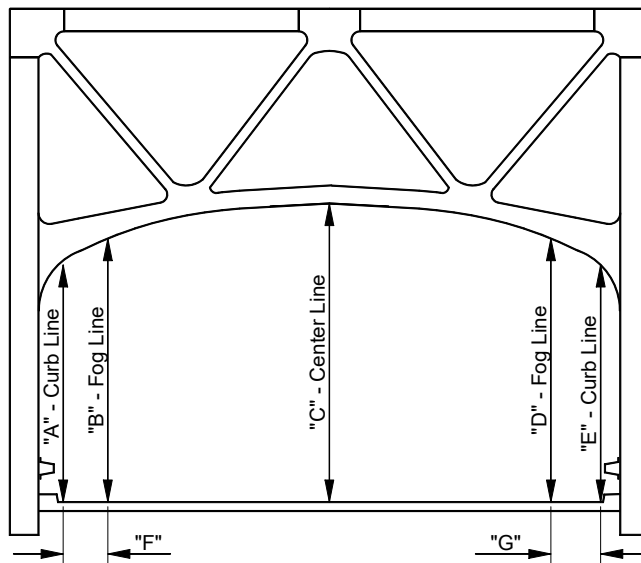

| Location | Field Measurement |   |   |   |   |   |   |
|----------|-------------------|---|---|---|---|---|---|
|          | A                 | B | C | D | E | F | G |
|          |                   |   |   |   |   |   |   |
|          |                   |   |   |   |   |   |   |
|          |                   |   |   |   |   |   |   |
|          |                   |   |   |   |   |   |   |
|          |                   |   |   |   |   |   |   |
|          |                   |   |   |   |   |   |   |
|          |                   |   |   |   |   |   |   |
|          |                   |   |   |   |   |   |   |
|          |                   |   |   |   |   |   |   |
|          |                   |   |   |   |   |   |   |
|          |                   |   |   |   |   |   |   |
|          |                   |   |   |   |   |   |   |
|          |                   |   |   |   |   |   |   |
|          |                   |   |   |   |   |   |   |
|          |                   |   |   |   |   |   |   |
|          |                   |   |   |   |   |   |   |
|          |                   |   |   |   |   |   |   |
|          |                   |   |   |   |   |   |   |
|          |                   |   |   |   |   |   |   |
|          |                   |   |   |   |   |   |   |
|          |                   |   |   |   |   |   |   |
|          |                   |   |   |   |   |   |   |
|          |                   |   |   |   |   |   |   |
|          |                   |   |   |   |   |   |   |
|          |                   |   |   |   |   |   |   |

**Vertical Clearance Card Steel**





## Bridge Inspection Pre-Activity Safety Plan Cover Sheet

This pre-activity safety plan covers all bridge inspection activities as indicated below for the WEEK/WEEKEND OF \_\_\_\_\_ TO \_\_\_\_\_.

LOCATION: BR NOs & MPs \_\_\_\_\_.

COUNTIES \_\_\_\_\_.

Our signatures below indicate that we have read the safety plan, that we understand the hazards related to the activities to be conducted, and that we will apply the appropriate controls to minimize the risks of accident and injury during the inspections.

LEAD INSPECTOR: \_\_\_\_\_ DATE: \_\_\_\_\_  
(Name/Signature/Initials)

CO-INSPECTOR: \_\_\_\_\_ DATE: \_\_\_\_\_  
(Name/Signature/Initials)

UBIT DRIVER: \_\_\_\_\_ DATE: \_\_\_\_\_  
(Name/Signature/Initials)

Our initials below indicate that we have discussed and reaffirmed the hazards, risks and control measures prior to the start of daily activities (Tailgate Safety Meetings) *[For use on multiple-day inspections]*

|                | DATE |  |  |  |  |
|----------------|------|--|--|--|--|
|                |      |  |  |  |  |
| LEAD INSPECTOR |      |  |  |  |  |
| CO-INSPECTOR   |      |  |  |  |  |
| UBIT DRIVER    |      |  |  |  |  |

Activities to be conducted during the above inspection dates (check all that apply):

|                                                                                                                                                                                                                                                                                                                   |                                                                                                                                                                         |
|-------------------------------------------------------------------------------------------------------------------------------------------------------------------------------------------------------------------------------------------------------------------------------------------------------------------|-------------------------------------------------------------------------------------------------------------------------------------------------------------------------|
| <input type="checkbox"/> <b>General Bridge Inspection Activities</b><br><input type="checkbox"/> Routine Inspection<br><input type="checkbox"/> Short Span Inspection<br><input type="checkbox"/> Safety Inspection<br><input type="checkbox"/> Interim Inspection<br><input type="checkbox"/> Special Inspection | <input type="checkbox"/> <b>Equipment Bridge Inspection using a Bucket Truck, Man Lift, or other Boom Truck</b><br><input type="checkbox"/> Attach Fall Protection Plan |
| <input type="checkbox"/> <b>UBIT Bridge Inspection</b><br><input type="checkbox"/> Attach Fall Protection Plan                                                                                                                                                                                                    | <input type="checkbox"/> <b>Bridge Climbing Inspection</b><br><input type="checkbox"/> Attach Fall Protection Plan                                                      |
| <input type="checkbox"/> <b>Damage Inspection</b><br><input type="checkbox"/> Attach Fall Protection Plan                                                                                                                                                                                                         | <input type="checkbox"/> <b>Confined Space Entry</b><br><input type="checkbox"/> Attach Confined Entry Plan                                                             |
| <input type="checkbox"/> <b>Scour Site Visit Bridge Inspection</b>                                                                                                                                                                                                                                                | <input type="checkbox"/> <b>Underwater Inspection</b>                                                                                                                   |
| <input type="checkbox"/> <b>Boat Inspection</b>                                                                                                                                                                                                                                                                   | <input type="checkbox"/> <b>Nondestructive Testing</b>                                                                                                                  |
| <input type="checkbox"/>                                                                                                                                                                                                                                                                                          | <input type="checkbox"/>                                                                                                                                                |

Fill out the cover page to the Pre-Activity Safety Plan for each inspection trip. For multiple crew inspections fill out a sheet for each crew. For multiple bridges where more room is needed to list the bridges above attach a list of the bridges. This cover sheet must be filled out before the activities starts and must be present on site during the activities. Maintain these coversheets in chronological order in front of the Pre-Activity Safety Plan section of the Safety Binder and keep in the inspection vehicle. The lead inspector is responsible for all on site safety matters.

## Bridge Inspection Pre-Activity Safety Plan

**Goal:** The Washington State Department of Transportation (WSDOT) is committed to providing a healthy and safe workplace for all personnel; zero injuries, accidents, exposures, and the control of occupational hazards are key components of the goal.

**Purpose:** The purpose of the Pre-Activity Safety Plan is to provide a tool for inspection crews and supervisors to use in conducting safety training and tailgate briefings in order to identify hazards, assess the risks, and to implement control measures to minimize the risk of accidents and injuries while performing bridge inspection activities.

**General:** Bridges have many different hazards that may be encountered during inspection. There are two major types of inspection that generally occur, ROUTINE inspections and EQUIPMENT inspections using a UBIT (Under Bridge Inspection Truck), Bucket Truck, Man Lift, and other boom trucks.

Routine inspection entails a quick (generally <1 hour) inspection of a bridge by doing a walk-around and checking various bridge components. Routine inspections are generally a part of all inspections. Safety and Short Span inspections are special type inspections similar to routine inspections. The hazards associated with the Routine Inspections are inherent in these as well. Special Inspections and Interim Inspections can be in the form of a walking inspection similar to routine inspections and/or an equipment inspection.

Equipment inspections are performed in addition to routine inspections on bridges that require a close in depth inspection of areas that cannot be reached or safely reached on foot, ladder, or by remote devices such as fiber optic devices. Fracture Critical bridges are almost always inspected with equipment as are most of the Special Inspections and Damage Inspections. Equipment inspections are almost always in the form of a UBIT Inspection (see Figure 1) and are often accompanied by the use of a bucket truck, Genie Lift, and/or other man lift/boom trucks. They may also be performed without a UBIT truck based on the requirements of the inspection.

Lift trucks are often rented. Because there are many different brands and types of lift trucks, it is the responsibility of the inspection crew to inspect the equipment for serviceability and to ensure training on the particular piece of equipment is received prior to its use.

Equipment inspections almost always require a traffic control plan, flagging operations, and/or Truck Mounted Attenuators (TMAs) often referred to an 'Attenuator'. In most cases the region maintenance crew will develop the traffic control plan and provide flagging and attenuators as needed. This does not relieve the inspection crew of ensuring safety regarding these activities.

Bridge Climbing is an inspection technique used when a close in depth look of areas are required and an equipment inspection is not feasible such as when the areas may be out of reach of the equipment, load restrictions prohibit the use of equipment, or traffic control issues might prohibit the use of equipment. Climbing inspection activities may include rope access, in which a rope

access plan shall be developed for the specific bridge and supplement this Pre-activity Safety Plan (PASP).



Figure 1 Typical multi-crew UBIT inspection

Scour inspections are performed on bridges over waterways and can be performed by walking, wading, boat, and or SCUBA diving (Underwater Inspection). Many times a scour evaluation is conducted in conjunction with routine and/or equipment inspections and requires measuring the depth and profile of the channel from the bridge deck with a rod or an incremented line and weight. Traffic and fall hazards are of concern in these cases, both of which have to be addressed simultaneously. When wading, or boating operations are performed, water safety needs to be addressed.

**Bridge Preservation Office personnel are highly trained in the performance of their field activities. This PASP addresses all inspections that may occur on any bridge throughout the state. Hazards that are specific to a particular bridge will be addressed on-site. Discussion notes and mitigation measures are to be added to this PASP whenever specific hazards not already covered are found at a particular bridge site.**

**Typical Procedures:**

**Routine Inspections:** Lane closure is seldom necessary. There are two inspectors working out of one vehicle. The passenger navigates as the driver drives to the bridge. When arriving at the bridge, the inspector turns on the overhead beacons and finds a safe place to park near the bridge and out of traffic. Inspectors get out and inspect the abutments and walk the deck on foot.

**Equipment Inspections:** Closure of a lane is performed by maintenance crews. When the work zone is set up, maintenance will radio the inspection crew that they are ready. The UBIT and/or other equipment trucks will then enter the work zone. The engineers' inspection vehicle will follow behind. The engineers will then get in the UBIT truck (or other equipment) and start the inspection. After the UBIT inspection is complete, the engineers will finish the bridge by walking the deck and inspecting the abutments on foot.

For bucket truck operations without region traffic control (off the shoulder work), the inspectors will establish a safety zone and cone off the shoulder. Early warning signs may be required in accordance with Work Zone Traffic Control Guidelines, M 54-44.04

**Scour Site Visit:** A lane closure is seldom necessary. There are generally two inspectors working out of one vehicle. The passenger navigates as the driver drives to the bridge. When arriving at the bridge, the inspector turns on the overhead beacons and finds a safe place to park near the bridge and out of traffic. Inspectors get out and inspect the abutments, intermediate piers, and the associated waterway. When required, soundings from the bridge rail to the channel bed will be measured to create a stream cross section sketch.

**Tasks, Hazards, and Controls:**

| TASK                      | HAZARDS | CONTROL<br>When controls cannot be met as specified below or by readily available equivalent mitigating measures, the activity will be aborted and rescheduled after a specific plan of action is devised to mitigate the specific circumstances. |
|---------------------------|---------|---------------------------------------------------------------------------------------------------------------------------------------------------------------------------------------------------------------------------------------------------|
| All Inspection Activities | Noise   | Hearing conservation education. Wear hearing protection.                                                                                                                                                                                          |

|                                  |                                   |                                                                                                                                                                                                                                                                                                                                                               |
|----------------------------------|-----------------------------------|---------------------------------------------------------------------------------------------------------------------------------------------------------------------------------------------------------------------------------------------------------------------------------------------------------------------------------------------------------------|
| <b>All Inspection Activities</b> | Traffic                           | If accident occurs, dial 911. If joint measurements are required, one inspector watches traffic to ensure the other can safely measure joints. Always walk the bridge decks in teams of two with one person inspecting and the other having the duties as a safety monitor.                                                                                   |
| <b>All Inspection Activities</b> | Needles/feces                     | Stay alert for these and avoid. See Appendix C.                                                                                                                                                                                                                                                                                                               |
| <b>All Inspection Activities</b> | Pigeon guano                      | Avoid disturbance of guano                                                                                                                                                                                                                                                                                                                                    |
| <b>All Inspection Activities</b> | Transients                        | Avoid transients and travel in pairs using the buddy system. Announce presence to transients.                                                                                                                                                                                                                                                                 |
| <b>All Inspection Activities</b> | Weather                           | Not inspecting during thunderstorms and icy conditions.                                                                                                                                                                                                                                                                                                       |
| <b>All Inspection Activities</b> | Walking the deck (moving Traffic) | Walk in a direction facing oncoming traffic. Be aware of escape routes in case of emergency.                                                                                                                                                                                                                                                                  |
| <b>All Inspection Activities</b> | Walking the deck (Fall Hazard)    | Bridge decks with rails less than 39" will be protected against inadvertent falls using a safety monitor. Using the 2-man inspection crew, one is the inspector, the other is the safety monitor. The safety monitor's only duty is to ensure the inspector's safety by watching the hazards and alerting the inspector as necessary when the risk increases. |

**Pre-Activity Safety Plan (PASP)**  
 (Page 5 of 23)

|                                  |                                    |                                                                                                                                                                                                                                                                  |
|----------------------------------|------------------------------------|------------------------------------------------------------------------------------------------------------------------------------------------------------------------------------------------------------------------------------------------------------------|
| <b>All Inspection Activities</b> | Hazardous Materials                | Review MSDS for all hazardous materials being used or expected to be encountered.                                                                                                                                                                                |
| <b>All Inspection Activities</b> | Snake and spider bites             | Provide first aid and drive to hospital if bitten. Take the offending animal with you ONLY if doing so does not create further hazard (i.e. the animal is dead). Be prepared to describe the animal if it cannot be taken. See Appendix D for the hospital list. |
| <b>All Inspection Activities</b> | Struck by falling objects          | Avoid walking and working under suspended loads. Hard hats must be worn when working around backhoes, cranes, excavators, etc.                                                                                                                                   |
| <b>All Inspection Activities</b> | Weather related illness            | Take extra precautions to prevent heat and cold stress when working in extremely hot or cold temperatures.                                                                                                                                                       |
| <b>All Inspection Activities</b> | Strains and sprains due to Lifting | Proper lifting techniques shall be used. Get help or use lifting/hoisting equipment if necessary.                                                                                                                                                                |

**Pre-Activity Safety Plan (PASP)**  
(Page 6 of 23)

|                                                                                     |                                      |                                                                                                                                                                                                                                                                            |
|-------------------------------------------------------------------------------------|--------------------------------------|----------------------------------------------------------------------------------------------------------------------------------------------------------------------------------------------------------------------------------------------------------------------------|
| <b>All Inspection Activities</b>                                                    | Slips trips and falls (General)      | Be aware of loose materials, excavation drop-off, tripping hazards and other obstructions. Keep walk spaces and work areas free from loose materials or tools. Avoid dangerous terrain when possible. Use alternate route.                                                 |
| <b>All Inspection Activities</b>                                                    | Slips trips and falls (Steep Slopes) | Steep slopes (typically 2 vertical to 1 horizontal) are to be assessed on-site. A plan will be discussed to protect inadvertent falls before negotiating the slope. Surface conditions and weather are part of the assessment which can turn a lesser slope into a hazard. |
| <b>Confined Space Inspection Activities</b>                                         | Confined space entry in box girders. | Complete confined space entry plan (Appendix A) if the confined space is permit required. Carry gas monitors while performing inspection. Use the buddy system. If asphyxiation of person in confined space occurs, partner dials 911 instead of entering the space.       |
| <b>All Inspection Activities requiring the use of Ladders</b>                       | Falling from ladder.                 | Find stable footing for ladder. Have co-inspector help with anchoring ladder base.                                                                                                                                                                                         |
| <b>All Inspection Activities requiring Wading</b>                                   | Falling, drowning                    | Use probe to help balance and to avoid drop-offs.                                                                                                                                                                                                                          |
| <b>All Inspection Activities requiring the use of Hand Tools (Power and Manual)</b> | Cuts, pinches and debris in eyes.    | Follow operating instructions. Use appropriate PPEs.                                                                                                                                                                                                                       |

**Pre-Activity Safety Plan (PASP)**  
 (Page 7 of 23)



|                                                                                   |                                                                                                  |                                                                                                                                                                                                                                                                                                                                                                                                                                                                                                                                                                                                                                                              |
|-----------------------------------------------------------------------------------|--------------------------------------------------------------------------------------------------|--------------------------------------------------------------------------------------------------------------------------------------------------------------------------------------------------------------------------------------------------------------------------------------------------------------------------------------------------------------------------------------------------------------------------------------------------------------------------------------------------------------------------------------------------------------------------------------------------------------------------------------------------------------|
| <b>All Inspection Activities requiring the negotiation of Fences and Barriers</b> | Falling, strains and cuts                                                                        | Use fence climber tool. Cut fence if required. Attempt to find alternate route.                                                                                                                                                                                                                                                                                                                                                                                                                                                                                                                                                                              |
| <b>All Inspection Activities requiring reaching across Bridge Rails</b>           | Falling                                                                                          | When inspection activities require reaching or looking over the bridge rail the following requirements will be met: The deck surface will be free of debris that may pose a slipping or tripping hazard. Three points of contact (minimum) will be maintained at all times, two of which will be both feet flat on the bridge deck or sidewalk (the third can be a hand or arm) such that the body is braced at all times to prevent falling over. And, a safety Monitor will be used. The second person in the inspection team will be designated as a safety monitor and will have only the duties of observing for and alerting the inspector of hazards. |
| <b>All Inspection Activities around and near Railways</b>                         | Railroad beneath the bridge                                                                      | Obtain flagging from the Railroad. If RR flagging is not present, maintain a minimum of 25 ft. clear distance from the track centerline.                                                                                                                                                                                                                                                                                                                                                                                                                                                                                                                     |
| <b>Bucket truck or manlift inspection.</b>                                        | The hazards present are the same for UBIT inspection except that this equipment is often rented. | Careful inspection of manlift equipment before use.                                                                                                                                                                                                                                                                                                                                                                                                                                                                                                                                                                                                          |
| <b>Work Boat</b>                                                                  | Struck by, drowning                                                                              | Perform pre-operational checks, PFD.                                                                                                                                                                                                                                                                                                                                                                                                                                                                                                                                                                                                                         |
| <b>Fences</b>                                                                     | Falling, strains and cuts                                                                        | Use fence climber tool. Cut fence if required. Attempt to find alternate route.                                                                                                                                                                                                                                                                                                                                                                                                                                                                                                                                                                              |
| <b>Nondestructive testing: Dye Penetrant, Ultrasonic</b>                          | Paint/ dye penetrant inhalation                                                                  | Taking care not to inhale fumes. Not smoking while handling these products.                                                                                                                                                                                                                                                                                                                                                                                                                                                                                                                                                                                  |

**Pre-Activity Safety Plan (PASP)**  
(Page 8 of 23)

|                                       |                           |                                                                                                                                                                                                                                               |
|---------------------------------------|---------------------------|-----------------------------------------------------------------------------------------------------------------------------------------------------------------------------------------------------------------------------------------------|
| <b>UBIT and Equipment Inspections</b> | Falling                   | Complete fall protection plan (Appendix B). Use and follow fall protection plan.                                                                                                                                                              |
| <b>UBIT and Equipment Inspections</b> | Power lines               | Maintain distances on power lines as called out on safety placard posted on UBIT bucket. Shut down power in lines when bridge is unable to be inspected without maintaining a safe distance. If electrocution occurs, dial 911 on cell phone. |
| <b>UBIT and Equipment Inspections</b> | Traffic                   | Set up flagging on bridge to take the lane (performed by maintenance).                                                                                                                                                                        |
| <b>UBIT and Equipment Inspections</b> | Hydraulic failure in UBIT | If total failure occurs, use Rollgliss.                                                                                                                                                                                                       |
| <b>UBIT and Equipment Inspections</b> | Weather                   | Not inspecting during thunderstorms and icy conditions.                                                                                                                                                                                       |
| <b>UBIT and Equipment Inspections</b> | Struck by falling objects | Avoid walking and working under suspended loads. Hard hats must be worn when working around backhoes, cranes, excavators, etc.                                                                                                                |
| <b>UBIT and Equipment Inspections</b> | Weather related illness   | Take extra precautions to prevent heat and cold stress when working in extremely hot or cold temperatures.                                                                                                                                    |
| <b>UBIT and Equipment Inspections</b> | Overhead hazards.         | Wearing hard-hats while inspecting in and around equipment.                                                                                                                                                                                   |
| <b>UBIT and Equipment Inspections</b> | Lead exposure             | When grinding occurs, use dust masks to prevent inhalation of dust. Wear coveralls to keep dust off clothes. Use eye protection.                                                                                                              |
| <b>UBIT Inspections</b>               | Hydraulic failure in UBIT | If total failure occurs, use Rogliss.                                                                                                                                                                                                         |

**Pre-Activity Safety Plan (PASP)**  
 (Page 9 of 23)

|                                 |                                               |                                                                                                                                                                                                                                                                                                                                                                                                                                                                                                                                                                                                                                                                     |
|---------------------------------|-----------------------------------------------|---------------------------------------------------------------------------------------------------------------------------------------------------------------------------------------------------------------------------------------------------------------------------------------------------------------------------------------------------------------------------------------------------------------------------------------------------------------------------------------------------------------------------------------------------------------------------------------------------------------------------------------------------------------------|
| <p><b>Scour Inspections</b></p> | <p>Taking Soundings from the bridge rail.</p> | <p>When inspection activities require reaching or looking over the bridge rail the following requirements will be met: The deck surface will be free of debris that may pose a slipping or tripping hazard. Three points of contact (minimum) will be maintained at all times, two of which will be both feet flat on the bridge deck or sidewalk (the third can be a hand or arm) such that the body is braced at all times to prevent falling over. And, a safety Monitor will be used. The second person in the inspection team will be designated as a safety monitor and will have only the duties of observing for and alerting the inspector of hazards.</p> |
|                                 |                                               |                                                                                                                                                                                                                                                                                                                                                                                                                                                                                                                                                                                                                                                                     |
|                                 |                                               |                                                                                                                                                                                                                                                                                                                                                                                                                                                                                                                                                                                                                                                                     |
|                                 |                                               |                                                                                                                                                                                                                                                                                                                                                                                                                                                                                                                                                                                                                                                                     |
|                                 |                                               |                                                                                                                                                                                                                                                                                                                                                                                                                                                                                                                                                                                                                                                                     |
|                                 |                                               |                                                                                                                                                                                                                                                                                                                                                                                                                                                                                                                                                                                                                                                                     |
|                                 |                                               |                                                                                                                                                                                                                                                                                                                                                                                                                                                                                                                                                                                                                                                                     |

**Pre-Activity Safety Plan (PASP)**  
 (Page 10 of 23)

APPENDIX A: CONFINED SPACE ENTRY



Washington State  
Department of Transportation

Confined Space Entry and Hot Work Permit

NOTE: This form is required to be completed, appropriately signed prior to, and utilized during entry into any confined space.

|                                                                                                                                                            |          |        |                       |
|------------------------------------------------------------------------------------------------------------------------------------------------------------|----------|--------|-----------------------|
| Confined Space ID No.                                                                                                                                      |          | Region | Region Safety Manager |
| Type of Work:<br><input type="checkbox"/> Overhead<br><input type="checkbox"/> Under Foot                                                                  | Location |        |                       |
| Purpose of Entry                                                                                                                                           |          |        |                       |
| This space entered _____ times per <input type="checkbox"/> Day <input type="checkbox"/> Week <input type="checkbox"/> Month <input type="checkbox"/> Year |          |        |                       |
| Description of Work                                                                                                                                        |          |        |                       |
| Employees Assigned Entry                                                                                                                                   |          |        | Date / Time Issued    |
| Authorized Attendants                                                                                                                                      |          |        | Date / Time Expired   |

| Have the Following Precautions Been Taken?                                      | Yes | No | N/A |
|---------------------------------------------------------------------------------|-----|----|-----|
| Were hazards, testing, and emergency procedures discussed?                      |     |    |     |
| Have authorized entrants and attendants been trained regarding confined spaces? |     |    |     |
| Has safety equipment been properly calibrated and checked?                      |     |    |     |
| Have the duties of the authorized entrants and attendants been discussed?       |     |    |     |
| Have emergency response or rescue procedures been discussed?                    |     |    |     |

**What are the Potential Work Hazards? (Check all that apply)**

|                                                                          |                                              |                                               |                                     |                                             |
|--------------------------------------------------------------------------|----------------------------------------------|-----------------------------------------------|-------------------------------------|---------------------------------------------|
| <input type="checkbox"/> Corrosives                                      | <input type="checkbox"/> Flammable Materials | <input type="checkbox"/> Hazardous Atmosphere | <input type="checkbox"/> Mechanical | <input type="checkbox"/> Ladders Over 10 F. |
| <input type="checkbox"/> Hot Work (riveting, welding, grinding, burning) | <input type="checkbox"/> Dust                | <input type="checkbox"/> Electrical           | <input type="checkbox"/> Biological | <input type="checkbox"/> Temperature        |
| <input type="checkbox"/> Other (specify):                                |                                              |                                               |                                     |                                             |

**Personal Protective and Safety Equipment? (Check all that apply)**

|                                                                        |                                                   |                                                    |                                  |
|------------------------------------------------------------------------|---------------------------------------------------|----------------------------------------------------|----------------------------------|
| <input type="checkbox"/> Atmosphere Monitoring (complete next section) | <input type="checkbox"/> Communications Equipment | <input type="checkbox"/> Respiratory Protection    | <input type="checkbox"/> Hearing |
| <input type="checkbox"/> Life Lines and Harness                        | <input type="checkbox"/> Ventilation Equipment    | <input type="checkbox"/> Head, Hand, Foot, and Eye |                                  |
| <input type="checkbox"/> Other (specify):                              |                                                   |                                                    |                                  |

DOT Form 750-094 EF  
Revised 2/2000

APPENDIX A –PAGE 1

Pre-Activity Safety Plan (PASP)  
(Page 11 of 23)

APPENDIX B: TOWER AND BRIDGE FALL PROTECTION PLAN



Tower and Bridge  
Fall Protection Plan

|                                                                                                                                                                                                                                                                                                                                                                                                                                                                                                                                                                                                                                                                                                                                                                                                                                                                                                                                                                                                                                                                                                                                                                                                                                           |          |             |
|-------------------------------------------------------------------------------------------------------------------------------------------------------------------------------------------------------------------------------------------------------------------------------------------------------------------------------------------------------------------------------------------------------------------------------------------------------------------------------------------------------------------------------------------------------------------------------------------------------------------------------------------------------------------------------------------------------------------------------------------------------------------------------------------------------------------------------------------------------------------------------------------------------------------------------------------------------------------------------------------------------------------------------------------------------------------------------------------------------------------------------------------------------------------------------------------------------------------------------------------|----------|-------------|
| Date                                                                                                                                                                                                                                                                                                                                                                                                                                                                                                                                                                                                                                                                                                                                                                                                                                                                                                                                                                                                                                                                                                                                                                                                                                      | Location | Prepared By |
| Description of Work                                                                                                                                                                                                                                                                                                                                                                                                                                                                                                                                                                                                                                                                                                                                                                                                                                                                                                                                                                                                                                                                                                                                                                                                                       |          |             |
| <b>Recognized Fall Hazards</b><br><input type="checkbox"/> Tower <input type="checkbox"/> Bridge <input type="checkbox"/> Non-Standard <input type="checkbox"/> Ladder w/o Fall Restraint<br><input type="checkbox"/> Self-Support <input type="checkbox"/> Suspension <input type="checkbox"/> Roof Top <input type="checkbox"/> Step Bolts w/o Fall Restraint<br><input type="checkbox"/> Guyed <input type="checkbox"/> Cantilever <input type="checkbox"/> Building Side <input type="checkbox"/> Work Deck w/o Fall Restraint<br><input type="checkbox"/> Monopole <input type="checkbox"/> Arch <input type="checkbox"/> Highway Sign Structure <input type="checkbox"/> Rest Platform w/o Fall Restraint<br><input type="checkbox"/> Light Pole <input type="checkbox"/> Draw <input type="checkbox"/> Other <input type="checkbox"/> Other<br><input type="checkbox"/> Wooden Pole <input type="checkbox"/> Other _____<br><input type="checkbox"/> Walkway w/o Fall Restraint                      _____<br><input type="checkbox"/> Staircase w/o Fall Restraint                      _____ <input type="checkbox"/> Motorized Vehicular Traffic<br><input type="checkbox"/> Weakened or Damage (e.g., missing member/hardware) |          |             |
| <b>Recognized Environmental Hazards</b><br><input type="checkbox"/> Sun <input type="checkbox"/> Rain <input type="checkbox"/> Snow <input type="checkbox"/> Heat/Ice <input type="checkbox"/> Cold <input type="checkbox"/> Noise <input type="checkbox"/> Darkness                                                                                                                                                                                                                                                                                                                                                                                                                                                                                                                                                                                                                                                                                                                                                                                                                                                                                                                                                                      |          |             |
| <b>Recognized Live Hazards</b><br><input type="checkbox"/> Birds <input type="checkbox"/> Insects <input type="checkbox"/> Reptiles <input type="checkbox"/> Human <input type="checkbox"/> Other _____                                                                                                                                                                                                                                                                                                                                                                                                                                                                                                                                                                                                                                                                                                                                                                                                                                                                                                                                                                                                                                   |          |             |
| <b>Other Recognized Hazards</b><br><input type="checkbox"/> Electrical <input type="checkbox"/> Rf Exposure                                                                                                                                                                                                                                                                                                                                                                                                                                                                                                                                                                                                                                                                                                                                                                                                                                                                                                                                                                                                                                                                                                                               |          |             |
| <b>Method of Fall Restraint and/or Arrest (PFAS) to be Used</b><br><input type="checkbox"/> Work Deck <input type="checkbox"/> Full Body Harness <input type="checkbox"/> Work Platform<br><input type="checkbox"/> Railing <input type="checkbox"/> Shock Absorbing Lanyard <input type="checkbox"/> Rest Platform<br><input type="checkbox"/> Positioning Lanyard <input type="checkbox"/> Self Retracting Lanyard <input type="checkbox"/> Walkway<br><input type="checkbox"/> Ladder Safety Climb <input type="checkbox"/> Vertical Life Line <input type="checkbox"/> Tie-Off Point<br><input type="checkbox"/> Warning Signs Lines <input type="checkbox"/> Horizontal Life Line                      Capable of 5,000 Lbs. per Person                                                                                                                                                                                                                                                                                                                                                                                                                                                                                              |          |             |
| <b>Personal Protection Equipment (PPE) to be Used</b><br><input type="checkbox"/> Hard Hat <input type="checkbox"/> Gloves                      Tool Handling:<br><input type="checkbox"/> Safety Eyewear <input type="checkbox"/> Heaving Clothing <input type="checkbox"/> Tool Belts<br><input type="checkbox"/> Rain Wear <input type="checkbox"/> Heavy Footwear <input type="checkbox"/> Tool Bucket<br><input type="checkbox"/> Face Wear <input type="checkbox"/> Other _____ <input type="checkbox"/> Other _____                                                                                                                                                                                                                                                                                                                                                                                                                                                                                                                                                                                                                                                                                                                |          |             |
| <b>Method of Hoisting Used</b><br><input type="checkbox"/> Winch <input type="checkbox"/> Block and Tackle <input type="checkbox"/> Capstan <input type="checkbox"/> Manual <input type="checkbox"/> Crane <input type="checkbox"/> Boom Truck                                                                                                                                                                                                                                                                                                                                                                                                                                                                                                                                                                                                                                                                                                                                                                                                                                                                                                                                                                                            |          |             |
| <b>Method of Manriding Line Used</b><br><input type="checkbox"/> Descent/Suspension w/PFAS <input type="checkbox"/> Ascending/Decending w/PFAS                                                                                                                                                                                                                                                                                                                                                                                                                                                                                                                                                                                                                                                                                                                                                                                                                                                                                                                                                                                                                                                                                            |          |             |

**Note:** Upon hearing the sound of thunder, caused by lightening strike activity, all high structure climbing and work shall cease and all climbing personnel are to immediately mobilize safely off the structure and seek shelter below the tower. Work shall not resume until it is deemed safe.

DOT Form 750-001A EF  
1/2005



APPENDIX A: CONFINED SPACE ENTRY

**Atmospheric Monitoring Equipment/Instrument**

|                     |       |            |
|---------------------|-------|------------|
| Make                | Model | Serial No. |
| Date of Calibration | Other |            |

**Atmospheric Monitoring Equipment - Equipment Check and Calibration**

Concentration of Calibration Gases and Instrument Readings: Gas Concentration / Instrument Reading

Oxygen                      Flammables                      Carbon Monoxide                      Other: \_\_\_\_\_

\_\_\_\_\_

**Note:** Make sure calibration gas cylinders have not expired. If the instrument readings are not within 5-10% of the known gas concentrations, recalibrate or send in to manufacturer for recalibration.

**Atmospheric Test Results**

| Date / Time | Oxygen | Flammability | Carbon Monoxide | Other |
|-------------|--------|--------------|-----------------|-------|
|             |        |              |                 |       |
|             |        |              |                 |       |
|             |        |              |                 |       |
|             |        |              |                 |       |
|             |        |              |                 |       |
|             |        |              |                 |       |
|             |        |              |                 |       |
|             |        |              |                 |       |
|             |        |              |                 |       |
|             |        |              |                 |       |

Is "hot work" (riveting, welding, cutting, brazing, burning, grinding) to be performed in the confined space?  Yes  No  
 If Yes, complete the Hot Work Section. If No, skip to Page 3, Qualified Person Verification and Signature Section

**Hot Work**

Description of Work or Equipment Presenting a Potential Ignition Source or Generating a Hazardous Atmosphere

---

Have employees been properly trained, advised, and monitored with regards to hot work performed in confined spaces?  
 Yes  No **IF YOU ANSWERED NO, STOP ALL WORK ACTIVITIES AND CONSULT WITH MANAGERS.**

Does the working surface or equipment being used have a potential of generating toxic gases, fumes, dust, or vapors? Check all that apply:

Welding Rods and Flux     Silica or Respirable Dusts     Oxygen Displacement     Other \_\_\_\_\_  
 Lead Paint / Paint     Animal Wastes     Carbon Monoxide    \_\_\_\_\_

Describe in detail the type of ventilation (volumes, air exchanges, air intakes, that will be used to remove the gases, fumes, dust, or vapors.

DOT Form 750-004 EF  
 Revised 3/2000

APPENDIX A: CONFINED SPACE ENTRY

**Hot Work - Continued**

Describe in detail the personal protective equipment to be used during the hot work activities:

|                                  |
|----------------------------------|
| Respiratory Requirements:        |
| Atmosphere Monitoring Equipment: |
| Rescue Equipment or Rescue Team: |
| Fire Extinguishing Media:        |
| Head, Foot, Hand, Eye:           |
| Other:                           |

**Atmospheric Monitoring Data During Hot Work (must be continuous)**

| Date / Time | Oxygen | Flammability | Carbon Monoxide | Other |
|-------------|--------|--------------|-----------------|-------|
|             |        |              |                 |       |
|             |        |              |                 |       |
|             |        |              |                 |       |
|             |        |              |                 |       |
|             |        |              |                 |       |
|             |        |              |                 |       |
|             |        |              |                 |       |
|             |        |              |                 |       |
|             |        |              |                 |       |
|             |        |              |                 |       |
|             |        |              |                 |       |

Is employee exposure monitoring being performed during the hot work activities?     Yes     No    If yes, describe the monitoring:

**Qualified Person Verification and Signature**

I have verified the procedures and work activities and have briefed the Authorized Entrants and Attendants on the proper practices and associated hazards of confined spaces and the associated work activities.

|                               |              |      |
|-------------------------------|--------------|------|
| Name of Qualified Person      | Phone        | Date |
| Signature of Qualified Person | Organization |      |

*This Confined Space Entry and Hot Work Permit serves as a master record for data and information collected during the field operations and confined space entry. The qualified person shall annually provide copies of the completed forms to their respective Region Safety Manager. It is recommended that all completed forms be kept on file for at least five years.*

DOT Form 750-094 EF  
Revised 2/2000



APPENDIX B: TOWER AND BRIDGE FALL PROTECTION PLAN



Tower and Bridge  
Fall Protection Plan

|                                                                                                                                                                                                                                                                                                                                                                                                                                                                                                                                                                                                                                                                                                                                                                                                                                                                                                                                                                                                                                                                                                                                                                                                                                           |          |             |
|-------------------------------------------------------------------------------------------------------------------------------------------------------------------------------------------------------------------------------------------------------------------------------------------------------------------------------------------------------------------------------------------------------------------------------------------------------------------------------------------------------------------------------------------------------------------------------------------------------------------------------------------------------------------------------------------------------------------------------------------------------------------------------------------------------------------------------------------------------------------------------------------------------------------------------------------------------------------------------------------------------------------------------------------------------------------------------------------------------------------------------------------------------------------------------------------------------------------------------------------|----------|-------------|
| Date                                                                                                                                                                                                                                                                                                                                                                                                                                                                                                                                                                                                                                                                                                                                                                                                                                                                                                                                                                                                                                                                                                                                                                                                                                      | Location | Prepared By |
| Description of Work                                                                                                                                                                                                                                                                                                                                                                                                                                                                                                                                                                                                                                                                                                                                                                                                                                                                                                                                                                                                                                                                                                                                                                                                                       |          |             |
| <b>Recognized Fall Hazards</b><br><input type="checkbox"/> Tower <input type="checkbox"/> Bridge <input type="checkbox"/> Non-Standard <input type="checkbox"/> Ladder w/o Fall Restraint<br><input type="checkbox"/> Self-Support <input type="checkbox"/> Suspension <input type="checkbox"/> Roof Top <input type="checkbox"/> Step Bolts w/o Fall Restraint<br><input type="checkbox"/> Guyed <input type="checkbox"/> Cantilever <input type="checkbox"/> Building Side <input type="checkbox"/> Work Deck w/o Fall Restraint<br><input type="checkbox"/> Monopole <input type="checkbox"/> Arch <input type="checkbox"/> Highway Sign Structure <input type="checkbox"/> Rest Platform w/o Fall Restraint<br><input type="checkbox"/> Light Pole <input type="checkbox"/> Draw <input type="checkbox"/> Other <input type="checkbox"/> Other<br><input type="checkbox"/> Wooden Pole <input type="checkbox"/> Other _____<br><input type="checkbox"/> Walkway w/o Fall Restraint                      _____<br><input type="checkbox"/> Staircase w/o Fall Restraint                      _____ <input type="checkbox"/> Motorized Vehicular Traffic<br><input type="checkbox"/> Weakened or Damage (e.g., missing member/hardware) |          |             |
| <b>Recognized Environmental Hazards</b><br><input type="checkbox"/> Sun <input type="checkbox"/> Rain <input type="checkbox"/> Snow <input type="checkbox"/> Heat/Ice <input type="checkbox"/> Cold <input type="checkbox"/> Noise <input type="checkbox"/> Darkness                                                                                                                                                                                                                                                                                                                                                                                                                                                                                                                                                                                                                                                                                                                                                                                                                                                                                                                                                                      |          |             |
| <b>Recognized Live Hazards</b><br><input type="checkbox"/> Birds <input type="checkbox"/> Insects <input type="checkbox"/> Reptiles <input type="checkbox"/> Human <input type="checkbox"/> Other _____                                                                                                                                                                                                                                                                                                                                                                                                                                                                                                                                                                                                                                                                                                                                                                                                                                                                                                                                                                                                                                   |          |             |
| <b>Other Recognized Hazards</b><br><input type="checkbox"/> Electrical <input type="checkbox"/> Rf Exposure                                                                                                                                                                                                                                                                                                                                                                                                                                                                                                                                                                                                                                                                                                                                                                                                                                                                                                                                                                                                                                                                                                                               |          |             |
| <b>Method of Fall Restraint and/or Arrest (PFAS) to be Used</b><br><input type="checkbox"/> Work Deck <input type="checkbox"/> Full Body Harness <input type="checkbox"/> Work Platform<br><input type="checkbox"/> Railing <input type="checkbox"/> Shock Absorbing Lanyard <input type="checkbox"/> Rest Platform<br><input type="checkbox"/> Positioning Lanyard <input type="checkbox"/> Self Retracting Lanyard <input type="checkbox"/> Walkway<br><input type="checkbox"/> Ladder Safety Climb <input type="checkbox"/> Vertical Life Line <input type="checkbox"/> Tie-Off Point<br><input type="checkbox"/> Warning Signs Lines <input type="checkbox"/> Horizontal Life Line                      Capable of 5,000 Lbs. per Person                                                                                                                                                                                                                                                                                                                                                                                                                                                                                              |          |             |
| <b>Personal Protection Equipment (PPE) to be Used</b><br><input type="checkbox"/> Hard Hat <input type="checkbox"/> Gloves                      Tool Handling:<br><input type="checkbox"/> Safety Eyewear <input type="checkbox"/> Heaving Clothing <input type="checkbox"/> Tool Belts<br><input type="checkbox"/> Rain Wear <input type="checkbox"/> Heavy Footwear <input type="checkbox"/> Tool Bucket<br><input type="checkbox"/> Face Wear <input type="checkbox"/> Other _____ <input type="checkbox"/> Other _____                                                                                                                                                                                                                                                                                                                                                                                                                                                                                                                                                                                                                                                                                                                |          |             |
| <b>Method of Hoisting Used</b><br><input type="checkbox"/> Winch <input type="checkbox"/> Block and Tackle <input type="checkbox"/> Capstan <input type="checkbox"/> Manual <input type="checkbox"/> Crane <input type="checkbox"/> Boom Truck                                                                                                                                                                                                                                                                                                                                                                                                                                                                                                                                                                                                                                                                                                                                                                                                                                                                                                                                                                                            |          |             |
| <b>Method of Manriding Line Used</b><br><input type="checkbox"/> Descent/Suspension w/PFAS <input type="checkbox"/> Ascending/Decending w/PFAS                                                                                                                                                                                                                                                                                                                                                                                                                                                                                                                                                                                                                                                                                                                                                                                                                                                                                                                                                                                                                                                                                            |          |             |

**Note:** Upon hearing the sound of thunder, caused by lightening strike activity, all high structure climbing and work shall cease and all climbing personnel are to immediately mobilize safely off the structure and seek shelter below the tower. Work shall not resume until it is deemed safe.

DOT Form 750-001A EF  
1/2005



## APPENDIX C: BLOODBORNE PATHOGENS

**BLOODBORNE PATHOGENS  
EXPOSURE CONTROL PLAN**

Facility Name: Bridge Preservation Office

Date of Preparation: February 21, 2007

**A. Purpose**

The Bloodborne Pathogens Exposure Control Plan is to reduce or eliminate occupational exposure to bloodborne pathogens.

**B. Exposure Determination**

Employees that may come into contact with human blood or other potentially infectious materials (OPIM) are listed on Page 5 of this appendix.

**C. Methods of Compliance**

Universal Precautions will be utilized in the handling of all human blood and OPIMs. Please refer to WSDOT's Bloodborne Pathogens Policy, Chapter 7 of Safety Procedures and Guidelines Manual, M75-01.

**D. Engineering Controls**

1. Employees will wash their hands and any other exposed skin thoroughly with soap and hot water immediately or as soon as possible after contact with blood or OPIM in a manner causing friction on both inner and outer surfaces of the hands.
2. Employees will be provided with antiseptic hand cleaner and paper towels when hand washing is not feasible. However, hand washing must still take place as soon as possible after exposure.
3. Eating, drinking, smoking, applying cosmetics or lip balm and handling contact lenses is prohibited in work areas where there is the potential for exposure to bloodborne pathogens.
4. If professional medical attention is required, a local ambulance will be the first choice; a personal car will be the second. If a personal car is taken, impervious material should be used to prevent contamination of the vehicle.
5. New employees or employee being transferred to other sections will receive training about any potential exposure from the Regional Safety Manager.
6. This Exposure Control Plan will be a part of the BPO office Pre-activity Safety Plans when exposure to bloodborne pathogens is recognized during pre-job hazard assessment.

**Pre-Activity Safety Plan (PASP)**  
(Page 16 of 23)

## APPENDIX C: BLOODBORNE PATHOGENS

**E. Personal Protective Equipment**

All personal protective equipment, such as gloves, contaminated materials handling tools or equipment, biohazard bags used will be provided without cost to employees. Personal protective equipment will be chosen based on the anticipated exposure to blood or OPIM. The protective equipment will be considered appropriate only if it does not permit blood or OPIM to pass through or reach the employees' clothing, skin, eyes, mouth, or other mucous membranes under normal conditions of use.

**F. Disposal of Contaminated Items and Communication of Hazard**

1. Employees must:
  - a. use bleach to disinfect any blood or OPIM.
  - b. apply the bleach with single-use gloves and allow contact for at least 15 minutes.
  - c. place any single-use gloves that have been contaminated in a biohazard bag and cover.
    - i. contact your Regional Safety Managers for the proper disposal of biohazard bags or other impervious containers.
    - ii. regulated waste should be placed in appropriate containers, label and disposed of in accordance with Chapter 296-823, WAC
2. Employees will be warned of biohazard bags by labels attached to the disposal bags. Labels used will be orange-red and marked with the work **BIOHAZARD** or the biohazard symbol.

**G. Housekeeping**

Maintaining our work areas in a clean and sanitary condition is an important part of WSDOT's Bloodborne Pathogens Compliance Program. Employees must decontaminate working surfaces and equipment with an appropriate disinfectant after completing procedures involving blood or OPIM. All equipment, environmental surfaces and work surfaces shall be decontaminated immediately or as soon as feasible after contamination.

1. Employees must clean and disinfect when surfaces become contaminated and after any spill of blood or OPIM.
2. Employees will use a solution of one part bleach to ten parts water for cleaning and disinfecting.
3. Working surfaces and equipment will be cleaned, disinfected and maintain.
4. Potentially contaminated broken glass will be picked up using mechanical means, such as dustpan and brush, tongs, etc.

**APPENDIX C: BLOODBORNE PATHOGENS**

5. Use universal precautions for handling of all soiled laundry.
6. Laundry contaminated with blood or OPIM will be handled as little as possible. Employees who handle contaminated laundry will utilize personal protective equipment to prevent contact with blood or OPIM from coming into contact skin or street clothes.
7. Contaminated clothing will remain on the premises, or will be sent directly to a laundry facility for cleaning. Employees will be given the option of reimbursement for the cost of contaminated clothing and the clothing will be disposed.

**H. Hepatitis B Vaccination and Post-Exposure Evaluation and Follow-Up**

1. WSDOT shall make available within 24 hours of possible exposure the Hepatitis B vaccine and vaccination series to all employees who have occupational exposure. Vaccination is not required if:
  - a. Employee has previously received the completed Hep B vaccination series.
  - b. An antibody test has revealed that the employee is immune to hepatitis B.
  - c. There are medical reasons not to give the vaccine, usually determined by the employee's physician.
2. An employee who refuses the vaccination is required to sign a Hepatitis B Vaccination Declination Form, Appendix 7-C in Chapter 7 of the Safety Manual which will be retained indefinitely in the employee's Safety and Health file located at the HQ Safety Office.
3. An exposure incident means a specific eye, mouth, other mucous membrane, non-intact skin or parenteral contact with blood or OPIM that result from the performance of an employee's duties. Examples of non-intact skin include skin with dermatitis, hangnails, cuts, abrasions, chafing or acne. Any employee having an exposure incident shall contact the Regional Safety Manager immediately. All employees who have an exposure incident will be offered a confidential post-exposure evaluation and follow-up in accordance with the DOSH standard. This includes a visit to a physician selected by the employee where an L&I claim can be initiated. The health care professional written opinion will be provided to the employee within 15 days of the evaluation.

**I. Training**

Training is provided at the time of initial assignment to tasks where occupational exposure may occur, and that it shall be repeated within twelve months of the previous training. Training shall be tailored to the education and language level of the employee, and offered during the normal work shift. The training will be interactive and cover the following:

1. a copy of the standard and an explanation of its contents;
2. a discussion of the epidemiology and symptoms of bloodborne diseases;

**Pre-Activity Safety Plan (PASP)**  
(Page 18 of 23)

**APPENDIX C: BLOODBORNE PATHOGENS**

3. an explanation of the modes of transmission of bloodborne pathogens;
4. an explanation of the WSDOT Bloodborne Pathogen Exposure Control Plan (this program), and a method for obtaining a copy;
5. the recognition of tasks that may involve exposure;
6. an explanation of the use and limitations of methods to reduce exposure, for example engineering controls, work practices and personal protective equipment;
7. information on the types, use, location, removal, handling, decontamination, and disposal of PPE;
8. explanation of the basis of selections of PPE;
9. information on the Hepatitis B vaccination, including efficacy, safety, method of administration, benefits, and that it will be offered free of charge;
10. information on the appropriate actions to take and persons to contact in an emergency involving blood or OPIM;
11. explanation of the procedures to follow if an exposure incident occurs, including the method of reporting and medical follow-up;
12. information on the evaluation and follow-up required after an employee exposure incident;
13. an explanation of the signs, labels, and color-coding systems.

**J. Exposure Reporting and Recordkeeping**

1. Exposures, including first aid incident exposures that involve the presence of blood or OPIM must be reported to the supervisor and the Regional Safety Manager before the end of the work shift. An Accident Form, 750-100 must be completed to include the names of all the first-aid providers who rendered assistance, the time and date of the first-aid incident and a description of the first-aid incident.
2. Medical records shall be maintained in accordance with DOSH Standards. These records shall be kept confidential, and must be maintained at the HQ Safety and Health Office for at least the duration of employment plus 30 years.

## APPENDIX D: HOSPITALS

| NAME                                | ADDRESS                     | CITY         | COUNTY       | PHONE          |
|-------------------------------------|-----------------------------|--------------|--------------|----------------|
| Grays Harbor Community Hospital     | 915 Anderson Drive          | Aberdeen     | Grays Harbor | (360) 532-8330 |
| Island Hospital                     | 1211 - 24th                 | Anacortes    | Skagit       | (360) 299-1300 |
| Cascade Valley Hospital and Clinics | 330 S. Stillaguamish Avenue | Arlington    | Snohomish    | (360) 435-2133 |
| Auburn Regional Medical Center      | 202 N. Division Street      | Auburn       | King         | (253) 833-7711 |
| Overlake Hospital Medical Center    | 1035 - 116th NE             | Bellevue     | King         | (425) 688-5000 |
| St. Joseph Hospital                 | 2901 Squaticum Parkway      | Bellingham   | Whatcom      | (360) 734-5400 |
| Harrison Medical Center             | 2520 Cherry Avenue          | Bremerton    | Kitsap       | (360) 377-3911 |
| Naval Hospital                      | HP 01 Boone Road            | Bremerton    | Kitsap       | (360) 475-4210 |
| Okanogan Douglas District Hospital  | 507 Hospital Way            | Brewster     | Okanogan     | (509) 689-2517 |
| Highline Medical Center             | 16251 Sylvester Road SW     | Burien       | King         | (206) 244-9970 |
| Providence Centralia Hospital       | 914 South Scheuber Road     | Centralia    | Lewis        | (360) 736-2803 |
| Lake Chelan Community Hospital      | 503 E. Highland Avenue      | Chelan       | Chelan       | (509) 682-3300 |
| St. Joseph's Hospital               | 500 East Webster            | Chewelah     | Stevens      | (509) 935-8211 |
| Tri-State Memorial Hospital         | 1221 Highland Ave.          | Clarkston    | Asotin       | (509) 758-5511 |
| Whitman Hospital and Medical Center | 1200 West Fairview          | Colfax       | Whitman      | (509) 397-3435 |
| Mount Carmel Hospital               | 982 E. Columbia             | Colville     | Stevens      | (509) 684-2561 |
| Whidbey General Hospital            | 101 N. Main Street          | Coupeville   | Island       | (360) 678-5151 |
| Lincoln Hospital                    | 10 Nicholls Street          | Davenport    | Lincoln      | (509) 725-7101 |
| Dayton General Hospital             | 1012 S. Third Street        | Dayton       | Columbia     | (509) 382-2531 |
| Deer Park Hospital                  | 1015 E. "D" Street          | Deer Park    | Spokane      | (509) 276-5061 |
| Stevens Healthcare                  | 21601 76th Avenue West      | Edmonds      | Snohomish    | (425) 640-4000 |
| Kittitas Valley Community Hospital  | 603 S. Chestnut             | Ellensburg   | Kittitas     | (509) 962-9841 |
| Enumclaw Regional Hospital          | 1450 Battersby Avenue       | Enumclaw     | King         | (360) 825-2505 |
| Columbia Basin Hospital             | 200 Nat Washington Way      | Ephrata      | Grant        | (509) 754-4631 |
| Providence Everett Medical Center   | 1321 Colby                  | Everett      | Snohomish    | (425) 261-2000 |
| St. Francis Hospital                | 34515 9th Avenue South      | Federal Way  | King         | (253) 944-8100 |
| Forks Community Hospital            | 530 Bogachiel Way           | Forks        | Clallam      | (360) 374-6271 |
| Klickitat Valley Health             | 310 S. Roosevelt            | Goldendale   | Klickitat    | (509) 773-4022 |
| Coulee Community Hospital           | 411 Fortuyn Road            | Grand Coulee | Grant        | (509) 633-1753 |
| Ocean Beach Hospital                | 174 - 1st Avenue North      | Ilwaco       | Pacific      | (360) 642-3181 |
| Kennewick General Hospital          | 900 S. Auburn               | Kennewick    | Benton       | (509) 586-6111 |
| Evergreen Healthcare                | 12040 NE 128th Street       | Kirkland     | King         | (425) 899-1000 |
| Fairfax Hospital                    | 10200 N.E. 132nd Street     | Kirkland     | King         | (425) 821-2000 |

APPENDIX D –PAGE 1

**Pre-Activity Safety Plan (PASP)**  
(Page 20 of 23)

## APPENDIX D: HOSPITALS

| NAME                                     | ADDRESS                      | CITY          | COUNTY       | PHONE          |
|------------------------------------------|------------------------------|---------------|--------------|----------------|
| Cascade Medical Center                   | 817 Commercial Street        | Leavenworth   | Chelan       | (509) 548-5815 |
| PeaceHealth, St. John Medical Center     | 1615 Delaware Street         | Longview      | Cowlitz      | (360) 414-2000 |
| Mark Reed Hospital                       | 322 South Birch Street       | McCleary      | Grays Harbor | (360) 495-3244 |
| Valley General Hospital                  | 14701 - 179th SE             | Monroe        | Snohomish    | (360) 794-7497 |
| Morton General Hospital                  | 521 Adams Street             | Morton        | Lewis        | (360) 496-5112 |
| Samaritan Healthcare                     | 801 E. Wheeler Road          | Moses Lake    | Grant        | (509) 765-5606 |
| Skagit Valley Hospital                   | 1415 E Kincaid Street        | Mount Vernon  | Skagit       | (360) 424-4111 |
| Newport Hospital & Health Services       | 714 West Pine                | Newport       | Pend Oreille | (509) 447-2441 |
| Odessa Memorial Healthcare Center        | 502 E. Amende Drive          | Odessa        | Lincoln      | (509) 982-2611 |
| Capital Medical Center                   | 3900 Capital Mall Drive S.W. | Olympia       | Thurston     | (360) 956-2550 |
| Providence St. Peter Hospital            | 413 Lilly Road N.E.          | Olympia       | Thurston     | (360) 491-9480 |
| Mid-Valley Hospital                      | 810 Jasmine                  | Omak          | Okanogan     | (509) 826-1760 |
| Othello Community Hospital               | 315 N. 14th Avenue           | Othello       | Adams        | (509) 488-2636 |
| Lourdes Medical Center                   | 520 N. 4th Avenue            | Pasco         | Franklin     | (509) 547-7704 |
| Garfield County Public Hospital District | 66 North Sixth Street        | Pomeroy       | Garfield     | (509) 843-1591 |
| Olympic Medical Center                   | 939 Caroline Street          | Port Angeles  | Clallam      | (360) 417-7000 |
| Jefferson Healthcare                     | 834 Sheridan                 | Port Townsend | Jefferson    | (360) 385-2200 |
| Prosser Memorial Hospital                | 723 Memorial Street          | Prosser       | Benton       | (509) 786-2222 |
| Pullman Regional Hospital                | 835 SE Bishop Boulevard      | Pullman       | Whitman      | (509) 332-2541 |
| Good Samaritan Community Healthcare      | 407 14th Avenue S.E.         | Puyallup      | Pierce       | (253) 697-4000 |
| Quincy Valley Medical Center             | 908 10th Avenue S.W.         | Quincy        | Grant        | (509) 787-3531 |
| Group Health Cooperative/Eastside Hosp   | 2700 152nd N.E.              | Redmond       | King         | (425) 883-5151 |
| Valley Medical Center                    | 400 S. 43rd Street           | Renton        | King         | (425) 228-3450 |
| Ferry County Memorial Hospital           | 36 Klondike Road             | Republic      | Ferry        | (509) 775-3333 |
| Kadlec Medical Center                    | 888 Swift Boulevard          | Richland      | Benton       | (509) 946-4611 |
| Lourdes Counseling Center                | 1175 Carondelet Drive        | Richland      | Benton       | (509) 943-9104 |
| East Adams Rural Hospital                | 903 S. Adams                 | Ritzville     | Adams        | (509) 659-1200 |
| Children's Hospital and Reg Med Ctr      | 4800 Sand Point Way N.E.     | Seattle       | King         | (206) 987-2000 |
| Group Health Cooperative/Central Hosp    | 201 16th Avenue East         | Seattle       | King         | (206) 326-3000 |
| Harborview Medical Center                | 325 Ninth Avenue             | Seattle       | King         | (206) 731-3000 |
| Kindred Hospital Seattle                 | 10631 8th Avenue N.E.        | Seattle       | King         | (206) 364-2050 |
| Northwest Hospital & Medical Center      | 1550 North 115th Street      | Seattle       | King         | (206) 364-0500 |
| Regional Hosp for Resp & Complex Care    | 12844 Military Road South    | Seattle       | King         | (206) 248-4604 |
| Seattle Cancer Care                      | 825 Eastlake E               | Seattle       | King         | (206) 288-1400 |

APPENDIX D –PAGE 2

**Pre-Activity Safety Plan (PASP)**  
(Page 21 of 23)



## APPENDIX D: HOSPITALS

| NAME                                     | ADDRESS                        | CITY           | COUNTY   | PHONE          |
|------------------------------------------|--------------------------------|----------------|----------|----------------|
| Alliance                                 |                                |                |          |                |
| Swedish Medical Center/Ballard           | 5300 Tallman Avenue NW         | Seattle        | King     | (206) 782-2700 |
| Swedish Medical Center/First Hill        | 747 Broadway                   | Seattle        | King     | (206) 386-6000 |
| Swedish Medical Center/Providence        | 500 17th Avenue                | Seattle        | King     | (206) 320-2000 |
| University of WA Medical Center          | 1959 N.E. Pacific Street       | Seattle        | King     | (206) 598-3300 |
| VA Puget Sound Health Care System        | 1660 South Columbian Way       | Seattle        | King     | (206) 762-1010 |
| Virginia Mason Medical Center            | 1100 Ninth Avenue              | Seattle        | King     | (206) 624-1144 |
| West Seattle Psychiatric Hospital        | 2600 SW Holden Street          | Seattle        | King     | (206) 933-7000 |
| United General Hospital                  | 2000 Hospital Drive            | Sedro-Woolley  | Skagit   | (360) 856-6021 |
| Mason General Hospital                   | 901 Mt. View Drive, Bldg. 1    | Shelton        | Mason    | (360) 426-1611 |
| Snoqualmie Valley Hospital               | 9575 Ethan Wade Way SE         | Snoqualmie     | King     | (425) 831-2300 |
| Willapa Harbor Hospital                  | 800 Alder Street               | South Bend     | Pacific  | (360) 875-5526 |
| Deaconess Medical Center                 | 800 West Fifth Avenue          | Spokane        | Spokane  | (509) 458-5800 |
| Holy Family Hospital                     | N. 5633 Lidgerwood Street      | Spokane        | Spokane  | (509) 482-0111 |
| Sacred Heart Medical Center              | 101 West Eighth Avenue         | Spokane        | Spokane  | (509) 474-3131 |
| Shriners Hospital for Children           | 911 West Fifth Avenue          | Spokane        | Spokane  | (509) 455-7844 |
| St. Luke's Rehabilitation Institute      | 711 South Cowley Avenue        | Spokane        | Spokane  | (509) 473-6298 |
| Valley Hospital & Medical Center         | 12606 E. Mission Avenue        | Spokane Valley | Spokane  | (509) 924-6650 |
| Sunnyside Community Hospital             | 1016 Tacoma Avenue             | Sunnyside      | Yakima   | (509) 837-1500 |
| Allenmore Hospital                       | S. 19th & Union                | Tacoma         | Pierce   | (253) 459-6633 |
| Madigan Army Medical Center              | 9040 A Reid Street             | Tacoma         | Pierce   | (253) 968-1210 |
| Mary Bridge Children's Hosp & Hlth Ctr   | 317 Martin Luther King Jr. Way | Tacoma         | Pierce   | (253) 403-1400 |
| St. Clare Hospital                       | 11315 Bridgeport Way S.W.      | Tacoma         | Pierce   | (253) 588-1711 |
| St. Joseph Medical Center                | 1717 South "J" Street          | Tacoma         | Pierce   | (253) 426-4101 |
| Tacoma General Hospital                  | 315 Martin Luther King Jr. Way | Tacoma         | Pierce   | (253) 403-1000 |
| North Valley Hospital                    | 203 South Western Avenue       | Tonasket       | Okanogan | (509) 486-2151 |
| Toppenish Community Hospital             | 502 West Fourth Avenue         | Toppenish      | Yakima   | (509) 865-3105 |
| Highline Medical Center/Specialty Campus | 12844 Military Road South      | Tukwila        | King     | (206) 244-0180 |
| Legacy Salmon Creek Hospital             | 2211 NE 139th Street           | Vancouver      | Clark    | (360) 487-1000 |
| Southwest Washington Medical Center      | 400 NE Mother Joseph Place     | Vancouver      | Clark    | (360) 256-2000 |

APPENDIX D –PAGE 3

**Pre-Activity Safety Plan (PASP)**  
(Page 22 of 23)

**APPENDIX D: HOSPITALS**

| NAME                              | ADDRESS                  | CITY         | COUNTY      | PHONE          |
|-----------------------------------|--------------------------|--------------|-------------|----------------|
| St. Mary Medical Center           | 401 W. Poplar            | Walla Walla  | Walla Walla | (509) 525-3320 |
| Walla Walla General Hospital      | 1025 S. Secord Avenue    | Walla Walla  | Walla Walla | (509) 525-0480 |
| Central Washington Hospital       | 1201 South Miller Street | Wenatchee    | Chelan      | (509) 662-1511 |
| Wenatchee Valley Hospital         | 820 North Chelan Avenue  | Wenatchee    | Chelan      | (509) 663-8711 |
| Skyline Hospital                  | 211 Skyline Drive        | White Salmon | Klickitat   | (509) 493-1101 |
| Yakima Regional Med & Cardiac Ctr | 110 S. Ninth Avenue      | Yakima       | Yakima      | (509) 575-5000 |
| Yakima Valley Memorial Hospital   | 2811 Tieton Drive        | Yakima       | Yakima      | (509) 575-8000 |

APPENDIX D –PAGE 4

### 3.06 Appendices

|                  |                                                        |
|------------------|--------------------------------------------------------|
| Appendix 3.06-A1 | Bridge With Fill on Deck                               |
| Appendix 3.06-A2 | Bridge With No Fill on Deck                            |
| Appendix 3.06-A3 | Culvert With Fill on Deck                              |
| Appendix 3.06-B  | UBIT Inspections and Procedures                        |
| Appendix 3.06-C  | FHWA Letter for Routine Extended Frequency Inspections |
| Appendix 3.06-D  | FHWA Letter for Bridge Special Feature Inspections     |



Short Span Inspections are recommended and performed by the Washington State Department of Transportation (WSDOT) Bridge Preservation Office when the following criteria are met:

1. Depth of fill must be less than  $D/2$  (where  $D$  = Maximum opening distance).
2. CONCRETE Structures: Opening of 6 feet or more.  
STEEL Structures: Opening of 6 feet or more.  
TIMBER Structures: Opening of 4 feet or more.

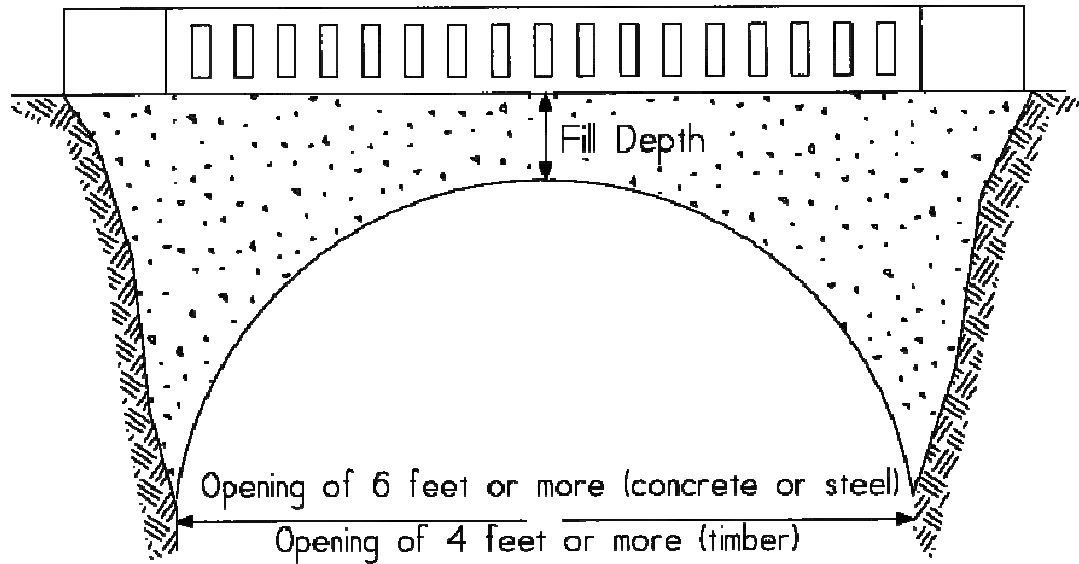



Short Span Inspections are recommended and performed by the Washington State Department of Transportation (WSDOT) Bridge Preservation Office when the following criteria are met:

- 1. CONCRETE Structures: Opening of 6 feet or more.  
STEEL Structures: Opening of 6 feet or more.  
TIMBER Structures: Opening of 4 feet or more.

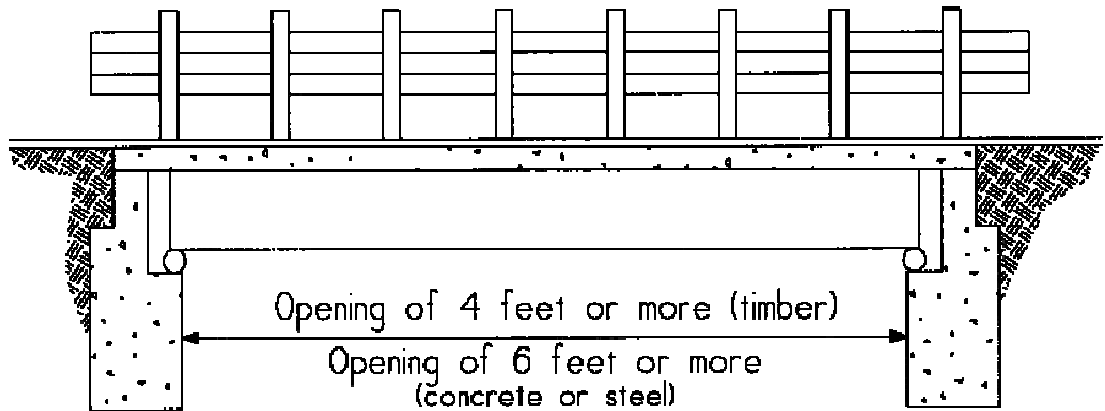





Short Span Inspections are recommended and performed by the Washington State Department of Transportation (WSDOT) Bridge Preservation Office when the following criteria are met:

1. Depth of fill must be less the  $D/2$  (where  $D$  = total opening).
2. Total Opening of 8 feet or more.

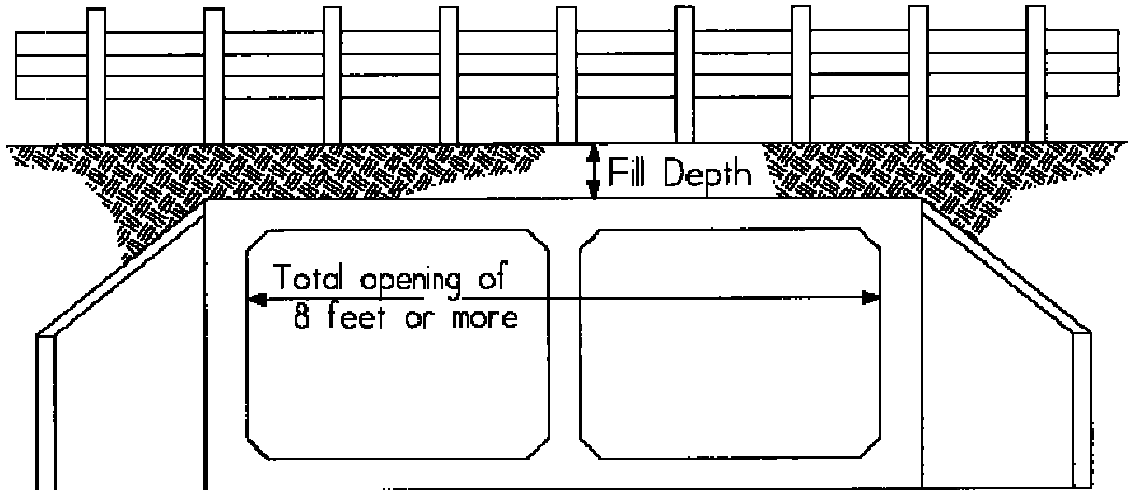



The following explains the procedures for UBIT inspections.

1. **Determine Those Bridges Which Will Require Inspection With a UBIT** – On some structures, the team leader will not be able to gain sufficient access to determine the structural condition of the member (for example, floorbeam and stringer connections, a pier cap, or a bearing device at midspan or on top of interior piers that are too high for ladders). If this is the case, a UBIT, ladder, scaffolding, catwalk, boat, or some other means may be required to provide sufficient access.

The records for all structures that require inspection with a UBIT are all contained within the State Bridge Inventory. As part of scheduling for an upcoming inspection season, lists are generated from the inventory for bridges that are due for inspection with a UBIT.

2. **Provide for the Use of the UBIT** – The UBIT is an expensive piece of equipment and only a few agencies have the budget to purchase one. Along with the State, there are only a few UBIT owners in the Pacific Northwest. These trucks are complicated pieces of equipment which require special expertise to operate and a trained UBIT driver to drive and maintain the truck.
3. **Conduct the UBIT Inspection** – The UBIT inspection gives “hands on” access to under bridge elements for inspection. The team leader should make the same observations and assessments as would be made during a routine inspection. Given the expense of contracting for the use of this equipment, special care should be taken to ensure that the UBIT inspection is performed efficiently.

It is a good idea to map out an inspection plan that will allow an inspection of the entire under portion of the bridge in as few steps as possible and with as few changes in the positioning of the UBIT as needed. Communication between the inspection team in the bucket and the truck operator should be maintained at all times to ensure the safety of the operation and to allow for proper positioning for the inspection. The team should have any and all inspection equipment required (test hammer, note pad, camera, etc.). Finally, the team leader should ensure that needed traffic control can be provided and that all other necessary special equipment will be available. If these steps are taken, the UBIT inspection can be accomplished quickly and at minimum expense.

4. **Record the Inspection Findings on the Bridge Inspection Report** – The UBIT inspection findings should be recorded on the Bridge Inspection Report. Follow the same procedures as described for Routine Inspection Reports in Section 3.02.A.
5. **Updating the WSBIS Inventory Record** – Any other changes needed for the WSBIS Inventory Record (add the inspection date for UBIT, Fracture Critical, and/or Special Inspections) should be entered into BridgeWorks.

6. **Frequency** – The NBIS does not give specific instructions of how often a routine UBIT inspection needs to be completed. To determine the frequency necessary, a history of the bridge condition and deterioration needs to be established. After a few Routine UBIT Inspections are completed the history and deterioration can be determined. For those bridges that do not need a UBIT Routine Inspection each time, the inspection frequency can be rotated. For a “rule of thumb,” the state of Washington has chosen the following:

| Type of Structure                                            | Frequency (Months) |
|--------------------------------------------------------------|--------------------|
| Timber                                                       | 24                 |
| Steel Trusses                                                | 24                 |
| Steel Bridges With Pins and Hangers                          | 24                 |
| Non-Fracture Critical Steel Bridges                          | 48                 |
| Concrete Bridges With Movable Bearings in the Interior Spans | 48                 |
| Concrete Bridges With Fixed Bearings or No Bearings; Maximum | 72                 |

7. **Traffic Control** – A UBIT inspection will typically require some sort of traffic control where a temporary work zone such as closing a lane of traffic or equivalent shoulder width is set up to provide safety for the inspection team as well as the traveling public. The traffic control plan needs to follow the updated version of the Manual of Uniform Traffic Control Devices (MUTCD) for proper signing and flagging in the temporary work zone. Local events and traffic disruptions need to be checked before scheduling a UBIT Truck. Emergency response agencies, schools, the public, and businesses affected by the inspection need to be notified so they can adjust as necessary. All these items need to be checked before committing to the actual inspection date.
8. **Fall Protection Plans** – The Department of Labor and Industries (L&I) and the Washington Administrative Code (WAC) require a Fall Protection Plan be completed at each UBIT Inspection site. The retrieval systems and the safety emergency plans need to be known and signed on the Fall Protection Form by all in the work zone prior to beginning the inspection. The State utilizes a Pre-Activity Safety Plan (PASP) prior to all inspections, see Section 3.05 for a copy of the PASP.



**Washington State  
Department of Transportation**  
Sid Morrison  
Secretary of Transportation

Transportation Building  
P O. Box 47300  
Olympia, WA 98504-7300

July 28, 1998

Mr. Gene Fong  
Division Administrator  
Federal Highway Administration  
711 South Capitol Way  
Olympia, WA 98501

Attn: Mr. Barry Brecto

RE: Bridge Inspection Frequency  
Revision

Dear Mr. Fong:

This is in response to your letter of May 7, 1998. Attached is a revised list of bridges that meet our approved 48-month inspection criteria. We have reviewed the current database and have excluded those bridges with spans of more than ~~30-48~~ <sup>100 feet</sup> meters.

We have changed the inspection frequency to 48 months on the 233 bridges on this list. The extended inspection frequency will be re-evaluated during every future inspection. We will continue to monitor the 48-month inspection criteria and submit an updated list every April along with our annual master list update.

Again, this is the criteria used to create and maintain the 48-month bridge inspection list.

1. Common Designs - Concrete Bridges or steel culverts
  - a. Prestressed girders (PCB)
  - b. Box girders (CBOX)
  - c. Slabs (CS)
  - d. T-beams (CTB)
  - e. Post-tensioned box girders (PBOX)
  - f. Concrete culvert (CCULV)
  - g. Steel culvert (SCULV)

Mr. Fong  
July 28, 1998  
Page 2

2. Structure Age - No maximum age limit. The condition ratings will be used to determine whether the structure should be on a four-year cycle.
3. Condition Ratings
  - a. Superstructure greater than 6
  - b. Substructure greater than 6
  - c. Deck greater than 6
  - d. Culvert greater than 6
4. Inventory Load Ratings
  - a. ~~All bridge inventory ratings are greater than or equal to state legal loads~~  
Inventory Rating Tons are equal to or greater than 36 or Rating Factor greater than 1.0
5. Vertical Underclearances greater than 14' 00"
6. Bridges over water
  - a. Not scour critical - Scour Code 5, 8, 9, T or N. 680
  - b. Channel and channel code 6 or greater. 677
7. The maximum span length is equal to or less than 100 feet (In Accordance with FHWA Technical Advisory T 5140.21 dated September 16, 1988).
8. The maximum ADT is 100,000 vehicles and the ADTT 10,000.
9. No major maintenance has been performed on the bridge in the last two years.
10. The bridge has received at least one in-depth inspection in addition to its inventory inspection.

We appreciate the effort and assistance that the FHWA Division Bridge Engineer has provided in this matter. We have implemented this change and will continue to monitor the status of the criteria you set forth. If you have any questions, please call the Bridge Preservation Engineer at (360)753-4739.

Sincerely,

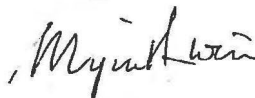

M. MYINT LWIN, P.E.  
Bridge and Structures Engineer

MML:lr  
ORG/RPH  
Attachment

cc: D. K. Nelson, EESC, MS 47323



U.S. Department  
of Transportation  
**Federal Highway  
Administration**

Washington Division

Suite 501 Evergreen Plaza  
711 South Capitol Way  
Olympia, Washington 98501-1284  
(206) 753-9480  
(206) 753-9889 (FAX)

*D.I.g.* *FHWA CORR6*

February 17, 1993

HBR-WA/407.23

Mr. Duane Berentson  
Secretary of Transportation  
Department of Transportation  
Olympia, Washington

Attention: Mr. Al Walley, PE

Bridge Special Feature Inspections

Dear Mr. Berentson:

Enclosed for your information and use is a memorandum from our Region 3 office, which lists criteria for selecting bridges that have special features needing inspection. The designation of these features is contained in Items 92C and 93C of the National Bridge Inventory. This guidance is provided to promote some uniformity in compiling the lists for these bridges.

The special features inspection list you furnished our office in January 1992 consisted of the following bridge types.

- Movable Bridges
- Floating Bridges
- Suspension Bridges
- Segmental Bridges
- Ferry Terminals
- Bridges with A514 Steel
- Bridges with Pins and/or Hangers
- Bridges with Temporary Supports

Please review the criteria developed in Region 3 to determine if modifications should be made to your criteria. We recommend you give serious consideration to adding two items, cable stayed bridges and bridges experiencing fatigue cracking or scour problems, to your list.

Please provide us an up-to-date list of those bridges with special features requiring inspection, including the selection criteria. This submission should be included with the upcoming April

(more)

progress update on the NBIS Critical Feature Inspections, due in our office by March 24, 1993.  
Since this information is needed for both State and local agency bridges, we are providing Mr.  
Dennis Ingham a copy of this letter.

Sincerely,

BARRY F. MOREHEAD  
Division Administrator



By: Barry B. Brecto, P.E.  
Division Bridge Engineer

Enclosure





U.S. Department  
of Transportation  
**Federal Highway  
Administration**

# Memorandum

Subject: National Bridge Inspection Standards (NBIS)  
Guidance on Coding Items 92C and 93C in the National Bridge Inventory  
Date: November 13, 1992

From: Director, Office of Structures  
Baltimore, Maryland

Reply to  
Attn of HST-03

To: Division Administrators  
Region 3

As discussed at our Region 3 Bridge Engineers meeting in Atlanta, we have been reviewing States' criteria for coding items 92C and 93C in the National Bridge Inventory (NBI). Item 92C refers to special features other than fracture critical details and underwater inspection which need special evaluation. Item 93C is for coding the date of last inspection of the special feature.

As anticipated, we found a wide variation in the definition of special features. In some cases, the items were obviously coded incorrectly or not coded at all. The variation in coding is due primarily to the lack of specific guidance on types of bridges that would require "other special inspection." Development of specific criteria has generally been left up to each individual State.

Several FHWA documents provide examples of special features or attempt to broadly define bridges that require special inspections. Examples are as follows:

- \* Technical Advisory (TA) 5140.21, defines bridges with special features as those that by their nature or experience need special monitoring and evaluation. A second definition is provided in the same TA as bridges that because of location, strategic importance, or special design features, warrant special attention.
- \* 23 CFR, Part 650, defines bridges with unique or special features as those which require additional attention during inspection to ensure the safety of such bridges.
- \* The 1988 Coding Guide provides an example of a special feature as temporary shoring that is being inspected on a six month interval.
- \* The Bridge Inspector's Training Manual (May 1991) provides three examples of bridge types which feature special elements and require special inspection procedures: suspension, cable stayed, and segmental concrete bridges.

Since each State is required to maintain a master list of bridges that require special inspections, some uniformity in the criteria used to compile the lists should exist. We recognize that there will

2

be differences in criteria due to individual State experiences, location, design policies, limits of acceptable risk, etc.; however, there are basic bridge types and features that are common among most of the States.

Based on the above definitions and examples along with our review of criteria in use by some States, we offer the following as a suggested list of bridge types or features that may require a special inspection:

1. Segmental, cable stayed, suspension, and movable bridges
2. Pin and hanger details on redundant structures.
3. Temporarily supported bridges
4. Bridges experiencing fatigue cracking or scour problems
5. Damaged bridges (e.g., due to vehicular or ship impact)
6. Concrete bridges showing signs of distress for which plans are not available
7. Interim inspection of bridges posted at operating rating
8. Long span metal culverts/structural plate culverts

With respect to movable bridges, inspection of the trusses, floor systems, and other structural elements requires typical inspection procedures; however, the electrical, mechanical and some structural components must receive a specialized inspection. Also, long span metal culverts are included on the list based on problems with cracking along the bolt line experienced by some States.

A few States use additional criteria such as bridges with steel box girders, electroslog welds, post-tensioned concrete channel beams, and panel type bridges (e.g., Acrow, Mabey, Bailey). These are good examples of features that may be specific to an individual State based on local experience.

We should note that a bridge does not have to be inspected more frequently than every two years to be included on the master list for item 92C. The "individual in charge" of a State's inspection program is responsible for determination of time intervals between inspections based on the condition of the special feature or bridge. More frequent inspection should not be used as a crutch in lieu of repair or retrofit. When used for this purpose it should be a temporary measure where deficiencies can be corrected and considered as a deliberate measure where corrections are impractical. The attached December 20, 1990 Washington Office memorandum provides additional guidance on inspection frequency.

We request that each Division Bridge Engineer review their States practices for coding items 92C and 93C with consideration given to the above suggested criteria. Where appropriate, changes or additions to the State's current criteria should be pursued. For those States that have either not coded these items or have coded them incorrectly, measures should be implemented to ensure accurate reporting in the NBI.

3

We further request that a brief status report be provided to our office by December 31, 1992. The report should indicate where your State stands in relation to our suggested criteria and outline any proposed actions to implement necessary changes. We are available to assist in this effort if desired.

Please contact Mr. Thomas Everett at 410-962-2486 with any questions or comments.

*Louis N. Triandafilou*  
Louis N. Triandafilou

Attachment



**4.01 List of WSDOT Elements by Number**

| <b>Bridge Decks</b> |                                                 |      |                                                      |      |
|---------------------|-------------------------------------------------|------|------------------------------------------------------|------|
| 12                  | Concrete Deck . . . . .                         | 4-14 | 29 Steel Deck - Concrete Filled Grid . . . . .       | 4-16 |
| 13                  | Bridge Deck Surface . . . . .                   | 4-14 | 30 Deck - Corrugated or Other Steel system . . . . . | 4-17 |
| 14                  | Fully Supported Concrete Deck . . . . .         | 4-15 | 31 Timber Deck . . . . .                             | 4-17 |
| 20                  | Concrete Deck - Lightweight Aggregate . . . . . | 4-15 | 32 Fiber Reinforced Polymer (FRP) - Deck . . . . .   | 4-17 |
| 26                  | Concrete Deck w/Coated Bars . . . . .           | 4-16 | 35 Concrete Deck Soffit . . . . .                    | 4-18 |
| 27                  | Steel Orthotropic Deck . . . . .                | 4-16 | 36 Deck Rebar Cover Flag . . . . .                   | 4-18 |
| 28                  | Steel Deck - Open Grid . . . . .                | 4-16 |                                                      |      |

| <b>Superstructure</b> |                                                          |      |                                                |      |
|-----------------------|----------------------------------------------------------|------|------------------------------------------------|------|
| 38                    | Concrete Slab . . . . .                                  | 4-20 | 116 Concrete Stringer . . . . .                | 4-30 |
| 49                    | Concrete Hollow Slab . . . . .                           | 4-20 | 117 Timber Sawn Girder . . . . .               | 4-30 |
| 50                    | Prestressed Concrete Slab . . . . .                      | 4-20 | 118 Timber Stringer . . . . .                  | 4-30 |
| 51                    | Prestressed Concrete Slab w/Coated Bars . . . . .        | 4-20 | 119 Concrete Truss . . . . .                   | 4-31 |
| 52                    | Concrete Slab w/Coated Bars . . . . .                    | 4-21 | 126 Steel Thru Truss . . . . .                 | 4-31 |
| 54                    | Timber Slab . . . . .                                    | 4-21 | 131 Steel Deck Truss . . . . .                 | 4-31 |
| 89                    | Prestressed Concrete Girder w/Coated Strands . . . . .   | 4-22 | 133 Truss Gusset Plates . . . . .              | 4-32 |
| 90                    | Steel Rolled Girder . . . . .                            | 4-22 | 135 Timber Truss . . . . .                     | 4-32 |
| 91                    | Steel Riveted Girder . . . . .                           | 4-22 | 139 Timber Arch . . . . .                      | 4-33 |
| 92                    | Steel Welded Girder . . . . .                            | 4-23 | 141 Steel Arch . . . . .                       | 4-33 |
| 96                    | Concrete Encased Steel Girder . . . . .                  | 4-23 | 142 Steel Tied Arch . . . . .                  | 4-33 |
| 97                    | Prestressed Concrete Trapezoidal Girder . . . . .        | 4-24 | 143 Steel Suspender . . . . .                  | 4-34 |
| 98                    | Thin Flange Girder . . . . .                             | 4-24 | 144 Concrete Arch . . . . .                    | 4-34 |
| 100                   | Post Tensioned Concrete Segmental Box Girder . . . . .   | 4-25 | 145 Earth Filled Concrete Arch . . . . .       | 4-35 |
| 102                   | Steel Box Girder . . . . .                               | 4-25 | 146 Suspension - Main Cable . . . . .          | 4-35 |
| 103                   | Prestressed Concrete Super Girder . . . . .              | 4-26 | 147 Suspension - Suspender Cable . . . . .     | 4-35 |
| 104                   | Post Tension Concrete Box Girder . . . . .               | 4-26 | 149 Cable Stayed Bridge - Cable . . . . .      | 4-36 |
| 105                   | Concrete Box Girder . . . . .                            | 4-26 | 150 Concrete Column on Spandrel Arch . . . . . | 4-36 |
| 107                   | Steel Open Girder . . . . .                              | 4-27 | 152 Steel Floor Beam . . . . .                 | 4-37 |
| 108                   | Prestressed Concrete Bulb-T Girder . . . . .             | 4-27 | 154 Prestressed Concrete Floor Beam . . . . .  | 4-37 |
| 109                   | Prestressed Concrete Multiple Web Girder Units . . . . . | 4-28 | 155 Concrete Floor Beam . . . . .              | 4-38 |
| 110                   | Concrete Girder . . . . .                                | 4-28 | 156 Timber Floor Beam . . . . .                | 4-38 |
| 111                   | Timber Glue-Lam Girder . . . . .                         | 4-28 | 160 Steel Column on Spandrel Arch . . . . .    | 4-39 |
| 113                   | Steel Stringer . . . . .                                 | 4-29 | 161 Steel Hanger . . . . .                     | 4-39 |
| 114                   | Concrete Multiple Web Girder Unit . . . . .              | 4-29 | 162 Steel Pin . . . . .                        | 4-40 |
| 115                   | Prestressed Concrete Girder . . . . .                    | 4-29 |                                                |      |

| <b>Substructure</b> |                                               |      |  |
|---------------------|-----------------------------------------------|------|--|
| 200                 | Abutment Fill                                 | 4-43 |  |
| 202                 | Steel Pile/Column                             | 4-43 |  |
| 204                 | Prestressed Concrete Pile/Column              | 4-44 |  |
| 205                 | Concrete Pile/Column                          | 4-44 |  |
| 206                 | Timber Pile/Column                            | 4-44 |  |
| 207                 | Concrete Pile/Column w/Steel Jacket           | 4-45 |  |
| 208                 | Concrete Pile/Column w/Composite Wrap         | 4-45 |  |
| 209                 | Submerged Concrete Pile/Column w/Steel Jacket | 4-46 |  |
| 210                 | Concrete Pier Wall                            | 4-46 |  |
| 211                 | Other Pier Wall                               | 4-46 |  |
| 212                 | Concrete Submerged Pier Wall                  | 4-46 |  |
| 213                 | Other Submerged Pier Wall                     | 4-46 |  |
| 214                 | Concrete Web Wall between Columns             | 4-47 |  |
| 215                 | Concrete Abutment                             | 4-47 |  |
| 216                 | Timber Abutment                               | 4-48 |  |
| 217                 | Other Abutment                                | 4-48 |  |
| 218                 | Steel Abutment                                | 4-49 |  |
| 219                 | Concrete Cantilevered Span Abutment           | 4-50 |  |
| 220                 | Concrete Submerged Foundation                 | 4-50 |  |
| 221                 | Concrete Foundation                           | 4-51 |  |
| 222                 | Timber Foundation                             | 4-51 |  |
| 225                 | Steel Submerged Pile/Column                   | 4-52 |  |
| 226                 | Prestressed Concrete Submerged Pile/Column    | 4-52 |  |
| 227                 | Concrete Submerged Pile/Column                | 4-52 |  |
| 228                 | Timber Submerged Pile/Column                  | 4-53 |  |
| 229                 | Timber Cap Rehab with Steel                   | 4-53 |  |
| 231                 | Steel Pier Cap/Crossbeam                      | 4-54 |  |
| 233                 | Prestressed Concrete Pier Cap/Crossbeam       | 4-54 |  |
| 234                 | Concrete Pier Cap/Crossbeam                   | 4-55 |  |
| 235                 | Timber Pier Cap                               | 4-55 |  |
| 236                 | Concrete Floating Pontoon                     | 4-56 |  |
| 237                 | Pontoon Hatch/Bulkhead                        | 4-58 |  |
| 238                 | Floating Bridge - Anchor Cable                | 4-58 |  |

| <b>Culverts</b> |                  |      |  |
|-----------------|------------------|------|--|
| 240             | Metal Culvert    | 4-59 |  |
| 241             | Concrete Culvert | 4-59 |  |
| 242             | Timber Culvert   | 4-60 |  |
| 243             | Other Culvert    | 4-60 |  |

| <b>Tunnels</b> |                       |      |  |
|----------------|-----------------------|------|--|
| 250            | Tunnel                | 4-61 |  |
| 251            | Tunnel - Timber Lined | 4-61 |  |
| 252            | Tunnel - Unlined      | 4-61 |  |
| 253            | Tunnel Tile           | 4-61 |  |

| <b>Sidewalk and Supports</b> |                                                      |      |  |
|------------------------------|------------------------------------------------------|------|--|
| 260                          | Steel Open Grid Sidewalk and Supports                | 4-62 |  |
| 261                          | Steel Concrete Filled Grid Sidewalk and Supports     | 4-62 |  |
| 262                          | Corrugated/Orthotropic Sidewalk and Supports         | 4-62 |  |
| 264                          | Timber Sidewalk and Supports                         | 4-63 |  |
| 266                          | Concrete Sidewalk and Supports                       | 4-63 |  |
| 267                          | Fiber Reinforced Polymer (FRP) Sidewalk and Supports | 4-63 |  |

| <b>Bearings</b> |                                          |      |  |
|-----------------|------------------------------------------|------|--|
| 310             | Elastomeric Bearing                      | 4-64 |  |
| 311             | Moveable Bearing (Roller, Sliding, etc.) | 4-64 |  |
| 312             | Concealed Bearing or Bearing System      | 4-64 |  |
| 313             | Fixed Bearing                            | 4-64 |  |
| 314             | Pot Bearing                              | 4-65 |  |
| 315             | Disc Bearing                             | 4-65 |  |
| 316             | Isolation Bearing                        | 4-65 |  |

| <b>Approach Slab</b> |                                |      |  |
|----------------------|--------------------------------|------|--|
| 321                  | Concrete Roadway Approach Slab | 4-66 |  |
| 322                  | Bridge Impact                  | 4-66 |  |

| <b>Bridge Rail</b> |                         |      |  |
|--------------------|-------------------------|------|--|
| 330                | Metal Bridge Railing    | 4-67 |  |
| 331                | Concrete Bridge Railing | 4-67 |  |
| 332                | Timber Bridge Railing   | 4-67 |  |
| 333                | Other Bridge Railing    | 4-67 |  |

| <b>Pedestrian Rail</b>                 |      |                                      |      |
|----------------------------------------|------|--------------------------------------|------|
| 340 Metal Pedestrian Rail . . . . .    | 4-68 | 342 Timber Pedestrian Rail . . . . . | 4-68 |
| 341 Concrete Pedestrian Rail . . . . . | 4-68 | 343 Other Pedestrian Rail . . . . .  | 4-68 |

| <b>Smart Flags</b>                              |      |                                                  |      |
|-------------------------------------------------|------|--------------------------------------------------|------|
| 355 Damaged Bolts or Rivets . . . . .           | 4-69 | 370 Seismic - Longitudinal Restrainer . . . . .  | 4-72 |
| 356 Steel Cracking . . . . .                    | 4-69 | 371 Seismic - Transverse Restrainer . . . . .    | 4-72 |
| 357 Pack Rust . . . . .                         | 4-69 | 372 Seismic - Link/Pin Restrainer . . . . .      | 4-73 |
| 360 Bridge Movement . . . . .                   | 4-70 | 373 Seismic - Catcher Block . . . . .            | 4-73 |
| 361 Scour . . . . .                             | 4-70 | 374 Seismic - Column Silo . . . . .              | 4-74 |
| 362 Impact Damage . . . . .                     | 4-71 | 375 Cathodic Protection . . . . .                | 4-75 |
| 366 Undercrossing - Safety Inspection . . . . . | 4-71 | 376 Concrete Deck Delamination Testing . . . . . | 4-75 |
| 367 Movable Bridge . . . . .                    | 4-71 | 380 Unknown Foundation Units . . . . .           | 4-75 |
| 368 Seismic Pier Crossbeam Bolster . . . . .    | 4-72 | 400 Asphalt Butt Joint Seal . . . . .            | 4-76 |
| 369 Seismic Pier Infill Wall . . . . .          | 4-72 | 401 Asphalt Open Joint Seal . . . . .            | 4-77 |

| <b>Expansion Joints</b>                         |      |                                                   |      |
|-------------------------------------------------|------|---------------------------------------------------|------|
| 402 Open Concrete Joint . . . . .               | 4-78 | 412 Strip Seal - Anchored . . . . .               | 4-81 |
| 403 Concrete Bulb-T . . . . .                   | 4-78 | 413 Strip Seal - Welded . . . . .                 | 4-81 |
| 404 Compression Seal/Concrete Header . . . . .  | 4-79 | 414 Bolt Down - Sliding Plate w/springs . . . . . | 4-82 |
| 405 Compression Seal/Polymer Header . . . . .   | 4-79 | 415 Bolt Down Panel - Molded Rubber . . . . .     | 4-83 |
| 406 Compression Seal/Steel Header . . . . .     | 4-79 | 416 Assembly Joint Seal (Modular) . . . . .       | 4-83 |
| 407 Steel Angle Header . . . . .                | 4-79 | 417 Silicone Rubber Joint Filler . . . . .        | 4-84 |
| 408 Steel Sliding Plate . . . . .               | 4-80 | 418 Asphalt Plug . . . . .                        | 4-84 |
| 409 Steel Sliding Plate w/Raised Bars . . . . . | 4-80 | 419 Steel Angle w/Raised Bars . . . . .           | 4-85 |
| 410 Steel Fingers . . . . .                     | 4-80 | 420 Joint Paved Over Flag . . . . .               | 4-85 |
| 411 Steel Fingers w/Raised Bars . . . . .       | 4-81 |                                                   |      |

| <b>Movable Bridges</b>                   |      |  |  |
|------------------------------------------|------|--|--|
| 501 Movable Bridge Steel Tower . . . . . | 4-86 |  |  |

| <b>Other Bridge Elements</b>                 |      |                                              |      |
|----------------------------------------------|------|----------------------------------------------|------|
| 705 Bridge Luminaire Pole and Base . . . . . | 4-86 | 710 Bridge Mounted Sign Structures . . . . . | 4-87 |

| <b>Overlays</b>                                                         |      |                                           |      |
|-------------------------------------------------------------------------|------|-------------------------------------------|------|
| 800 Asphalt Concrete (AC) Overlay . . . . .                             | 4-88 | 804 Polyester Concrete Overlay . . . . .  | 4-89 |
| 801 Asphalt Concrete (AC) Overlay With Waterproofing Membrane . . . . . | 4-88 | 805 AC Over a Polymer Overlay . . . . .   | 4-90 |
| 802 Thin Polymer Overlay . . . . .                                      | 4-89 | 806 BST on Concrete (Chip Seal) . . . . . | 4-90 |
| 803 Modified Concrete Overlay . . . . .                                 | 4-89 |                                           |      |

| <b>Protective Coatings</b>                         |      |                                                |      |
|----------------------------------------------------|------|------------------------------------------------|------|
| 901 Red Lead Alkyd Paint System . . . . .          | 4-91 | 906 Metalizing . . . . .                       | 4-91 |
| 902 Inorganic Zinc/Vinyl Paint System . . . . .    | 4-91 | 907 Galvanizing . . . . .                      | 4-91 |
| 903 Inorganic Zinc/Urethane Paint System . . . . . | 4-91 | 908 Epoxy Paint for Weathering Steel . . . . . | 4-91 |
| 904 Organic Zinc/Urethane Paint System . . . . .   | 4-91 | 909 Zinc Primer . . . . .                      | 4-92 |
| 905 Coal Tar Epoxy Paint System . . . . .          | 4-91 | 910 Weathering Steel Patina . . . . .          | 4-92 |

## 4.02 List of WSDOT Elements by Subject

| Bridge Decks |                                       |      |    |                                         |      |
|--------------|---------------------------------------|------|----|-----------------------------------------|------|
| 12           | Concrete Deck                         | 4-14 | 29 | Steel Deck - Concrete Filled Grid       | 4-16 |
| 13           | Bridge Deck Surface                   | 4-14 | 30 | Deck - Corrugated or Other Steel system | 4-17 |
| 14           | Fully Supported Concrete Deck         | 4-15 | 31 | Timber Deck                             | 4-17 |
| 20           | Concrete Deck - Lightweight Aggregate | 4-15 | 32 | Fiber Reinforced Polymer (FRP) - Deck   | 4-17 |
| 26           | Concrete Deck w/Coated Bars           | 4-16 | 35 | Concrete Deck Soffit                    | 4-18 |
| 27           | Steel Orthotropic Deck                | 4-16 | 36 | Deck Rebar Cover Flag                   | 4-18 |
| 28           | Steel Deck - Open Grid                | 4-16 |    |                                         |      |

| Bridge Deck Overlays |                                                              |      |     |                             |      |
|----------------------|--------------------------------------------------------------|------|-----|-----------------------------|------|
| 800                  | Asphalt Concrete (AC) Overlay                                | 4-88 | 803 | Modified Concrete Overlay   | 4-89 |
| 801                  | Asphalt Concrete (AC) Overlay With<br>Waterproofing Membrane | 4-88 | 804 | Polyester Concrete Overlay  | 4-89 |
| 802                  | Thin Polymer Overlay                                         | 4-89 | 805 | AC Over a Polymer Overlay   | 4-90 |
|                      |                                                              |      | 806 | BST on Concrete (Chip Seal) | 4-90 |

| Expansion Joints |                                   |      |     |                                     |      |
|------------------|-----------------------------------|------|-----|-------------------------------------|------|
| 402              | Open Concrete Joint               | 4-78 | 412 | Strip Seal - Anchored               | 4-81 |
| 403              | Concrete Bulb-T                   | 4-78 | 413 | Strip Seal - Welded                 | 4-81 |
| 404              | Compression Seal/Concrete Header  | 4-79 | 414 | Bolt Down - Sliding Plate w/springs | 4-82 |
| 405              | Compression Seal/Polymer Header   | 4-79 | 415 | Bolt Down Panel - Molded Rubber     | 4-83 |
| 406              | Compression Seal/Steel Header     | 4-79 | 416 | Assembly Joint Seal (Modular)       | 4-83 |
| 407              | Steel Angle Header                | 4-79 | 417 | Silicone Rubber Joint Filler        | 4-84 |
| 408              | Steel Sliding Plate               | 4-80 | 418 | Asphalt Plug                        | 4-84 |
| 409              | Steel Sliding Plate w/Raised Bars | 4-80 | 419 | Steel Angle w/Raised Bars           | 4-85 |
| 410              | Steel Fingers                     | 4-80 | 420 | Joint Paved Over Flag               | 4-85 |
| 411              | Steel Fingers w/Raised Bars       | 4-81 |     |                                     |      |

| Approach Slab |                                |      |
|---------------|--------------------------------|------|
| 321           | Concrete Roadway Approach Slab | 4-66 |

| Bridge Rail |                         |      |     |                       |      |
|-------------|-------------------------|------|-----|-----------------------|------|
| 330         | Metal Bridge Railing    | 4-67 | 332 | Timber Bridge Railing | 4-67 |
| 331         | Concrete Bridge Railing | 4-67 | 333 | Other Bridge Railing  | 4-67 |

| Pedestrian Rail |                          |      |     |                        |      |
|-----------------|--------------------------|------|-----|------------------------|------|
| 340             | Metal Pedestrian Rail    | 4-68 | 342 | Timber Pedestrian Rail | 4-68 |
| 341             | Concrete Pedestrian Rail | 4-68 | 343 | Other Pedestrian Rail  | 4-68 |

| Sidewalk and Supports |                                                  |      |     |                                                      |      |
|-----------------------|--------------------------------------------------|------|-----|------------------------------------------------------|------|
| 260                   | Steel Open Grid Sidewalk and Supports            | 4-62 | 264 | Timber Sidewalk and Supports                         | 4-63 |
| 261                   | Steel Concrete Filled Grid Sidewalk and Supports | 4-62 | 266 | Concrete Sidewalk and Supports                       | 4-63 |
| 262                   | Corrugated/Orthotropic Sidewalk and Supports     | 4-62 | 267 | Fiber Reinforced Polymer (FRP) Sidewalk and Supports | 4-63 |

| Seismic Retrofit |                                               |      |     |                                   |      |
|------------------|-----------------------------------------------|------|-----|-----------------------------------|------|
| 207              | Concrete Pile/Column w/Steel Jacket           | 4-45 | 370 | Seismic - Longitudinal Restrainer | 4-72 |
| 208              | Concrete Pile/Column w/Composite Wrap         | 4-45 | 371 | Seismic - Transverse Restrainer   | 4-72 |
| 209              | Submerged Concrete Pile/Column w/Steel Jacket | 4-46 | 372 | Seismic - Link/Pin Restrainer     | 4-73 |
| 368              | Seismic Pier Crossbeam Bolster                | 4-72 | 373 | Seismic - Catcher Block           | 4-73 |
| 369              | Seismic Pier Infill Wall                      | 4-72 |     |                                   |      |



| <b>Reinforced Concrete</b>                      |      |                                                |      |
|-------------------------------------------------|------|------------------------------------------------|------|
| 38 Concrete Slab . . . . .                      | 4-20 | 116 Concrete Stringer . . . . .                | 4-30 |
| 49 Concrete Hollow Slab . . . . .               | 4-20 | 119 Concrete Truss . . . . .                   | 4-31 |
| 52 Concrete Slab w/Coated Bars . . . . .        | 4-21 | 144 Concrete Arch . . . . .                    | 4-34 |
| 96 Concrete Encased Steel Girder . . . . .      | 4-23 | 145 Earth Filled Concrete Arch . . . . .       | 4-35 |
| 105 Concrete Box Girder . . . . .               | 4-26 | 150 Concrete Column on Spandrel Arch . . . . . | 4-36 |
| 110 Concrete Girder . . . . .                   | 4-28 | 155 Concrete Floor Beam . . . . .              | 4-38 |
| 114 Concrete Multiple Web Girder Unit . . . . . | 4-29 |                                                |      |

| <b>Prestressed Concrete</b>                                |      |                                                              |      |
|------------------------------------------------------------|------|--------------------------------------------------------------|------|
| 50 Prestressed Concrete Slab . . . . .                     | 4-20 | 103 Prestressed Concrete Super Girder . . . . .              | 4-26 |
| 51 Prestressed Concrete Slab w/Coated Bars . . . . .       | 4-20 | 104 Post Tension Concrete Box Girder . . . . .               | 4-26 |
| 89 Prestressed Concrete Girder w/Coated Strands . . . . .  | 4-22 | 108 Prestressed Concrete Bulb-T Girder . . . . .             | 4-27 |
| 97 Prestressed Concrete Trapezoidal Girder . . . . .       | 4-24 | 109 Prestressed Concrete Multiple Web Girder Units . . . . . | 4-28 |
| 98 Thin Flange Girder . . . . .                            | 4-24 | 115 Prestressed Concrete Girder . . . . .                    | 4-29 |
| 100 Post Tensioned Concrete Segmental Box Girder . . . . . | 4-25 | 154 Prestressed Concrete Floor Beam . . . . .                | 4-37 |

| <b>Structural Steel</b>           |      |                                             |      |
|-----------------------------------|------|---------------------------------------------|------|
| 90 Steel Rolled Girder . . . . .  | 4-22 | 131 Steel Deck Truss . . . . .              | 4-31 |
| 91 Steel Riveted Girder . . . . . | 4-22 | 133 Truss Gusset Plates . . . . .           | 4-32 |
| 92 Steel Welded Girder . . . . .  | 4-23 | 141 Steel Arch . . . . .                    | 4-33 |
| 102 Steel Box Girder . . . . .    | 4-25 | 142 Steel Tied Arch . . . . .               | 4-33 |
| 107 Steel Open Girder . . . . .   | 4-27 | 143 Steel Suspender . . . . .               | 4-34 |
| 113 Steel Stringer . . . . .      | 4-29 | 152 Steel Floor Beam . . . . .              | 4-37 |
| 126 Steel Thru Truss . . . . .    | 4-31 | 160 Steel Column on Spandrel Arch . . . . . | 4-39 |

| <b>Pin &amp; Hangers</b>   |      |                         |      |
|----------------------------|------|-------------------------|------|
| 161 Steel Hanger . . . . . | 4-39 | 162 Steel Pin . . . . . | 4-40 |

| <b>Timber</b>                        |      |                                 |      |
|--------------------------------------|------|---------------------------------|------|
| 54 Timber Slab . . . . .             | 4-21 | 135 Timber Truss . . . . .      | 4-32 |
| 111 Timber Glue-Lam Girder . . . . . | 4-28 | 139 Timber Arch . . . . .       | 4-33 |
| 117 Timber Sawn Girder . . . . .     | 4-30 | 156 Timber Floor Beam . . . . . | 4-38 |
| 118 Timber Stringer . . . . .        | 4-30 |                                 |      |

| <b>Cables</b>                              |      |                                           |      |
|--------------------------------------------|------|-------------------------------------------|------|
| 146 Suspension - Main Cable . . . . .      | 4-35 | 149 Cable Stayed Bridge - Cable . . . . . | 4-36 |
| 147 Suspension - Suspender Cable . . . . . | 4-35 |                                           |      |

| <b>Bearings</b>                                        |      |                                 |      |
|--------------------------------------------------------|------|---------------------------------|------|
| 310 Elastomeric Bearing . . . . .                      | 4-64 | 314 Pot Bearing . . . . .       | 4-65 |
| 311 Moveable Bearing (Roller, Sliding, etc.) . . . . . | 4-64 | 315 Disc Bearing . . . . .      | 4-65 |
| 312 Concealed Bearing or Bearing System . . . . .      | 4-64 | 316 Isolation Bearing . . . . . | 4-65 |
| 313 Fixed Bearing . . . . .                            | 4-64 |                                 |      |

| <b>Reinforced Concrete</b>                        |      |                                              |      |
|---------------------------------------------------|------|----------------------------------------------|------|
| 205 Concrete Pile/Column . . . . .                | 4-44 | 221 Concrete Foundation . . . . .            | 4-51 |
| 210 Concrete Pier Wall . . . . .                  | 4-46 | 227 Concrete Submerged Pile/Column . . . . . | 4-52 |
| 212 Concrete Submerged Pier Wall . . . . .        | 4-46 | 234 Concrete Pier Cap/Crossbeam . . . . .    | 4-55 |
| 214 Concrete Web Wall between Columns . . . . .   | 4-47 | 236 Concrete Floating Pontoon . . . . .      | 4-56 |
| 215 Concrete Abutment . . . . .                   | 4-47 | 237 Pontoon Hatch/Bulkhead . . . . .         | 4-58 |
| 219 Concrete Cantilevered Span Abutment . . . . . | 4-50 | 238 Floating Bridge - Anchor Cable . . . . . | 4-58 |
| 220 Concrete Submerged Foundation . . . . .       | 4-50 |                                              |      |

| <b>Prestressed Concrete</b>                             |      |                                                       |      |
|---------------------------------------------------------|------|-------------------------------------------------------|------|
| 204 Prestressed Concrete Pile/Column . . . . .          | 4-44 | 233 Prestressed Concrete Pier Cap/Crossbeam . . . . . | 4-54 |
| 226 Prestressed Concrete Submerged Pile/Column. . . . . | 4-52 |                                                       |      |
| <b>Structural Steel</b>                                 |      |                                                       |      |
| 202 Steel Pile/Column . . . . .                         | 4-43 | 225 Steel Submerged Pile/Column . . . . .             | 4-52 |
| 218 Steel Abutment . . . . .                            | 4-49 | 231 Steel Pier Cap/Crossbeam . . . . .                | 4-54 |
| <b>Timber</b>                                           |      |                                                       |      |
| 206 Timber Pile/Column . . . . .                        | 4-44 | 228 Timber Submerged Pile/Column. . . . .             | 4-53 |
| 216 Timber Abutment . . . . .                           | 4-48 | 235 Timber Pier Cap . . . . .                         | 4-55 |
| 222 Timber Foundation . . . . .                         | 4-51 |                                                       |      |
| <b>Substructure - Other</b>                             |      |                                                       |      |
| 211 Other Pier Wall . . . . .                           | 4-46 | 217 Other Abutment . . . . .                          | 4-48 |
| 213 Other Submerged Pier Wall . . . . .                 | 4-46 |                                                       |      |
| <b>Culverts</b>                                         |      |                                                       |      |
| 240 Metal Culvert . . . . .                             | 4-59 | 242 Timber Culvert . . . . .                          | 4-60 |
| 241 Concrete Culvert. . . . .                           | 4-59 | 243 Other Culvert . . . . .                           | 4-60 |
| <b>Tunnels</b>                                          |      |                                                       |      |
| 250 Tunnel. . . . .                                     | 4-61 | 252 Tunnel - Unlined . . . . .                        | 4-61 |
| 251 Tunnel - Timber Lined. . . . .                      | 4-61 | 253 Tunnel Tile . . . . .                             | 4-61 |
| <b>Movable Bridges</b>                                  |      |                                                       |      |
| 501 Movable Bridge Steel Tower. . . . .                 | 4-86 |                                                       |      |
| <b>Other Bridge Elements</b>                            |      |                                                       |      |
| 705 Bridge Luminaire Pole and Base . . . . .            | 4-86 | 710 Bridge Mounted Sign Structures. . . . .           | 4-87 |
| <b>Protective Coatings</b>                              |      |                                                       |      |
| 901 Red Lead Alkyd Paint System . . . . .               | 4-91 | 906 Metalizing . . . . .                              | 4-91 |
| 902 Inorganic Zinc/Vinyl Paint System . . . . .         | 4-91 | 907 Galvanizing. . . . .                              | 4-91 |
| 903 Inorganic Zinc/Urethane Paint System. . . . .       | 4-91 | 908 Epoxy Paint for Weathering Steel. . . . .         | 4-91 |
| 904 Organic Zinc/Urethane Paint System. . . . .         | 4-91 | 909 Zinc Primer . . . . .                             | 4-92 |
| 905 Coal Tar Epoxy Paint System. . . . .                | 4-91 | 910 Weathering Steel Patina. . . . .                  | 4-92 |
| <b>Smart Flags</b>                                      |      |                                                       |      |
| 322 Bridge Impact . . . . .                             | 4-66 | 362 Impact Damage . . . . .                           | 4-71 |
| 355 Damaged Bolts or Rivets . . . . .                   | 4-69 | 366 Undercrossing - Safety Inspection . . . . .       | 4-71 |
| 356 Steel Cracking . . . . .                            | 4-69 | 367 Movable Bridge. . . . .                           | 4-71 |
| 357 Pack Rust. . . . .                                  | 4-69 | 375 Cathodic Protection . . . . .                     | 4-75 |
| 360 Bridge Movement . . . . .                           | 4-70 | 376 Concrete Deck Delamination Testing . . . . .      | 4-75 |
| 361 Scour . . . . .                                     | 4-70 |                                                       |      |

## 4.1 Introduction

This chapter defines the Washington State Department of Transportation (WSDOT) elements for recording the structural condition evaluation of bridges. Local Agencies are encouraged, but not required to use the WSDOT Bridge Elements as defined in this chapter in order to use WSDOT management strategies and lessons learned. The basic intent of any element data is to supplement the National Bridge Inventory (NBI) structural evaluation of the Deck, Superstructure, and Substructure. Most of the other NBI information such as location, traffic, and geometry is still useful, but element conditions are a practical necessity to identify and manage bridge needs.

Though the NBIS did provide a consistent standard for the collection of bridge data, it was not comprehensive enough to provide performance-based decision support that included economic considerations. Among the problems with the NBIS are:

- Each bridge is divided into only three major parts for condition assessment: superstructure, substructure, and deck. This level of detail is not sufficient to identify appropriate repair strategies, or to estimate costs.
- Each of the three major parts was rated on a 0-9 scale by severity of deterioration, without identifying the deterioration process at work or the extent of deterioration.
- NBI condition ratings vary based on the vague language of the condition definitions. Because the bridges include multiple distress symptoms and ratings to describe the overall or “average” condition of the bridge, is often difficult to decide what the “average” condition is when a bridge has mainly localized problems.
- NBI does not provide a method to inspect or track the performance of items such as paint, overlays, and expansion joints.

WSDOT recognized a different strategy towards future bridge preservation was needed in the early 1980's. A comprehensive deck testing program existed at the time and obviously the testing should have a connection to the NBI deck condition rating. WSDOT elements have been in use since 1992 and were designed to be practical for the inspector, useful to a bridge manager, and accurately capture bridge conditions. WSDOT elements have matured since 1992 and so have the national element philosophies:

- 1985 – NCHRP Project 12-28: Bridgit and Pontis Management software
- 1987 – NCHRP Report 300: Element based Bridge Management System (BMS)
- 1993 – FHWA CoRe Element Report recommendations
- 1996 – AASHTO CoRe Element Guidelines adopted
- 2011 – AASHTO Guidelines for Bridge Element Inspection
- 2014 – FHWA requirement to collect element level bridge inspection data for NHS bridges.
- 2015 – As a supplement to the National Bridge Inventory (NBI) data submission due April 1, 2015, and every year thereafter, each State and Federal agency will also provide element level bridge inspection data for bridges on the NHS to the FHWA for inclusion in the NBI. Today, a successful Bridge Management System must use supplemental bridge condition data to ensure the effective use of available funds. WSDOT element data has supported WSDOT Bridge needs with minor changes since the year 2008 in the follow ways:

- Element data is used to identify current bridge condition, need, and cost.
- Provided a logical and realistic method to prioritize bridge projects.
- Realistic and reliable forecasts of future preservation need and cost.
- Adapted changes in management philosophies without changing elements.
- Tracks the performance of desired bridge needs.

Elements represent parts of a structure that are relevant to document structural conditions with clearly defined condition states or to manage. Elements that carry primary design loads are considered structural elements and all follow the same condition state philosophy.

“Smart Flags” are elements used to track supplemental information that may or may not be included in other elements or exist at the time of original construction. Smart Flag condition states are defined as necessary to collect useful information and may be significantly different than other element definitions. Examples of Smart Flags are Steel Fatigue (cracks in steel elements), Scour, and Pack Rust.

WSDOT elements presented herein are used by both the WSDOT Bridge Office and Local Programs (LP). Local Agencies are encouraged to follow these guidelines so as to provide a consistent basis for management, evaluation, and reporting of inspection data.

#### **4.1.1 Identifying Elements Prior to Inspection**

Details about the design of the bridge are important when identifying the elements. As-built plans should be used to determine the correct elements, and then field verified during the inspection. If as-built plans are not available, then the elements will have to be defined or assumed at the bridge site. Many of the element dimensions for the element total quantity are difficult to determine in the field and it is highly recommend the total quantities be calculated based on contract plan dimensions.

For example, looking at the contract Plans is the only practical way to determine if a bridge deck has plain reinforced steel which is element 12, or epoxy coated steel which is element 26 because this information is not visible to the inspector. Likewise, field measuring the deck length and width in traffic would not be necessary and usually less accurate than if plan dimensions are available.

An average bridge made of the same material will have six to ten elements. A large or complex bridge may have up to 20 elements. A typical bridge will have a bridge deck, possibly a deck overlay, bridge rails, a primary load carrying member like a prestressed concrete girder, primary substructure support like concrete columns, other elements like abutments, expansion joints and/or bearings.

In order to maintain quality element data, the Inspector is responsible for updating the elements and quantities as they change with time by maintenance or by contract. Many bridges will have construction work that changes the joints, asphalt depth, rail, concrete overlay, or widens the structure, etc. These activities can change elements that apply to the bridge and must be updated accordingly. WSDOT uses a Contract History database to log contract work and for reference. See Section 2.02 for more information on the Contract History database.

### 4.1.2 Element Units and the Total Quantity

Every element has assigned units that are necessary for the inspector to quantify the element defects. The units are “SF” for Square Feet, “LF” for Lineal Feet, “EA” for Each, or in the case of concrete pontoons the units are per Cell.

“SF” units apply to elements where the surface area provides the better method to document element condition and manage the element, such as deck and paint elements.

The total quantity for an element with “LF” units should represent the total length of an element and is based on the way it was constructed. For example: A bridge may have been built using five “Prestressed Concrete Girders.” Each one was individually pre-cast and then put into place at the bridge site. If each girder were 100 feet in length then the total element quantity would be “500 LF.” If the same bridge was a “Concrete Box Girder” then the total quantity would be “100 LF” since the box girder was constructed as one unit.

“EA” units are used to determine the number of members in a condition state. For example: A bridge may 5 piles at 3 piers for a total quantity of 15 for the pile element. Then, each pile is inspected, evaluated, and recorded in the appropriate condition state. Elements with units of “EA” code the entire member in one condition state, such as piles, where the entire pile is in one of the defined condition states. Other element units, such as “LF” or “SF” may have all or portions of the element in one or all of the condition states in order to describe the existing element conditions.

### 4.1.3 Quantifying Element Defects

In order to quantify the condition of an element, the first step is to review the condition state language for the elements. A complete list of the condition state descriptions is provided in this chapter and summarized in this section.

Element condition state (CS) language is based on four condition states for all primary structural members, regardless of the materials. Similar to the NBI system of evaluation, element condition requires the inspector to evaluate defects and also quantify the defect’s impact to the element or possibly the bridge. A defect evaluation may result in element quantities in CS1, CS2, CS3, or CS4 depending on the location, size, structural importance or element units.

#### 4.1.3.1 Affected Quantity

The concept of the “Affected quantity” is relied on heavily when quantifying the defects in the primary structural elements and should be applied in two ways. Condition State 3 defines “Affected Quantity” of the defect as local damage to a member and the “Affected Quantity” is the actual length of the defect. Whereas, Condition State 4 defines “Affected Quantity” as a reduced capacity of the member and the “Affected Quantity” is the length of the span. In the case of prestressed girders, damage that does not “Affect” capacity of a prestressed girder would only quantify the length of damaged concrete in CS3. Whereas, Condition State 4 does “Affect” the capacity of the girder and the quantity is the span length, not just the length of damaged concrete. Using this same rational to quantify repairs in CS2, a patch that covers damage to the concrete only is quantified as the length of the visible patch and a patch that covers repaired strand is quantified as the span length in CS2. In other words, the patch is quantified in CS2 based on the “Affected length” of the damage.

This philosophy applies directly to all beam type elements including concrete slab structures with side-by-side beam elements using square foot quantities. It is less obvious where there can be significant redistribution of stresses such as a timber deck or cast-in-place concrete slab. In these cases a defect, such as a hole in the deck, would have to be evaluated as to whether the capacity of the span is “Affected” or not. Trusses are the most difficult because the linear feet quantities represent a 3 dimensional member with chords, verticals, horizontals, sway bracing, etc. Trusses should quantify CS3 defects by panel length of truss and CS4 truss capacity defects by span length of the truss.

#### 4.1.3.2 WSDOT Condition States for structural members

The following summarizes the WSDOT element condition state philosophy for primary structural members. Different condition philosophies apply to the non-primary structural elements such as deck/overlays, joints, paint, and smart flags which are specified for each element in Chapter 4, but not discussed in this section.

**Condition State 1: Good Condition** – Most parts of a bridge will be in this condition state for all WSDOT elements. The element may have some defects, but is in good condition. Many times new bridges have insignificant defects and older bridges will acquire insignificant defects with time. In order to determine if the defect is insignificant, the inspector must decide if the defect will impact the element load carrying capacity with time. Inspectors are cautioned to look at new construction that may not be CS1.

**Condition State 2: Repaired Condition** – This condition state documents repairs to structural members. A repair is defined as a defective member partially modified to carry design loads and still dependent on the remaining portions of the defective member, such as an in-span splice, helper member, or column splice. Generally, these are easy to identify and report. Common repairs do not have the same integrity or longevity as original construction. Many times members are difficult to access and prohibit a good quality repair. Inspectors are cautioned to verify repairs to make sure they are functioning as intended. When a damaged or defective member has been entirely replaced, the member quantity is CS1 or considered a new member. If a repair is not completed correctly or is not functioning properly, then the repair should be coded as CS3 or CS4. For example:

- A timber helper stringer/pile that does not properly transfer design loads is not considered sufficient to be considered in CS2. A repair must properly block, brace, or connect to the stringer/pile as required by repair design.
- Timber pier caps are assumed to be designed as simple spans. Even though the member that has been partially replaced is not continuous at a support, as long as there is a positive connection to the supporting columns, the replaced portion may be considered in CS1.

The amount of repaired quantity to be coded in CS2 depends on the affected length of the repair for all primary structural members. In general terms, the quantity to be coded in CS2 is the quantity that was in CS3 or CS4 and is now repaired. For example:

- A prestressed girder with a high load hit that did not damage strand would code the length of the concrete patch as the repair quantity for CS2. If a strand is damaged, then the span length is the repair quantity for CS2.

- A repaired crack in a steel member that did not threaten capacity would code the minimum length or 1 foot for CS2. If the repaired crack did threaten capacity, then the span length is the repair quantity for CS2.

**Condition State 3: Fair Condition** – This condition state records any significant defect noticed by the inspector, but the defect does not significantly impact the capacity of the element. Capacity is not currently threatened, but if left unchecked, it could be threatened in the future. Repairs may apply to the elements in CS3 because the defects are more economical address now than to wait and repair later.

**Condition State 4: Poor Condition** – This condition state documents members with defects that have impacted the structural capacity of the element. Based on the visual inspection, the owner of the bridge must address this deficiency in order to preserve or restore the capacity of the member and/or structure. Generally, these defects have reduced the structural capacity of the element, but are still within safe operating limits of design.

#### 4.1.4 Reporting Structural History

There are times when structural information may be known but not visible; or visible and then at a later time not visible to the inspector. This can happen to submerged piles/foundations that are buried one inspection and exposed the next. This also applies to asphalt overlays where the deck patching is not visible to the inspector. This type of element information should remain in the element notes until the element condition **is known to have changed**. An example of element change would be deck delaminations recorded in CS4 are not visible to the inspector and are removed by hydromilling during construction of a concrete overlay. The CS4 data does not apply after the concrete overlay is completed and WSDOT element 376 should be deleted from the report and the concrete deck CS4 quantity should be zero.

#### 4.1.5 Concrete Element Cracking

The following table is reproduced from the Bridge Inspector's Reference Manual (BIRM), Volume 1, Table 2.2.3; and should be used to distinguish between different sizes of concrete cracks.

|               | Reinforced Concrete |               | Prestressed Concrete |                 |
|---------------|---------------------|---------------|----------------------|-----------------|
|               | English             | Metric        | English              | Metric          |
| Hairline (HL) | < 0.0625"           | < 1.6 mm      | < 0.004"             | < 0.1 mm        |
|               | < 1/16"             |               |                      |                 |
| Narrow (N)    | 0.0625" to 0.125"   | 1.6 to 3.2 mm | 0.004" to 0.009"     | 0.1 to 0.23 mm  |
|               | 1/16" to 1/8"       |               |                      |                 |
| Medium (M)    | 0.125" to 0.1875"   | 3.2 to 4.8 mm | 0.010" to 0.030"     | 0.25 to 0.75 mm |
|               | 1/8" to 3/16"       |               |                      |                 |
| Wide (W)      | > 0.1875"           | > 4.8 mm      | > 0.030"             | > 0.76 mm       |
|               | > 3/16"             |               |                      |                 |

#### **WSDOT Element Concrete Crack Width Guidelines**

Table 4.1.5

**Concrete Structural Cracking** – For the purpose of evaluating element condition, concrete structural cracks are narrow (or wider) in regions of high shear or moment (see BIRM). Crack width is significant to the extent that it indicates exposure of rebar to water and/or a structural problem in a concrete element. Generally, most concrete elements have hairline cracking and not considered significant structurally.

#### 4.1.6 WSDOT Deck Element to NBI Deck Table

WSDOT began testing concrete decks in the early 1980s and discovered a very poor correlation to the traditional assumptions of deck deterioration. In addition, the deck testing and crack surveys did not prioritize deck preservation projects in a fashion acceptable to the inspectors, maintenance, or management. Today, WSDOT recommends the use of the deck and soffit elements and Table 4.1.6 to evaluate the NBI Item 058, NBI Deck Overall Condition Code. This table originates from the 1973 FHWA Coding Guidelines and has been modified to reflect WSDOT's primary bridge deck management philosophies since the early 1990s.

Secondary and more subjective concrete deck conditions such as cracking, scaling, leaching, rebar cover, chloride content, Half-cell potential, etc. may be documented in the deck element notes, but not applied to the deck element evaluation of structural condition. These secondary conditions are applied during annual prioritization of the concrete bridge decks and should not determine the NBI code. To be clear, these types of secondary conditions visible below the deck in the soffit or other structural elements below the deck element require an evaluation of:

| Percent of Concrete Deck Patches, Spalls, and Delaminations (CS2 + CS3 + CS4) | Percent of Concrete Deck Soffit in CS3 (CS3 only) | NBI Deck Condition Code |
|-------------------------------------------------------------------------------|---------------------------------------------------|-------------------------|
| N/A                                                                           | N/A                                               | 9                       |
| None                                                                          | None                                              | 8                       |
| None                                                                          | None                                              | 7                       |
| < 1%                                                                          | < 1%                                              | 6                       |
| 1% to 2%                                                                      | 1% to 2%                                          | 5                       |
| 2% to 5%                                                                      | 2% to 5%                                          | 4                       |
| > 5%                                                                          | > 5%                                              | 3                       |

**WSDOT Deck Condition to NBI Deck Overall**

**Table 4.1.6**



## 4.2 Bridge Decks

The intent of the bridge deck elements is to record the top surface deterioration. The Concrete Deck Soffit, slab, or deck-girder elements record the structural deterioration. Deck elements 12, 13, 14, 20, and 26 record deck patches in CS2, deck spalls in CS3, and delaminations in CS4. Other deck top surface distress such as cracking, scaling, and rutting are not tracked in the deck BMS condition states. These items should be described in the notes at the inspector's discretion. Do not count filling in of the rut as a patch. These locations have filled in a rut with Liquid Concrete or Ure-Fast and are not considered a deck structural repair.

All asphaltic patching material on a concrete bridge deck shall be considered a spalled area and since this is unacceptable patching material. These materials can be picked out of the spall and will smell like tar.

All bridges will have at least one deck element, even though some bridges do not have a traditional deck and use elements 13 or 14. (The one exception is a Luten Arch structure that is earth filled with an asphalt pavement only.)

Traditional concrete bridge decks use elements 12, 20, or 26 to record the top surface deterioration; and have the **WSDOT Soffit Element (35)** to record the structural deterioration. It should be noted for element 26 that epoxy coated rebar in bridge decks became an industry standard in Washington State in the early 1980s.

Non-Traditional concrete decks use elements 13 or 14 to record the top surface deterioration and the slab or deck-girder elements record the structural deterioration.

Steel and Timber decks use elements 28, 29, 30, 31 to record structural **deterioration of the top and bottom surface.**

Inspectors are encouraged to take the time to locate and describe the patches and spalls on larger structures using photos and descriptions. The preferred documentation format for patching is the number and SF per span. This format is easiest for the next inspector to identify quantity changes.

Quantity estimates must be based on the sum of the estimated length and width of the patched or spalled areas. Approximations based on the percent of area are not useful.

**Note:** The total quantity for deck elements is the actual bridge deck area. Do not use the NBI Item 051, **“Bridge Roadway Width Curb-to-Curb” (or WSBIS Item 1356 “Curb-to-Curb Width”)** when deck curb-to-curb dimensions vary.

**12 Concrete Deck**

**Units – SF**

This element defines a concrete bridge deck constructed with uncoated steel reinforcement. The total quantity for this element is the actual bridge deck area from curb line to curb line.

1. Defects are superficial. The deck surfaces have no spalls/delaminations or previous repairs. The deck surfaces may have hairline cracks or rock pockets. Wear and rutting may expose aggregate or reinforcing.
2. Deck area with repairs or patches. Do not include the rare case rutting filled with patching material.
3. Deck area with spalling. Do not add delaminations found in the field, see condition State 4.
4. Record the delaminated area (CS4) from WSDOT element 376 in the deck CS4. If new delaminations are found, do not add delaminations found in the field unless approved by Bridge Management. Chain Drag testing by the Bridge Inspector must chain the entire deck, record the results in a Chain Drag Report available on the Bridge Website under Bridge Overlays, and send the file to Bridge Management.

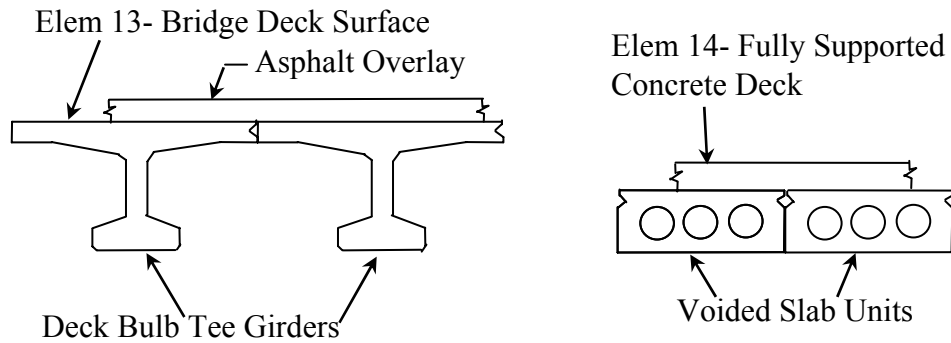

**13 Bridge Deck Surface**

**Units – SF**

This WSDOT element defines a surface of a bridge deck that consists of a slab or girder without a traditional deck. Usually there is a deck protection system (overlay) present, but in some cases, traffic may be driving directly on the girder or slab. The Bridge Deck Surface consists of precast or prestressed girders with no span between the flanges. This WSDOT element is generally used with superstructure elements 38, 49, 50, 51, 52, 54, 108, 109, or 114. The total quantity for this element is the actual bridge deck area from curb line to curb line.

---

|           |                                      |                   |
|-----------|--------------------------------------|-------------------|
| <b>14</b> | <b>Fully Supported Concrete Deck</b> | <b>Units – SF</b> |
|-----------|--------------------------------------|-------------------|

---

This WSDOT element defines a fully supported concrete bridge deck constructed with one layer of coated reinforcement (epoxy, galvanizing, stainless steel, etc.). The bridge support surface consists of precast or prestressed girders with no span between the flanges. This WSDOT element may apply to superstructure WSDOT elements 50, 51, 108, 109, or 114. The total quantity for this element is the actual bridge deck area from curb line to curb line.

**Condition States for WSDOT Elements 13 and 14**

1. Defects are superficial. The deck surfaces have no spalls/delaminations or previous repairs. The deck surfaces have no exposed reinforcing. The deck surfaces may have hairline cracks, rock pockets and/or be worn exposing aggregate.
2. If the top of the slabs or girders are visible, area of deck with repairs.
3. Deck area with spalling. Do not add delaminations found in the field, see condition State 4.
4. Record the delaminated area (CS4) from WSDOT element 376 in the deck CS4. If new delaminations are found, do not add delaminations found in the field unless approved by Bridge Management. Chain Drag testing by the Bridge Inspector must chain the entire deck, record the results in a Chain Drag Report available on the Bridge Website under Bridge Overlays, and send the file to Bridge Management.

---

|           |                                              |                   |
|-----------|----------------------------------------------|-------------------|
| <b>20</b> | <b>Concrete Deck – Lightweight Aggregate</b> | <b>Units – SF</b> |
|-----------|----------------------------------------------|-------------------|

---

This WSDOT element defines a lightweight concrete bridge deck constructed with lightweight aggregate and steel reinforcement. The total design weight of the deck is approximately 120 lbs./C.Y. The total quantity for this element is the actual bridge deck area from curb line to curb line.

**26 Concrete Deck w/Coated Bars****Units – SF**

This WSDOT element defines a concrete bridge deck constructed with coated (epoxy, galvanizing, stainless steel, etc.) reinforcement. The total quantity for this element is the actual bridge deck area from curb line to curb line.

**Condition States for WSDOT Elements 20 and 26**

1. Defects are superficial. The deck surfaces have no spalls/delaminations or previous repairs. The deck surfaces may have hairline cracks or rock pockets. Wear and rutting may expose aggregate or reinforcing.
2. Deck area with repairs or patches. Do not include the rare case rutting filled with patching material.
3. Deck area with spalling. Do not add delaminations found in the field, see condition State 4.
4. Record the delaminated area (CS4) from WSDOT element 376 in the deck CS4. If new delaminations are found, do not add delaminations found in the field unless approved by Bridge Management. Chain Drag testing by the Bridge Inspector must chain the entire deck, record the results in a Chain Drag Report available on the Bridge Website under Bridge Overlays, and send the file to Bridge Management.

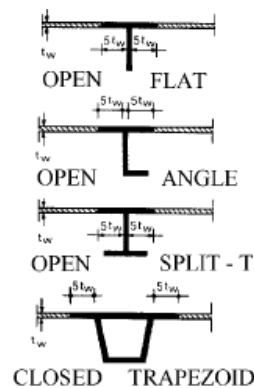
**27 Steel Orthotropic Deck****Units – SF**

This WSDOT element defines a bridge deck constructed of a flat, deck plate stiffened either longitudinally or transversely, or in both directions. See BIRM, Volume 1, Figure P.1.2.7 The total quantity for this element is the actual bridge deck area curb to curb.

**28 Steel Deck – Open Grid****Units – SF**

This WSDOT element defines a bridge deck constructed of steel grids that are open and unfilled. The total quantity for this deck WSDOT element is the actual bridge deck area from curb line to curb line.

**29 Steel Deck – Concrete Filled Grid****Units – SF**

This WSDOT element defines a bridge deck constructed of steel grids with either all of the openings or just those in the wheel lines filled with concrete. The total quantity for this element is the actual bridge deck area from curb line to curb line.

---

|           |                                                |                   |
|-----------|------------------------------------------------|-------------------|
| <b>30</b> | <b>Deck – Corrugated or Other Steel system</b> | <b>Units – SF</b> |
|-----------|------------------------------------------------|-------------------|

---

This WSDOT element generally defines a bridge deck constructed of corrugated metal filled with Portland cement concrete or asphaltic concrete. This element may also be used to identify other non-standard steel decks. The total quantity for this element is the actual bridge deck area from curb line to curb line.

**Condition States for WSDOT elements 27, 28, 29, and 30 (Structural Decks)**

1. Defects are superficial. The connectors (such as welds, rivets, etc.) or concrete/ asphalt filler are functioning as designed.
2. Deck area with repairs or replaced panels.
3. Deck area with structural defects. The defects do not significantly affect structural capacity. Deficiencies do not warrant analysis, but may require repairs.
4. Deck area with damage in locations or quantity and has reduced the structural capacity of the element. Structural analysis is warranted or has determined repairs are essential to restore the full capacity of the element.

---

|           |                    |                   |
|-----------|--------------------|-------------------|
| <b>31</b> | <b>Timber Deck</b> | <b>Units – SF</b> |
|-----------|--------------------|-------------------|

---

This WSDOT element defines a bridge deck constructed of timber. The deck may be longitudinally or transversely laminated or of planks. The deck may have an overlay or may be constructed with runners of metal or timber. The total quantity for this element is the actual bridge deck area from curb line to curb line.

1. Defects are superficial and have no effect on the structural capacity of the element. Decay, insect infestation, cracks, splits, or checks may exist.
2. Timber deck area with repairs, plates, or replaced timbers.
3. Timber deck area with structural defects. The defects do not significantly affect structural capacity. Deficiencies do not warrant analysis, but may require repairs. These areas are typically marked with a YELLOW TAG by inspectors.
4. Timber deck area with damage in locations or quantity and has reduced the structural capacity of the WSDOT element or the bridge. Structural analysis is warranted or has determined repairs are essential to restore the full capacity of the element. These areas are typically marked with a RED TAG by inspectors.

---

|           |                                              |                   |
|-----------|----------------------------------------------|-------------------|
| <b>32</b> | <b>Fiber Reinforced Polymer (FRP) – Deck</b> | <b>Units – SF</b> |
|-----------|----------------------------------------------|-------------------|

---

This WSDOT element defines a bridge deck constructed of fiber reinforced polymer. The total quantity for this element is the actual bridge deck area from curb line to curb line.

1. Defects are superficial. Cracking or delamination of layers may be present.
2. FRP Deck area with repairs, patches, or plated.
3. FRP Deck area with structural defects. The defects do not significantly affect structural capacity. Deficiencies do not warrant analysis, but may require repairs.
4. FRP Deck area with damage in locations or quantity and has reduced the structural capacity of the element or the bridge. Structural analysis is warranted or has determined repairs are essential to restore the full capacity of the element.

**35 Concrete Deck Soffit****Units – SF**

This WSDOT element defines the bottom (or undersurface) and edge of a concrete deck and is to be included with concrete WSDOT deck elements 12, 20, and 26. It is extremely valuable when an asphalt overlay exists on the top surface of the deck. The purpose of the element is to identify decks that may have a reduced structural capacity through visual inspections of the deck soffit. Element 35 does not apply if steel stay-in-place forms are present since the soffit is not visible. To be consistent with the deck quantity, the total quantity for this element the actual bridge deck area from curb line to curb line. Delaminations on concrete soffits over roadways may pose a danger to traffic below the bridge. In this situation, a repair should be recommended to correct the condition.

1. The undersurface of the deck is not showing signs of distress. There may be rust stains from rebar chairs, spalls without exposed rebar, or cracks with efflorescence.
2. Deck soffit area with repairs or patches.



3. Deck soffit area showing signs of reduced structural capacity. Typical indications include areas with heavy to severe rust staining from deck reinforcement; Spalling with corroded rebar indicating active corrosion; Cracks that are full depth, severe, or leaking water.

**36 Deck Rebar Cover Flag****Units – SF**

This does not apply to deck spalling with exposed rebar. This element is used to identify the top surface of bridge decks with concrete cover less than 1 inch and having rebar exposed. This condition results from either lack of cover during construction or general rutting that has exposed rebar. Deck patching is often difficult at these locations. This flag will determine method of deck rehabilitation. Report square foot of visible deficiency in CS2. The total quantity for this element is the actual bridge deck area curb to curb.

1. Deck top surface area with adequate concrete cover.
2. Concrete deck area with visible lack of cover due to construction or general rutting that has exposed rebar.



### 4.3 Superstructure

#### Girders

A girder is defined as any longitudinal structural member (single web or box section) that directly supports the bridge deck. A girder type bridge will typically have two or more girders. Girders may be constructed of the following typical materials: Rolled, welded, bolted (riveted), steel sections; Post tensioned, prestressed or reinforced concrete sections; or Timber sections.

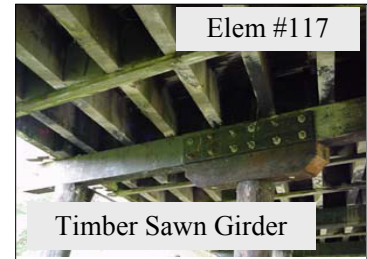
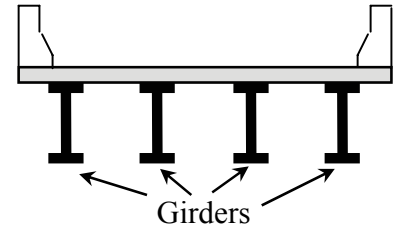

#### Diaphragms

Diaphragms are structural members used to tie adjoining girders together to improve the strength and rigidity of the girder and to distribute forces in the lateral direction. Diaphragms do not have an element but if a diaphragm has advanced deterioration, it should be noted in the element comments of the associated girder.

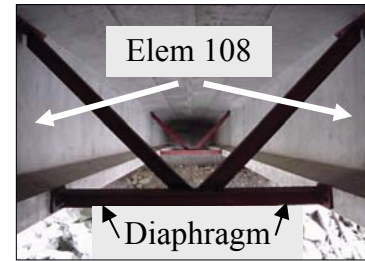

#### Pedestrian Bridges

The same WSDOT elements used for bridges that carry vehicular traffic can be used for pedestrian bridges. Do not use the WSDOT sidewalk elements (#260 through #266) for pedestrian bridges.

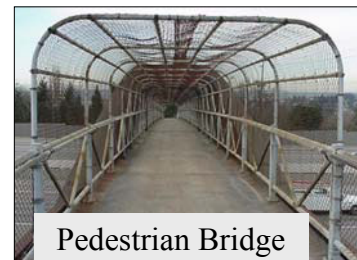

**Slab Bridges**

Slab bridges can have precast segments or cast in place concrete. The bridge in the picture is a cast in place concrete slab and will have a deck element for the deterioration of the top surface. Structural deficiencies of the slab bottom and edge are documented in WSDOT element 38 “Concrete Slab.”

*Note:* The total quantity for slab elements is the actual bridge deck area. Do not use the NBI Item 051, “**Bridge Roadway Width Curb-to-Curb**” (or WSBIS Item 1356 “**Curb-to-Curb Width**”) when a deck curb-to-curb dimensions vary.

---

**38 Concrete Slab** **Units – SF**

---

This element defines a concrete slab bridge and edge that has been constructed with uncoated reinforcement. Structural deficiencies of the edge and bottom surface are addressed in the condition states. The total quantity for this slab element is the actual bridge slab area from curb line to curb line.



---

**49 Concrete Hollow Slab** **Units – SF**

---

This element defines a concrete slab bridge and edge that has been constructed with sono-tubes and uncoated reinforcement. Structural deficiencies of the edge and bottom surface are addressed in the condition states. This type of bridge was typically built in the 50’s and 60’s on the state highway system. The total quantity for this slab element is the actual bridge slab area from curb line to curb line.

---

**50 Prestressed Concrete Slab** **Units – SF**

---

This element defines a concrete slab bridge that has been constructed with prestressed concrete and uncoated steel reinforcement. This element may be solid or have built in voids. Structural deficiencies of the edge and bottom surface are addressed in the condition states. The total quantity for this slab element is the actual bridge slab area from curb line to curb line.

---

**51 Prestressed Concrete Slab w/Coated Bars** **Units – SF**

---

This element defines a concrete slab bridge that has been constructed with prestressed concrete and coated steel reinforcement (epoxy, etc.). This element may be solid or have built in voids. Structural deficiencies of the edge and bottom surface are addressed in the condition states. The total quantity for this slab element is the actual bridge slab area from curb line to curb line.



---

|           |                                    |                   |
|-----------|------------------------------------|-------------------|
| <b>52</b> | <b>Concrete Slab w/Coated Bars</b> | <b>Units – SF</b> |
|-----------|------------------------------------|-------------------|

---

This element defines a concrete slab bridge and edge that has been constructed with coated (epoxy, etc.) reinforcement. This element may or may not contain a hollow core. Structural deficiencies of the edge and bottom surface are addressed in the condition states. The total quantity for this slab element is the actual bridge slab area from curb line to curb line.

**Condition States for WSDOT Elements 38, 49, 50, 51, and 52**

1. Defects are superficial and have no effect on the structural capacity of the element. There may be discoloration, efflorescence, and/or superficial cracking, spalls, or delaminations.
2. Concrete slab area with repairs or patches.
3. Concrete slab area with structural defects. The defects do not significantly affect structural capacity. Deficiencies do not warrant analysis, but may require repairs.
4. Concrete slab area with damage in locations or quantity and has reduced the structural capacity of the element or the bridge. Structural analysis is warranted or has determined repairs are essential to restore the full capacity of the element. For slabs made with beam units, the affected area should be based on the span length.



---

|           |                    |                   |
|-----------|--------------------|-------------------|
| <b>54</b> | <b>Timber Slab</b> | <b>Units – SF</b> |
|-----------|--------------------|-------------------|

---

This element defines a slab that is constructed of timber. Structural deficiencies of the edge and bottom surface are addressed in the condition states. The total quantity for this slab element is the actual bridge slab area from curb line to curb line.

1. Defects are superficial and have no effect on the structural capacity of the element. Decay, insect infestation, cracks, splits, or checks may exist.
2. Slab area with repairs, plates or replaced timbers.
3. Slab area with structural defects. The defects do not significantly affect structural capacity. Deficiencies do not warrant analysis, but may require repairs. These areas are typically marked with a YELLOW TAG by inspectors.
4. Slab area with damage in locations or quantity and has reduced the structural capacity of the element or the bridge. Structural analysis is warranted or has determined repairs are essential to restore the full capacity of the element. These areas are typically marked with a RED TAG by inspectors.

---

|           |                                                     |                   |
|-----------|-----------------------------------------------------|-------------------|
| <b>89</b> | <b>Prestressed Concrete Girder w/Coated Strands</b> | <b>Units – LF</b> |
|-----------|-----------------------------------------------------|-------------------|

---

This element defines a girder constructed of precast prestressed concrete and epoxy coated strand that supports the bridge deck. The element quantity should equal the sum of each girder length. The element total quantity for this element is the sum of each girder length.

1. Defects are superficial and have no effect on the structural capacity of the element. There may be discoloration, efflorescence, and/or superficial cracking, spalls, or delaminations.
2. Girder length affected by repair or patch. Capacity repairs such as a strand splicing should record girder span length.
3. Girder length affected by defects. The defects do not significantly affect structural capacity. Deficiencies do not warrant analysis, but may require repairs. Structural deficiencies are not limited to delaminations, spalls, structural cracking, exposed or corroded reinforcing or strands.
4. Girder span length with damage in locations or quantity and has reduced the structural capacity of the element or the bridge. Structural analysis is warranted or has determined repairs are essential to restore the full capacity of the element.



---

|           |                            |                   |
|-----------|----------------------------|-------------------|
| <b>90</b> | <b>Steel Rolled Girder</b> | <b>Units – LF</b> |
|-----------|----------------------------|-------------------|

---

This element defines a girder unit of structural steel that has an integral web and flanges and was fabricated in a steel mill by the rolling process. This element may have bolted, riveted or welded cover plates. This element directly supports the bridge deck and is part of a two or more longitudinal girder system. The total quantity for this element is the sum of each girder length.

---

|           |                             |                   |
|-----------|-----------------------------|-------------------|
| <b>91</b> | <b>Steel Riveted Girder</b> | <b>Units – LF</b> |
|-----------|-----------------------------|-------------------|

---

This element defines a girder unit of structural steel that directly supports the bridge deck. This element has a web and flanges that are connected with rivets. This element is part of a two or more longitudinal girder system. The total quantity for this element is the sum of each girder length.

---

|           |                            |                   |
|-----------|----------------------------|-------------------|
| <b>92</b> | <b>Steel Welded Girder</b> | <b>Units – LF</b> |
|-----------|----------------------------|-------------------|

---

This element defines a girder unit of structural steel that directly supports the bridge deck. This element has a web and flanges that are connected with welds. This element is part of a two or more longitudinal girder system. The total quantity for this element is the sum of each girder length.

**Condition States for WSDOT Elements 90, 91, and 92**

1. Defects are superficial and have no effect on the structural capacity of the element.
2. Girder length affected by repairs such as: bolts or rivets have been replaced; cracks that have been drilled or plated.
3. Girder length affected by structural defects. The defects do not significantly affect structural capacity. Deficiencies do not warrant analysis, but may require repairs. Structural deficiencies are not limited to impact damage, cracks, broken bolts, or measurable section loss due to corrosion (note the location and depth).
4. Girder span length with damage in locations or quantity and has reduced the structural capacity of the element or the bridge. Structural analysis is warranted or has determined repairs are essential to restore the full capacity of the element. Structural deficiencies are not limited to impact damage, corrosion, a crack in primary load path member or in the attachment welded to primary member. Retain the quantity of the element reported in CS4 if the element is repainted but not repaired.

---

|           |                                      |                   |
|-----------|--------------------------------------|-------------------|
| <b>96</b> | <b>Concrete Encased Steel Girder</b> | <b>Units – LF</b> |
|-----------|--------------------------------------|-------------------|

---

This element defines a steel girder that is encased in concrete. The total quantity for this element is the sum of each girder length.

1. Defects are superficial and have no effect on the structural capacity of the element. There may be discoloration, efflorescence, and/or superficial cracking.
2. Girder length affected by repairs or patches.
3. Girder length affected by structural defects. The defects do not significantly affect structural capacity. Deficiencies do not warrant analysis, but may require repairs. Structural deficiencies are not limited to impact damage, cracks, broken bolts, or measurable section loss due to corrosion (note the location and depth), concrete delaminations or spalls in a tension zone.
4. Girder span length with damage in locations or quantity and has reduced the structural capacity of the element or the bridge. Structural analysis is warranted or has determined repairs are essential to restore the full capacity of the element.

**97 Prestressed Concrete Tub Girder****Units – LF**

This element defines a prestressed concrete box girder or Tub Girder as defined in the *Bridge Design Manual M 23-50*. Post-tensioning and span field splices may or may not be present. The total quantity for this element is the sum of each girder length.

1. Defects are superficial and have no effect on the structural capacity of the element. There may be discoloration, efflorescence, and/or superficial cracking, spalls, or delaminations.
2. Girder length affected by repair or patch. Capacity repairs such as a strand splicing should record girder span length.
3. Girder length affected by defects. The defects do not significantly affect structural capacity. Deficiencies do not warrant analysis, but may require repairs. Structural deficiencies are not limited to delaminations, spalls, structural cracking, exposed or corroded reinforcing or strands.
4. Girder span length with damage in locations or quantity and has reduced the structural capacity of the element or the bridge. Structural analysis is warranted or has determined repairs are essential to restore the full capacity of the element.

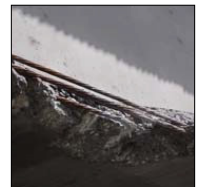
**98 Thin Flange Girder****Units – LF**

This element defines a precast prestressed concrete girder unit where the top flange is not designed to carry live load and must have a concrete deck. There may be asphalt or a concrete overlay on the concrete slab. This element represents the WSDOT - WFxxTDG girder sections: WF36TDG, WF42TDG, WF50TDG, WF58TDG, WF66TDG, WF74TDG, WF83TDG, WF95TDG, and WF100TDG. Structural deficiencies of the edge and bottom surface are addressed in the condition states. The total quantity for this element is the sum of each girder length.

---

|                                                         |                   |
|---------------------------------------------------------|-------------------|
| <b>100 Post Tensioned Concrete Segmental Box Girder</b> | <b>Units – LF</b> |
|---------------------------------------------------------|-------------------|

---

This element defines a post-tensioned concrete box girder constructed using the segmental precast process. The total quantity for this element is the length of segmental box girders.

**Condition States for WSDOT Elements 97, 98, and 100**

1. Defects are superficial and have no effect on the structural capacity of the element. There may be discoloration, efflorescence, and/or superficial cracking, spalls, or delaminations.
2. Girder length affected by repair or patch. Capacity repairs such as a strand splicing should record girder span length.
3. Girder length affected by defects. The defects do not significantly affect structural capacity. Deficiencies do not warrant analysis, but may require repairs. Structural deficiencies are not limited to delaminations, spalls, structural cracking, exposed or corroded reinforcing or strands.
4. Girder span length with damage in locations or quantity and has reduced the structural capacity of the element or the bridge. Structural analysis is warranted or has determined repairs are essential to restore the full capacity of the element.



---

|                             |                   |
|-----------------------------|-------------------|
| <b>102 Steel Box Girder</b> | <b>Units – LF</b> |
|-----------------------------|-------------------|

---

This element defines a box girder unit constructed with structural steel. This element directly supports the bridge deck. The total quantity for this element is the sum of each girder length.

1. Defects are superficial and have no effect on the structural capacity of the element.
2. Girder length affected by repairs such as: bolts or rivets have been replaced; cracks that have been drilled or plated.
3. Girder length affected by structural defects. The defects do not significantly affect structural capacity. Deficiencies do not warrant analysis, but may require repairs. Structural deficiencies are not limited to impact damage, cracks, broken bolts, or measurable section loss due to corrosion (note the location and depth).
4. Girder span length with damage in locations or quantity and has reduced the structural capacity of the element or the bridge. Structural analysis is warranted or has determined repairs are essential to restore the full capacity of the element. Structural deficiencies are not limited to impact damage, corrosion, a crack in primary load path member or in the attachment welded to primary member. Retain the quantity of the element reported in CS4 if the element is repainted but not repaired.

---

|            |                                          |                   |
|------------|------------------------------------------|-------------------|
| <b>103</b> | <b>Prestressed Concrete Super Girder</b> | <b>Units – LF</b> |
|------------|------------------------------------------|-------------------|

---

This element defines a prestressed WSDOT girder WF83G, WF95G, WF100G, WF83PTG, WF95PTG, WF100PTG. Girders may or may not be post-tensioned. The total quantity for this element is the sum of each girder length.

---

|            |                                         |                   |
|------------|-----------------------------------------|-------------------|
| <b>104</b> | <b>Post Tension Concrete Box Girder</b> | <b>Units – LF</b> |
|------------|-----------------------------------------|-------------------|

---

This element defines a box girder unit constructed of post-tensioned, cast in place concrete. The total quantity for this element is the sum of each girder length.

---

|            |                            |                   |
|------------|----------------------------|-------------------|
| <b>105</b> | <b>Concrete Box Girder</b> | <b>Units – LF</b> |
|------------|----------------------------|-------------------|

---

This element defines a box girder superstructure unit constructed with cast in place reinforced concrete. The total quantity for this element is the sum of each girder length.

### Condition States for WSDOT Elements 103, 104, and 105

1. Defects are superficial and have no effect on the structural capacity of the element. There may be discoloration, efflorescence, and/or superficial cracking, spalls, or delaminations.
2. Girder length affected by repair or patch. Capacity repairs such as a strand splicing should record girder span length.
3. Girder length affected by defects. The defects do not significantly affect structural capacity. Deficiencies do not warrant analysis, but may require repairs. Structural deficiencies are not limited to delaminations, spalls, structural cracking, exposed or corroded reinforcing or strands.
4. Girder span length affected by damage in locations or quantity and has reduced the structural capacity of the element or the bridge. Structural analysis is warranted or has determined repairs are essential to restore the full capacity of the element.

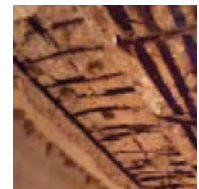

**107 Steel Open Girder****Units – LF**

This element defines an open girder unit that is constructed of structural steel. An open or “through” girder is part of a two girder system with stringer and floor beam elements that support a bridge deck. Open girders are located on the outside of the bridge. The bridge deck and any sidewalks are contained between the open girders. Bridges with open girders were generally built prior to 1950 and usually have built up riveted steel members. The total quantity for this element is the sum of each girder length.

1. Defects are superficial and have no effect on the structural capacity of the element.
2. Steel open girder length affected by repairs such as: bolts or rivets have been replaced; cracks that have been drilled or plated.
3. Steel open girder length affected by structural defects. The defects do not significantly affect structural capacity. Deficiencies do not warrant analysis, but may require repairs. Structural deficiencies are not limited to impact damage, cracks, broken bolts, or measurable section loss due to corrosion (note the location and depth).
4. Steel open girder span length with damage in locations or quantity and has reduced the structural capacity of the element or the bridge. Structural analysis is warranted or has determined repairs are essential to restore the full capacity of the element. Structural deficiencies are not limited to impact damage, corrosion, a crack in primary load path member or in the attachment welded to primary member. Retain the quantity of the element reported in CS4 if the element is repainted but not repaired.

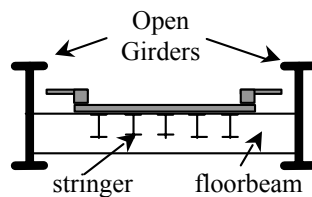
**108 Prestressed Concrete Bulb-T Girder****Units – LF**

This element defines a precast prestressed concrete Bulb-Tee girder unit **which has little or no span between the top flange. There may be asphalt, a concrete slab, a concrete overlay, or nothing on the top flange. This element represents the following WSDOT girder sections: W35DG, W41DG, W53DG, W65DG, WF39DG, WF45DG, WF53DG, WF61DG, WF69DG, WF77DG, WF86DG, WF98DG, WF103DG.**

Structural deficiencies of the edge and bottom surface are addressed in the condition states. The total quantity for this element is the sum of each girder length.

---

|            |                                                       |                   |
|------------|-------------------------------------------------------|-------------------|
| <b>109</b> | <b>Prestressed Concrete Multiple Web Girder Units</b> | <b>Units – LF</b> |
|------------|-------------------------------------------------------|-------------------|

---

This element defines a precast prestressed concrete girder that has more than one web. Structural deficiencies of the edge and bottom surface are addressed in the condition states. The total quantity for this element is the sum of each girder length.

---

|            |                        |                   |
|------------|------------------------|-------------------|
| <b>110</b> | <b>Concrete Girder</b> | <b>Units – LF</b> |
|------------|------------------------|-------------------|

---

This element defines a girder (including T-Beams) constructed of non-prestressed reinforced concrete. The total quantity for this element is the sum of each girder length.

**Condition States for WSDOT Elements 108, 109, and 110**

1. Defects are superficial and have no effect on the structural capacity of the element. There may be discoloration, efflorescence, and/or superficial cracking, spalls, or delaminations.
2. Girder length affected by repair or patch. Capacity repairs such as a strand splicing should record girder span length.
3. Girder length affected by defects. The defects do not significantly affect structural capacity. Deficiencies do not warrant analysis, but may require repairs. Structural deficiencies are not limited to delaminations, spalls, structural cracking, exposed or corroded reinforcing or strands.
4. Girder span length with damage in locations or quantity and has reduced the structural capacity of the element or the bridge. Structural analysis is warranted or has determined repairs are essential to restore the full capacity of the element.

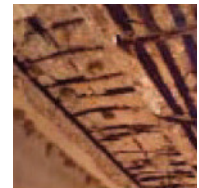

---

|            |                               |                   |
|------------|-------------------------------|-------------------|
| <b>111</b> | <b>Timber Glue-Lam Girder</b> | <b>Units – LF</b> |
|------------|-------------------------------|-------------------|

---

This element defines a girder unit constructed of glue-lam timber. This element directly supports the bridge deck. The total quantity for this element is the sum of each girder length.

1. Defects are superficial and have no effect on the structural capacity of the element. Decay, insect infestation, cracks, splits, or checks may exist.
2. Glue-Lam girder length affected by repairs, patches, or plated.
3. Glue-Lam girder length affected by structural defects. The defects do not significantly affect structural capacity. Deficiencies do not warrant analysis, but may require repairs. These areas are typically marked with a YELLOW TAG by inspectors.
4. Glue-Lam girder span length with damage in locations or quantity and has reduced the structural capacity of the girder or the bridge. Structural analysis is warranted or has determined repairs are essential to restore the full capacity of the element. These areas are typically marked with a RED TAG by inspectors.



**113 Steel Stringer****Units – LF**

This element defines a stringer constructed of structural steel that supports the deck in a stringer-floor beam system. A stringer is connected to a floor beam and directly supports a bridge deck. A steel stringer and floor beam combination is commonly used in steel truss and steel open girder bridges. The total quantity for this element is the sum of each girder length.



1. Defects are superficial and have no effect on the structural capacity of the element.
2. Stringer length affected by repairs such as: bolts or rivets have been replaced; cracks that have been drilled or plated.
3. Stringer length affected by structural defects. The defects do not significantly affect structural capacity. Deficiencies do not warrant analysis, but may require repairs. Structural deficiencies are not limited to impact damage, cracks, broken bolts, or measurable section loss due to corrosion (note the location and depth).
4. Stringer span length with damage in locations or quantity and has reduced the structural capacity of the element or the bridge. Structural analysis is warranted or has determined repairs are essential to restore the full capacity of the element. Structural deficiencies are not limited to impact damage, corrosion, a crack in primary load path member or in the attachment welded to primary member. Retain the quantity of the element reported in CS4 if the element is repainted but not repaired.

**114 Concrete Multiple Web Girder Unit****Units – LF**

This element defines a girder constructed of non-prestressed reinforced precast concrete. Structural deficiencies of the edge and bottom surface are addressed in the condition states. The total quantity for this element is the sum of each girder length. Check the NBIS main span type.

**115 Prestressed Concrete Girder****Units – LF**

This element defines a girder constructed of precast prestressed concrete that supports the bridge deck. The total quantity for this element is the sum of each girder length.

**116 Concrete Stringer****Units – LF**

This element defines a stringer constructed of reinforced concrete that supports the bridge deck in a stringer-floor beam system. The total quantity for this element is the sum of each stringer length. See Steel Stringers and Floor Beams for a more general description.

**Condition States for WSDOT Elements 114, 115, and 116**

1. Defects are superficial and have no effect on the structural capacity of the element. There may be discoloration, efflorescence, and/or superficial cracking, spalls, or delaminations.
2. Girder length affected by repair or patch.
3. Girder length affected by defects. The defects do not significantly affect structural capacity. Deficiencies do not warrant analysis, but may require repairs. Structural deficiencies are not limited to delaminations, spalls, structural cracking, exposed or corroded reinforcing or strands.
4. Girder span length with damage in locations or quantity and has reduced the structural capacity of the element or the bridge. Structural analysis is warranted or has determined repairs are essential to restore the full capacity of the element.

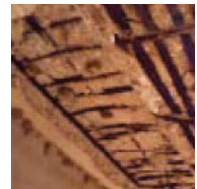
**117 Timber Sawn Girder****Units – LF**

This element defines a girder constructed of sawn timber that supports the bridge deck. The total quantity for this element is the sum of each girder length.

**118 Timber Stringer****Units – LF**

This element defines a stringer constructed of timber that supports the bridge deck. The element total quantity is the sum of each stringer length. See Steel Stringers, WSDOT Element 113, for a more general description.

**Condition States for WSDOT Elements 117 and 118**

1. Defects are superficial and have no effect on the structural capacity of the element. Decay, insect infestation, cracks, splits, or checks may exist.
2. Girder or stringer length affected by repairs or plates.
3. Girder or stringer length affected by structural defects. The defects do not significantly affect structural capacity. Deficiencies do not warrant analysis, but may require repairs. Typically, locations in a load path with a **shell thickness greater than or equal to 1½"** are marked with a YELLOW TAG.
4. Girder or stringer span length with damage in locations or quantity and has reduced the structural capacity of the element or the bridge. Structural analysis is warranted or has determined repairs are essential to restore the full capacity of the element. Typically, locations in a load path with less than a 1½" shell thickness are marked with a RED TAG.

**119 Concrete Truss****Units – LF**

This element defines all members in a truss that is constructed of concrete. There is only one concrete truss on the state highway system. The total quantity for this element is the sum of each concrete truss length, which is two times the truss span length.

1. Truss panel length with superficial defects that have no effect on the structural capacity of the element. There may be discoloration, efflorescence, and/or superficial cracking, spalls, or delaminations.
2. Truss panel length with repairs or patches.
3. Truss panel length affected with structural defects. The defects do not significantly affect structural capacity. Defects do not warrant analysis, but may require repairs. Structural deficiencies are not limited to delaminations, spalls, structural cracking, exposed or corroded reinforcing or strands.
4. Length of truss span affected with damage in locations or quantity and has reduced the structural capacity of the element or the bridge. Structural analysis is warranted or has determined repairs are essential to restore the full capacity of the element.

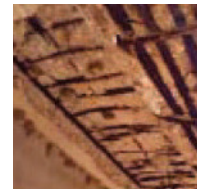
**126 Steel Thru Truss****Units – LF**

This element includes all structural steel truss members. Code this element for through and pony trusses only. The total quantity for this element is the sum of each truss length, which is two times the truss span length.

**131 Steel Deck Truss****Units – LF**

This element includes all truss members of a structural steel deck truss. The top and bottom chords are included in this element. The total quantity for this element is the sum of each truss length, which is two times the truss span length.

**Condition States for WSDOT Elements 126 and 131**

1. Defects are superficial and have no effect on the structural capacity of the element.
2. Truss panel length with repairs such as: bolts or rivets have been replaced; cracks that have been drilled or plated.
3. Truss panel length with structural defects. The defects do not significantly affect structural capacity. Deficiencies do not warrant analysis, but may require repairs. Structural deficiencies are not limited to impact damage, cracks, broken bolts, or measurable section loss due to corrosion (note the location and depth).
4. Truss span length affected by damage in locations or quantity and has reduced the structural capacity of the element or the bridge. Structural analysis is warranted or has determined repairs are essential to restore the full capacity of the element. Structural deficiencies are not limited to impact damage, corrosion, a crack in primary load path member or in the attachment welded to primary member. Retain the quantity of the element reported in CS4 if the element is repainted but not repaired.

**133 Truss Gusset Plates****Units – EA**

This element documents structural defects on gusset plates at the panel points of a truss element. Gusset plates are defined as any plate attached to primary members that transfer primary or secondary load at the panel joint. Significant defects should be considered when they are within the stress zones of the gusset. Stress zones are approximately illustrated as the shaded portion in Figure at right. The total quantity for a truss is the total number of all node points of all trusses

1. Defects are superficial and have no effect on the structural capacity of the element.
2. Number of panel points with repairs or have been reinforced.
3. Number of panel points with structural defects. The defects do not significantly affect structural capacity. Deficiencies do not warrant analysis, but may require repairs. Structural deficiencies are not limited to impact damage, cracks, broken bolts, or measurable section loss due to corrosion (note the location and depth).
4. Number of panel points with structural deficiencies in locations or quantity and has reduced the structural capacity of the element or the bridge. Structural analysis is warranted or has determined repairs are essential to restore the full capacity of the element. Retain the quantity of the element reported in CS4 if the element is repainted but not repaired.

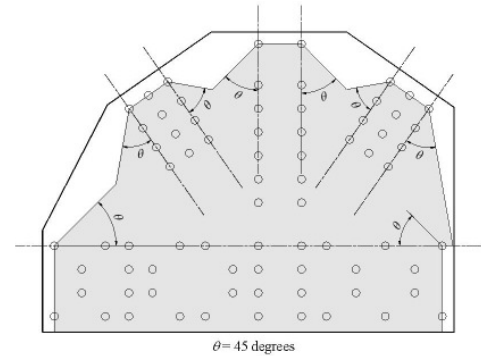
**135 Timber Truss****Units – LF**

This element defines a truss constructed of timber members. The total quantity for this element is the sum of each truss length, which is two times the truss span length.

1. Truss panel length with defects that are superficial and have no effect on the structural capacity of the element. Decay, insect infestation, cracks, splits, or checks may exist.
2. Truss panel length with repairs or plates.
3. Truss panel length with structural defects. The defects do not significantly affect structural capacity. Deficiencies do not warrant analysis, but may require repairs. Typically, locations in a load path with a **shell thickness greater than or equal to 1½"** are marked with a YELLOW TAG.
4. Truss span length affected by damage in locations or quantity and has reduced the structural capacity of the element or the bridge. Structural analysis is warranted or has determined repairs are essential to restore the full capacity of the element. Typically, locations in a load path with less than a 1½" shell thickness are marked with a RED TAG.

---

|            |                    |                   |
|------------|--------------------|-------------------|
| <b>139</b> | <b>Timber Arch</b> | <b>Units – LF</b> |
|------------|--------------------|-------------------|

---

This element includes all members of an arch constructed of Timber. The total quantity for this element is the length measured from one arch support to the other.

1. Arch panel length with defects that are superficial and have no effect on the structural capacity of the element. Decay, insect infestation, cracks, splits, or checks may exist.
2. Arch panel length with repairs or plates.
3. Arch panel length with structural defects. The defects do not significantly affect structural capacity. Deficiencies do not warrant analysis, but may require repairs. Typically, locations in a load path with a **shell thickness greater than or equal to 1½"** are marked with a YELLOW TAG.
4. Arch span length affected by damage in locations or quantity and has reduced the structural capacity of the element or the bridge. Structural analysis is warranted or has determined repairs are essential to restore the full capacity of the element. Typically, locations in a load path with less than a 1½" shell thickness are marked with a RED TAG.

---

|            |                   |                   |
|------------|-------------------|-------------------|
| <b>141</b> | <b>Steel Arch</b> | <b>Units – LF</b> |
|------------|-------------------|-------------------|

---

This element includes only the arch constructed of structural steel. When coding NBI, pier caps, cross beams, and any other coded substructure elements within the arch span are considered superstructure elements. The total quantity for this element is the length measured from one arch support to the other.

---

|            |                        |                   |
|------------|------------------------|-------------------|
| <b>142</b> | <b>Steel Tied Arch</b> | <b>Units – LF</b> |
|------------|------------------------|-------------------|

---

This element includes all members of a tied arch constructed of structural steel. The bottom and top chords are included in this element. The total quantity for this element is the length measured from one arch support to the other.

**Condition States for WSDOT Elements 141 and 142**

1. Arch panel length with defects that are superficial and have no effect on the structural capacity of the element.
2. Arch panel length with repairs such as: bolts or rivets have been replaced; cracks that have been drilled or plated.
3. Arch panel length with structural defects. The defects do not significantly affect structural capacity. Deficiencies do not warrant analysis, but may require repairs. Structural deficiencies are not limited to impact damage, cracks, broken bolts, or measurable section loss due to corrosion (note the location and depth).
4. Arch span length affected by damage in locations or quantity and has reduced the structural capacity of the element or the bridge. Structural analysis is warranted or has determined repairs are essential to restore the full capacity of the element. Structural deficiencies are not limited to impact damage, corrosion, a crack in primary load path member or in the attachment welded to primary member. Retain the quantity of the element reported in CS4 if the element is repainted but not repaired.

**143 Steel Suspender****Units – EA**

This element defines a steel suspender member used hang a bridge deck from an arch or truss. The total quantity for this element is the total number of suspenders.

1. Number of suspenders with defects that are superficial and have no effect on the structural capacity of the element.
2. Number of suspenders with repairs such as: bolts or rivets have been replaced; cracks that have been drilled or plated.
3. Number of suspenders with structural defects. The defects do not significantly affect structural capacity. Deficiencies do not warrant analysis, but may require repairs. Structural deficiencies are not limited to impact damage, cracks, broken bolts, or measurable section loss due to corrosion (note the location and depth).
4. Number of suspenders with damage in locations or quantity and has reduced the structural capacity of the element or the bridge. Structural analysis is warranted or has determined repairs are essential to restore the full capacity of the element. Structural deficiencies are not limited to impact damage, corrosion, a crack in primary load path member or in the attachment welded to primary member. Retain the quantity of the element reported in CS4 if the element is repainted but not repaired.

**144 Concrete Arch****Units – LF**

This element only defines the arch (open/closed spandrel, bowstring, etc.) and is constructed of non-prestressed reinforced concrete. When coding NBI, pier caps, cross beams, and any other coded substructure elements within the arch span are considered superstructure elements. The total quantity for this element is the length measured from one arch foundation to the other.

1. Arch panel length with defects that are superficial and have no effect on the structural capacity of the element. There may be discoloration, efflorescence, and/or superficial cracking, spalls, or delaminations.
2. Arch panel length with repairs or patches.
3. Arch panel length with structural defects. The defects do not significantly affect structural capacity. Deficiencies do not warrant analysis, but may require repairs. Structural deficiencies are not limited to delaminations, spalls, structural cracking, exposed or corroded reinforcing or strands.
4. Arch span length affected by damage in locations or quantity and has reduced the structural capacity of the element or the bridge. Structural analysis is warranted or has determined repairs are essential to restore the full capacity of the element.

**145 Earth Filled Concrete Arch****Units – LF**

This element defines an earth filled (Luten) arch constructed of reinforced concrete. The total quantity for this element is the length measured from one arch foundation to the other. If there is a concrete deck constructed on the fill, WSDOT element 14 applies. If there is an ACP wearing surface, WSDOT element 800 or 801 applies.

1. Arch span length with defects that are superficial and have no effect on the structural capacity of the element. There may be discoloration, efflorescence, and/or superficial cracking, spalls, or delaminations.
2. Arch span length with repairs or patches.
3. Arch span length with structural defects. The defects do not significantly affect structural capacity. Deficiencies do not warrant analysis, but may require repairs. Structural deficiencies are not limited to delaminations, spalls, structural cracking, exposed or corroded reinforcing or strands.
4. Arch span length affected by damage in locations or quantity and has reduced the structural capacity of the element or the bridge. Structural analysis is warranted or has determined repairs are essential to restore the full capacity of the element.

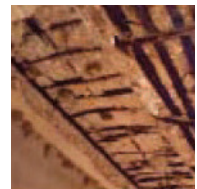
**146 Suspension – Main Cable****Units – EA**

This element defines a main steel cable used to support the superstructure in a suspension bridge. The total quantity for this element is the number of cables.

**147 Suspension – Suspender Cable****Units – EA**

This element defines a suspender steel cable that connects the bridge superstructure to the main suspension cable. Suspender cables include the anchor device at the ends and the zinc protection on the wires. The outer protection system is usually a form of a paint element. The total quantity for this element is the number of steel cables.

**149 Cable Stayed Bridge – Cable**

**Units – EA**

This element defines a steel cable used to support the superstructure in a cable stayed bridge. The cable stays include the anchor device at the ends. The total quantity for this element is the number of steel cables.

**Condition States for WSDOT Elements 146, 147, and 149**

- 1. Number of cables with no defects. Zinc coating may be dull gray showing early signs stages of zinc oxidation. New replacement cables are coded in this condition state.



- 2. Number of cables with defects that are insignificant and do not affect the capacity of the cable. Zinc coating has white spots or areas of the surface which indicate corrosion of the zinc protection.



- 3. Number of cables or anchors with defects that are beginning to affect the capacity of the cable, but are within acceptable design limits. Localized areas of zinc depletion and showing rust spots, but there is no visible section loss.

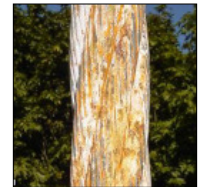

- 4. Number of cables or anchors with defects that have clearly affected the capacity. This includes broken wires or localized section loss due to other defects. The zinc protective coating is largely depleted with ferrous rust prevalent in many locations along the cable length.



**150 Concrete Column on Spandrel Arch**

**Units – EA**

This element defines the column supports on a spandrel arch bridge. The total quantity for this element is the number of columns supported by the arch.

- 1. Defects are superficial and have no effect on the structural capacity of the element. There may be discoloration, efflorescence, and/or superficial cracking, spalls, or delaminations.

- 2. Number of columns with repairs or patches.

- 3. Number of columns with structural defects. The defects do not significantly affect structural capacity. Deficiencies do not warrant analysis, but may require repairs. Structural deficiencies are not limited to delaminations, spalls, structural cracking, exposed or corroded reinforcing or strands.



- 4. Number of columns with damage in locations or quantity and has reduced the structural capacity of the element or the bridge. Structural analysis is warranted or has determined repairs are essential to restore the full capacity of the element.

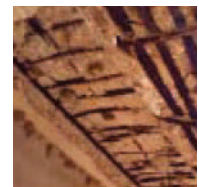



**152 Steel Floor Beam****Units – LF**

This element defines a floor beam constructed of structural steel that supports stringers in a stringer-floor beam system. Floor beams are load carrying elements located transversely to the general bridge alignment. Floor beams transmit the loads from the deck and/or stringers to the outside open girders or to the bottom chord of a truss bridge. The total quantity for this element is the sum of each floorbeam length.



1. Defects are superficial and have no effect on the structural capacity of the element.
2. Floorbeam length affected by repairs such as: bolts or rivets have been replaced; cracks that have been drilled or plated.
3. Floorbeam length affected by structural defects. The defects do not significantly affect structural capacity. Deficiencies do not warrant analysis, but may require repairs. Structural deficiencies are not limited to impact damage, cracks, broken bolts, or measurable section loss due to corrosion (note the location and depth).
4. Floorbeam span length with damage in locations or quantity and has reduced the structural capacity of the element or the bridge. Structural analysis is warranted or has determined repairs are essential to restore the full capacity of the element. Structural deficiencies are not limited to impact damage, corrosion, a crack in primary load path member or in the attachment welded to primary member. Retain the quantity of the element reported in CS4 if the element is repainted but not repaired.

**154 Prestressed Concrete Floor Beam****Units – LF**

This element defines a floor beam constructed of prestressed concrete that supports the bridge deck in a stringer-floor beam system. The total quantity for this element is the sum of each floorbeam length.

**155 Concrete Floor Beam****Units – LF**

This element defines a floor beam constructed of reinforced concrete that supports the bridge deck in a stringer-floor beam system. Floor beams are load carry elements located transversely to the general bridge alignment. Floor beams transmit the loads from the deck and/or stringers to the outside open girders. The total quantity for this element is the sum of each floorbeam length.

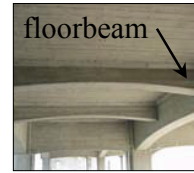
**Condition States for WSDOT Elements 154 and 155**

1. Defects are superficial and have no effect on the structural capacity of the element. There may be discoloration, efflorescence, and/or superficial cracking, spalls, or delaminations.
2. Floorbeam length affected by repairs or patches.
3. Floorbeam length affected by structural defects. The defects do not significantly affect structural capacity. Deficiencies do not warrant analysis, but may require repairs. Structural deficiencies are not limited to delaminations, spalls, structural cracking, exposed or corroded reinforcing or strands.
4. Floorbeam span length with damage in locations or quantity and has reduced the structural capacity of the element or the bridge. Structural analysis is warranted or has determined repairs are essential to restore the full capacity of the element.

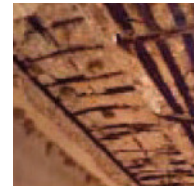
**156 Timber Floor Beam****Units – LF**

This element defines a stringer constructed of timber that supports the bridge deck. The total quantity for this element is the sum of each floorbeam length. See Steel Floorbeam, WSDOT Element 152, for a more general description.

1. Defects are superficial and have no effect on the structural capacity of the element. Decay, insect infestation, cracks, splits, or checks may exist.
2. Floorbeam length affected by repairs or plates.
3. Floorbeam length affected by structural defects. The defects do not significantly affect structural capacity. Deficiencies do not warrant analysis, but may require repairs. Typically, locations in a load path with a **shell thickness greater than or equal to 1 1/2"** are marked with a YELLOW TAG.
4. Floorbeam span length with damage in locations or quantity and has reduced the structural capacity of the element or the bridge. Structural analysis is warranted or has determined repairs are essential to restore the full capacity of the element. Typically, locations in a load path with less than a 1 1/2 shell thickness are marked with a RED TAG.

---

|            |                                      |                   |
|------------|--------------------------------------|-------------------|
| <b>160</b> | <b>Steel Column on Spandrel Arch</b> | <b>Units – EA</b> |
|------------|--------------------------------------|-------------------|

---

This element defines the column supports on a spandrel arch bridge. The total quantity for this element is the number of columns supported by the arch.

---

|            |                     |                   |
|------------|---------------------|-------------------|
| <b>161</b> | <b>Steel Hanger</b> | <b>Units – EA</b> |
|------------|---------------------|-------------------|

---

This element defines the hanger portion of a pin and hanger usually on a steel girder. Truss “hanger” members are not included in this element. The total quantity for this element is the number of steel hangers on the bridge. Generally there will be two hangers at each location.

#### **Condition States for WSDOT Elements 160 and 161**

1. Defects are superficial and have no effect on the structural capacity of the element.
2. Number of steel columns or hangers with repairs such as: bolts or rivets have been replaced; cracks that have been drilled or plated.
3. Number of steel columns or hangers with structural defects. The defects do not significantly affect structural capacity. Deficiencies do not warrant analysis, but may require repairs. Structural deficiencies are not limited to impact damage, cracks, broken bolts, or measurable section loss due to corrosion (note the location and depth).
4. Number of steel columns or hangers with damage in locations or quantity and has reduced the structural capacity of the element or the bridge. Structural analysis is warranted or has determined repairs are essential to restore the full capacity of the element. Structural deficiencies are not limited to impact damage, corrosion, a crack in primary load path member or in the attachment welded to primary member. Retain the quantity of the element reported in CS4 if the element is repainted but not repaired.

---

**162 Steel Pin****Units – EA**

---

This element defines a structural pin used in any connection joint in a girder or truss. The total quantity for this element is the number of pins on the bridge. Zero force and construction pins are not included in the quantity. Pins in bearing elements are not included unless they have uplift loadings.

1. Number of pins and associated connection plates are in good condition. Visual Inspection: There may be minor rust or shallow surface deformations on the exposed pin surfaces. Minor amounts of rust powder or paint damage may be present suggesting minor pin rotation in place. No pack rust is present between associated connection plates. There is no noise associated with the pin connection. Ultrasonic Testing (UT): Transducer can be applied to both ends of pin allowing a complete scan of pin grip surfaces, there are strong shoulder and end reflections, and there are no UT indications. UT indications are defined as pips in the grip area that are three times larger (3:1) than the background noise when the GAIN is adjusted to produce a 90 to 100 percent reflection height for the far shoulder.
2. Number of pins and associated connection plates have defects that do not affect the strength or serviceability of the bridge. Visual Inspection: Corrosion with pitting or laminar rust may be present. Minor abnormalities may be observed in alignment, pin wear, or deck joint movement. Pack rust may be present between connection plates, but is not judged to put a jacking force between the pin nuts. The connection may have some rust powder and/or make noise under loading. Ultrasonic Testing (UT): For pins UT inspected from both ends, there may be non-coincident indications between 10 and 20 percent of the far shoulder reflection height. There may be loss in shoulder or back reflections which can be explained by pin end conditions (dents, holes, corrosion). Pins that can be UT inspected from one end only are considered CS2, even if they have no indications or have indications less than 10 percent of the far shoulder reflection height.
3. Number of pins and associated connection plates have defects that may affect the strength or serviceability of the bridge. Visual Inspection: Significant corrosion may be present, suggesting that pin is “frozen” in place. Measurable abnormalities may be observed in alignment, pin wear, or deck joint movement. Pack rust may be present between connection plates that place a jacking force between the pin nuts. The connection may have significant amounts of rust powder and/or make noise under loading. Ultrasonic Testing (UT): For pins UT inspected from both ends, there may be coincident indications (of any size) or non-coincident indications greater than 20 percent of the far shoulder reflection height. There may be loss in shoulder or back reflections that cannot be explained by pin end conditions (dents, holes, corrosion). Pins that can be UT inspected from one end only are considered CS3 if there are indications greater than 10 percent of the far shoulder reflection height.
4. Number of pins and associated connection plates have defects that are judged to affect the strength or serviceability of the bridge. Visual Inspection: There may be “frozen” pins designed for free rotation as part of normal bridge movement. Pack rust may be present between connection plates that are causing distortion/displacement of plates or pins.

## 4.4 Substructure

The evaluation of the substructure elements are based on those portions of the member that are exposed for visual inspection and included in the element quantity. If an element is added to a bridge or quantities are changed due to exposure or discovery by other means, do not delete the historical information in subsequent inspections. Simply note the prior exposure or those members not visible and document the current condition.

### Abutments

An abutment is a substructure unit located at the end of a bridge that is designed to retain the fill supporting the roadway, and support the bridge superstructure. Bridges that terminate in mid-span or at a pier that is not at grade do not have an abutment substructure unit and do not have abutment elements. These cases will use other appropriate structural elements to evaluate condition.

All abutments shall be evaluated for the capacity to transfer design loads to a foundation thru structural elements. The roadway embankment with non-monolithic concrete wingwalls, timber planking, or other abutment retaining systems are included in the evaluation of the WSDOT Abutment Fill element 200 (EA) where the evaluation is limited to no more than 25 feet from the abutment. Timber Abutment element 216 (LF) and Cantilever Abutment element 219 (EA) are elements equivalent to element 200.

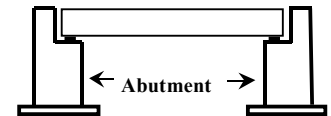
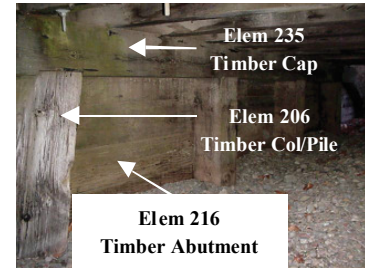

### Pier Cap/Cross Beam

A pier cap is an element that is attached to the top of a pier and is used to support the superstructure of a bridge. A pier cross beam is generally attached to the girders and is used to distribute the loads from the girders to the pier.

One WSDOT element is used to define either a cap or cross beam constructed of the same material.

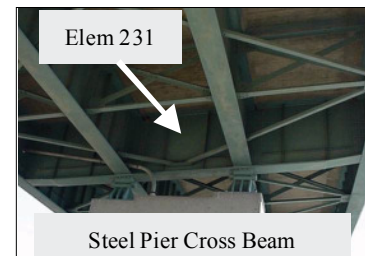
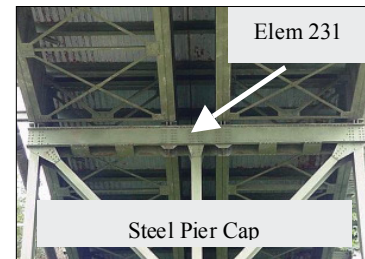

**Pier Wall Definition**

A pier wall is a substructure pier element. For WSDOT elements, a pier wall is defined using two criteria: if the length (transverse direction) is 3 times greater than the width (longitudinal direction) at the bottom; and the wall extends full height from the foundation to the superstructure. If the pier does not meet these two criteria, then the element would be coded as a column or other pier.

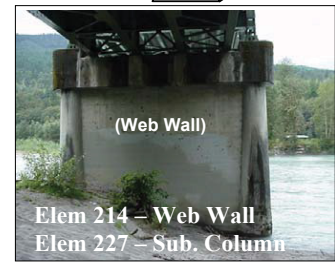
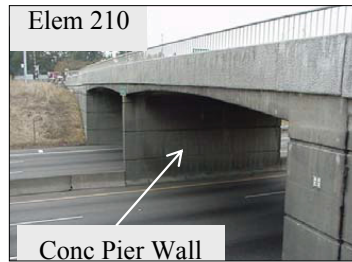
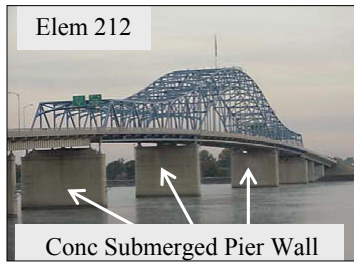
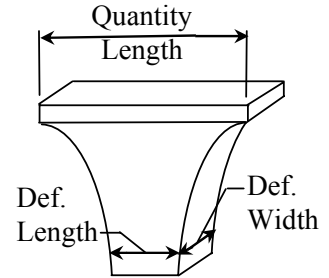

**Pile/Column Elements**

These long slender members transfer load normally as a part of the bridge substructure. The bottom of a column element may be visible or supported on unknown foundations. For element and inspection purposes, a pile is inspected as a designed column for the visible portion above ground or if visible in the past. Single columns supported on a single shaft are to be considered the same as one column or column length even though a part of the shaft is visible.

**Foundation Elements**

WSDOT Timber Foundation and Concrete Foundation elements document that a foundation is visible, and the structural condition may or may not be related to scour. The foundation may be a spread footing, or a footing supported by piles or drilled shafts. The foundation element is based on the footing material and the piles may be of any material. The condition of the foundation is the focus of these elements, not the pile design or material.

If the supporting piles are visible, then the pile element should be added to the bridge. Do not delete the pile element in subsequent inspections. The total quantity is the quantity of piles supporting the exposed foundation, not just the number of exposed piles. When scour threatens or reduces the condition, the scour documentation and condition is recorded separately in WSDOT element 361 and not recorded in the foundation element.

**Submerged Element Definition (Column, Pier Wall, Foundation)**

A Submerged element in BMS is defined as a substructure element located within the normal high water banks of a waterway channel. Repair or replacement of these elements may have special construction requirements as outlined in the environmental permits.

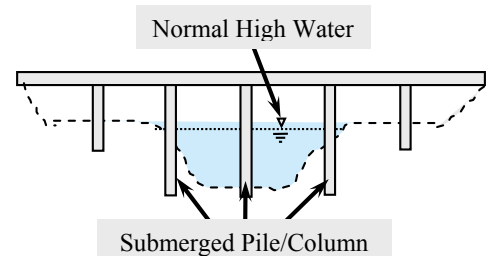

---

|            |                      |                   |
|------------|----------------------|-------------------|
| <b>200</b> | <b>Abutment Fill</b> | <b>Units – EA</b> |
|------------|----------------------|-------------------|

---

This element is defined as the soil retained behind a concrete or steel abutment and includes the materials retaining the embankment such as non-monolithic concrete wing walls or other retaining wall system. The evaluation of the fill or retaining systems should not extend beyond 25 feet or the approach slab, whichever is greater.

Normally **structures** have two abutments at grade. When bridges terminate at intermediate piers or in mid-span (not on the ground), then this element does not apply. In addition, WSDOT Element 200 is equivalent to and does not apply to **structures** with WSDOT Timber Abutment 216 (LF) or Cantilever Abutment Element 219 (EA).

Erosion outside of the abutment/wingwalls can be documented in the notes, but is not included in the evaluation or condition of the element or the condition of the element.

1. Defects are superficial and have no effect on the structural capacity or performance of the fill.
2. Number of abutments that have been repaired.
3. Number of abutments with a fill problem which does not significantly affect the support of the traveled lanes. Deficiencies do not warrant analysis, but may require repairs.
4. Number of abutments with a fill problem in locations or quantity and has reduced the structural capacity of the soil to support the approach or roadway. It is a threat to traffic. Structural analysis is warranted or has determined repairs are essential to restore the full capacity of the element.

---

|            |                          |                   |
|------------|--------------------------|-------------------|
| <b>202</b> | <b>Steel Pile/Column</b> | <b>Units – EA</b> |
|------------|--------------------------|-------------------|

---

This element defines a column or column portion of a pile constructed of structural steel visible for inspection.

1. Defects are superficial and have no effect on the structural capacity of the element.
2. Number of pile/columns with repairs such as: bolts or rivets have been replaced; cracks that have been drilled or plated.
3. Number of pile/columns with structural defects. The defects do not significantly affect structural capacity. Deficiencies do not warrant analysis, but may require repairs. Structural deficiencies are not limited to impact damage, cracks, broken bolts, or measurable section loss due to corrosion (note the location and depth).
4. Number of pile/columns with damage in locations or quantity and has reduced the structural capacity of the element or the bridge. Structural analysis is warranted or has determined repairs are essential to restore the full capacity of the element. Structural deficiencies are not limited to impact damage, corrosion, a crack in primary load path member or in the attachment welded to primary member. Retain the quantity of the element reported in CS4 if the element is repainted but not repaired.

---

|            |                                         |                   |
|------------|-----------------------------------------|-------------------|
| <b>204</b> | <b>Prestressed Concrete Pile/Column</b> | <b>Units – EA</b> |
|------------|-----------------------------------------|-------------------|

---

This element defines a column or column portion of a pile constructed of prestressed concrete visible for inspection.

---

|            |                             |                   |
|------------|-----------------------------|-------------------|
| <b>205</b> | <b>Concrete Pile/Column</b> | <b>Units – EA</b> |
|------------|-----------------------------|-------------------|

---

This element defines a column or column portion of a pile constructed of reinforced concrete visible for inspection. Usually, WSDOT concrete piles are designed and constructed inside a sacrificial steel pipe.

**Condition States for WSDOT Elements 204 and 205**

1. Defects are superficial and have no effect on the structural capacity of the element. There may be discoloration, efflorescence, and/or superficial cracking, spalls, or delaminations.
2. Number of pile/columns that has been repaired or patched.
3. Number of pile/columns has structural defects. The defects do not significantly affect structural capacity. Deficiencies do not warrant analysis, but may require repairs. Structural deficiencies are not limited to delaminations, spalls, structural cracking, exposed or corroded reinforcing or strands.
4. Number of pile/columns with damage in locations or quantity and has reduced the structural capacity of the element or the bridge. Structural analysis is warranted or has determined repairs are essential to restore the full capacity of the element.

---

|            |                           |                   |
|------------|---------------------------|-------------------|
| <b>206</b> | <b>Timber Pile/Column</b> | <b>Units – EA</b> |
|------------|---------------------------|-------------------|

---

This element defines a column or column portion of a pile constructed of timber visible for inspection.

1. Defects are superficial and have no effect on the structural capacity of the element. Decay, insect infestation, cracks, splits, or checks may exist.
2. Number of pile/columns with repairs, plates, or splices.
3. Number of pile/columns with structural defects. The defects do not significantly affect structural capacity. Deficiencies do not warrant analysis, but may require repairs. Typically, locations in a load path with a **shell thickness greater than or equal to 1½"** are marked with a YELLOW TAG.
4. Number of pile/columns with damage in locations or quantity and has reduced the structural capacity of the element or the bridge. Structural analysis is warranted or has determined repairs are essential to restore the full capacity of the element. Typically, locations in a load path with less than a 1½" shell thickness are marked with a RED TAG.



---

**207 Concrete Pile/Column w/Steel Jacket** **Units – EA**

---

This element defines a column or column portion of a pile constructed of reinforced concrete and has been seismically retrofitted with a steel jacket visible for inspection.

1. Defects are superficial and have no effect on the structural capacity of the element.
2. Number of pile/columns with repairs.
3. Number of pile/columns with structural defects. The defects do not significantly affect structural capacity. Deficiencies do not warrant analysis, but may require repairs. Structural deficiencies are not limited to impact damage, cracks, broken bolts, or measurable section loss due to corrosion (note the location and depth).
4. Number of pile/columns with damage in locations or quantity and has reduced the structural capacity of the element or the bridge. Structural analysis is warranted or has determined repairs are essential to restore the full capacity of the element. Structural deficiencies are not limited to impact damage, corrosion, a crack in primary load path member or in the attachment welded to primary member.

---

**208 Concrete Pile/Column w/Composite Wrap** **Units – EA**

---

This element defines a column or column portion of a pile constructed of reinforced concrete and has been seismically retrofitted with composite wrap visible for inspection.

1. Defects are superficial and have no effect on the structural capacity of the element. There may be discoloration, superficial cracking or debonding.
2. Number of composite wrapped Pile/Columns with repairs.
3. Number of composite wrapped Pile/Columns with structural defects. The defects do not significantly affect structural capacity of the wrap or pile/column. Deficiencies do not warrant analysis, but may require repairs.
4. Number of composite wrapped Pile /Columns with damage in locations or quantity and has reduced the structural capacity of the element or the bridge. Structural analysis is warranted or has determined repairs are essential to restore the full capacity of the element.

---

|            |                                                      |                   |
|------------|------------------------------------------------------|-------------------|
| <b>209</b> | <b>Submerged Concrete Pile/Column w/Steel Jacket</b> | <b>Units – EA</b> |
|------------|------------------------------------------------------|-------------------|

---

This element defines a submerged column or column portion of a pile that is constructed of reinforced concrete and has been seismically retrofitted with a steel jacket visible for inspection.

1. Defects are superficial and have no effect on the structural capacity of the element.
2. Number of steel jacketed Pile/Columns with repairs.
3. Number of steel jacketed Pile/Columns with structural defects. The defects do not significantly affect structural capacity. Deficiencies do not warrant analysis, but may require repairs. Structural deficiencies are not limited to impact damage, cracks, broken bolts, or measurable section loss due to corrosion (note the location and depth).
4. Number of steel jacketed Pile/Columns with damage in locations or quantity and has reduced the structural capacity of the element or the bridge. Structural analysis is warranted or has determined repairs are essential to restore the full capacity of the element.

---

|            |                           |                   |
|------------|---------------------------|-------------------|
| <b>210</b> | <b>Concrete Pier Wall</b> | <b>Units – LF</b> |
|------------|---------------------------|-------------------|

---

This element defines a pier wall constructed of reinforced concrete. The total quantity for this element is the length at the top of the wall.

---

|            |                        |                   |
|------------|------------------------|-------------------|
| <b>211</b> | <b>Other Pier Wall</b> | <b>Units – LF</b> |
|------------|------------------------|-------------------|

---

This element defines a pier wall that is constructed of a non-standard material (rock and mortar) or non-standard construction. The total quantity for this element is the length at the top of the wall.

---

|            |                                     |                   |
|------------|-------------------------------------|-------------------|
| <b>212</b> | <b>Concrete Submerged Pier Wall</b> | <b>Units – LF</b> |
|------------|-------------------------------------|-------------------|

---

This element defines a submerged pier wall constructed of reinforced concrete. The total quantity for this element is the length at the top of the wall.

---

|            |                                  |                   |
|------------|----------------------------------|-------------------|
| <b>213</b> | <b>Other Submerged Pier Wall</b> | <b>Units – LF</b> |
|------------|----------------------------------|-------------------|

---

This element defines a submerged pier wall that is constructed of a non-standard material (rock and mortar) or non-standard construction. The total quantity for this element is the length at the top of the wall.

**Condition States for WSDOT Elements 210, 211, 212, and 213**

1. Defects are superficial and have no effect on the structural capacity of the element.
2. Length of pier wall with repairs.
3. Length of pier wall with structural defects. The defects do not significantly affect structural capacity. Deficiencies do not warrant analysis, but may require repairs.
4. Entire length of pier wall with damage in locations or quantity and has reduced the structural capacity of the element or the bridge. Structural analysis is warranted or has determined repairs are essential to restore the full capacity of the element.

---

|            |                                          |                   |
|------------|------------------------------------------|-------------------|
| <b>214</b> | <b>Concrete Web Wall between Columns</b> | <b>Units – LF</b> |
|------------|------------------------------------------|-------------------|

---

This element defines a secondary concrete wall constructed between pier columns. This element includes railroad crash barriers. The total quantity for this element is the length at the top of the wall.

1. Defects are superficial and have no effect on the structural capacity of the element.
2. Affected length of Web wall with repairs.
3. Length of Web wall with structural defects. The defects do not significantly affect structural capacity. Deficiencies do not warrant analysis, but may require repairs.
4. Entire length of Web wall with damage in locations or quantity and has reduced the structural capacity of the element or the bridge. Structural analysis is warranted or has determined repairs are essential to restore the full capacity of the element.

---

|            |                          |                   |
|------------|--------------------------|-------------------|
| <b>215</b> | <b>Concrete Abutment</b> | <b>Units – LF</b> |
|------------|--------------------------|-------------------|

---

This element is defined as a concrete abutment or a concrete cap at the abutment which are designed to carry design loads to a foundation. A concrete abutment is a short or tall wall supporting the superstructure. An abutment cap is generally a rectangular beam supporting the superstructure. An abutment cap is included in this element and excluded from the quantity of element 234, Concrete Caps, elsewhere in the bridge. An abutment cap may be supported with concrete, steel, or timber columns or piles and the columns are coded separately and not included in this element, but are included with the quantity and evaluation of the other the similar columns in the bridge. The columns are only coded if they are visible or have been visible in the past.

The element quantity is measured along the skew and includes concrete monolithic wingwalls up to the first open joint or expansion joint. Wingwalls monolithic with the abutment shall be included evaluation of the abutment. The length of monolithic wingwall shall not exceed 20 feet per corner,

The embankment and retaining system, or retaining system beyond a monolithic wingwall, are documented in WSDOT element 200.

1. Defects are superficial and have no effect on the structural capacity of the element. There may be discoloration, efflorescence, and/or superficial cracking, spalls, or delaminations.
2. Affected length of abutment with repairs.
3. Length of abutment with structural defects. The defects do not significantly affect structural capacity. Deficiencies do not warrant analysis, but may require repairs.
4. Entire length of abutment when damage exists in locations or quantity and has reduced the structural capacity of the element or the bridge. Structural analysis is warranted or has determined repairs are essential to restore the full capacity of the element.

**216 Timber Abutment****Units – LF**

This element defines the roadway embankment fill behind a timber cap includes the sheet materials retaining the embankment. The total quantity is the length of the timber cap. Timber caps at the abutment and the piles supporting the caps are not included in this element. The caps are included in the element 235 with other timber caps and the piles are included with the other pile elements in the bridge.

Erosion outside of the abutment/wingwalls can be documented in the notes, but is not included in the evaluation of the element condition states.

1. Defects are superficial and have no effect on the structural capacity or performance of the fill.
2. **Length** of abutment that **has** been repaired.
3. **Length** of abutment with a fill problem which does not significantly affect the support of the traveled lanes. Deficiencies do not warrant analysis, but may require repairs.
4. **Length** of abutment with a fill problem in locations or quantity and has reduced the structural capacity of the soil to support the approach or roadway. It is a threat to traffic. Structural analysis is warranted or has determined repairs are essential to restore the full capacity of the element.

**217 Other Abutment****Units – LF**

This element defines an abutment not constructed of steel, timber, or concrete such as rock/mortar. The element quantity is the length of abutment measured along the skew. The element quantity includes monolithic wing walls but not to exceed 20 feet per corner.

Document the condition of the embankment and the embankment retaining system conditions in WSDOT element 200.

1. Defects are superficial and have no effect on the structural capacity of the element.
2. Affected length of abutment with repairs
3. Affected length of abutment with structural defects. The defects do not significantly affect structural capacity. Deficiencies do not warrant analysis, but may require repairs.
4. Entire length of abutment when damage exists in locations or quantity and has reduced the structural capacity of the abutment. Structural analysis is warranted or has determined repairs are essential to restore the full abutment capacity.

---

**218 Steel Abutment****Units – LF**

---

This element defines an abutment constructed of structural steel which is usually a steel cap at the abutment. Similar to concrete abutment caps, steel abutment caps are included in this element and are not included in the quantity of element 233, steel cap/crossbeam. The columns supporting the steel cap are coded separately or included with other similar columns in the bridge. The element quantity is the length of steel abutment cap measured along the skew.

Document the embankment conditions and the embankment retaining system conditions in WSDOT element 200.

1. Defects are superficial and have no effect on the structural capacity of the element.
2. Length of abutment with repairs such as: bolts or rivets have been replaced; cracks that have been drilled or plated.
3. Length of abutment with structural defects. The defects do not significantly affect structural capacity. Deficiencies do not warrant analysis, but may require repairs. Structural deficiencies are not limited to impact damage, cracks, broken bolts, or measurable section loss due to corrosion (note the location and depth).
4. Entire length of abutment affected when damage exists in locations or quantity and has reduced the structural capacity of the element or the bridge. Structural analysis is warranted or has determined repairs are essential to restore the full capacity of the element.

**219 Concrete Cantilevered Span Abutment****Units – EA**

The WSDOT Cantilever Span Abutment element was created to keep this abutment type separate from the typical abutment elements. This element defines an abutment for the end of a bridge span that is cantilevered from the first or last pier at grade. The default notation assumes the pavement seat (abutment 1) is Pier 1; the cantilever span is Span 1; the first pier is Pier 2. These abutments do not carry load but do retain fill where the defects of structural members are evaluated as part of the superstructure elements.

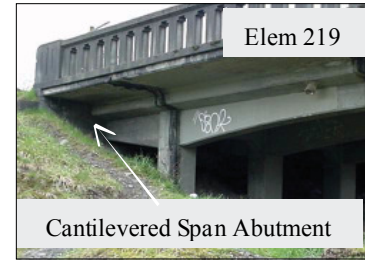

The definition, condition evaluation, and units are the same as for the WSDOT element 200 where this element is defined as the soil retained behind the abutment and wing walls or retaining walls that support an asphalt roadway or approach slab. The fill evaluation should not extend beyond 25 feet or the approach slab, whichever is greater. Erosion outside of the abutment/wingwalls can be documented in the notes, but is not included in the evaluation of the element condition states.

1. Defects are superficial and have no effect on the structural capacity or performance of the fill.
2. Number of abutments that have been repaired.
3. Number of abutments with a fill problem does not significantly affect the support of the traveled lanes. Deficiencies do not warrant analysis, but may require repairs.
4. Number of abutments with a fill problem in locations or quantity and has reduced the structural capacity of the soil to support the approach or roadway. It is a threat to traffic. Structural analysis is warranted or has determined repairs are essential to restore the full capacity of the element.

**220 Concrete Submerged Foundation****Units – EA**

This element defines a reinforced concrete foundation footing supported by shafts, piles, or soil (spread footing) that is visible for inspection and may be always, or seasonably covered by water. Do not delete the element from the bridge because the foundation is no longer visible. Scour deficiencies at a concrete abutment are included in WSDOT element 361 and are not included in this element.

The piles may be timber, concrete or steel. If the supporting piles become visible, then the pile element should be added to the bridge. The total quantity is the quantity of piles supporting the exposed foundation, not just the number of exposed piles. Do not delete the element in subsequent inspections. The total quantity of foundations/piles will increase each time a new location is exposed and visible.

**221 Concrete Foundation****Units – EA**

This element defines a reinforced concrete foundation footing supported by shafts, piles, or soil (spread footing) that is visible for inspection. Scour deficiencies at a concrete foundation are included in WSDOT element 361 and are not included in this element. Plinths are a form of spread footing and included in this element which are a small concrete base that supports a column.

The piles may be timber, concrete or steel. If the supporting piles become visible, then the pile element should be added to the bridge. The total quantity is the quantity of piles supporting the exposed foundation, not just the number of exposed piles. Do not delete the element in subsequent inspections. The total quantity of foundations/piles will increase each time a new location is exposed and visible.

**Condition States for WSDOT Elements 220 and 221**

1. Defects are superficial and have no effect on the structural capacity of the element. There may be discoloration, efflorescence, and/or superficial cracking, spalls, or delaminations.
2. Number of foundations with repairs.
3. Number of foundations with structural defects. The defects do not significantly affect structural capacity. Deficiencies do not warrant analysis, but may require repairs.
4. Number of foundations with damage in locations or quantity and has reduced the structural capacity of the element or the bridge. Structural analysis is warranted or has determined repairs are essential to restore the full capacity of the element.

**222 Timber Foundation****Units – LF**

This element defines a timber foundation element that includes a mud sill which is a spread footing and the rare case of a pile supported footing. A timber pile supported footing is a where timber horizontal footing member is a support for columns and the timber member is supported by piles. The total quantity for this element is the length of timber foundation.

1. Defects are superficial and have no effect on the structural capacity of the element. Decay, insect infestation, cracks, splits, or checks may exist.
2. Total length of foundation if repairs exist.
3. Total length of foundation if structural defects exist, but the defects do not significantly affect structural capacity. Deficiencies do not warrant analysis, but may require repairs. Typically, locations in a load path with a **shell thickness greater than or equal to 1½"** are marked with a YELLOW TAG.
4. Total length of foundation where damage exists in locations or quantity and has reduced the structural capacity of the element or the bridge. Structural analysis is warranted or has determined repairs are essential to restore the full capacity of the element. Typically, locations in a load path with less than a 1½ shell thickness are marked with a RED TAG.

---

|            |                                    |                   |
|------------|------------------------------------|-------------------|
| <b>225</b> | <b>Steel Submerged Pile/Column</b> | <b>Units – EA</b> |
|------------|------------------------------------|-------------------|

---

This element defines a column or column portion of a pile constructed of steel and is visible for inspection and may be always or seasonably covered by water. Do not delete the element from the bridge because the element is no longer visible. The exposure may be intentional or caused by scour.

---

|            |                                                   |                   |
|------------|---------------------------------------------------|-------------------|
| <b>226</b> | <b>Prestressed Concrete Submerged Pile/Column</b> | <b>Units – EA</b> |
|------------|---------------------------------------------------|-------------------|

---

This element defines a submerged column or column portion of a pile constructed of prestressed concrete and is visible for inspection and may be always or seasonably covered by water. Do not delete the element from the bridge because the element is no longer visible. The exposure may be intentional or caused by scour.

---

|            |                                       |                   |
|------------|---------------------------------------|-------------------|
| <b>227</b> | <b>Concrete Submerged Pile/Column</b> | <b>Units – EA</b> |
|------------|---------------------------------------|-------------------|

---

This element defines a submerged column or column portion of a pile constructed of reinforced concrete and is visible for inspection and may be always or seasonably covered by water. Do not delete the element from the bridge because the element is no longer visible. The exposure may be intentional or caused by scour.

**Condition States for WSDOT Elements 225, 226, and 227**

1. Defects are superficial and have no effect on the structural capacity of the element. There may be discoloration, efflorescence, and/or superficial cracking, spalls, or delaminations.
2. Number of pile/columns with repairs.
3. Number of pile/columns with structural defects. The defects do not significantly affect structural capacity. Deficiencies do not warrant analysis, but may require repairs.
4. Number of pile/columns with damage in locations or quantity and has reduced the structural capacity of the element or the bridge. Structural analysis is warranted or has determined repairs are essential to restore the full capacity of the element.



---

|            |                                     |                   |
|------------|-------------------------------------|-------------------|
| <b>228</b> | <b>Timber Submerged Pile/Column</b> | <b>Units – EA</b> |
|------------|-------------------------------------|-------------------|

---

This element defines a submerged column or column portion of a pile constructed of reinforced timber and is visible for inspection and may be always or seasonably covered by water. Do not delete the element from the bridge because the element is no longer visible. The exposure may be intentional or caused by scour.

1. Defects are superficial and have no effect on the structural capacity of the element. Decay, insect infestation, cracks, splits, or checks may exist.
2. Number of pile/columns with repairs, plates, or splices.
3. Number of pile/columns with structural defects. The defects do not significantly affect structural capacity. Deficiencies do not warrant analysis, but may require repairs. Typically, locations in a load path with a **shell thickness greater than or equal to 1½"** are marked with a YELLOW TAG.
4. Number of pile/columns with damage in locations or quantity and has reduced the structural capacity of the element or the bridge. Structural analysis is warranted or has determined repairs are essential to restore the full capacity of the element. Typically, locations in a load path with less than a 1½" shell thickness are marked with a RED TAG.

---

|            |                                    |                   |
|------------|------------------------------------|-------------------|
| <b>229</b> | <b>Timber Cap Rehab with Steel</b> | <b>Units – LF</b> |
|------------|------------------------------------|-------------------|

---

This element consists of a timber cap rehabilitation where alternate load paths to piling are provided by steel members on the exterior of the cap and the timber cap remains in place. The timber conditions are excluded from the condition evaluation. The total quantity for this element is the length at the top of the wall.

1. Defects are superficial and have no effect on the structural capacity of the element.
2. Steel span length of pier cap rehabilitation with repairs.
3. Steel length of pier cap rehabilitation with structural defects. The defects do not significantly affect structural capacity. Deficiencies do not warrant analysis, but may require repairs. Structural deficiencies are not limited to impact damage, cracks, broken bolts, or measurable section loss due to corrosion (note the location and depth).
4. Steel span length of pier cap rehabilitation with damage in locations or quantity and has reduced the structural capacity of the element or the bridge. Structural analysis is warranted or has determined repairs are essential to restore the full capacity of the element. Structural deficiencies are not limited to impact damage, corrosion, a crack in primary load path member or in the attachment welded to primary member. Retain the quantity of the element reported in CS4 if the element is repainted but not repaired.

---

**231 Steel Pier Cap/Crossbeam** **Units – LF**

---

This element defines a steel pier cap or crossbeam. The total quantity for this element is the length at the top of the crossbeam.

1. Defects are superficial and have no effect on the structural capacity of the element.
2. Steel span length of pier cap/crossbeam with repairs.
3. Steel span length of pier cap/crossbeam with structural defects. The defects do not significantly affect structural capacity. Deficiencies do not warrant analysis, but may require repairs. Structural deficiencies are not limited to impact damage, cracks, broken bolts, or measurable section loss due to corrosion (note the location and depth).
4. Steel span length of pier cap/crossbeam with damage in locations or quantity and has reduced the structural capacity of the element or the bridge. Structural analysis is warranted or has determined repairs are essential to restore the full capacity of the element. Structural deficiencies are not limited to impact damage, corrosion, a crack in primary load path member or in the attachment welded to primary member. Retain the quantity of the element reported in CS4 if the element is repainted but not repaired.

---

**233 Prestressed Concrete Pier Cap/Crossbeam** **Units – LF**

---

This element defines a prestressed concrete pier cap or crossbeam. The total quantity for this element is the length at the top of the crossbeam.

---

|                                        |                   |
|----------------------------------------|-------------------|
| <b>234 Concrete Pier Cap/Crossbeam</b> | <b>Units – LF</b> |
|----------------------------------------|-------------------|

---

This element defines a reinforced concrete pier cap or crossbeam. Integral pier caps with girders framed directly into the crossbeam are also included in this element. The total quantity for this element is the length at the top of the crossbeam.

**Condition States for WSDOT Elements 233 and 234**

1. Defects are superficial and have no effect on the structural capacity of the element. There may be discoloration, efflorescence, and/or superficial cracking, spalls, or delaminations.
2. Length of pier cap/crossbeam affected by repair or patch. Capacity repairs such as a strand splicing should record girder span length.
3. Length of pier cap/crossbeam affected by defects. The defects do not significantly affect structural capacity. Deficiencies do not warrant analysis, but may require repairs. Structural deficiencies are not limited to delaminations, spalls, structural cracking, exposed or corroded reinforcing or strands.
4. Concrete span length of pier cap/crossbeam affected by damage in locations or quantity and has reduced the structural capacity of the element or the bridge. Structural analysis is warranted or has determined repairs are essential to restore the full capacity of the element.

---

|                            |                   |
|----------------------------|-------------------|
| <b>235 Timber Pier Cap</b> | <b>Units – LF</b> |
|----------------------------|-------------------|

---

This element defines a timber pier cap that directly supports the superstructure. The total quantity for this element is the length at the top of the crossbeam.

1. Defects are superficial and have no effect on the structural capacity of the element. Decay, insect infestation, cracks, splits, or checks may exist.
2. Length of pier cap with repairs, plates, or splices.
3. Length of pier cap with structural defects. The defects do not significantly affect structural capacity. Deficiencies do not warrant analysis, but may require repairs. Typically, locations in a load path with a **shell thickness greater than or equal to 1½"** are marked with a YELLOW TAG.
4. Timber span length of pier cap with damage in locations or quantity and has reduced the structural capacity of the element or the bridge. Structural analysis is warranted or has determined repairs are essential to restore the full capacity of the element. Typically, locations in a load path with less than a 1 ½ shell thickness are marked with a RED TAG.

---

**236 Concrete Floating Pontoon****Units – Cell**

---

A concrete floating bridge is a series of post-tensioned floating pontoons which are subdivided into internal compartments called cells. Traffic may ride directly on the top of the pontoon or the roadway may be elevated above the pontoon and supported by columns. This element includes all pontoons regardless of size or configuration and all cells shall be evaluated at the same risk to the bridge condition. Deck elements will apply for the entire length of the pontoon structure. Pontoon condition will include the top slab where the deck /soffit elements exist on the pontoon. The deck/soffit elements are not included where the deck is elevated above the pontoon. The total quantity for the Concrete Floating Pontoon element is the total number of pontoon cells for the bridge.

Concrete pontoons are specially designed to be water tight and dry while in service. The concrete is specifically designed to be visually crack free and have low permeability with water tight construction joints. Water tight design is the basis for condition evaluation of the pontoon below water line and is to include, but is not limited to the assessment of post-tensioned concrete, connections between pontoons, WSDOT element 237-Pontoon Hatch/Bulkheads, and the risk to buoyancy. Water tight criteria shall not apply to the evaluations of conventionally designed concrete conditions above the waterline.

Concrete cracking shall be assessed on the location:

- Above or below the waterline;
- Whether it is in an exterior or interior wall;
- Whether it is active or in-active;
- And based on the design criteria that visible cracking should not exist on submerged surfaces.

An active crack is defined for this element as a crack that allows water to pass into or through a concrete section which is a risk for transporting fine materials out of the section or a source of contaminates into the section. Active cracks may be visible under normal bridge loading or only visible under storm conditions.

Seepage is defined as a cell with a water accumulation of less than 1” per year.

Ballasted cells shall establish a void ratio of the ballast to calculate a volume of water in a cell.

This Concrete Floating Pontoon element also defines the relationship between the bridge element condition and the corresponding NBI Substructure Condition rating or NBI Item 060.

1. Number of pontoon cells with defects that are superficial and are insignificant to structural capacity or buoyancy of the cell, pontoon or bridge. The cell is dry. A cell may have water present due to condensation caused when a deck hatch is opened.
  - If the total quantity is in CS1, then NBI Item 060 shall be an 8.

2. Number of pontoon cells with a repair such as, but not limited to a concrete patch or a sealed crack.
  - If repairs are above water level, then NBI Item 060 shall be a 7.
  - If repairs below water level, then NBI Item 060 shall be a 6.
  - If 20 percent of the cells in one pontoon, or a total of 10 percent of the cells in adjoining pontoons, or 5 percent of the total element quantity are in CS2, then NBI Item 060 shall be a 5.
3. Number of pontoon cells with significant defects. Conventional concrete defects above the waterline which does not affect structural capacity of the concrete. Water tight defects below the waterline which may affect buoyancy of the cell, pontoon or the bridge. Typical CS3 submerged defects include, but are not limited to: Seepage of less than 1” of water accumulation in a year; Cracks that are stable or inactive for several storm events; Areas of concrete that are moist or have leachate present; Any cells that are consistently in a damp or “trace condition.”
  - If cells are in CS3 due to seepage, then NBI Item 060 shall be a 6.
  - If eight or more adjacent or contiguous cells in a single pontoon are in CS3, then NBI Item 060 shall be a 5.
  - If 20 percent of the cells in one pontoon, or a total of 10 percent of the cells in adjoining pontoons or 5 percent of the total element quantity are in CS3, then NBI Item 060 shall be a 4.
4. Number of pontoon cells with damage in locations or quantity which has reduced the structural capacity of the pontoon or threatens the buoyancy of a cell, the pontoon or the bridge. Wet conditions that indicate a threat to a cell’s buoyancy include, but not limited to: Water leaks 1 inch or more per year in three consecutive years; Water leaks 2 inches or more in a year; Any cell visually leaking water. Any cell with a pontoon hatch or bulkhead in CS4, see WSDOT element 237.
  - If cells are in CS4, then NBI Item 060 shall be a 4.
  - If eight or more non-adjacent cells in a single pontoon are in CS4 or one cell leaks ½ inch per month, then NBI Item 060 shall be a 3.
  - If eight or more adjacent cells in a single pontoon are in CS4, or one cell leaks 1 inch of water per month, then NBI Item 060 shall be a 2.
  - If 20 percent of the cells in one pontoon, or a total of 10 percent of the cells in adjoining pontoons or 5 percent of the total element quantity are in CS4, then NBI Item 060 shall be a 2.
  - If one cell leaks 1 inch of water per month, for three consecutive months, then the NBI Item 060 shall be a 1 and the bridge shall be closed to traffic.
  - If there is a measurable or visual change in the alignment or the free board distance at any location on the pontoon, then the NBI Item 060 shall be a 1 and the bridge shall be closed to traffic.

**237 Pontoon Hatch/Bulkhead****Units – EA**

This element defines a steel deck or bulkhead hatch access. Deck hatches are accessed from the exterior of a pontoon and bulkhead hatches provide access between cells. The condition evaluation of a hatch includes, but is not limited to the ability of a hatch to provide a watertight structural seal. The performance of the hatches is critical to the design buoyancy of the pontoon structure during extreme events. The total element quantity is the total number of hatch and bulkheads on a bridge.

1. Defects are superficial and are insignificant to performance of the hatch. Insignificant amounts of water enter a cell when a deck hatch is opened.
2. Number of hatch/bulkheads with repairs such as: replaced seals, repaired hold-down dogs or locks.
3. Number of hatch/bulkheads with structural defects. The defects do not threaten performance of the hatch. Number of hatches which allow water accumulation into a cell of less than 1” per year.
4. Number of hatch/bulkheads with damage that threatens performance during an extreme event. Number of hatches which allow water accumulation into a cell of 1” or more per year. All pontoon cells in WSDOT element 236 shall be coded CS4 that have a deck hatch or bulkhead hatch coded CS4.

**238 Floating Bridge – Anchor Cable****Units – EA**

This element defines a steel anchor cable used in a floating bridge. The condition of a floating pontoon anchor cable is evaluated during underwater inspections performed by divers and remotely operated vehicles. Condition evaluation is based on cable protection system, breakage of wires within the cable and the condition of the cable anchor. The total element quantity should equal the number of floating pontoon anchor cables attached to the bridge.

1. Number of cables or anchors with no defects in the cable or anchor and the galvanized protection system is functioning properly. New replacement cables are coded in this condition state. (Corresponds to NBI substructure rating of 7 or 8.)
2. Number of cables or anchors with defects that are insignificant and do not affect the capacity of the cable. The galvanized protection system is showing signs of failure, and surface or freckled rust may exist with no significant loss of section. If any portion of the cable or anchor is CS2, then the NBI Substructure Condition rating (NBI Item 060) shall be a maximum of 6.
3. Number of cables or anchors with defects that are beginning to affect the capacity of the cable, but are within acceptable design limits. Corrosion section loss is present. Single wire failures of the cable may exist due to corrosion or hydrogen embrittlement, but no closer than 30 feet apart.
4. Number of cables or anchors with defects that have significantly affected the capacity. Two or more broken wires, or equivalent section loss due to other defects, are within 30 feet. If any portion of the cable or anchor is CS4, then the NBI Substructure Condition rating (NBI Item 060) shall be a maximum of 4. If two or more adjacent cables (on the same side or opposite sides of the pontoon) or more than four cables on the structure are CS4, then the NBI Substructure Condition rating (NBI Item 060) shall be 3.

## 4.5 Culverts

---

|            |                      |                   |
|------------|----------------------|-------------------|
| <b>240</b> | <b>Metal Culvert</b> | <b>Units – LF</b> |
|------------|----------------------|-------------------|

---

This element defines a metal (steel, aluminum, etc.) culvert including arches, round or elliptical pipes, etc. The total quantity is the length of culvert from inlet to outlet along the bottom of the culvert and does not include the apron.

1. Defects are superficial and have no effect on the structural capacity of the element. There may be corrosion, erosion, scour, distortion, or roadway settlement.
2. Length of culvert with repairs.
3. Length of culvert with structural defects. The defects do not significantly affect structural capacity. Deficiencies do not warrant analysis, but may require repairs.
4. Length of culvert affected by damage in locations or quantity and has reduced the structural capacity of the culvert. Structural analysis is warranted or has determined repairs are essential to restore the full capacity of the element. Structural deficiencies are not limited to: distortion, deflection, roadway settlement, or misalignment of the barrel.

---

|            |                         |                   |
|------------|-------------------------|-------------------|
| <b>241</b> | <b>Concrete Culvert</b> | <b>Units – LF</b> |
|------------|-------------------------|-------------------|

---

This element defines all precast and cast-in-place (conventional or prestressed) concrete arch, pipe and box culverts. The total quantity is the length of culvert from inlet to outlet along the bottom of the culvert and does not include the apron.

1. Defects are superficial and have no effect on the structural capacity of the element. There may be discoloration, efflorescence, and/or superficial cracking, spalls, or delaminations.
2. Length of culvert with repair or patch.
3. Length of culvert affected by defects. The defects do not significantly affect structural capacity. Deficiencies do not warrant analysis, but may require repairs. Structural deficiencies are not limited to delaminations, spalls, structural cracking, exposed or corroded reinforcing or strands.
4. Length of culvert affected by damage in locations or quantity and has reduced the structural capacity of the element or the bridge. Structural analysis is warranted or has determined repairs are essential to restore the full capacity of the culvert. Structural deficiencies are not limited to: distortion, deflection, roadway settlement, or misalignment of the.

---

**242 Timber Culvert****Units – LF**

---

This element defines all timber box culverts. The total quantity is the length of culvert from inlet to outlet along the bottom of the culvert and does not include the apron.

1. Defects are superficial and have no effect on the structural capacity of the element. Decay, insect infestation, cracks, splits, or checks may exist.
2. Length of culvert that has been replaced, repaired, patched, or plated.
3. Length of culvert with structural defects. The defects do not significantly affect structural capacity. Deficiencies do not warrant analysis, but may require repairs. Typically, locations in a load path with a **shell thickness greater than or equal to 1½"** are marked with a YELLOW TAG.
4. Length of culvert affected by damage in locations or quantity and has reduced the structural capacity of the element or the bridge. Structural analysis is warranted or has determined repairs are essential to restore the structural capacity of the culvert. Structural deficiencies are not limited to: distortion, deflection, roadway settlement, or misalignment of the barrel. Typically, locations in a load path with less than a 1½" shell thickness are marked with a RED TAG.

---

**243 Other Culvert****Units – LF**

---

This element defines all culverts not included under steel, concrete, or timber culvert elements. It may include masonry or combinations of other materials. The total quantity is the length of culvert from inlet to outlet along the bottom of the culvert and does not include the apron.

1. Defects are superficial and have no effect on the structural capacity of the culvert.
2. Length of culvert with repairs.
3. Length of culvert with structural defects. The defects do not significantly affect structural capacity. Deficiencies do not warrant analysis, but may require repairs.
4. Length of culvert affected by damage in locations or quantity and has reduced the structural capacity of the culvert. Structural analysis is warranted or has determined repairs are essential to restore the structural capacity of the culvert. Structural deficiencies are not limited to: distortion, deflection, roadway settlement, or misalignment of the barrel.



## 4.6 Tunnels

---

|            |                                |                   |
|------------|--------------------------------|-------------------|
| <b>250</b> | <b>Tunnel – Concrete Lined</b> | <b>Units – SF</b> |
|------------|--------------------------------|-------------------|

---

This WSDOT element identifies concrete lined tunnels. In addition, other WSDOT elements are used to record the existence and condition of those portions of a tunnel that are defined as tunnel superstructure. Tunnel superstructure exists when elevated members directly support live load on or inside the tunnel. The total quantity is the tunnel perimeter exposed to traffic minus the roadway surface multiplied by the length of tunnel.

---

|            |                              |                   |
|------------|------------------------------|-------------------|
| <b>251</b> | <b>Tunnel – Timber Lined</b> | <b>Units – SF</b> |
|------------|------------------------------|-------------------|

---

This is an element used to identify timber-lined tunnels. In addition, other WSDOT elements are used to record the existence and condition of those portions of a tunnel that are defined as tunnel superstructure. Tunnel superstructure exists when elevated members directly support live load on or inside the tunnel. The total quantity is the tunnel perimeter exposed to traffic minus the roadway surface multiplied by the length of tunnel.

---

|            |                         |                   |
|------------|-------------------------|-------------------|
| <b>252</b> | <b>Tunnel – Unlined</b> | <b>Units – SF</b> |
|------------|-------------------------|-------------------|

---

This is an element to identify unlined tunnels. In addition, other WSDOT elements are used to record the existence and condition of those portions of a tunnel that are defined as tunnel superstructure. Tunnel superstructure exists when elevated members directly support live load on or inside the tunnel. The total quantity is the tunnel perimeter exposed to traffic minus the roadway surface multiplied by the length of tunnel.

### Condition States for WSDOT Elements 250, 251, and 252

1. Defects are superficial and have no effect on the structural capacity of the tunnel.
2. Tunnel area with repairs or patches.
3. Tunnel area with structural defects. The defects do not significantly affect structural capacity. Deficiencies do not warrant analysis, but may require repairs.
4. Tunnel area affected by damage in locations or quantity and has reduced the structural capacity of the tunnel (or tunnel liner). Structural analysis is warranted or has determined repairs are essential to restore the full capacity of the element.

---

|            |                    |                   |
|------------|--------------------|-------------------|
| <b>253</b> | <b>Tunnel Tile</b> | <b>Units – SF</b> |
|------------|--------------------|-------------------|

---

This is an element to identify tunnel tile. The total quantity is the area of tile visible for inspection.

1. Tile is bonded with no cracks, chips, or blemishes. Tile may be dirty but reflectivity is enhanced during regular tunnel washing operations.
2. Tile area that has been repaired.
3. Tile area that is bonded, but cracked and may have efflorescence or small amounts of section loss. Tile may be blemished from impact or other causes resulting in major loss of reflectivity.
4. Tile area with delaminations based on soundings, is completely missing, or has major section loss warranting replacement.

## 4.7 Sidewalk and Supports

A sidewalk is an element that provides pedestrian access across a bridge. A sidewalk is supported by a bridge deck and/or by sidewalk brackets that consist of several types of materials. The purpose of the sidewalk BMS is to record the structural integrity of the support system and sidewalk. Identify these elements in BMS if the sidewalk width is greater than or equal to 3 feet.

However, there are exceptions that must be accommodated. When there is a true sidewalk on a bridge as determined by the design, approach sidewalks, and location, it is appropriate to enter a sidewalk element in the BMS. Timber sidewalks, for example, may be narrow and have a support system. These exceptions should include a sidewalk WSDOT element. A specific note explaining the reasoning for including the sidewalk element should be provided.

If a rail retrofit or a wide curb has been determined to NOT be a sidewalk, then Bridge Rail elements will be used to document defects.

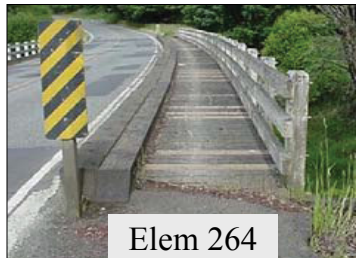

---

### 260 Steel Open Grid Sidewalk and Supports

Units – SF

This element defines a sidewalk constructed of steel grids that are open and unfilled. This element also includes the members used to provide support like stringers and braces. The total quantity should equal the width of the sidewalk times its length which includes sidewalk supported by structural bridge members such as a wing wall or approach slab.

---

### 261 Steel Concrete Filled Grid Sidewalk and Supports

Units – SF

This element defines a sidewalk constructed of steel grids that have been filled with concrete. This element also includes the members used to provide support like stringers and braces. The total quantity should equal the width of the sidewalk times its length which includes sidewalk supported by structural bridge members such as a wing wall or approach slab.

---

### 262 Corrugated/Orthotropic Sidewalk and Supports

Units – SF

This element defines a sidewalk constructed of corrugated metal filled with Portland cement concrete or asphaltic concrete or an orthotropic steel deck. This element also includes the members used to provide support like stringers and braces. The total quantity should equal the width of the sidewalk times its length which includes sidewalk supported by structural bridge members such as a wing wall or approach slab.

**264 Timber Sidewalk and Supports****Units – SF**

This element defines a sidewalk constructed of timber. This element also includes the members used to provide support like stringers and braces. The total quantity should equal the width of the sidewalk times its length which includes sidewalk supported by structural bridge members such as a wing wall or approach slab.

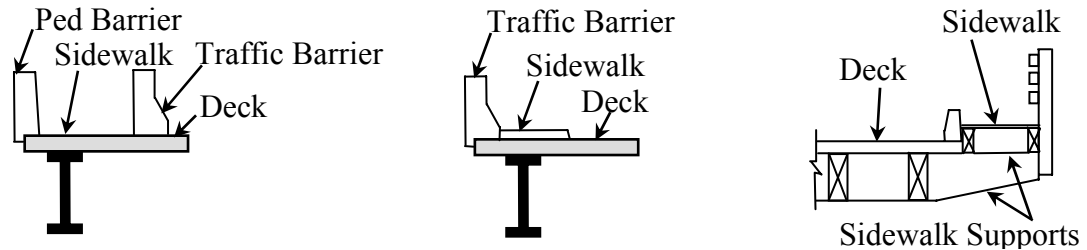
**266 Concrete Sidewalk and Supports****Units – SF**

This element defines a sidewalk constructed of reinforced concrete. The concrete sidewalk may be supported by the roadway deck, bracing, diaphragms, or sidewalk stringers. The total quantity should equal the width of the sidewalk times its length which includes sidewalk supported by structural bridge members such as a wing wall or approach slab.

**267 Fiber Reinforced Polymer (FRP) Sidewalk and Supports****Units – SF**

This element defines a sidewalk constructed of fiber-reinforced polymer. This element also includes the members used to provide support like stringers and braces. The total quantity should equal the width of the sidewalk times its length which includes sidewalk supported by structural bridge members such as a wing wall or approach slab.

**Condition States for WSDOT Elements 260, 261, 262, 264, 266, and 267**

1. Defects are superficial and have no effect on the structural capacity of the sidewalk or supports.
2. Sidewalk area (or support projected area) with repairs or patches
3. Sidewalk area (or support projected area) with structural defects. The defects do not significantly affect structural capacity. Deficiencies do not warrant analysis, but may require repairs.
4. Sidewalk area (or support projected area) affected by damage in locations or quantity and has reduced the structural capacity of the sidewalk support. Structural analysis is warranted or has determined repairs are essential to restore the full capacity of the element.

## 4.8 Bearings

When an in-span hinge separates two structures, the joint, bearing, and seismic restrainers at the hinge will be documented in the dependent (or supported) structure only.

---

### 310 Elastomeric Bearing Units – EA

---

This element defines a bridge bearing that is constructed primarily of elastomers, with or without fabric or metal reinforcement.



---

### 311 Moveable Bearing (Roller, Sliding, etc.) Units – EA

---

This element defines those bridge bearings that provide for both deflection and longitudinal movement by means of roller, rocker or sliding mechanisms.



---

### 312 Concealed Bearing or Bearing System Units – EA

---

This element defines those bridge bearings and/or bearing seats that are not accessible with tools or equipment and therefore are not open for detailed inspection.

---

### 313 Fixed Bearing Units – EA

---

This element defines those bridge bearings that provide for rotation only.



**314 Pot Bearing****Units – EA**

This element defines those high load bearings with a confined elastomer. The bearing may be fixed against horizontal movement, guided to allow sliding in one direction, or floating to allow sliding in any direction.

**315 Disc Bearing****Units – EA**

This element defines a high load bearing with a hard plastic disc. The bearing may be fixed against horizontal movement, guided to allow sliding in one direction, or floating to allow sliding in any direction.

**316 Isolation Bearing****Units – EA**

This element defines a bearing that is laminated and is a sandwich of neoprene and steel plates. The bearing contains a lead core that is primarily used for seismic loads. The isolation bearing is used to protect structures against earthquake damage.

**Condition States for WSDOT Elements 310, 311, 312, 313, 314, 315, and 316**

1. Defects are superficial and have no effect on the superstructure movements or safe transfer of load to the substructure. Shear deformation, displacement, or cracking of grout pad may be present. Top and bottom surfaces may not be parallel.
2. Number of bearings with a repair.
3. Number of bearings with structural defects. The defects are not detrimental to the superstructure or the safe transfer of load to the substructure. Deficiencies do not warrant analysis, but may require repairs.
4. Number of bearings with defects that are detrimental to the superstructure or the safe transfer of load to the substructure. Loss of minimum bearing area may be imminent. Structural analysis is warranted or has determined bearing repairs are essential to restore the safe movement or transfer of load to the substructure.

## 4.9 Bridge Approach

---

### 321 Concrete Roadway Approach Slab Units – SF

---

This element defines a structural concrete slab supported at the bridge abutment and the roadway pavement. This element is essentially a concrete deck element that documents the surface conditions of the approach slab. The element quantity is the total area of both concrete approach slabs attached to the bridge. Do not include asphalt shoulder if present. Whether surface of approach slab is visible or covered by an asphalt overlay, a WSDOT element shall exist.

1. Defects are superficial. The slab surface do not have spalls/delaminations or previous repairs. The deck surfaces may have cracks or rock pockets. Wear and rutting may expose aggregate or reinforcing.
2. Slab area with repairs or patches. Do not include the rare case rutting filled with patching material.
3. Slab area with spalling. Do not add delaminations found in the field.
4. This condition state documents when an approach slab has failed and needs to be replaced. Failure is normally due to the slab falling off the bridge seat with a visible grade separation and/or excessive gap at the pavement seat. Code the total SF of approach slab in condition state 4.

---

### 322 Bridge Impact Units – EA

---

This documents an increase to the bridge live load, or impact, due to hammering or dynamic response of the bridge from trucks passing on to the bridge. Truck speed may be considered when slower speeds reduce the impact. Total quantity is based on the direction of trucks on to the bridge. Head to head traffic has two and bridges with a single direction of traffic will have one, such as ramps or main line divided structures (N&S or E&W). Code the approach roadway in the condition state that best indicates the severity of the problem. For the roadway where trucks are leaving the structure, deficiencies **will** be described and repairs may be called out; however, **the trailing roadway will not be quantified in the condition states.**

1. The number of approach roadways that are smooth. Hammer or dynamic response to the structure is not significant. There may be small bumps or minor raveling of the pavement in the approach roadway.
2. The number of approach roadways (not approach slab) that have been repaired or feather patched to correct an approach problem. If a paving project has removed the repairs, **maintain the CS2 condition and note the year of the new asphalt.**
3. The number of approach roadways that are rough, but the increase in live load to the structure is minor. Hammering impact is minor due to the wheels passing over surface discontinuities such as joints, cracks, or potholes. Dynamic response is minor due to a dip or rise in the approach roadway alignment.
4. The number of approach roadways that are causing significant increase in live load to the structure. Hammering impact is significant due to the wheels passing over surface discontinuities such as joints, cracks, or potholes. Dynamic response is significant due to a dip or rise in the approach roadway alignment.

## 4.10 Bridge Rail

WSDOT element for bridge railing are to be entered for each type of rail. For example, if there is W-beam or Thrie beam guardrail mounted on the concrete bridge rail, then the length of each metal and concrete element should be entered. If the original concrete bridge rail has aluminum rail installed on top (with or without a rail retrofit), enter that quantity into the appropriate WSDOT element as well. In the element notes, describe what type of metal bridge or pedestrian rail has been entered.

---

### **330 Metal Bridge Railing** **Units – LF**

---

This element defines all types and shapes of metal bridge railing aluminum, metal beam, rolled shapes, etc. The quantity should equal the total length measured along each bridge rail within the limits of the bridge which includes rail attached to structural bridge members such as a wing wall or approach slab.

---

### **331 Concrete Bridge Railing** **Units – LF**

---

This element defines all types and shapes of reinforced concrete bridge railing. The quantity should equal the total length measured along each bridge rail within the limits of the bridge which includes rail attached to structural bridge members such as a wing wall or approach slab.

---

### **332 Timber Bridge Railing** **Units – LF**

---

This element defines all types and shapes of timber railing. All elements of this rail (except connectors) must be timber. The quantity should equal the total length measured along each bridge rail within the limits of the bridge which includes rail attached to structural bridge members such as a wing wall or approach slab.

---

### **333 Other Bridge Railing** **Units – LF**

---

This element defines all types and shapes of bridge railing except those defined as METAL, CONCRETE or TIMBER. This element will include cable rails, and combinations of materials. The quantity should equal the total length measured along each bridge rail within the limits of the bridge which includes rail attached to structural bridge members such as a wing wall or approach slab.

#### **Condition States for WSDOT Elements 330, 331, 332, and 333**

1. Defects are superficial and have no effect on the structural capacity of the element.
2. Bridge rail length with a repair.
3. Bridge rail length with structural defects. The defects do not significantly affect structural capacity. Deficiencies do not warrant analysis, but may require repairs. Structural deficiencies are not limited to impact damage, cracks, broken bolts, or measurable section loss due to corrosion (note the location and depth), decay, or spalling.
4. Bridge rail length with damage in locations or quantity and has reduced the structural capacity of the rail. Structural analysis is warranted or has determined repairs are essential to restore the full capacity of the element.

## 4.11 Pedestrian Rail

A pedestrian rail will typically be on the outside of a sidewalk and protected from traffic by a Bridge Rail.

---

### 340 Metal Pedestrian Rail Units – LF

---

This element defines all types and shapes of metal pedestrian bridge railing including steel (excluding weathering steel), aluminum, metal beam, rolled shapes, etc.

The quantity should equal the total length measured along each pedestrian rail within the limits of the bridge which includes rail attached to structural bridge members such as a wing wall or approach slab.

---

### 341 Concrete Pedestrian Rail Units – LF

---

This element defines all types and shapes of reinforced concrete pedestrian bridge railing. The quantity should equal the total length measured along each pedestrian rail within the limits of the bridge which includes rail attached to structural bridge members such as a wing wall or approach slab.

---

### 342 Timber Pedestrian Rail Units – LF

---

This element defines all types and shapes of timber pedestrian bridge railing. All elements of this rail (except connectors) must be timber. The quantity should equal the total length measured along each pedestrian rail within the limits of the bridge which includes rail attached to structural bridge members such as a wing wall or approach slab.

---

### 343 Other Pedestrian Rail Units – LF

---

This element defines all types and shapes of pedestrian bridge railing except those defined as METAL, CONCRETE or TIMBER. This element will include cable rails, and combinations of materials. The quantity should equal the total length measured along each pedestrian rail within the limits of the bridge which includes rail attached to structural bridge members such as a wing wall or approach slab.

#### Condition States for WSDOT Elements 340, 341, 342, and 343

1. Defects are superficial and have no effect on the structural capacity of the element.
2. Pedestrian rail length with a repair.
3. Pedestrian rail length with structural defects. The defects do not significantly affect structural capacity. Deficiencies do not warrant analysis, but may require repairs. Structural deficiencies are not limited to impact damage, cracks, broken bolts, or measurable section loss due to corrosion (note the location and depth), decay, or spalling.
4. Pedestrian rail length with damage in locations or quantity and has reduced the structural capacity of the rail. Structural analysis is warranted or has determined repairs are essential to restore the full capacity of the element.



## 4.12 Smart Flags

---

### 355 Damaged Bolts or Rivets Units – EA

---

This smart flag is used to identify superstructure steel elements that have broken or missing bolts and/or rivets. Report one unit for each occurrence in the corresponding condition state.

1. Number of damaged, missing, or loose bolts or rivets in secondary member(s).
2. Number of damaged, missing, or loose bolts or rivets has been replaced.
3. Number of damaged, missing, or loose bolts or rivets in a primary member(s).

---

### 356 Steel Cracking Units – EA

---

This smart flag is used to identify superstructure steel elements with cracks. Report one unit for each occurrence (or crack) in the corresponding condition state. If fatigue damage exists, which may warrant analysis of the element or the serviceability of the element is uncertain, contact a supervisor immediately.

1. Number of steel cracks, of any length, in a secondary member(s).
2. Number of steel cracks within a load path that have been repaired or arrested. The bridge may still be prone to fatigue.
3. Number of steel cracks within a load path that are not arrested and less than 1 inch. Any cracks (typically cope cracks) on WSDOT bridges must be repaired accordance with WSDOT Bridge Preservation Office procedures.
4. Number of steel cracks within a load path that are not arrested and 1 inch or greater in length. Any cracks (typically cope cracks) on WSDOT bridges must be repaired accordance with WSDOT Bridge Preservation Office procedures.

---

### 357 Pack Rust Units – EA

---

The primary purpose of this smart flag is to quantify steel connections where rust expansion is visually deflecting steel plates and should be addressed when the bridge is painted. Structural impacts to pack rust overstressing are recorded in the steel elements. The total quantity is the number of existing pack rust locations identified by the inspector.

1. Number of locations where visible pack rust exists and is less than ¼ inch thick.
2. Number of locations where pack rust is more than ¼ inch thick.

---

**360 Bridge Movement****Units – EA**

---

The primary purpose of this smart flag is to identify structural movement that is causing significant distress to the bridge. Movements may be horizontal, vertical, or rotational. Evidence of movement should be documented (photo) in such a way that future measurements can determine if the structure is still moving or has stabilized.

1. The entire bridge appears to have stabilized due to repairs or recent history of measurements. Tilt meters, piezometer tubes, or monitoring system show no movement in the past two years.
2. Bridge elements are moving but do not cause a significant problem for the bridge. Bearings may be approaching design limits. Substructure elements may be moving.
3. Bridge movement is at or beyond design limits. Investigation and repair analysis of the bridge is warranted.

---

**361 Scour****Units – EA**

---

This element is used to identify foundation scour for bridges crossing waterways as observed during inspections. Its primary purpose is to identify bridge piers or abutments that are subject to scour and to provide some measure of the magnitude of that scour. Piers in normal high water are typically considered for this element but there are instances where piers above high water may be subject to scour. Maintain historical information related to scour documented in previous inspections such as measurements and/or comments of exposed footings.

1. Number of pier/abutment foundations where no Scour exists, or where scour is superficial and has no effect on the foundations structural capacity.
2. Number of pier/abutment foundations where scour has been mitigated and the repair is functioning and in place as designed. Evaluate and comment on any riprap or other scour countermeasures that are in place.
3. Number of pier/abutment foundations where scour exists. The scour does not significantly affect the foundations structural capacity. Scour does not warrant analysis, but may require repairs. If left unchecked, could adversely impact the foundations structural capacity.

Scour at this level should not impact the NBI Substructure Overall rating code, item 060 (WSBIS Item 1676).

Examples:

- Top of spread footings are exposed due to scour.
- Bottom of pile caps are exposed due to scour.
- Minimum known pile embedment is between 5' and 10'.

4. Number of pier/abutment foundations with scour damage in significant locations or quantity and has reduced the foundations structural capacity. Structural analysis is warranted. Repair and or action are required to protect exposed foundation and to restore capacity to the pier.

Scour at this level may impact the NBI Substructure Overall rating code, item 060 (WSBIS Item 1676). A comment is necessary if the NBI Substructure Overall rating code is lowered.

Examples:

- Undermining of spread footings or foundation material is occurring.
- Minimum pile embedment is less than 5'. Make a recommendation to evaluate the exposed pile for lateral stability.
- Pile cap is undermined and piles are exposed due to scour.

---

|            |                      |                   |
|------------|----------------------|-------------------|
| <b>362</b> | <b>Impact Damage</b> | <b>Units – EA</b> |
|------------|----------------------|-------------------|

---

This is a smart flag used to identify damage caused by impact from traffic or other causes such as flood debris. A maximum of 1 unit can be coded in each condition state.

1. Impact damage has occurred. None of the prestressed system is exposed. Repair, patching, or heat straightening is not required.
2. Impact damage has been repaired or patched. Any damage to a prestressed system has been repaired and patched. Steel elements have been repaired and painted.
3. Impact damage has occurred. Any prestressed system exposure is due to a traffic impact, but is not impaired. Patching concrete or heat straightening of steel is needed.
4. Impact damage has occurred and strength of the member is impaired. Analysis is warranted to ascertain if the member can be repaired or needs to be replaced.

---

|            |                                          |                   |
|------------|------------------------------------------|-------------------|
| <b>366</b> | <b>Undercrossing – Safety Inspection</b> | <b>Units – EA</b> |
|------------|------------------------------------------|-------------------|

---

This is a smart flag for safety checks of structures where Washington is not the Custodian (NBI Item 21) such as Railroad and other non-vehicular undercrossings. No other core elements are needed.

1. Report the entire bridge in condition state one (EA).

---

|            |                       |                   |
|------------|-----------------------|-------------------|
| <b>367</b> | <b>Movable Bridge</b> | <b>Units – EA</b> |
|------------|-----------------------|-------------------|

---

This is a smart flag to identify movable bridges. WSDOT elements will be used in addition to this smart flag.

1. A Movable bridge with elements that do not require repair (EA).
2. A Movable bridge with elements that require repair (EA).

**368 Seismic Pier Crossbeam Bolster****Units – EA**

This element identifies concrete piers with seismic structural improvements.

1. Number of piers with a crossbeam bolster.

**369 Seismic Pier Infill Wall****Units – EA**

This element identifies concrete piers with seismic structural improvements.

1. Number of piers with a seismic pier infill wall.

**4.13 Seismic Restrainers**

Earthquake restrainers have been installed on WSDOT bridges since the 1980s. The typical longitudinal restrainer uses epoxy coated Dywidag bars with a designed gap maintained by double nuts. An earlier system using springs to maintain the required restrainer gap was used until the early 1990s when it was discontinued as being ineffective. Gap measurements are required during an inspection if visual inspection or loose double nuts indicate the gaps are not uniform.

**370 Seismic – Longitudinal Restrainer****Units – EA**

This element is used to identify longitudinal seismic restrainers. When an in-span hinge separates two structures, the joint, bearing, and seismic restrainers at the hinge will be documented in the dependent (or supported) structure only. The quantity should equal the total number of longitudinal restrainers on the bridge.

**371 Seismic – Transverse Restrainer****Units – EA**

This element identifies existing bridges that have been retrofitted or newer structures that have been equipped with transverse restrainers designed to restrain transverse movement during a seismic event. The quantity should equal the total number of transverse restrainers on the bridge. When an in-span hinge separates two structures, the joint, bearing, and seismic restrainers at the hinge will be documented in the dependent (or supported) structure only. Concrete girder stops located at the ends of girders attached to the abutment or intermediate pier caps/crossbeams provide lateral restraint however it is not the intention to include these in with this element.

**372 Seismic – Link/Pin Restrainer****Units – EA**

This element is used to identify link/pin seismic restrainers. When an in-span hinge separates two structures, the joint, bearing, and seismic restrainers at the hinge will be documented in the dependent (or supported) structure only. The quantity should equal the total number of link/pin restrainers on the bridge.

**Condition States for WSDOT Elements 370, 371, and 372**

1. Restrainer is in good condition and will function as designed. Anchor plate nuts have been checked and are in good condition.
2. Number of restrainers with misaligned seismic-longitudinal restrainer rods. Anchor plate nuts that are tight, but that have epoxy running down their bolts or are of varying lengths. The gap between adjacent longitudinal restrainers varies between  $\frac{1}{4}$  inch and  $\frac{3}{4}$  inch. Short transverse pipe restrainer length. Measure the depth of the diaphragm hole to the restrainer. Take a picture of the hole and tape measure.
3. Number of restrainers with improper anchor plate installation. Loose or inadequately bonded anchor nuts. A repair is warranted if over 25 percent of the anchor nuts have more than 2 inches of bolt thread exposed below the nut. Restrainer gap variation in a series of longitudinal seismic restrainers is greater than  $\frac{3}{4}$  inches (measure and add the two gap distances on both sides of each restrainer in making your comparisons). Loose double nuts. Specify the replacement of the double nuts with (new) nuts having (with) setscrews and the resetting of the restrainer gaps according to the design tables. The inspector shall specify the required gaps, according to the bridge plans, in the repair.

**373 Seismic – Catcher Block****Units – EA**

This element is used to identify a catcher block attached to a pier or abutment installed as part of a seismic retrofit. The quantity should equal the total number of catcher blocks on the bridge.

1. Number of catcher blocks in good condition.
2. Number of catcher blocks with deficiencies that need correction.

**374 Seismic - Column Silo****Units – EA**

I-5 N-N RAMP OVER I-5 - 5/628N-N - 0016991A



This element is used to identify when a column has been designed to be isolated from the surrounding soil during a seismic event. This will usually consist of a corrugated metal pipe buried in the ground with a cap at the base of a column. The inspection note needs to identify the individual columns that are siloed along with the planned depth (relative to an identifiable elevation) at each one. In cases with small numbers of siloed columns, that could be done in the note. In other situations, a spreadsheet attached as a file or something similar may be useful. In-depth inspections at 12-year intervals are required to confirm the system condition and functionality. In-depth inspection may require means (equipment and manpower) to open and then reclose/reseal the capping system along with tools to measure the silo depth and to roughly assess column and silo condition below the capping system. Each bridge with siloed columns may require an individual in-depth inspection procedure.

1. Silo capping system is intact as designed and is accessible with no visible deterioration.
2. Minor deterioration of silo capping system elements such as hardware corrosion, visible seal deterioration, access hardware broken/missing.
3. Capping system has been buried and is not visible for inspection. (write repair – priority 2 or higher)
4. Capping system has failed allowing solid foreign material to enter the intended gap and potentially restrict column movement. (write repair – priority 1)

**375 Cathodic Protection****Units – EA**

This is a smart flag used to identify a cathodic protection system used on a bridge. The quantity should equal the total number of cathodic protection systems on the bridge.

1. Code 1 if the cathodic protection system is functioning as designed.
2. Code 1 if the cathodic system is no longer functioning as designed.

**376 Concrete Deck Delamination Testing****Units – SF**

This flag provides a snapshot of deck testing and must be included in the evaluation of a concrete deck and overlay. ASTM4580, Chain Drag Testing will locate and quantify the patches, spalls, delaminations not visible to the inspector and other defects on the entire top surface of the bridge deck. This information is supplemental to the deck/overlay elements and the quantities do not change. For Washington State bridges, the BMS engineer will provide the condition state quantities and notes for this element based on a Chain Drag Report produced by Design or Construction.

For decks covered with an Asphalt Overlay, the 376 data will be updated each time the asphalt is removed from the concrete surface and must be used to evaluate the deck element even though defects are not visible to the inspector. This information does not expire and the element must not be deleted from the report unless the deck is replaced or new information is provided.

1. Deck area with no delaminations.
2. For decks covered with asphalt, this quantity of patching must be recorded in the Deck CS2 and used to evaluate the deck. Do not include this quantity in the evaluation of a bare deck.
3. For decks covered with asphalt, this quantity of spalling must be recorded in the Deck CS3 and used to evaluate the deck. Do not include this quantity in the evaluation of a bare deck.
4. For concrete decks and concrete overlays, the CS4 delamination quantities must be applied to the deck/overlay element CS4. If the Chain Drag Report is more than 10 years old, then the 376 element is deleted from the report because the test results are no longer accurate and also must be removed from the evaluation of the deck/overlay element. If a Chain Drag was completed before the concrete overlay was constructed, then the 376 element must be deleted from the report since patching and delaminations are addressed during the construction.

**380 Unknown Foundation Units****Units – EA**

This element has been discontinued and is no longer available for use. Migrate any notes that pertain to this element to an appropriate alternative element.

## 4.14 Expansion Joint Elements

The expansion joint condition states are designed to track the criteria associated with joint structural failure such as spalling, patches, and other structural problems. A spall within 1'-0" of a joint system should be considered a joint spall and not included with the deck spalling. Spalls next to the joint are a joint deficiency rather than deck deterioration.

Missing or defective joint glands are not considered structural joint failures in the joint condition states. Some joints are designed to pass water and many joints leak within days of installation. If the joint seal leakage is causing structural problems with elements below the joint, this should be noted in the report and a repair should be recommended. A smart flag or element may be used to track this deterioration in the future, but it is not included in the joint condition states at this time.

If any portion of a joint falls into a lower condition state, code the entire length of the joint in the lower condition state. Joints with structural defects are coded in CS2. Joints that require replacement are tracked in CS3. In general, joints in Condition State 3 will be programmed for rehabilitation or replacement.

When the entire joint is replaced with a new joint system, change the WSDOT element to the new joint type. Do not use more than one WSDOT element for a joint location, unless the structure has been widened and there are two joint systems present. Joint notes should reference specific joints by pier or span number.

When an in-span hinge separates two structures, the joint, bearing, and seismic restrainers at the hinge will be documented in the dependent (or supported) structure only.

---

### 400 Asphalt Butt Joint Seal Units – LF

---

This element defines a butt joint between concrete and asphalt pavement that is an asphalt sawcut filled with hot poured rubber. This joint is shown in WSDOT Standard Plan A-40.20, Bridge Paving Joint Seals, Detail 3 or 4. This element shall also be apply for a butt joint at the end of the approach slab to extend the life of the asphalt. The quantity should equal the length measured along the joint.

1. The expansion joint is functioning as designed. Joint may not be perfect with signs of leakage. The adjacent concrete or asphalt is sound.
2. Skewed joint length at each location. "D" spalls or patches are present in the header or in the concrete within one foot of either side of the joint but no more than 10 percent of the length.
3. Skewed joint length at each location with the following typical criteria: When the concrete or asphalt must be rebuilt to maintain a reliable roadway surface; More than 10 percent of the joint length has spalls or patches adjacent to the seal; Asphalt was placed without a sawcut or the sawcut was not in the proper location.



---

**401 Asphalt Open Joint Seal****Units – LF**

---

This element represents a sealed and sawcut contraction joint or a asphalt joint in bridge paving over an open concrete joint in a bridge deck or truss panel joint, as shown in WSDOT Standard Plan A-40.20, Bridge Paving Joint Seals, Detail 1, 2, 5, or 6 . The joint consists of hot poured rubber placed in an open concrete joint and a membrane may or may not exist. After the asphalt is placed, a sawcut is placed over the concrete joint and the gap filled with hot poured rubber. WSDOT Elements 402 - Open Concrete Joint and 420 - Joint Paved Over flag do not apply at these locations. The quantity should equal the length measured along the joint.

WSDOT Element 420 - the Joint Paved Over flag does apply for all locations of a buried steel joint due to the risk of planing equipment damaging the bridge deck.

1. The expansion joint is functioning as designed. Joint may not be perfect with signs of leakage. The adjacent concrete or asphalt is sound.
2. Skewed joint length at each location. “D” spalls or patches are present in the header or in the concrete within one foot of either side of the joint but no more than 10 percent of the length.
3. Skewed joint length at each location with the following typical criteria: When the concrete or asphalt must be rebuilt to maintain a reliable roadway surface; More than 10 percent of the joint length has spalls or patches adjacent to the seal; Asphalt was placed without a sawcut or the sawcut was not in the proper location.

**402 Open Concrete Joint**

**Units – LF**

This element defines a joint designed to have concrete edges at the joint opening in a concrete wearing surface. The original design is usually filled with hot poured rubber or pre-molded joint filler and the design materials may or may not be present. This joint is typical for panel joints at a truss floorbeam, interior joints on older bridges, and at the concrete roadway/approach slab joint. At the back-of-pavement seat, if a compression seal has been removed and replaced with Hot Poured Rubber (crack sealant), then quantities for the 402 element apply and the quantities for the compression seal must be reduced. The quantity should equal the length measured along the expansion joint.

This joint must not be confused with: WSDOT Element 403 - Concrete Bulb-T joint, WSDOT Elements 405 or 406 Compression Seals with the seal missing, or WSDOT Element 417 - Rapid Cure Silicone (RCS) joint.

1. The expansion joint is functioning as designed. Joint may not be perfect with signs of leakage. The adjacent deck or header is sound.
2. Skewed joint length at each location with “D” spalls or patches are present in the header or in the deck within one foot of either side of the joint.
3. Skewed joint length at each location where the deck or headers must be rebuilt to maintain a reliable roadway surface. As a guideline, more than 25 percent of the joint length has spalls or patches in the deck or headers adjacent to the seal.



A repair to reseal the joints is required for bridges at each steel floorbeam where water is corroding the top flange and/or connections.

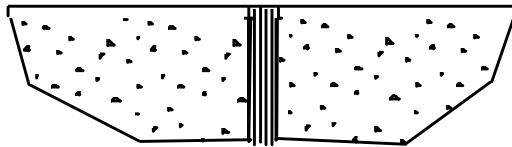

**403 Concrete Bulb-T**

**Units – LF**

This element defines a joint formed to accept a Bulb-T preformed seal. The seal may be missing or other materials present to provide a seal. The quantity should equal the length measured along the expansion joint.

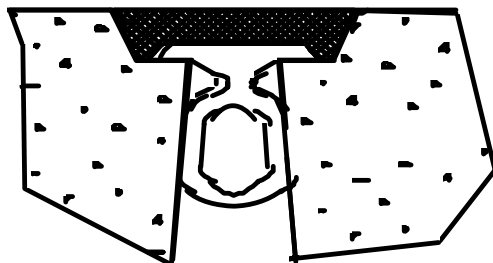

**404 Compression Seal/Concrete Header**

**Units – LF**

This element defines a joint with concrete headers formed during the original construction of the bridge. The joint is filled with a pre-formed compression type seal. The quantity should equal the length measured along the expansion joint.

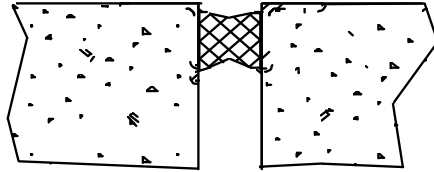

**405 Compression Seal/Polymer Header**

**Units – LF**

This element defines those joints that have been rehabilitated with a polymer header and filled with a pre-formed compression type seal. The quantity should equal the length measured along the expansion joint.

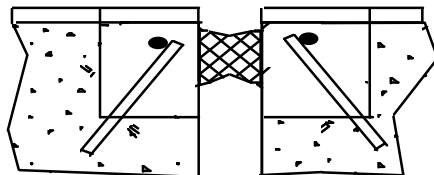

**406 Compression Seal/Steel Header**

**Units – LF**

This element defines a joint with steel angle plate headers that have a pre-formed compression type seal. The quantity should equal the length measured along the expansion joint.

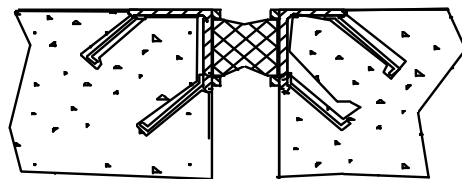

**407 Steel Angle Header**

**Units – LF**

This element defines an open joint with steel angle plate headers. The quantity should equal the length measured along the expansion joint.

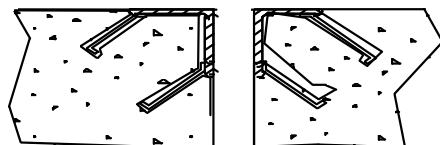

---

**408 Steel Sliding Plate**

**Units – LF**

This element defines a joint with steel sliding plates. The quantity should equal the length measured along the expansion joint.

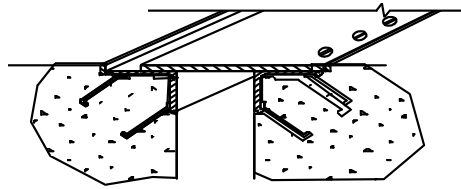

---

**409 Steel Sliding Plate w/Raised Bars**

**Units – LF**

This element defines a joint with steel sliding plates and steel raised bars welded to the plates to accommodate an overlay. The quantity should equal the length measured along the expansion joint.

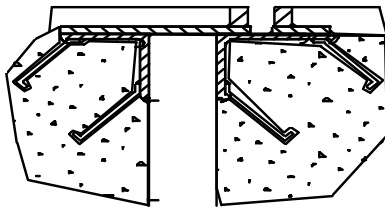

---

**410 Steel Fingers**

**Units – LF**

This element defines a joint with open steel fingers. The quantity should equal the length measured along the expansion joint.

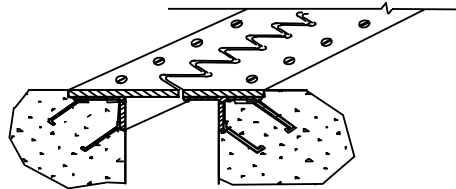

**411 Steel Fingers w/Raised Bars****Units – LF**

This element defines a joint with bars or plates welded to the steel finger plates to accommodate an overlay. The quantity should equal the length measured along the expansion joint.

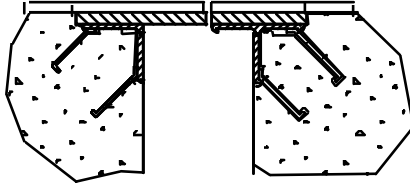
**412 Strip Seal – Anchored****Units – LF**

This element defines an expansion joint that uses a neoprene type waterproof gland with steel extrusion or other system to anchor the gland. The steel extrusion is anchored into the concrete deck or header. The quantity should equal the length measured along the expansion joint.

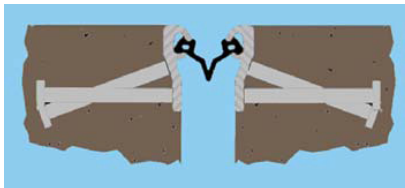
**413 Strip Seal – Welded****Units – LF**

This element defines an expansion joint that uses a neoprene type waterproof gland with steel extrusion or other system to anchor the gland. The steel extrusion is welded to a pre existing steel expansion joint. The quantity should equal the length measured along the expansion joint.

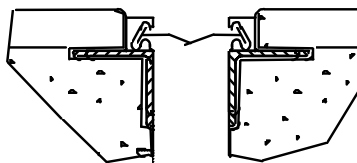

**414 Bolt Down – Sliding Plate w/springs****Units – LF**

This element defines a bolted sliding plate expansion joint that uses steel springs. The quantity should equal the length measured along the expansion joint.

**Condition States for WSDOT Elements 403,404, 405, 406, 407, 408, 409, 410, 411, 412, 413, and 414**

1. The expansion joint is functioning as designed. Joint may not be perfect with signs of leakage. The adjacent deck or header is sound.
2. Skewed joint length at each location with “D” spalls or patches present in the header or in the deck within one foot either side of the joint.
3. Skewed joint length at each location where the deck or headers must be rebuilt to maintain a reliable roadway surface or to maintain seal placement. As a guideline, more than 25 percent of the joint length has spalls or patches in the deck or headers adjacent to the seal.

Steel Materials: Steel components are banging, cracked, loose, broken, or missing. Steel sections that have been removed and/or replaced with something else (usually concrete patching) should be CS3.

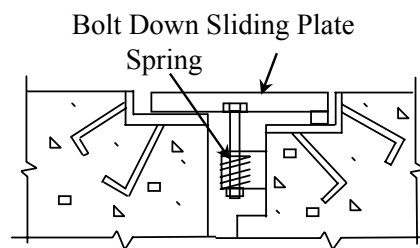

**415 Bolt Down Panel – Molded Rubber****Units – LF**

This element defines an expansion joint that uses a waterproof gland that is held in place by molded rubber panels that are attached with bolts. The quantity should equal the length measured along the expansion joint.

1. The expansion joint is functioning as designed. Joint may not be perfect with signs of leakage. The adjacent deck or header is sound. Molded Rubber panels are secure and have no defects.
2. Skewed joint length at each location with “D” spalls or patches present in the header or in the deck within one foot either side of the joint. Some of the bolts may be broken but they represent less than 10 percent of the total for that panel.
3. Skewed joint length at each location where more than 10 percent of the bolts in a panel are missing, loose, or broken. As a guideline, more than 25 percent of the joint length has spalls or patches in the deck or headers adjacent to the seal

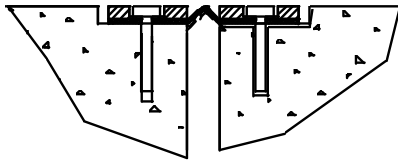
**416 Assembly Joint Seal (Modular)****Units – LF**

This element defines a large movement joint that has an assembly mechanism with multiple neoprene type waterproof glands. The quantity should equal the length measured along the expansion joint.

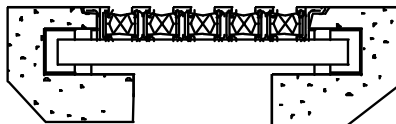

**417 Silicone Rubber Joint Filler**

**Units – LF**

This element defines an expansion joint that has been repaired with a single or two component rubber joint filler. The quantity should equal the length measured along the expansion joint.

**Condition States for WSDOT Elements 416 and 417**

1. The expansion joint is functioning as designed. Joint may not be perfect with signs of leakage. The adjacent deck or header is sound.
2. Skewed joint length at each location with “D” spalls or patches present in the header or in the deck within one foot either side of the joint.
3. Skewed joint length at each location where the deck or headers must be rebuilt to maintain a reliable roadway surface or to maintain seal placement. As a guideline, more than 25 percent of the joint length has spalls or patches in the deck or headers adjacent to the seal.

Steel Materials: Steel components are banging, cracked, loose, broken, or missing. Steel sections that have been removed and/or replaced with something else (usually concrete patching) should be CS3.

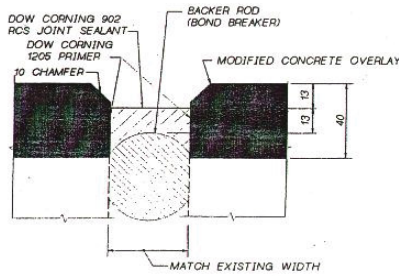

**418 Asphalt Plug**

**Units – LF**

This element defines an expansion joint that has been replaced with an asphalt plug system. The quantity should equal the length measured along the expansion joint.

1. The expansion joint is functioning as designed. Joint may not be perfect with signs of leakage. The adjacent deck or header is sound.
2. Skewed joint length at each location with rutting in the joint is minor. “D” spalls or patches are present in the joint, or in deck adjacent to joint.
3. Skewed joint length at each location where the asphalt material in the joint has significant rutting, bulging or is missing. As a guideline, more than 25 percent of the joint length has spalls or patches in the deck or headers adjacent to the seal.

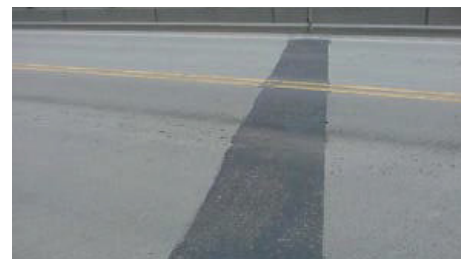
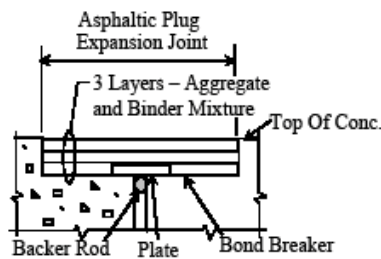



**419 Steel Angle w/Raised Bars****Units – LF**

This element defines a joint with steel angles and steel raised bars welded to the angles to accommodate an overlay. The quantity should equal the length measured along the expansion joint.

1. The expansion joint is functioning as designed. Joint may not be perfect with signs of leakage. The adjacent deck or header is sound.
2. Skewed joint length at each location with “D” spalls or patches present in the header or in the deck within one foot either side of the joint.
3. Skewed joint length at each location where the deck or headers must be rebuilt to maintain a reliable roadway surface or to maintain seal placement. As a guideline, more than 25 percent of the joint length has spalls or patches in the deck or headers adjacent to the seal.

Steel Materials: Steel components are banging, cracked, loose, broken, or missing. Steel sections that have been removed and/or replaced with something else (usually concrete patching) should be CS3.

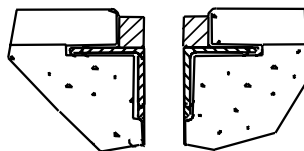
**420 Joint Paved Over Flag****Units – LF**

This element identifies when a steel joint system that has been paved over with asphalt. This is a high risk to damaging the steel joint or bridge deck by the paving operations. When this flag is used, a cost for joint work will be included in the next paving contract to correct the problem. Since the joint cannot be inspected, the joint element condition states should remain unchanged (and so noted). Some steel joints may have more than 2.5” of asphalt may not require rehabilitation. The Total quantity will be the sum total length of all joint systems on the bridge.

1. Skewed joint length at each location that is paved over, but rehabilitation is not required.
2. Skewed joint length at each location that requires rehabilitation. A photo is helpful to determine the type of rehabilitation.

## 4.15 Movable Bridges

| <b>501 Movable Bridge Steel Tower</b> | <b>Units – LF</b> |
|---------------------------------------|-------------------|
|---------------------------------------|-------------------|

This element defines the structural steel columns and members used to support a counter weight of a vertical lift span. The total quantity is the total of the supporting column lengths.

1. Defects are superficial and have no effect on the structural capacity of the element.
2. Tower column length with repairs such as: bolts or rivets have been replaced; cracks that have been drilled or plated.
3. Tower column length with structural defects. The defects do not significantly affect structural capacity. Deficiencies do not warrant analysis, but may require repairs.
4. Tower column length affected by damage in locations or quantity and has reduced the structural capacity of the column or the tower. Structural analysis is warranted or has determined repairs are essential to restore the full capacity of the element. Structural deficiencies are not limited to impact damage, corrosion, a crack in primary load path member or in the attachment welded to primary member. Retain the quantity of the element reported in CS4 if the element is repainted but not repaired.

## 4.16 Other Bridge Elements

| <b>705 Bridge Luminaire Pole and Base</b> | <b>Units – EA</b> |
|-------------------------------------------|-------------------|
|-------------------------------------------|-------------------|

This element is defined by a light pole and anchor system attached to a bridge. It does not include the mast arm or other types of lights that may be attached to the bridge. The condition states describe the structural condition of the pole, anchor bolts, and support. WSDOT Region maintenance may need to be contacted prior to inspection in order to remove bolt covers or otherwise provide access for inspection. The total element quantity should equal the number of luminaire poles attached to the bridge.

1. There are no significant structural defects in the pole or support, and the grout pad is solid. Poles or supports that have been replaced are coded in this condition state.
2. Number of poles where structural inspection requires special equipment to access.
3. Number of poles with structural defects. The defects do not significantly affect the structural capacity.
4. Number of poles affected by damage in locations or quantity and has reduced structural capacity. Structural analysis is warranted or has determined repairs are essential to restore the full capacity of the element. Visual inspection indicates a base plate that is not supported by leveling nuts.

---

**710 Bridge Mounted Sign Structures****Units – EA**

---

This element defines bridge mounted sign structures anchored to the bridge. This includes signs mounted to the outside face of the bridge or over the deck using a beam, truss, or cantilevered support. The condition states address any physical damage defects with the sign or its anchorage and the inventory status of the sign. The inventory status may be determined by the presence of a “Bridge Preservation Sign Structure Identification Tag”. The quantity should equal the number of signs mounted to the bridge.

1. The sign has been inventoried and has the appropriate identification tag. The sign, support, and anchorage are in good condition with no significant structural defects.
2. The sign has not been inventoried. The sign, support, and anchorage are in good condition with no apparent defects. The sign bridge engineer should be notified.
3. The sign may or may not have been inventoried and has defects to the structure or anchorage but is safe and structural capacity has not been significantly reduced. This may include loose, missing or damaged bolts, or hardware within the sign structure where redundant framework or hardware prevents the identified defects from creating an immediate hazard. Anchorage defects may include corrosion or cracks; grout may be loose or missing. A repair should be written and the sign bridge engineer notified.
4. The sign may or may not have been inventoried. Defects to the structure or anchorage threaten or have reduced the structural capacity. This may include loose, missing or damaged bolts, or hardware in multiple locations, and cracks within structural sections. Anchorage defects may include loose, missing or broken hardware, broken or delaminating anchor locations, or loss of embedment due to creep or pull out. An emergent repair should be specified with written notification to region maintenance and the sign bridge engineer.

## 4.17 WSDOT Bridge Deck Overlay Elements

WSDOT categorizes overlays in to two different types. The first type consists of Asphalt Concrete Pavement (ACP) and Thin Overlays, are a deck protection systems intended to prolong the life of the deck by removing the traffic wear from the surface of the concrete deck. The second type is a Concrete Overlay which is intended to rehabilitate the deck and provide a new concrete wearing surface.

ACP Overlays are represented by the WSDOT element 800 can generally be identified in the field where as WSDOT element 801 represents asphalt with a membrane that is not visible. Thin overlays may be identified in the field if the system has failed and chunks are missing. Deterioration of the ACP and thin overlays is not generally associated with the deterioration of the deck. The ACP may be replaced several times without exposing the concrete deck and the condition states for the deck and overlay elements are independent and DIFFERENT. Paving contracts attempt to repair all concrete spalls and delaminations on WSDOT bridges before placing the overlay. If the area of patching/spalls/delams is known, then the quantity should be noted and recorded in the WSDOT concrete deck element as CS2, CS3 or CS4 respectively; while the Overlay quantities of CS2 and CS3 are based on the visible inspection of the surface. In a similar fashion, if a new Bituminous Surface Treatment (BST) has been applied to an asphalt surface, then the overlay element CS2 and CS3 are equal to zero.

---

|            |                                      |                   |
|------------|--------------------------------------|-------------------|
| <b>800</b> | <b>Asphalt Concrete (AC) Overlay</b> | <b>Units – SF</b> |
|------------|--------------------------------------|-------------------|

---

This element defines an Asphalt Concrete (AC) bridge deck overlay, with or without a Bituminous Surface Treatment (BST). The quantity should equal the overlay's width times the length.

---

|            |                                                                  |                   |
|------------|------------------------------------------------------------------|-------------------|
| <b>801</b> | <b>Asphalt Concrete (AC) Overlay With Waterproofing Membrane</b> | <b>Units – SF</b> |
|------------|------------------------------------------------------------------|-------------------|

---

This element defines an asphaltic concrete with waterproofing membrane bridge deck overlay. The quantity should equal the overlay's width times the length.

---

|            |                             |                   |
|------------|-----------------------------|-------------------|
| <b>802</b> | <b>Thin Polymer Overlay</b> | <b>Units – SF</b> |
|------------|-----------------------------|-------------------|

---

This defines a thin polymer bridge deck overlay that is less than or equal to 0.5 inches in thickness (i.e., epoxy, methyl-methacrylate). The quantity should equal the overlay's width times the length.

**Condition States for WSDOT Elements 800, 801, and 802**

1. Defects are superficial. The deck surfaces have no spalls/delaminations or previous repairs. The deck surfaces may have cracking.
2. Total area of overlay patches.
3. Total area of overlay spalls or potholes. Thin Polymer Overlays (802) may have visible delaminations and should be considered as spalls and coded in CS3.

Concrete Overlay elements are difficult to discern in the field and are identified in special provisions or Plans. When constructing modified concrete overlays, the material removed by the deck preparation (spalls and delams) is replaced with the overlay material. WSDOT considers this construction deck rehabilitation; or in other words, the concrete overlay and deck are monolithic. Therefore, CS2 and CS3 for the deck and concrete overlay will be the SAME. All defects noted in the concrete overlay (SF) apply to the deck. It is not uncommon to have the overlay break up when there is a problem in the deck below it.

---

|            |                                  |                   |
|------------|----------------------------------|-------------------|
| <b>803</b> | <b>Modified Concrete Overlay</b> | <b>Units – SF</b> |
|------------|----------------------------------|-------------------|

---

This defines a rigid modified concrete bridge deck overlay that is normally 1.5 inches or greater in thickness (i.e., Latex (LMC), Microsilica (MMC), Fly Ash (FMC)). The quantity should equal the overlay's width times the length.

---

|            |                                   |                   |
|------------|-----------------------------------|-------------------|
| <b>804</b> | <b>Polyester Concrete Overlay</b> | <b>Units – SF</b> |
|------------|-----------------------------------|-------------------|

---

This defines a rigid polyester concrete bridge deck overlay that is normally 0.75 inches in thickness. The quantity should equal the overlay's width times the length.

**Condition States for WSDOT Elements 803 and 804**

1. Defects are superficial. The deck surfaces have no spalls/delaminations or previous repairs. The deck surfaces may have hairline cracks or rock pockets.
2. Concrete overlay area with repairs or patches. Do not include the rare cases of rutting that has been filled with patching material.
3. Concrete overlay area with spalling.
4. Record the delaminated area (CS4) from WSDOT element 376 in the overlay CS4. If new delaminations are found, do not add delaminations found in the field unless approved by Bridge Management. Chain Drag testing by the Bridge Inspector must chain the entire deck, record the results in a Chain Drag Report available on the Bridge Website under Bridge Overlays, and send the file to Bridge Management.

---

**805 AC Over a Polymer Overlay** **Units – SF**

---

This defines an asphaltic concrete applied over a thin polymer bridge deck overlay (i.e., epoxy, methyl-methacrylate). The quantity should equal the overlay's width times the length.

1. Defects are superficial. The deck surfaces have no spalls/delaminations or previous repairs. The deck surfaces may have cracking.
2. ACP overlay area with patches.
3. ACP overlay area with spalls or potholes.

---

**806 BST on Concrete (Chip Seal)** **Units – SF**

---

This defines a Bituminous Surface Treatment (BST), or commonly known as a chip seal, mistakenly applied directly on a concrete deck **and is to be removed**. This severely limits the inspection of the deck. Code the area of BST covering the concrete deck in CS1.

**Note:** Element 800 or 801 is used when a chip seal is intentionally applied to a structure. WSDOT discontinued use of this element in the year 2012.

## 4.18 Protective Coatings

---

|            |                                    |                   |
|------------|------------------------------------|-------------------|
| <b>901</b> | <b>Red Lead Alkyd Paint System</b> | <b>Units – SF</b> |
|------------|------------------------------------|-------------------|

---

This paint protection system is a 3-coat alkyd system incorporating lead based paint. Use this paint element as a default if the paint was installed prior to 1991.

---

|            |                                          |                   |
|------------|------------------------------------------|-------------------|
| <b>902</b> | <b>Inorganic Zinc/Vinyl Paint System</b> | <b>Units – SF</b> |
|------------|------------------------------------------|-------------------|

---

This paint protection system consists of an inorganic zinc silicate shop applied primer system and a vinyl is paint applied after erection, cleaning, and spot priming.

---

|            |                                             |                   |
|------------|---------------------------------------------|-------------------|
| <b>903</b> | <b>Inorganic Zinc/Urethane Paint System</b> | <b>Units – SF</b> |
|------------|---------------------------------------------|-------------------|

---

This paint protection system consists of a inorganic zinc silicate shop applied primer system and an epoxy, aliphatic urethane paint system applied after erection, cleaning, and spot priming. This paint system is used on new WSDOT steel bridges.

---

|            |                                           |                   |
|------------|-------------------------------------------|-------------------|
| <b>904</b> | <b>Organic Zinc/Urethane Paint System</b> | <b>Units – SF</b> |
|------------|-------------------------------------------|-------------------|

---

This paint protection system is a 3-coat system incorporating an organic zinc primer, an epoxy second coat and a moisture cured urethane topcoat. Use this paint element as a default if the paint was installed after 1991.

---

|            |                                    |                   |
|------------|------------------------------------|-------------------|
| <b>905</b> | <b>Coal Tar Epoxy Paint System</b> | <b>Units – SF</b> |
|------------|------------------------------------|-------------------|

---

This paint protection system incorporates a coal tar epoxy based product.

### Condition States for WSDOT Elements 901, 902, 903, 904, and 905

1. The paint system is sound and functioning as intended to protect the metal surface.
2. Paint system area with chalking, peeling, curling or showing other early evidence of paint system distress, but there is no exposure of metal.
3. Paint system area that is no longer effective. The metal substrate is exposed.

---

|            |                   |                   |
|------------|-------------------|-------------------|
| <b>906</b> | <b>Metalizing</b> | <b>Units – SF</b> |
|------------|-------------------|-------------------|

---

This protection system consists of a sprayed coating of zinc or zinc/aluminum.

---

|            |                    |                   |
|------------|--------------------|-------------------|
| <b>907</b> | <b>Galvanizing</b> | <b>Units – SF</b> |
|------------|--------------------|-------------------|

---

This protection system consists of zinc applied to steel in a variety of spray-on methods.

---

|            |                                         |                   |
|------------|-----------------------------------------|-------------------|
| <b>908</b> | <b>Epoxy Paint for Weathering Steel</b> | <b>Units – SF</b> |
|------------|-----------------------------------------|-------------------|

---

This protection system consists of a clear epoxy coating applied to weathering steel to prevent excessive corrosion.

### Condition States for WSDOT Elements 906, 907, and 908

1. Protection system area that is sound and functioning as intended to protect the metal surface.
2. Protection system area with corrosion of the substrate metal.

**909 Zinc Primer****Units – SF**

This paint protection system consists of a zinc silicate shop applied primer system.

1. The paint system is sound and functioning as intended to protect the metal surface.
2. Protection system area with chalking, peeling, curling or showing other early evidence of paint system distress, but there is no exposure of metal.
3. Protection system area that is no longer effective. The metal substrate is exposed.

**910 Weathering Steel Patina****Units – SF**

This protection system consists of a chemical compound formed on the surface of weathering steel elements and is called the patina. When exposed to the atmosphere, weathering steel develops a patina, which seals and protects the steel from further corrosion. This oxide film is actually an intended layer of surface rust, which protects the member from further corrosion and loss of material thickness. The patina acts like a paint system to protect the steel. The color is an indicator of the condition of the patina may vary from orange to dark brown or purple-brown.

1. Weathering steel area that is chocolate brown or purple brown in color (boldly exposed) and in good condition. The patina is tightly adhered, capable of withstanding hammering or vigorous wire brushing. The patina system is sound and functioning to protect the metal surface.
2. Weathering steel color is yellow orange to light brown. Some areas may not have rust. Patina has a dusty to granular texture.
3. Weathering steel area that is black in color indicating non-protective patina. Area that remains damp for long periods of time due to rain, condensation, leaky joints, traffic spray or other source of moisture. Area where debris has accumulated on a horizontal surface and the steel is continuously wet. Area with a texture of large granules (greater than 1/8" diameter); flaking (greater than 1/4" diameter) or laminar rusting in thin sheets.

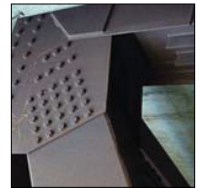



## 5.01 General

The National Bridge Inspection Standards (NBIS) requires a load rating be calculated for each reportable bridge\* as well as a scour evaluation for any reportable structure over water. Temporary structures that will be in service for more than 90 days shall be load rated as well as assessed for scour.

The load rating calculations and scour evaluations are a permanent part of the bridge file and are to be updated when the condition of the bridge changes. All load rating calculations and new and updated Scour analysis shall be stamped, signed, and dated by a registered professional engineer.

*\*Bridge is intended to mean all reportable structures which includes bridges, culverts and tunnels.*

## 5.02 Bridge Load Rating

Load rating of bridges shall be completed per Chapter 13 of the *Bridge Design Manual* (BDM) M 23-50 and the *AASHTO Manual for Bridge Evaluation* (MBE). See Chapter 13 of the BDM, Section 13.4 for summary sheets and information included in the Load Rating Report. See the appendix in the MBE for examples of load rating different types of structures. Newly discovered or transfer of ownership of bridges shall have load ratings completed and data entered into the inventory within 90 days.

### A. General Load Rating and Re-Rating Guidelines

- The Load rating of new bridges shall be completed within 90 days of opening the structure to the traveling public in the anticipated final configuration.
- The ratings of existing bridges shall be re-examined when the “Revise Rating Flag” is turned on. The condition of identified bridge elements shall be reviewed and the load ratings shall be updated if needed. In cases where the capacity of a member is reduced significantly, such as impact damage to a girder with loss of reinforcing or damage to steel members, ratings shall be updated within 30 days. In other cases such as increase in dead load, a preliminary assessment can be made based on the increase in dead load, condition of the structure and existing ratings. If in the engineer’s judgment, the ratings will not be affected significantly, and will not require a need to post or lower the load restriction on the bridge, ratings should be updated within 12 months, however, the decision and findings shall still be documented in the Load Rating File.

Load ratings of structures shall be reviewed and updated if necessary every 12 years. Factors to be reviewed to assess the need for updating the rating should be changes in the design code or changes in the load rating criteria as well as the criteria listed in Section B, below. For State bridges, a field in the load rating database with the initials of the reviewer and the date of the review shall be filled out.

For State owned bridges, the Risk Reduction Engineer shall provide a list of outstanding load ratings to the Bridge Preservation Engineer on a monthly basis. The list can be generated thru a query in the Load Rating database.

## **B. Bridge Load Rating Revision Criteria**

WSBIS Item 2688, Revise Rating should be coded as “Y” when one or more of the following items apply:

1. The Superstructure or Cross-beams/ Floor-beams Elements’ State condition changes from either Condition State 1, 2 or 3 to Condition State 4, or Superstructure or Substructure NBI code changed to 4 or less.
2. If the approach condition to the structure causes severe impact to the bridge, call for a high priority repair to fix the approaches so the transition onto the structure is smooth.
3. If the deck has potholes on the surface or at the joints, call for a high priority repair to patch the potholes in the deck at the joints.
4. The thickness of the overlay has increased.
5. The railing is replaced with a heavier traffic barrier.
6. New utilities such as water main or sewer line have been installed on the structure.
7. The number of striped lanes has increased on 2 line superstructure members such as trusses or 2-line girder bridge, and box girder bridges.
8. Damaged or deficient structural elements have been repaired/ replaced, such as replacement of timber caps or girders or replacement or repair of damaged girders due to high load hits or other deterioration.

When a deficiency is observed in the field such as rot pockets in timber or section loss in a steel member, the inspector should provide the following items to assist in providing accurate rating factors:

1. The description “shell thickness” shall state whether the thickness is all around the member or on one side and whether it is full depth and location.
2. Section loss in steel members shall include, if possible, the remaining section thickness, location of the section loss and required dimensions.

Provide a sketch of the deficient member and show deterioration as stated above and provide the dimensions of the deteriorated area. It is of great importance to provide as accurate information as possible instead of estimates. Posting or restricting a bridge is greatly dependent on this information.

## **C. Bridges With Unknown Structural Components**

For concrete and masonry bridges with no design plans, and when the necessary reinforcing details are unknown and cannot be measured, load capacity ratings may be determined based on field inspection by a qualified bridge inspector followed by evaluation by a qualified engineer. Such a bridge does not need to be posted for load restrictions if it has been carrying normal traffic for an appreciable period of time and shows no sign of distress; Reference the AASHTO Manual for Bridge Evaluation (MBE) second edition, Sections 6.1.4 and 6A.8.1. General rating guidelines for these structures are:

- Inventory rating shall be equal to the design truck at the time the bridge was constructed. Operating rating shall be equal to the inventory rating multiplied by 1.667.

- Legal trucks rating factors shall be equal to 1 when the Superstructure or Substructure NBI code is equal or greater than 5. Restriction of permit loads shall be assessed.
- Posting or restricting of a bridge shall be assessed when NBI condition rating of the superstructure or substructure is 4 or less or when there are signs of structural distress.

The Load Rating Methods WB1551 and WB1554 shall be coded as “ 0”, Administrative.

Full documentation for an administrative rating shall be placed in the bridge load rating file.

The table below shows typical design loads and the era they were utilized. The information in the table is based on State bridge inventory and it is dependent on the class of highway.

|       | <b>Design Load in Tons</b> | <b>Design Era</b>        |
|-------|----------------------------|--------------------------|
| H-10  | 10                         | Early 1900- mid 20's     |
| H-15  | 15                         | Mid 1910's-Mid 1960's    |
| H-20  | 20                         | Mid 1910's-1920's        |
| HS-15 | 27                         | Mid 1940's-Late 60's     |
| HS-20 | 36                         | Mid-1940's- Early 2000's |

\*Administrative ratings imply ratings based on Field evaluation and Documented Engineering Judgment.

#### **D. Data Management**

The WSBIS database shall be updated within 30 days from the completion and approval of a load rating of a structure.

#### **E. Posting Requirements**

Posting of a structure shall occur when the Operating rating factor for any of the legal loads is less than 1 based on the Load Factor or Allowable Stress Methods or the rating factor for any of the legal loads is less than 1 based on the Load and Resistance Factor Method.

Agencies generally post a bridge between the Inventory Rating and the Operating Rating using the Load Factor Method and Allowable Stress Methods. The minimum permissible posting value is three tons at inventory or operating levels. Bridges not capable of carrying a minimum gross live load of three tons shall be closed. The posted tonnage shall be the smaller of the rating factor for the specific truck times its weight or the gross vehicle weight of the truck.

In general, posting of a structure, when warranted, shall occur as soon as possible but not to exceed 90 days from the time posting requirements have been verified and within 60 days from the date of the posting letter is sent to the region by the Statewide Program Manager. In instances where the load carrying capacity of a bridge is significantly reduced, such as by impact to the structure, posting or closing of the bridge shall occur as soon as it is determined it is not safe to carry legal vehicular loads.

When possible, additional tests such as concrete strength or steel yield strength shall be performed to validate the assumption in the load rating analysis, hence mitigate the need for posting or restriction of the bridge. Strengthening or repair of an element should also be considered to eliminate the need for posting or restriction.

Load Posting Signs for structures where needed, shall follow the Manual on Uniform Traffic Control Devices (MUTCD) and WSDOT *Sign Fabrication Manual* M 55-05.

In general, when a bridge requires posting for the three AASHTO legal trucks, Type 3 (Single Unit), Type 3S2 (Truck-Semi Trailer) and Type 3-3 (Truck Trailer), it will also require the posting for the SUV's (SU4, SU5, SU6 and SU7). In this instance two posting signs will be required as shown in Fig 5.02-F-1. Note that posting limit for the 3 or less axles shall match the Type 3 Truck.

In cases where the structure is required to be posted for only the SUV trucks, the posting shall follow the sign shown in Figure 5.02-F-2. The sign shall reflect only the vehicles that need be posted. For example if the bridge requires posting for the SU5, SU6 and SU7, there is no need to show the posting limit for the SU4.

In cases where the required posting for the different trucks falls within 5 tons, provide one posting sign limiting the structure to the most restrictive posting.



Figure 5.02-E-1



Figure 5.02-E-2

All bridges requiring load posting also require additional advance posting signs in advance of the nearest intersecting roads, ramps or a wide point in the road where a driver can detour or turn around.

## F. Overload Permits

Overweight loads traveling over state or local agency roads are required to obtain permits/approval from the state, county, or city maintaining those roadways. No permit loads shall be allowed over posted bridges. The first step in evaluating a permit is to determine if the configuration meets RCW 46.44 for maximum gross weight, load per axle, or axle group (E-Snoopi) is a tool on WSDOT Commercial Vehicle website is used to calculate axle weight per RCW). The second step is to evaluate the structures on the traveled route. This can be accomplished in two methods.

The first method, which is more precise for a specific structure, is to model the permit load moving on the bridge and calculating its load rating factor. A single lane distribution factor can be used in the model, which means that no other trucks are permitted in the adjacent lanes. A rating factor equal to or above 1 means the permit truck can safely travel over the particular structure. Permit loads that have unusual configuration or have more than 8 tires per axles shall be evaluated using this method.

The second method is more general and the engineer shall be extremely cautious when applying it to ensure that the permit load is enveloped by one of the typical rated trucks. The method calculates the maximum weight per axle allowed over a bridge and is dependent on the load rating factors for the particular structure, as follows:

- **Truck Type SA**

**Definition:** Construction Equipment Tires (a.k.a., Super Single Axle) (RCW 46.44.091(3))

**Range:** Up to 45,000 lbs. per axle.

**Criteria:** Using the Load Rating Factor for the Overload 1 Truck (a.k.a., OL1), which has a dual axle weighing 43,000 lbs., the equation is  $45,000 \text{ lbs.} \times \text{Rating Factor} \times \frac{43}{45}$  rounded to the nearest 500 lbs.

- **Collection Truck (RCW 46.44.041) Restriction List**  
**Truck Type S/A**

**Definition:** Two-axle trucks where the rear drive axle is the item in question on non-interstate routes only.

**Range:** Up to 26,000 lbs. on rear axle.

**Criteria:** Using the Load Rating Factor for the AASHTO1 Truck (a.k.a., Type 3), which has a dual axle weighing 34,000 lbs., the equation is  $26,000 \text{ lbs.} \times \text{Rating Factor} \times \frac{26}{34}$  rounded to the nearest 500 lbs.

- **Truck Type T/D**

**Definition:** Three-axle trucks where the rear tandem drive axles are the item in question on non-interstate routes only.

**Range:** Up to 42,000 lbs. on rear dual.

**Criteria:** Using the Load Rating Factor for the AASHTO1 Truck (a.k.a., Type 3), which has a dual axle weighing 34,000 lbs., the equation is  $42,000 \text{ lbs.} \times \text{Rating Factor} \times \frac{34}{42}$  rounded to the nearest 500 lbs.

- **Tow Truck (RCW 46.44.015) Restriction List**

**Truck Type:** Tow truck with tandem (dual) drive axles.

**Definition:** Three axle tow truck with tandem drive axles towing a variety of vehicles.

**Range:** Up to 48,000 lbs. on drive dual axles.

**Criteria:** Using the Load Rating Factor for the AASHTO2 Truck (a.k.a., Type 3S2), which has dual weighing 31,000 lbs., the equation is **48,000 lbs. \* Rating Factor \* 31/48** rounded to the nearest 500 lbs.

- **Truck Type CL8**

**Definition:** Class 8 Short Hitch five-axle combination (three-axle tractor with a two-axle trailer).

**Range:** Up to 21,500 lbs. per axle in dual group and 20,000 to 22,000 for a single axle.

**Criteria:** Use the Load Rating Factor for the OL1 Truck based on single lane distribution factor. The equation is **22,000 lbs.\* Rating Factor** rounded to the nearest 500 lbs.

- **Truck Type BL**

**Definition:** Big load six plus axle combination and three to four axle single units.

**Range:** Up to 22,000 lbs. per axle in dual and tridem groups and up to 22,000 lbs. for a single axle.

**Criteria:** Use the Load Rating Factor for the OL2 Truck based on a single lane distribution factor. The equation is **22,000 lbs.\* Rating Factor\* Modifying Factor (MF)\*** rounded to the nearest 500 lbs. In some instances engineering judgment may be used in establishing restrictions on a structure.

\*Modifying Factor (MF) is 1.15 if Superstructure or Substructure Condition is 6 or above; 1.10 for Condition of 5 and 1 for 4 or less. The MF is applicable to concrete and steel members. For timber members the MF is 1.

For permits traveling over State routes, WSDOT can request the weighing of a permit load at any time, however, here are typical triggers:

- Analysis shows that the load is close to overstressing one or more bridges.
- Multiple load requests: 10 or more loads in the 200-300 thousand pound range.
- 5 or more loads over 300 thousand pounds.
- Any load over 500,000 pounds.

**Commentary:** *The SA load is assumed to act as a tandem axle due to the size of the tire. The occurrence of these permitted loads are occasional, hence, the OL1 was used to envelope these vehicles due to the lower Live Load Factor instead of the Type 3S2 which was previously used.*

*The MF multiplier applied to the BL is used since the OL2 is an envelope truck and is not permitted in the State. The Engineer shall use the MF with extreme caution and it shall not be applied to every permit load. The previous methodology which applied a Multiplier Factor based on the number of lanes is not valid any longer.*

### 5.03 Scour Evaluation

All bridges spanning waterways are required by the NBIS to have a scour evaluation. A scour evaluation is done to identify the susceptibility to erosion of streambed material and the degree of foundation element stability. The evaluation should include as-built foundation details, current condition of the foundation, a stream bed cross section profile, and stream flow rates. The initial evaluation is a screening tool to evaluate the susceptibility of a structure to scour. If a structure is found to be vulnerable to scour, an analysis shall be performed by a professional engineer with hydraulics expertise to assess the scour issues or identify the proper repairs/countermeasures.

As the bridge foundation condition changes and/or the stream bed characteristics change, the scour criticality may have to be reanalyzed. Scour evaluations shall be reviewed and updated every 12 years, if necessary.

Upon determining that a bridge is scour critical, the agency needs to develop a written plan of action (POA) to monitor, mitigate, or close the bridge. Monitoring the structural performance of the bridge during and after flood events is particularly important. For additional information, see FHWA HEC 18 Evaluating Scour at Bridges.

New bridges shall have the scour evaluation completed during the design phase and results shall be entered into the data inventory within 30 days of the structure being open to traffic. Newly discovered or transfer of ownership of bridges shall have scour evaluation completed and entered into inventory within 12 months.

#### A. Determining Susceptibility to Scour

Each bridge's susceptibility to scour damage must be determined to be either:

1. Stable for calculated scour conditions (scour code 8, 7, 5, 4).
2. Scour critical (scour code 3, 2, 1, 0).
3. Scour risk cannot be determined due to unknown foundations (scour code U)
4. Tidal water that has not been evaluated for scour, but considered low risk (appropriate scour code of 3 if foundations are unknown).

See FHWA coding guide revision at [www.fhwa.dot.gov/engineering/hydraulics/policymemo/revguide.cfm](http://www.fhwa.dot.gov/engineering/hydraulics/policymemo/revguide.cfm).

The results of the scour evaluation are to be recorded by the scour engineer in the Scour Summary Sheet (See Section 5.04) and to be placed in the scour files. Upon completion of all scour evaluations, there should not be any bridges with a code “6.” The completed scour evaluations, information required to do the evaluation, and the best mitigation option for the bridge in question are to be incorporated into the permanent bridge file.

| Scour Code | Soundings Flag Max. Frequency (months) |
|------------|----------------------------------------|
| 2          | 12                                     |
| 3          | 24                                     |
| U          | 24                                     |
| 4          | 24                                     |
| 5          | 72                                     |
| 7          | 72                                     |
| 8          | 72                                     |

The soundings frequency for State bridges can be changed by the Scour Engineer as needed based on field observations. The list of bridges that require soundings for State bridges is created by the Scour Engineer and provided to the Information Group within BPO no later than December 31st of each year to be added to Bridge Works.

### **B. Action Plans for Scour Critical Bridges**

For each bridge that has been determined to be scour critical, a POA shall be developed to identify the appropriate measures necessary to make the bridge less vulnerable to damage or failure due to scour. The POA is to provide specific direction as to essential actions required at the site for region field staff to observe and take the appropriate action without further communication. It should have details of who to contact after a bridge has been closed due to the specified event. Whatever action is to be taken it must be documented in the POA no matter how trivial the direction is (or no direction).

Region field staff inspecting the condition of susceptible elements must have authority to close the bridge and know how to conduct an emergency closure. They must have the necessary equipment with them to take this action at the time of the determination without leaving the bridge or calling for assistance.

The two primary components of the POA are instructions regarding the triggering event and frequency of inspections to be made at the bridge, and a schedule for the timely design and construction of scour countermeasures (see Section 5.04 for WSDOT and FHWA POA templates). The POA's for WSDOT are updated by the Scour Engineer after each inspection, if needed, and they are stored on BEISt.

The POA should include:

- Physical site identification (bridge, route, stream, etc.) features that are vulnerable (approach roadway, pier/s, pier orientation/beginning of bridge)
- Hydrologic and Hydraulic Characteristics (water surface elevation needed if appropriate to the event type and characteristics.)
- Party responsible for decision on closure/reopen.
- Responsible party contact information after taking the specified action.



- Trigger mechanisms for closure and opening on-site water surface elevation located such that field crews can observe them from river bank.
- Detour routes
- Communication to public (detour signage, law enforcement, press, etc.)
- Records of mitigation in place (quarry spall, weirs, mats, barbs, etc.) with photo and original dimensions for future examination and reference. This information to be made available to inspectors and region field staff to utilize during inspections and flood events.

When monitoring is deemed appropriate there are basic components that should be incorporated as listed above. Depending on the risk or consequence of failure, greater detail may be warranted.

**Monitoring** – It is important that all scour critical bridges be monitored during and after flood events. The POA should include specific instructions to bridge inspectors or maintenance workers on what to look for, at what locations, and methods of inspection to use. Guidance should also be included as to when a bridge should be closed to traffic. Agencies should also develop and inform appropriate personnel of bridge closure procedures. The intensity of the monitoring effort is related to the risk of the scour hazard, as determined from the scour evaluation. Some of the items to consider when developing the monitoring plan include:

- Amount of existing rotational movement or settlement of substructure units
- Degree of streambed degradation, aggradation, or lateral movement
- Recommended procedures and equipment for taking measurements of streambed elevations (rods, probes, weights, portable sonic equipment, etc.)
- Instructions for inspecting existing countermeasures such as riprap, dikes, barbs, mats, etc.
- Guidance on maximum permissible scour depths, flood flows, water surface elevations, etc. beyond which the bridge should be closed to traffic
- Instructions for checking the operation of fixed scour monitoring devices
- Reporting procedures for conditions that warrant bridge closure. Establish the chain of command with authority to close bridges.
- Forms and procedures for documenting inspection results and instructions regarding follow-up actions when necessary

**Temporary Countermeasures** – Temporary countermeasures provide a degree of protection for scour critical bridges. They may prevent damage for most flows, but are sacrificial, low-cost treatments that help insure the safety of a bridge during flood events. Use of such measures may postpone the need to close a bridge during high flows. Temporary countermeasures, such as riprap, should not be viewed as an alternative to monitoring, but rather as a supplement.

**Permanent Countermeasures** – Permanent countermeasures are engineered to make a bridge safe from damage due to scour. A variety of methods exist including channel improvements, structural strengthening or underpinning, drop structures, relief bridges or constructing additional spans. These types of fixes would eliminate the bridge from being “scour critical,” but are more costly. Agencies prioritize permanent countermeasures to address the most critical needs as funds permit.

### C. Recording Bridge Scour Information

The completed bridge scour evaluation shall include the resulting WSBIS 1680 scour code, the information required to do the evaluations, and the written action plan to mitigate scour risk. The evaluation is to be incorporated into the permanent bridge file for the bridge. Any changes to bridge inventory data should be accomplished within 30 days after the evaluation or field review are complete. The scour monitoring information or schedule should be communicated to all affected parties.

Fields that relate to bridge hydraulics and/or scour are:

- Waterway Adequacy Appraisal- WSBIS 1662 [NBI Item 71]
- Substructure Condition - WSBIS 1676 [NBI Item 60]
- Channel Protection - WSBIS 1677 [NBI Item 61]
- Pier/Abutment Protection – WSBIS 1679 [NBI Item 111]
- Scour – WSBIS 1680 [NBI Item 113]

### D. Scour Analysis

The procedure for analyzing stream stability and scour shall be per HEC Publications (see Figure 5-0) which could involve the following three levels of analysis:

- **Level 1** – Application of simple geomorphic concepts and other qualitative analyses
- **Level 2** – Application of basic hydrologic, hydraulic and sediment transport engineering concepts.
- **Level 3** – Application of mathematical or physical modeling studies

**Data Needs for Level 1 Qualitative and Other Geomorphic Analyses** – The data required for preliminary stability analyses include maps, aerial photographs, notes, and photographs from field inspections, historic channel profile data, information on human activities, and changes in stream hydrology and hydraulics over time.

A flowchart of the typical steps in qualitative geomorphic analyses is provided in Figure 5-1.

The six steps are generally applicable to most stream stability problems. As shown in the figure, the qualitative evaluation leads to a conclusion regarding the need for more detailed (Level 2) analysis or a decision to complete a screening or evaluation based on the Level 1 analysis. A Level 1 qualitative analysis is a prerequisite for a Level 2 engineering analysis for bridge design or rehabilitation.

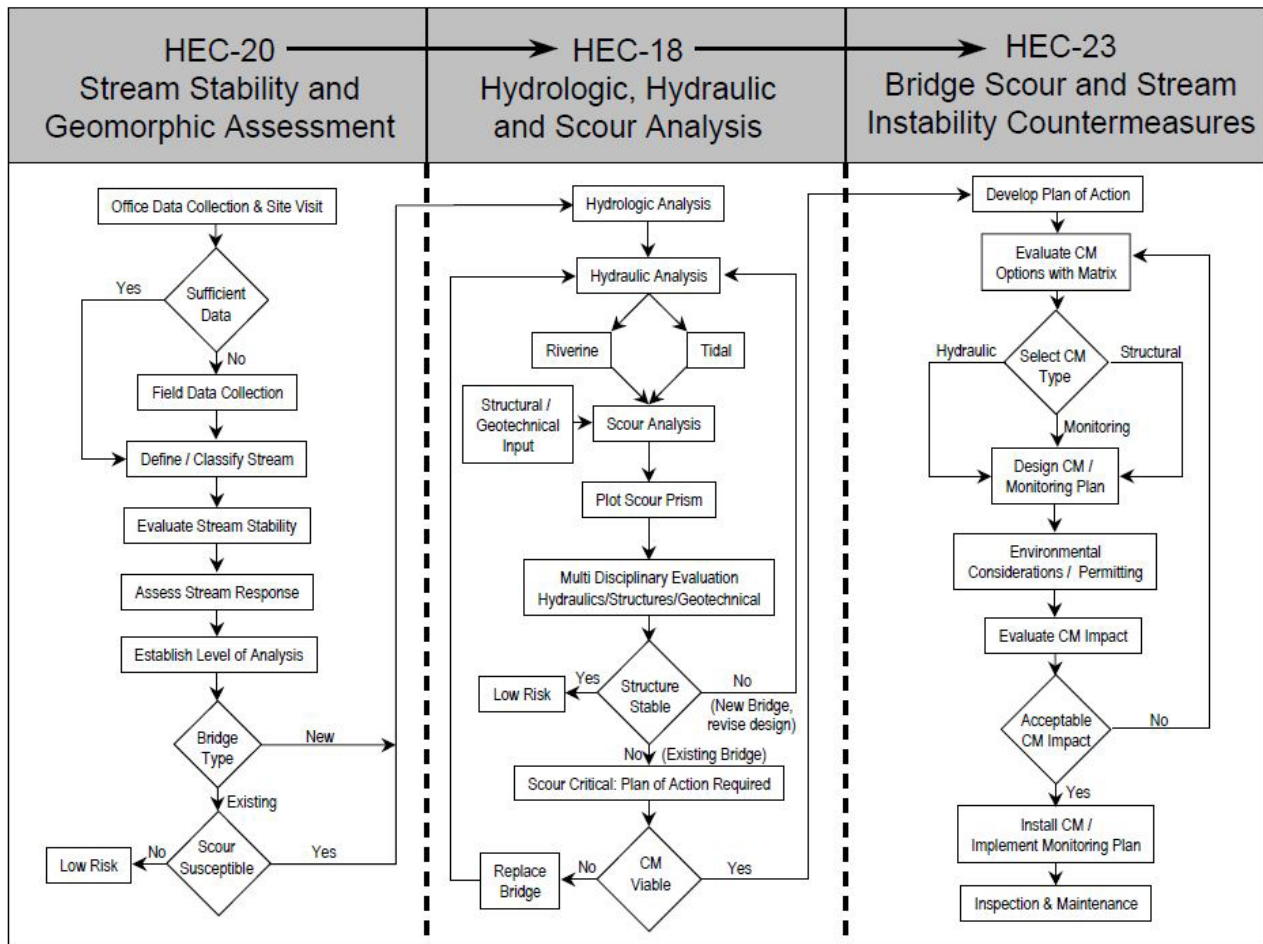

**Scour and Stream Stability Analysis**  
 Figure 5-0

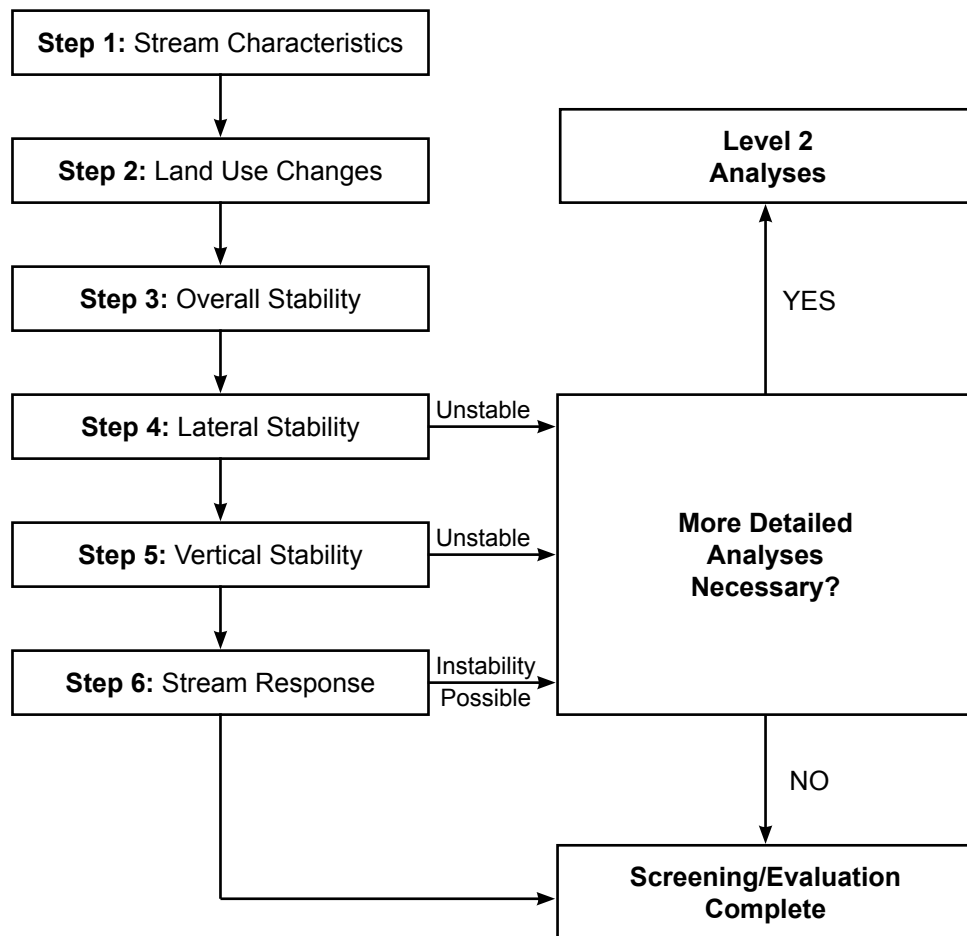

**Level 1 Analysis**  
*Figure 5-1*

**Data Needs for Level 2 Basic Engineering Analyses** – Data requirements for basic hydrologic, hydraulic and sediment transport engineering analyses are dependent on the types of analyses that must be completed. Hydrologic data needs include dominant discharge (or bankfull flow), flow duration curves, and flow frequency curves. Hydraulic data needs include cross sections, channel and bank roughness estimates, channel alignment, and other data for computing channel hydraulics, up to and including water surface profile calculations. Analysis of basic sediment transport conditions requires information on land use, soils, geologic conditions, watershed and channel conditions, and available measured sediment transport rates (e.g., from USGS gauging stations).

More detailed quantitative analyses require data on the properties of bed and bank materials and field data on bed-load and suspended-load transport rates. Properties of bed and bank materials that are important to a study of sediment transport include size, shape, fall velocity, cohesion, density, and angle of repose.

Level 3 analyses are performed by a professional engineer with hydraulic expertise (see Figure 5-2).

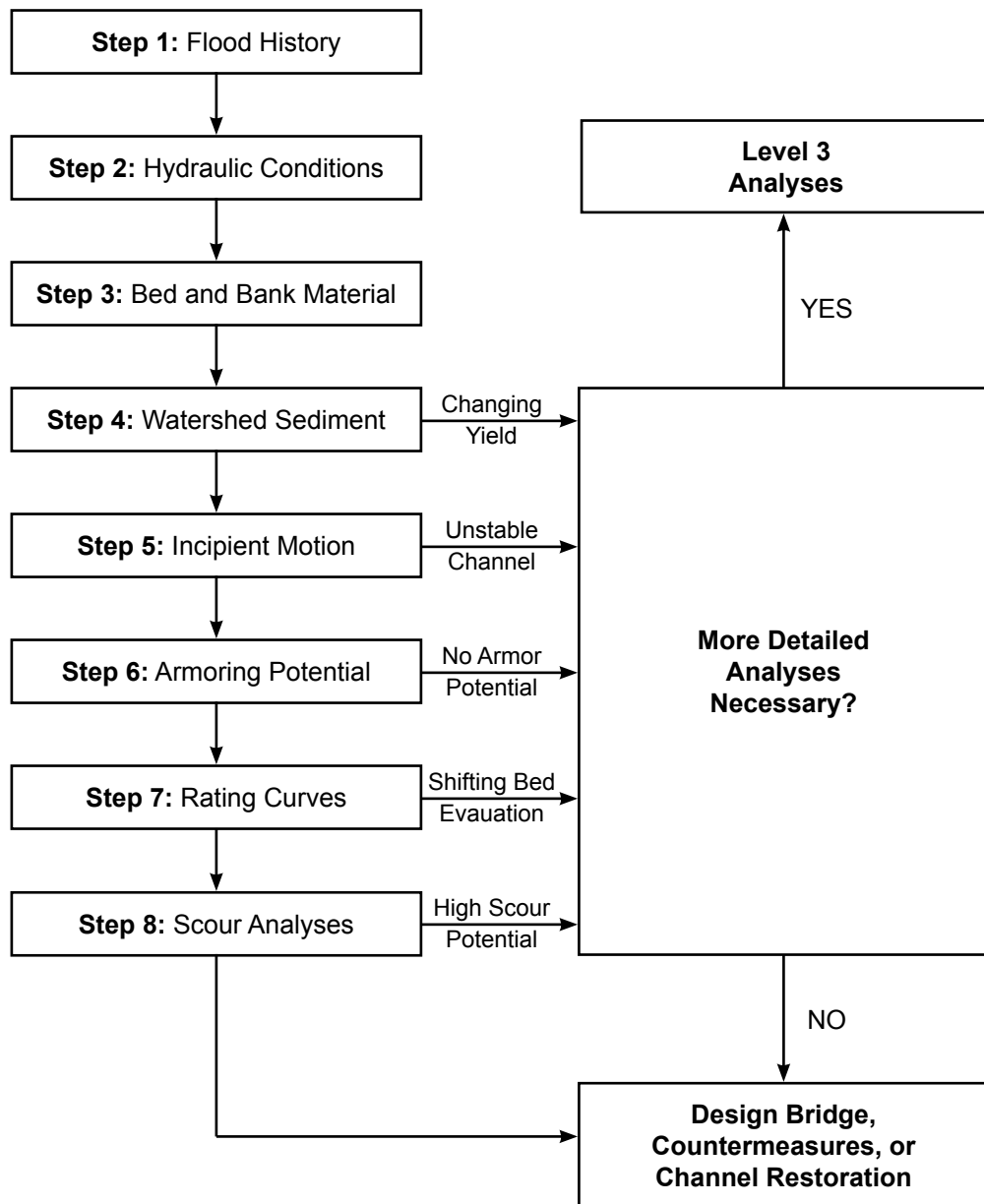

**Level 2 Analysis**  
*Figure 5-2*



## 5.04 Appendices

|                 |                                                  |
|-----------------|--------------------------------------------------|
| Appendix 5.04-A | WSDOT Scour Summary Sheet Instructions           |
| Appendix 5.04-B | WSDOT Plan of Action Template                    |
| Appendix 5.04-C | Instructions for Completing WSDOT Plan of Action |
| Appendix 5.04-D | FHWA Plan of Action Template                     |
| Appendix 5.04-E | Instructions for Completing FHWA Plan of Action  |





# Appendix 5.04-A

# WSDOT Scour Summary Sheet Instructions

| SCOUR SUMMARY SHEET                                                       |  |                                  |  |                                       |  |                    |                      |
|---------------------------------------------------------------------------|--|----------------------------------|--|---------------------------------------|--|--------------------|----------------------|
| <b>Bridge Number:</b>                                                     |  |                                  |  |                                       |  |                    |                      |
| <b>Waterway</b>                                                           |  |                                  |  |                                       |  |                    |                      |
| <b>Scour Code</b>                                                         |  |                                  |  |                                       |  |                    |                      |
| <b>Owner</b>                                                              |  |                                  |  |                                       |  |                    |                      |
| <b>SID</b>                                                                |  |                                  |  | Place PE Stamp Here                   |  |                    |                      |
| <b>Analyzed By:</b>                                                       |  |                                  |  |                                       |  |                    |                      |
| <b>Date of Analysis:</b>                                                  |  |                                  |  |                                       |  |                    |                      |
| <b>Q100 (cfs)</b>                                                         |  |                                  |  | <b>Q100 Water Surface Elev. (ft.)</b> |  |                    |                      |
| <b>Q500 (cfs)</b>                                                         |  |                                  |  | <b>Q500 Water Surface Elev. (ft.)</b> |  |                    |                      |
| <b>V100 (ft./sec)</b>                                                     |  |                                  |  | <b>V500 (ft./sec)</b>                 |  |                    |                      |
| <b>Angle of Attack</b>                                                    |  |                                  |  | <b>Thalweg Elevation</b>              |  |                    |                      |
| <b>Superstructure Low Point (pt. obstructs water flow) Elev. (ft.)</b>    |  |                                  |  |                                       |  |                    |                      |
| <b>Q When High Water Touches Bottom of Bridge if less than Q500 (cfs)</b> |  |                                  |  |                                       |  |                    |                      |
| Scour Analysis                                                            |  |                                  |  |                                       |  |                    |                      |
| Pier Number                                                               |  | Bottom of Foundation Elev. (ft.) |  | Calculated Scour Elev. (ft.)          |  | Monitor (UW, R, F) | Inspection Frequency |
| 1                                                                         |  |                                  |  |                                       |  |                    |                      |
| 2                                                                         |  |                                  |  |                                       |  |                    |                      |
| 3                                                                         |  |                                  |  |                                       |  |                    |                      |
| 4                                                                         |  |                                  |  |                                       |  |                    |                      |
| 5                                                                         |  |                                  |  |                                       |  |                    |                      |
| 6                                                                         |  |                                  |  |                                       |  |                    |                      |
| 7                                                                         |  |                                  |  |                                       |  |                    |                      |
| 8                                                                         |  |                                  |  |                                       |  |                    |                      |
| 9                                                                         |  |                                  |  |                                       |  |                    |                      |
| 10                                                                        |  |                                  |  |                                       |  |                    |                      |
| <b>Mitigation</b>                                                         |  |                                  |  | <b>In Place and Functioning (Y/N)</b> |  |                    |                      |
| <b>Description of Mitigation</b>                                          |  |                                  |  |                                       |  |                    |                      |
| <b>Comments</b>                                                           |  |                                  |  |                                       |  |                    |                      |
| <b>Frequencies:</b>                                                       |  |                                  |  |                                       |  |                    |                      |
| <u>Type of Inspection</u>                                                 |  | <u>Frequency (years)</u>         |  | <u>Year Frequency Established</u>     |  |                    |                      |
| Stream Cross Section from U/S Rail                                        |  |                                  |  |                                       |  |                    |                      |
| Underwater                                                                |  |                                  |  |                                       |  |                    |                      |
| Fathometric                                                               |  |                                  |  |                                       |  |                    |                      |



**SCOUR CRITICAL BRIDGE - PLAN OF ACTION**

|              |                      |                           |
|--------------|----------------------|---------------------------|
| Structure ID | Brg No               | Bridge Name               |
| Region       | Route                | Mile Post                 |
| Owner        | Last Inspection Date |                           |
| Waterway     | Brg Length           | Main Span      Appr Spans |

Foundations: Date POA Modified:  
 Subsurface soil information:  Non-Cohesive    Cohesive    Rock Modified By:  
Title:  
 Does the bridge provide service to emergency facilities and/or an evacuation route?   N/A

**SCOUR VULNERABILITY**

NBIS coding :

|                    |                 |
|--------------------|-----------------|
| Scour Code NBIS    | Item 113 WS 680 |
| Substructure NBIS  | Item 60 WS 676  |
| Channel Protection | Item 60 WS 677  |
| Waterway Adequacy  | Item 71 WS 662  |

Source of Scour Rating       Observed    Assessment    Calculated

Scour Evaluation Summary:

9 Note:  
 361 Note:  
 677 Note:  
 680 Note:

Scour Critical Elements:

**RECOMMENDED ACTION(S)**

a. Flood Monitoring Program       Yes    No       Yes    No  
Recommended      Implemented

b. Hydraulic/Structural Countermeasures       Yes    No       Yes    No

**MONITORING PROGRAM**

Regular Inspection Program       w/ cross sections  
 Items to Watch:

Underwater Inspection Program  
 Items to Watch:

Flood Monitoring Program       Visual Inspection

Flood monitoring required during event:

Flood monitoring event defined by (check all that apply):

Discharge       Stage  
 Elevation measured from  
 Flood warning system:

Frequency of flood monitoring:  
 Post-flood monitoring required:       within

Frequency of post-flood monitoring:  
 Criteria for termination of flood monitoring:

Agency and Department responsible for monitoring:

Contact  
Number

**COUNTERMEASURE RECOMMENDATIONS**

Countermeasure  
implementation  
project type:

Contact person:

Target design completion date:

Target construction completion date:

Countermeasures  
already completed:

**BRIDGE CLOSURE PLAN**

Scour monitoring criteria for consideration of bridge closure:

Agency and department responsible for closure:

Closure contact name:

Criteria for reopening the bridge:

Person responsible for Re-opening bridge after inspection:

**DETOUR ROUTE**

Detour route description ( route number, from/to, distance from bridge, etc.) :

Bridges on Detour Route:

Traffic control equipment (detour signing and barriers) and locations(s):

News release, other public notice (include authorized person(s), information to be provided and limitations):

Scour Files (From BEIST)

**SECTION 1: General Information**

- The general bridge information is usually available via BEIS or from Bridge Works.
- Subsurface soil information is available from boring logs or site visits.
- Included under this section is whether the bridge provides service to emergency services or is a part of an evacuation route.
- POA updates (date, person, and title) provided here.

**SECTION 2: Scour Vulnerability**

- NBI codes 1680, 1676, 1677, and 1682 obtained from most recent bridge inspection report via a query.
- Source of scour rating (observed, assessment, or calculated) defined.
- The Scour Evaluation Summary lists pier foundation elevations and calculated scour elevations when available.
- The bridge inspection notes 9, 361, 1677, and 1680 are obtained from the most recent bridge inspection report via a query.
- The scour critical bridge elements are listed in this section.

**SECTION 3: Recommended Actions**

- Check boxes determine whether a flood monitoring program and hydraulic/structural countermeasures have been recommended and/or implemented.

**SECTION 4: Monitoring Program**

- Regular and underwater inspection programs items to watch as well as cross sections included (under regular inspections).
- Flood monitoring program and visual inspection (during the flood) check boxes listed in this section.
- Flood monitoring required during the event checkbox. Provided with region input.
- Flood monitoring definition checkboxes listed (discharge, stage, elevation measured from, flood warning system).
- Flood elevations tied to bridge structure when possible.
- Specific USGS river gauge listed.
- Flood monitoring and post flood monitoring frequencies listed. These frequencies are provided by the regions.
- Criteria for flood monitoring termination stated.
- Agency, department responsible for flood monitoring along with contact information listed.

**SECTION 5: Countermeasure Recommendations**

- Countermeasure implementation project type as well as targeted design and construction completion dates provided. A list of completed scour countermeasures is included here.
- Scour engineer contact information listed here.

**SECTION 6: Bridge Closure Plan**

- Scour monitoring criteria (flood elevations, debris piles, obvious bridge distress) listed for consideration of bridge closure.
- Agency, department, closure contact information listed here.
- Criteria for reopening bridge, person responsible for reopening bridge (BPO engineer) contact information listed.

**SECTION 7: Detour Route**

- Detour route description (route number, distance from bridge) provided by regions.
- Bridges on detour route along with any load or geometric restrictions provided by regions.
- Traffic control equipment (signing and barriers) and locations provided by region maintenance.
- News releases, other public notices including authorized persons provided by region public relations.

**SECTION 8: Scour files**

- Electronic scour file locations listed.

| <b>SCOUR CRITICAL BRIDGE - PLAN OF ACTION</b>                                                                                                                                 |                                          |                                                                                   |
|-------------------------------------------------------------------------------------------------------------------------------------------------------------------------------|------------------------------------------|-----------------------------------------------------------------------------------|
| <b>1. GENERAL INFORMATION</b>                                                                                                                                                 |                                          |                                                                                   |
| Structure number: _____                                                                                                                                                       | City, County, State: _____               | Waterway: _____                                                                   |
| Structure name: _____                                                                                                                                                         | State highway or facility carried: _____ | Owner: _____                                                                      |
| Year built: _____                                                                                                                                                             | Year rebuilt: _____                      | Bridge replacement plans (if scheduled): _____<br>Anticipated opening date: _____ |
| Structure type: <input type="checkbox"/> Bridge <input type="checkbox"/> Culvert                                                                                              |                                          |                                                                                   |
| Structure size and description: _____                                                                                                                                         |                                          |                                                                                   |
| Foundations: <input type="checkbox"/> Known, type: _____    Depth: _____ <input type="checkbox"/> Unknown                                                                     |                                          |                                                                                   |
| Subsurface soil information ( <i>check all that apply</i> ): <input type="checkbox"/> Non-cohesive <input type="checkbox"/> Cohesive <input type="checkbox"/> Rock            |                                          |                                                                                   |
| Bridge ADT: _____                                                                                                                                                             | Year/ADT: _____                          | % Trucks: _____                                                                   |
| Does the bridge provide service to emergency facilities and/or an evacuation route (Y/N)? _____<br>If so, describe: _____                                                     |                                          |                                                                                   |
| <b>2. RESPONSIBILITY FOR POA</b>                                                                                                                                              |                                          |                                                                                   |
| Author(s) of POA (name, title, agency/organization, telephone, pager, email): _____                                                                                           |                                          |                                                                                   |
| Date: _____                                                                                                                                                                   |                                          |                                                                                   |
| Concurrences on POA (name, title, agency/organization, telephone, pager, email): _____                                                                                        |                                          |                                                                                   |
| POA updated by (name, title, agency, organization): _____ Date of update: _____<br>Items update: _____                                                                        |                                          |                                                                                   |
| POA to be updated every _____ months by (name, title, agency/organization): _____<br>Date of next update: _____                                                               |                                          |                                                                                   |
| <b>3. SCOUR VULNERABILITY</b>                                                                                                                                                 |                                          |                                                                                   |
| a. Current Item 113 Code: <input type="checkbox"/> 3 <input type="checkbox"/> 2 <input type="checkbox"/> 1                      Other: _____                                  |                                          |                                                                                   |
| b. Source of Scour Critical Code: <input type="checkbox"/> Observed <input type="checkbox"/> Assessment <input type="checkbox"/> Calculated                      Other: _____ |                                          |                                                                                   |
| c. Scour Evaluation Summary: _____                                                                                                                                            |                                          |                                                                                   |
| d. Scour History: _____                                                                                                                                                       |                                          |                                                                                   |

| 4. RECOMMENDED ACTION(S) (see Sections 6 and 7)                                                                                                                                                                                                                                                                                                                                                                                                                                                                                                                                                                                                                                                           |                                                          |                                                          |
|-----------------------------------------------------------------------------------------------------------------------------------------------------------------------------------------------------------------------------------------------------------------------------------------------------------------------------------------------------------------------------------------------------------------------------------------------------------------------------------------------------------------------------------------------------------------------------------------------------------------------------------------------------------------------------------------------------------|----------------------------------------------------------|----------------------------------------------------------|
|                                                                                                                                                                                                                                                                                                                                                                                                                                                                                                                                                                                                                                                                                                           | <u>Recommended</u>                                       | <u>Implemented</u>                                       |
| a. Increased Inspection Frequency                                                                                                                                                                                                                                                                                                                                                                                                                                                                                                                                                                                                                                                                         | <input type="checkbox"/> Yes <input type="checkbox"/> No | <input type="checkbox"/> Yes <input type="checkbox"/> No |
| b. Fixed Monitoring Device(s)                                                                                                                                                                                                                                                                                                                                                                                                                                                                                                                                                                                                                                                                             | <input type="checkbox"/> Yes <input type="checkbox"/> No | <input type="checkbox"/> Yes <input type="checkbox"/> No |
| c. Flood Monitoring Program                                                                                                                                                                                                                                                                                                                                                                                                                                                                                                                                                                                                                                                                               | <input type="checkbox"/> Yes <input type="checkbox"/> No | <input type="checkbox"/> Yes <input type="checkbox"/> No |
| d. Hydraulic/Structural Countermeasures                                                                                                                                                                                                                                                                                                                                                                                                                                                                                                                                                                                                                                                                   | <input type="checkbox"/> Yes <input type="checkbox"/> No | <input type="checkbox"/> Yes <input type="checkbox"/> No |
| 5. NBI CODING INFORMATION                                                                                                                                                                                                                                                                                                                                                                                                                                                                                                                                                                                                                                                                                 |                                                          |                                                          |
|                                                                                                                                                                                                                                                                                                                                                                                                                                                                                                                                                                                                                                                                                                           | <u>Current</u>                                           | <u>Previous</u>                                          |
| <b>Inspection date</b>                                                                                                                                                                                                                                                                                                                                                                                                                                                                                                                                                                                                                                                                                    |                                                          |                                                          |
| <b>Item 113   Scour Critical</b>                                                                                                                                                                                                                                                                                                                                                                                                                                                                                                                                                                                                                                                                          |                                                          |                                                          |
| <b>Item 60   Substructure</b>                                                                                                                                                                                                                                                                                                                                                                                                                                                                                                                                                                                                                                                                             |                                                          |                                                          |
| <b>Item 61   Channel &amp; Channel Protection</b>                                                                                                                                                                                                                                                                                                                                                                                                                                                                                                                                                                                                                                                         |                                                          |                                                          |
| <b>Item 71   Waterway Adequacy</b>                                                                                                                                                                                                                                                                                                                                                                                                                                                                                                                                                                                                                                                                        |                                                          |                                                          |
| <b>Comments: (drift, scour holes, etc. - depict in sketches in Section 10)</b>                                                                                                                                                                                                                                                                                                                                                                                                                                                                                                                                                                                                                            |                                                          |                                                          |
| 6. MONITORING PROGRAM                                                                                                                                                                                                                                                                                                                                                                                                                                                                                                                                                                                                                                                                                     |                                                          |                                                          |
| <input type="checkbox"/> <b>Regular Inspection Program</b> <span style="float: right;"><input type="checkbox"/> w/surveyed cross sections</span><br>Items to Watch: _____                                                                                                                                                                                                                                                                                                                                                                                                                                                                                                                                 |                                                          |                                                          |
| <input type="checkbox"/> <b>Increased Inspection Frequency of __ mo.</b> <span style="float: right;"><input type="checkbox"/> w/surveyed cross sections</span><br>Items to Watch: _____                                                                                                                                                                                                                                                                                                                                                                                                                                                                                                                   |                                                          |                                                          |
| <input type="checkbox"/> <b>Underwater Inspection Required</b><br>Items to Watch: _____                                                                                                                                                                                                                                                                                                                                                                                                                                                                                                                                                                                                                   |                                                          |                                                          |
| <input type="checkbox"/> <b>Increased Underwater Inspection Frequency of __ mo.</b><br>Items to Watch: _____                                                                                                                                                                                                                                                                                                                                                                                                                                                                                                                                                                                              |                                                          |                                                          |
| <input type="checkbox"/> <b>Fixed Monitoring Device(s)</b><br>Type of Instrument: _____<br>Installation location(s): _____<br>Sample Interval: <input type="checkbox"/> 30 min. <input type="checkbox"/> 1 hr. <input type="checkbox"/> 6 hrs. <input type="checkbox"/> 12 hrs. <input type="checkbox"/> Other: _____<br>Frequency of data download and review: <input type="checkbox"/> Daily <input type="checkbox"/> Weekly <input type="checkbox"/> Monthly <input type="checkbox"/> Other _____<br>Scour alert elevation(s) for each pier/abutment: _____<br>Scour critical elevations(s) for each pier/abutment: _____<br>Survey ties: _____<br>Criteria of termination for fixed monitoring: _____ |                                                          |                                                          |



**Flood Monitoring Program**  
 Type:  Visual inspection  
 Instrument (*check all that apply*):  
 Portable  Geophysical  Sonar  Other: \_\_\_\_\_  
 Flood monitoring required:  Yes  No  
 Flood monitoring event defined by (*check all that apply*):  
 Discharge \_\_\_\_\_  Stage \_\_\_\_\_  
 Elev. measured from \_\_\_\_\_  Rainfall \_\_\_\_\_ (in/mm) per \_\_\_\_\_ (hour)  
 Flood forecasting information: \_\_\_\_\_  
 Flood warning system: \_\_\_\_\_  
 Frequency of flood monitoring:  1 hr.  3 hrs.  6 hrs.  Other: \_\_\_\_\_  
 Post-flood monitoring required:  No  Yes, within \_\_\_\_\_ days  
 Frequency of post-flood monitoring:  Daily  Weekly  Monthly  Other: \_\_\_\_\_  
 Criteria for termination of flood monitoring: \_\_\_\_\_  
 Criteria for termination of post-flood monitoring: \_\_\_\_\_  
 Scour alert elevation(s) for each pier/abutment: \_\_\_\_\_  
 Scour critical elevation(s) for each pier/abutment: \_\_\_\_\_

*Note: Additional details for action(s) required may be included in Section 8.*  
 Action(s) required if scour alert elevation detected (*include notification and closure procedures*): \_\_\_\_\_  
 Action(s) required if scour critical elevation detected (*include notification and closure procedures*): \_\_\_\_\_

**Agency and department responsible for monitoring:** \_\_\_\_\_

**Contact person (include name, title, telephone, pager, e-mail):** \_\_\_\_\_

**7. COUNTERMEASURE RECOMMENDATIONS**

*Prioritize alternatives below. Include information on any hydraulic, structural or monitoring countermeasures.*

**Only monitoring required (see Section 6 and Section 10 – Attachment F)**  
 Estimated cost \$ \_\_\_\_\_

**Structural/hydraulic countermeasures considered (see Section 10, Attachment F):**

| <u>Priority Ranking</u> | <u>Estimated cost</u> |
|-------------------------|-----------------------|
| (1) _____               | \$ _____              |
| (2) _____               | \$ _____              |
| (3) _____               | \$ _____              |
| (4) _____               | \$ _____              |
| (5) _____               | \$ _____              |

**Basis for the selection of the preferred scour countermeasure:** \_\_\_\_\_

**Countermeasure implementation project type:**  
 Proposed Construction Project  Maintenance Project  
 Programmed Construction - Project Lead Agency:  
 Bridge Bureau  Road Design  Other \_\_\_\_\_

**Agency and department responsible for countermeasure program (if different from Section 6 contact for monitoring):** \_\_\_\_\_

Contact person (include name, title, telephone, pager, e-mail): \_\_\_\_\_

Target design completion date: \_\_\_\_\_

Target construction completion date: \_\_\_\_\_

Countermeasures already completed: \_\_\_\_\_

**8. BRIDGE CLOSURE PLAN**

**Scour monitoring criteria for consideration of bridge closure:**

- Water surface elevation reaches \_\_\_\_\_ at \_\_\_\_\_
- Overtopping road or structure
- Scour measurement results / Monitoring device (See Section 6)
- Observed structure movement / Settlement
- Discharge: \_\_\_\_\_ cfs/cms
- Flood forecast: \_\_\_\_\_
- Other:  Debris accumulation     Movement of riprap/other armor protection
- Loss of road embankment

Emergency repair plans (include source(s), contact(s), cost, installation directions): \_\_\_\_\_

Agency and department responsible for closure: \_\_\_\_\_

Contact persons (name, title, agency/organization, telephone, pager, email): \_\_\_\_\_

Criteria for re-opening the bridge: \_\_\_\_\_

Agency and person responsible for re-opening the bridge after inspection: \_\_\_\_\_

**9. DETOUR ROUTE**

**Detour route description** (route number, from/to, distance from bridge, etc.) - Include map in Section 10, Attachment E.

**Bridges on Detour Route:**

| Bridge Number | Waterway | Sufficiency Rating/<br>Load Limitations | Item 113 Code |
|---------------|----------|-----------------------------------------|---------------|
|               |          |                                         |               |
|               |          |                                         |               |
|               |          |                                         |               |
|               |          |                                         |               |

Traffic control equipment (detour signing and barriers) and location(s): \_\_\_\_\_

Additional considerations or critical issues (susceptibility to overtopping, limited waterway adequacy, lane restrictions, etc.) : \_\_\_\_\_

News release, other public notice (include authorized person(s), information to be provided and limitations): \_\_\_\_\_

**10. ATTACHMENTS**

Please indicate which materials are being submitted with this POA:

- Attachment A: Boring logs and/or other subsurface information
- Attachment B: Cross sections from current and previous inspection reports
- Attachment C: Bridge elevation showing existing streambed, foundation depth(s) and observed and/or calculated scour depths
- Attachment D: Plan view showing location of scour holes, debris, etc.
- Attachment E: Map showing detour route(s)
- Attachment F: Supporting documentation, calculations, estimates and conceptual designs for scour countermeasures.
- Attachment G: Photos
- Attachment H: Other information: \_\_\_\_\_



The existing bridge management system in your state will provide much of the information required to fill out this template.

**Note:** All blocks in this template will expand automatically to allow as much space as you require. All fields can be modified to accommodate local terminology, as desired. Where check boxes are provided, they can be checked by double-clicking on the box and selecting the “checked” option. If you include additional attachments, please indicate this in Section 10.

### Section 1

**Foundations** – It is recommended that substructure depths be shown in the bridge elevation, Attachment C (see Section 10). The minimum depth should be reported in Section 1 as a worst-case condition.

**Subsurface Soil Information** – If conditions vary with depth and/or between substructure units, this should be noted and included in Attachments A and/or C (see Section 10).

#### Sections 1, 2, 3, and 4

These sections are intended as an executive summary for the reviewer/manager who may not need the details of Sections 5 through 10, and show:

- **Section 1** – General information
- **Section 2** – Who prepared the POA
- **Section 3** – The source of the problem
- **Section 4** – What actions are recommended and their status

### Section 3

Reasons why the bridge has been rated scour critical for Item 113:

#### Scour Critical

- Aggressive stream or tidal waterway (high velocity, steep slope, deep flow).
- Actively degrading channel.
- Bed material is easily eroded.
- Large angle of attack ( $> 10^\circ$ ).
- Significant overbank or floodplain flow (floodplain  $> 50$  m or 150 feet wide).
- Possibility of bridge overtopping (potential for pressure flow through bridge).
- Evidence of scour and/or degradation.
- Evidence of structural damage due to scour.
- Foundations are spread footings on erodible soil, shallow piles, or embedment unknown.
- Exposed footing in erodible material.
- Exposed piles with unknown or insufficient embedment.

- Loss of abutment and/or pier protection.
- No countermeasures or countermeasures in poor condition.
- Needs countermeasures immediately.

**Unknown Foundations**

- No record of foundation type (spread footing vs. piles).
- Depth of foundation or pile embedment unknown.
- Condition of foundation or pile embedment unknown.
- Subsurface soil strata not documented.

**Section 5**

This section highlights recent changes in the scour/hydraulics coding items as an indication of potential problems or adverse trends. See FHWA Policy Memorandum on Revision of Coding Guide, Item 113 - Scour Critical Bridges dated April 27, 2001, for details on Items 113 and 60 which can be found at [www.fhwa.dot.gov/engineering/hydraulics/policymemo/revguide.cfm](http://www.fhwa.dot.gov/engineering/hydraulics/policymemo/revguide.cfm).

**Section 6**

Multiple individuals responsible for various monitoring activities may be listed, as appropriate.

**Section 7**

Guidance on the selection and design of scour countermeasures may be found in FHWA Hydraulic Engineering Circular No. 23, Bridge Scour and Stream Instability Countermeasures, Second Edition, 2001. To facilitate the selection of alternative scour countermeasures, a matrix describing the various countermeasures and their attributes is presented in this circular and can be found at <http://isddc.dot.gov/olpfiles/fhwa/010592.pdf>.

**Section 8**

Standard closure and reopening procedures, if available, may be appended to the POA (see Section 10, Attachment H).

**Section 9**

In some situations, public transportation (e.g., bus routes) may be of importance to the public, and therefore could be included in the POA (see Section 10, Attachment).

### 6.01 General

The purpose of this chapter is to provide consistent procedures for reporting bridge repair needs and following up on bridge repair work performed. FHWA has general reporting requirements related to critical findings (discussed later), but otherwise leaves the tracking of repair and maintenance to the owning agency.

Recommendations for repairs arising from bridge inspections range from preventive maintenance that will preserve the life of the structure by slowing down the processes of deterioration, to routine repairs that correct existing minor problems, to critical repairs that must be undertaken immediately to restore service or safeguard the public. The ability to identify and track bridge repair needs and to follow the status of repairs is a vital element of a quality bridge management program. Bridge program managers rely on accurate, timely information provided by concise reports and thorough procedures. The following sections outline both the reports to use and procedures to follow for various types of repair and maintenance needs.

This chapter is specifically written for the use of state forces conducting inspections on both state and locally owned structures. For inspection work performed by state forces on locally-owned structures, it is important for the Local Agency to be aware of the procedures that will be used by the state inspectors. Local Agencies are encouraged to also follow these guidelines but are able to tailor internal procedures to their specific organizational need.

### 6.02 Critical Damage Bridge Repair Report (CDBRR)

The NBIS (23CFR 650.313(h))/MBE (Chapter 4) make reference to critical findings/ deficiencies as a special category of repair need requiring immediate attention of the bridge owner with timely notification to FHWA and subsequent tracking of repair status.

In Washington State, a critical finding is strictly defined as a condition that necessitates closing, posting, or restriction of a bridge or a portion of a bridge due to an identified structural deficiency requiring structural repair(s) before it can be reopened to unrestricted traffic in the original configuration. **The restrictions are usually, but not necessarily limited to restrictions to vehicular traffic.**

Initial notification (and subsequent status updating) for a critical finding is accomplished by completing and submitting the Critical Damage Bridge Repair Report (CDBRR). The CDBRR form was developed by the state to assist in documenting and tracking critical structural and safety related deficiencies on damaged structures.

FHWA will periodically review the reports and the tracking system to verify the needed repairs were promptly reported and the recommended repairs were completed within a reasonable period of time. FHWA may also conduct field checks to verify that critical repair work was accomplished.

CDBRR incidents can be caused by many factors. Recent examples include scour, fire, structural deterioration, and vehicular impact. There can be other causes (e.g. earthquake or other extreme environmental event). A relatively frequent cause is vehicular impact. A point to be aware of is that a short term closure or restriction of a facility to clean up debris and perform initial inspections does not qualify as a CDBRR incident by itself.

See Figure 6.02-A for guidance on determining when a CDBRR is required.

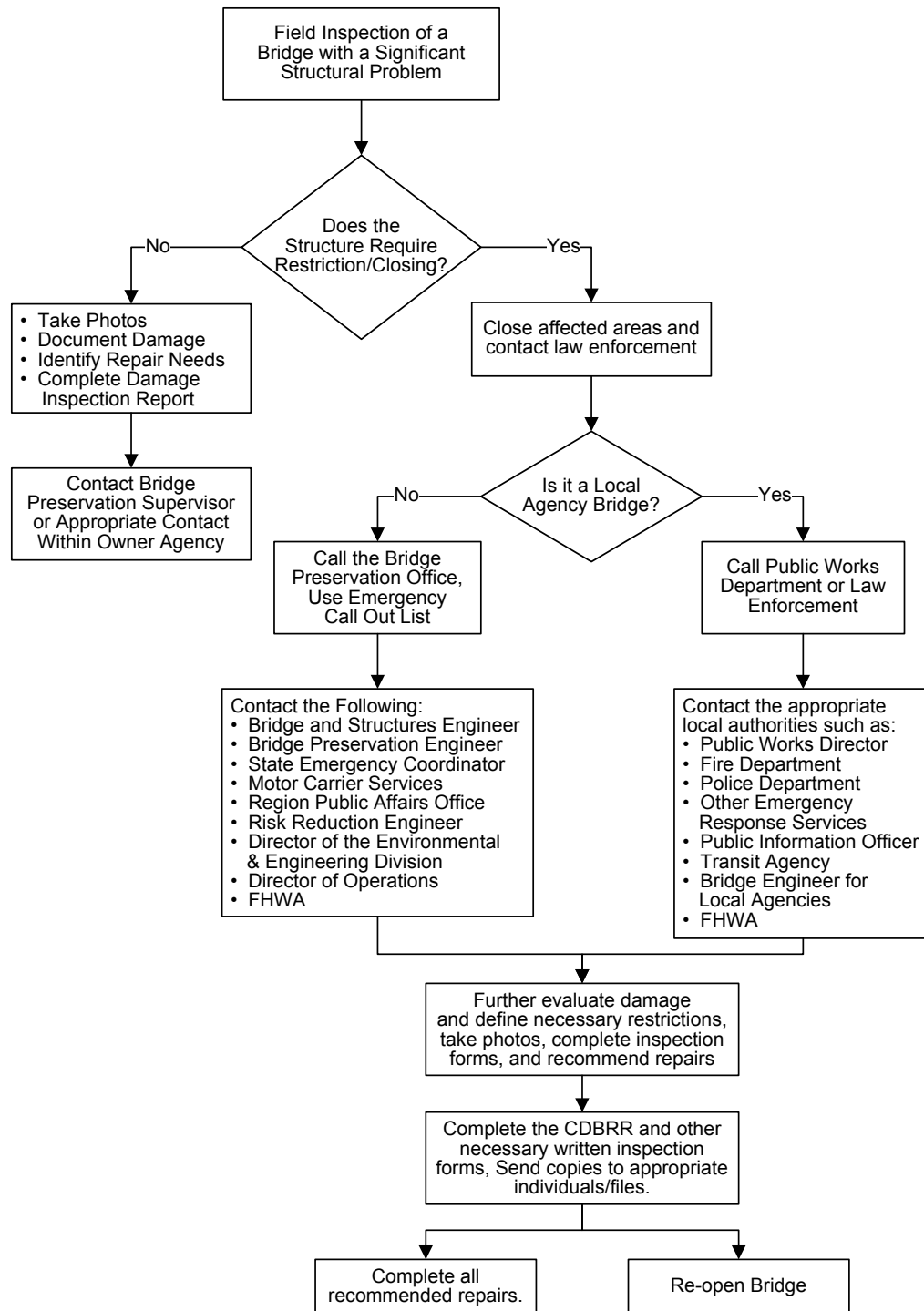

**Field Inspection Procedure**  
**Figure 6.02-A**



The Bridge Preservation Engineer (for State bridges) or the WSDOT Local Programs Bridge Engineer (for Local Agency bridges) is to be notified by phone or email within one working day of identifying structural deficiencies to a structure that will likely require a CDBRR.

The CDBRR must be filled in as completely as possible immediately after the post-incident inspection. See Section 6.02.B for CDBRR submittal requirements.

CDBRR incidents are to be registered in the systemwide database by completing a Damage Inspection Report (DIR) within BridgeWorks (BW). The DIR is discussed further in Chapter 3. The CDBRR and all supporting materials (photos, sketches, etc.) are completed and attached to the Files Tab in BW. All repair recommendations arising from the CDBRR incident are to be identified in the CDBRR and also entered as specific repairs in BW. The specific repairs in BW shall be tagged as “CDBRR” within the repair description.

Any time the recommended repairs cannot be accomplished immediately, the applicable NBI and BMS condition codes should be updated to ensure that the data accurately reflects the bridge’s current condition and status.

The following procedure describes how to fill out the CDBRR.

### **A. Completing the CDBRR**

A dynamic CDBRR form (developed using InfoPath) may be copied from:

W:\Data\Bridge\BridgeDamage\CDBRR Form(For Inspectors Use). See Section 6.06 for a copy of the CDBRR form.

When filling out the CDBRR form, team leaders shall check the appropriate boxes in the upper right corner of the form. Check the CDBRR box when initially creating the form. The Update box should be checked and remain checked for all subsequent changes to the originally submitted CDBRR.

After the CDBRR type has been selected, the team leader may now fill in the applicable fields of the form. The form is organized into three distinct sections:

1. the bridge and inspection team information,
2. the description of the incident that caused the damage,
3. the follow-up or post repair activities on the structure.

Team leaders should fill out the form as thoroughly as possible although some information may be unknown and left blank.

1. **Bridge and Inspection Team Information** – This portion of the CDBRR briefly describes the basic information of the structure that has been damaged along with the inspection team information. The items within this section of the CDBRR are described below.
  - **Agency Name** – The name of the owner agency of the damaged structure.
  - **Structure ID** – The unique federal structure identification number associated with the particular structure in the NBI assigned by WSDOT.

- **Bridge Number** – The bridge number given by the owner agency that is associated with the particular structure.
- **Milepost** – The structure’s milepost location on the inventory route.
- **Incident Date** – The date of the incident that caused damage to the structure, if the information is available.
- **Bridge Name** – The name given by the owner agency that is associated with the particular structure.
- **CDBRR Date** – The date the CDBRR is filled out by the inspector.
- **Operational Status Check Boxes** – Check the appropriate box(es) to describe the type(s) of restriction imposed immediately after initial incident clean-up and inspection:
  - **Bridge Closure** – A complete closure to traffic as a result of structural damage to critical components.
  - **Lane Closure** – The inspection results in the closure of one or more lanes due to structural problems.
  - **Temporary Load Posting** – The inspection results in the temporary load posting of the bridge until repairs can be accomplished.
  - **Other Restriction** – If limits are placed on a bridge for some other reason than the three listed above, the Other Restriction option may be selected. (Example: sidewalk closure due to structural defect.) This item may be used to further explain any closures, postings, restrictions or other actions taken with the damaged structure. This explanation shall be documented within the Mitigation Measures Taken section of the CDBRR as described below.
- **Lead Inspector’s Name/CDBRR Author** – The team leader that performed the inspection or the person completing the CDBRR. (These are usually one and the same. On infrequent occasions, the CDBRR may be completed without there having been an inspection by BPO.)
- **Lead Inspector Cert#** – The team leader’s certification number. (Leave blank if there was no inspection by BPO.)
- **Co-Inspector’s Name** – The assistant inspector to the team leader. (Leave blank if there was no inspection by BPO.)
- **Inspection Date** – The date when the inspection of structural deficiencies took place. (Leave blank if there was no inspection by BPO.)
- **Incident Reported to the owner agency by** – The individual that reported the damage to the owner agency. (Leave blank when not applicable.)
- **Date Reported** – actual date when the incident was reported to the owner agency. (Leave blank when not applicable.)
- **Phone Number** – Contact number for the individual that reported the incident. (Leave blank when not applicable or unknown.)

2. **Incident Information** – This portion of the CDBRR describes the incident information along with the deficiencies found on the structure. The items within this section of the CDBRR are described below.
  - **Description of Incident** – Description of the incident that caused damage to the structure, if the information is available.
  - **Description of the Facilities Damaged** – Detailed description and locations of damage to the structure. For example, on over height collisions, the team leader should measure and identify the extent and degree of the damage as well as the vertical clearance at the point of impact.
  - **Mitigation Measures Taken** – Description of any actions taken to safeguard the traveling public until recommended repairs can be made.
  - **Description of Recommended Repair(s)** – Description of repairs required to correct the deficiencies noted. This may be added while on-site or sometime after the field visit prior to submitting.
3. **Intermediate CDBRR Updates** – This section is filled out whenever an intermediate update to the CDBRR is made. See Section 6.02.B for CDBRR submittal requirements.

Multiple Intermediate Updates are possible.

The items within this section of the CDBRR are described below:

- **Description of Update** – Description of the information to be updated. Insert initials/date in front of the description. This information is to remain in the report as subsequent intermediate updates are made. Insert initials/date in front of each individual description.
  - **Submitted By** – The individual who most recently updated the CDBRR.
  - **Date Submitted** – The date when the CDBRR is updated.
4. **Post Repair Update** – This section is filled out only when all repairs necessary to reopen the structure to unrestricted traffic have been completed. This section is generally to be completed within one month after completion of the recommended repairs has been verified. This section is typically filled out by the Repair Specialist. See Section 6.02.B for CDBRR submittal requirements.

The items within this section of the CDBRR are described below:

- **Description of Work Done** – Description of repair work performed to correct the deficiencies to the structure. The appropriate verification photos may be attached as needed.
- **Date of Repair Completion** – Date when the actual repairs were completed and restrictions removed. If the completion date is not known, use the date verified by BPO.
- **Submitted By** – The individual who updated the CDBRR.
- **Date Submitted** – The date when the CDBRR is updated.

## B. CDBRR Reporting

1. **CDBRR Submittals** – After the Damage Inspection is performed, the typical CDBRR will only contain information within the Bridge/Inspection Team section and within the Incident Information sections. Once completed, the team leader must place a PDF copy of the CDBRR in the "Files" tab of BridgeWorks for the respective structure, and send a copy of the report to the Bridge Preservation Engineer (for State bridges) or the WSDOT Local Programs Bridge Engineer (for local agency bridges). The information shall also be entered in the follow-up tracking system (by the Bridge Preservation Supervisor or his delegate), all within three (3) business days after identifying the damage. For NBI reportable structures, the Bridge Preservation Engineer or the WSDOT Local Programs Bridge Engineer will then forward a copy of this report to the FHWA Division Bridge Engineer as soon as possible but no later than five business days after identifying the damage.

Team leaders for the State are required to save the current XML file and a PDF copy of the CDBRR and all other electronic files, including emails and photos, associated with the Damage inspection into the Bridge Damage folder on the network. Damage inspections requiring a CDBRR and subsequent UPDATES are saved into W:\Data\Bridge Damage\CDBRR Events\ (Inspection Year) directory.

State team leaders are also required to send an email to the Bridge Preservation Engineer and the Bridge Preservation Supervisor, with a cc to the Load Rating Engineer, informing them that the CDBRR form is complete and saved within Bridge Damage Folder as described above.

2. **Post Repair Reporting** – The purpose of the CDBRR is to provide accurate and timely information to other interested parties, as well as to provide accountability, hence the requirement for submission of the Post Repair Update as soon as possible after satisfactory verification of the completion of the work and the removal of traffic restrictions.

The individual who completes the final UPDATE on a CDBRR may have to rely on reports and photos from those who have actually done the repair work. This is understandable and justified, recognizing that those who actually perform the work may not be the same person responsible for the bridge inspection and reporting. It is permissible in certain circumstances to verify the work and complete the Post Repair Update from the office based upon reports received from others. Consult with your supervisor, the Bridge Preservation Supervisor, or the Bridge Preservation Engineer to make the decision and to determine how the information is to be entered into the database (usually by Informational Report).

However, it remains a good and expected practice to have trained team leaders field verify that all the repairs are complete and satisfactory. If changes in condition coding are not anticipated, the follow-up verification inspection (one-time interim) is to be conducted within six months of completion of the required work. But in cases where NBI/BMS condition codes were reduced due to the incident and may be considered for increase after completion of the repair work, the follow-up verification inspection should be conducted as soon as possible following completion of the repair work.

After the repair verification is complete (from the office or by field inspection), a copy of the Post Repair Update shall be placed in the bridge file, a copy is also sent to the Bridge Preservation Engineer (for State bridges), or the WSDOT Local Programs Bridge Engineer (for Local Agency bridges), and the follow-up tracking system shall be updated (by the Bridge Preservation Supervisor or his delegate). For NBI reportable bridges, the Bridge Preservation Engineer or the WSDOT Local Programs Bridge Engineer will then forward a copy of this report to the FHWA Division Bridge Engineer. Update and resubmit the NBI and BMS data as necessary and described in Chapter 3.

### 6.03 Other Damage Reports

Most damage inspections do not end up requiring a CDBRR. The most common case is related to vehicular impact damage, but other situations (e.g. scour, fire, sudden joint failure) are possible.

For those damage inspections that do not require a CDBRR, complete the Damage Inspection Report (DIR) as outlined in Chapter 3. For some cases of minor damage that are not likely to require a structural repair and where the region has not specifically requested our assistance a field inspection may not be required by BPO. Consult with your supervisor, the Bridge Preservation Supervisor, or the Bridge Preservation Engineer for further guidance. For such cases, the DIR may be completed using information provided by the region or other sources. On occasion, a DIR may not be needed at all for vehicular impact incidents requiring nothing more than minor cosmetic repair provided there are not legal or cost recovery circumstances involved. Consult BPO management to make the determination.

For all cases involving vehicular impact and requiring a DIR, the lead inspector assigned to respond to the incident shall provide within 3 working days of initial notification the following information in an e-mail addressed to the Bridge Preservation Supervisor and to the Repair Specialist:

- Structure ID; Bridge Number; Bridge Name; Bridge Location (MP)
- Date of Incident (if known; note if unknown)
- Description of Incident
- Identity and contact info of the person or office who reported the incident to BPO (note if unknown)
- Date the incident was initially reported to BPO
- Date of BPO Inspection; names of Lead Inspector and Co-inspector (actual date, expected date, or a note if no field inspection is expected)
- Brief description of damage to the structure
- Brief description of anticipated repair recommendations
- Status of inspection/report (for those cases where an inspection is expected)

All inspection related damage photos and sketches shall be uploaded to the Damage Directory on the network (W:\Data\Bridge\BridgeDamage\Year xxxx\[bridge no.] [structure type] [incident date]).

Permission levels for this network location are set such that information can be uploaded to and/or copied from this directory, but edits and deletions can only be made by select individuals (Bridge Preservation Supervisor, Repair Specialist, QA Engineer). Notify one of these individuals if corrections/deletions are needed.

## 6.04 Bridge Repairs

### A. New Repair Entries

When a bridge inspection identifies a routine structural or non-structural deficiency, i.e., any deficiency that is not identified in Section 6.02, a repair note describing the deficiency and recommended repair should be written in the Bridge Inspection Report (BIR).

1. **BIR Repair Note** – The State utilizes the following guidelines when describing and documenting deficiencies needing repair.
  - Deficiencies that require repairs shall be documented in the body of the BIR with the associated BMS elements.
  - The description of the deficiency should be concise and detailed, including location and size of the defect.
  - Photos of deficiencies requiring repairs shall be taken for proposed and completed repair of any priority. Multiple photographs of a defect, including an overall view along with close-ups, are recommended.
  - A “REPAIR” notation should be put in the individual element note with the appropriate repair number. The repair number is generated by BridgeWorks and is referenced in the “Repairs” tab of the program.

*Example:* Stringer F in Panel 2 at Floor Beam 2 has a 4-½” long crack at the top cope. See photo #7. REPAIR #12345.

2. **Repair Entry** – Repair entries for deficiencies found during the course of a bridge inspection shall be entered within the “Repairs” tab found in the BridgeWorks program.

The repair entry should include:

- Priority for the repair
- Repair responsibility for the repair
- Date when the repair was first noted
- Accurate description of the repair required
- Proper identification of specific repair location(s). (In addition to notes in the description, consider adding a map and/or spreadsheet to the Files tab for any case that might be at all confusing to those who may not be intimately familiar with our terminology and layout on a bridge.)
- Photograph(s) of the damaged area
- Notice of any difference in the bridge orientation (pier numbering) from that in the plan drawings accessible on BEIS

It is recommended that repair entries with multiple items similar in nature are contained within the same repair. Do not put multiple repair items in the same repair note, unless they are similar.

**Similar** – Replace 10 ft. red tagged (RT) timber cap at Pier 2 and 5 ft. RT timber cap at Pier 3.

**Not Similar** – Replace upper 10 ft. RT timber Pile 5A and entire RT timber cap at Pier 6.

Due to the number of repairs generated for similar components, the State utilizes standard descriptions for similar types of repairs called the “Repair Protocols” which are located at W:\Data\Bridge\BridgeRepair\Repair Protocols. Contact BPO for examples and additional guidance for the protocols. For any repairs that are likely to require additional repair instructions from the BPO office, advise the Bridge Preservation Supervisor and the Repair Specialist of that need.

3. **Repair Responsibility** – Repair responsibilities utilized within the BridgeWorks program organizes repairs into separate repair types. The state utilizes these repair types to assign responsibility to the various entities that will, in most cases, ultimately perform the repair.

The following repair responsibility codes are utilized by team leaders for the state.

- **B – Bridge Repair**

These repair responsibilities are generally associated with the bridge or conditions that impact elements of the bridge to include structural deficiencies, non-scour related erosion or conditions preventing proper inspection. Regional bridge crews are typically charged with completing these types of repairs for state structures.

*Note:* Regional Inspection staff are not expected to conduct in-depth inspection on bridge mounted signs and sign supports, but are expected to stay alert to obvious defects that can be safely observed and that may need further inspection and/or repair. Such defects on bridge mounted signs are to be communicated to the BPO sign bridge team at the first opportunity. They will typically provide repair recommendations via the Sign Bridge Repair List. But for a severe defect, direct communication to the regional bridge crew can and should be made if the BPO sign bridge crew is not available for quick response. Keep a record of any such communication and provide it to the BPO sign bridge team.

- **V – Vertical Clearance Repair**

This indicates that the bridge has restrictive overhead clearance for vehicular traffic and that no signing or improper signing is in place. Vertical clearance signs are required for measured clearances less than or equal to 15’-3” and the policy for the State is to post at a height 3” less than measured. Measured clearances less than 14’-3” require advanced restrictive height warning signs as defined in the updated MUTCD. State team leaders shall follow the guidelines in Section 3.04.1.J for further instructions on vertical clearance repairs. The Bridge Preservation Office (BPO) Geometry Engineer is tasked with keeping track of vertical clearance issues and repairs for State structures. Regional Sign crews are typically charged with completing these types of repairs for state structures.

• **S – Scour Repair**

This indicates that the bridge site needs to be evaluated for scour mitigation. A description of the condition of concern must be provided in the inspection notes. Repair actions to correct the condition should be included in the repair description. The BPO Scour Engineer or the Local Agency’s hydraulic engineer will review and may revise the recommended repair, the repair priority, or may deactivate the repair altogether after careful review of the bridge site. A note by the hydraulic specialist should be added to the inspection report detailing their findings, typically within the note of WSBIS Item 1680. Regional bridge crews are typically charged with completing these types of repairs for state structures.

Engineering scour mitigation requires the engineer to work closely with environmental agencies to develop the best corrective action plan for all. Erosion caused by runoff from the bridge is not considered a scour repair.

Team leaders for the state shall apply the following guidelines when selecting a Scour repair responsibility.

- For new scour repairs or monitoring, enter an (S) scour repair (responsibility) and assign it a Priority 0, see Section 6.04.A.4. Notify the Bridge Scour Engineer, including photos, sketches and any other information. Code BMS Element #361 in the BIR and provide notes with the date that the scour engineer was contacted. The scour engineer will review the conditions and set the priority.
- For existing repairs, for scour with a set priority, insure that the repair (responsibility) is changed from a (B) to an (S) and leave the existing priority as it is set. If the existing priority is (S), set it to 0 and notify the BPO Scour Engineer.
- When a change in condition to an existing repair for scour is identified, insure that the repair (responsibility) is changed from a (B) to an (S). Notify the BPO Scour Engineer, including photos, sketches and any other information. Code BMS Element #361 and describe the change noting the date that the scour engineer was contacted.

| Example      | Responsibility | Priority  |                                   |
|--------------|----------------|-----------|-----------------------------------|
| New Repair   | S              | 0         | Comment and notify Scour Engineer |
| Exist Repair | B S            | 1 (Leave) |                                   |
| Exist Repair | B S            | S 0       | Notify Scour Engineer             |
| Change       | B S            | 1 (Leave) | Comment and notify Scour Engineer |
| Verify       | B S            | 1 (Leave) | Comment and notify Scour Engineer |

• **R – Railroad Repair**

WSDOT conducts limited scope (non-structural and non-mandated) “Safety” inspections of railroad owned bridges that cross over state-owned highways. The R repair indicates that a railroad owned bridge crossing over a public highway has a condition that could pose a hazard to the motoring public, such as ballast falling onto the roadway. The repair description should include some indication of the relative urgency of the recommended repair. The inspecting highway agency (WSDOT or local agency) must ensure that all such repair recommendations are communicated to the appropriate department/individual



at the correct railroad. For higher priority conditions, consider reducing the inspection frequency.

**Note:** Vertical clearance signage needs on a railroad overcrossing will likely become the responsibility of the region. Assign such repairs the responsibility code V as outlined above.

- **U – Utility Repair**

This indicates that there is a deficiency with a utility (not owned by the bridge owner) mounted to the bridge. The inspecting highway agency (WSDOT or local agency) should ensure that all such repair recommendations are communicated to the appropriate department/individual at the correct utility. If the deficiency poses a safety risk to the traveling public or to bridge inspection and maintenance crews, or if the deficiency is creating a problem for the structural integrity of the bridge, then the repair recommendations must be communicated to the appropriate department/individual at the correct utility. The Risk Reduction Engineer may be able to facilitate the communication in urgent situations.

- **J – Roadway Repair**

This indicates that there is a non-bridge related deficiency in the roadway approach to a bridge. Regional roadway maintenance crews are typically charged with completing these types of repairs for State structures. Deck joints and defects on both sides of the abutment headers are B repairs and not J repairs.

4. **Repair Priority** – The priority of the required repair establishes the urgency at which the repair shall take place. The priority may evolve into a more urgent priority if repairs are not completed.

- **Emergency** – Repair work requiring immediate action when structures are partially or completely closed.
- **Urgent** – Repair work requiring prompt action and must be completed when structural details and bridge crews become available.

Emergency or Urgent repair needs must be communicated directly to the region maintenance staff (or bridge owner) via phone call and follow-up email. Copy the Bridge Preservation Supervisor and the Repair Specialist on any such communication.

There is no specific “Emergency” or “Urgent” priority designation in the inspection application and these repairs may not always end up being published in the Bridge Repair List on BEIS. (A not uncommon example of an emergency repair is a deck hole-through where the hole is reported to the region maintenance crew by others and they respond and fix it immediately. In such a case, the bridge office may not send a crew or prepare an inspection report until well after the defect has been repaired.) But whenever an emergency or urgent repair need is entered into the application, the repair entry must be assigned an appropriate priority from the following listings (usually Priority 1 but sometimes Priority C when a CDBRR event is involved.)

- **Priority C** – Priority C is to be assigned to any CDBRR related repair entry that must be completed before the bridge may be returned to the level of unrestricted service that existed before the event. Priority C is to only be used in conjunction with a CDBRR event. Do not use Priority C for repairs that do not directly lead to a lifting of the restrictions imposed as a result of the CDBRR event. Completion of a Priority C repair (by maintenance or by contract) will require follow-up by inspectors to verify the repair entry(ies), review condition coding, update the CDBRR, and disseminate the information to the appropriate individuals. Completion of a Priority C repair must be communicated directly to the Bridge Preservation Supervisor and the Repair Specialist. See Section 6.02.B for CDBRR reporting requirements.
- **Priority 1** – A Priority 1 repair describes a deficiency to a primary bridge element that could cause a major impact to the bridge such as load restrictions. This type of deficiency may lead to more extensive and costly structural repairs if not completed as soon as possible.  
Priority 1 is the highest priority assigned to a repair which **if** left uncompleted, could turn into an urgent or emergency repair during next inspection.  
**Priorities 1 and C** are the highest **priorities** that can be assigned within the inspection application.

These repairs are top priority to ensure:

- Public Safety
- Reliability of the Transportation System
- Protection of Public Investments
- Maintenance of Legal Federal Mandates

On occasion, the inspection frequency may need adjustment to ensure that conditions since the previous inspection have not deteriorated to urgent or emergency status, that safety of the traveling public has not become compromised, and that inspectors may verify that repairs have been done in a timely manner. Additionally, the Rating Revision flag (WSBIS Item 2688) may require a “Y” to reexamine the bridge for load carrying capability.

Examples of deficiencies requiring Priority 1 repairs are as follows:

- Repairing exposure of damaged strands and/or rebar.
- Removing or mitigating any existing potential for material falling from the bridge.
- Repairing significant joint defects that impact the bridge or create traffic hazards such as ‘D’ spalls in the header with exposed steel.
- Trimming or removal of trees, brush or debris that interferes with inspection procedures or equipment access. List the month and year of the next inspection by which this repair needs to be completed.

- **Priority 2** – A Priority 2 repair describes a minor to moderate deficiency to a primary bridge element or a major deficiency to a secondary bridge element. This type of deficiency would not cause major impact to the level of service of the bridge or compromise safety. But, this type of deficiency may lead to more extensive and costly structural repairs if not completed in a timely manner.

Priority 2 is different from Priority 1 in that a Priority 2 deficiency does not immediately jeopardize:

- Public Safety
- Reliable Transportation System
- Protection of Public Investments
- Maintenance of Legal Federal Mandates

A Priority 2 repair would not generally be cause for a reduction in inspection frequency or a reexamination of a bridge's load rating.

Examples of deficiencies requiring Priority 2 repairs are as follows:

- **Repair Yellow-tagged (YT) timber members.**
  - Repair spalling in secondary members.
  - Repair spalling in the deck soffit and/or concrete girders. If not excessive, this could be a Priority 3.
- **Priority 3** – A Priority 3 repair is generally a minor nonstructural or “Housekeeping” type of repair that could evolve into a higher priority if not corrected.

Examples of deficiencies requiring Priority 3 repairs are as follows:

- Cleaning of drains, bridge members or deck and sidewalk surfaces.
  - Remove debris from off of pier caps and abutments.
  - Remove garbage, debris or vegetation from around abutments piles or retaining walls.
  - (Note that all such repairs shall be elevated to priority 1 if the material of concern is significantly impeding operation of bridge structural components or is making complete structural inspection of the bridge impossible.)
- **Priority M** – Monitor repairs require no action from the region bridge crews, but they should be aware of the condition, since the problem/defect could evolve into a repair. A reduced inspection frequency may be necessary in order to monitor the problem/defect. The state utilizes the following guidelines when implementing and administering monitor repairs.
    - Every monitor repair note must be updated at each routine or interim inspection with a clear statement of findings. This update including the inspection date, inspector initials, and notes on the changed condition will be appended to the existing repair note. If the condition is unchanged state, “No changes noted” and include the year and initials. **This specific instruction applies to monitor repairs only.**

- Every monitor repair note must include measurable information about the condition of interest, allowing subsequent inspectors to more easily and accurately determine if the condition is changing. Photos, sketches, and/or measurements are among the ways to provide this information, which must also clearly include location and date. It may be appropriate to reference an attached file with historical data in the monitor repair note.
- Over time, every monitor repair note will provide information on what circumstances warrant repair action. Inspectors will be expected to provide this information when possible, but it is recognized that this information may require more detailed evaluation and structural analysis beyond the scope of bridge inspection work.

Some existing monitor repairs may not meet the requirements listed above. In this case, please coordinate with the Bridge Preservation Supervisor to determine if a monitor repair is appropriate.

- **Priority 0** – A Priority 0 repair is typically used only for J repairs and other repairs not directly attached to, or affecting the bridge. This priority is also used for new scour repairs, as a flag to the WSDOT Scour Engineer, to indicate the need for review and actual assignment of the proper priority.

However, for J and U repairs, inspectors must use judgment in determining the impact of the situation. If an existing condition directly impacts the structure, presents a safety hazard, or interferes and prevents the bridge from being properly inspected a Priority 1 should be assigned. Conditions creating a hazard to pedestrians or traffic need to be reported to the region by the inspector as soon as possible and a note of the communication identifying the date, time and point of contact should appear in the repair note.

## B. Modifying Existing Repairs

When there is need to change or update the verbiage within a repair entry after subsequent inspections, team leaders for the State shall apply the following guidelines when modifying the repair.

- The team leader shall add his/her initials along with a date in parenthesis with a brief description of any changes to an existing repair note, including a priority change.
- Minor edits to repair text (spelling, caps, minor grammatical changes) should generally be avoided unless something else is being done to the entry.
- **Edits to repair priority entries other than priority M need be made only when the conditions/needs change sufficiently to warrant an update.**
- If a significant change to a repair is needed, eliminate the original repair entry by entering a date in the “Verified” column. Add a note in parenthesis in the repair description stating reasons for its removal, and then enter a new repair with the original repair date in the “Noted” field. (The application typically enters today’s date in the Noted field when a new repair is created. The Noted date can be changed by the inspector and must be changed in all cases where the contents of a previous repair entry are entered into a new repair entry.)
- Break out and rewrite repairs when dissimilar elements are called out in the same repair as described in Section 6.04.A.2. Date the new repair with the original repair date for the respective elements.

### C. Repair Verification

At each routine inspection, the current status of all open (not previously verified) repair entries must be reviewed by the inspection team and field reviewed provided the necessary access equipment is available. If the recommended work has been completed, the repair entry in the BIR shall be verified in accordance with the following guidelines.

- BMS element condition states and notes where the repairs are referenced must be updated to accurately describe the repaired condition after the inspection.
- Any portion of a primary BMS element that has been repaired is typically coded in Condition State 2. Primary members that have been completely replaced should be returned to Condition State 1.
- A completed repair should have before and after photos with the verification date and the repair number referenced in the individual BMS element note. Remove this verification note during the subsequent inspection.

**Example:** Stringer F in Panel 2 at Floor Beam 2 crack has been stop drilled. REPAIR #12345 verified on 1/20/02. See photos #7 and #9.

- In the “Repairs” tab of BridgeWorks, the team leader should enter the verification date within the “Verified” column and attach the after photos to the “Photo” column.
- Explain in the repair description why verification could not be accomplished and what it will take to do so for the next inspection (equipment, environment, etc.).

Repairs to state structures are most often performed by region bridge maintenance crews. Their work is often reported to BPO via a Maintenance Bridge Repair Report (MBRR) (see also Section 6.05). When this is done, the BridgeWorks application uses the info entered in the MBRR to enter a Maintenance Date (Maint).

The Maint date informs the bridge inspection team that the work specified by the repair entry has been completed. Once the date is entered, the responsible maintenance crew does not typically revisit this repair entry. The bridge inspection crew’s responsibility at this point is to verify that the reported maintenance satisfactorily completes the recommended repair(s). When a Maintenance date has been entered, consideration should be given to the need to schedule appropriate access equipment prior to heading out to the field. Discuss with your supervisor as needed.

There are, on occasion, repair entries within BridgeWorks that contain inappropriate or unexplained maintenance completion dates. Scenarios include, but are not limited to:

1. The work performed does not complete the full scope of the original repair recommendation;
2. The work performed is not satisfactory;
3. Further deterioration has occurred rendering the work performed inadequate;
4. There is no visual evidence of any work done; (e) the work performed belongs in fact to a different repair entry (i.e., the MBRR was improperly entered).

In cases such as these, correction is needed to ensure that the repair needs continue to be properly communicated back to the region bridge maintenance crews.

The team leader shall apply case-by-case judgment in making these corrections. Two primary options should be considered:

- **Option A** – Add a verified date with photos and/or notes in the repair description (does not have to be both provided there is no question of the intent). Write a new repair entry with appropriate supporting information and noting the changes being made. (*Example:* A repair entry of large scope has been partially completed. The existing entry could be verified, the description modified to note the portion that was completed, and the new entry would be referenced. The new repair entry would reference the old entry, note the partial completion and would describe the remaining scope. In most cases, the noted date of the new entry should be the same as the original entry.)
- **Option B** – Enter an Override Date in the BridgeWorks application. Modify the repair description to explain the reason for the override and provide the date and initials of the author. (This option may be most appropriate for a case where the Bridge Repair report was incorrectly entered. It could also be appropriate for the case where only a small part of the overall scope of a repair was addressed by the work in the Bridge Repair Report.)

In some extreme and/or complex cases, direct communication with the region bridge maintenance crew to explain the situation may also be advisable.

## 6.05 Maintenance – Bridge Repair Report (MBRR)

The repair descriptions from the inspection reports for WSDOT-owned bridges are entered into the “Bridge Repair List” (BRL - a state document), which can be viewed on the internal homepage of the WSDOT website. The BRL is updated twice a year. Maintenance crews for the State will review the list and schedule the work to complete selected bridge repairs. When a repair is completed, the maintenance crew may submit a Maintenance – Bridge Repair Report (MBRR) documenting the completed repair. The MBRR is typically submitted electronically via a link provided on the Bridge Repair List website. If submitted electronically, the program inserts a “maintenance date” for that repair into the database. Entering the maintenance date will automatically remove the repair from the next edition of the printed active “Bridge Repair List”. However, the unverified repair along with the maintenance date will still appear in the next Bridge Inspection Report (BIR). The MBRR is a state document, but it is available to Local Agencies for utilization if they do not have a bridge repair documentation process in place.

An example of a completed Maintenance - Bridge Repair Report can be found at the end of this chapter.

## 6.06 Forms

Critical Damage Bridge Repair Report

Critical Damage Bridge Repair Report - Instructions

Maintenance - Bridge Repair Report Example

|                                                                                                                                                              |                                  |                                                                   |                                                     |                          |
|--------------------------------------------------------------------------------------------------------------------------------------------------------------|----------------------------------|-------------------------------------------------------------------|-----------------------------------------------------|--------------------------|
|  <b>Washington State<br/>Department of Transportation</b>                   |                                  | <input type="checkbox"/> CDBRR<br><input type="checkbox"/> Update |                                                     |                          |
| <h2>Critical Damage Bridge Repair Report</h2>                                                                                                                |                                  |                                                                   |                                                     |                          |
| Agency Name                                                                                                                                                  | Structure ID                     | Bridge Number                                                     | MP                                                  | Incident Date            |
| Bridge Name                                                                                                                                                  |                                  | CDBRR Date:                                                       | Check all that apply<br>(Top three require a CDBRR) |                          |
| Lead Inspector's Name/CDBRR Author                                                                                                                           |                                  | Lead Inspector's Cert#                                            | Bridge Closure                                      | <input type="checkbox"/> |
| Co-Inspector's Name                                                                                                                                          |                                  | Inspection Date                                                   | Lane Closure                                        | <input type="checkbox"/> |
| Incident Reported to BPO by                                                                                                                                  |                                  | Date Reported                                                     | Temporary Load Posting                              | <input type="checkbox"/> |
|                                                                                                                                                              |                                  |                                                                   | Other Restriction                                   | <input type="checkbox"/> |
|                                                                                                                                                              |                                  |                                                                   | Phone No:                                           |                          |
| <b>Incident</b>                                                                                                                                              |                                  |                                                                   |                                                     |                          |
| Description of Incident                                                                                                                                      |                                  |                                                                   |                                                     |                          |
| Description of Damage to the Structure                                                                                                                       |                                  |                                                                   |                                                     |                          |
| Mitigation Measures Taken (And explain in more detail any closures, postings, restrictions or other actions taken)                                           |                                  |                                                                   |                                                     |                          |
| Description of Recommended Repair(s) (This may be added while on-site or sometime after the field visit prior to submitting)                                 |                                  |                                                                   |                                                     |                          |
| <b>Intermediate CDBRR Update:</b>                                                                                                                            |                                  |                                                                   |                                                     |                          |
| Description of Update:                                                                                                                                       |                                  |                                                                   |                                                     |                          |
| Update Submitted By:                                                                                                                                         |                                  | Date Submitted:                                                   |                                                     |                          |
| <b>Post Repair Update : For use by the Repair Specialist</b><br>This section to be completed within 1 month after verified completion of recommended repair. |                                  |                                                                   |                                                     |                          |
| Description of Work Done                                                                                                                                     |                                  |                                                                   |                                                     |                          |
| Date of Repair Completion or BPO Verification<br>Date If Completion Date Is Unknown                                                                          | Update Submitted By (Print Name) |                                                                   | Date Submitted                                      |                          |

### Critical Damage Bridge Repair Report



A CDBRR is required whenever one of the four conditions in the red box below have been executed.

|                                                                                                                                        |                        |                                                                                                                                                                                                           |                                                                   |                |
|----------------------------------------------------------------------------------------------------------------------------------------|------------------------|-----------------------------------------------------------------------------------------------------------------------------------------------------------------------------------------------------------|-------------------------------------------------------------------|----------------|
|  <b>Washington State Department of Transportation</b> |                        |                                                                                                                                                                                                           |                                                                   |                |
| <h2>Critical Damage Bridge Repair Report</h2>                                                                                          |                        |                                                                                                                                                                                                           |                                                                   |                |
| Agency Name                                                                                                                            | Structure ID           | Bridge Number                                                                                                                                                                                             | MP                                                                | Incident Date  |
| Bridge Name                                                                                                                            |                        | CDBRR Date:                                                                                                                                                                                               | <input type="checkbox"/> CDBRR<br><input type="checkbox"/> Update |                |
| Lead Inspector's Name/CDBRR Author                                                                                                     | Lead Inspector's Cert# | Check all that apply<br><input type="checkbox"/> Bridge Closure<br><input type="checkbox"/> Lane Closure<br><input type="checkbox"/> Temporary Load Posting<br><input type="checkbox"/> Other Restriction |                                                                   |                |
| Co-Inspector's Name                                                                                                                    | Inspection Date        | Phone No:                                                                                                                                                                                                 |                                                                   |                |
| Incident Reported to BPO by                                                                                                            | Date Reported          |                                                                                                                                                                                                           |                                                                   |                |
| <b>Incident</b>                                                                                                                        |                        |                                                                                                                                                                                                           |                                                                   |                |
| <b>Description of Incident</b>                                                                                                         |                        |                                                                                                                                                                                                           |                                                                   |                |
| These text fields expand as the line is filled. If more than 255 characters are in any of these lower boxes                            |                        |                                                                                                                                                                                                           |                                                                   |                |
| <b>Description of Damage to the Structure</b>                                                                                          |                        |                                                                                                                                                                                                           |                                                                   |                |
| the boxes will be outlined with red dashed lines. Ignore the validation error pop-up box when saving the file                          |                        |                                                                                                                                                                                                           |                                                                   |                |
| <b>Mitigation Measures Taken</b> (And explain in more detail any closures, postings, restrictions or other actions taken)              |                        |                                                                                                                                                                                                           |                                                                   |                |
| Save the file following the prescribed naming convention.                                                                              |                        |                                                                                                                                                                                                           |                                                                   |                |
| <b>Description of Recommended Repair(s)</b> (This may be added while on-site or sometime after the field visit prior to submitting)    |                        |                                                                                                                                                                                                           |                                                                   |                |
| Create a PDF copy and store both that and the .xml copy in the Bridge Damage folder.                                                   |                        |                                                                                                                                                                                                           |                                                                   |                |
| <b>Intermediate CDBRR Update:</b>                                                                                                      |                        |                                                                                                                                                                                                           |                                                                   |                |
| <b>Description of Update:</b>                                                                                                          |                        |                                                                                                                                                                                                           |                                                                   |                |
| This text field expands as the line is filled.                                                                                         |                        |                                                                                                                                                                                                           |                                                                   |                |
| Update Submitted By:                                                                                                                   |                        | Date Submitted:                                                                                                                                                                                           |                                                                   |                |
| <b>Post Repair Update : For use by the Repair Specialist</b>                                                                           |                        |                                                                                                                                                                                                           |                                                                   |                |
| This section to be completed within 1 month after verified completion of recommended repair.                                           |                        |                                                                                                                                                                                                           |                                                                   |                |
| <b>Description of Work Done</b>                                                                                                        |                        |                                                                                                                                                                                                           |                                                                   |                |
| Date of Repair Completion or BPO Verification                                                                                          |                        | Update Submitted By (Print Name)                                                                                                                                                                          |                                                                   | Date Submitted |
| Date If Completion Date Is Unknown                                                                                                     |                        |                                                                                                                                                                                                           |                                                                   |                |

Do not fill out this section outlined in red unless returning to the site to report on the repairs that have been completed - The Update Report type up above (top right corner) would be selected at this time.

The final procedure once the form is completely filled out is to create a pdf copy of it for placement into BridgeWorks. The XML file should not be placed in BridgeWorks. Place both copies (XML & pdf) in the Damage folder with any other documentation, photos etc. per WSBIM procedures in Ch. 6.

### Critical Damage Bridge Repair Report - Instructions

BEIS - Maintenance Report

Page 1 of 1

To: Bridge Preservation Office  
 PO Box 47341, Olympia, WA 98504-7341

Maintenance Date 2006-07-18

|                                                                                                                          |                                                                       |
|--------------------------------------------------------------------------------------------------------------------------|-----------------------------------------------------------------------|
| Structure Identifier <b>0005090A</b>                                                                                     | 10000                                                                 |
| Bridge Number <b>5/321</b>                                                                                               | Bridge Name <b>CAPITOL LAKE</b>                                       |
| Mile Post <b>104.52</b>                                                                                                  | Location <b>0.5 N JCT US 101</b>                                      |
| <hr/>                                                                                                                    |                                                                       |
| <b>Repairs Completed By</b>                                                                                              |                                                                       |
| B - Bridge Maintenance                                                                                                   |                                                                       |
| <hr/>                                                                                                                    |                                                                       |
| <b>Origin of Repairs</b>                                                                                                 |                                                                       |
| B - Bridge Repair List                                                                                                   | Repair No <b>S10000</b> , Priority <b>1</b> , Dated <b>2003-12-03</b> |
| <hr/>                                                                                                                    |                                                                       |
| <b>Repair Description</b>                                                                                                |                                                                       |
| Repair the strip seal at the north abutment. (verified - repair completed but has failed again; see new repairs 10002-4) |                                                                       |
| <hr/>                                                                                                                    |                                                                       |
| <b>Type of Materials Used - Suppliers</b>                                                                                |                                                                       |
| Sand blast and sika-flex with backer rod                                                                                 |                                                                       |
| <hr/>                                                                                                                    |                                                                       |
| <b>Repair Remarks and Details</b>                                                                                        |                                                                       |
| Cleaned expansion joint by sand blasting and poured sika- flex joint.                                                    |                                                                       |
| <hr/>                                                                                                                    |                                                                       |
| <b>Weather Conditions</b>                                                                                                |                                                                       |
|                                                                                                                          |                                                                       |
| <hr/>                                                                                                                    |                                                                       |
| Completed By Steve McIntyre                                                                                              | Posted Date 2006-07-18                                                |
| Map Repair No                                                                                                            |                                                                       |

**Maintenance - Bridge Repair Report Example**

### 7.01 General

This chapter establishes policies on how the Washington State Department of Transportation (WSDOT) and local agencies within the state of Washington conduct quality control/quality assurance (QC/QA) on its respective bridge inspection programs to meet FHWA requirements within 23 CFR 650.307(c) and §650.313(g).

The guidelines presented herein are those in use by both the WSDOT Bridge Preservation Office (BPO) and Local Programs (LP). Sections 7.02 through 7.08 pertain to the QC/QA program implemented by the BPO. Sections 7.09 through 7.11 pertain to the QC/QA program developed by the LP Office. Local Agencies are encouraged to follow these guidelines so as to provide a consistent basis for evaluation and reporting of inspection data.

The QC/QA programs documented in this chapter, including the appendices, have been approved for use by the Federal Highway Administration (FHWA.) As an alternative, individual agencies may choose to establish their own QC/QA policies and procedures. The procedures will require documentation similar to what is discussed in this chapter and meet the approval of the SPM or named delegate as well as the FHWA Division Bridge Engineer within the state of Washington.

Any QC/QA program being developed will want to reflect on the five areas identified in §650.307 through §650.315. A thorough QC/QA program will examine these five areas as well as any internal policies and procedures established within a given agency as a means of determining whether or not the inspection program maintains what FHWA defines as a high degree of accuracy and consistency.

The five topics identified in 23CFR 650 include:

- Bridge Inspection Organization (§650.307)
- Inspection Staff Qualifications and Re-Certification (§650.309)
- Inspection Frequency (§650.311)
- Inspection Procedures (§650.313)
- Inventory (§650.315)

There are also many sources of information available that can help an agency in developing their own QC/QA programs. One particularly helpful is a document written by Dr. Glen Washer and Dr. C. Alec Chang entitled *Guideline for Implementing Quality Control and Quality Assurance for Bridge Inspection*. AASHTO sponsored the creation of this document completed in June 2009 to help those agencies in need of assistance in developing their own QC/QA programs. Section 1.4 from that document identifies seven characteristics that are common to effective programs.

These include:

1. Independent Reviews.
2. Objective and quantitative measures of quality.
3. Quality program documentation.
4. Comprehensive coverage of the inspection and load rating program.
5. Established procedures for corrective actions.
6. Established schedule for evaluations.
7. Documented review procedures.

The section concludes by saying that these characteristics of effective programs can be used in many ways and methodologies depending upon an agencies specific programmatic characteristics and needs.

## 7.02 WSDOT Bridge Preservation Office Quality Control Program

### A. Purpose

To establish within management a diverse set of quality control (QC) procedures to be used in the BPO in order to maintain a high degree of accuracy and consistency within the BPO inspection program. These procedures have been developed uniquely for each of the different units in the office. The procedures focus on the following areas:

- Qualifications of designated positions within the office.
- Maintaining bridge information (electronic and physical information).
- Management/analysis of bridge load rating and bridge scour.
- Office review and Field verification of information and conditions collected in bridge inspection reports.

The QC program's role is to evaluate and communicate directly with staff, any assessments made of their work. BPO policy and practices should be evaluated throughout this process and be addressed and adjusted accordingly in order to create a more consistent and accurate inspection program.

### B. Definitions

Quality control is defined in *National Bridge Inspection Standards (NBIS) Regulation 23 CFR 650.305 Definitions* as those procedures intended to maintain the quality of a bridge inspection and load rating at or above a specified level. QC is performed within a work group.

### C. Time Frame of Evaluation

This is an ongoing process throughout the year by each of the individual units within the office.

### D. Personnel

To meet the federal requirements identified in 23 CFR 650 for Bridges, Structures and Hydraulics, the BPO has five distinct units that work together. These units consist of the following:

- Coding and Appraisal Unit
- Regional Inspection Unit
- Risk Reduction Unit
- Special Structures Unit
- Underwater Inspection Unit

The QC program will be administered by the supervisor in each of these respective units. There may be portions of the work that are delegated to staff positions. This work will be addressed further below in each of the individual units.

## 7.03 Coding and Appraisal Unit

The Coding and Appraisal Unit is led by the Coding and Appraisal Engineer and is responsible for administering QC procedures within the unit. Listed below are those areas identified in 23 CFR 650 that require defined QC procedures. These procedures may be delegated to others within the unit at the discretion of the Coding and Appraisal Engineer.

### A. Bridge File Maintenance

There are two positions within the Coding and Appraisal Unit that work at maintaining both the physical and electronic bridge files. These are parallel positions (Resource Technician and Inventory Technician) that operate as QC for each other.

**Physical Letter Files** – The Resource Technician performs an annual audit by comparing a current list of bridges from the Washington State Bridge Inventory System (WSBIS) database against the physical letter files. All conflicts between the electronic list and the physical letter files are addressed, validating both the physical and electronic portions of the bridge files. This audit has three QC functions:

- Identifies physical letter files that are missing so they can be recovered.
- Validates the accuracy of the electronic database with respect to the bridges listed in the inventory.
- Ensures that records for bridges that have been added, transferred, or removed from the inventory are complete and accurate.

Verify that all signed inspection reports from the previous year made it into the letter file.

There are two types of letter files depending on the type of inspection a bridge receives. Appendix 7.12-A provides information on what is contained in each of these two types. The physical letter files are located in the Bridge Resource Room (Room #2041). See the attached Bridge Office floor plan in Appendix 2.06-A for locations of the other various types of physical files kept in the office.

**Electronic Files** – The Resource Technician is also responsible for scanning electronic copies of signed inspection reports which are placed in the physical letter files, for placement in the electronic file for a particular bridge. The Inventory Technician is assigned the task of QC of this scanning process, reviewing 10 percent of the electronic files for accuracy and completeness.

Items reviewed include whether the final inspection report form was the “released” version of the report, all pages are included, all inspection types listed on the first page are included, and that the Team Leader signed the report. Once the spot check has been performed by the Inventory Technician on a batch of inspection reports, the Resource Technician uploads the reports on the BEIS server for access by all with the privileges to do so.

## **B. Processing Inspection Reports**

**Field Inspections** – Bridge inspection reports are processed by the Bridge Data Steward after all the QC is complete between inspectors and supervisors. The Bridge Data Steward performs the following QC actions:

- Validates that the QC process between the inspectors and supervisors was performed (initials required on WSBIS sheet used to initiate inspection processing).
- Checks changes made to all codes in WSBIS report for reasonableness and consistency.
- Runs automated error checks within BridgeWorks application. See BPO coding guide for a detailed list of error checks.
- Checks to ensure that inspection report types are used correctly, and that when multiple report types are used in a single inspection that they all have the same inspection date.

When these checks are completed and errors corrected, the Bridge Data Steward “releases” the inspection data into the “State System Bridge Inventory” database.

The Bridge Data Steward then prints out a fresh copy of the bridge inspection report with released data, and sends that to the bridge inspectors for signature. The Bridge Data Steward then sends the WSBIS report with initials validating the inspector QC process to the Bridge Resource Technician, who also receives the signed inspection reports from the inspectors for scanning and filing. This WSBIS report is matched against the signed inspection reports to ensure they are returned to the Bridge Resource Technician for final processing as described above. The WSBIS report with QC initials is then filed for auditing purposes. These changes will then be permanently recorded in the database and immediately visible on the BEIS website.

**Informational Inspections** – The “State System Bridge Inventory” database often needs updated information from sources other than field bridge inspections. This includes updates to traffic or route information and setting flags for inspectors to take measurements or other specific field work that should be performed during the next field inspection. In all cases, a note is added to the informational inspection describing the changes made.

When single bridges or a small number of bridges need updating for new non-inspection data, the electronic data is reviewed and processed by the Bridge Data Steward prior to releasing into the database, though no printouts, signatures, scanning or filing is done. When batch updates are performed on a large number of structures, the Bridge Data Steward is involved in reviewing the changes, but the release process is done automatically by the BridgeWorks Application Engineer. Similarly, informational inspections are also created by the Bridge Preservation Supervisor as needed to make changes to bridge repairs. These changes are not reviewed by the Bridge Data Steward.

### **C. Coding New Bridges**

The Bridge Inventory Technician has primary responsibility for tracking the construction of new bridges and entering them into the “State System Bridge Inventory” database. See the attached flowchart in Appendix 7.12-B that describes this process. This involves considerable coordination with many individuals both within BPO and other offices in WSDOT to obtain complete and accurate information. Due to this complexity, the flow chart is considered part of the QC process since it plays a key role in ensuring that all steps are taken.

QC of the inventory process consists of the following:

- All plan sheets are reviewed by the Bridge Resource Technician prior to loading onto BEIS to ensure that the sheet labels are correct and that the image is complete and legible.
- The new bridge inventory data is created as an Inventory report type, and is reviewed by the Bridge Data Steward prior to release into the “State System Bridge Inventory ” database.

### **D. Data Concurrency**

The Bridge Geometric Engineer is responsible to make sure that selected WSBIS fields have data that is reasonably concurrent with other WSDOT databases which serve as sources for these fields. Since this is a manual operation at this time, data queries are initiated with several other offices once per year in the late summer and the WSBIS is updated with the revised data in the following winter. The WSBIS fields managed this way are included in Appendix 7.12-C.

In order to obtain complete information on these selected fields from other databases in WSDOT, these external databases must have a complete and current list of bridges in the WSBIS and selected location information accurately coded. Regular communication and cross checking between the Bridge Geometric Engineer and the data stewards for these other external databases ensures this data integrity and concurrency, and has significant quality benefits for both the WSBIS and other databases with shared information.

### **E. Vertical Clearance and Clearance Posting**

The Bridge Geometric Engineer manages the collection of vertical clearance data for all bridges intersecting state routes. In most cases, this consists of providing guidance to bridge inspectors on when and how to collect vertical clearance data, and reviewing and entering this data after it has been collected. This work serves as a QC mechanism for the vertical clearance data and for any bridge posting recommendations that result from vertical clearance findings.

### **F. Inspector Certification**

Every Team Leader and assistant is responsible for keeping their own records. Their supervisors will track certification training records during each PMP and provide this information to BridgeWorks Application Engineer for implementation into the Bridgeworks software. Acceptable recertification courses or conferences as established by the Statewide Program Manager (SPM) can be found in Chapter 1. Inspectors who meet the qualifications retain active certification in the BridgeWorks software and retain accounts as needed to create bridge inspection reports.



## G. Inspection Status Report and Performance Indicators

The BridgeWorks Application Engineer maintains a database and reporting tool called the Inspection Status Report (ISR) that serves as a “management dashboard” for the BPO. The ISR identifies bridges due for inspection and tracks their inspection progress. It also creates a record of NBI compliance for on-time inspection for federally reported inspection types. The ISR is considered a QC process for the entire bridge inspection operation.

## 7.04 Risk Reduction Unit (Load Rating)

The Load Rating group is led by the Risk Reduction Engineer who is responsible for administering QC within the group. QC consists of procedures defined below that will assess load rating work completed by consultants as well as what is completed in-house. Currently those load ratings completed by consultants and in-house consist of state owned bridges that meet the federal definition of a bridge. QC levels 1 and 2 listed below will be applied to all ratings submitted to the load rating section.

### A. QC Criteria

All state owned bridges (owner code 1), that qualify as an NBI reportable bridge with new load ratings shall be reviewed per Level 1 as described below.

#### Level 1 –

- Verify that a stamped summary sheet is included in the rating file.
- Evaluate the rating factors, do they make sense? For example is the OL1 RF greater than OL2 or the RF for AASHTO 1 greater than HS20.
- Verify that all elements/members that require ratings are rated.
- Verify that preliminary calculations are included in the submittal, especially for complex structures for accuracy. These files might include dead loads, factors, and any assumptions used in the calculations.
- Verify that the rating represent the condition of the structure based on the latest inspection report.
- Verify that each bridge’s physical characteristics are modeled properly.
- Verify reinforcing/pre-stressing; typically check points at maximum stress.
- Verify that dead and live loads are modeled properly.
- Verify that the inventory and operating tons are updated in BridgeWorks and the posting matches the rating where needed.

**Level 2 –** This will require an independent load rating of 3 percent of the structures from Level 1. Rating factors and condition of the superstructure or substructure will be the main factors in choosing the bridges. That is, bridges with low rating factors or have an NBI code less than 5 for superstructure or substructure will have higher priority for review.

## 7.05 Risk Reduction Unit (Scour Group)

The Scour Group is also led by the Risk Reduction Engineer and is responsible for administering QC within the group. QC tasks may be delegated to the Scour Engineer at the discretion of the Risk Reduction Engineer. QC of scour items will consist of procedures defined below to assess the scour work completed by the Regional and Special Structures Inspection Units as well as that of the Scour Group. QC will also verify that new structures added to the inventory are properly designed for scour and are not scour critical.

**Note:** The criteria set below contain QA elements.

### A. Bridge Selection Criteria

All state bridges in which the scour code has changed since the last inspection. All state bridges in which the POA has changed in regards to new directions to the regions. These two items will be verified for validity.

In addition, a list of 60 bridges over water will be selected randomly from the previous inspection season. Of the bridges selected, 40 of them shall have a scour code of 3, 4, or 7.

### B. Office Review

- Verify that each bridge over water has a scour summary sheet, scour calculations if appropriate, a bridge layout sheet and initial ground line drawings.
- Verify that the bridge is properly coded based on scour calculations.
- Verify that each scour critical bridge has a Plan of Action and that it has clear direction for the field staff to follow.

### C. On Site Field Review

- Verify that the scour code in the bridge inspection report is correct and that it reflects the field conditions.
- Verify that the scour code note added to all bridges over water, has clear and direct information.
- Verify any scour related concerns, exposed footings, channel migration, presence or need for countermeasures.
- Verify that the POAs reflect the conditions in the field.

## 7.06 Regional and Special Structures Inspection Units

The responsibility of structural inspections has been divided between three supervisors within the BPO. There are two Regional Inspection Engineers that oversee the bulk of the state inventory of bridges within the state of Washington. One Special Structures Engineer oversees the more unique types of structures within the inventory.

### A. Office Review of Structural Inspections

A Regional Inspection Engineer or a second Team Leader will review 100 percent of High Risk, Fracture Critical, In-Depth, Interim, Damage, Special Feature, 48 month frequency, Inventory and Local Agency inspection reports under their responsibility, with the exception being those that qualify for "Team Leader Approval." See Appendix 7.12-D for specific criteria. The reviews are targeted in such a manner that all Team Leaders have close to an equal number of bridges reviewed.

The Special Structures Engineer reviews 100 percent of all Special Structure reports under his area of responsibility.

The office review of reports will consist of the following validation for accuracy and consistency:

- **Inspection Type** – The appropriate inspection types are identified.
- **Inspection Date** – Ensure that bridges are inspected on time.
- **Inspection Frequency** – Verify that inspection frequency is based on condition or policy (i.e., 48 month frequency criteria).
- **Inspection Hours** – Verify that the correct inspection hours are reported based on history of previous report hours, structure type and condition.
- **Accounting Codes** – Verify that the correct accounting codes are used.
- **Organization of Report** – Verify that the report is organized, understandable, uses correct photo and file references that follow office policy.
- **Proper Inspection Forms** – Verify that the appropriate inspection forms are included in the reports.
- **Soundings and Ground Lines** – Verify if bridge requires soundings. If required, verify that soundings and ground lines are correct and completed.
- **Inspection Resources** – Verify that the appropriate resources needed for safety, access, and adequate inspection are being used.
- **NBI Codes** – Verify that the NBI codes are supported by inspection report content.
- **BMS Elements** – Verify that the BMS elements are complete and accurate.
- **BMS Condition States** – Verify that the BMS condition states are supported by the inspection report content.
- **Repair Recommendation and Priorities** – Verify that appropriate repairs and repair priorities are recommended based on inspection report content.
- **Follow-Up Actions on Significant/Critical Findings** – Ensure deficiencies that require immediate action have had the proper parties notified and are being monitored and/or followed up on.
- **Follow-Up on Damage and Critical Damage Bridge Repair Report (CDBRR) Reports** – Verify that CDBRR's and Alerts have updated information added such as future repaired dates and/or completed repairs.

Additional QC measures that are associated with the inspection program consist of the following:

- Regional Inspection Team Leaders are scheduled to inspect bridges randomly. This limits the chances of the same bridge getting inspected by the same Team Leader repetitively.
- Regional Inspection Engineers have the opportunity to review reports written by all Regional Team Leaders. The two Regional Inspection Engineers participate in a two year rotation in which one is responsible for reviewing all Local Agency inspection reports inspected by the BPO. All Regional Team Leaders (under both Regional Inspection Engineers) are assigned to inspect these Local Agency bridges. This allows the Regional Inspection Engineer on that particular rotation to review reports and provide feedback to all Regional Team Leaders, not just the Team Leaders working under them.

- All changes made or suggested for any particular report during the QC review process must be agreed upon by the Team Leader responsible for the final submittal of the report. In the event of a disagreement, the Bridge Preservation Engineer shall intervene as arbitrator to determine a final solution to the matter.

Documentation of reports reviewed includes, but is not limited to bridge name, inspector name, date bridge inspected, date reviewed and review state (APPROVED, APPROVED AS NOTED(AAN) OR RETURN FOR CORRECTION(RFC)). Example office review forms are included in Appendix 7.12-E and 7.12-F.

## **B. Field Review of Structural Inspections**

Each year, 2 percent of all structural inspections are selected for field review. Structures are selected from a list of current year inspections, along with a concurrent review of the prior inspection. The reviews are targeted in such a manner that all Team Leaders have close to an equal number of bridges reviewed.

During the field review, the primary focus is to evaluate the accuracy of:

- NBI inventory items.
- NBI ratings of condition codes.
- Bridge BMS elements.
- Bridge BMS element condition states.
- Written or omitted repairs.
- Proper safety procedures.
- Areas of improvement.

Field reviews allow the supervisor an opportunity to see how the various Team Leaders are evaluating structures, relative to how the supervisor would evaluate the same structure. The expectation for coding NBI data items for “Deck, Super, and Substructure,” relative to the supervisors rating, are for the NBI condition codes to be within plus or minus 1 except for codes less than 5. Codes of 4 or less should not deviate at all, unless there are changed conditions warranting an updated code. For the BMS elements, there should be no missing elements. For BMS condition states, verbiage in the report should be supportive of the condition state ratings and quantities. For repairs, all repairs need to be supported by inspection findings.

All deviations from the above standard are documented, and the supervisor shall dialogue one-on-one with the Team Leader responsible for the report concerning all deviations. It is the responsibility of the supervisor to determine if more training is necessary for the Team Leader, or if other measures need to be taken to insure consistency of the bridge inspection reports. A field review form is included in Appendix 7.12-G.

## 7.07 Underwater Inspection Unit

The Underwater Inspection (UW) Unit within the BPO focuses on the structural inspection of substructure bridge elements identified to be in water deeper than 4 feet. The Special Structures Engineer has the responsibility of administering QC procedures identified below for this unit.

### A. Underwater Inspection Office Report Review Process

Reviews of UW inspection reports are based on the type and condition of the bridge inspected. A complete office review is performed for all bridges that fall into one of the following categories:

- Local Agency owned.
- Washington State Ferry terminals.
- Scour critical bridges (scour code of 3 or less).
- Structures with exposed footings.
- Bridge with repairs associated with the underwater inspection findings.

The review ensures that all documentation is included to support the underwater findings. This includes:

- Correct substructure coding (based on inspection findings).
- Sketches and drawings showing the extents of underwater inspection.
- Documentation of ground lines around all piers.
- Drawings showing the location and extents of all defects.
- Drawings showing the current channel cross section.
- Repairs must be adequately described and written into the text of the inspection findings.

A UW report checklist is used to make sure the report package is complete.

### B. Field Review of Underwater Bridge Inspections

The Special Structures Engineer accompanies the underwater bridge inspection team for 5 percent of all of the inspections performed each year.

## 7.08 WSDOT Bridge Preservation Office Quality Assurance Program

### A. Purpose

To conduct an independent annual evaluation of the adequacy of the bridge inspection program within the BPO in meeting the FHWA requirements as defined in the §650.307 through §650.315, as well as office policy, procedures and best management practices established in the WSBIM. The program will also assess the adequacy and consistency of QC procedures in place within the BPO.

### B. Definitions

Quality assurance (QA) is defined in §650.305 as the use of sampling and other measures to assure the adequacy of QC procedures to verify or measure the quality level of the entire bridge inspection and load rating program. QA is administered from outside a work group.

### C. **Timeframe of the Quality Assurance Evaluation**

QA will be conducted on bridges inspected in the previous inspection season. See Appendix 7.12-H for details on the selection process.

### D. **Personnel**

To meet the federal requirement identified in §650.307(c) and §650.313(g) the BPO created a Quality Assurance Engineer (QAE) position. This position is responsible for administering the QA program. The QAE must meet the same qualifications and re certification requirements as a TL.

### E. **Quality Assurance**

The QA program treats the separate units within BPO as a whole to evaluate the following areas below for accuracy and consistency and produces an annual summary of findings. In addition to that, the QAE will participate in an annual office wide “Process Change” meeting, a meeting with management and staff prior to the beginning of the next inspection season. This will consist of a summary of the information that is contained in the annual report submitted to the SPM.

1. **Staff Qualifications and Re-Certification** – Document validity of qualifications and re-certification of SPM, TL, LRE and UBID based on roles and responsibilities defined in Chapter 1.
2. **Office Records and Procedures** – Review and document the accuracy and completeness of the following for those bridges selected using the selection criteria described in Appendix 7.12-H:
  - Contents of bridge letter and electronic files (see Appendix 7.12-A).
  - Load ratings.

Review of load rating information:

- Load posting at bridge matches that of load rating documentation.
- Operating level codes match legal load ratings and posting codes.
- Summary sheet in the letter file is signed and stamped by Engineer of Record (EOR).

Inspection reports:

- Appropriate report forms:
  - Fracture Critical report
  - Underwater report
  - Special Inspection report
  - Damage inspections
- Bridges on 48 month frequency.
- Scour Evaluation of bridges over water.

3. **Field Procedures** – Review and document the accuracy and completeness of the following for those bridges selected using the selection criteria described in Appendix 7.12-H:
  - Appropriate forms used.
  - NBI appraisal coding, NBI inventory data and Bridge Management System (BMS) condition state coding.
  - Inspection notes.
  - Photographs and sketches.
  - Maintenance recommendations.
  - Resources used to conduct bridge inspections.
  - Safety hazards addressed.
4. **Data Quality** – The Coding and Appraisal Unit completes QC/QA processes that include error checks, incorporated results from FHWA provided error checks, persistent error reports, and State developed consistency, compatibility and accuracy checks.
5. **De-certification/Reinstatement** – For process on de-certification and reinstatement see Chapter 1.
6. **Deliverables** – A written report will be provided to the SPM prior to the beginning of the next inspection season that will include:
  - Executive summary.
  - Selection breakout by category. See Appendix 7.12-H for details.
  - Individual QA field and office reports for each bridge selected.
  - Findings (from both office and field procedures).
  - Recommendations to management.





## 7.09 WSDOT LP Quality Control/Quality Assurance Program

### A. General

LP conducts quality control/quality assurance (QC/QA) reviews of local agency bridge programs statewide to:

- Verify that local agency bridge inspection programs maintain a high degree of accuracy and consistency.
- Identify future training needs.
- Ensure compliance with the NBIS.

QC reviews are conducted by both the local agency bridge owners and by LP. The LP Local Agency Bridge Inventory Engineer continually performs routine QC on the data contained in the Local Agency Bridge Inventory.

QA reviews are formal reviews of an agency that are conducted a minimum of once every five years. This formal agency review consists of both a bridge file review and the field review as detailed in Section 7.11.B. See *Local Agency Guidelines (LAG)* M 36-63 Appendix 34.57 for a copy of the checklist used by LP for this review.

## 7.10 WSDOT LP Quality Control Program

LP has established a set of QC procedures to be used with Local Agencies in order to maintain a high degree of accuracy and consistency within the bridge inspection program. The procedures focus on the following areas:

- Qualifications of designated bridge positions within the agency.
- Maintaining bridge information (electronic and physical information).
- Management/analysis of bridge load rating and bridge scour.
- Office review and Field verification of information and conditions detailed in bridge inspection reports.

The QC program's role and that of those involved in the process is to evaluate and communicate the assessments made directly with staff involved. Local Agency practices should be evaluated throughout this process and be addressed and adjusted accordingly in order to create a more consistent and accurate inspection program.

Quality control is defined per 23 CFR 650.305 as "procedures that are intended to maintain the quality of a bridge inspection and load rating at or above a specified level." QC is performed within a work group.

### A. Personnel – Roles, Responsibilities, and Qualifications

The roles and responsibilities for the following local agency bridge inspection personnel are described in detail in Chapter 1. The minimum qualifications for each of these positions are described in the NBIS.

List of typical local agency bridge inspection personnel:

- Program Manager
- Team Leader
- Load Rater
- Underwater Bridge Inspection Diver

## **B. Personnel – Continuing Education Requirements**

The Certified Bridge Inspector (CBI) list is managed through the Local Agency BridgeWorks bridge inspection software. Each CBI must fulfill the continuing education requirements as listed in Chapter 1 or as outlined in LAG Chapter 34 prior to the expiration date on their Local Agency BridgeWorks account and must submit their training records for review and request an extension of their Local Agency BridgeWorks account rights.

LP will also search the database for all inspectors that are due for the refresher course within the next year and notify each inspector of the need to attend the refresher course and availability of training. A CBI who does not fulfill the requirements of Chapter 1 will have their certification suspended until the inspector supplies LP with proof that they have successfully fulfilled the continuing education requirements (see Section 1.06).

## **C. Maintain Bridge Information (Electronic and Physical Information)**

Each agency is responsible for maintaining a bridge file for each bridge within its jurisdiction. A detailed list of information that should be in the bridge file is listed and described in Section 2.02. In addition, agencies are required to maintain a record of other general information. This information may be requested during the QA review of the bridge inspection program. The following general information should be on file:

- An experience and training record for each lead inspector.
- A master list of all bridges within the agency's jurisdiction. This list should identify bridges that have fracture critical members, require underwater inspection, and/or warrant special inspection because of their design features, location, or strategic importance.

**Physical Letter Files** – The LP Local Agency Bridge Engineer will perform an annual audit by comparing a current list of bridges from the Local Agency WSBIS database against the physical letter files. All conflicts between the electronic list and the physical letter files are addressed, validating both the physical and electronic portions of the bridge files. This annual audit has three QC functions:

- Identifies physical letter files that are missing so they can be recovered.
- Validates the accuracy of the electronic database with respect to the bridges listed in the inventory.
- Ensures that records for bridges that have been added, transferred, or removed from the inventory are complete and accurate.

All physical letter files should include an individual bridge record checklist as provided in LAG Appendix 34.56.

**Electronic Files** – Local Agencies have the option of keeping some or all of their bridge files electronically. If an agency chooses to maintain an electronic copy, it is the local agency program manager's responsibility for scanning the signed inspection reports. The agency should review the data scanned to ensure the files are accurate and complete.

Items to be reviewed include:

- Did the agency “release” the final inspection report form:
  - Were all pages included
  - Were all inspection types listed on the first page included
  - Did the Team Leader sign the report

See LAG Appendix 34.55, for additional information that should be reviewed and included as part of an individual electronic bridge record.

#### **D. Management/Analysis of Bridge Load Rating and Bridge Scour**

**Load Rating** – The QC tasks for load rating are the responsibility of the LP Local Agency Bridge Engineer or the Local Agency Program Manager. A PE license is required for the individual responsible for this review. The QC tasks apply to any new load rating work to be completed on a structure or for revisions to a load rating on a structure.

QC consists of procedures defined below that assess the load rating work completed by consultants as well as by local agencies. These rules currently apply to those load ratings completed by consultants and local agencies on locally owned bridges that meet the federal definition of a bridge (NBI bridges). However, agencies are also encouraged to follow these methods for their non-NBI bridges.

A selected number of locally owned bridges (Owner code of 2, 3,4,25, or 32) that qualify as NBI bridges will be reviewed annually. A sub-set of the selected bridges will consist of a combination of Fracture Critical bridges and bridges with a Superstructure or Substructure NBI Code of 4 or less.

The QC review on all selected structures will include the following:

- Verify the bridge has been rated.
- Verify a stamped summary sheet is included in the rating file.
- Verify the inventory and operating tons match the values reported in bridge inventory through the BridgeWorks software and the posting matches the rating where needed.
- Evaluate the rating factors, do they make sense? For example is the OL1 RF greater than OL2 or the RF for AASHTO 1 greater than HS20?

For structures that consist of a combination of Fracture Critical bridges and bridges with a superstructure or substructure NBI condition code of 4 or less, additional information will be reviewed for these structures as follows:

- Verify all elements/members that require ratings are rated.
- Verify the preliminary calculations are included in the submittal and are checked for accuracy. These files might include dead loads, factors, and any assumptions used in the calculations.
- Verify the ratings represent the condition of the structure based on the latest inspection report.
- Verify each bridge’s physical characteristics are modeled properly.
- Verify reinforcing/pre-stressing; typically check points at maximum stress.
- Verify dead and live loads are modeled properly.

**Bridge Scour** – The QC tasks for bridge scour are the responsibility of the LP Local Agency Bridge Engineer or the Local Agency Program Manager. The LP Local Agency Bridge Engineer will conduct an annual review on all local agency bridges in which the scour code has changed since the last inspection and on all bridges in which the scour Plan of Action (POA) has changed in regards to new directions for monitoring or implementing. These two items will be verified for validity.

The QC review on all selected structures will check the following:

- Verify each bridge over water has:
  - a scour summary sheet
  - scour calculations if appropriate
  - a bridge layout sheet
  - Initial ground line drawings
- Verify the bridge is properly coded based on scour calculations.
- Verify each scour critical bridge has a Plan of Action and that it has clear direction for the field staff to follow.

A field review is also conducted as part of the QC review on the bridges selected annually that includes the following:

- Verify the scour code in the bridge inspection report is correct and that it reflects the field conditions.
- Verify the scour code note added to all bridges over water has clear and direct information.
- Verify any scour related concerns, exposed footings, channel migration, presence or need for countermeasures.
- Verify the POAs reflects the conditions in the field.

### **E. Review and Validation of Inspection Reports and Data**

QC reviews are conducted by both the local agency bridge owners and by LP. The LP Local Agency Bridge Inventory Engineer continually performs routine QC on the data contained in the Local Agency Bridge Inventory.

An individual bridge record specific QC check by the LP Local Agency Bridge Inventory Engineer begins after agencies conduct bridge inspections and perform their internal QC procedure. After an Agency's QC is complete, notification is made to LP by email that their bridge inspection records are ready for release to the Local Agency Bridge Inventory. Any necessary information or instructions related to their updated inspection data are also provided in this email. The Local Agency Bridge Inventory Engineer then starts the QC process on the updated, as well as the existing bridge data associated with the bridge records. This includes the following:

- A query is run on all inventory data for verification of data consistency and correct data field correlation.
- An in-depth review is run on all inventory data for verification of data consistency and correct data field correlation on all new data prior to releasing into the bridge inventory.
- A review of the inspection coding for consistency, completeness and accuracy.

- A review of additional bridge file components as they become available electronically through the bridge inspection software.
- Note any discrepancies, errors or questions.

Along with the individual inventory review:

- An evaluation of all bridge inventory data integrity is made whenever bridge information requests are made.
- Individual questions are answered daily through one-on-one instruction by phone call or email.
- Review visits with an Agency are conducted periodically with formal review visits as noted above.
- Quarterly reports are prepared from the bridge inventory data and are forwarded to the Agencies for review and action. This report lists bridges with inspections that appear to be out of date, with inspection work that needs to be completed and released, and a projection of what inspections need to be scheduled in the next quarter.

If discrepancies or errors are found the following will occur:

- A documented phone call may be sufficient to clear up the issue.
- If the error has been previously noted or is severe enough to warrant immediate action, the structure update will be returned un-released with an explanation as to why the update was not released and instructions on how to resolve the issue.
- An Excel spreadsheet of the errors found is prepared from the review notations and is sent to the Agency with instructions on how to correct their record. The updated inspection information is released and the corrections are made through an informational update or during the next inspection.
- If the review does not result in questions or concerns, the update is released without comment.

#### **F. Reporting of Quality Control Reviews**

Reporting annual results and findings of QC reviews will be as follows:

- Provide results to the Statewide Program Manager for incorporation into overall Washington QC/QA annual report by the end of October.
- Copies of all reporting and documentation of the LP QC reviews will be available at the WSDOT LP Office.

## 7.11 WSDOT LP Quality Assurance Program

QA reviews are formal reviews that are conducted by LP annually for bridge inspector personnel qualifications and a minimum of once every five years to verify the adequacy of the QC procedures for a local agency. The QA review is performed by the LP Local Agency Bridge Engineer as an independent reviewer from the bridge inspection team on a sample of work completed within a three year timeframe prior and up to the time of the formal review.

Quality assurance is defined per 23 CFR 650.305 as “the use of sampling and other measures to assure the adequacy of QC procedures in order to verify or measure the quality level of the entire bridge inspection and load rating program”. QA is administered from outside a work group.

### A. Annual QA Review – Certified Bridge Inspector

At a minimum, the LP Local Agency Bridge Engineer will review qualifications and re-certification records for a sample of certified inspectors within the database on an annual basis. Continued certification will be in accordance with the inspector certification process established in Chapter 1. Any suspensions of certification will be in accordance with the process described in Section 1.06.

### B. QA Review – On Local Agency QC Procedures

The formal QA review that is conducted a minimum of once every five years consists of both a bridge file review and the field review as detailed below. This review will be performed by, or under the direction of the LP Local Agency Bridge Engineer. The agencies and structures that are selected for review are those responsible for NBIS inspections and reporting. The number of bridges to be reviewed will be determined based on agency inventory and types of structures. If an agency has a cross section of structure types and condition states a sample from all types will be included as part of the review.

Selection criteria for agencies to receive a QA review includes the following;

- Agencies responsible for NBIS inspections and reporting will have a higher priority.
- Elapsed time since last local agency QA review (maximum interval of five years).
- **Past Performance** – An agency that has had a review with minor deficiencies and/or corrections will receive higher priority; conversely agencies with a demonstrated record of high quality results will be a lower priority.
- **Condition of Bridges** – Agencies with inventories of higher risk bridges (such as bridges with low sufficiency ratings that are fracture critical or structurally deficient) will receive high priority.

Listed below are the procedures and sampling parameters that will be used in selecting bridges to review from each selected agency:

- Is the bridge load restricted?
- Bridge’s deficiency status.
- Is the bridge programmed for rehabilitation or replacement?

- Does the bridge have critical findings and what is the status of any follow-up action?
- Bridges with unusual changes in condition ratings.
- Bridges that require special inspection.
- Location of bridges.

A close-out meeting will be conducted at the conclusion of each local agency QA review. Any deficiencies, as well as commendable practices will be identified for the agency at the time of the review. See Appendix 7.12-J for procedure on documenting an agencies deficiencies and corrective action to be taken. If no deficiencies were found during the local agency's bridge program QA review, the local agency will be informed in writing.

**Office File Review** – The QA office file review assesses the following items documenting the results via the checklist in LAG Appendix 34.57:

- Inspection reports.
- Verify inspections were completed by qualified staff.
- Complete and organized bridge files.
- Accurate and current master lists.
- Accurate documentation of bridge load ratings.
- Accurate documentation of scour evaluations including scour codes and a plan of action for all scour critical bridges
- Thorough and accurate documentation of inspections performed
- Inspection frequency as outlined by the NBIS at a minimum or agency specific defined frequencies, see LAG Appendix 34.52.
- For agencies with a Program Manager delegated by WSDOT, an in-depth review to validate the agencies QC/QA procedures

**Field Review** – The field bridge inspection QA review is the second component of the overall QA review. The field review will be performed by, or under the direction of the Local Agency Bridge Engineer. Other members of the team will consist of representatives from the bridge owner agency and possibly Region Local Programs Personnel. The number of bridges the team selects will be based on a review of the agency's overall inventory and past performance. The Local Agency Bridge Engineer will consider the number of bridges in an agencies inventory when making the following decisions on the number of structures to be sampled:

- The various inspection types of structures in an agencies inventory. (i.e., fracture critical, special, underwater, routine).
- The sample reviewed should have a cross section of structures of all types of bridges within and agencies inventory. This should be at a minimum of three bridges per structure inspection type depending on the individual inventory.
- The number of bridges in poor condition. Generally 10 percent of bridges considered structurally deficient in the Local Agency BridgeWorks Inventory should be reviewed, but not more than three will be required.
- An agencies past performance that has had a review with major deficiencies and/or corrections will have a higher priority.

The field review process will compare the bridge site condition report with the routine inspection reports as well as Fracture Critical, Underwater, and/or Complex Bridge Inspection Reports if applicable:

- General site review checklist:
  - Review Bridge Inspection Report(s).
  - NBI Appraisal Rating Items and Condition Codes (WB76).
  - BMS Element correctness and condition states.
  - Accuracy of notes.
  - Repair Recommendations.
  - Special inspections and procedures (fracture critical, underwater, complex).
  - Correct correlation of report elements.
  - Field aspects of frequency, scour, and load rating.
- One or more condition ratings are out of tolerance more than +/- 1. This will be reported on the closeout meeting and the information will also be included in the letter to the agency.
- Review Bridge Inventory Report
  - Inspection date and frequency for all reportable inspection types (WB77).
  - Additional coding not noted on the Bridge Inspection Report.

### **C. Reporting of Quality Assurance Reviews**

Reporting results and findings of QA reviews will be as follows:

- Detailed in the Federal Aid Highway Program Stewardship and Oversight Agreement entered into by WSDOT and FHWA that is to be in place in early 2015 (pending signatures).
- Provided to the Statewide Program Manager for incorporation into overall Washington QC/QA annual report by the end of October.
- Copies of all reporting and documentation of the LP QA reviews will be available at the WSDOT LP office.



## 7.12 Appendices

|                 |                                                                           |
|-----------------|---------------------------------------------------------------------------|
| Appendix 7.12-A | Bridge Letter File Contents for State Bridges                             |
| Appendix 7.12-B | Flowchart for Tracking New Bridges                                        |
| Appendix 7.12-C | WSBIS Fields Maintained With Other<br>WSDOT Database Source Information   |
| Appendix 7.12-D | Bridge Preservation Office Lead Approval Criteria                         |
| Appendix 7.12-E | Bridge Preservation Office Quality Control Review<br>Tracking Form        |
| Appendix 7.12-F | Bridge Preservation Office Quality Control Report<br>Review Tracking Form |
| Appendix 7.12-G | Bridge Preservation Office Quality Control Field<br>Review Form           |
| Appendix 7.12-H | Bridge Preservation Office Quality Assurance Bridge<br>Selection Process  |
| Appendix 7.12-I | Bridge Preservation Office Field Review                                   |
| Appendix 7.12-J | LP Quality Assurance Deficiencies                                         |



**State Bridge Files with 1 Divider**  
**(w/o Underwater or Fracture Critical Inspections)**

|                                                                                                                                      |                                                                                                          |
|--------------------------------------------------------------------------------------------------------------------------------------|----------------------------------------------------------------------------------------------------------|
| <b><u>Inside Front Cover</u></b><br>Layout Sheet & Vicinity Map<br>Deck & Elevation Photos<br>Load Rating Summary<br>& Scour Summary | <b><u>1st Divider Back</u></b><br>Regional Maintenance/<br>Repair Documentation                          |
| <b><u>1st Divider Front</u></b><br>Routine Insp.<br>UBIT Insp.<br>Detail Photos                                                      | <b><u>Inside Back Cover</u></b><br>Correspondence<br>EQ Restrainer Plans<br>Repair/Modification<br>Plans |

(page 1 of 2)

State Bridge Files with 2 Dividers  
(including Underwater and Fracture Critical Inspections)

|                                                                                                                                                     |                                                                                           |                                                                                                                              |
|-----------------------------------------------------------------------------------------------------------------------------------------------------|-------------------------------------------------------------------------------------------|------------------------------------------------------------------------------------------------------------------------------|
| <p><b><u>Inside Front Cover</u></b><br/>Layout Sheet<br/>Vicinity Map<br/>Deck &amp; Elevation Photos<br/>Load Rating Summary<br/>Scour Summary</p> | <p><b><u>1st Divider Back</u></b><br/>Underwater Insp.<br/>Scour Reports</p>              | <p><b><u>2nd Divider Back</u></b><br/>Correspondence</p>                                                                     |
| <p><b><u>1st Divider Front</u></b><br/>Routine Insp.<br/>UBIT Insp.<br/>Emergency Response Insp<br/>Detail Photos</p>                               | <p><b><u>2nd Divider Front</u></b><br/>Regional Maintenance/<br/>Repair Documentation</p> | <p><b><u>Inside Back Cover</u></b><br/>Fracture Critical Insp.<br/>EQ Restrainer Plans<br/>Repair/Modification<br/>Plans</p> |

(page 2 of 2)





## **WSBIS Fields Maintained With Other WSDOT Database Source Information**

---

1. Fields that BPO would like to get from TDO to check for NBI submittal:

**hwy\_class (char(1), null)** – This code identifies what type of highway the inventoried route is one using the following:

- 1 Interstate highway
- 2 U.S. numbered highway
- 3 State Highway
- 4 County road
- 5 City street
- 6 Federal lands road
- 7 State lands road
- 8 Other (included toll roads not otherwise identified.)

**serv\_level\_code(char(1), null)** – This code describes the designated level of service provided by the inventoried route:

- 1 Mainline (most local agency bridges)
- 2 Alternate
- 3 Bypass
- 4 Spur
- 6 Business
- 7 Ramp or “Y”
- 8 Service and/or unclassified Frontage Road
- 0 None of the above

When two or more routes are concurrent, the highest class of route will be used. The hierarchy is as listed above

**adt(numeric(6,0), null)** – This is the Average Daily Traffic (ADT) volume carried on the route being inventoried. If bridges on a divided highway are coded as parallel, then the ADT is the volume carried on the individual bridge, not the cumulative volume carried on the route. The determined ADT volume must be no more than four (4) years old. Add leading zeros to fill all spaces in the field.

**adt\_truck\_pct (numeric(2,0),null)** – This is the percentage of the ADT volume that is truck traffic. It does not include vans, pickups, or other light delivery trucks. Code to the nearest whole percent.

**adt\_year(numeric(4,0), null)** – This is the year in which the estimate of the ADT volume was determined. If the year entered in this field is more than four years in the past, a new ADT volume must be determined and entered in the ADT and the year the ADT was determined in this field.

**Future\_adt(numeric(6,0), null)** – This is the ADT volume that the inventory route is expected to carry 20 years in the future. This field may be updated whenever a new projection is made. The field must be updated any time the projected date of this forecast is less than 17 years, but not more than 22 years from the current year.

**Future\_adt\_year(numeric(4,0), null)** – This is the year for which future\_adt has been projected. This date must be at least 17, but no more than 22 years from the current year. If the date in this field is outside these limits, then a new value will be required for and a new year will need to be entered in this field.

**strahnet\_hwy(char(1),null)** – For the inventory route identified indicate STRAHNET highway status using one of the following codes:

- 0 The inventory route is not a STRAHNET highway.
- 1 The inventory route is an Interstate STRAHNET highway.
- 2 The inventory route is a non-Interstate STRAHNET highway.
- 3 The inventory route connects with a Department of Defense facility.

**nat\_truck\_ntwrk\_flag(char(1),null)**

**fed\_hwy\_system\_code(char(1),null)** – This item shall be coded for all records in the inventory. For the inventory route identified indicate whether the inventory route is on the NHS or not on that system. This code shall reflect an inventory route on the NHS as described in the TRANSPORTATION EQUITY ACT FOR THE 21ST CENTURY (TEA21).

If more than one federal aid highway is carried on or under the bridge, indicate only the classification of the more primary route.

- 0 Inventory Route is not on the NHS.
- 1 Inventory Route is on the NHS.

**fed\_functional\_class(class(2),null)** – This code describes the Federal Functional classification of the inventory route as classified according to Statewide National Functional Classification System maps. Statewide National Functional Classification System maps are located at local agency planning departments or WSDOT Service Center Planning.

Separate codes are used to distinguish roadways located in rural or in urban areas. Routes shall be coded rural if they are not inside a designated urban area, Codes 08, 09, and 19 are for off-system roads.

#### **Rural Codes**

- 01 Principal Arterial – Interstate
- 02 Principal Arterial – Other
- 06 Minor Arterial
- 07 Major Collector (Federal Aid Secondary)
- 08 Minor Collector
- 09 Local



### Urban Codes

- 11 Principal Arterial – Interstate
- 12 Principal Arterial – Other Freeway or Expressway
- 14 Other Principal Arterial
- 16 Minor Arterial
- 17 Collector
- 19 Local

**fed\_lands\_hwy\_code(char(1),null)** – This code identifies bridges on roads which lead to and traverse through federal lands. These bridges may be eligible to receive funding from the Federal Lands Highway Program. Use one of the following codes:

- 0 Not Applicable
- 1 Indian Reservation Road (IRR)
- 2 Forest Highway (FH)
- 3 Land Management Highway System (LMHS)
- 4 Both IRR and FH
- 5 Both IRR and LMHS
- 6 Both FH and LMHS
- 9 Combined IRR, FH, and LMHS

For definition of IRR (Indian Reservation Roads), see Title 23 USC Section 101.

2. Fields BPO would like to get from TDO if available:

**Region\_code(char(2),null)** – This is a two-digit code, which identifies the WSDOT region in which the bridge is located.

**County\_id(int,null)** – This is a two-digit code, which identifies the county in which the bridge is located. If this is a jointly owned bridge, the county that is responsible for reporting the data to the inventory should be entered here. Use one of the following codes.

**City\_id(int,null)** – This is the city in which the bridge is located. (Codes for cities and towns are identified according to the most recent U.S. Bureau of the Census Identification Schedule.) Contact the Bridge Engineer for Local Agencies for newly incorporated municipalities. If the bridge is outside of corporate limits or in an unincorporated city, code all zeros.

**Leg\_dist\_code\_1(int, null)** – This field identifies the first or only State Legislative District in which the bridge is located. If the legislative district number is followed by a letter (District 19A, for example), disregard the letter and enter the two-digit number only

**Leg\_dist\_code\_2(int, null)** – For bridges which span a State Legislative District dividing line, use this field to identify the second State Legislative District number. Use both this and the Legislative District Number (1) field to enter the two separate State Legislative District numbers. If no code is applicable, enter all zeroes.

**speed\_limit(tinyint, null)** – Speed limit on the bridge.

- These are coming from the Data Mart process...an ARM value is returned as well.
- These are going to be populated by HPMS.



Please use the following criteria to help you determine which reports can be sent directly to the Bridge Information Group without further review by a supervisor or a second Lead.

A “Bridge Inspection Report” that fits any one of the following nine criteria must be reviewed by a Regional Bridge Inspection Engineer or a second Lead Inspector.

1. If NBI codes for Deck Overall, Superstructure or Substructure are less than “6”.
2. Structures with repairs or conditions to be monitored.
3. New bridge structures (Inventory Inspections).
4. Fracture Critical bridges.
5. Local Agency bridges.
6. UBIT Bridge Inspections.
7. Any inspection with a frequency >24 months.
8. Any bridge that is currently having issues with scour.
9. Any time an inspection/report type and/or frequency is either changed, added, or deleted.

Additionally, the Lead may submit for review any report that the Lead feels needs further input from the Regional Bridge Inspection Engineer.

If the “Bridge Inspection Report” does not meet any of these criteria, then the “Bridge Inspection Report” can be routed by the experienced Lead Inspector to the Info Group for processing.

For quality assurance reasons, the “Bridge Inspection Report” can be randomly reviewed at the Regional Bridge Inspection Engineer’s option.



# Appendix 7.12-E

# Bridge Preservation Office Quality Control Review Tracking Form

| 2011 Inspection Report Status |              |               |                           |                |              |                 |               |                      |       |        |         |        |                  |         |         |      |         |            |                  |         |
|-------------------------------|--------------|---------------|---------------------------|----------------|--------------|-----------------|---------------|----------------------|-------|--------|---------|--------|------------------|---------|---------|------|---------|------------|------------------|---------|
| Total                         | Structure ID | Bridge Number | Bridge Name               | Lead Inspector | CO-Inspector | Inspection Date | Date Received | Non UBIT Totals = 10 |       |        |         |        | UBIT Totals = 10 |         |         |      |         |            |                  |         |
|                               |              |               |                           |                |              |                 |               | Routine              | Short | Damage | Interim | Safety | Hours            | Routine | Interim | F.C. | Special | UBIT Hours | Returned to Lead |         |
| 1                             | 0009245A     | 16120         | OLYMPIC DR. NW OVER SR 16 | WDS            | HDR          | 1/8/11          | 1/8/11        | 8                    | 0     | 1      | 0       | 1      | 10.5             | 3       | 1       | 6    | 0       | 0          | 107.5            | 1/8/11  |
| 2                             | 0017677A     | 28510P        | GEORGE SELLAR PED TUNNEL  | GAS            | GAS          | 1/8/11          | 3/21/11       |                      |       |        |         |        | 1.5              |         |         |      |         |            |                  | 3/22/11 |
| 3                             | 0013077C     | 2101          | SLOUGH                    | DCC            | TKK          | 4/7/11          | 5/4/11        | 1                    |       |        |         |        | 1.0              |         |         |      |         |            |                  | 5/6/11  |
| 4                             | 0013077D     | 2102          | STREAM                    | DCC            | TKK          | 4/7/11          | 5/4/11        | 1                    |       |        |         |        | 1.0              |         |         |      |         |            |                  | 5/6/11  |
| 5                             | 0006347A     | 91117         | SNOHOMISH R OVERFLOW      | DCC            | TKK          | 4/7/11          | 5/4/11        | 1                    |       |        |         |        | 1.0              |         |         |      |         |            |                  | 5/6/11  |
| 6                             | 0008375C     | 405103E       | 228TH ST OC               | DCC            | TKK          | 4/4/11          | 5/4/11        | 1                    |       |        |         |        | 1.0              |         |         |      |         |            |                  | 5/6/11  |
| 7                             | 0008375D     | 405103W       | FRUITLAND AVE OC          | DCC            | TKK          | 4/4/11          | 5/4/11        | 1                    |       |        |         |        | 1.0              |         |         |      |         |            |                  | 5/6/11  |
| 8                             | 0008673D     | 51223N        | FRUITLAND AVE OC          | DCC            | TKK          | 4/4/11          | 5/4/11        | 1                    |       |        |         |        | 1.0              |         |         |      |         |            |                  | 5/6/11  |
| 9                             | 0008673C     | 51223S        | FRUITLAND AVE OC          | DCC            | TKK          | 4/4/11          | 5/4/11        | 1                    |       |        |         |        | 1.0              |         |         |      |         |            |                  | 5/6/11  |
| 10                            | 0008761A     | 522142        | SR 522 OVER W MAIN ST     | DCC            | TKK          | 4/7/11          | 5/4/11        | 1                    |       |        |         |        | 1.0              |         |         |      |         |            |                  | 5/6/11  |
| 1                             | 0003477A     | 285170        | SEN. GEORGE SELLAR BR.    | GFC            | ABK          | 1/8/11          | 1/27/11       |                      |       |        |         |        |                  |         |         | 1    |         |            | 28.0             | 1/27/11 |
| 2                             | 0002001B     | 21215         | WENATCHEE R               | DCC            | TKK          | 4/5/11          | 5/4/11        |                      |       |        |         |        |                  |         |         | 1    |         |            | 7.0              | 5/10/11 |
| 3                             | 0002657A     | 20714         | WENATCHEE RIVER           | DCC            | TKK          | 4/6/11          | 5/4/11        |                      |       |        |         |        |                  |         |         | 1    |         |            | 8.0              | 5/10/11 |
| 4                             | 0008116A     | 51445W        | NISQUALLY R               | DAG            | AES          | 4/17/11         | 5/4/11        |                      |       |        |         |        |                  |         |         | 1    |         |            | 14.0             | 5/10/11 |
| 5                             | 0013731C     | 50436         | MARATTA CREEK             | RAA            | RCD          | 5/5/11          | 5/12/11       |                      |       |        |         |        |                  | 1       |         |      |         |            | 2.5              | 5/12/11 |
| 6                             | 0005358A     | 50930         | DRY GULCH                 | RAA            | RCD          | 4/30/11         | 5/12/11       |                      |       |        |         |        |                  |         | 1       |      |         |            | 1.0              | 5/12/11 |
| 7                             | 0013620A     | 50427         | HOFFSTADT CREEK           | RAA            | RCD          | 5/5/11          | 5/8/11        |                      |       |        |         |        |                  |         |         | 1    |         |            | 23.0             | 6/6/11  |
| 8                             | 0002069A     | 5345E         | NISQUALLY RIVER           | RAA            | RCD          | 5/1/11          | 6/8/11        |                      |       |        |         |        |                  |         |         | 1    |         |            | 18.0             | 6/7/11  |
| 9                             | 0008175E     | 167127E       | BNRR OC (NP)              | RAA            | RCD          | 5/1/11          | 6/8/11        |                      |       |        |         |        |                  |         |         | 1    |         |            | 3.0              | 6/8/11  |
| 10                            | 0008175F     | 167127W       | BNRR OC (NP)              | RAA            | RCD          | 5/1/11          | 6/8/11        |                      |       |        |         |        |                  |         |         | 1    |         |            | 3.0              | 6/8/11  |

EXAMPLE



# Bridge Preservation Office Quality Appendix 7.12-F Control Report Review Tracking Form

## 2011 REPORT REVIEW STATUS

| REVIEW DATE | REPORT DATE | 006/115    | INSPECTOR | APPROVAL STATUS | COMMENTS |
|-------------|-------------|------------|-----------|-----------------|----------|
| 03/26       | 02/28       | 006/101    | FPW/WAW   | AAN             |          |
| 03/29       | 03/19       | 099/540NB  | DCC/GAS   | AAN             |          |
| 03/29       | 03/19       | 099/540SB  | DCC/GAS   | AAN             |          |
| 03/30       | 03/20       | 099/540W-S | DCC/GAS   | APPROVED        |          |
| 03/30       | 03/07       | 08507600   | WDS/AES   | AAN             |          |
| 03/30       | 03/21       | 08039100   | WDS/TJN   | APPROVED        |          |
| 03/30       | 03/21       | 08118500   | WDS/TJN   | AAN             |          |
| 03/30       | 03/08       | 08201200   | WDS/AES   | AAN             |          |
| 03/31       | 03/24       | 08647200   | WDS/SMP   | AAN             |          |
| 03/31       | 03/23       | 08276000   | WDS/TJN   | AAN             |          |
| 03/31       | 03/22       | 0012160A   | WDS/TJN   | AAN             |          |
| 03/31       | 03/22       | 08218700   | WDS/TJN   | AAN             |          |
| 03/31       | 03/07       | 08288400   | JED/TJN   | AAN             |          |
| 04/01       | 03/08       | 08396900   | JED/TJN   | AAN             |          |
| 04/01       | 03/07       | 08651000   | JED/TJN   | AAN             |          |
| 04/04       | 03/17       | 08271700   | DAG/TJN   | AAN             |          |
| 04/04       | 03/15       | 08557500   | DAG/TJN   | AAN             |          |
| 04/04       | 03/15       | 08558400   | DAG/TJN   | AAN             |          |
| 04/04       | 03/03       | 0009236C   | DAG/TKK   | APPROVED        |          |
| 04/05       | 03/03       | 167/112W   | DAG/TKK   | AAN             |          |
| 04/05       | 02/28       | 167/110    | DAG/TKK   | AAN             |          |
| 04/05       | 03/03       | 167/116    | DAG/TKK   | APPROVED        |          |
| 04/05       | 03/03       | 167/112W-N | DAG/TKK   | AAN             |          |
| 04/05       | 03/03       | 167/111W-N | DAG/TKK   | AAN             |          |
| 04/05       | 03/02       | 167/123W   | DAG/TKK   | AAN             |          |
| 04/05       | 03/02       | 167/129    | DAG/TKK   | AAN             |          |
| 04/05       | 03/02       | 167/131.25 | DAG/TKK   | AAN             |          |
| 04/05       | 03/28       | 0010756A   | DAG/HDR   | AAN             |          |
| 04/05       | 03/29       | 08492300   | DAG/HDR   | AAN             |          |
| 04/05       | 03/14       | 0003093A   | WDS/TJN   | AAN             |          |
| 04/06       | 03/09       | 08230200   | WDS/AES   | AAN             |          |
| 04/06       | 03/31       | 08164100   | DAG/TKK   | AAN             |          |
| 04/06       | 03/03       | 005/626.5A | JHL/RCD   | APPROVED        |          |
| 04/06       | 03/01       | 020/223N   | JHL/RCD   | APPROVED        |          |
| 04/06       | 03/02       | 005/706    | JHL/RCD   | AAN             |          |
| 04/06       | 03/03       | 005/651W   | JHL/RCD   | AAN             |          |
| 04/06       | 03/02       | 005/708    | JHL/RCD   | AAN             |          |
| 04/06       | 03/03       | 005/726E   | JHL/RCD   | APPROVED        |          |

void under south approach





**Field Review**

**2012 WASHINGTON STATE  
QUALITY CONTROL REVIEW**

|                             |       |                     |       |
|-----------------------------|-------|---------------------|-------|
| <b>Bridge Number:</b>       | _____ | <b>Bridge Name:</b> | _____ |
| <b>Inspectors:</b>          | _____ | <b>QC Reviewer:</b> | _____ |
| <b>Inspection Date:</b>     | _____ |                     |       |
| <b>Frequency:</b>           | _____ |                     |       |
| <b>Previous Report Date</b> | _____ |                     |       |

|                                                                            |                  |
|----------------------------------------------------------------------------|------------------|
| <b>Description of Quality Control Method</b>                               |                  |
|                                                                            |                  |
| Are all the applicable FHWA items for the structure properly coded?        | Yes ____ No ____ |
|                                                                            |                  |
| Are all the BMS elements for the structure correctly identified?           | Yes ____ No ____ |
|                                                                            |                  |
| Are all the BMS element condition states for the structure properly coded? | Yes ____ No ____ |
|                                                                            |                  |
| Do the BMS codes support the NBI Codes?                                    | Yes ____ No ____ |
|                                                                            |                  |

Field Review

**2012 WASHINGTON STATE  
QUALITY CONTROL REVIEW**

Bridge Number: \_\_\_\_\_

Bridge Name: \_\_\_\_\_

Inspectors: \_\_\_\_\_

QC Reviewer: \_\_\_\_\_

Inspection Date: \_\_\_\_\_

Does the verbiage within the report support the condition states? Yes \_\_\_\_\_ No \_\_\_\_\_

|  |
|--|
|  |
|--|

Were proper safety procedures practiced? Yes \_\_\_\_\_ No \_\_\_\_\_

|  |
|--|
|  |
|--|

Are the existing repairs supported by the inspection findings? Yes \_\_\_\_\_ No \_\_\_\_\_

|  |
|--|
|  |
|--|

Are improvement processes necessary? Yes \_\_\_\_\_ No \_\_\_\_\_

|  |
|--|
|  |
|--|

# **Bridge Preservation Office Quality Assurance Bridge Selection Process**

## **Appendix 7.12-H**

---

The following table identifies categories used to help evaluate whether or not the random selection is representative sample of the previous seasons inspections. If a particular category is not considered to be covered sufficiently, additional bridges can be traded out in order to establish more representative coverage. The selection set for the office and field review will include a minimum of 100 bridges of the previous year’s inspections. Like the NBIP compliance review trips performed in Washington state, the QA selection process as of 2014 uses a 3 year cycle in which bridges are selected from two different regions each year. In this three year cycle, a random set of bridges are selected and receive a QA inspection from each of the six regions. In addition to this cycle and due to the number of bridges in the Northwest Region, a smaller sampling of bridges (one or at most two inspection trips depending on complexity of bridges) will be selected from this region. This will be done in the off cycle years in order to maintain a representative sample of bridges within that region in the overall three year cycle.

The three year cycle will pair up the following regions:

- SCR and SWR (includes a small set in NWR)
- OLR and EAR (includes a small set in NWR)
- NWR and NCR

The final list developed prior to generating a random sample is screened for inspection types that consist of Routine, Safety or Short Span type inspections. The list is also screened for bridges that have been previously QA’d. Once a final list of bridges is developed, a random list is generated. The first 100 bridges are selected and represent the final short list for QA office and field review for that year. This final short list is then validated for reasonable representation of the categories listed below.

As an option, a minimum of five bridges previously receiving a quality assurance review, excluding work from the previous QA inspection season, can be added to the final short list for the season. The goal of doing this is to validate whether or not suggested changes in the report that reflect correct office procedures and federal requirements have been implemented or not. These bridges may be chosen by the QA Engineer to best fit within proximities of the randomly selected bridges.

|                                                      |                      |
|------------------------------------------------------|----------------------|
| Region                                               | Scour Code           |
| Primary Material Type                                | Open/Closed/Posted   |
| Primary Design Type                                  | Year Built           |
| Inspection Type                                      | Inspection Frequency |
| By Team Leader                                       | NBI Reportable       |
| Sufficiency Rating                                   | Bridge Length        |
| Structurally Deficient/Functionally Obsolete (SD/FO) | High Risk            |

## **BPO Scope of Field Review**

The selection process above does not eliminate any bridges because of size or complexity. The typical bridge will be inspected in its entirety. However, the scope of field review for larger and more complex bridges is entirely a different matter. The process for QA inspection for these types of structures will be more case by case. The idea will be that some of all of the components for these particular bridges will be inspected. The QA process should consider both time and size in determining how to reach this goal for these types of bridges. Traffic windows, lane closure manpower, species windows, and equipment availability are other factors that will influence the ability for one QA team to accomplish a smaller scale inspection of a larger more complex structure.

**Appendix 7.12-I**

---

The following is a list of contents in a typical bridge file for structures owned by the State of Washington which also includes Washington State Ferries (WSF) structures.

- Letter file contents include:
- Deck and Elevation Photos (More recent photos are stored on BEISt)
- Vicinity map
- Load Rating summary sheet
- Scour Summary sheet\*\*
- Signed Inspection reports
- Fracture Critical report\*
- Underwater (U/W) report\*
- WSBIS forms (in file drawer)
- Correspondence
- Maintenance records
- Plan sheets (Most plans are stored on BEISt)

\*For bridges with underwater and/or fracture critical inspections.

\*\*For bridges over water.



LP has established a procedure for documenting and reporting deficiencies found during Quality Assurance reviews of a local agency.

If deficiencies exist, the local agency will be sent a letter or email requesting that any missing documentation be submitted or provide a plan of corrective action, for LP's approval, to correct the deficiency within 60 days. This notification will be first in the form of email or other correspondence with the LP Bridge Office. If corrections are not made within 60 days of notification, the second notification will be a formal letter of non-compliance from the LP Engineering Services Manager.

Finally, failure to carry out the plan of corrective action will result in formal notification from the Director of LP that federal funds may be restricted until compliance is met. If continued deficiencies are found in subsequent reviews of the agency's procedures, management practices, or systems, or if specific inspection errors continue, LP will work with the agency to further determine the cause of the problems and will recommend additional training for the both the Bridge Program Manager and the Bridge Inspection Team Leader.

When a local agency is notified of deficiencies to correct, the LP Local Agency Bridge Engineer will notify and include the Statewide Program Manager (SPM) on all plans of corrective action and status updates to the plans of corrective action.





## 8.01 General

The National Bridge Inspection Standards (NBIS), 23 CFR 650, requires that complex bridges have specialized inspection procedures, and additional inspector training. These structures have numerous mechanical and electrical systems requiring inspection, troubleshooting, repair, and rehabilitation. This chapter serves as a guideline to illustrate inspection and reporting procedure as followed by the Complex Bridge and Tunnel section of the Bridge Preservation Office.

### A. References

Inspection staff may refer to the most current editions of the following:

- AASHTO *LRFD Movable Highway Bridge Design Specifications*
- AASHTO *Movable Bridge Inspection, Evaluation, and Maintenance Manual*
- AASHTO *Standard Specifications for Movable Highway Bridges, 1988*
- FHWA *Bridge Inspector's Manual for Movable Bridges IP 77-10*
- *Emergency Operations Manual M 54-11*
- Blue Ribbon Commission, Resolution No. 398

### B. Definitions

Some definitions for use with this chapter are as follows:

**Complex Bridge** – Complex bridges are defined in the NBIS as movable, suspension, cable stayed, and other bridges with unusual characteristics.

*Complex bridges in Washington are referred to as “Special Feature” bridges where discussed in other chapters of this manual.*

**Complex Tunnel** – Complex tunnels are defined in this manual as tunnels characterized by advanced or unique structural elements or functional systems.

**National Bridge Inspection Standards (NBIS)** – Title 23 Code of Federal Regulations 650 Part C defines the NBIS regulations, and establishes requirements for inspection procedures, frequency of inspections, qualifications of personnel, inspection reports, and preparation and maintenance of a state bridge inventory. The NBIS apply to all structures defined as bridges located on all public roads.

**National Tunnel Inspection Standards (NTIS)** – Title 23 Code of Federal Regulations 650 Subpart E defines the NTIS regulations, and establishes requirements for inspection procedures, frequency of inspections, qualifications of personnel, inspection reports, and preparation and maintenance of a state tunnel inventory. The NTIS apply to all structures defined as highway tunnels located on all public roads.

See Section 1.01.A for additional definitions used in this manual.

## 8.02 Description of Complex Bridges and Tunnels

In accordance with the description of the Bridge Inspection Organization offered in Section 1.02, a bridge inspection program/tunnel inspection program as required by the NBIS and NTIS has been constructed to ensure safe and reliable operation of electrical/mechanical systems present on the complex bridges and tunnels listed in Appendix 8.09-E.

The Complex Bridge and Tunnel section is staffed by individuals, specialized in electrical or mechanical engineering, who have defined roles and responsibilities. Their roles and qualifications are as follows:

### A. *Delegated Program Manager (DPM)*

A delegated program manager assumes some functions for the statewide program manager for the selected subset of structures under their direct control. To qualify as a delegated program manager, the individual must meet, at a minimum, the requirements as follows:

- (a) The individual in charge of the organizational unit that has been delegated the responsibilities for bridge inspection, reporting, and inventory shall possess the following minimum qualifications:
  - (1) Be a registered professional engineer in the State of Washington; or
  - (2) Have a minimum of 10 years' experience in complex bridge or tunnel inspection assignments in a responsible capacity.

**Note:** Although DPMs perform functions for the bridge inspection organization, overall responsibility for NBIS compliance still resides with the Statewide Program Manager.

### B. *Electrical/Mechanical Complex Bridge Lead Inspector (CBLI)*

A CBLI is in charge of inspections and is responsible for planning, preparing, performing the field inspection of bridges, and reporting observations/findings. The CBLI also makes repair recommendations and is responsible for initiating the critical damage procedures including full bridge or tunnel closure if deemed necessary. To qualify as a CBLI, the individual must meet, at a minimum, the requirements as follows:

- (a) An individual in charge of an inspection team shall possess the following minimum qualifications:
  - (1) Be a registered professional engineer in the State of Washington.
  - (2) Have a minimum of 4 years' experience in complex bridge or tunnel inspection.

A continued certification of complex bridge inspection personnel has been developed in order to ensure that all program managers and CBLIs are kept up to date with the latest practices and technology in the areas of complex bridge and tunnel inspections. The continued certification of complex bridge inspection personnel is detailed in Appendix 8.09-D.

## 8.03 Inspections

Several different types of inspections are in place to adhere to the requirements of the NBIS and NTIS. This section identifies and describes the inspection types and reporting procedures used for mechanical and electrical inspections by the Bridge Preservation Office (BPO).

### A. Routine Inspections

Regularly scheduled comprehensive safety and operational reliability inspections encompassing all mechanical/electrical elements of the structures listed in Appendix 8.09-E. Routine inspections are performed by a licensed professional engineer to evaluate safety as well as whether the electrical and mechanical systems are performing as designed, identify any changes from initial or previously recorded conditions, and ensure that electrical and mechanical components of structures pertaining to the Complex Bridge and Tunnels section continue to satisfy present service requirements.

1. **Frequency** – Routine electrical and mechanical inspections are conducted at least once every 24 months as required by NBIS, Section §650.311. Every complex bridge is inspected annually as required by the *Transportation Structures Preservation Manual*, Bridge Inventory and Inspection Rules.
2. **Inspecting Methodology** – Critical electrical and mechanical components are visually and operationally inspected. Non-destructive testing methods adhering to guidelines established by the AASHTO Movable Bridge Inspection, Evaluation, and *Maintenance Manual* Chapter 2, are used in evaluation of bridge components as well. Following these procedures throughout routine inspections helps ensure the safety and operational reliability of the mechanical and electrical systems by providing a thorough and comprehensive inspection.
3. **Inspection Report** – A routine inspection report (RIR) shall be prepared at the completion of each routine inspection to record the inspection findings, provide a narrative description of conditions at the site, and note any changes in the WSBS coding information. The CBLI shall record and submit the findings of the routine inspection into BridgeWorks as follows:
  - a. At the conclusion of the routine inspection, confirm the Numerical Rating Condition (NRC), Appendix 8.09.C, coding for the various elements and make any changes necessary. Complete the narrative portion corresponding to any condition rating change describing the existing condition of its respective element.
  - b. Enter onto the inspection report: CBLI initials, CBLI identification number, date of inspection, total number of crew hours at the site, average bridge openings per month since last inspection, average marine traffic bridge openings per month since last inspection, average maintenance bridge openings per month since last inspection, and the number of inspection bridge openings.

- c. Prepare a list of elements in need of repair and recommend the type of repair that should be done. A photo of repair areas should be taken with each type of recommended repair. Assign each repair a priority level. Text describing each repair should appear in the relevant element description. Deficiency photos are to be referenced in the column alongside the element description as well as the repair.

## **B. Blue Ribbon Inspections**

Shall be unannounced random inspections intended to assess the reliability of the mechanical and electrical systems, identify needed preventative maintenance activities and develop the scope of required rehabilitation projects on the floating bridges. Blue ribbon inspections and the corresponding reports are completed by consultants considered to be experts in their field, managed by CBLIs, in accordance with Resolution No. 398. When blue ribbon electrical and mechanical inspections are performed, they are used in conjunction with the routine inspection for that structure.

1. **Frequency** – Due to permissions granted by the Bridge and Structures Engineer in 1994, blue ribbon inspections shall be conducted unannounced at least once every two years. This augmentation to the original annual inspection schedule recommended by Resolution No. 398 is provided in the memo in Appendix 8.09-A.
2. **Inspection Methodology** –Blue ribbon inspections consist of visual and operational inspection of the electrical and mechanical systems. Disassembly of electrical and mechanical components for closer inspection is also conducted throughout these inspections to gather a higher level of detail than is typical in the routine inspections. Non-destructive testing methods adhering to guidelines established by the AASHTO *Movable Bridge Inspection, Evaluation, and Maintenance Manual* Chapter 2, are used in evaluation of bridge components as well. Following these procedures throughout blue ribbon inspections helps ensure the safety and operational reliability of the mechanical and electrical systems by providing a thorough and comprehensive inspection.
3. **Reporting** – After completion of a blue ribbon inspection a RIR is to be entered into BridgeWorks in the same fashion as outlined in Section 8.03.A.3. In addition to this RIR another inspection report is to be generated by a consulting engineer. Consultant reports are detailed reports to be formatted as dictated by the document provided in Appendix 8.09-B. These reports include identified deficiencies, recommended actions to correct deficiencies, and cost estimates to complete recommended rehabilitation items. The DPM will coordinate the implementation of the recommended repairs and rehabilitation items with the Region maintenance staff.

### C. In-Depth Inspection

Shall be a close-up inspection of one, several, or all electrical and mechanical elements to identify any deficiencies not readily detectable using routine inspection procedures. The results of these inspections are used to assess the reliability of mechanical and electrical systems, identify needed preventative maintenance activities, review and correct as-built schematics, review and correct OIM manuals, and develop the scope of required rehabilitation projects. In-depth electrical and mechanical inspections are used in conjunction with the routine inspection. Consultants, specialized in the specific field of interest, are used in conducting these inspections due to constant change in demand of disciplines, equipment, and vendors needed to accomplish the various in-depth inspections. Consulting engineers are managed by CBLIs in the same manner as those used in blue ribbon inspections.

1. **Frequency** – An in-depth inspection shall be performed in conjunction with a routine inspection every six years in accordance with the AASHTO *Movable Bridge Inspection, Evaluation, and Maintenance Manual* Section 2.1. An in-depth inspection may also be performed as a follow-up inspection to a routine or blue ribbon inspection to better identify any deficiencies found. The first inspection on a new or rehabilitated structure shall be an in-depth inspection in order to establish a detailed baseline for the structure file.
2. **Inspection Methodology** – In-depth inspections consist of visual and operational inspections of the electrical and mechanical systems. Extensive disassembly of electrical and mechanical components for closer inspection is conducted throughout these inspections to gather a higher level of detail than is typical in blue ribbon and routine inspections. Non-destructive testing methods adhering to guidelines established by the AASHTO *Movable Bridge Inspection, Evaluation, and Maintenance Manual* Chapter 2, are used in evaluation of bridge components as well. Following these procedures throughout in-depth inspections helps ensure the safety and operational reliability of the mechanical and electrical systems by providing a thorough and comprehensive inspection.
3. **Reporting** – After completion of an in-depth inspection an RIR is to be entered into BridgeWorks in the same fashion as outlined in Section 8.03.A.3. In addition to this RIR another inspection report is to be generated by a consulting engineer. Consultant reports are detailed reports to be formatted as dictated by the document provided in Appendix 8.09-B. These reports include identified deficiencies, recommended actions to correct deficiencies, and cost estimates to complete recommended rehabilitation items. The DPM will coordinate the implementation of the recommended repairs and rehabilitation items with the Region maintenance staff.
4. **Specialized Inspections** – Occasionally certain components/systems have their own specialized inspections carried out separately. Examples of components/systems that may require special inspections are trunnion bearings, counterweight ropes, and cathodic protection. Each of these inspections is functionally an in-depth inspection, pertaining only to that component or system, which are conducted and reported as such.

## 8.04 Complex Bridge and Tunnel QC/QA Program

The CBLIs review 100% of inspection reports under their responsibility prior to release. The majority of inspections involving the Complex Bridge and Tunnel section only concern one inspection engineer of each discipline. If multiple CBLIs of the same discipline participated in an inspection then that report will be reviewed by both engineers prior to submittal to the DPM.

An effort shall be made to rotate which CBLIs conduct routine inspections on each structure on an annual basis to add variation to the Complex Bridge and Tunnel section's internal QC program.

The DPM reviews 100% of all Complex Bridge and Tunnel reports under his area of responsibility prior to release.

The office review of reports will consist of validation for accuracy and consistency of the following:

- Inspection Type – The appropriate inspection types are identified.
- Inspection Date – Ensure that bridges are inspected on time.
- Inspection Frequency – Verify that inspection frequency is based on condition or policy (i.e., 12 month frequency criteria).
- Inspection Hours – Verify that the correct inspection hours are reported based on history of previous report hours, structure type and condition.
- Organization of Report – Verify that the report is organized, understandable, uses correct photo and file references that follow office policy.
- Inspection Resources – Verify that the appropriate resources needed for safety, access, and adequate inspection are being used.
- NRC Codes – Verify that the Numerical Rating Condition codes are supported by inspection report content. Coding information available in Appendix 8.09-C.
- Elements – Verify that the elements are complete and accurate.
- Repair Recommendations and Priorities – Verify that appropriate repairs and repair priorities are recommended based on inspection report content.
- Follow-Up Actions on Significant/Critical Findings – Ensure deficiencies that require immediate action have had the proper parties notified and are being monitored and/or followed up on.

Utilizing consultants on blue ribbon and in-depth inspections serves to act as QA for the Complex Bridge and Tunnel section. An effort is made to rotate which consultant conducts each blue ribbon or in-depth inspection. This process helps to ensure delivery of a comprehensive and high quality inspection program.

## 8.05 Tunnel Inspection Duties

On July 6, 2012 the President signed the Moving Ahead for Progress in the 21st Century Act (MAP-21), which **required** the Secretary to establish national standards for tunnel inspections. As a result, the FHWA **has issued** the National Tunnel Inspection Standards (NTIS) for highway tunnels. **The BPO is working to establish a program to meet the intent of the NTIS.** As such, routine inspections of the electrical and mechanical systems present in highway tunnels are to be conducted at a maximum of 24 month intervals. Routine inspections result in an inspection report created and submitted through Bridge Works. In-depth inspections result in detailed consultant reports that are reviewed by CBLIs in addition to a standard RIR. In-depth inspections of the mechanical and electrical systems are to be conducted at least once every six years. Maintenance and inspection guidelines for mechanical and electrical systems present in tunnels are outlined in the FHWA *Tunnel Operations, Maintenance, Inspection and Evaluation* (TOMIE) Manual. Each tunnel has its own structure file similar to that of our other complex bridges and tunnels which are updated with signed copies of applicable reports.

## 8.06 Complex Bridge and Tunnel Records

### A. Operation, Inspection and Maintenance Manuals

Every complex bridge has its own *Operation, Inspection, and Maintenance (OIM) Manual* developed by the Bridge Preservation Office as mandated by *Transportation Structures Preservation Manual M 23-11*. These are developed partially using the Operations and Maintenance (O&M) manuals provided to WSDOT as a result of Section 1-06.5 of *Standard Specifications*. O&M manuals consist of catalog cuts or shop drawings of each piece of equipment found on its corresponding structure. Both of these manuals as well as any as-builts must be periodically updated as structures are rehabilitated and the information contained within them becomes obsolete. Region(s) input is invaluable in the process of creating OIM manuals and correctly identifying operating procedures for each structure. Contract documents, special provisions, and as-builts are also used in the process of generating the OIM manual.

OIM manuals contain important information relevant to their corresponding complex bridge including but not limited to specific operational procedures, emergency procedures, recommended maintenance scheduling and procedure, as well as inspection procedures. Master copies of each OIM manual are retained by the BPO and the regions are provided with copies of every manual relevant to their bridges. A complete list of OIM manuals developed by the BPO is included in Appendix 8.09-F.

## B. Structure Files

Every complex bridge and tunnel has its own structure file maintained in accordance with the standards set in Chapter 2 of this manual to satisfy the FHWA. The physical location of structure file documents is indicated in Appendix 2.06-A “Bridge Preservation Floor Plan.” A more detailed explanation of the legend is as follows:

- “B- Movable Bridge Files” refers to project files, signed copies of every bridge inspection report, contract documents, microfilm cards and antiquated pictures from old inspections.
- “F-Letter Files” refers to the movable bridge letter files as well as reports generated by consultants. These reports are the original stamped and signed copies that come as a result of a Blue Ribbon inspection or an In-Depth inspection.

The current Routine and In-Depth inspection databases containing inspection dates and intervals for scheduling purposes are available to view on the Corporate drive. These files are only editable by members of the Complex Bridge and Tunnel section. These databases are available along the following file path on the Corporate drive: \Data\ Bridge\Movable. Folders labeled “Routines” and “In-Depth Database” contain the relevant files.

### 8.07 Bridge Damage/Emergency Responsibilities

As dictated in the WSDOT *Emergency Operations Plan M 54-11* BPO personnel are provided with emergency responder training. The BPO employs multiple mechanical and electrical engineers with offset schedules such that in the event of an emergency situation involving an electrical or mechanical component failure, personnel will be available to provide technical assistance to the Region(s). Should an emergency situation occur the Region(s) are to contact the BPO at which point technical assistance will be dispatched. After any emergency response situation the CBLI onsite for the incident shall prepare a report to be distributed amongst the BPO and the Region(s) via email. The BPO can always be reached via the emergency response phone at 360-480-4500.

### 8.08 Plans, Specifications and Estimates

The BPO assists the region with preparation of Plans, Specifications & Estimates documentation for the purpose of special inspections, requiring consultants, as well as rehabilitation activities. In the event electrical and mechanical components need to be acquired through the bidding process, the BPO provides assistance to the region with preparation of the proper documentation. During construction of repairs or rehabilitation of structures the BPO is available to assist the Region(s) and the Project Engineer Office as needed.



## 8.09 Appendices

|                 |                                                                       |
|-----------------|-----------------------------------------------------------------------|
| Appendix 8.09-A | BPO Memo for Blue Ribbon Inspection<br>Schedule Alteration            |
| Appendix 8.09-B | Guideline for Writing Electrical and Mechanical<br>Inspection Reports |
| Appendix 8.09-C | Numerical Rating Condition Description                                |
| Appendix 8.09-D | Continued Certification of Bridge Inspection Personnel                |
| Appendix 8.09-E | Complex Bridge and Tunnel Inspection List                             |
| Appendix 8.09-F | Operations, Inspection, and Maintenance Manual List                   |



S.F. 80  ROUTING SLIP SF 80 F

DATE: 28-99

TO: ORG

ADDRESS: MAY 31 1994

FROM: MML

DEPT. OF TRANSPORTATION

MAIL STOP PHONE

For Action       Per Your Request       Per Our Conversational  
 For Approval       Read and Return       Read & Route to Files  
 For Signature       For Your Information       For Your Comments

The random inspection shall include an element of "surprise" and an element of "independence" to and from the regular maintenance folks and their activities. Are we accomplishing this?

Please include me in the random inspections that are coming up. Thanks.



Memorandum

Date: May 10, 1994

From: O. R. George <sup>ORG</sup>  
Phone: 753-4739

Subject: Proposed Schedule For  
Floating Bridge Random  
Inspections

To: M. Myint Lwin  
Bridge & Structures - 7340

Random inspections of the four floating bridges are conducted by our office as outlined in the attached June 8, 1993 memorandum from A. H. Walley to S. A. Moon. We propose to delay the mechanical and electrical inspections on the Evergreen Point Bridge (520/8) until 1995 due to the major mechanical and electrical renovations taking place this summer. Inspections by our office during the construction phase would be redundant since the designer, Sverdrup Corporation will be assisting with construction services.

We also propose to conduct the first electrical random inspection on the Lacey V. Murrow Bridge (90/25S) in 1995. This first inspection will be within 2 years of opening the bridge to traffic and will meet the requirements of the June 8, 1993 memorandum. It was determined after the 1992 mechanical inspection of the Third Lake Bridge (90/25N) that mechanical inspections on both of the I-90 floating bridges are not needed due to their lack of mechanical components.

When in-depth mechanical/electrical inspections performed by consultants coincide with the random mechanical/electrical inspections, we will use the in-depth inspections in place of the random inspections. This occurs on the Hood Canal Bridge in 1994 and is denoted on the schedule by an asterisk.

With your approval, we would like to adopt the inspection schedule shown below which allows us to conduct 1 mechanical and 2 electrical inspections per year, rather than 2 mechanical and 4 electrical inspections every other year.

RECEIVED

MAY 12 1994

DEPT. OF TRANSPORTATION  
BRIDGE & STRUCTURES

DOT 700-008X  
Revised 6/92

M. Myint Lwin  
May 10, 1994  
Page 2

Inspection Schedule

| <u>Bridge No.</u> | <u>Water-Tightness</u> | <u>Electrical</u> | <u>Mechanical</u> |
|-------------------|------------------------|-------------------|-------------------|
| 90/25S            | Annually               | 1995, 1997, ...   | NA**              |
| 90/25N            | Annually               | 1994, 1996, ...   | NA**              |
| 104/5.1 & 5.2     | Annually               | 1994*, 1996, ...  | 1994*, 1996, ...  |
| 520/8             | Annually               | 1995, 1997, ...   | 1995, 1997, ...   |

\* In-depth electrical/mechanical inspections by consultants

\*\* Random mechanical inspections not needed, as determined after the 1992 random mechanical inspection on 90/25S.

*\* Shall include inspection/testing of sensors piping system and pumps.*

ORG:jj  
MPP/DLS  
Attachment

Approval: *M. Myint Lwin*  
M. MYINT LWIN, P.E.  
Bridge and Structures Engineer

Date: 5-28-94



Washington State  
Department of Transportation

Memorandum

Date: June 8, 1993  
 From: A. H. Waller  
 J. F. Conrad  
 Thru: E. R. Burch  
 J. R. Buss  
 To: S. A. Moon

Subject: Floating Bridge  
Random Inspections

As directed by the Transportation Commission, random inspections have been conducted on the three state floating bridges. Based on our office's evaluation of the initial inspections, we request your approval of the following proposals on the process to be used in the future:

1. Responsibility for planning and conducting the random inspections should be delegated to the Bridge Office, and clearly defined in Directive D23-11.
2. A report on findings on each inspection should be prepared by the Bridge Office and sent to the Chief Maintenance Engineer for further transmittals to the districts.
3. Annual random inspections should be conducted to verify water-tightness of the bridge pontoons.

Random inspections focusing on reliability of mechanical and electrical systems of the bridges should be conducted at two year intervals.

The following background is provided to assist in your consideration of the above proposals:

The Report issued on May 2, 1991 by the Blue Ribbon Panel investigating the sinking of the Lacey V. Murrow Bridge included a recommendation for "Independent Random Inspections" of the state's floating bridges. ~~These inspections were to be "in addition to the scheduled major inspections" and were to be conducted "by people not responsible for bridge maintenance".~~ Emphasis of the inspections was to be "placed on the water-tightness of the bridge and on the reliability of electrical and mechanical systems.

S. A. Moon  
June 8, 1993  
Page 2

Transportation Commission Resolution 398 directed the department to "carefully review, analyze and, if feasible incorporate certain recommendations of the Blue Ribbon Panel". The Resolution's "implementing action document" directs us to address random inspections as follows:

"The Department will hire a consultant or utilize an independent division internal to the Department to provide random inspections on the floating bridges. These inspections ~~are to occur unannounced at least once a year for each bridge and will be an in-depth review of the water-tightness of the structure plus an inspection of the mechanical and electrical component of each bridge.~~ A detailed report will be required."

Copies of pertinent sections of the Blue Ribbon Panel Report and Resolution 398 are attached.

An initial random inspection was conducted on the Hood Canal, Evergreen Point and 3rd Lake Floating Bridges in August and September of 1992. The inspection team consisted of members from the Bridge and Structures and Marine Transportation Offices and from the office of the State's mechanical and electrical consultant; the Sverdrup Corporation. Reports on inspection findings were prepared by the Bridge Office and provided to the districts through the HQ Maintenance Office. Inspection recommendations are now being implemented or considered for implementation by the districts.

A post inspection review of the random inspection process by our offices led to the recommendations in this letter. Responsibilities for these inspections need to be clearly defined in a Department Directive. Also, although a one year interval for random inspection of pontoon watertightness appears to be appropriate, ~~a longer interval is needed between random inspections of the electrical and mechanical systems. The longer interval is needed to provide sufficient time to cost-effectively address any problems identified on these complex systems.~~

AHW/JFC:sf  
ORG  
Attachments

Approval: S.A. Moon  
Deputy Secretary of Transportation

Date: 6-22-93





# **Appendix 8.09-B**

## **Guideline for Writing Electrical and Mechanical Inspection Reports**

### **GUIDELINE FOR WRITING ELECTRICAL AND MECHANICAL INSPECTION REPORTS FOR WSDOT**

**General - Format and fonts used in the electrical and mechanical inspection reports must be the same. Single side print.**

**See page 4-8 for a sample cover page.**

**The cover page of the draft submittal shall have "DRAFT" indicated on top of Washington State Department of Transportation.**

**The title of the report and the bridge name and bridge number will be indicated exactly as spelled out in the scope of work for the inspection.**

**A photograph of the general outline of the bridge will appear on the cover of the reports.**

**The Consultants Company name will appear under the photograph.**

**The PE Seal shall be placed below the photograph on the Draft but not signed. When the final submittal is ready for the PE Seal it shall be placed on the original report and signed by the Consultant. Color copies will then be made of the original report.**

**The Table of Contents page shall be page number i. Each page of the report will be numbered sequentially and will agree with the page numbers listed in the Table of Contents. Font size shall be No. 12.**

**See page 5 of 8 for a sample Table of Contents.**

**The footers for each report page and appendices shall have the bridge name and number on two lines on the bottom left, the page number in the bottom center and the type of inspection and month and year on two lines on the bottom right. The font shall be No. 10.**

**The font for the report titles and text shall be No. 12. Heading shall be capitalized and bold.**

**The report shall include the following sections in the order listed:**

**The Executive Summary should be brief but give a general assessment of the condition of the bridge systems, major conclusions and a summary of any pertinent recommendations.**

**The Purpose and Scope of Inspection should state that the purpose of the inspection is to determine the condition of the bridge equipment and identify any deficiencies.**

The dates of the inspection and the Consultants Company name should also be indicated. Reference shall be made to the Scope of Work provided by WSDOT in the inspection request for proposal and it shall be attached to the report in Appendix A.

See page 6 of 8 for a sample of the Executive Summary, the Purpose and the Scope of Work.

Any deviations from the Scope of Work should be identified with an explanation of why the deviations occurred.

Inspection Methodology should briefly describe the type of inspections, tests or measurements performed.

A general description of the bridge is not required. We know where the bridge is, what river it crosses and how it operates.

Inspection Findings shall identify the condition of the systems in the order that they are listed in the Scope of Work. All deficiencies shall be identified and reference shall be made to its attached photograph. The photographs shall be the last Appendix in the report except when additional data such as oil sample analysis or other sub-consultant reports are attached. The photos shall be referenced in the body of the report as follows: (See Photo \_\_\_ in Appendix \_\_\_). Data such as motor currents, insulation resistance, gear tooth measurements, etc. shall be tabulated and included in the Appendices. The tabulated data shall be referenced in the body of the report as follows: (See Table \_\_\_ in Appendix \_\_\_).

Conclusions shall identify those items which are in need of Emergency Repair, Maintenance Repair or Rehabilitation. Under each of these categories they shall be listed in the order in which they appear in the Scope of Work.

Recommendations shall include Emergency Repairs, Maintenance Repairs or Rehabilitation Recommendations. Emergency Repair recommendations which are not addressed during the inspection shall be made in writing within 48 hours of the finding from the Consultant to the Bridge Preservation Engineer. Recommendations for Maintenance Repairs must be within the capabilities of the available maintenance forces. Rehabilitation recommendations should be made for conditions which will provide 20+ years of extended service.

Cost estimates shall be listed for each rehabilitation recommendation in the order that the system appears in the Scope of Work. (Service Entrance; Power Distribution; Motors and Brakes; Control System; Wire and Conduit; etc.) Do not say Electrical and Mechanical Rehabilitation and give a lump sum figure. Beneath the cost estimate a note shall indicate that cost estimates are for material and installation labor (bridge items only). They do not include cost for design engineering, maintenance, traffic control, construction management or administration.

Appendices shall be made attached in the following order:

Appendix A – Scope of Work

Appendix B – Condensed Mech/Elect Rating Summary

B1 Numerical Rating Condition Description (WSDOT provided with Scope of Work)

B2 Condensed Mech/Elect Rating Summary

C, D, etc – tabulated data, schematics, tables of measurements etc.

The last Appendix should be photographs unless there are Co-Consultant documents like oil analysis in which case the photographs are the next to last and the Co-Consultant data is last. There shall be two photographs on each page.

Appendices shall have a cover page with a Table of Contents.

See page 7 of 8 for a sample Appendix Table of Contents

Appendices sheets shall have the same footer as the report but the page number will be prefaced with the letter of the Appendix

Data sheets and measurements sheets shall be arranged in the order that the subject appears in the Scope of Work.

See page 8 of 8 for a sample photograph page.

All reports are to be comb bound with clear plastic covers. The final submittal shall consist of one bound final report with original photographs which shall be stamped and signed by an Engineer of the appropriate discipline licensed in the State of Washington and six color copies of the report. An electronic copy of the final report in PDF format and an electronic copy of all photographs in jpeg format shall be submitted with the final reports.

**WASHINGTON STATE  
DEPARTMENT OF TRANSPORTATION**

**(TYPE) INSPECTION REPORT  
MONTH, YEAR**

**NAME OF BRIDGE  
BRIDGE NO. (W/XYZ)**



**PREPARED BY  
FIRM NAME  
CITY, STATE**



TABLE OF CONTENTS

|                                               |      |
|-----------------------------------------------|------|
|                                               | Page |
| EXECUTIVE SUMMARY.....                        | 1    |
| PURPOSE AND SCOPE OF INSPECTION.....          | 1    |
| INSPECTION METHODOLOGY.....                   | 3    |
| INSPECTION FINDINGS.....                      | 4    |
| SCOPE OF WORK ITEM.....                       | 5    |
| SCOPE OF WORK ITEM.....                       | 6    |
| CONCLUSIONS.....                              | 7    |
| RECOMMENDATIONS.....                          | 8    |
| COST ESTIMATE.....                            | 9    |
| APPENDICES:                                   |      |
| A) SCOPE OF WORK.....                         | Ai   |
| B) CONDENSED (MECH/ELECT) RATING SUMMARY..... | Bi   |
| C) TABLES.....                                | Ci   |
| D) PHOTOGRAPHS.....                           | Di   |
| E) OILSAMPLE ANALYSIS.....                    | Ei   |

Name of Bridge  
Bridge No.

i

Type of Inspection  
Month, Year

**EXECUTIVE SUMMARY**

This report documents the condition of the Bridge Name and Bridge Number, electrical (or mechanical) systems. Overall, the bridge operated in an acceptable manner during the inspection. There were no emergency repairs required at this time. Items which required maintenance have been identified in the recommendations. Items requiring rehabilitation include the following: (Do not just copy the repair list or the rehabilitation recommendation list. Write a summary.)

**PURPOSE AND SCOPE OF INSPECTION**

The purpose of this report is to document the condition of the Bridge Name and Number on which an In-Depth Electrical (or Mechanical) inspection was performed on (Date). The Scope of Work for this inspection is attached as Appendix 1.

Name of Bridge  
Bridge No.

1

Type of Inspection  
Month, Year

6-8

wirgrev7

APPENDIX D  
PHOTOGRAPHS

|         |                  | Page |
|---------|------------------|------|
| Photo 1 | Photo Title..... | D1   |
| Photo 2 | Photo Title..... | D1   |
| Photo 3 | Photo Title..... | D2   |
| Photo 4 | Photo Title..... | D2   |
| Photo 5 | Photo Title..... | D3   |

Name of Bridge  
Bridge No.

Di

Type of Inspection  
Month, Year

7-8

wirgrev7



Photo 1 Control Desk



Photo 2 Broken conduit fitting on NE Thruster Brake

Name of Bridge  
Bridge No.

D1

Type of Inspection  
Month, Year

8-8

wirgrev7



## Appendix 8.09-C Numerical Rating Condition Description

| NUMERICAL RATING CONDITION DESCRIPTION |                                                                                                                                                                                                                                                                                                                                                                                                                                                                                                                                                                                                                                                                                                                                                                                                                                                                                                                                                                                                                                                                                                                                                                                    |
|----------------------------------------|------------------------------------------------------------------------------------------------------------------------------------------------------------------------------------------------------------------------------------------------------------------------------------------------------------------------------------------------------------------------------------------------------------------------------------------------------------------------------------------------------------------------------------------------------------------------------------------------------------------------------------------------------------------------------------------------------------------------------------------------------------------------------------------------------------------------------------------------------------------------------------------------------------------------------------------------------------------------------------------------------------------------------------------------------------------------------------------------------------------------------------------------------------------------------------|
| Rating Condition                       | Description of Condition                                                                                                                                                                                                                                                                                                                                                                                                                                                                                                                                                                                                                                                                                                                                                                                                                                                                                                                                                                                                                                                                                                                                                           |
| 1                                      | FAILED CONDITION. Item not operational.                                                                                                                                                                                                                                                                                                                                                                                                                                                                                                                                                                                                                                                                                                                                                                                                                                                                                                                                                                                                                                                                                                                                            |
| 2                                      | POTENTIALLY HAZARDOUS. Deterioration or damage to span drive or stabilizing machinery which could cause movable span to become imminently unstable in any position. Malfunction or deterioration of electrical system which could cause loss of control of the moving span. Deficiency in electrical system design, maintenance, or operational procedure which could cause loss of control of moving span. Inoperable vehicular traffic control device. Also, extreme cases of defects listed under higher rating numbers. Bridge may not be opened to marine traffic. If problem is with stabilizing machinery in the closed position, temporary shoring or support may be necessary to permit safe vehicular traffic over the closed bridge at reduced speed or rating. However, if problem, is with counterweight components of vertical lift bridge stabilizing machinery, bridge may be closed to all traffic until shored or repaired.                                                                                                                                                                                                                                      |
| 3                                      | VERY SERIOUS DETERIORATION. Deterioration or damage to machinery which will not cause imminent instability of a non-redundant span drive but reduces allowable load on drive and may cause future instability if not corrected. Stabilizing machinery damaged, deteriorated, or improperly operated such that movable structure is not properly supported causing structure not to behave as designed and resulting in structural overstress and movements under vehicular traffic that severely affect quality. Severe misalignment of stabilizing machinery, resulting in overload of electrical system and consequent overstress of span drive machinery. Severe interference between moving span and fixed structure due to substructure movements. Deterioration of electrical control system such that many of the safety interlocks are normally by-passed, inconsistent control of moving span, and inoperable or missing traffic control devices. Operation of movable span may be restricted in terms of opening angle, number of openings, and allowable wind velocity. If problem is with stabilizing machinery, shoring may be necessary to permit vehicular traffic. |
| 4                                      | SERIOUS DETERIORATION. Severe wear, deterioration or damage to span drive or stabilizing machinery due to overloading, inadequate maintenance, improper operation, or movement of the structure or substructure. Electrical system malfunctions and numerous safety interlocks are by-passed. Results are inconsistent, noisy, and unreliable operation of the movable span. Improper closure, affecting structural action and vehicular ride quality. Electrical system has archaic components for which replacements are no longer available and open bus panelboards that are considered unsafe nowadays.                                                                                                                                                                                                                                                                                                                                                                                                                                                                                                                                                                       |
| 5                                      | MODERATE DETERIORATION. Excessive wear, some damage and deterioration of span drive and stabilizing mechanical machinery. Repairs and replacement of some machinery components required. Bearings may need liner adjustment. Machinery may be misaligned due to shifting of structure and substructure but not enough to seriously overload span drive: correctable by adjusting machinery component location using shims, etc. Replacement of corroded machinery fasteners required. Moving span under control but some indicating and safety devices may be inoperable and may be by-passed, and span limit switch may need adjustment.                                                                                                                                                                                                                                                                                                                                                                                                                                                                                                                                          |
| 6                                      | MINOR DETERIORATION. None of the major mechanical machinery components are worn or damaged to the extent that replacement is now required. Some components of the span drive may need to be replaced, such as flex-couplings grids, brake linings, etc. Span stabilizing machinery functioning except that wear may have caused excessive clearances in lock bar guides, etc. Shimming of lock bar guides, replacement of limit switches and adjustments necessary. Machinery needs cleaning, painting, lubrication and adjustment. Electrical system generally functioning as designed. Replacement of some relays, indicating devices and lights may be required. Traffic control devices need repair or maintenance.                                                                                                                                                                                                                                                                                                                                                                                                                                                            |
| 7                                      | ALMOST NEW CONDITION. No extensive repairs required. Machinery needs cleaning, painting, lubrication, and adjustment. Electrical systems functioning as designed; may need replacement of indicating lights and minor limit switch adjustment, cleaning of relay contacts and housekeeping in panelboard. Traffic control devices functioning but may need replacement of obstruction lights, object markers, painting of housings, lubrication and adjustment of limit switches.                                                                                                                                                                                                                                                                                                                                                                                                                                                                                                                                                                                                                                                                                                  |
| 8                                      | NEW CONDITION. Virtually no repairs required. Mechanical machinery may need cleaning, touch-up painting and lubrication. Electrical system and traffic devices functioning but may need replacement of bulbs and minor housekeeping.                                                                                                                                                                                                                                                                                                                                                                                                                                                                                                                                                                                                                                                                                                                                                                                                                                                                                                                                               |
| 9                                      | NOT APPLICABLE. This device or equipment is not on the structure being inspected.                                                                                                                                                                                                                                                                                                                                                                                                                                                                                                                                                                                                                                                                                                                                                                                                                                                                                                                                                                                                                                                                                                  |
| N/I                                    | NOT INSPECTED. This device or equipment was not included in the inspection.                                                                                                                                                                                                                                                                                                                                                                                                                                                                                                                                                                                                                                                                                                                                                                                                                                                                                                                                                                                                                                                                                                        |



# **Continued Certification of**

## **Appendix 8.09-D    Complex Bridge Inspection Personnel**

---

A continued certification of complex bridge and tunnel inspection personnel has been established to ensure that all program managers and inspectors are kept up to date with the latest practices and technology in the areas of bridge and tunnel inspections. This continued certification program requires that each Electrical/Mechanical Complex Bridge Lead Inspector (CBLI) and their Delegated Program Manager(DPM) must participate in the following during a five-year period to maintain certification:

- 30 hours of bridge related continuing education courses and training including WSDOT sponsored bridge training, bridge conferences and other NHI bridge training courses as approved by the delegated program manager.

### **Continued Certification Course and Training List**

The following is a list of courses that are examples of what would qualify in combination to acquire 30 hours of continuing education hours in the designated five-year period. It is the inspector's responsibility to ensure that the information is given to their manager within the necessary timeframes to ensure continued certification.

|                                                          |          |
|----------------------------------------------------------|----------|
| National Electric Code                                   | 16 hours |
| Grounding and Bonding Training                           | 16 hours |
| NFPA 70E Arc Flash Electrical Safety                     | 16 hours |
| Programmable Logic Controller Training                   | 24 hours |
| AC/DC Motors and Drives Training                         | 16 hours |
| Cathodic Protection                                      | 40 hours |
| National Fire Alarm and Signaling Code                   | 24 hours |
| Non-Destructive Testing Training                         | 24 hours |
| Hydraulics & System Troubleshooting                      | 16 hours |
| Principles of Bearings and Lubrication                   | 16 hours |
| Coupling and Shaft Alignment                             | 16 hours |
| Strain Gage Workshop                                     | 40 hours |
| Pacific NW Bridge Maintenance Conference                 | 16 hours |
| Pacific NW Bridge Inspection Conference                  | 16 hours |
| Heavy Movable Structures Conference                      | 16 hours |
| Western Bridge Engineers' Seminar                        | 16 hours |
| WSDOT/LTAP – Bridge Condition Inspection Training (BCIT) | 72 hours |
| WSDOT/LTAP – Bridge Condition Inspection Update (BCIU)   | 16 hours |



The following is a list of complex bridges and tunnels that require electrical and mechanical inspections in accordance with the NBIS and NTIS. The regularly scheduled inspections for each structure are listed along with their frequency. Special inspections in addition to those listed may be conducted if deemed necessary.

**12/12N – Wishkah River Bridge**

**Electrical**

Routine Inspection (1 yr)  
In-Depth Inspection (6 yrs)

**Mechanical**

Routine Inspection (1 yr)  
In-Depth Inspection (6 yrs)

**12/12S – Heron Street Bridge**

**Electrical**

Routine Inspection (1 yr)  
In-Depth Inspection (6 yrs)

**Mechanical**

Routine Inspection (1 yr)  
In-Depth Inspection (6 yrs)

**12/915 – Snake River Clarkston**

**Electrical**

Routine Inspection (1 yr)  
In-Depth Inspection (6 yrs)

**Mechanical**

Routine Inspection (1 yr)  
In-Depth Inspection (6 yrs)  
Counterweight Rope Inspection (6 yrs)  
Trunnion Bearing Inspection (6 yrs)

**16/110E – Tacoma Narrows**

**Electrical**

Routine Inspection (1 yr)  
In-Depth Inspection (6 yrs)

**Mechanical**

Routine Inspection (1 yr)  
In-Depth Inspection (6 yrs)

**16/110W – Tacoma Narrows**

**Electrical**

Routine Inspection (1 yr)  
In-Depth Inspection (6 yrs)

**Mechanical**

Routine Inspection (1 yr)  
In-Depth Inspection (6 yrs)

**90/25N – Homer M. Hadley**

**Electrical**

Routine Inspection (1 yr)  
Blue Ribbon Inspection (2 yrs)  
Blue Ribbon Cathodic Protection Inspection (2 yrs)  
In-Depth Inspection (6 yrs)  
In-Depth Cathodic Protection Inspection (6 yrs)

**90/25S – Lacey V. Murrow****Electrical**

Routine Inspection (1 yr)  
 Blue Ribbon Inspection (2 yrs)  
 Blue Ribbon Cathodic Protection Inspection (2 yrs)  
 In-Depth Inspection (6 yrs)  
 In-Depth Cathodic Protection Inspection (6 yrs)

**99/530E – Duwamish River Br****Electrical**

Routine Inspection (1 yr)  
 In-Depth Inspection (6 yrs)

**Mechanical**

Routine Inspection (1 yr)  
 In-Depth Inspection (6 yrs)  
 Trunnion Bearing Inspection (6 yrs)

**99/530W – Duwamish River Br****Electrical**

Routine Inspection (1 yr)  
 In-Depth Inspection (6 yrs)

**Mechanical**

Routine Inspection (1 yr)  
 In-Depth Inspection (6 yrs)

**101/115 – Chehalis River Bridge****Electrical**

Routine Inspection (1 yr)  
 In-Depth Inspection (6 yrs)

**Mechanical**

Routine Inspection (1 yr)  
 In-Depth Inspection (6 yrs)

**101/125E – Hoquiam River - Riverside****Electrical**

Routine Inspection (1 yr)  
 In-Depth Inspection (6 yrs)

**Mechanical**

Routine Inspection (1 yr)  
 In-Depth Inspection (6 yrs)  
 Counterweight Rope Inspection (6 yrs)

**101/125W – Hoquiam River - Simpson****Electrical**

Routine Inspection (1 yr)  
 In-Depth Inspection (6 yrs)

**Mechanical**

Routine Inspection (1 yr)  
 In-Depth Inspection (6 yrs)

**104/5.1 – Hood Canal-W.A. Bugge Bridge W****Electrical**

Routine Inspection (1 yr)  
 Blue Ribbon Inspection (2 yrs)  
 Blue Ribbon CP Inspection (2 yrs)  
 In-Depth Inspection (6 yrs)  
 In-Depth CP Inspection (6 yrs)

**Mechanical**

Routine Inspection (1 yr)  
 Blue Ribbon Inspection (2 yrs)  
 In-Depth Inspection (6 yrs)

**104/5.2 – Hood Canal-W.A. Bugge Br E****Electrical**

Routine Inspection (1 yr)  
 Blue Ribbon Inspection (2 yrs)  
 Blue Ribbon CP Inspection (2 yrs)  
 In-Depth Inspection (6 yrs)  
 In-Depth CP Inspection (6 yrs)

**Mechanical**

Routine Inspection (1 yr)  
 Blue Ribbon Inspection (2 yrs)  
 In-Depth Inspection (6 yrs)

**513/12 – Montlake Bridge****Electrical**

Routine Inspection (1 yr)  
 In-Depth Inspection (6 yrs)

**Mechanical**

Routine Inspection (1 yr)  
 In-Depth Inspection (6 yrs)

**520/8 – Albert D. Rosellini Bridge****Electrical**

Routine Inspection (1 yr)  
 Blue Ribbon Inspection (2 yrs)  
 In-Depth Inspection (6 yrs)

**Mechanical**

Routine Inspection (1 yr)  
 Blue Ribbon Inspection (2 yrs)  
 In-Depth Inspection (6 yrs)

**529/10E – Snohomish River Bridge****Electrical**

Routine Inspection (1 yr)  
 In-Depth Inspection (6 yrs)

**Mechanical**

Routine Inspection (1 yr)  
 In-Depth Inspection (6 yrs)  
 Counterweight Rope Inspection (6 yrs)

**529/10W – Snohomish River Bridge****Electrical**

Routine Inspection (1 yr)  
 In-Depth Inspection (6 yrs)

**Mechanical**

Routine Inspection (1 yr)  
 In-Depth Inspection (6 yrs)  
 Counterweight Rope Inspection (6 yrs)

**529/20E – Steamboat Slough****Electrical**

Routine Inspection (1 yr)  
 In-Depth Inspection (6 yrs)

**Mechanical**

Routine Inspection (1 yr)  
 In-Depth Inspection (6 yrs)

**529/20W – Steamboat Slough****Electrical**

Routine Inspection (1 yr)  
 In-Depth Inspection (6 yrs)

**Mechanical**

Routine Inspection (1 yr)  
 In-Depth Inspection (6 yrs)

**90/22LID – Martin Luther King LID****Electrical**

Routine Inspection (2 yr)  
 In-Depth Inspection (6 yrs)

**Mechanical**

Routine Inspection (2 yr)  
 In-Depth Inspection (6 yrs)

**90/24N – Mt Baker Ridge Tunnel****Electrical**

Routine Inspection (2 yr)  
In-Depth Inspection (6 yrs)

**Mechanical**

Routine Inspection (2 yr)  
In-Depth Inspection (6 yrs)

**90/24S – Mt Baker Ridge Tunnel****Electrical**

Routine Inspection (2 yr)  
In-Depth Inspection (6 yrs)

**Mechanical**

Routine Inspection (2 yr)  
In-Depth Inspection (6 yrs)

**90/26LID – First Hill LID****Electrical**

Routine Inspection (2 yr)  
In-Depth Inspection (6 yrs)

**Mechanical**

Routine Inspection (2 yr)  
In-Depth Inspection (6 yrs)

**5/549CNC – Wash St Convention Center****Electrical**

Routine Inspection (2 yr)  
In-Depth Inspection (6 yrs)

**Mechanical**

Routine Inspection (2 yr)  
In-Depth Inspection (6 yrs)

**304/9 – Bremerton Tunnel****Electrical**

Routine Inspection (2 yr)  
In-Depth Inspection (6 yrs)

**Mechanical**

Routine Inspection (2 yr)  
In-Depth Inspection (6 yrs)



## Appendix 8.09-F

# Operations, Inspections, and Maintenance Manual List

The following is a tabulated listing of all of the OIM manuals generated by the BPO. They are updated as necessary when rehabilitations of bridge systems occur or major components are changed.

| Bridge #      | Bridge Name               | Manual Date | Revision Date | Document Number |
|---------------|---------------------------|-------------|---------------|-----------------|
| 12/12N        | Wishkah River             | Jun-03      | 2006          | M 23-25         |
| 12/12S        | Wishkah River - Heron     | Jun-03      | 2007          | M 23-19         |
| 12/915        | Snake River - Clarkston   | Jun-96      | Dec-04        | M 23-26         |
| 16/110E       | Tacoma Narrows            | Jun-95      |               | *               |
| 90/25N        | Homer M. Hadley           | Jul-06      |               | *               |
| 90/25S        | Lacey V. Murrow           | Jul-06      |               | *               |
| 99/530E       | Duwamish River            | Jun-01      |               | M 23-31         |
| 99/530W       | Duwamish River            | Jun-01      | 2007          | *               |
| 101/115       | Chehalis River            | Oct-99      | Aug-05        | M 23-23         |
| 101/125E      | Hoquiam River - Riverside | Jun-97      |               | M 23-22         |
| 101/125W      | Hoquiam River - Simpson   | Sep-79      |               | M 23-33         |
| 104/5.1 & 5.2 | Hood Canal                | Jun-96      |               | M 23-12         |
| 513/12        | Montlake Bridge           | Nov-02      |               | M 23-30         |
| 520/8         | Evergreen Point           | Apr-04      |               | M 23-13         |
| 529/10E & W   | Snohomish River           | Mar-01      |               | M 23-21         |
| 529/20E & W   | Steamboat Slough          | Jan-05      |               | M 23-28         |

\*Document number not yet assigned.

