



**Washington State  
Department of Transportation**

---

# Construction Manual

M 41-01.42

July 2023

**Engineering and Regional Operations**  
State Construction Office

## ENGLISH

### Title VI Notice to Public

It is the Washington State Department of Transportation's (WSDOT) policy to assure that no person shall, on the grounds of race, color, national origin, as provided by Title VI of the Civil Rights Act of 1964, be excluded from participation in, be denied the benefits of, or be otherwise discriminated against under any of its programs and activities. Any person who believes his/her Title VI protection has been violated, may file a complaint with WSDOT's Office of Equity and Civil Rights (OECR). For additional information regarding Title VI complaint procedures and/or information regarding our non-discrimination obligations, please contact OECR's Title VI Coordinator at (360) 705-7090.

### Americans with Disabilities Act (ADA) Information

This material can be made available in an alternate format by emailing the Office of Equity and Civil Rights at [wsdotada@wsdot.wa.gov](mailto:wsdotada@wsdot.wa.gov) or by calling toll free, 855-362-4ADA(4232). Persons who are deaf or hard of hearing may make a request by calling the Washington State Relay at 711.

---

## ESPAÑOL

### Notificación de Título VI al Público

La política del Departamento de Transporte del Estado de Washington (Washington State Department of Transportation, WSDOT) es garantizar que ninguna persona, por motivos de raza, color u origen nacional, según lo dispuesto en el Título VI de la Ley de Derechos Civiles de 1964, sea excluida de la participación, se le nieguen los beneficios o se le discrimine de otro modo en cualquiera de sus programas y actividades. Cualquier persona que considere que se ha violado su protección del Título VI puede presentar una queja ante la Oficina de Equidad y Derechos Civiles (Office of Equity and Civil Rights, OECR) del WSDOT. Para obtener más información sobre los procedimientos de queja del Título VI o información sobre nuestras obligaciones contra la discriminación, comuníquese con el coordinador del Título VI de la OECR al (360) 705-7090.

### Información de la Ley sobre Estadounidenses con Discapacidades (ADA, por sus siglas en inglés)

Este material puede estar disponible en un formato alternativo al enviar un correo electrónico a la Oficina de Equidad y Derechos Civiles a [wsdotada@wsdot.wa.gov](mailto:wsdotada@wsdot.wa.gov) o llamando a la línea sin cargo 855-362-4ADA(4232). Personas sordas o con discapacidad auditiva pueden solicitar la misma información llamando al Washington State Relay al 711.

---

## 한국어 - KOREAN

### 제6조 관련 공지사항

워싱턴 주 교통부(WSDOT)는 1964년 민권법 타이틀 VI 규정에 따라, 누구도 인종, 피부색 또는 출신 국가를 근거로 본 부서의 모든 프로그램 및 활동에 대한 참여가 배제되거나 혜택이 거부되거나, 또는 달리 차별받지 않도록 하는 것을 정책으로 하고 있습니다. 타이틀 VI에 따른 그/그녀에 대한 보호 조항이 위반되었다고 생각된다면 누구든지 WSDOT의 평등 및 민권 사무국(OECR)에 민원을 제기할 수 있습니다. 타이틀 VI에 따른 민원 처리 절차에 관한 보다 자세한 정보 및/또는 본 부서의 차별금지 의무에 관한 정보를 원하신다면, (360) 705-7090으로 OECR의 타이틀 VI 담당자에게 연락해주시십시오.

### 미국 장애인법(ADA) 정보

본 자료는 또한 평등 및 민권 사무국에 이메일 [wsdotada@wsdot.wa.gov](mailto:wsdotada@wsdot.wa.gov) 을 보내시거나 무료 전화 855-362-4ADA(4232)로 연락하셔서 대체 형식으로 받아보실 수 있습니다. 청각 장애인은 워싱턴주 중계 711로 전화하여 요청하실 수 있습니다.

---

## русский - RUSSIAN

### Раздел VI Общественное заявление

Политика Департамента транспорта штата Вашингтон (WSDOT) заключается в том, чтобы исключить любые случаи дискриминации по признаку расы, цвета кожи или национального происхождения, как это предусмотрено Разделом VI Закона о гражданских правах 1964 года, а также случаи недопущения участия, лишения льгот или другие формы дискриминации в рамках любой из своих программ и мероприятий. Любое лицо, которое считает, что его средства защиты в рамках раздела VI были нарушены, может подать жалобу в Ведомство по вопросам равенства и гражданских прав WSDOT (OECR). Для дополнительной информации о процедуре подачи жалобы на несоблюдение требований раздела VI, а также получения информации о наших обязательствах по борьбе с дискриминацией, пожалуйста, свяжитесь с координатором OECR по разделу VI по телефону (360) 705-7090.

### Закон США о защите прав граждан с ограниченными возможностями (ADA)

Эту информацию можно получить в альтернативном формате, отправив электронное письмо в Ведомство по вопросам равенства и гражданских прав по адресу [wsdotada@wsdot.wa.gov](mailto:wsdotada@wsdot.wa.gov) или позвонив по бесплатному телефону 855-362-4ADA(4232). Глухие и слабослышащие лица могут сделать запрос, позвонив в специальную диспетчерскую службу штата Вашингтон по номеру 711.(4232). Глухие и слабослышащие лица могут сделать запрос, позвонив в специальную диспетчерскую службу штата Вашингтон по номеру 711.

## tiếng Việt - VIETNAMESE

### Thông báo Khoản VI dành cho công chúng

Chính sách của Sở Giao Thông Vận Tải Tiểu Bang Washington (WSDOT) là bảo đảm không để cho ai bị loại khỏi sự tham gia, bị từ khước quyền lợi, hoặc bị kỳ thị trong bất cứ chương trình hay hoạt động nào vì lý do chủng tộc, màu da, hoặc nguồn gốc quốc gia, theo như quy định trong Mục VI của Đạo Luật Dân Quyền năm 1964. Bất cứ ai tin rằng quyền bảo vệ trong Mục VI của họ bị vi phạm, đều có thể nộp đơn khiếu nại cho Văn Phòng Bảo Vệ Dân Quyền và Bình Đẳng (OECR) của WSDOT. Muốn biết thêm chi tiết liên quan đến thủ tục khiếu nại Mục VI và/hoặc chi tiết liên quan đến trách nhiệm không kỳ thị của chúng tôi, xin liên lạc với Phó Trí Viên Mục VI của OEER số (360) 705-7090.

### Thông tin về Đạo luật Người Mỹ tàn tật (Americans with Disabilities Act, ADA)

Tài liệu này có thể thực hiện bằng một hình thức khác bằng cách email cho Văn Phòng Bảo Vệ Dân Quyền và Bình Đẳng [wsdotada@wsdot.wa.gov](mailto:wsdotada@wsdot.wa.gov) hoặc gọi điện thoại miễn phí số, 855-362-4ADA(4232). Người điếc hoặc khiếm thính có thể yêu cầu bằng cách gọi cho Dịch vụ Tiếp âm Tiểu bang Washington theo số 711.

## العربية - ARABIC

### العنوان 6 إشعار للجمهور

تتمثل سياسة وزارة النقل في ولاية واشنطن (WSDOT) في ضمان عدم استبعاد أي شخص، على أساس العرق أو اللون أو الأصل القومي من المشاركة في أي من برامجها وأنشطتها أو الحرمان من الفوائد المتاحة بموجبها أو التعرض للتمييز فيها بخلاف ذلك، كما هو منصوص عليه في الباب السادس من قانون الحقوق المدنية لعام 1964. ويمكن لأي شخص يعتقد أنه تم انتهاك حقوقه التي يكفلها الباب السادس تقديم شكوى إلى مكتب المساواة والحقوق المدنية (OEER) التابع لوزارة النقل في ولاية واشنطن. للحصول على معلومات إضافية بشأن إجراءات الشكاوى وأو بشأن التزاماتنا بعدم التمييز بموجب الباب السادس، يرجى الاتصال بمنسق الباب السادس في مكتب المساواة والحقوق المدنية على الرقم (360) 705-7090.

### معلومات قانون الأمريكيين ذوي الإعاقة (ADA)

يمكن توفير هذه المواد في تنسيق بديل عن طريق إرسال رسالة بريد إلكتروني إلى مكتب المساواة والحقوق المدنية على [wsdotada@wsdot.wa.gov](mailto:wsdotada@wsdot.wa.gov) أو عن طريق الاتصال بالرقم المجاني: (4232) 855-362-4ADA. يمكن للأشخاص الصم أو ضعاف السمع تقديم طلب عن طريق الاتصال بخدمة Washington State Relay على الرقم 711.

## 中文 - CHINESE

### 《权利法案》Title VI公告

<華盛頓州交通部(WSDOT)政策規定，按照《1964年民權法案》第六篇規定，確保無人因種族、膚色或國籍而被排除在WSDOT任何計畫和活動之外，被剝奪相關權益或以其他方式遭到歧視。如任何人認為其第六篇保護權益遭到侵犯，則可向WSDOT的公平和民權辦公室(OEER)提交投訴。如需關於第六篇投訴程式的更多資訊和/或關於我們非歧視義務的資訊，請聯絡OEER的第六篇協調員，電話(360) 705-7090。

### 《美国残疾人法案》(ADA)信息

可向公平和民權辦公室發送電子郵件[wsdotada@wsdot.wa.gov](mailto:wsdotada@wsdot.wa.gov)或撥打免費電話 855-362-4ADA(4232)，以其他格式獲取此資料。听力丧失或听觉障碍人士可拨打711联系Washington州转接站。

## Af-soomaaliga - SOMALI

### Ciwaanka VI Ogeysiiska Dadweynaha

Waa siyaasada Waaxda Gaadiidka Gobolka Washington (WSDOT) in la xaqiijiy in aan qofna, ayadoo la cuskanaayo sababo la xariira isir, midab, ama wadanku kasoo jeedo, sida ku qoran Title VI (Qodobka VI) ee Sharciga Xaquuqda Madaniga ah ah oo soo baxay 1964, laga saarin ka qaybgalka, loo diidin faa'iidooyinka, ama si kale loogu takoorin barnaamijyadeeda iyo shaqooyinkeeda. Qof kasta oo aaminsan in difaaciisa Title VI la jebiyay, ayaa cabasho u gudbin kara Xafiiska Sinaanta iyo Xaquuqda Madaniga ah (OEER) ee WSDOT. Si aad u hesho xog dheeraad ah oo ku saabsan hanaannada cabashada Title VI iyo/ama xogta la xariirta waajibbaadkeena ka caagan takoorka, fadlan la xariir Iskuduwaha Title VI ee OEER oo aad ka wacayso (360) 705-7090.

### Macluumaadka Xeerka Naafada Marykanka (ADA)

Agabkaan ayaad ku heli kartaa qaab kale adoo iimeel u diraa Xafiiska Sinaanta iyo Xaquuqda Madaniga ah oo aad ka helayso [wsdotada@wsdot.wa.gov](mailto:wsdotada@wsdot.wa.gov) ama adoo wacaaya laynka bilaashka ah, 855-362-4ADA(4232). Dadka naafada maqalka ama maqalku ku adag yahay waxay ku codsan karaan wicitaanka Adeega Gudbinta Gobolka Washington 711.

If you have difficulty understanding English, you may, free of charge, request language assistance services by calling 360-705-7050 or email us at: [ITDSerivceDesk@wsdot.wa.gov](mailto:ITDSerivceDesk@wsdot.wa.gov)

---

## ESPAÑOL – SPANISH

### Servicios de traducción

Aviso a personas con dominio limitado del idioma inglés: Si usted tiene alguna dificultad en entender el idioma inglés, puede, sin costo alguno, solicitar asistencia lingüística con respecto a esta información llamando al 360-705-7050, o envíe un mensaje de correo electrónico a: [ITDSerivceDesk@wsdot.wa.gov](mailto:ITDSerivceDesk@wsdot.wa.gov)

---

## 한국어 – KOREAN

### 번역 서비스

영어로 소통하는 것이 불편하시다면 360-705-7050, 으로 전화하시거나 다음 이메일로 연락하셔서 무료 언어 지원 서비스를 요청하실 수 있습니다: [ITDSerivceDesk@wsdot.wa.gov](mailto:ITDSerivceDesk@wsdot.wa.gov)

---

## русский – RUSSIAN

### Услуги перевода

Если вам трудно понимать английский язык, вы можете запросить бесплатные языковые услуги, позвонив по телефону 360-705-7050, или написав нам на электронную почту: [ITDSerivceDesk@wsdot.wa.gov](mailto:ITDSerivceDesk@wsdot.wa.gov)

---

## tiếng Việt – VIETNAMESE

### các dịch vụ dịch thuật

Nếu quý vị không hiểu tiếng Anh, quý vị có thể yêu cầu dịch vụ trợ giúp ngôn ngữ, miễn phí, bằng cách gọi số 360-705-7050, hoặc email cho chúng tôi tại: [ITDSerivceDesk@wsdot.wa.gov](mailto:ITDSerivceDesk@wsdot.wa.gov)

---

## العَرَبِيَّةُ – ARABIC

### خدمات الترجمة

إذا كنت تجد صعوبة في فهم اللغة الإنجليزية، فيمكنك مجاناً طلب خدمات المساعدة اللغوية عن طريق الاتصال بالرقم 360-705-7050 أو مراسلتنا عبر البريد الإلكتروني : [ITDSerivceDesk@wsdot.wa.gov](mailto:ITDSerivceDesk@wsdot.wa.gov)

---

## 中文 – CHINESE

### 翻译服务

如果您难以理解英文，则请致电：360-705-7050，或给我们发送电子邮件：[ITDSerivceDesk@wsdot.wa.gov](mailto:ITDSerivceDesk@wsdot.wa.gov)，请求获取免费语言援助服务。

---

## Af-soomaaliga – SOMALI

### Adeegyada Turjumaada

Haddii ay kugu adag tahay inaad fahamtid Ingiriisida, waxaad, bilaash, ku codsan kartaa adeegyada caawimada luuqada adoo wacaaya

# Foreword

---

This manual is provided for our construction engineering personnel as instruction for fulfilling the objectives, procedures, and methods for construction administration of Washington State transportation projects. This manual contains two kinds of instructions depending on the subject matter and the nature of the work. In one case, where the activity is the inspection of contract work that is critical from a structural or operational viewpoint, the instructions prescribe detailed methods and procedures, or detailed performance measures, designed to assure the objective of a safe and adequate finished product. In other cases, typically in the areas of documentation and payment, the instructions are limited to describing the necessary objectives of the work without specifying the methods or procedures. The *Construction Manual* is intended as a reference book that is consistent with the language and intent of the *Standard Specifications*. In order to use this reference effectively, it is essential that the user has a thorough understanding of the contract, contract plans, contract provisions, and the *Standard Specifications*, as well as this manual.

Where specific methods and procedures are not included, the intent of this manual is to provide the project staff with a statement of the outcomes required and to allow the Region Construction Management and the Project Engineer to devise procedures accordingly. This manual provides basic instruction for identifying policies or laws that affect the construction administration work, however, the manual generally does not interpret these policies or laws. Compliance with policies, laws, and regulations is the duty of the Project Engineer, who may call on others, especially those authorized to enforce laws and regulations, at any time for assistance. In order to respond to the many situations that may arise on different contracts with different types of work, the instruction provided by this manual is general in character and is not to be construed as replacing, modifying, or superseding any of the provisions of the contract, contract plans, contract provisions, or *Standard Specifications*.

Decisions to deviate from the instruction provided in this manual must be based on engineering judgment and supportable as representing the best interests of the public and are to be made by the individual with appropriate authority.

Comments about the manual are always welcome and will be considered in future updates.

---

**Robert E. Christopher III, P.E.**  
Director of Construction Division  
State Construction Engineer

# Contents

---

<b>Chapter 1</b>	<b>Administration</b>	<b>1-1</b>
1-00	Agency Organization and Relations with Other Organizations	1-1
GEN 1-00.1	Purpose and Scope of Manual	1-1
GEN 1-00.2	Definition of Terms	1-1
GEN 1-00.3	WSDOT State Construction Office	1-1
GEN 1-00.4	Region Organization	1-5
GEN 1-00.5	Relationship with Other Agencies	1-10
GEN 1-00.6	Relating to the Public	1-12
GEN 1-00.7	Application of Contract Provisions, Plans, and Specifications	1-12
GEN 1-00.8	Emergency Work Performed Under the Contract	1-14
GEN 1-00.9	Prime Contractors Performance Report	1-14
GEN 1-00.10	Stewardship	1-15
GEN 1-00.11	Bridge and Structures Office Support on Design-Bid-Build Projects During Construction	1-18
1-02	Bid Procedures and Conditions	1-19
SS 1-02.2	Plans and Specifications	1-19
SS 1-02.4	Examination of Plans, Specifications, and Site of Work	1-20
1-03	Award and Execution of Contract	1-20
SS 1-03.2	Award of Contract	1-20
SS 1-03.3	Execution of Contract	1-21
1-04	Scope of the Work	1-21
SS 1-04.3	Reference Information	1-21
SS 1-04.4	Changes	1-21
SS 1-04.5	Procedure, Protest and Dispute by the Contractor	1-35
SS 1-04.6	Variation in Estimated Quantities	1-37
SS 1-04.7	Differing Site Conditions (Changed Conditions)	1-41
1-05	Control of Work	1-41
SS 1-05.1	Authority of the Engineer	1-41
SS 1-05.3	Plans and Working Drawings	1-52
SS 1-05.4	Conformity with and Deviations from Plans and Stakes	1-58
SS 1-05.7	Removal of Defective and Unauthorized Work	1-60
SS 1-05.9	Equipment	1-63
SS 1-05.10	Guarantees	1-63
SS 1-05.14	Cooperation with Other Contractors	1-64
1-06	Control of Material	1-64
SS 1-06.3	Manufacturer's Certificate of Compliance	1-64
SS 1-06.6	Recycled Materials	1-65

1-07	Legal Relations and Responsibilities to the Public.....	1-66
	SS 1-07.1 Laws to be Observed .....	1-66
	SS 1-07.3 Fire Prevention and Merchantable Timber Requirements .....	1-71
	SS 1-07.4 Sanitation .....	1-72
	SS 1-07.5 Environmental Regulations .....	1-73
	SS 1-07.9 Wages .....	1-78
	SS 1-07.11 Requirements for Nondiscrimination.....	1-91
	SS 1-07.12 Federal Agency Inspection.....	1-105
	SS 1-07.13 Contractor’s Responsibility for Work.....	1-107
	SS 1-07.14 Responsibility for Damage.....	1-109
	SS 1-07.15 Temporary Water Pollution Prevention.....	1-109
	SS 1-07.16 Protection and Restoration of Property.....	1-110
	SS 1-07.17 Utilities and Similar Facilities.....	1-113
	SS 1-07.18 Public Liability and Property Damage Insurance .....	1-115
	SS 1-07.23 Public Convenience and Safety.....	1-116
1-08	Prosecution and Progress .....	1-121
	SS 1-08.1 Subcontracting.....	1-121
	SS 1-08.3 Progress Schedules.....	1-123
	SS 1-08.4 Prosecution of Work.....	1-128
	SS 1-08.5 Time for Completion.....	1-128
	SS 1-08.6 Suspension of Work .....	1-132
	SS 1-08.8 Extensions of Time .....	1-133
	SS 1-08.9 Liquidated Damages .....	1-134
	SS 1-08.10 Termination of Contract.....	1-137
1-09	Measurement and Payment .....	1-138
	SS 1-09.4 Equitable Adjustment.....	1-138
	SS 1-09.6 Force Account .....	1-140
	SS 1-09.8 Payment for Material on Hand .....	1-150
	SS 1-09.9 Payments .....	1-151
	SS 1-09.10 Payment for Surplus Processed Materials.....	1-164
	SS 1-09.12 Audits .....	1-166
1-10	Temporary Traffic Control .....	1-169
	SS 1-10.1 General .....	1-169
	SS 1-10.2 Traffic Control Management.....	1-171
	SS 1-10.3 Traffic Control Labor, Procedures, and Devices.....	1-175
	SS 1-10.4 Measurement.....	1-178
	SS 1-10.5 Payment .....	1-180

<b>Chapter 2</b>	<b>Earthwork</b>	<b>2-1</b>
2-01	Clearing, Grubbing, and Roadside Cleanup	2-1
	SS 2-01.3 Construction Requirements	2-1
	SS 2-01.4 Measurement	2-2
2-02	Removal of Structures and Obstructions	2-2
	GEN 2-02.3 General Instructions	2-2
	SS 2-02.3 Construction Requirements	2-3
2-03	Roadway Excavation and Embankment	2-3
	SS 2-03.1 Description	2-4
	SS 2-03.3 Construction Requirements	2-5
	GEN 2-03.4/5 Measurement and Payment	2-17
2-04	Haul	2-17
	SS 2-04.4 Measurement	2-17
2-06	Subgrade Preparation	2-18
	SS 2-06.3 Construction Requirements	2-18
2-07	Watering	2-19
	SS 2-7.3 Construction Requirements	2-19
2-09	Structure Excavation	2-19
	SS 2-09.3 Construction Requirements	2-19
2-10	Ditch and Channel Excavation	2-23
	SS 2-10.3 Construction Requirements	2-23
2-11	Trimming and Cleanup	2-23
	SS 2-11.3 Construction Requirements	2-23
2-12	Construction Geotextile	2-24
	SS 2-12.3 Construction Requirements	2-24
<b>Chapter 3</b>	<b>Aggregate Production and Acceptance</b>	<b>3-1</b>
3-01	Production From Quarry and Pit Sites	3-1
	GEN 3-01.1 General Instructions	3-1
	GEN 3-01.2 Outline of Inspector's Duties	3-1
	SS 3-01.2 Material Sources, General Requirements	3-2
	SS 3-01.3 State Furnished Material Sources	3-4
	SS 3-01.4 Contractor Furnished Material Sources	3-4
	SS 3-01.5 Measurement	3-5
3-02	Stockpiling Aggregates	3-6
	SS 3-02.2 General Requirements	3-6
	SS 3-02.4 Measurement	3-7
3-03	Site Reclamation	3-7
	GEN 3-03.1 General	3-7
	SS 3-03.2 General Requirements	3-8
	SS 3-03.3 Reclamation Plans	3-8



<b>Chapter 4</b>	<b>Bases</b>	<b>4-1</b>
4-02	Gravel Base	4-1
	GEN 4-02.1    General Instructions	4-1
	SS 4-02.2    Construction Requirements	4-1
4-04	Ballast and Crushed Surfacing	4-1
	GEN 4-04.1    General Instructions	4-1
	GEN 4-04.2    Inspector’s Checklist	4-1
	SS 4-04.3    Construction Requirements	4-2
	SS 4-04.4    Measurement	4-5
<b>Chapter 5</b>	<b>Surface Treatments and Pavements</b>	<b>5-1</b>
5-01	Cement Concrete Pavement Rehabilitation	5-1
	SS 5-01.1    Description	5-1
	SS 5-01.3    Construction Requirements	5-1
5-02	Bituminous Surface Treatment	5-6
	GEN 5-02.1    General Instructions	5-6
	GEN 5-02.3    Inspection and Sampling of Materials	5-6
	GEN 5-02.4    Miscellaneous Inspection Duties	5-6
	GEN 5-02.5    Reports and Records	5-7
	SS 5-02.3    Construction Requirements	5-7
5-03	Crack and Joint Sealing	5-12
	GEN 5-03.1    General Instructions	5-12
5-04	Hot Mix Asphalt	5-13
	GEN 5-04.1    General Instructions	5-13
	SS 5-04.2    Materials	5-16
	GEN 5-04.2    Inspector Roles and Responsibilities	5-19
	GEN 5-04.3    Street Inspection	5-20
	GEN 5-04.4    How to...	5-24
	SS 5-04.3    Construction Requirements	5-25
5-05	Cement Concrete Pavement	5-39
	GEN 5-05.1    General Instructions	5-39
	GEN 5-05.2    Testing Equipment/Reports	5-40
	GEN 5-05.3    Checklists	5-40
	SS 5-05.3    Construction Requirements	5-43
	SS 5-05.5    Payment	5-52

<b>Chapter 6</b>	<b>Structures</b>	<b>6-1</b>
6-01	General Requirements for Structures	6-1
GEN 6-01.1	Bridge Construction De-Briefing Session	6-1
GEN 6-01.2	General Inspection Procedures	6-1
GEN 6-01.4	Safety Nets and Staging	6-2
SS 6-01.2	Foundations	6-2
SS 6-01.4	Appearance of Structures	6-2
SS 6-01.6	Load Restrictions on Bridges Under Construction	6-2
SS 6-01.9	Working Drawings	6-3
SS 6-01.12	Final Cleanup	6-4
SS 6-01.16	Repair of Defective Work	6-4
6-02	Concrete Structures	6-6
GEN 6-02.1	Use of Epoxy Resins	6-6
SS 6-02.3	Construction Requirements	6-7
SS 6-02.4/5	Measurement and Payment	6-37
6-03	Steel Structures	6-39
SS 6-03.4/5	Measurement and Payment	6-48
6-04	Timber Structures	6-48
SS 6-04.4/5	Measurement and Payment	6-49
6-05	Piling	6-49
GEN 6-05.1	Vibration Monitoring during Pile Driving	6-49
GEN 6-05.2	Pile Driving Records	6-49
SS 6-05.3	Construction Requirements	6-49
SS 6-05.4/5	Measurement and Payment	6-56
6-06	Bridge Railings	6-57
GEN 6-06.1	Railing Alignment	6-57
SS 6-06.4/5	Measurement and Payment	6-57
6-07	Painting	6-57
GEN 6-07.1	General	6-57
6-08	Bituminous Surfacing on Structure Decks	6-60
GEN 6-08.1	Description	6-60
SS 6-08.2	Materials	6-60
6-10	Concrete Barrier	6-63
SS 6-10.3	Construction Requirements	6-63
6-14	Geosynthetic Retaining Walls	6-65
GEN 6-14	Description	6-65
SS 6-14	Geosynthetic Retaining Walls	6-65
SS 6-14.3	Construction Requirements	6-66
SS 6-14.4	Measurement	6-66
6-19	Shafts	6-67
SS 6-19	Shafts	6-67
6-20	Buried Structures	6-68
6-20.1	Construction Requirements	6-68

<b>Chapter 7</b>	<b>Drainage Structures, Storm Sewers, Sanitary Sewers, Water Mains, and Conduits</b>	<b>7-1</b>
7-01	Drains	7-1
	GEN 7-01.1 Roadway Subdrainage	7-1
7-02	Culverts	7-2
	GEN 7-02.1 General Instructions	7-2
	GEN 7-02.2 Roadway Surface Drainage	7-3
	GEN 7-02.3 Design of Culverts	7-3
	SS 7-02.5 Payment	7-7
7-03	Vacant	7-7
7-04	Storm Sewers	7-7
	GEN 7-04.1 General Instructions	7-7
	SS 7-04.3 Construction Requirements	7-7
	SS 7-04.5 Payment	7-7
<b>Chapter 8</b>	<b>Miscellaneous Construction</b>	<b>8-1</b>
8-01	Erosion Control and Water Pollution Control	8-1
	GEN 8-01.1 Introduction	8-1
	GEN 8-01.2 References	8-2
	GEN 8-01.3 Definitions	8-2
8-02	Roadside Restoration	8-10
	GEN 8-02.1 General	8-10
	GEN 8-02.2 Landscape Terminology	8-10
	GEN 8-02.3 Reference Reading	8-14
	SS 8-02.2 Materials	8-14
	SS 8-02.3 Construction Requirements	8-14
	SS 8-02.5 Payment	8-28
8-03	Irrigation System	8-28
	GEN 8-03.1 General	8-28
	GEN 8-03.2 Inspection	8-29
	SS 8-03.2 Materials	8-29
	8-03.3 Construction Requirements	8-29
8-04	Curbs, Gutters, Spillways, and Inlets	8-32
	SS 8-04.3 Construction Requirements	8-32
8-11	Guardrail	8-32
	GEN 8-11.1 General Instructions	8-32
	SS 8-11.3 Construction Requirements	8-32
8-12	Chain Link Fence and Wire Fence	8-34
	SS 8-12.3 Construction Requirements	8-34
8-14	Cement Concrete Sidewalks	8-34
	SS 8-14.3 Construction Requirements	8-34

8-20	Illumination, Traffic Signal Systems, and Electrical .....	8-35
	GEN 8-20.1  General .....	8-35
	GEN 8-20.2  Inspection.....	8-35
	SS 8-20.2   Materials.....	8-36
	SS 8-20.3   Construction Requirements.....	8-38
	GEN 8-20.6B1 Conduit Plowing .....	8-42
	8-20.6D     Wire and Cable .....	8-43
8-21	Permanent Signing .....	8-46
	GEN 8-21.1  General .....	8-46
	SS 8-21.2   Materials.....	8-46
	SS 8-21.3   Construction Requirements.....	8-46
 <b>Chapter 9  Materials .....</b>		<b>9-1</b>
9-1	General.....	9-1
	9-1.1       PE Authority for Materials Approval and Acceptance .....	9-1
	9-1.2       Control of Materials .....	9-8
	9-1.3       Approval of Materials .....	9-14
	9-1.4       Acceptance Methods for Materials .....	9-22
	9-1.5       Field Verification of Materials .....	9-27
9-2	Materials Fabrication Inspection Office – Inspected Items Acceptance .....	9-27
	9-2.1       General .....	9-27
	9-2.2       Inspected Items, Stamps, and Tagging Identification.....	9-29
	9-2.3       Permanent Sign Inspection .....	9-34
	9-2.4       Pipe Acceptance Report.....	9-36
9-3	Guidelines for Job Site Control of Materials.....	9-36
	9-3.1       General .....	9-36
	9-3.2       Sample Types.....	9-36
	9-3.3       Test Numbering.....	9-37
	9-3.4       Point of Acceptance .....	9-38
	9-3.5       Basis for Acceptance.....	9-38
	9-3.6       Vacant .....	9-39
	9-3.7       Acceptance Sampling and Testing Frequency Guide.....	9-40
9-4	Specific Requirements for Each Material .....	9-43
	9-4.1       Portland Cement, Blended Hydraulic Cement, Rapid Hardening Hydraulic Cement, Fly Ash, and Other Cementitious Materials .....	9-45
	9-4.2       Bituminous Materials .....	9-46
	9-4.3       Pavement Marker Adhesive.....	9-47
	9-4.4       Concrete Aggregates .....	9-47
	9-4.5       Aggregates for Bituminous Surface Treatment, Ballast, Permeable Ballast, Crushed Surfacing Base and Top Course, Maintenance Rock, and Gravel Backfill for Foundations Class A .....	9-48
	9-4.6       Aggregates for Hot Mix Asphalt (HMA).....	9-49
	9-4.7       Hot Mix Asphalt (HMA) .....	9-49

9-4.8	Mineral Filler .....	9-50
9-4.9	Aggregate Materials for Walls (Gravel Borrow for Structural Earth Walls) ...	9-50
9-4.10	Miscellaneous Aggregates: Gravel Base, Gravel Backfill for Foundation Class B, Gravel Backfill for Wall, Gravel Backfill for Pipe Zone Bedding, Gravel Backfill for Drains, Gravel Backfill for Drywells, Backfill for Sand Drains, Sand Drainage Blanket, Gravel Borrow, Select Borrow, Common Borrow, Native Materials for Trench Backfill, Foundation Material Class A, B, and C, and Bank Run Gravel for Trench Backfill.....	9-51
9-4.11	Recycled Materials .....	9-52
9-4.12	Premolded Joint Filler for Expansion Joints .....	9-54
9-4.13	Elastomeric Expansion Joint Seals .....	9-55
9-4.14	Poured Rubber Joint Sealer – Two Component .....	9-55
9-4.15	Hot Poured Joint Sealants .....	9-56
9-4.16	Concrete Drain, Perforated Underdrain, Culvert, and Storm Sewer Pipe ....	9-56
9-4.17	Corrugated Galvanized Steel, Aluminized Steel, Aluminum: Drain, Perforated Underdrain, Culvert Pipe Arch, and Storm Sewer Pipe.....	9-57
9-4.18	Polyvinyl Chloride (PVC) and Corrugated Polyethylene (PE) Drain, Perforated Underdrain, Culvert, and Storm Sewer Pipe.....	9-58
9-4.19	Structural Plate Pipes, Arches, and Boxes.....	9-59
9-4.20	Steel, Gray-Iron, and Ductile-Iron Castings: Manhole Rings and Covers; Metal Frame, Grate, and Solid Metal Cover for Catch Basins or Inlets; Cast Metal Inlets; Frame (Ring), Grate, and Cover for Drywells .....	9-59
9-4.21	Sanitary Sewers.....	9-60
9-4.22	Structural Steel for Bridges .....	9-61
9-4.23	Unfinished Bolts (Ordinary Machine Bolts), Nuts, and Washers .....	9-62
9-4.24	High Strength Bolts, Nuts, and Washers.....	9-62
9-4.25	Anchor Bolts, Rods, Nuts, and Washers .....	9-63
9-4.26	Reinforcing Bars for Concrete (Uncoated and Epoxy Coated Rebar) .....	9-64
9-4.27	Vacant .....	9-65
9-4.28	Mechanical Splices .....	9-65
9-4.29	Rebar Chairs, Mortar Blocks (Dobies), and Spacers .....	9-66
9-4.30	Dowels and Tie Bars for Concrete Pavement.....	9-67
9-4.31	Welded Wire Reinforcement for Concrete .....	9-68
9-4.32	Bridge Approach Slab Anchors .....	9-69
9-4.33	Prestressing/Post Tensioning Reinforcement – Strand.....	9-69
9-4.34	Prestressing/Post Tensioning Reinforcement – Bar.....	9-70
9-4.35	Painting, Paints, Coating, and Related Materials .....	9-70
9-4.36	Timber and Lumber.....	9-73
9-4.37	Vacant .....	9-74
9-4.38	Piling – All Types .....	9-74
9-4.39	Vacant .....	9-75
9-4.40	Precast Concrete Manholes, Catch Basins, Inlets, <b>and</b> Drywells.....	9-76
9-4.41	<b>Adjustment Sections for Drainage Structures</b> .....	9-76
9-4.42	Riprap, Rock for Erosion and Scour Protection, Quarry Spalls, Rock for Rock Wall and Chinking Material, Backfill for Rock Wall, and Stone for Gabions ..	9-77

9-4.43	Semi-Open Slope Protection . . . . .	9-78
9-4.44	Plant Material. . . . .	9-78
9-4.45	Topsoil. . . . .	9-79
9-4.46	Seed. . . . .	9-80
9-4.47	Fertilizer . . . . .	9-81
9-4.48	Mulch . . . . .	9-82
9-4.49	Irrigation System . . . . .	9-84
9-4.50	Fencing and Gates. . . . .	9-85
9-4.51	Beam Guardrail, Guardrail Anchors, and Guardrail Terminals . . . . .	9-86
9-4.52	Guardrail Posts and Blocks . . . . .	9-88
9-4.53	Miscellaneous Precast Concrete Products (Block Traffic Curb, Precast Traffic Curb) . . . . .	9-89
9-4.54	Prestressed Concrete Girders . . . . .	9-89
9-4.55	Pavement Marking Materials. . . . .	9-90
9-4.56	Signing Materials, Mounting Hardware, Posts, Sign Supports and Digital Printing System – Reflective Sheeting with its Integrated Engineered Matched Component System: Ink, Clear Overlay Film and Digital Printer and Sign Fabricator . . . . .	9-90
9-4.57	Liquid Concrete Curing Compound . . . . .	9-93
9-4.58	Admixtures for Concrete . . . . .	9-94
9-4.59	Plastic Waterstop . . . . .	9-94
9-4.60	Epoxy Systems. . . . .	9-94
9-4.61	Resin Bonded Anchors . . . . .	9-96
9-4.62	Gabion Cribbing, Hardware, and Stone . . . . .	9-96
9-4.63	Steel Sign Structures – Cantilever, Sign Bridge, Bridge Mounted, Roadside. . . . .	9-97
9-4.64	Conduit . . . . .	9-98
9-4.65	Fiber Optic Cable, Electrical Conductors, and Cable. . . . .	9-99
9-4.66	Steel Poles – ITS, Pedestrian, Light, Signal Standards, and High Mast Light Poles . . . . .	9-99
9-4.67	Vacant . . . . .	9-101
9-4.68	Luminaires, Lamps, and Light Emitting Diodes (LED) . . . . .	9-101
9-4.69	Water Distribution System . . . . .	9-101
9-4.70	Elastomeric Pads . . . . .	9-102
9-4.71	Bridge Bearings – Cylindrical, Disc, Fabric Pad, Pin, Spherical. . . . .	9-103
9-4.72	Precast Concrete Barrier . . . . .	9-104
9-4.73	Vacant . . . . .	9-105
9-4.74	Metal Bridge Rail. . . . .	9-105
9-4.75	Construction Geosynthetics (Geotextiles and Geogrids) . . . . .	9-106
9-4.76	Concrete . . . . .	9-107
9-4.77	Water for Concrete. . . . .	9-108
9-4.78	Expansion Joints . . . . .	9-108
9-4.79	Traffic Signal Controller Assembly . . . . .	9-109
9-4.80	Erosion Control Devices. . . . .	9-110
9-4.81	Concrete Patching Material, Grout and Mortar . . . . .	9-111
9-4.82	Streambed Aggregates . . . . .	9-113

9-4.83	Temporary Traffic Control Materials. . . . .	9-113
9-4.84	Modular Expansion Joint . . . . .	9-115
9-4.85	Junction Boxes, Cable Vaults, and Pull Boxes. . . . .	9-115
9-4.86	Precast Bridge Deck Panels, Floor Panels, Marine Pier Deck Panels, Noise Barrier Walls, Pier Caps, Retaining Walls, Roof Panels, Structural Earth Walls, Wall Panels, and Wall Stem Panels . . . . .	9-117
9-4.87	Concrete Three Sided Structures, Box Culverts and Split Box Culverts. . . . .	9-118
9-4.88	Precast Concrete Vaults (Utility, Drainage, etc.). . . . .	9-118
9-4.89	Fabricated/Welded Miscellaneous Metal Drainage Items: Grate Inlets and Drop Inlets . . . . .	9-119
9-4.90	Miscellaneous Steel Structures (Cattle Guards, Handrail, Guardrail Posts with Welded Base Plate, Seismic Retrofit Earthquake Restrainers, Column Jackets). . . . .	9-120
9-4.91	Miscellaneous Welded Structural Steel . . . . .	9-120
9-4.92	Wood Bridges . . . . .	9-121
9-4.93	Electrical Service Cabinets. . . . .	9-121
9-4.94	Monument Case, Cover, and Riser . . . . .	9-122
9-4.95	Steel Bollards . . . . .	9-122
9-4.96	Metal Trash Racks, Debris Cages, and Safety Bars for Culvert Pipe and Other Drainage Items. . . . .	9-123
9-4.97	Flow Restrictors and Oil Separators. . . . .	9-123
9-4.98	Concrete Blocks . . . . .	9-124
9-4.99	Vacant . . . . .	9-124
9-4.100	Intelligent Transportation Systems (ITS)/System Operations Management (SOM) Materials. . . . .	9-125
9-4.101	Media Filter Drain Mix . . . . .	9-128
9-5	Quality Assurance Program. . . . .	9-129
9-5.1	General . . . . .	9-129
9-5.2	Quality Assurance Program Structure and Responsibilities . . . . .	9-130
9-5.3	WAQTC Testing Technician Qualification Program . . . . .	9-132
9-5.4	Method Qualified Tester Program . . . . .	9-132
9-5.5	Calibration/Standardization/Check of Equipment. . . . .	9-134
9-5.6	Qualified Laboratories . . . . .	9-134
9-5.7	Independent Assurance Program (IAP) . . . . .	9-135
9-6	Radioactive Testing Devices . . . . .	9-138
9-6.1	Administration and Safety . . . . .	9-138
9-6.2	Radiation Administration Officer (Region Materials Engineer) . . . . .	9-140
9-6.3	Radiation Safety Officer. . . . .	9-140
9-6.4	Authorized Operators. . . . .	9-140
9-6.5	Authorized Transporters. . . . .	9-140
9-7	Field Operating Procedures and other Related Test Methods. . . . .	9-140

<b>Chapter 10</b>	<b>Documentation</b>	<b>10-1</b>
10-1	General	10-1
10-1.1	Introduction	10-1
10-1.2	Requirements for Notes	10-2
10-1.3	Source Documents	10-2
10-2	Measurement of Items of Work	10-3
10-2.1	General	10-3
10-2.2	Items Measured by Weight	10-6
10-2.3	Items Measured by Volume	10-7
10-2.4	Items Measured by Hour/Day	10-9
10-2.5	Items Measured by Lump Sum	10-9
10-2.6	Items Measured by Other Units	10-9
10-2.7	Items Bid at “No Charge”	10-10
10-3	Final Records for Projects Constructed by Contract	10-10
10-3.1	Records	10-10
10-3.2	Final Record Book No. 1	10-13
10-3.3	Construction Project Diaries - Final Records Book No. 2	10-14
10-3.4	Inspector’s Daily Report - Final Records Book No. 3	10-14
10-3.5	Traffic Control Reports - Final Records Book No. 4	10-16
10-3.6	Pile Driving Records - Final Records Book No. 5	10-16
10-3.7	Post Tensioning Records - Final Records Book No. 6	10-17
10-3.8	Contamination Material Records - Final Records Book No. 7	10-17
10-3.9	Miscellaneous Records - Final Records Book No. 8	10-17
10-3.10	As-Built Plans and Shop Drawings	10-17
10-3.12	Final Record Field Notebooks	10-20
10-3.13	Electronically Produced Documents	10-21
10-3.14	Photographs	10-21
10-3.15	Pre-Estimate Reports	10-22
10-3.16	Estimate Reports	10-22
10-3.17	Final DBE Utilization Plan Report	10-22
10-4	Project Ledger System	10-22
10-4.1	General	10-22
10-4.2	Source Documents	10-23
10-4.3	Source Document Filing Systems	10-24
10-5	Region Project Documentation Reviews	10-25
10-5.1	General	10-25
10-5.2	Review Procedures for Final Estimates and Final Records	10-26
<b>Chapter 11</b>	<b>Forms</b>	<b>11-1</b>
11-1	Introduction	11-1
11-2	Definitions	11-1
11-3	General Instructions	11-1
11-3A	Numerical Listing of Forms	11-4



## 1-00 Agency Organization and Relations with Other Organizations

### **GEN 1-00.1 Purpose and Scope of Manual**

This manual is published by the State Construction Office as a resource for construction engineering personnel. It provides instruction for administering Washington State transportation projects, recognizes established standards and describes accepted engineering practices. The instruction provided by this manual identifies desired results, establishes standardized requirements, and provides statewide uniformity in the administration and construction of transportation related contracts.

Chapters 1 through 8 of the *Construction Manual* are organized with two types of content. General information that isn't tied to any specific Section of the *Standard Specifications* is prefaced by "GEN" in the Section number. Information that is intended to complement and expand on sections of the *Standard Specifications* is prefaced by a "SS" in the section number. Not all sections of the *Standard Specifications* are addressed in the *Construction Manual*.

Construction engineering staff should be familiar with the guidance and instructions included in this manual. The guidance presented by this manual complements the requirements of the *Standard Specifications* and the Contract Provisions and promotes uniformity of results among all Regions of the Washington State Department of Transportation (WSDOT).

Suggestions for corrections, additions, or improvements to this manual and to the *Standard Specifications* or [General Special Provisions](#) are welcomed and should be submitted to the State Construction Office in the form of a Word document in "track changes" format.

### **GEN 1-00.2 Definition of Terms**

Definitions of words or terms should be the same as set forth under "Definitions and Terms" in [Standard Specifications](#) Section 1-01. If a conflict occurs between the guidance or instructions offered by this manual and the Specifications or provisions identified in the Contract, the latter will always prevail. Unless exclusively stated in the Request for Proposal documents of a Design Build Contract, any reference of the Project Engineer in this manual will mean the WSDOT Project Engineer.

### **GEN 1-00.3 WSDOT State Construction Office**

The State Construction Office strives for consistent, cost-effective, quality construction through direct support of WSDOT's Regional construction program. The State Construction Office coordinates the development of policies and standards, provides training, guidance, oversight, technical expertise and advocacy, introduces innovation, and coordinates and shares information on construction issues.

**GEN 1-00.3(1) State Construction Engineer**

The Director of the Construction Division is the State Construction Engineer and reports to the Assistant Secretary Multimodal Development and Delivery. The State Construction Engineer is responsible for all WSDOT contract construction projects, except those contracts executed by the Director of Washington State Ferries Division. The State Construction Engineer is responsible for all matters pertaining to contract administration and represents the Chief Engineer in managing the performance of these contracts. In addition, the State Construction Engineer acts for the Chief Engineer in approving increases or decreases of work, changes in the work or in materials incorporated into the work, authority to accomplish work by force account, extensions of time, and the assessment of any liquidated damages. The State Construction Engineer is responsible for providing guidance and direction to the Regions and State Construction Office personnel who are investigating construction claims and is responsible for the approval of all claim settlements. The State Construction Engineer establishes WSDOT policy relative to inspection and documentation and ensures uniform interpretation and enforcement of the *Standard Specifications* and Contract Provisions throughout the State. The State Construction Engineer is assisted by the Deputy State Construction Engineer, the Lead Construction Engineer, Administration, the Lead Construction Engineer, Projects, and the Assistant State Construction Engineers.

**GEN 1-00.3(1)A Deputy State Construction Engineer**

The Deputy State Construction Engineer reports to the State Construction Engineer. The Deputy State Construction Engineer is delegated the authority to execute documents concerning the following:

- Advertising, award, and execution of Contracts
- Federal Aid project documentation
- Contract change orders of a value not to exceed \$2 million and 60 days
- Extensions of time
- Reduction in pre-qualification
- Certification of materials to FHWA
- Claims on Contracts
- Final Acceptance

**GEN 1-00.3(1)B Lead Construction Engineer, Projects**

The Lead Construction Engineer, Projects represents the State Construction Engineer by formulating policy in the following areas:

- *Standard Specifications*
  - All Divisions except for Division 9
- *Construction Manual*
  - All Chapters except for Chapter 9

Additionally, the Lead Construction Engineer, Projects is the lead within the State Construction Office for Environmental Coordination.

The Lead Construction Engineer, Projects is delegated authority to execute contract documents concerning:

- Force account rates
- Interpretation of Contract Provisions
- Specification and Contract requirements
- Policy related to inspection and documentation
- Contract change orders of a value not to exceed one million dollars and/or changes in Contract time not to exceed 60 days

### **GEN 1-00.3(1)C Lead Construction Engineer, Administration**

The Lead Construction Engineer, Administration reports to the Deputy State Construction Engineer and represents the State Construction Engineer by formulating policy in the following areas:

- Design-Build Program
  - [Design-Build Manual](#) M 3126
  - Contract Template
- eConstruction
- Contract Advertisement and Award
- Organizational Conflict of Interest

The Lead Construction Engineer, Administration is delegated authority to execute contract documents concerning:

- Force account rates
- Interpretation of Contract Provisions
- Specification and Contract requirements
- Policy related to inspection and documentation
- Contract change orders of a value not to exceed one million dollars and/or changes in Contract time not to exceed 60 days

The Lead Construction Engineer, Administration, is assisted by:

- **Documentation Engineer** – Provides guidance for Contract documentation and Contract payments, as well as providing support to Region Documentation Engineers. The Documentation Engineer resolves issues of material documentation deficiencies for all Federal aid projects, is responsible to assist with prevailing wage issues, and is also responsible for evaluating Contracts for Acceptance. The Documentation Engineer may assist the State Materials Laboratory with Quality Audits on administrative documentation as well as audits performed by FHWA and the State Auditor's Office.
- **Construction Administration Specialist** – Is the CCIS System Manager/Administrator, the State Construction Office Liaison to Management Information Systems (MIS), supports the Region and Project Offices by providing guidance in the use of CCIS, and the IBM Cognos reporting tool used to report from the Construction Data Mart. This position oversees the maintenance of the *Construction Manual*, C30P and the Force Account Program. This position also maintains contact with the publishers of the Equipment Rental Rate Blue Book (Equipment Watch).

**GEN 1-00.3(1)D Assistant State Construction Engineers**

Assistant State Construction Engineers report to the Lead Construction Engineers or the Deputy State Construction Engineer and are assigned as the State Construction Office point of contact for specific Project Offices or Programs. Assistant State Construction Engineers also assist the Construction Engineers in the development of policy and are assigned responsibility for specific sections of the *Standard Specifications* and the *Construction Manual*.

Assistant State Construction Engineers are delegated the authority to execute:

- Contract Change Orders of a value not to exceed one million dollars and/or changes in contract time not to exceed 60 days

**GEN 1-00.3(2) State Materials Laboratory**

The State Materials Engineer reports to the Director of the Construction Division and represents the Director of the Construction Division by directing the materials acceptance and quality assurance program used on WSDOT projects. The State Materials Engineer directs operating methods to be followed in providing soils and materials analysis and testing; furnishes counsel and technical assistance to the Regional Construction Managers in conducting required materials tests and analysis and provides for periodic review of these test methods and procedures to ensure their conformance to established policies, procedures, and methods.

The State Materials Engineer represents the Director of the Construction Division by formulating policy in the following areas:

- *Standard Specifications*
  - Division 9 Materials
- *Construction Manual*
  - Chapter 9 Materials
- *Materials Manual*
  - All Sections
- Design Build Request for Proposal
  - Section 2.25 and 2.28

The State Materials Engineer is delegated the authority to execute documents concerning:

- Reports on soil and test results
- Approving material sources
- Approving material for the Qualified Products List and New Products List
- Establishing policy related to construction inspection, materials testing and documentation
- Interpretation and meaning of Contract Provisions
- Construction Quality Audits

The State Materials Engineer is assisted by a staff of professional engineers, administrative personnel, engineers and technicians.

**GEN 1-00.3(2)B State Pavements Engineer**

The State Pavements Engineer reports to the Director of the Construction Division by directing the pavement design and pavement management sections. The State Pavement Engineer establishes statewide pavement policy and provides technical support for pavement design and construction. The State Pavement Engineer approves design changes and material substitutions for pavement design related changes.

The State Pavement Engineer is assisted by a staff of professional engineers, administrative personnel engineers and technicians.

**GEN 1-00.3(2)C State Geotechnical Engineer**

The State Geotechnical Engineer reports to the Director of the Construction Division, and represents the Director of the Construction Division by formulating and implementing geotechnical design and construction policy, primarily through the [Geotechnical Design Manual](#), but also through Standard Plans, General Special Provisions, and portions of the *Standard Specifications*. The State Geotechnical Engineer or his representatives, develop, and/or review and approve, the following types of documents:

- Summary of Geotechnical Conditions
- Boring logs and associated geotechnical test data
- Blasting plan submittals
- Geotechnical aspects of shoring and excavation submittals
- Other geotechnical construction submittals
- For design-build projects, portions of the RFP (primarily Section 2.6), geotechnical base-line reports, geotechnical data reports, and related geotechnical reports

The State Geotechnical Engineer, or his representatives, develop and/or approve geotechnical reports that provide the design basis for construction projects statewide. The State Geotechnical Engineer, or his representatives, provide geotechnical expertise and support for evaluation of construction and changed condition claims to Region Construction Managers and the State Construction Office staff.

**GEN 1-00.4 Region Organization****GEN 1-00.4(1) Regional Administrator**

The Regional Administrator, or those delegated Regional Administrator authority, represents the Assistant Secretary in a geographic area, organizes and supervises a staff of personnel which perform administrative duties and supervise location, design, construction administration, and maintenance of the transportation system within the region.

The Regional Administrator is delegated the authority to execute:

- Change orders as Specified in *Construction Manual* [SS 1-04.4](#), Delegation of Execution Authority
- Approval of subcontractors and agents

**GEN 1-00.4(2) Regional Construction Manager**

In supervision of construction, the Regional Administrator is assisted by a Regional Construction Manager. The Regional Construction Manager, or those delegated Regional Construction Manager authority, assigns Project Engineers with appropriate supporting personnel and provides training and guidance to the Project Engineers. It is the responsibility of the Regional Construction Manager to ensure that sufficient qualified personnel are provided on all projects at all times to ensure adequate inspection, documentation, materials testing and quality assurance program controls.

**GEN 1-00.4(3) Regional Administration of the Inspector Certification Program**

**Goal** – The purpose of the Inspector Certification Program is to provide training and resources for Construction Inspectors and to provide examinations to confirm the Inspector’s knowledge. This will ensure consistent administration of highway construction contracts. The monitoring of construction activities by Certified Inspectors will help to ensure that only quality materials and workmanship are employed on WSDOT construction projects.

**Definitions**

**Director of the Construction Division (Director)** – Individual delegated authority from the Secretary of Transportation to administer the Department’s Construction Program.

**Region Inspector Certification Manager (RICM)** – Individual designated by the Director of the Construction Division to coordinate all construction training and Inspector Certification in that Region.

**Region Inspector Certification Official (RICO)** – Appointing authority for Region Construction Project Engineers or an individual delegated this responsibility by the appointing authority.

**Department** – Washington State Department of Transportation.

There are two types of Inspectors, Interim Inspectors and those enrolled in the Inspector Certification Program (ICP). There are two different levels of certification, General and Divisional.

An Interim Inspector is a person assigned to work under the supervision of a WSDOT Certified Inspector. This person may be a temporary employee, seasonal employee or permanent employee within the Department. Interim Inspectors should be considered for inclusion within the Inspector Certification Program. Interim Inspectors at the Transportation Technician 3 In-Training level and above may only serve as Interim Inspectors for six months before being required to obtain certification as a General Inspector.

An Inspector is entered into the ICP through the Washington State Learning Center (LC). The employee’s supervisor will contact their Region Trainer who will assign the certification tests via the LC.

The Inspector will become certified as a General Inspector once they have successfully demonstrated proficiency by achieving a passing score of 75 percent on each open book examination for the following subjects:

- Technical Mathematics
- Contract Plans Reading
- Basic Surveying

- Composing an Inspector's Daily Report
- Force Account Documentation and Payment
- Materials Documentation
- Inspector's Role for Change Order Work
- Inspector Safety
- Utilizing Resources
- Environmental
- Work Zone Traffic Control

The Inspector may either take the courses first and then take the examination or take the examination without taking the course. If the Inspector does not achieve a passing score on an examination, they may retake that examination after waiting three days. If they fail an examination a second time, the Inspector will be required to successfully complete training before attempting another examination for that subject matter. Certification as a General Inspector shall not expire. The General Inspector may be required to successfully complete additional courses to maintain their General Inspector certification should the Department change its work methods or standards, pertaining to the subject matter covered in the General Inspector Certification.

The purpose of the General Inspector Certification phase is to broaden the Construction Inspectors' knowledge base through additional instruction and inspection experience.

### Division Certificates

The next phase of the Inspector Certification Program includes modules for Division Certifications as shown below. Once the Inspector becomes a Certified General Inspector, they will be eligible for training and certification focus in at least one of the following Divisions as they become available. A Division Certification will include modules of training and exams for a particular item of work.

<b>Division 2</b> Earthwork	<b>Division 6</b> Structures Cast-in-Place Concrete Foundations	<b>Division 7</b> Drainage
<b>Division 5</b> Hot Mix Asphalt Placement Cement Concrete Pavement	Concrete Bridges Structural Earth Walls Tieback Walls Concrete Walls	<b>Division 8</b> Guardrail Signing Illumination, Signals, Electrical & ITS

The Certified General Inspector will be certified in the Divisions listed above when they have successfully demonstrated proficiency by achieving a passing score of 80 percent on the examinations. After completion of the stated requirements, the individual will be granted the title of Certified Inspector in that Division. At this level, the Inspector would be expected to operate independently with limited supervision in that Division.

Each year, the Construction Project Engineers will ensure that Inspectors assigned to them are afforded the opportunity to take additional courses to broaden their knowledge and certifications.

All Division certification requirements may be completed by either successful completion of the required training courses and then passing the examinations or the examinations may be taken without completing the training courses. If an exam is failed the RICM will notify the Project Engineer. The Inspector must take an on-line or Instructor Led course

for the affected subject prior to re-taking the exam. The exam may be retaken with a minimum of a three-day waiting period from the date the original test was failed.

If an exam is failed for a second time, the RICM will notify the Project Engineer and RICO. The Project Engineer and RICO will develop an action plan for training and mentoring on the subject. A period of 30 days minimum is required for the action plan to be completed, and then the Project Engineer will notify the RICM the Inspector is ready to retake the examination.

An Inspector's Division certification will be valid for a period of 4 years from the date of certification, after which they will be required to complete a recertification course and/or examination.

### **Certification Revocation Based on Lack of Proficiency**

If it is determined that a Certified Inspector has demonstrated a lack of proficiency, the RICO will work with the inspector's Project Engineer to develop an action plan to correct the lack of proficiency. The action plan will include successfully completing course work identified and achieving a passing score on course examinations. If the inspector fails to successfully complete the action plan, the RICO will revoke the Inspector's Certification and inform the Director of the Construction Division.

The RICM will maintain a database of all certified Inspectors, in what areas they are certified, and any who have had their certification revoked.

The RICO will initiate notification that a certification has been revoked. Notification shall be in writing and shall be mailed ("return receipt requested") to the affected Inspector. A copy of the notification shall be sent to the employee's supervisor.

Prior to having the certification reinstated, the inspector must meet all requirements stated in their revocation letter and pass any applicable proficiency examination(s).

### **Reporting**

Once each year the RICM will report actions taken under the Inspector Certification Program. The report shall include as a minimum the number of certified inspectors, the Inspector's names, what certifications they hold, and any certification revocations, taken under the Inspector Certification Program. The report will be due to the Director by the last working day in January.

### **GEN 1-00.4(5) Regional Administration of the Quality Assurance Program**

**Goal** – The purpose of the WSDOT Quality Assurance Program (QAP) is to ensure that materials incorporated into any highway construction project are in conformity with the approved plans and specifications, including any approved changes. This program also conforms to the criteria in the FHWA regulation for Quality Assurance Procedures for Construction (23 CFR 637). The requirements for the WSDOT QAP are detailed in Section 9-5 of this manual. The Regional Construction Manager is responsible for overall management of the Region QAP.

The Region QAP includes the following:

- WAQTC Testing Technician Qualification Program
- Method Qualified Tester Program
- Testing Equipment Calibration/Standardization/Check and Maintenance Program



- Qualified Laboratory Program
- Independent Assurance (IA) Program

The WSDOT QAP requires Western Alliance for Quality Transportation Construction (WAQTC) qualified testers, American Concrete Institute (ACI) qualified testers, method qualified testers, testing equipment calibrations/standardization/check and maintenance, qualified laboratories, and independent assurance to ensure consistent materials testing as well as ensure materials used on WSDOT contracts meet specification quality requirements.

The WAQTC Qualified Tester Program requires all personnel who perform acceptance testing of materials on WSDOT projects be WAQTC qualified in the test method they are performing. The WAQTC program certifies materials testers in testing aggregate, asphalt, concrete, in place density, embankment and base testing, and embankment and base in place density testing. Within the WAQTC program concrete testers are ACI certified testers. Materials Testers are required to pass both a written exam and a hands-on evaluation to become qualified and the qualification lasts 5 years unless revoked or suspended. The [WAQTC Registration Policies & Information Handbook](#) provides information on tester qualifications, certification renewals, as well as tester certification revocation or suspension processes. The requirements for tester qualifications are detailed in Section 9-5.3 of this manual.

The Method Qualified Tester Program is a tester qualification program for personnel who perform materials tests not included in a WAQTC tester certifications. Method qualified testers are required to pass both a written exam and a hands-on evaluation to become qualified and the qualification lasts 5 years. The WAQTC Registration Policies & Information Handbook provides information on method qualified tester qualifications, certification renewals, as well as tester certification revocation or suspension processes. The requirements for tester qualification are detailed in [Section 9-5.4](#) of this manual.

The Testing Equipment Calibration/Standardization/Check and Maintenance Program requires that all testing equipment used for testing be calibrated on a yearly basis, be standardized to ensure required correction factors are applied, checks are performed to ensure compliance with standards and regular maintenance performed to ensure testing equipment does not degrade and is able to produce repeatable tests results. Each year all laboratory equipment is required to be calibrated/standardized/checked as required by the test procedures, AASHTO R 18 or the WSDOT Verification Procedures. The requirements for the Calibration/Standardization/Check of Equipment are detailed in [Section 9-5.5](#) of this manual as well as the WSDOT Standardization and Check Procedures for Materials Testing Equipment (VP's) that are available online.

The Qualified Laboratory Program requires that all Region and Private testing laboratories, other than the State Materials Laboratory, which are AASHTO accredited, perform acceptance testing, dispute resolution testing or Independent Assurance testing for WSDOT construction projects be qualified by the State Materials Laboratory Quality Systems Section. The Quality Systems Section inspects the Region and Private testing laboratories for conformance with the requirements of WSDOT Standard Practice QC-3 to ensure testing laboratories can provide consistent repeatable test results. The requirements for the Laboratory qualification program are found in [Section 9-5.6](#) of this manual and WSDOT Standard Practice QC-3 is found in the WSDOT *Materials Manual* M 46-01.40.

The Independent Assurance (IA) Program requires that each active WAQTC Certified, or Method Qualified Tester will have an annual IA audit by a Region Independent Assurance Inspector (IAI). These audits include IAI observations, IAI split samples of materials and quality assurance and acceptance test result comparisons. Split samples test results from assurance and acceptance materials samples are compared for degree of conformance with reports sent to the Project Engineer and the Region IAI by the Region Materials Engineer (RME). The requirements for the Independent Assurance Program are found in [Section 9-5.7](#) of this manual.

### Quality Assurance Program Reporting

The Regional Construction Manager will submit a Region annual Independent Assurance (IA) report to the Director of the Construction Division (Director) with an electronic copy sent to the State Materials Engineer. The region IA report will be submitted to the Director by the last working day in January. The region IA report will summarize the results of the previous calendar year and contain the following:

1. Number and percent of materials testers audited
2. The testers name, list of the tester certifications, date each tester was audited
3. If applicable, the reason the annual tester audit was not completed on a tester or testers; see [Section 9-5.7](#) Independent Assurance Program.
4. Any tester certification revocations
5. What, if any, problems occurred and why
6. A general statement as to how any problems that were reported were resolved

The State Materials Laboratory Quality Systems Section will compile the Region IA report information and submit the information to the FHWA per the requirements in [Section 9-5.7C](#) of this manual.

## **GEN 1-00.5 Relationship with Other Agencies**

### **GEN 1-00.5(1) Federal Highway Administration**

The Federal Government provides transportation funding to Washington State through the Federal Highway Administration (FHWA), a division of the U.S. Department of Transportation. These funds are subject to applicable Federal law, Executive Orders, regulations, and agreements.

The WSDOT contact with FHWA for Construction Administration matters is the State Construction Office. In preparing and approving *Standard Specifications*, General Special Provisions, and this manual, the State Construction Office seeks the review and approval of FHWA. Use of approved provisions and meeting the required outcomes described in the manual become the basis of federal reimbursement.

FHWA provides oversight of WSDOT work on some projects and has delegated that responsibility to WSDOT on others. A full discussion of WSDOT responsibilities under Stewardship is included in Section 1-00.10.

**GEN 1-00.5(2) Local Agencies**

Cities, counties, and other municipalities within the state may also perform work funded with federal dollars. When this happens, the money is passed through the Department of Transportation, and we will have entered into agreements with the local agencies to provide services. For example, WSDOT will allow the use of testing facilities by a local agency.

**GEN 1-00.5(2)A Project Engineer Administering Local Agency Project**

Occasionally, a WSDOT Project Engineer may be assigned to provide engineering and inspection services on a local agency project. The duties of the Project Engineer will be determined by the actual Contract Provisions and by any specific agreement made between the Region Administration and the local agency. The provisions of this manual may or may not apply, depending on the situation.

**GEN 1-00.5(2)B Local Agency Administering Its Project on State Right of Way**

In some cases, WSDOT may grant approval for a local agency to construct a facility on State Right of Way using local agency staff and contractors. (For example, a city funded overpass of an interstate). When this happens, a Project Engineer will be assigned to provide oversight of the local agency work. The Project Engineer is expected to assure that the local agency provides the same level of engineering and inspection that State employees would accomplish. While the Local Agency may have different administrative provisions with respect to risk-sharing and submittal requirements, all of the technical aspects of the *Standard Specifications* and this manual must be met.

**GEN 1-00.5(3) Other Federal, State, and Local Agencies**

The design and construction of transportation improvements often incorporates locations and features that fall within the jurisdiction of other agencies. It is the policy of WSDOT to cooperate with all agencies as partners in the completion of each project, recognizing and complying with each agency's legal requirements. The Project Engineer shall cooperate with local authorities to help ensure that the contractor complies with local laws, ordinances, and regulations. However, unless specifically allowed in the statutes or the contract documents, no WSDOT employee shall engage in any kind of enforcement of laws, rules, regulations, or ordinances which are the responsibility of other agencies. WSDOT needs to maintain the confidence and build trust with resource agencies and the public, so it is critical that we take the proper actions when we are aware of an issue. When WSDOT employees observe something which is questionable or appears to not be in compliance with local laws, ordinances, and regulations, it shall be brought to the Project Engineer's attention. The Project Engineer is responsible for bringing it to the Contractor's attention for proper action. Rely on the Regional and Headquarters expertise and the appropriate agencies when dealing with complex issues such as environmental compliance, safety, or hazardous materials.

**GEN 1-00.5(3)A Highways over National Forest Lands**

WSDOT has entered into a Memorandum of Understanding (MOU) with the United States Forest Service (USFS) and the Project Engineer is required to do the following when performing work on National Forest Service Lands:

1. Represent the department in all matters pertaining to the project.
2. Confirm that the USFS has been notified of the project advertisement and award.
3. Notify and obtain approval from the USFS for any changes in the project that will affect National Forest System Lands, beyond that of the original contract.
4. Notify the USFS when the project nears completion, at which time the USFS will indicate if they choose to participate in the final review of the project.

### **GEN 1-00.6 Relating to the Public**

Public confidence is enhanced by WSDOT personnel being responsive to reasonable requests for information, providing timely advanced notice of possible impacts, and reducing inconvenience to traffic while maintaining worker safety. When possible, the Project Engineer should rely on resources such as Regional Public Information Officers and the State Office of Communications and Public Involvement. If there is concern or reason to question the confidentiality or sensitivity of the information requested, consult with your supervisor or seek the advice of the Attorney General's office.

### **GEN 1-00.7 Application of Contract Provisions, Plans, and Specifications**

#### **GEN 1-00.7(1) Construction Contracts Information System (CCIS)**

The CCIS system is a mainframe application designed to track Contract information and generate reports for all WSDOT administered construction projects. The initial setup of Contract information into CCIS is done automatically by using information in CAPS and other systems. However, after the Contract has been executed, the Project Office must enter the majority of the Contract information into the CCIS system. The Project Engineer will verify that the initial Contract information in CCIS is correct. The data entered is then maintained and stored on the mainframe.

Among other things, CCIS generates and tracks the Weekly Statement of Working Days and Change Orders. The system creates the forms for these reports so a preprinted form is not needed. Following is a list of data that needs to be entered into the CCIS database over the life of the project:

1. **Contract Information** – This part of CCIS will contain general Contract information, including but not limited to:
  - Region administering Contract
  - Region the Contract is located in
  - Regional Administrator
  - Operations Engineer
  - Project Engineer/PE Org code
  - Description of Work
  - SR Number(s)
  - Begin and End mile post
  - County
  - Prime Contractor's local address, if applicable
  - Prime Contractor contact person
  - Prime Contractor DMWBE type if applicable
  - Prime Contractor ethnic code if applicable

- Date of Statement of Intent to Pay Wages – Prime
  - Date of Contractor and Subcontractor/Agent Cert. for F.A. Projects
  - Date of Affidavit of Wages Paid – Prime
  - Date of Preconstruction Meeting Minutes
  - Date time started
  - Date work started
  - Date Orig. Progress Schedule approved
  - Date Last Supplemental Progress Schedule approved if applicable
  - Date of Substantial Completion (if no Substantial Completion granted, use Physical Completion date)
  - Date of Physical Completion
  - Final Estimate to Contractor
  - Date of Completion
  - Final Estimate to State Construction Office (filled in by Region office)
  - Contract time – Original Authorized Working Days
2. **Contractor Information** – This part of CCIS tracks information about Request to Sublet and Affidavits of Amounts Paid.
    - Request to Sublet
    - Affidavit of Amounts Paid
  3. **ECR Tracking** – This part of CCIS tracks the Contractor’s training program, trainees, and MWDBE reviews.
    - Training Program
    - Apprentice/Trainee Approval Request
    - DMWBE and EEO reviews
  4. **Change Orders** – Change orders are created, printed, and tracked in this part of CCIS. It is very important to keep the information current to facilitate correct tracking and reporting.
    - Approval (to proceed when granted)
    - VECP Amount (if the change order is a VECP)
    - A brief description of the change order (if the change order is a VECP)
    - Date sent to Contractor
    - Date received from Contractor
    - Is there Surety consent
    - Date of Surety consent
    - Dates of approval and execution (**Note:** Line 4 “Date Executed” should only be used by Region or the State Construction Office)
    - Change Order Voided (if applicable)
  5. **Weekly Statement of Working Days** – The “Weekly Statement of Working Days” report is generated by CCIS, based on information entered into the system by the Project Office. This report details the number of workable/unworkable days charged to a project, the reason a day is charged as unworkable, daily weather codes, the current status of contract days, and a summary of the week’s construction activity. The Project Engineer must ensure that the appropriate information is entered into

CCIS on a weekly basis, a “Weekly Statement of Working Days” is generated, and the report is sent to the Contractor by 5:00 p.m. the following Thursday. Weekly statements shall cease when physical completion is granted, or when substantial completion is granted and all working days are expended.

Refer to the CCIS Users Guide for details on using the system. This guide is available on the [State Construction Office SharePoint](#) site in the Shared Documents folder.

### **GEN 1-00.7(2) Order Lists**

Contract language requiring an order list can be found in [Standard Specifications](#) Section 6-05.3(2), which addresses piling other than cast in place concrete and steel piles, and in Section 8-21.3, which addresses the determination of lengths of wood and steel sign posts. In other types of work, such as drainage, guardrail, etc., the actual layout will often result in quantities and lengths that vary from the plan estimates. A Project Engineer could choose to communicate this information in several ways, one of which could be the development of a formal order list. If an order list is used, extra care should be taken to ensure its accuracy. An alternate method of notice could also be a walk through with the contractor representative after staking.

### **GEN 1-00.8 Emergency Work Performed Under the Contract**

When a natural disaster impacting a wide area strikes, WSDOT may utilize an existing construction Contract in order to restore essential travel, minimize damage or protect remaining facilities. [RCW 47.28.170\(2\)](#) allows WSDOT to contract this work on a negotiated basis provided (a) the cost does not exceed force account rates for the work performed and (b) the Contract does not exceed thirty working days. There must be an emergency declaration by the appropriate authority, the Project Engineer must complete a DOT Form 300-001 Detailed Damage Inspection Report (DDIR) and the Project Engineer must contact the Regional Program Manager, since this work will initially be funded by state funds. The Project Engineer should follow the guidance provided in the WSDOT [Emergency Funding Manual](#) M 3014.

Emergency repair work, when performed by the Contractor under an existing Federal-Aid Contract, may be eligible for Emergency Relief funding. In order to qualify for Emergency Relief funding, the repair work must be the result of a natural disaster over a wide area, such as a flood, an unusually severe storm or a landslide. The work must be demonstrated to be beyond the Contractor’s responsibility and not work that has already been scheduled for repair or replacement of deficient structures. Only the work required to protect and open the roadway is eligible for Emergency Relief funding.

Adding emergency work to a State funded Contract would require the addition of all Federal-Aid specifications, and is not practicable. It is however acceptable to hire the existing Contractor to perform emergency work at the same location under a separate emergency force account Contract which would include all the Federal requirements.

### **GEN 1-00.9 Prime Contractors Performance Report**

The procedures for completing and submitting the Prime Contractors Performance Report are included with DOT Form 421-010 and in the [Prime Contractors Performance Report Manual](#) M 41-40. The requirement for this report and other direction can also be found in [WAC 468-16-150](#) and [WAC 468-16-160](#). Notify the Regional Construction Manager for assistance and advice if the Contractor’s performance on a project becomes below standard.

## **GEN 1-00.10 Stewardship**

Webster defines “steward” as “one who acts as a supervisor or administrator, as of finances and property, for another or others.” The designated steward of all federal highway funds is the United States Department of Transportation, acting through the Federal Highway Administration (FHWA). In Washington State, FHWA is represented by its Washington Division. Washington Division has delegated a portion of its stewardship responsibility (and the corresponding authority) to the Washington State Department of Transportation (WSDOT) through the Federal-Aid Highway Program Stewardship and Oversight Agreement, signed on March 3, 2015.

This Section describes further agreement between FHWA and WSDOT concerning the details of the part of the Stewardship Agreement and Construction Monitoring Plan that applies to construction. The subject matter of this subagreement is monitoring of construction performed on behalf of WSDOT by independent contractors.

**Scope of Construction Monitoring Plan** – Outlines expectations for federally-financed construction projects performed under Contract with WSDOT and administered through the WSDOT State Construction Office. It is not intended to be all-encompassing and does not include: WSDOT Ferries Division Contracts for construction of vessels and facilities; Contracts administered through Local Programs; Utility Agreements; and Emergency Relief work administered by WSDOT Maintenance.

**Project Responsibility** – FHWA Washington Division has delegated to WSDOT (and through the WSDOT delegation of authority to the State Construction Office) stewardship responsibility and authority for all federally-funded construction unless a project specific action (1) requires FHWA approval as defined in Attachment A of the Stewardship and Oversight Agreement or (2) the FHWA Division has retained approval as documented in an executed project specific Project of Division Interest (PoDI) plan.

The State Construction Office has further delegated the stewardship reporting responsibility for projects with 251 or more working days, as defined in the Contract Provisions to the various WSDOT Regions. The delegation of stewardship authority from the State Construction Office to the Regions is through the *Construction Manual*.

FHWA has also delegated to WSDOT the authority to accept projects unless FHWA has retained this action as documented in an executed project specific Project of Division Interest (PoDI) plan.

**FHWA Review/Approval Actions and Related Processes** – With the pre-approval of specifications and processes and the extensive delegation of stewardship authority, there are relatively few approval actions needed from FHWA during actual construction.

The following processes will apply:

FHWA may retain the oversight role of interim, or project inspections and acceptance, and the approval of certain high-value change orders on PoDIs. All PoDIs will be governed by a separate PoDI Plan that specifies FHWA and WSDOT’s responsibilities for the project.

The FHWA Area Engineer may choose to accompany WSDOT during the review of any federal-aid project. Such participation will be random and will be initiated by the Area Engineer. This participation by the FHWA will not change any delegation of oversight responsibility or authority in any way. When the Area Engineer has participated in a review, a copy of the summary report will be provided directly to the Area Engineer.

**Stewardship Summary Reports** – It is important to note the difference between a steward and a stewardship reviewer/reporter. Stewardship on WSDOT federal-aid projects is provided by a wide cross-section of employees who make stewardship decisions according to the requirements of the *Construction Manual* and their own delegated responsibilities and authorities. From the Project Inspector who observes Contract work and prepares pay instructions, to the Project Engineer who reviews and approves a monthly progress payment, to the Region Construction Manager who executes a change order, to the State Construction Engineer who negotiates and approves a claim settlement, all are acting as stewards in their own job descriptions and assignments.

The stewardship reviewer/reporter, on the other hand, is acting as an overseer, observing and collecting information about all of the stewardship activities, evaluating that information, making recommendations concerning the qualification of the covered work for federal funding and preparing reports to summarize the activities. Reviewers may be FHWA Area Engineers, State Construction Engineers, Region Managers or subordinate region specialists in documentation or contract administration. For the reports that it prepares, WSDOT may assign any person of the classification of Transportation Engineer 3 or above to this duty. The reviewer must not have been involved in the project-level administration and the report must be signed by someone with supervisory authority over the Project Engineer or management responsibility over the Contract itself.

- **Interim Reports:**

At least once per year, the State Construction Office will create a list of all open, federally funded projects that will be divided to assign responsibility for stewardship reporting by Region. Projects identified as requiring stewardship reporting will be required to complete and interim report. The State Construction Office delegates authority of stewardship reporting responsibility to the WSDOT Regions.

Interim Reports are required on projects with 251 or more working days, as specified in the Contract Provisions. Interim Reports will be completed when a project is at 30 – 50% of working days completed. Interim Reports may be required at a greater frequency, on shorter-duration projects, or for a special purpose at the discretion of the State Construction Office.

Copies of Interim Reports will be sent to State Construction Office and forwarded to FHWA.

- **Content of Reports**

Interim Reports provide immediate summaries of uncompleted projects, communicating details in a concise and comprehensive manner. The report should clearly identify project progress, conditions that make the project unique, difficulties encountered and their resolutions.

**Job Description** – A description of the major elements of the work. Include a narrative about the job. Include the Contractor's name, the award date, amount of the bid and the working days specified in the Contract Provisions.

**Time and Damages** – Discuss the present status of time and its relationship to the completion status. If behind, describe what is being done to catch up. Describe any suspensions or time extensions.

**Change Orders** – Choose one executed change order to confirm that the change was approved according to the checklist before the work started and that a cost verification is on file. Include a detailed description of high impact change orders (e.g., scope change, claim settlements, major impacts to cost and schedule).



**Buy America and Build America/Buy America (BABA):**

**Steel and Iron** - Choose one applicable bid item and verify that a completed and signed Certificate of Materials Origin (CMO) was submitted to the Project Engineer prior to incorporation into permanent work. Discuss how the office is tracking foreign material used to ensure the amount does not exceed one-tenth of one percent of the total contract cost or \$2,500.00.

**Construction Materials** - Review processed progress estimates to ensure that signed Certificate of Materials Origin - Required for Acceptance of Construction Materials was submitted to the Project Engineer for each paid estimate. Include information if a CMO was received that showed foreign construction materials were placed and the resolution.

**Materials** - Review a process in progress by checking for submittals and approvals of RAMs, any drawing or catalog submittals, the testing method and frequency, adjustments to the ROM, observe field tests and include a summary report. Comment on the overall status of materials testing, documentation and adequacy.

**Disputes, Claims** - Note all claims or major disputes for the project and discuss resolution, if applicable.

**Traffic Control** - Comment on the adequacy of the traffic control plans and unusual events during the project. Discuss the project's use of flagging, devices, pilot cars, etc.

**Training and Apprenticeship** - Verify that a plan has been submitted and approved, the current percentage attained, and efforts to recover if behind.

**Subcontracting** - Discuss the level and nature of subcontracted work. Note any Disadvantaged Business Enterprise (DBE) requirements and any change orders modifying these requirements by deleting, adding or substituting DBE commitments. Make reference to any Condition of Award requirements. Review on-site reports for any DBE firm utilized, whether or not its utilization was mandatory.

**Other** - Talk to the Project Engineer. Look for special notes. If there was an experimental specification or process, discuss how it is working on the project. If there was an unusual event or happenstance, discuss the circumstances that caused the event. Describe the overall impression of the contractual relationship. Describe any evidence of successful collaboration between the parties. Include any other information of interest.

**Note:** As a significant part of any review, the reviewer must visit the jobsite and confirm that a project of approximately the nature and magnitude of that shown on the plans actually does exist. This is true for all stewardship reporting.

**Communication** - Much of the day-to-day communication between WSDOT and FHWA is informal in nature. Verbal discussions, telephone consultations and email notices (including digital photos when needed for clarity) are used extensively. Except where formal written notices are specifically required, staff from both agencies will attempt to utilize the simplest form of communication that accomplishes the needed communication in the least time. All reports and correspondence related to a project shall bear both the WSDOT contract number and the FHWA project number as identifiers.

## **GEN 1-00.11 Bridge and Structures Office Support on Design-Bid-Build Projects During Construction**

The Bridge and Structures Office supports Project Offices, Regions and the State Construction Office on Design-Bid-Build projects when the Contract work involves bridges and structures. Support is provided in two primary areas; submittal review and processing, and technical support.

When changes to structural engineered drawings occur, licensed professionals shall follow the requirements in *Construction Manual SS 1-04.4* "Responsibility of Licensed Professionals for Changes to Structural Engineered Drawings During Design-Bid-Build Construction Contracts".

### **GEN 1-00.11(1) Submittal Review and Processing**

The Bridge and Structure Office coordinates and tracks submittals to be reviewed on WSDOT projects in accordance with *Standard Specifications* Section 1-05.3, Working Drawings. The Construction Support Engineers or Bridge Technical Advisors coordinate submittal reviews with the various SMEs (Subject Matter Experts) per *Section SS 1-05.3* and *Figure 1-1*. For Contracts not using Unifier for submittals, the Region Project Office electronically submits Working Drawings and design calculations in PDF format directly to: [BridgeConstructionSupport@wsdot.wa.gov](mailto:BridgeConstructionSupport@wsdot.wa.gov)

Bridge Construction Support maintains a database of submittals received and reviewed listed by Contract number at: [www.wsdot.wa.gov/eesc/bridge/conlog](http://www.wsdot.wa.gov/eesc/bridge/conlog) for Contracts not using Unifier. Contracts utilizing Unifier will process submittals accordingly and will not be entered into Conlog.

### **GEN 1-00.11(2) Technical Support**

Upon advertisement of a Contract that includes bridges or structures, the Bridge and Structures Office will identify a primary and secondary Bridge Technical Advisor (BTA) who will support the project during pre-bid questions and through construction. BTA assignments will be made for all Contracts with bridges or structures that were designed in-house as well as projects that were consultant-designed. Depending on the complexity of the project and the needs of the Region, some consultant-designed projects may use a consultant to provide primary BTA construction support. On these projects, a representative of the Bridge and Structures Office will provide secondary BTA support.

BTA assignments will be available via the "HQ-Bridge-CN Support" MS Team, which is public and accessible to all WSDOT employees. Requests for BTAs not on the list may also be made within the Team via the Posts tab.

The BTA coordinates structural support from the Bridge and Structures Office for the Project Engineer during Contract Work. BTA's may be consulted for questions relating to structural design, inconsistencies or clarifications of structural plans, and for recommendations on structural issues that are identified during construction.

The Assistant State Construction Engineer (ASCE) shall be included in correspondence on contract administration issues when:

- Work or recommendations of the BTA or others may result in a change to the Contract or are considered the practice of engineering in accordance with *Construction Manual SS 1-04.4* "Responsibility of Licensed Professionals for Changes to Structural Engineered Drawings During Design-Bid-Build Construction Contracts".

- Work of the BTA or others will result in a change to the Contract; approval for this change must come from the State Construction Office.

The Project Engineer is encouraged to engage the ASCE early in the process prior to inclusion in a BTA response.

BTAs and others shall comply with the following guidelines when supporting projects:

- Follow procedures in accordance with *Construction Manual SS 1-04.4* “Responsibility of Licensed Professionals for Changes to Structural Engineered Drawings During Design-Bid-Build Construction Contracts”
- Develop the most economical recommendations while considering the Contractor’s means and methods
- Provide recommendations and support documentation to the Project Engineer and the ASCE in writing. Include a cost estimate of any change work
- Keep all correspondence, activities and recommendations
- Defer contract administration issues or questions to the Project Engineer and the ASCE
- Conform to the field safety requirements of the Region and the Contractor
- Give the project priority but be prudent in the use of time and expense charges
- Avoid direct communications with the Contractor without coordinating through the Project Engineer
- Avoid directing the Contractor’s work

Once a project is underway, the Project Engineer shall set up a meeting between the Project Office, ASCE and primary BTA to discuss project roles, responsibilities, and communication protocols. The BTA’s technical responsibility will be to the BTA’s supervisor in the Bridge and Structures Office.

## 1-02 Bid Procedures and Conditions

### SS 1-02.2 Plans and Specifications

When the design phase of a project is completed and funding has been secured, the public is then notified that WSDOT is ready to accept bids for completion of the Work involved. This notice is accomplished by publishing an advertisement for the project, along with an invitation to bid the work, in the “Daily Journal of Commerce.” The advertisement includes a specific date and time for the opening of bids along with the necessary information for obtaining plans, specifications, and bid documents. Once advertised, these plans and specifications are then made available to all Contractors who wish to study the project. Contract proposal forms or bid documents are also furnished, but only to those prospective Contractors who have been prequalified to bid on the types and quantities of Work involved. Once bids have been opened, an announcement in the “Daily Journal of Commerce” will also be made identifying the “Apparent Low Bidder.” Specific information regarding the advertisement phase and bidding procedures can be found in the [Advertisement and Award Manual M 27-02](#).

## **SS 1-02.4 Examination of Plans, Specifications, and Site of Work**

If the Project Engineer determines that prospective bidders may have difficulty locating the project or determining the project limits, the Project Engineer may choose to post the project limits.

*Standard Specifications* Section 1-02.4 requires that all requests for explanation or interpretation of the Contract documents be submitted, and be answered, in writing. Any answers that may interpret, clarify, or change the Contract shall do so by means of an addendum. Acceptable answers to pre-bid questions are:

1. Your question will be addressed by addendum
2. Refer to the contract documents – Page/sheet #XXX
3. Bid in accordance with the Contract

Anytime the answer to a question from a prospective bidder might be perceived as interpreting, clarifying, or changing the Contract, the Project Engineer should immediately contact the Region Construction Manager or Region Plans Office to facilitate the preparation of an Addendum. Answers to such questions must be provided to all bidders in the same manner.

All questions from prospective bidders regarding an advertised project should be referred to the Project Engineer listed in the “Notice to All Planholders” for a complete response. The Project Engineer will coordinate the effort to determine if any requested information needs to be addressed by an addendum. If no addendum is required, the response will be posted on the Contract Ad & Award web page. The Project Engineer shall send the response to: [ContractAd&Award@wsdot.wa.gov](mailto:ContractAd&Award@wsdot.wa.gov) for posting to the web page.

When questions arise regarding the Transfer of Coverage (TOC) for the Construction Stormwater General Permit, the Project Engineer should go to the [Environmental Service Office's Erosion Control](#) page on the internet for guidance.

## **1-03 Award and Execution of Contract**

### **SS 1-03.2 Award of Contract**

Bids for Contracts are opened at a public meeting where each prospective bidder's proposal is read and the Apparent Low Bidder is announced:

- Within 45 calendar days of bid opening, the proposals will be closely reviewed and the Contract will be awarded to the lowest bidder deemed responsive.
- The successful bidder must return the required documentation in *Standard Specification* 1-03 within 20 calendar days. Only after all required documentation has been submitted can the Contract be executed by WSDOT.
- The Contract Administration and Payment System (CAPS) unit of Accountability and Financial Services (AFS) sends awarded Contracts to the Contractor for execution within three days of award using digital signature software.

Once bids for the Contract have been opened, all communication with bidders shall be directed through the Contract Ad and Award Office and/or CAPS. This moratorium on communication with bidders, including the Apparent Low Bidder, remains in effect until execution of the Contract.

### **SS 1-03.3 Execution of Contract**

After the documents required in *Standard Specification 1-03* are returned to WSDOT, the Contract is ready to be executed by WSDOT. Proposals submitted by Contractors are not binding to WSDOT prior to execution of the Contract. No bid item Work can be performed within the project limits or WSDOT furnished sites prior to the execution of the Contract by WSDOT. Any work that is performed by the Contractor outside of these areas, or any material that is ordered prior to WSDOT execution, is done so solely at the risk of the Contractor.

Once the Contract is executed by WSDOT, a copy is sent to the Contractor and the Project Engineer automatically through the digital signature software. Copies of the full Contract are available on the WSDOT ftp site.

## **1-04 Scope of the Work**

### **SS 1-04.3 Reference Information**

Reference Information is information provided to the Contractor that is not part of the Contract. Reference Information often includes design files, CAD files, engineering calculations, survey information, geotechnical reports, bridge condition reports, etc. Because the Reference Information is not part of the Contract, any construction requirements described in the Reference Information will need to be captured in the Contract documents (for example, the plans or special provisions).

Reference Information for most WSDOT projects should be linked through the Contract Ad and Award web site – “View Project Information” - under the Reference Information Section of the specific project page.

### **SS 1-04.4 Changes**

WSDOT reserves the right, under *Standard Specifications* Section 1-04.4, to make changes to the work, work methods, working days, or quantities, as necessary to satisfactorily complete the project as originally intended.

Adding work beyond the original scope is, in essence, entering into a contract to perform work without the benefit of a competitive bid. There is a statutory ([RCW 47.28.050](#)) exception from the competitive bid requirement for work up to a value of \$7,500. If the value of the work is in excess of \$7,500 it is necessary to go through the competitive bidding process.

Change order work may impact the design criteria used to develop the project. The Project Engineer must be alert to this and ensure that the Design Documentation Package is revised to reflect any such changes. Changes to the design may also require reevaluation of environmental processes (NEPA/SEPA), as well as permit modifications. The Project Engineer must contact the Region Project Development staff and Environmental Permit Coordinators to obtain approval for the change, and for guidance in documenting and incorporating the change into the Design Documentation Package.

## Types of Changes

There are several categories of changes that may occur during the work. A change may warrant additional payment to the contractor, a credit to the contracting agency or be a no cost change order. A change may also warrant an increase or decrease in the working days. Every situation is different. The *Standard Specifications* are very specific on what additional costs are eligible for adjustment. The balance of this discussion of types of changes is intended to help describe and explain the various categories of changes. The Project Engineer should also employ the guidance supplied by the WSDOT Construction Change Order Process Guide, which is available on the [State Construction Office SharePoint site](#).

## Deletion of Items

- A. **Authority to Delete** – As provided in *Standard Specifications* Section 1-04.4 and 1-08.10(2), WSDOT may cancel all or portions of Work included in a Contract. Refer to Section 1-07.11 for information regarding changes or deletion of Work that affect COA requirements.
- B. **Payment for Remaining Work** – There are some limitations to payment that should be noted under *Standard Specifications* Section 1-09.5. When work is decreased or deleted by the contracting agency, payment will only be for the costs actually incurred for partially completed work. No profit will be allowed for work that was not completed. Consequential damages are also not allowed. Consequential damages may include such things as: loss of credit, loss of bonding capacity, loss of other jobs, loss of business reputation, loss of job opportunities, etc. In the case of a portion of a lump sum item or partially completed unit items, the value of this work will need to be determined. It may also be necessary to negotiate a price adjustment for the work that was performed and paid using a contract unit price if there is a material difference in the nature of the accomplished work when compared to the nature of the overall planned work. Under certain circumstances when the contractor says, “you eliminated all the easy work and left the difficult,” there may be entitlement to an adjustment.  
  
In the event that the deletion impacts the critical path for the project, an adjustment in working days may also be appropriate.
- C. **Payment for Materials** – When work is deleted from the project and the contractor has already ordered acceptable materials for such work, *Standard Specifications* Section 1-09.5 controls.
  1. **Contractor Restocks** – The first and best method for disposing of the materials is to request that the contractor attempt to return the materials to the supplier at cost or subject to a reasonable restocking charge. If the materials are restocked then, in accordance with *Standard Specifications* Section 1-09, the contractor’s actual costs incurred in handling the materials may be paid.
  2. **Contractor Purchases** – If WSDOT cannot utilize the materials, the contractor may elect to retain them for other work. Once again, in accordance with *Standard Specifications* Section 1-09, the contractor’s actual costs incurred to handle the materials may be paid.

3. **State Purchases and Disposes** – As a last resort, if the materials can not be disposed of at a reasonable cost to WSDOT, the Department may choose to purchase the materials from the contractor. There are some limitations that come with the use of federal funds that may require that the materials be purchased with state funds depending on the situation. The State Construction Office may be contacted for advice. If possible, such materials may be provided to a future contractor (work with Design) or to Maintenance (work with the Regional Maintenance Office). If the materials cannot be used, they shall be disposed of as described in the WSDOT [Disposal of Personal Property Manual](#) M 72-91. Once again, in accordance with [Standard Specifications](#) Section 1-09, the contractor's actual costs incurred in handling the materials may be paid.

### **Contract Modifications**

Changes in Materials, Work Method, or Work Sequence may or may not be a change to the contract. The determining factor is if the change is a modification of a specific contract requirement. If the contract includes language such as “recommends,” “suggested,” or “approved equal” associated with the item or allows the engineer to approve changes, then a change order is probably not required. In essence, this would not be a violation of the contract and therefore, does not require a change to the contract. A common situation is when the contractor proposes a change to a submitted manufacturer's recommendation, drawing or plan such as a falsework drawing or erection plan. Changes to those drawings/plans may be made by the same authority that approved them the first time. Once again, it is not a change to the Contract.

### **Responsibility of Licensed Professionals for Changes to Structural Engineered Drawings During Design-Bid-Build Construction Contracts**

During construction, changes to engineered drawings are often required to address field conditions, plan errors, Contractor errors, repairs, differing site conditions, etc. The following policy defines the responsibilities of licensed professional engineers for changes to engineered drawings for bridges and structures after Contract award and execution.

#### **Practice of Engineering**

The practice of engineering is defined in [RCW 18.43.020\(5\)\(a\)](#):

“Practice of engineering” means any professional service or creative work requiring engineering education, training, and experience and the application of special knowledge of the mathematical, physical, and engineering sciences to such professional services or creative work as consultation, investigation, evaluation, planning, design, and supervision of construction for the purpose of assuring compliance with specifications and design, in connection with any public or private utilities, structures, buildings, machines, equipment, processes, works, or projects.

#### **Structural Engineering**

Structural engineering is recognized as a specialized branch of professional engineering. See [Bridge Design Manual](#) 1.3.2.C for guidelines on providing structural engineering services for significant structures.

## Area of Expertise

For a change to be within their area of expertise, the licensee shall be registered in the applicable technical field and qualified by education or experience as defined in the Revised Code of Washington (RCW) and Washington Administrative Code (WAC). The licensee shall be competent in the technology and knowledgeable of the applicable codes and regulations (see [WAC 196-27A-020\(2\)](#)).

## Evaluation of Changes for Practice of Engineering

All proposed changes from what is shown in the engineered drawings shall be evaluated by the Project Engineer to determine whether they are considered practice of engineering. When the change is outside the area of expertise of the Project Engineer, they shall consult the ASCE and a licensed professional acting within their area of expertise to make this determination. Some examples of changes to engineered drawings that may be considered the practice of engineering include:

- Changes to engineered drawing details
- Material substitutions not allowed in the Contract documents, and possibly material substitutions when the Contract allows “approved equal” replacements
- Material properties outside of contract tolerances, even when the contract provides a method for acceptance such as for deficient strength concrete
- Changes in geometry or location of a component outside of contract tolerances when the capacity or function of the element or system is affected
- Changes to mandatory, prescriptive construction sequences shown in engineered drawings (e.g. including but not limited to sequencing and temporary work)
- Repairs that impact the capacity or function of the element. For example:
  - Modifications to structural steel elements
  - Concrete repairs that involve modifications (splicing, coupling, doweling) to reinforcing steel
  - Repairs to structural elements that are already loaded by actions such as prestressing, release of falsework, subsequent material placement, etc.
- Modification to a concrete construction joint in a bridge column, bridge crossbeam, bridge deck, prestressed element, etc. (see [Standard Specification 6-02.3\(12\)A](#))
- Modification of a concrete reinforcement splice (see [Standard Specification 6-02.3\(24\)D](#))

Some examples of changes to engineered drawings that may not be considered practice of engineering include:

- Editorial changes (such as corrections of spelling or grammar) with no effect on engineering performance
- Changes to quantities with no effect on engineering performance
- Corrections to sheet and detail references with no effect on engineering performance
- Addition of typical construction aids. For instance, in concrete construction, the addition of concrete embedments used to facilitate construction including inserts, reinforcement ties and chairs, reinforcement braces, form ties and hangers, strand deviators, CSL tubes, thermocouples, etc.



- Notation of which alternate or option was chosen when engineered drawings identify acceptable alternates or options for portions of the Work
- Application of pre-approved repair procedures

### Documentation and Notification Requirements

After determining whether a proposed change is the practice of engineering, the Project Engineer shall then ensure the requirements listed in the table below are met:

	Change to the Contract	Not a Change to the Contract
Practice of Engineering	<ul style="list-style-type: none"> <li>• Change shall be prepared and sealed by a licensed professional acting within their area of expertise</li> <li>• Notify the original Engineer-of-Record of change if possible</li> <li>• Document change in change order and in as-built</li> </ul>	<ul style="list-style-type: none"> <li>• Change shall be evaluated by a licensed professional acting within their area of expertise</li> <li>• Notify the original Engineer-of-Record of change if possible</li> <li>• Document change in as-built</li> </ul>
Not the Practice of Engineering	<ul style="list-style-type: none"> <li>• Change need not be prepared and sealed by a licensed professional</li> <li>• Document change in change order and in as-built</li> </ul>	<ul style="list-style-type: none"> <li>• Document change in as-built</li> </ul>

For proposed changes considered to be the practice of engineering, the Project Engineer shall require sealed engineering calculations and/or other documentation to show that the change complies with all design criteria or is otherwise structurally acceptable. If WSDOT prepares or evaluates the change, the calculations or other documentation will be generated and archived by the support group preparing the change as appropriate and need not be provided to the Project Engineer. Any sealed engineering calculations and/or other documentation for structures that is not prepared by WSDOT shall be provided to the WSDOT Bridge & Structures Office who will archive it if appropriate in accordance with [Bridge Design Manual](#) Sections 1.3.3.C.4 and 1.3.8.

The licensed professional engineer shall be a licensed structural engineer when providing structural engineering services for significant structures.

Licensed professional engineers who sealed the current documents shall be notified of changes to their work (including Contract-allowed “approved equal” material substitutions) that are considered practice of engineering and shall be given an opportunity to review and comment, if possible. Licensed professional engineers who are no longer WSDOT employees or who are not available through a consultant services agreement need not be notified of changes to their work (see [WAC 196-27A-030\(9\)](#)).

### General Requirements for Changes to Engineering Drawings

The location, extent and details of all physical changes to the Work shall be contained in the changed engineering drawings. If changes to engineered drawings are part of a Contract change order, the drawings shall identify the associated change order by number.

## Changes to Engineered Drawings Prepared and Sealed or Evaluated by a Licensed Professional

Changes to engineered drawings may be prepared and sealed or evaluated by any licensed professional engineer who is working within their area of expertise. As a way to limit costs, it is recommended to have the engineering done by the person or party who may complete it most efficiently. Some general guidelines to consider include:

- When WSDOT is the Engineer of Record, it is usually most efficient to have WSDOT prepare the changes to engineered drawings
- If there is a consultant Engineer of Record, and a consultant services agreement exists with them, they should prepare changes to the engineered drawings. Otherwise, changes to engineered drawings could be handled by a different consultant or by WSDOT
- When WSDOT has the contractual responsibility for the change, the engineering should be performed by WSDOT or by a consultant working for WSDOT
- When the Contractor has the contractual responsibility for the change, or the responsibility is not apparent, the engineering may be performed by WSDOT, a consultant working for WSDOT, or an engineer working for the Contractor
  - The Contractor may hire an engineer to make the changes to the engineered drawings. The modified drawings will require WSDOT review and concurrence
  - It may be more efficient for the Engineer of Record (WSDOT or a WSDOT consultant) to perform the engineering; we own the design so there is less start-up effort needed to evaluate a change to an engineered drawing
  - WSDOT can require the Contractor to perform any needed engineering
  - For significant changes, WSDOT should consider reimbursement for our engineering costs through a credit change order

Changes to engineered drawings shall be prepared on the most recent version of the existing drawings, on substitute drawings or on additional drawings. For revisions to existing engineered drawings, the licensee shall note the extent of their change and responsibility (see [WAC 196-23-020\(3\)\(a\)](#) and [WAC 196-27A-030\(9\)](#)). When revisions to existing engineered drawings will make the drawings difficult to read or interpret, the details and changes should be consolidated onto substitute drawings. Substitute drawings shall meet the detailing requirements of [Bridge Design Manual Chapter 11](#) and [Plans Preparation Manual Chapter 4](#). Preexisting seals of licensed professional engineers shall be preserved when revising existing engineered drawings but need not be preserved for substitute drawings.

Provided a licensee is acting within the guidelines of their profession, during an emergency it is acceptable to certify documents after the emergent need is stabilized (see Secretary's Executive Order E 1010.01 III.B).

### **Contractor Endorsement/Unilateral Execution**

In order to facilitate timely processing of all change orders, the [Standard Specifications](#) require the Contractor to endorse or respond to a change order within 14 calendar days of delivery from WSDOT. With the exception of Minor Changes (see Section 1-04.4(1)), a Contractor signature is required for change orders. Change orders are identified as a document that requires additional verification and must be signed using an approved electronic signautre software (currently Adobe Sign). A change order signature flowchart

is available for use on the [Construction SharePoint](#) site to assist with setting up documents to receive the appropriate signatures (depending on execution requirements) in the system.

The [Standard Specifications](#) retains authority for the Project Engineer to unilaterally execute change orders when the Contractor fails to respond within the time specified or refuses to sign a change order. When this happens, the Project Engineer will notify the Region Construction Engineer with the intention of proceeding with unilateral execution of the change order. Processing the change order unilaterally will ensure that all parties affected by the change are promptly paid.

To document a unilaterally executed change order using the electronic signature program (Adobe Sign), the Project Engineer will send it for signature following typical protocol. If the Contractor has not signed the change order within a two week timeframe:

- Cancel the document
- Set it up again for signature without including the Contractor as a signer
- Attach the original audit report showing that the Contractor was given two weeks to sign it, but chose not to

Requests for extensions of time for Contractor endorsement may be granted with sound justification from the Contractor. Items to consider for granting such requests are size, risk and complexity of the change, whether terms have been agreed to prior to sending the change order for signature, prompt payment and if surety consent is required. The Project Office should consult the Region Construction Engineer prior to approving a time extension request for endorsement of a change order.

### Approval of Changes/Checklist

In addition to noting who can execute a change order, the Change Order Checklist (DOT Form 422-003) further indicates who must approve the change prior to execution. The completed checklist will be a part of the change record and shall accompany the change order when it is transmitted to the State Construction Office, and represents the minimum information required to process the change order. Written approval constitutes agreeing with the general nature of the change and can be granted by memorandum, RFI response or email. The checklist works as follows: for any item marked “yes,” approval from the State Construction Office must be obtained if indicated by the column with the “Xs.”

The Project Engineer and the Region Construction Office have the authority to decide not to proceed with the change. This approval does not constitute authority to proceed with the Work. Approval to proceed with the Work prior to executing the change order must come from the person who will execute the change order (see approval to proceed). In an emergency, the Region Construction Manager may authorize Work to begin on any change order if the assigned ASCE or other State Construction Office representative cannot be contacted for the required approvals and the Work must proceed.

### Approval to Proceed

All change orders shall be executed prior to the work being performed unless otherwise approved as an exception. In all cases, approval requests (per the change order checklist) should occur immediately after the need for a change is identified and include at a minimum, why the change is necessary, general terms of the change, estimated cost (range of cost acceptable) and the change in contract time. If it is determined to be

necessary to proceed with the change work prior to execution of the change order, this exception requires approval per the checklist and approval from the executing authority prior to beginning work. Such an approval to proceed might be warranted if it will provide a cost/time benefit to WSDOT or minimize a cost/time disadvantage to the Contractor.

In the event that the Project Engineer determines that it is in the State's best interest to proceed with the Work prior to having a signed change order, the permission of the executing authority and approval per the checklist to proceed with the change under these circumstances must be documented in the file. If approval is granted to proceed prior to an executed change order, the Project Engineer must process a change order prior to payment becoming due to the Contractor. For complex changes, this may necessitate issuing multiple change orders and/or paying for the initial Work on a Force Account basis until agreement on an overall equitable adjustment can be reached.

In the event the Project Engineer determines, as part of the RFI, a change is required and that it is necessary to proceed with the change Work prior to execution of the change order, approvals shall be obtained prior to responding to the RFI.

- A. **FHWA Approval** – On Projects of Division Interest (PoDI), written FHWA approval, or other less formal prior approval if the public interest is served by the more timely action, is required prior to beginning work on those change orders meeting the threshold as outlined in the project specific PoDI agreement.

**Who does what?** – The Region will formally submit this type of change order to FHWA for approval if it is within Region approval authority. If it is outside Region approval authority, the State Construction Office will submit the change order to FHWA for approval. A guidance document regarding PoDI is available on the [HQ Construction SharePoint](#) site.

- B. **State Materials Laboratory**

**Areas of Responsibility** – *Standard Specifications* Division 9 (see [Section 1-00.3\(2\)](#)) The State Materials Laboratory also advises the State Construction Office and Regions regarding an alternate material's capability to perform the same function as a required material. However, the State Construction Office makes the final approval based on application of the material, maintenance concerns, etc., as to whether an alternate material acceptable.

## Delegation of Execution Authority

### *Highway Construction*

The Change Order Checklist (DOT Form 422-003), in addition to describing the approval requirements previously described, also outlines who has authority to execute a change order.

The State Construction Engineer (or designee) executes the change order:

- If any one of 1, 2, 3, or 4 is true (checklist item # 1, 2, 3, or 4 is yes).

The Region (Regional Administrator (and those designated Regional Administrator authority) may execute a change order provided:

- 1, 2, 3, and 4 are not true of the change (checklist item # 1, 2, 3, and 4 are no).

The Regional Administrator's authority to execute change orders may be:

- Delegated to the Regional Construction Manager.
- Further delegated to the assistant to the Regional Construction Manager.
- Further delegated to the Project Engineer.

### Limits of Execution Authority

Executing Authority	Dollar Limit	Time Limit
State Construction Engineer	\$2,000,000 and Greater	60 days and Greater
Deputy State Construction Engineer	not to exceed \$2,000,000	not to exceed 60 days
Lead Construction Engineer	not to exceed \$1,000,000	not to exceed 60 days
Assistant State Construction Engineers	not to exceed \$1,000,000	not to exceed 60 days
Region Administrator (and those designated Regional Administrator authority) or Designee	not to exceed \$500,000	not to exceed 30 days

### Local Agency Projects

When the project being administered includes local agency participation, the Project Engineer should coordinate with the Regional Local Programs Engineer and the local agency to establish an approval process acceptable to all the parties. Any funding constraints and timelines for reviews and approvals should be established per an agreement and specified in the contract, if appropriate. Absent an agreement, changes that affect permanent work incorporated within WSDOT right of way with use of local agency funds (regardless of which agency is administering the contract) will require following the WSDOT approval process and execution authorities.

### Documentation

#### State Construction Office Role

The State Construction Office will review Region executed change orders and provide appropriate feedback.

#### Project Files

A. **CCIS Input** – The Project Engineer will ensure that the following information is entered into CCIS accurately and in a timely manner:

- Page 1
  - Contract No.: (in 6-digit format)
  - Proposed By: C(Contractor), E(Engineer), or B(Both)
  - Order Date: Date change order is entered into CCIS
  - Unilateral Change: Y/N
  - PE Stamp required: Y/N (**Note:** For structural changes, see Section “Responsibility of Licensed Professionals for Changes to Bridge and Structure Engineered Drawings During Design-Bid-Build Construction Contracts”.)
  - Short Description: Descriptive title for change order
  - Is this a Minor Change?: Y/N

- Page 2 – (Use only if approval to proceed is requested)
  - Approval Date: The date approval given
  - Requested By: Who requested approval
  - Approved By: Who gave approval
  - Estimated Amount: The estimated dollar amount of the change order
  - Narrative: Description of why approval is needed
- Page 3 – (Use only if this change order is a Value Engineering Change Proposal (VECP))
  - VECP Amount
  - Commentary on VECP
- Page 4
  - Sent To Contr: The date the change order was sent to the Contractor for signature/concurrence
  - Rec'd From Contr: The date the change order was returned from the Contractor
  - Surety Consent: Was surety consent obtained (Y/N)
  - Surety Date: Date surety consent is obtained
  - PE Recom: Is the Project Engineer recommending execution by Region or the State Construction Office
  - Exec: Initials of the Project Engineer if executing the change the order
  - Date: Date that the Project Engineer executed or recommended execution (**Note:** the date field on line 4 is for Region or State Construction Office use only)
  - By Whom: Who voided the change order (if applicable)
  - Date: Date the change order was voided (if applicable)
- Page 5
  - Phase: Contract phase affected by change order (if days are added/deleted)
  - Description: Phase description (if days are added or deleted)
  - Net Change: Number of days added or deleted by change order
- Page 6
  - Description: Change order text (uploaded from C30P: Construction Contract Change Order Program)
- Page 7
  - What Section of the contract changed?
  - Describe the Detail Change:
  - What created the need or caused the change?
  - What is the purpose of this change order?

If new items are created, Contract items are modified, or Condition of Award (COA) is modified by the change order, this information must be input into CCIS as well.

CCIS automatically assigns sequential change order numbers. Timely entry will provide information regarding the need for the change and must be adequate to assist the users with monitoring project changes and costs. Some key items to remember are as follows:

- Is there a clear description of the Work?
- Is the origin and purpose of the change being entered using at least two of the reasons listed in the system?
- Was there an order, other than a signed change order, by the Project Engineer for the Contractor to proceed?
- Is there a reference to any key documents in the change order file?
- Are any increases or decreases in Contract time associated with the change order entered in the appropriate field enabling the Weekly Statement of Working Days to be automatically updated?
- For COA change orders, are the appropriate fields filled in to generate the change order and automatically update the COA items?
- Are any disclaimers included in the change order and are any agreed upon disclaimers included in the text?
- Are all the appropriate dates entered?

**B. Change Record (DOT Form 422-002)** – The change record must accompany the change order describing the change in sufficient detail so that everyone involved will understand the need for the change, will see that the price is appropriate and that appropriate checks and consultations have been made. The following is a list of items to include in the change record accompanying the change order:

**1. Evolution & Description of the Change**

- What is required by Contract?
- What is the change?
- How does it solve the problem?
- Reason for entitlement/why is this not paid under the Contract?
- Is there time associated with the change?
- Did the Contractor concur/if not why?
- Is FHWA participation appropriate?
- Does the change affect COA?

**2. Basis of Cost & Justification**

- Any increase or decrease in cost?
- How it was established (see equitable adjustment)
- Force account must include estimate

**3. Contract Time**

- Does the change impact the critical path?
- How was any change in working days established?
- Note if a change in Contract time affects the amount of liquidated damages

#### 4. Prior Approval

- Was the change order executed by the appropriate WSDOT authority prior to proceeding with the Work?
- If not, prior approval by whom and when

#### 5. List Attachments

- Checklist
- Documentation of approval to proceed
- Any supporting documentation needed for understanding

- C. **Distribution** - Change orders are signed and transmitted using approved electronic signature software (currently Adobe Sign). Each change order is set up to require specific signatures depending on execution requirements. After receiving all the required signatures, a copy is automatically sent to the Contractor through the electronic signature software.

If the change order requires FHWA approval per Section SS 1-04.4, FHWA must include the appropriate FHWA representative as a signer when setting the change order up in the electronic signature program.

Completed change orders (all required signatures applied) and corresponding backup documentation are routed through the Electronic Content Management (ECM) for review and storage. The Project Office initiates the process through the Electronic Change Order Routing Workflow:

#### Electronic CO Routing Workflow

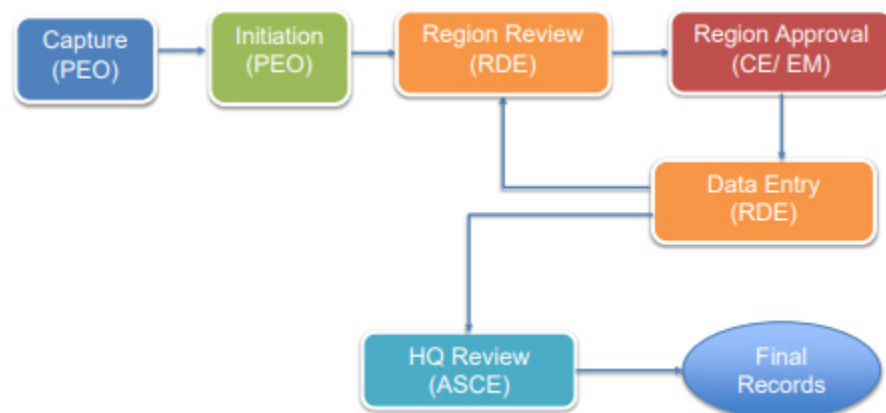

- **Capture** - The Project Office uploads the change order and backup documentation.
- **Initiation** - The Project Office starts the change order routing workflow in the ECM.
- **Region Review** - Region Documentation Engineer reviews and either sends it to the Construction Engineer or Engineering Manager for approval or sends it back to the Project Office for corrections.
- **Region Approval** - Construction Engineer or Engineering Manager reviews and either sends to Region Documentation Engineer for data entry or back to the Region Documentation Engineer for corrections.
- **Data Entry** - Region Documentation Engineer executes the change order in CCIS, completes the CAPS entry if a new bid item is created and/or notifies CAPS if a new group needs to be created.



- **HQ Review** - Assistant State Construction Engineer (ASCE) reviews the change order and either sends it to the ECM for final record storage or returns to the Region Documentation Engineer for correction. If the change order exceeds the threshold to post the change order on the external website or for lessons learned tracking, the ECM will mark it as such for further processing at HQ.
- **Final Records** - Moving the document to this step completes the process and moves the change order to the final records in the ECM. The Region Documentation Engineer will enter change order information in CAPS if a new bid item is created and notify the CAPS unit of Accountability and Financial Services (AFS) to create new groups. Additional resources regarding the change order signature and password requirements are available on the [Construction SharePoint](#) site.

**D. Protecting the Interest of the Surety** – Consent of Surety may be required on any change order that expands the scope of the contract. It is also appropriate on any change of large value or risk. Failure to obtain consent of surety could weaken the State’s protection under the bond.

**E. Change Order Tracking**

In order to provide current status and communication of contract changes Project Offices need to maintain an active change order log. For consistency, a tracking template has been developed and can be found on the [State Construction Office SharePoint](#) site: Change Order Forms - All Documents Congnos also has a standard report that can be used for tracking under “Individual Contract Analysis”.

**SS 1-04.4(1) Minor Changes**

All contracts will have a standard item for “Minor Change.” This item will be established in every group as a calculated lump sum. Credits, debits, changes in working days and no cost changes may all be processed under the Minor Change method subject to the listed criteria.

The Contractor may submit an RFI, in accordance with Section 1-05.1(2) *Requests for Information*, requesting a change to the Contract so long as it meets the criteria for a minor change. The minor change should be used for simple and straightforward Contract modifications. In any case, a Contractor-proposed change must be beneficial to the project. The Project Engineer is under no obligation to accept the proposal and the Contractor may not protest the Project Engineer’s decision.

**Criteria for Use**

Although the change meets the criteria for using the Minor Change process, the Project Engineer may decide that this process is not appropriate. The use of this item is at the Region’s and the Project Engineer’s discretion. Also keep in mind that the limitations and approvals required by the Change Order Checklist still apply as well as all other Change Order criteria not modified by this Minor Change section. Use of the Minor Change process is limited to changes that satisfy all of the following criteria:

- The value of the change (credit or debit) is estimated at \$25,000 or less
- Any change in working days not greater than ten days
- The proposed change can be fully described and explained on page 1 (Change Order page) and with no more than 3 revised/new plan sheets

## Endorsement

In the interest of being timely, the Change Order should be a tool to document agreement and not a negotiation tool back and forth. The Contractor's authorized signature on the Change Order is desirable but not mandatory. A phone call or a verbal agreement with the Project Superintendent may be appropriate when payment is to be made under the item "Minor Change." This may be a good discussion item at the preconstruction conference. The Project Engineer should determine when the Contractor's signature is required based on when it is in the State's best interest to document agreement prior to proceeding with a Change Order. Some situations that may warrant the Contractor's signature are as follows:

- The Contract includes substantial incentives
- There are mutual benefits associated with the change
- The change might include impacts to time or other Work
- The change is proposed by the Contractor
- The change is a claim settlement

In any case, a copy of page 1 (Change Order Page) of DOT Form 421-005A must be sent to the Contractor. If the Contractor does not agree with the terms or conditions of any Change Order and has not endorsed the change, then the Contractor is required to follow the procedure outlined in [Standard Specifications](#) Section 1-04.5. This orders the Work to proceed and puts the decision to continue negotiations in the Contractor's hands as detailed in that section. The Contractor is obligated to endorse or protest as described in the Specification, and a timeline is provided for these actions.

## Execution

Due to the criteria for the application of minor changes, the Project Engineer has the authority to execute these change orders, after obtaining all approvals required by the change order checklist. Approval is required prior to performing the work.

## Payment by LUMP SUM

The negotiation of prices for payment under the item "Minor Changes" is intended to be the same as any other change order. The focus, as always, should be forward pricing such that the Contractor controls the work and assumes the risk. However, situations occur where it makes sense to measure portions of the work in a variety of ways such as units, force account and/or lump sum. The method for establishing, measuring and monitoring the total may be by any combination of methods however, the payment will only be by a lump sum under the item "Minor Changes."

## Project Files

- CCIS Input** - "Minor Change" Change Orders must be entered into CCIS; however the required input is slightly abbreviated. Since a formal Change Order document as described in Section [SS 1-04.4](#) is not processed, the Work Description Section in CCIS requiring a detailed upload of text is not required. However, the Short Description is required and should provide enough detail to identify the content of the "Minor Change" Change Order. All other information requested by CCIS, including changes to Working Days, is required.

- B. **Transmittal** – Under the Minor Change process (Change Order – Minor Change DOT Form 421-005A) substitutes for the transmittal included in the more formal process described above. The information on the Minor Change form should at a minimum briefly document three key items:
- A description of the change
  - Reason for entitlement/why is this not paid by bid items
  - Any increase or decrease in cost and time and briefly how it was established
- C. **Distribution** – When utilizing the Minor Change process, the Minor Change Form is substituted for the Change Order document and the change record. Backup documentation shall be kept in the project file at the Project Office, with a copy of the completed Minor Change form. The original, signed Minor Change form, change approval documentation, and the original, completed change order checklist shall be submitted to the State Construction Office. The Minor Change shall be fully documented on DOT Form 421-005A, which is limited to pages 1 (Change Order Page) and 2 (Change Record Page), with no more than three new or revised plan sheets included. A copy of the form may be used to document the payment.

#### **SS 1-04.4(2) Value Engineering Change Proposal (VECP)**

It is the policy of WSDOT to encourage our contractors to be innovative in planning and performing the work when a cost savings can be realized. When a contractor identifies such a savings and provides a significant portion of the efforts needed to develop the proposal, WSDOT will share the resulting savings with the contractor. This policy is carried out through change orders containing Value Engineering Incentive Payments. The Project Engineer should encourage VECPs and seriously consider the mutual benefits of these proposals brought forth by the contractor as a partner in the contract.

A VECP must meet all the requirements enumerated in [Standard Specifications](#) Section 1-04.4(2)A, General.

#### **SS 1-04.4(2)B VECP Savings**

VECP savings are calculated as defined in [Standard Specifications](#) Section 1-04.4(2)B1, Proposal Savings and [Standard Specifications](#) Section 1-04.4(2)B2, Added Cost to Achieve Time Savings.

#### **SS 1-04.4(2)C VECP Approval**

There are two separate approvals for a VECP. The first is approval of the concept as described in [Standard Specifications](#) Section 1-04.2(2)C1, Concept Approval and the second approval is described in [Standard Specifications](#) Section 1-04.4(2)C2, Formal Approval.

#### **SS 1-04.5 Procedure, Protest and Dispute by the Contractor**

During the course of a Contract, differences of opinion may arise over decisions and plan interpretations that benefit one party at the expense of the other. WSDOT pursues resolution of these differences at the earliest possible time, fully recognizing the contractual rights of the Contractor during the resolution process. These differences of opinion can become contentious and distracting for both WSDOT and Contractor staff. The Project Engineer should make every effort to maintain professionalism and

collaboration between the parties while seeking timely resolution of these disagreements. In all circumstances, the Contractor must continue to proceed with the Work under the Contract.

Disagreements, disputes, and protests are the responsibility of the Project Engineer until a Certified Claim is filed in accordance with *Standard Specifications* Section 1-09.11. The Project Engineer may employ a variety of techniques and procedures to pursue resolution of these issues. With the high potential for cost impact and delay, it is strongly recommended that all disagreements be identified, tracked, and communicated with the Region Construction Manager as they become apparent.

### **Protested Work**

When the Contractor disagrees with the requirements of a change order or a Project Engineer's Written Determination, a written notice of protest must be submitted according to procedures of *Standard Specification* Section 1-04.5.

While the Project Engineer may acknowledge a Contractor's verbal protest, the Contractor should be advised that it must follow the procedures of Section 1-04.5 in order to pursue an adjustment of the payment or Contract time, and to avoid waiving its right to pursue a claim for protested work. While these provisions require the Contractor to keep accurate records for completing the protested work, it is not advisable for the Project Engineer to rely on these records to determine what may have taken place when trying to verify costs for protested work many months later. In order to help document the Contractor's work, the form Report of Protested Work DOT Form 422-007 was developed as a tool for the Project Engineer's use.

If in the opinion of the Project Engineer, the Contractor has not supplied sufficient information to evaluate a protest, the Contractor may be allowed one opportunity to correct or amend their supplemental information. Corrections or amendments of the supplemental information must be furnished within 14 days of the Project Engineer's notice.

Only protests and supplemental information that follow the procedures set forth in Section 1-04.5 will be evaluated by the Project Engineer, with a Written Determination of merit provided to the Contractor within 21 days. If the Project Engineer determines that the protest has merit, then an adjustment of the payment or contract time will be made in accordance with Section 1-09.4.

If the Project Engineer determines that the protest does not have merit the Contractor may continue to pursue the protest by following the dispute procedures outlined in Section 1-04.5(1). Regardless of the Contractor's decision to continue the dispute, the Project Engineer must ensure the Contractor continues work.

#### **1-04.5(1) Disputes**

The Contractor must exhaust the procedures for protest before pursuing the matter as a dispute. The Contractor is required to notify the Project Engineer within 14 days after receiving the Project Engineer's Written Determination of merit of their protest. The Project Engineer should remind the Contractor of its obligation to furnish this notice if it wishes to pursue the dispute. The Contractor must exhaust the procedures in this section, including the use of a Disputes Review Board, before they may submit a Certified Claim under Section 1-09.11.

## **Disputes Review Boards**

Unresolved Protests may be referred to a Disputes Review Board (the board). Whether the Contract includes the bid item for “Disputes Review Boards” will determine whether referral of the matter to the board requires mutual agreement of the parties or whether either party may refer a matter to the board. Not all matters are eligible to be heard by the board. Typically, the board is best suited to provide recommendations on matters of Contract interpretation or entitlement to additional compensation and time. Interpretations of the law and matters concerning the fairness of Contract terms are usually not appropriate for consideration by a board. In all cases, the Project Engineer must contact the State Construction Office for concurrence before presenting any matter to a Disputes Review Board.

The Project Engineer and Contractor are responsible for selecting the board members. They may use the Statewide Prequalified Candidate Roster to select board members, but it is not required. Once established, regular meetings should be held to discuss the status of the project with the board. The board’s primary purpose in regular board meetings is claim avoidance. By monitoring key project indicators and facilitating communications between project participants, the board can be quite effective in helping the project avoid claims.

The board may also assist with claim resolution by issuing written recommendations regarding a specific dispute that is referred to them. When the board issues a recommendation concerning a dispute, the Contractor and Project Engineer must respond and either accept the board’s recommendation, request a clarification or reconsideration from the board, or notify the other party that the dispute is unresolved. Although the board recommendations are not binding on either party, they should be weighed carefully and will be admissible in subsequent proceedings such as arbitration or litigation. The Project Engineer should consult with their ASCE if they are not in agreement with the board’s recommendations prior to responding in writing to the board and the Contractor.

### **SS 1-04.6 Variation in Estimated Quantities**

Contracts are set up with estimated quantities. Contractors provide unit prices and actual measured quantities are paid using those unit prices. What happens when the actual measured quantity varies from the estimated proposal quantity? [Standard Specifications](#) Section 1-04.6 require that variations of less than 25 percent be performed without changes in the bid price, but that variations greater than 25 percent may qualify for a payment adjustment of the contract bid. This distribution of estimating risk is a policy of WSDOT and is also a Federal requirement for any project with Federal funds.

Variations may occur because field conditions cause a different quantity for the planned work than was envisioned during the estimating. Other variations may occur when work is added or deleted by change order and original contract unit items are included as the method of pricing the change order. Finally, quantity variations occur when work is added, deleted, or revised without a formal change order (constructive change) and units with unit prices are the only measure of the revision. The work represented by a constructive change order is in fact work not anticipated at the time the contract was bid and executed, and as such would be outside of the requirements of [Standard Specifications](#) Section 1-04.6. In other words, you cannot deny a payment adjustment based solely on the fact that the accepted quantity of a bid item is within 25 percent of the original proposal quantity.

As discussed below, quantities included in formal change orders are excluded from consideration of quantity variations. The Project Engineer who allows constructive changes without formal documentation may find an additional negotiation waiting when final adjusted quantities are calculated and compared with the original proposal quantity.

A unit bid price consists of four different parts. First, and most obvious, are the costs of labor, equipment, materials and services needed to accomplish the work. These are the “direct costs” involved and they vary directly with the amount of work. Second are the variable overhead costs, such as field supervision, field support items (phones, computer rental, payroll clerks, portable restroom, etc.) whose amounts will vary along with the direct costs. Third, and more difficult to assess, are unavoidable, distributed, fixed overhead costs. These are typically long term and exist whether the quantity varies or not. They include things like home office costs, field trailer setup, long term equipment rentals and other fixed costs. These are typically distributed to the project by allocating them to the plan quantity. Fourth, and finally, the unit price will include some amount for profit.

- A. **Standard Specifications Section 1-04.6** – The standard contract provision calls for the calculation of an adjusted final quantity. This is the method of revising the final measured quantity to allow for proposal item quantities included in agreed change orders. Unit prices as originally bid will be utilized if the adjusted final quantity is more than 75 percent of the original proposal quantity and not more than 25 percent greater than the original proposal quantity.

If the final adjusted quantity is outside these limits, then either party to the contract may initiate a renegotiation. If neither party does so, then unit prices will apply to the entire measured quantity of the item. Neither of these actions would be a change to the contract, as the provisions already allow a price change. A formal change order document might well be initiated to show the agreement, however, and would be the mechanism to create new prices.

If a negotiation is initiated, the provision calls for a new price for the quantity in excess of the 25 percent overrun or a contract price adjustment to compensate for costs and losses associated with an excessive underrun. The renegotiated price for the overrun portion is not an equitable adjustment and this is an important distinction. The new price is based upon actual costs experienced and is completely unrelated to the old bid price. The typical discussion about “what’s different from the bid work and what number should be used to modify the bid price?” does not apply in this type of negotiation. The underrun compensation is an equitable adjustment, however, and much of the negotiation is related to the bid price and discussions of the actual work costs as opposed to the planned costs.

Other features of the provision include an exclusion of force account items and other items where an amount has been entered solely to provide a common proposal for the bidders. Consequential damages and lost profits are specifically excluded. The effect of any unbalanced allocation of overhead costs is also excluded from compensation under the provision.

Force accounts and calculated quantities are already taking actual costs into account for overruns. Because of the nature of these items, contractors are unable to allocate unavoidable fixed costs to them except as a share of the allowed markup. The contractor is aware of this provision at the time of bid and knows that this item will not be eligible for renegotiation in the case of an underrun.

Consequential damages are those which are separated from the project and which might be presented as part of a negotiation. “Because of your overrun, I was unable to start work on my other project and had to do that other work in the wintertime.” This consequence of the quantity variation is not compensable because of the wording of the provision. Similarly, the profit that the contractor might have made on some other work but for the need to perform the extra work in an overrun is also not compensable.

Unbalanced bidding might result in a significantly higher or lower price for an item than normal. It means that too much or too little of allocated overhead or other costs is assigned to the item. This is not a problem in a low bid situation when all items come in at plan quantity. The problem would arise if an unbalanced item were to be involved in an excessive underrun. This provision allows the Project Engineer to evaluate this possibility during an underrun negotiation (remember that the overrun pricing takes care of the problem automatically by assessing cost and ignoring the bid price.)

Contract time may be affected by the first unit of overrun or underrun. It may be appropriate to add or delete working days; depending on how the quantity variation affects critical activities, as shown on the Contractor’s approved progress schedule.

## B. Negotiation Guidelines

1. **Adjusted Final Quantity** – The *Standard Specifications* language is quite clear on this subject. Start with the final measured quantity, the number that would be included in the final estimate for the item. Review all change orders that have been approved and have been accepted by the Contractor (see *Standard Specifications* Section 1-04.5 for a definition of contractor acceptance of change orders.) Identify change order increases in the item and subtract these from the final measured quantity. Identify change order decreases in the item and add these to the result of the previous subtraction. The result of these calculations is defined as the Adjusted Final Quantity.

Compare the Adjusted Final Quantity to the original proposal quantity. If the Adjusted Final Quantity is greater than 1.25 times the original proposal quantity, then the item is eligible for an overrun renegotiation. If the Adjusted Final Quantity is less than 0.75 times the original proposal quantity, then the item is eligible for negotiation of an equitable adjustment due to underrun.

2. **Renegotiation for Overruns** – The first analysis should be to determine, if possible, where and when the overrun took place. This is not necessarily the work done after the quantity of 1.25 times proposal was reached. In many cases, a review of the work will disclose which part of the project actually experienced the low estimate and the resulting extra quantity. This is more common in physical items that are visible and can be measured by weight or physical dimensions (Roadway Excavation, Culvert Pipe, Select Borrow, etc.) These are often detailed in the plans to the extent that actual work can be compared with the relevant portion of the proposal quantity. When actual overrun work can be identified and when records exist showing the resources utilized for that work, then those records can form the basis for the revised payment amount. In other cases, the item is a support function, often measured by time, where the plan segments cannot be separated for analysis. This is common in Flagging, Pollution Control items, etc. To analyze these, the only choice is often to look at the actual work that occurred after the

threshold was reached and price it. A third method, where records are adequate, is to evaluate the actual costs for the entire item, and apply those only to the overrun units.

Regardless of method of determining direct cost, markups will be allowed. A good place to start would be the force account percentages described in [Standard Specifications](#) Section 1-09.6. If the contractor is providing other records for overhead and profit, these can be used, if they are reasonable. Any overhead items that are unavoidable, distributed fixed costs should be excluded. Remember that the Contractor has already been compensated for these one and a quarter times over.

The revised price will apply only to the units measured in excess of 1.25 times the original proposal quantity. The overrun units between the proposal quantity and the threshold will be paid, according to the terms of the contract, at the bid price.

3. **Equitable Adjustment for Underruns** – The adjustment for an underrun is limited by the contract terms to three factors. The first of these is an adjustment for any increase or decrease in direct costs that result solely from the reduction in quantity. The most common example of this type of cost is the learning curve. “By the time my crew learned how to do this work at this site with these specifications, we were done. They should have been able to apply these skills to an additional 30, 40, or 50 percent of the plan quantity. I experienced the least efficient units and missed out on the most efficient.” In negotiation, this might be demonstrated by production rates, by inspectors’ reports or by the agreed judgment of the negotiators. If such a condition did exist, then an agreed amount for inefficiency during the learning curve could be included in the adjustment.

The second factor has to do with the nature of the work actually done, when compared with the work shown in the plans. The most common manifestation of this is “You deleted the easiest units and left me with the most difficult,” or “You added units that were much more difficult than those shown in the plan.” Compensable, if true. Logic dictates that, if all of the work shown in the plans was performed and, if no work was added except by formal change order, then this factor can have no value. The work that was performed was what was shown in the plans and was what the Contractor bid. If, on the other hand, the project engineer has allowed constructive changes without formal documentation, then this factor could well come into play.

Finally, the negotiation should include a look at reallocation of undistributed unavoidable fixed overhead costs. The contractor has allocated these to 100 percent of the proposal amount. The bid price is firm as long as 75 percent of the units are measured and paid. If the final adjusted quantity is less than 75 percent, then the anticipated contribution of the units not performed (up to 75 percent) can be identified, negotiated and included in the equitable adjustment.

**One Final Aspect of Underruns** – There is a reality that, if more units were paid up to the 75 percent threshold, then there would be no eligibility for negotiation. Because of this, there is a limit to the equitable adjustment. The total paid for the item, including units actually performed and the equitable adjustment cannot exceed 75 percent of the original proposal quantity, multiplied by the unit bid price.



### **SS 1-04.7 Differing Site Conditions (Changed Conditions)**

There are two types of changed conditions. The first (Type I) is a hidden condition that is different from that indicated by the Contract (the borings do not show this rock). The second (Type II) is a hidden condition that is not shown differently in the Contract but is unusual and different from what a reasonably prudent Contractor would expect (i.e., “I’ve never seen this before and nobody else has ever seen it, either”). In either case, to qualify for renegotiation, the condition must have a “material” effect on the work. In other words, there must be a definable difference in the way the work will now be performed and that difference must be significant.

The contractual rules included in [Standard Specifications](#) Section 1-04.7 are related to fair notice and to giving the State an opportunity to examine the condition and, perhaps, order a different approach to the work. If the contractor takes away this opportunity, then there may be grounds for denying compensation for the different approach to the work. In some cases, the changed situation is not recognized until much or all of the work has been done. In that case, the determining factor for notice is the time when the Contractor knew or should have known of the condition. Whenever notice is served, it must be written.

Contractors work on tight schedules with one activity interdependent on others and it is not in the public interest to stop work while a changed condition discussion takes place. As soon as possible, to the extent possible, and in any manner which accomplishes the intent, the Project Engineer is expected to consult with the Region Construction Manager and the State Construction Office to obtain the approval before agreeing that a changed condition exists or before entering negotiations for price adjustments.

The Department response to a Contractor’s assertion of changed conditions, whether agreement or denial, must be written. The Project Engineer must keep accurate time and material records whether the response was negative or positive.

## **1-05 Control of Work**

### **SS 1-05.1 Authority of the Engineer**

The Project Engineer is designated as the Contracting Agency’s representative who directly supervises the engineering and administration of the construction Contract. This provides considerable authority to enforce the provisions of the Contract under [Standard Specifications](#) Section 1-05.1. This authority is tempered by WSDOT’s policies and delegation of authority from the State Construction Engineer to the Project Engineer. Accordingly, considerable care and professional judgment must be exercised by the Project Engineer in order to avoid exceeding the authority as delegated and to avoid decisions or actions that may be contrary to WSDOT policy. Should there be any doubts as to the limits of authority; the Project Engineer should consult the Regional Construction Manager.

In many cases the courts have held that where the Project Engineer has exceeded their delegated authority their actions are binding upon Contracting Agency. Because of this, it is important that the Project Engineer make no instructions, verbally or by written memoranda, that are outside of their authority.

The term Written Determination is defined in *Standard Specification* Section 1-01.3. It is important for the Project Engineer to understand that the Written Determination initiates most of the contractual timelines related to protests, disputes, delays, and Contract changes. It signals to the Contractor that they have limited time to protect their contractual rights by either accepting the Project Engineer's position, or by initiating a dispute or demand for additional compensation. A Written Determination must be transmitted to the Contractor by a letter or electronic mail, and it must be clearly identified as a "Written Determination".

### **SS 1-05.1(1) Oral Orders**

The Project Engineer may occasionally need to issue oral directions, instructions, interpretations and determinations in order to protect the traveling public or to avoid unnecessary delay to critical Work. While these circumstances are unavoidable, the Project Engineer should avoid giving oral orders, opting for other verifiable communication methods using a mobile electronic device or other means. If an oral order is given, the Project Engineer must send the Contractor a Written Determination within 3 days, documenting the order and specifying whether it constitutes a change to the Contract. Oral orders can be misunderstood or misinterpreted, making it crucial that the Project Engineer provide the order in writing so the Contractor may understand its rights and obligations under the Contract.

During the course of the project the Contractor may believe it has been given an oral order that changes the Work. *Standard Specification* Section 1-05.1(1) requires the Contractor to notify the Project Engineer within 3 days of receiving an oral order. Upon receiving this notification from a Contractor, the Project Engineer will provide a Written Determination within 14 days. Having notified the Project Engineer of an oral order in accordance with this section, the Contractor has preserved its rights to pursue a protest and dispute until the Project Engineer issues a Written Determination. The purpose of this procedure is to avoid misunderstanding between the parties, and to identify disagreements as early as possible.

If the Contractor disagrees with any Written Determination, it must follow the procedure for protest in Section 1-04.5.

### **SS 1-05.1(2) Requests for Information (RFI)**

The request for information is the procedure by which the Contractor may officially request an explanation or interpretation of the Contract. The Contractor is expected to notify the Project Engineer of ambiguities in the Contract as soon as they are discovered. Failure to do so may result in denial of any resulting claims. Requests for information must not be used as a means of providing notice of protest or notice of a differing site condition. RFIs should also not be used to request time extensions. However, the Contractor may submit an RFI for any of the reasons listed in the *Standard Specifications*. See Section 1-04.4(1) and 1-05.7 for more discussion on RFIs.

The Project Engineer has a responsibility for resolving ambiguities in a timely manner. Therefore, they must respond to a RFI within the timeframe provided in the Contract. If more than 14 calendar days are needed, because of the complexity of the RFI, they should notify the Contractor. Responses to RFIs are considered Written Determinations and any disagreement from the Contractor should follow the procedure for protest. Rejection or non-approval of a RFI that requests a change to the Contract is not subject to protest.

## Project Engineer's Relationship and Responsibilities

The Region will appoint a Project Engineer to act as the authorized representative of the Secretary of Transportation for each contracted project. To avoid Contract claims, the Region and Project Engineer must not negotiate Contract items with the Contractor until the Contract has been executed by WSDOT (see Section 1-03.3). Prior to execution, the Region and Project Engineer must keep communication with the Contractor to non-contractual items such as congratulations, general introductions, or directing them to CAPS Unit for execution questions.

After the Contract has been executed by WSDOT, the Region may provide the Contractor with written confirmation of the name and address of the Project Engineer assigned. (The Region may rely on the special provisions and forego this letter, unless a change is made.) If a letter is sent, the Contractor should be reminded to send all correspondence and forms regarding the project to the Project Engineer.

The Project Engineer is then responsible for enforcement of the Contract Specifications and provisions and the completion of all work according to the plans. The Project Engineer supervises the work of WSDOT personnel assigned to the project and ensures that they perform their work in accordance with the Plans, Specifications and all applicable WSDOT policies. The Project Engineer is responsible for keeping complete and accurate records of all construction data and work progress, preparing progress and final estimates, and preparing other records necessary for a complete documentation of the project, including a performance evaluation of the Contractor (see Section 1-00.9).

Changes made to the project or substitutions for work detailed in the contract plans or specifications, must be made in accordance with the requirements of [Standard Specifications](#) Section 1-04 and the guidance provided by [Section SS 1-04.4](#). The Project Engineer should review the project on a regular basis with the Regional Maintenance personnel so they have an opportunity to present any maintenance problems that may arise.

The Project Engineer must, at all times, stay aware of the design implications of actions taken during construction. Change orders and undocumented field adjustments can affect the design standards utilized. If change orders or field adjustments affect the project design criteria, the changes must be documented, approved, and incorporated into the Design Documentation Package. The Project Engineer shall contact the Region Project Development staff for guidance in documenting these design criteria changes. The Project Engineer should also consult with Region Environmental Permit Coordinators and Environmental Subject Matter Experts to make sure proposed design changes comply with environmental requirements.

### Responsibility as a Public Official

The Project Engineer is responsible for a project that is affected by Federal, State, Tribal, and local laws, ordinances, and regulations. While no one could be familiar with every requirement, the Project Engineer should seek to understand as much as possible. Beyond that, the prudent Project Engineer will look for guidance and seek information related to whatever current issue is at hand. Legal requirements could affect State employees, those employed by the Contractor in performing the work, the materials to be incorporated, the equipment that is used on the project, or could otherwise affect the conduct of work.

If the Project Engineer discovers that any provision of the contract, plans, or specifications appears to be inconsistent with a law, ordinance, or regulation, the inconsistency should be investigated and, if appropriate, referred to the Region Construction Manager. The Project Engineer should, at all times, strive to comply with all laws, ordinances, and regulations.

### **Relationship with the Contractor**

The Project Engineer must be familiar with the conditions of the contract, special provisions, and specifications for the work. The Project Engineer must attend to any reasonable request of the Contractor, i.e., furnishing grades, stakes, plans, whenever necessary and within reason. In general, the Project Engineer should do all things necessary to enable the Contractor to work to advantage and without delay. The Project Engineer should not set any stakes or furnish to the Contractor any plans which are the responsibility of the Contractor to set or provide. The Project Engineer must ensure that the Contractor performs the work in accordance with the contract provisions, plans, and specifications.

Integrity on the part of all employees is essential. The attitude of the Project Engineer and staff toward the Contractor and the Contractor's personnel should be one of cooperation, consistent with the requirements of the Specifications. It should be recognized that both the State and the Contractor have explicit rights under the Contract and that both parties must respect those rights. The Contractor is generally trying to complete the Contract as required. Errors or difficulties are usually due to a lack of information or misunderstandings. If conflict should occur, the Project Engineer should make every effort to determine the cause of the conflict and make appropriate corrections. The Contractor also has the responsibility, under 1-05.1(2) *Requests for Information*, to notify the Contracting Agency of ambiguities that exist in the Contract and should be encouraged to do so.

### **Relationship with Other Government Agencies**

Other agencies responsible for such things as flood control, land development, resource protection, stream navigation, or pollution may be affected by the work. The Project Engineer must ensure that the contractor follows the contract pertaining to these and other related issues. The Project Engineer is encouraged to obtain a copy of commitments from the project design file or other sources, like the Commitment Tracking System. This should be available from a region or project design office. This file should contain environmental permits/agreements, real estate commitments, utility commitments, design deviations, and other important information. When the Contractor is specifically required by the contract to obtain an approval document from other agencies, the Project Engineer must confirm that the document was received. Other approvals required of the contractor, but not mentioned in the contract documents should be confirmed to the extent that the requirements are known and the confirmation is possible. If a representative of an agency visits the project, the Project Engineer or an inspector should accompany the representative on the visit.

In carrying out construction work in forested areas, the Project Engineer should encourage the Contractor to comply with all Federal and State forest rules and regulations governing the protection of forests and the prosecution of the work within both national and State forests. The Contractor must take all precautions necessary to prevent and suppress forest fires. The Project Engineer shall report to the nearest forest fire warden at the earliest possible moment, the location and extent of any fire and shall take immediate steps to control the fire if practicable.

Construction work in or near streams, rivers, or other bodies of water may require a permit from state and federal agencies, including but not limited to the State Department of Fish and Wildlife, Washington State Department of Ecology, or the U.S. Army Corps of Engineers. The Project Engineer is encouraged to coordinate closely with these (and other) agencies during permit acquisition to ensure the permits don't contain conflicting conditions. Also, be sure to consult across agencies if one of these agencies request modifications to the project that may affect other permits. The Project Engineer should ensure that the provisions of environmental permits are rigidly enforced. If the Contractor's method of operations, weather conditions, design changes, or other factors affect waters of the state in ways not anticipated or represented in the permit, the Project Engineer will work with the Region Environmental Office and the Contractor (if necessary) to modify the existing permit(s) or obtain a new or revised one(s) as appropriate.

The U.S. Department of Labor, Mine Safety and Health Administration (MSHA) has jurisdiction over and inspects mine sites. A pit, quarry, or other aggregate production facilities may be considered a mine site and under the jurisdiction of MSHA. Testing facilities, personnel and equipment located within a mine site are subject to Title 30 Code of Federal Regulations Parts 46 Training and Retraining of Miners engaged in shell dredging or employed at sand, gravel, surface stone, surface clay, colloidal phosphate, or surface limestone mines and Part 56 Safety and Health Standards – Surface Metal and Nonmetal Mines. When possible, WSDOT-owned testing facilities should be located outside the fenced area of the mine. If testing facilities are located on mine property, they should be placed where other mine administrative offices are located.

Before entering a mine site, contact the operator of the site and request site-specific hazard-awareness training which should include what personal protective equipment is required. This training is required by Title 30 CFR for facilities under MSHA jurisdiction. WSDOT employees are not considered miners and therefore must be escorted to/ through the mine site by a Trained Miner when obtaining samples, as required by Title 30 CFR Part 46.

The U.S. Department of Labor, Mine Safety and Health Administration, Metal and Non-Metal Mine Health and Safety Division, 3633 136th Place SE, Suite No. 206, Bellevue, WA 98006, 206-553-7037, must be notified at the beginning and closing of all mining operations. This includes surface mining, such as our normal pit site operations. Notification is required for all crusher operations and for all pits and quarries, including borrow pits, which are separated from the roadway under construction. The owner, operator, or person in charge of the mine site is responsible for notification to MSHA for all mining operations; including those taking place in WSDOT furnished pits and must submit the required report as soon as the date of opening or closing can reasonably be determined.

Whenever construction work is performed in navigable waterways, it is necessary to obtain a construction permit from the Coast Guard. One of the requirements of the construction permit is regular submission of Bridge Construction Progress Reports. Two copies of the report should be prepared by the Project Engineer sufficiently in advance of the first working day of the month and transmitted to the State Bridge and Structures Engineer. When a Coast Guard permit modification is proposed (by the Contractor or WSDOT), it shall be submitted to the Bridge and Structures Engineer for processing through the Coast Guard. The time required for approval/disapproval of the proposed permit modification is variable and depends on the nature and significance of the modification. Up to six months may be required. When all construction obstructions to navigation have been removed, the Project Engineer shall report that fact immediately to the Bridge and Structures Engineer indicating the date removal was completed. Upon completion of all permitted bridge work, a final report indicating the date of completion and certifying that the bridge has been constructed in compliance with the Coast Guard Bridge Permit shall be submitted by the Project Engineer to the State Bridge and Structures Engineer.

### **Preconstruction Meetings, Discussions**

The Project Engineer is required to communicate with the Contractor for the purpose of discussing the project and exchanging a variety of information. Depending upon the complexity of the project, this information can be exchanged in any combination of the following methods:

- Information packets provided to the Contractor.
- Letters transmitting information.
- Informal meetings.
- A single multipurpose formal meeting.
- Several formal meetings with different purposes.

If the Project Engineer decides that a formal meeting is necessary in order to successfully begin work on the project, a meeting should be arranged as soon as practical after the contract is awarded and the Contractor has organized for the work.

In the case of a project that includes utilities to be adjusted, relocated, replaced or constructed by a utility, or their contractor, during the performance of the contract, the Project Engineer shall facilitate a mandatory utility preconstruction meeting with the Contractor, all affected utility owners and their contractors prior to any on-site work. The Project Engineer should request assistance from the Region Utilities Engineer for help in getting utilities to attend this meeting. This meeting should include a discussion of all utility work schedules, in order to enable the utilities and the Contractor to coordinate their work, resolve schedule conflicts, and eliminate delays.

In the case of a project that includes work on or near a reservation, the Project Engineer should notify the appropriate Tribe of the preconstruction conference and invite them to attend.

The Revised Code of Washington ([RCW 47.01.300](#) and [47.85.030](#)) requires that projects with environmental considerations be reviewed during the preconstruction meetings held with the contractor. The Memorandum of Agreement Concerning Implementation of Fish and Wildlife Hydraulic Code for Transportation Activities requires WSDOT to invite the Area Habitat Biologist for the Washington State Department of Fish and Wildlife

to all environmental preconstruction meetings. More information about discussing environmental topics at the preconstruction meeting is found in the [Chapter 600](#) of the [Environmental Manual](#). Verification of the Contractor's Certified Erosion and Sediment Control Lead (CESCL) is required when the project has obtained a NPDES Construction Stormwater General Permit See the [Department of Ecology CESCL Database](#) to verify CESCL credentials.

All information exchanged should be documented in the project records, by formal meeting minutes, or by file copies of letters.

The nature, amounts, and methods of communication with the Contractor are left to the Project Engineer. As a minimum, the following subject areas should be covered during the preconstruction time period:

- **Contractor WSDOT Relationships** – The Project Engineer should begin to develop a positive and effective relationship with the Contractor as soon as the contract is awarded. This is also a good time to introduce the concept of “Partnering” if it has not already been introduced on the project. The Project Engineer should strive to create an environment that encourages a cooperative approach to completing the project. This can be helped by beginning the development of a team consisting of both the Contractor's and WSDOT's project people. The level of authority delegated to each member of the Project Engineer's staff should be discussed with the Contractor. The level of authority of each member of the Contractor's staff, in particular regarding change orders, should be discussed. In addition, the methods of establishing the Contractor's Performance ratings can be reviewed (see Section 1-00.9 for additional information). The Contractor should also be informed that there is an opportunity to evaluate the WSDOT construction process as well.

Especially on projects with Contractor surveying, it is strongly advised to invite the Region Survey Committee member or their representative to discuss the requirements for removing, disturbing, or re-establishing survey monuments.

- **Environmental Commitments** – Almost every project will have environmental commitments resulting from, but not limited to: 1) environmental processes like the National Environmental Policy Act or the Washington State Environmental Policy Act; 2) consultations with Federal agencies concerning endangered species; 3) obtaining Federal, State, and local permits; or 4) existing inter agency agreements. WSDOT uses the Commitment Tracking System (CTS) to store project specific environmental commitments and to organize them by ownership; Contractor, WSDOT, or both. It is WSDOT policy to incorporate all Contract-relevant environmental commitments into the Contract. As a result, the Special Provisions and the Plans should contain all the Contract-relevant environmental commitments not covered by the [Standard Specifications](#). The Project Engineer is encouraged to review the Special Provisions and Plans with the Contractor at the preconstruction meeting. The Project Engineer should consider using relevant information from the Environmental Compliance Binder (See [Environmental Manual Chapter 600](#)) during the preconstruction meeting and throughout the project.

The Contractor's responsibility to obtain any local agency permits should also be discussed. For example if a rock crusher is required for a project, the State Department of Ecology registration requirements should be discussed ([WAC 173-400](#)). In addition, a written record of this discussion should be sent to the Regional Office of the State Department of Ecology so that they are aware of the timing and location of the rock crushing operation.

- **Order of Work and Time Schedules** – The Project Engineer needs to know the Contractor’s schedule of work in order to set up the crews, arrange for any special inspections, or provide timely reviews of submittals. The Contract requirements for progress schedule or time for completion in accordance with *Standard Specification* Section 1-08, or as amended by the Special Provisions, can also be discussed. When shown in the Plans, the first order of work shall be the installation of high visibility fencing to delineate all areas for protection or restoration. The Project Engineer should review the Plans at the preconstruction meeting to ensure these resources are not disturbed during clearing and grading activities. See the Temporary Erosion and Sediment Control Plan template located on the [Stormwater & Water Quality](#) page for the Project Engineer to ensure the clearing limits are properly marked in the field to protect sensitive areas.
- **Subcontractors and Lower-Tier Subcontractors** – In accordance with *Standard Specifications* Section 1-08.1, the Project Engineer needs to become aware of the Contractor’s plans to delegate portions of the work to subcontractors. These plans must conform to the condition of award, if any, related to underutilized disadvantaged business enterprise participation. The Project Engineer should explain the requirements and process involved for subcontractor and lower-tier subcontractor approval, including the prevailing wage rate requirements outlined in the contract documents (see Section [SS 1-07.9\(1\)](#)), the requirement to verify that each subcontractor meets the responsibility criteria outline in [39.04 RCW](#) and possesses any license required by [19.28 RCW](#) or [70.87 RCW](#), and the requirement that all subcontracts (of whatever tier) on Federal Aid contracts must include FHWA-1273 and Amendments to FHWA-1273. WSDOT/Contractor/Subcontractor relationships should also be discussed. The Project Engineer should remind the Contractor that there is no contractual relationship between WSDOT and the subcontractors. All subcontractor correspondence with WSDOT should pass through the Contractor for submittal to WSDOT or vice versa. Contractor representation should also be discussed. It will be necessary for the Contractor to be represented at the job site at all times, even when there is only subcontractor work in progress.
- **Utilities, Railroads, and Other Third Parties** – If the project affects or is affected by third party organizations, the Project Engineer must advise the Contractor about the relationships with the third parties and the expectations they hold regarding the actions of both WSDOT and the Contractor. The Project Engineer may wish to arrange face-to-face meetings with representatives of affected third parties. In the case of utilities, reference should be made to the underground locator services and the requirements to utilize them (see [RCW 19.122](#)). If WSDOT has agreed to notification time limits, these should be communicated to the Contractor. If special insurance is required by any agreements with third parties, then these requirements should be pointed out to the Contractor.

If utilities are to be adjusted, relocated, repaired or constructed by the utility during the performance of the contract, the Project Engineer shall facilitate a separate, mandatory, utility preconstruction meeting with the Contractor, the utility, and their contractors.

If public transportation agencies will be impacted, the Project Engineer will consistently supply information to WSDOT’s Construction Traffic Management team throughout the life of the project. Keep in mind that public transportation is not just fixed routes, but includes services for people with special needs, vanpools,



park and ride lots, and other ride-sharing services. Traffic hot spots and other traffic information is accessible at: [www.wsdot.wa.gov/construction/planning](http://www.wsdot.wa.gov/construction/planning)

- **Safety and Traffic Control** – The Contractor’s safety program should be discussed as outlined in [Section SS 1-07.1](#). WSDOT has an interest in safe operations on the job and the Project Engineer should make clear that this interest will be protected. As part of a discussion of specific safety requirements of the particular work, safety considerations for workers and WSDOT personnel, such as safety zone requirements, vehicle intrusion protection, fall prevention, closed spaces, hazardous materials, work around heavy equipment, etc., should be addressed. The need for control of speed on all construction equipment should be emphasized.

The Project Engineer should describe WSDOT’s traffic requirements. The Contractor’s Traffic Control Manager (TCM), Traffic Control Supervisor (TCS) and WSDOT’s traffic control contact person should be identified and their responsibilities and authorities clearly stated. Any traffic control requirements that are unique or restrictive should be emphasized and addressed by the Contractor with respect to construction operations. Unacceptable delays to traffic should also be discussed.

The MUTCD, as adopted by WSDOT, is the legal standard for all signing, traffic control devices and traffic control plan requirements on the project. These standards have been incorporated into the project Traffic Control Plans (TCPs.) If the Contractor chooses to use these TCPs, they must be formally adopted in writing as required in [Standard Specifications](#) Section 1-10.2(2). If the Contractor wishes to use some other traffic control scheme, then that plan must be submitted and approved in advance.

Flaggers and their intended locations must be included in the plans. When Flaggers are utilized, they must have a current flagging card and shall be equipped with hard hats, vests, and standard stop/slow paddles as required in [Standard Specifications](#) Section 1-07.8 and 1-10.3. Overuse of flaggers is not appropriate as “catch all” traffic control and should be discouraged. Safety of flaggers, through use of physical protection devices where practical, proper flagging methods and formulating an emergency escape plan, should be emphasized.

The Contractor and the Project Engineer should establish communication with the Washington State Patrol (WSP) and local law enforcement agencies. Law enforcement advice about traffic control should be considered. Arrangements for all law enforcement agencies to notify the Project Office about accidents near, or in, the construction area should be established, if possible. If WSP traffic control assistance is to be used, a general discussion of strategy and responsibilities should be included.

Off-site hauling can pose a safety hazard to the public. WSDOT will cooperate with law enforcement agencies in the enforcement of legal load limit requirements and the covered load regulations. The Project Engineer should discuss this with the Contractor before any hauling begins.

The Contractor should be reminded of [Standard Specifications](#) Section 1-07.1, requiring the Contractor to comply with all Federal, State, tribal or local laws, ordinances, and regulation that affect Work under the contract.

Particular mention should be made of observance of Industrial Fire Precaution Levels (IFPL) when performing work on or adjacent to forest land under the purview of the Department of Natural Resources (DNR). The Contractor is required to comply with all fire regulation including, but not limited to, fire shutdowns, fire fighting tools required, notifications, etc. Information regarding IFPLs may be found on the DNR webpage listed: <https://www.dnr.wa.gov/ifpl>

- **Control of Materials** – The Contractor should be reminded of [Standard Specifications](#) Section 1-06.1, requiring the Engineer’s approval of all materials prior to their use. In order to expedite these approvals, the Contractor should be encouraged to make these requests as early as possible. The Project Engineer should provide the Contractor with a current copy of the Record of Materials (ROM) for the project.

The Project Engineer should discuss the ROM with the Contractor, covering the various requirements for sampling, catalog cuts, shop drawings, certification requirements, etc., which may be needed for approval of materials prior to their use. If the project includes federal funds, the Project Engineer should discuss Build America/Buy America requirements and the need to submit DOT Form 350-109, and Certification of Materials Origin (Steel and Iron) and DOT Form 350-110 - Certification of Materials Origin - Required for Acceptance of Construction Materials. The requirements of [Standard Specifications](#) Section 1-06.2 for ongoing acceptance of approved materials prior to their being incorporated into the work, should also be discussed. The Project Engineer should discuss with the Contractor who should have access to the Statistical Acceptance of Material (SAM) program. If fabricated items will be needed, the inspection process for fabricated materials, including shop drawing approvals and notification requirements for fabrication inspectors, should also be outlined. The requirements of [Standard Specifications](#) Section 1-06.3 that require manufacturer certifications prior to use of the materials should also be reviewed.

The Contractor should be reminded that, in order to avoid deferred progress payments for portions of work not completed, all necessary documentation for approval of materials and required certifications must be received and accepted prior to their use. A method of notification of intent to defer payment should be discussed with the Contractor, and an agreed upon method documented in the project files.

- **Other Submittals** – Discuss any other submittals that may be needed during the course of the contract. This may include Falsework and Forming Plans, Traffic Control Plans, Temporary Erosion and Sediment Control Plans, Spill Prevention Control and Countermeasures Plans, Schedules, Installation or Operating Procedures, Temporary Stream Diversion Plans, Painting Plans, or other Contractor initiated items requiring WSDOT review and/or approval. There are requirements for a number of submittals which, if not satisfied in a timely manner, could delay the initial progress payment. These include the Statement of Intent to Pay Prevailing Wages, the Progress Schedule, and the Training Plan. There may be others depending on the work to be done and as required by the contract provisions. The Project Engineer should identify and remind the Contractor of these requirements and the potential for deferred payments.
- **DBE Participation/EEO/Training** – The Project Engineer should briefly discuss and answer any questions the contractor may have with regard to the efforts, reports, and monitoring necessary to ensure successful performance for DBE Participation, EEO, Apprentice Utilization, and Training. Section [SS 1-07.11\(2\)](#) of this manual provides a breakdown of these various programs and the general requirements each contains. However, the specific requirements and contractor performance information are included in the [Standard Specifications](#), the Amendments included in the contract, as well as the contract specific special provisions titled Equal Employment Opportunity Responsibilities. If additional assistance or information is necessary, the Project Engineer could also request assistance from the Region EEO Officer, the State Office of Equal Opportunity, or the State Construction Office.

- **Wage Rate Administration** – Advise the Contractor of the requirement to pay prevailing wage rates as identified in the Contract. Advise the Contractor that it is their responsibility to work directly with Washington State Department of Labor and Industries (LNI) for approval of the Statement of Intent to Pay Prevailing Wages (SOI) and Affidavit of Wages Paid (AWP) and that:
  - The SOI and AWP will be on forms provided by LNI.
  - The forms will be filed electronically using LNI's online system – Prevailing Wage, Intents and Affidavits (PWIA).
  - The contractors, subcontractors, lower-tier subcontractors, suppliers, manufacturers, and fabricators that are required to submit SOIs and AWP's will pay the approval fee directly to LNI.
  - The Contractor will submit a copy of the approved forms (SOI, before any payment can be made for work performed and all AWP's before the contract can be accepted) to the Project Engineer through PWIA.
  - If payrolls are required, establish submittal deadlines in accordance with [Standard Specifications](#) Section 1-07.9(5) and describe the wage rate interview process.
  - Describe the required and/or recommended job site posters and provide them to the Contractor (see Section [SS 1-07.9\(2\)](#)).
  - On all Federal-Aid contracts, the Project Engineer must remind the Contractor that the work falls under the guidance of Davis-Bacon and Related Acts and the Contract Work Hours and Safety Standards Acts. As indicated in Section [SS 1-07.9\(1\)](#), the U.S. Department of Labor may conduct investigations to ensure compliance with these Acts.
- **Forms** – The Project Engineer should provide the Contractor a description of all required forms, providing guidance on where the Contractor can find each - [www.wsdot.wa.gov/forms/pdfForms.html](http://www.wsdot.wa.gov/forms/pdfForms.html). Remind the Contractor that all form submittals, including those of subcontractors, lower-tier subcontractors, and suppliers, should be routed through the Prime Contractor for submittal to WSDOT.
- **Request for Information** – The Project Engineer should discuss the Request for Information (RFI) process as provided for in Standard Specification 1-05.1(2) and 1-05.7(1) to discuss the Contractor's responsibility in this process. The RFI process is a tool for documentation and communication between the Contractor and the Project Engineer but should not take the place of building a working relationship with the Contractor.

The Contractor is required to submit an RFI if they believe there is information missing or a clarification of the Contract is needed. At a minimum, the Project Engineer will communicate with the Contractor on a weekly basis the status of RFIs.
- **Summary** – While these issues are to be discussed with the Contractor in some manner at the beginning of each contract, the Project Engineer is free to select the most effective method of doing so. A formal preconstruction conference may or may not be the best solution. Perhaps a single meeting is adequate or several meetings may be required. The entire preconstruction communication may also be covered in a short meeting between the Project Engineer and the Contractor. The Project Engineer is responsible to address these subjects, inform the Contractor in some manner and maintain a written summary of the preconstruction meetings or discussions for the contract files.

The Contractor and Project Engineer may be knowledgeable about those normal requirements listed above. In this situation, some items need only be listed in a mailing as a convenience to the Contractor's staff. Unique features, constructability, and third party coordination should be focused on with as many of the interested parties as can be assembled.

The key is effective communication, getting the right message to the necessary people. Additional meetings may be required as people change, as new facets of the work become imminent, or as the project goes into a second or third season. In order to assist this process, a checklist has been developed as a tool for the Project Office's use. It can be used to help identify the issues and track them for completion through the various preconstruction communications.

### **SS 1-05.3 Plans and Working Drawings**

Working Drawings submitted by the Contractor must be reviewed and checked for conformance to Contract requirements by the Project Office. Submittals that are incomplete, not legible, or not in conformance with Contract requirements shall be rejected and shall not be distributed for review outside the Project Office. If the Contract submittal requirements require modification, the submittal cannot be submitted and reviewed until after a change order is processed revising the submittal requirements. A Change Order is required for any deviation from Contract requirements. Any conflicts with the Contract Plans that have been detected or revisions that may be desired by the Project Engineer should be noted on the copy being forwarded to Headquarters. If change orders to cover any deviations from the Contract Plans have been issued, or are being processed, those changes should also be noted and copies of the change orders shall be provided to the reviewers.

[Figure 1-1](#) is a list of the most common Working Drawings and includes references to the Specifications that require them and the Section of this manual that covers the procedures for processing them. The WSDOT Review Groups column identifies the groups within WSDOT that need to review the various Working Drawings. All review by State groups (Bridge Technical Advisor, Bridge Construction Support, Bridge and Structures Architect, Geotechnical Engineer, State Materials Laboratory and Assistant State Construction Engineer) identified in [Figure 1-1](#) is coordinated by the Bridge Technical Advisor or Bridge Construction Support. Submittals are coordinated by the Bridge Technical Advisor if they are listed as a review group in [Figure 1-1](#), and all other submittals are coordinated by Bridge Construction Support. Bridge Technical Advisor and Bridge Construction Support assignments and can be found here: [BTA List](#).

The Project Engineer should use DOT Form 410-025 to transmit the Working Drawings with State review requirements to the Bridge and Structures Office. The Bridge Technical Advisor or Bridge Construction Support will then send a response back to the Project Engineer that incorporates comments from all State review groups.

The Project Engineer should maintain a log of all shop plans or other drawings received for each contract. Shop plans for items that conform to the contract plans or a standard plan, except those listed in [Figure 1-1](#), should be reviewed by the Project Engineer.

Type 1 Working Drawings are generally informational in nature and are often used to provide the Project Engineer a description of work to be completed and allow the Project Engineer an opportunity to prepare for the inspection of this work. A Type 1 Working Drawing does not require a response to the Contractor. Should the Project Engineer determine the work proposed by the Contractor does not comply with the contract, a response should be sent to the Contractor. Type 2 and 2E Working Drawings are required for work that is more complex or specialized than what would be required for a Type 1 Working Drawing. A Type 2 Working Drawing is submitted to the Project Engineer for review and comment and will often be reviewed by support offices that specializes in the type of work. The Project Engineer is allowed up to 20 calendar days for review and the Contractor is not allowed to begin work until the Project Engineer has provided review comments. It is important that the Project Engineer complete the review and return comments, even if the plan is acceptable, to prevent a delay to the Contractor. Type 3 and 3E Working Drawings require WSDOT's approval prior to the Contractor beginning work, and the Project Engineer is allowed 30 calendar days to complete their review. For Type 3 and 3E Working Drawings, it is important that the Project Engineer complete the review and reply to the Contractor within the allowed 30 calendar days. Should the Project Engineer fail to complete the review and respond to the Contractor within the allowable time for the Type 2 or 3 Working Drawings, the Contractor may be entitled to compensation for impacts due to the delay.

At this time, not all sections of the [Standard Specifications](#) and Special Provisions have been updated to reflect the revisions to [Section 1-05.3](#). There will still be some sections that reference different requirements for the submittal and review of Working Drawings. The Project Engineer should review the Contract to confirm the proper Working Drawing requirements are being followed.

Comments on Working Drawings should be related only to conformance of the Working Drawing to the contractual requirements. Possible responses to Working Drawings include:

- Approved (only use for Working Drawings that require WSDOT approval)
- No exceptions taken
- Make corrections noted
- Revise and resubmit
- Rejected

Working Drawings that conform to the requirements of the contract will generally be returned as approved for Type 3 or no exceptions taken for Type 2. Working Drawings that don't comply with the contract will be returned with one of the other responses depending on the nature and severity of the contractual compliance issues.

Figure 1-1 Working Drawings, Shop Plans or Submittal Type

Working Drawing, Shop Plan, or Submittal Type	Construction Manual Reference	Standard Spec. or Other References	WSDOT Review Groups	PE Distribution of Drawings	Notes
Working Drawings (Shop Plans for Contract or Standard Plan Item)	SS 1-05.3	1-01.3	Project Engineer	Contractor Fabrication Inspector	
Calculations for Overload of Structure	None	1-07.7(2) 6-01.6	Project Engineer Bridge Construction Support	Contractor	PE stamp is required
Mfg. Specification for Portable Temporary Traffic Control Signal	None	1-10.3(3)K	Project Engineer	Contractor	
Prefabricated Vertical Drainage Wick Submittals	None	2-03.3(14)H	Project Engineer	Contractor	
Calculation for Backfilling Abutment Prior to Superstructure Placement	None	2-03.3(14)I	Project Engineer Bridge Technical Advisor Geotechnical Engineer	Contractor	PE stamp is required
Blasting Plan	None	2-03.3(2)	Project Engineer	Contractor	
Excavation Slope Working Drawings and Calculations	None	2-09.3(3)B	Project Engineer Geotechnical Engineer	Contractor	PE stamp is required for Temporary Slopes Greater than 20 ft in Height
Cofferdams, Shoring, Cribs, and Trench Boxes	6-1.5	2-09.3(3)D 2-09.3(4) 6-02.3(16)	Project Engineer Bridge Construction Support Geotechnical Engineer	Contractor Region Construction	PE stamp is required
Falsework, Forming, and Bracing Plans (including design calculations)	6-1.5	6-02.3(16) 6-02.3(17)F	Project Engineer Bridge Construction Support	Contractor Region Construction	PE stamp is required
Contractor Supplied Design Buried Structure Plans, Specifications and Calculations	None	6-20.3(2)A	Project Engineer Bridge Construction Support Geotechnical Engineer	Contractor Fabrication Inspection	PE stamp is required
Contractor Supplied Design Buried Structure Load Rating Report	None	6-20.3(2)B	Project Engineer Bridge Construction Support	None	PE stamp is required
Buried Structure Fabrication Shop Drawings	None	6-20.3(2)C	Project Engineer Bridge Construction Support Geotechnical Engineer	Contractor Fabrication Inspection	
Buried Structure Dewatering Plan	None	6-20.3(2)D	Project Engineer Geotechnical Engineer	Contractor	
Buried Structure Installation Plan	None	6-20.3(2)F	Project Engineer Bridge Construction Support	Contractor	PE stamp is required

Figure 1-1 Working Drawings, Shop Plans or Submittal Type

Working Drawing, Shop Plan, or Submittal Type	Construction Manual Reference	Standard Spec. or Other References	WSDOT Review Groups	PE Distribution of Drawings	Notes
Project Specific Powder Coating Plan and Materials Submittals	None	6-07.3(11)B	Project Engineer State Materials Engineer (Fabrication Inspection) Bridge Technical Advisor	Contractor Fabrication Inspection	
Bridge Demolition Plans	None	2-02.3(2)A	Project Engineer Bridge Construction Support Assistant State Construction Engineer	Contractor Region Construction	PE stamp is required
Shaft Installation Plan and Construction Experience for Bridges and Permanent Signing Structures	None	6-19.3(2)	Project Engineer Bridge Construction Support Bridge Technical Advisor Geotechnical Engineer Assistant State Construction Engineer	Contractor	
Precast Vaults	None	See Special Provisions	Project Engineer Bridge Technical Advisor	Contractor Fabrication Inspection	PE stamp is required
Pipe Jacking Plans	None	See Special Provisions	Project Engineer Bridge Construction Support Geotechnical Engineer	Contractor	
Soil Nail Walls	None	6-15.3(3)	Project Engineer Bridge Technical Advisor Geotechnical Engineer	Contractor Fabrication Inspection	Include State Const. Engr. if shotcrete facing is permanent (6-18.3(1)) Experience criteria to be verified by Project Engineer
Soldier Pile Walls	None	6-16.3(2)	Project Engineer Bridge Technical Advisor Geotechnical Engineer	Contractor	PE stamp is required for concrete fascia panel forming plans only.
Permanent Ground Anchor Submittals	None	6-17.3(3)	Project Engineer Bridge Technical Advisor Geotechnical Engineer	Contractor	
Roadside Plant/Weed and Pest Control Plan	None	8-02.3(2)	Project Engineer	Contractor Region Construction	Signed by Licensed Chemical Pest Control Consultant
Shop Plans for Light Standard and Traffic Signal Standards	8-20.2B	8-20.2(1)	Project Engineer Bridge Technical Advisor	Contractor Fabrication Inspection Maintenance	Shop drawings are required for all signal standards and for those light standards without pre-reviewed plans. (per Std. Spec)

Figure 1-1 Working Drawings, Shop Plans or Submittal Type

Working Drawing, Shop Plan, or Submittal Type	Construction Manual Reference	Standard Spec. or Other References	WSDOT Review Groups	PE Distribution of Drawings	Notes
Shop Plans for Sign Structures	8-21.3	8-21.3(9) A refers to Section 6-03.	Project Engineer Bridge Technical Advisor	Contractor Fabrication Inspection	
Column Jacket Shop Drawings and Installation Plans	None	GSP 6-02.3.OPT8(C). GB6 and 6-02.3.OPT8(D). GB6	Project Engineer Bridge Technical Advisor Geotechnical Engineer	Contractor Fabrication Inspection Maintenance	PE stamp is required on column jacket installation plan
Form Liners (Various patterns per GSP)	None	6-02.3(14)D	Project Engineer Bridge and Structures Architect	Region Construction Contractor	Include 2ft x 2ft sample with drawing to Bridge and Struct. Architect
Welding Steel Piling	6-5.6	6-05.3(6) 6-03.3(25)	Project Engineer Bridge Technical Advisor	Contractor Fabrication Inspection	Weld splices of steel casing for cast-in-place conc. Piles shall be the Contractor's responsibility
Pile Driving Equipment Adequacy Submittals		6-05.3(9)	Project Engineer Bridge Construction Support Geotechnical Engineer Assistant State Construction Engineer	Contractor	PE stamp is required on wave equation analysis
Painting Plan – Shop Application Powder Coating Plan - Shop Application	None	6-07.3(2) 6-07.3(11)B1	Project Engineer Bridge Technical Advisor Assistant State Construction Engineer State Materials Engineer (Fabrication Inspection)	Contractor	
Painting Plan – Field Application	None	6-07.3(2)	Project Engineer Bridge Technical Advisor Assistant State Construction Engineer	Contractor	
Modified Concrete Overlays (Mix Design, Equipment Specifications and Procedures)	None	6-09.3(2)	Project Engineer Assistant State Construction Engineer	Contractor	
Shaft Installation Plan for Noise Walls, Soldier Pile Walls, Signal Standard Foundations, and Luminaire Bases	6-2.3E	6-12.3(1) 6-16.3(2)	Project Engineer Bridge Construction Support Bridge Technical Advisor Geotechnical Engineer Assistant State Construction Engineer	Contractor	



Figure 1-1 Working Drawings, Shop Plans or Submittal Type

Working Drawing, Shop Plan, or Submittal Type	Construction Manual Reference	Standard Spec. or Other References	WSDOT Review Groups	PE Distribution of Drawings	Notes
Structural Earth Wall Submittals	None	6-13.3(2)	Project Engineer Bridge Technical Advisor Geotechnical Engineer	Contractor	PE stamp is required
Geosynthetic Retaining Wall Plans (Includes Std. Plan Type 1-6 Walls)	None	6-14.3(2)	Project Engineer Bridge Technical Advisor Geotechnical Engineer	Contractor	
Girder Erection Plans (Including falsework and stress calculations)	None	6-02.3(16) 6-02.3(25)N 6-03.3(7)A	Project Engineer Bridge Construction Support	Contractor Region Construction	PE stamp is required
Welding Reinforcing Steel	6-2.6D	6-02.3(24)E	Project Engineer Bridge Technical Advisor	Contractor Fabrication Inspection	
Shop Detail Plans of Prestressed Concrete Girders, Prestressed Structures, Prestressed and Precast Conc Piles	6-2.7A	6-02.3(25)A None for Piles	Project Engineer Bridge Technical Advisor	Contractor Fabrication Inspection	6-02.3(16)B is for the formwork plans for preapproval
Post-Tension Shop Drawings	6-2.8	6-02.3(26)A	Project Engineer Bridge Technical Advisor Assistant State Construction Engineer	State Construction Engineer Contractor Region Construction	PE stamp required
Precast Concrete Panels	None	6-02.3(28)A 6-12.3(1)	Project Engineer Bridge Technical Advisor	State Construction Engineer Contractor Fabrication Inspection	
Welding Structural Steel (Submitted with Shop Drawings)	6-3.6C	6-03.3(25)	Project Engineer Bridge Technical Advisor	Region Construction State Materials Lab Contractor	
Bird Protection Plan	None	GSP 1-07.5(4)	Project Engineer WSDOT Project Biologist	Project Engineer Project Inspector	Contact your Environmental Coordinator to provide a contact name for your WSDOT Project Biologist if needed

## SS 1-05.4 Conformity with and Deviations from Plans and Stakes

### Permanent Monuments

Most permanent monuments which are in the construction zone are relocated by the establishing agency. Normally these monuments are relocated prior to beginning of construction, but if monuments are found within the construction zone, they must be preserved until they can be moved. If the urgency of construction does not allow time for the relocation of the monument, it must be properly referenced so it may be reset or relocated at a later time. When a monument is found within the construction area, the proper agency shall be notified promptly and requested to relocate the monument.

### Property Corner Monuments and Markers

It is imperative that land plats and property corners be preserved. The 1973 Legislature enacted a Survey Recording Act, [RCW 58.09](#), to provide a method for preserving evidence of land surveys by establishing standards and procedures for monuments and for recording surveys as a public record. When a general land office corner, plat survey corner, or property line corner exists in the construction zone, it is necessary to properly reference it and reset it after the construction work has been done. [RCW 58.09.040](#) requires that, for all monuments that are set or reset, a record of the monument be filed on a Monumentation Map with the County Engineer in the county in which the corner exists and the original sent to the State Right of Way Plans Branch, who will forward a copy to DNR for their records.

### Alignment Monumentation

During construction, alignment monumentation may be altered to fit field conditions. Such changes may include:

- Normally all PCs and PTs are to be monumented. Additional point on tangent (POT) monuments are necessary where line of sight is, or may in the future be obstructed by the horizontal or vertical alignment, buildings, or other barriers.
- When the right of way and the construction alignment do not coincide, the monumentation shall be such that the exact right of way as acquired can be positioned in the field. This will generally require, as a minimum, that the right of way alignment be monumented.
- When safety of the survey crew or survival of the monuments is an issue, monuments may be offset from the true alignment. An extra effort in accuracy must be made when setting offset monuments to ensure an accurate reestablishment of the true alignment. The monumentation, including monument locations, reference distances, stations, and bearings, is to be shown on the as built plans.

### Surveying Provided by the State

Unless the contract states otherwise, the Project Engineer is responsible for providing all surveying needed to locate and define the contract work. The staking done in construction surveying must assure that the work will conform to the plans and must also conform to the Contractor's approach to the work. There are numerous survey techniques that will accomplish these objectives. Prior to each phase of the work, the Project Engineer must reach agreement with the Contractor concerning the method, location, and timing of construction staking. Once this agreement is reached, it must be shared with all WSDOT, Contractor, and subcontractor personnel who place or use construction stakes.

## Contractor Surveying

If the contract requires the Contractor to provide some or all of the construction surveying, the Project Engineer is required to provide only the primary control points staked, marked, and verified in the field and the coordinate information for the main alignment points in the plans. The plan alignment and the field control points must be referenced to the same grid coordinate system.

The provisions for contractor surveying are intended to provide the stakes needed to inspect the work, as well as the primary function of locating and defining the work. If the survey stakes required by the contract do not provide the reference data needed for inspection, then the Project Engineer will have to provide additional survey work that is needed. As an alternative, a change could be negotiated with the Contractor to perform the added work.

The Contractor's survey work is a contract item, just like all other contract items. It must be inspected for adequacy and conformance with the contract. Once it is performed and inspected, it must be paid for.

The wise Project Engineer will inspect the survey efforts and check as much of the contractor's work as is practical. Any errors should be brought to the Contractor's attention for corrective action. The inclusion of contractor surveying in a project transfers the risk of survey errors to the Contractor. The Project Engineer must assure that the survey work of the Contracting Agency does not relieve the Contractor of that risk.

## Subgrade Grade Control Tolerance

The finish required on roadway subgrades shall ensure a final grade in as close conformity to the planned grade and cross-Section as is practicable, consistent with the type of material being placed. Subgrade blue tops shall be set 0.05 ft below subgrade elevation and be accurate to + or - 0.01 ft. The finished subgrade surface shall not deviate from the plan subgrade elevation by more than +0.00 to -0.05 ft. Where excessively rocky materials are being placed, deviations in excess of the above may be accepted where, in the opinion of the Engineer, closer conformance cannot be achieved by normal procedures and with a reasonable amount of effort and care on the part of the Contractor. Conformance to grade shall be checked by rod and level, straight-edging, or other appropriate engineering method as selected by the Engineer.

## Surfacing Grade Control Tolerance

Red and Yellow tops for surfacing materials shall be set accurate to + or -0.01 ft. The finish of the compacted materials shall conform to the grade established by the blue tops as closely as is practicable and in general, should not deviate from the established grade in excess of the following: ballast and base course, + or - 0.05 ft; top course for bituminous surface treatment, + or - 0.03 ft; top course for asphalt concrete, + or - 0.02 ft; surfacing under treated base course, + or - 0.03 ft; treated base under Portland cement concrete pavement, + 0.00 to - 0/02 ft.

Conformance should be checked by use of rod and levels from blue tops and/or by string-line or straight edge methods as determined appropriate by the Engineer. The above schedule refers to conformance both longitudinally and transversely to the traveled way. The outer shoulder line finished grades shall not exceed double the deviations outlined for the traveled way.

In the event that additional blue tops are not set for setting grade of surfacing courses, the grade of the surfacing shall be referenced to the earthwork subgrade blue tops and adequate controls shall be used to ensure the placement of the required thickness of surfacing and a final surface meeting the requirements outlined above.

### Inspection of Course Thicknesses

Tabulated below are the permissible deviations in measured thickness for specified depths of surfacing and paving. While these are the maximum deviations that can be allowed, the Project Engineer may impose tighter requirements for conforming to the plan dimensions where there is a reason to do so.

Material	Specified Depth	Max. Allowable Deviation at Any One Point	Average Depth Deviation for Entire Project
Untreated Surfacing	0 - 0.25'	-0.05'	-0.025'
	0.26 - 0.50'	-0.06'	-0.03'
	0.51 - 0.75'	-0.07'	-0.035'
	0.76 - 1.0'	-0.08'	-0.04'
	Over 1.0'	-8%	-4% Hot
Mix Asphalt (HMA) (single-lift) (multi-lift)	0.08 - 0.15'	-0.045'	-0.015'
	0.00 - 0.25'	-0.03'	-0.01'
	0.26 - 0.50'	-0.045'	-0.015'
	0.51 - 0.75'	-0.06'	-0.02'
	Over 0.75'	-0.075'	-0.025'

For HMA overlays with a specified depth of less than 0.08 ft, it will be the responsibility of the Project Engineer to ascertain the adequacy of the overlay depth in conformance to the plan.

### SS 1-05.7 Removal of Defective and Unauthorized Work

Contract Final Acceptance for all work completed on a project is made solely by the Secretary of Transportation acting through the State Construction Engineer. However, the Engineer relies heavily on the actions and professional opinions of others, involved throughout the course of work, in determining acceptability. Because of this, it is expected that the Project Engineer, working with the assistance of the Regional Construction Manager, as well as making full use of the many resources available at both the Regional and State level, particularly the office of the State Construction Engineer, will ensure that sufficient inspection is conducted in order to determine that the work performed or the materials utilized to construct the project comply with the requirements included in the contract plans and specifications. When inspections or tests are performed that indicate substandard work or materials, the Project Engineer should immediately notify the Contractor, rejecting the unsatisfactory work or material.

The following types of activities will be considered unauthorized Work and will be completed solely at the risk and expense of the Contractor:

- Work performed contrary to, or regardless of, the instructions of the Project Engineer.
- Work and materials that do not conform to the Contract requirements.
- Work done beyond the lines and grades set by the Plans or the Engineer.
- Any deviation made from the Plans and Specifications without written authority of the Project Engineer.

The Contractor is responsible for notifying the Project Engineer of any defective Work they discover. If the Project Engineer becomes aware of defective or unauthorized Work, they should first notify the Contractor. The Contractor should be notified as quickly as possible so that changes in materials or Work methods can be made to avoid materials or Work being rejected.

Until all issues of material acceptance and conformity to the Contract Plans and Specifications can be resolved, unauthorized or defective Work will not be paid for by WSDOT.

Once the unauthorized or defective Work has been discovered or the Contractor has been notified, the Contractor must immediately correct the deficiency. *Standard Specification 1-05.7(1)* provides the Contractor an option to submit an RFI to propose a repair procedure or method for correcting a deficiency. An RFI should be submitted when the repair would constitute a change to the Contract, or when the Contract does not include a specified remedy for the defect. The Project Engineer should ensure the Contractor has provided all the information needed to respond to the request and will discuss the request with the Contractor prior to providing a final response. Any engineering necessary to evaluate the acceptability and adequacy of the repair should be done by the Contractor and submitted to the Project Engineer with their RFI. All RFIs for repairs or corrections are considered Contractor-proposed changes and WSDOT is under no obligation to accept or approve them.

Alternately, the Project Engineer may direct that all unauthorized or defective Work be immediately remedied, removed, replaced, or disposed of. If the defective Work is replaced with Work meeting the Contract requirements, approval from the Project Engineer is not needed, nor is an RFI.

In correcting unauthorized or defective Work, the Contractor will be responsible to bear all costs to comply with the Engineer's order.

For additional guidance, see [Standard Specifications](#) Section 1-05.7. If the Contractor fails or refuses to carry out the orders of the Engineer or to perform Work in accordance with the Contract requirements, the Project Engineer should immediately notify the Regional Construction Manager of the facts in the matter, seek assistance and advice.

## Defective Materials

The contract plans and specifications for construction of a project require that specific materials and/or work practices be utilized in completing the work. The Project Engineer may reject any materials not conforming to the requirements of the specifications. The rejected materials, whether in place or not, are to be immediately removed from the site of the work unless the following guidelines for acceptance of non-specification materials are followed:

### Material Not in Place

There may be situations where WSDOT determines the use of nonconforming materials is acceptable. This requires prior approval of the State Construction Engineer and a change order modifying the project specifications.

The Contractor is required to submit an RFI as provided for in *Standard Specification 1-05.1(1)* for any material substitution. The Project Engineer will discuss the request with the Contractor prior to providing a final response to the RFI. If this is not done prior to incorporating into the project, the material should be treated as defective or unauthorized Work.

## Material in Place

1. Price adjustments have been developed and are referenced in the contract for acceptance of certain materials whose properties cannot be determined until they are in place. Items this policy applies to include: concrete compressive strength, Portland cement concrete pavement thickness, hot mix asphalt mixture and density, and pavement smoothness.
2. Material incorporated into the Work that is subsequently found to be in non-conformance with the Specifications and for which price adjustments for acceptance are not included in the Contract, may be reviewed to determine acceptability. The determination of acceptability should be made only when, in the Project Engineer's judgment, there is a possible service or benefit to be obtained from its use. If it is determined that no benefit or service is obtained from the material's use, the Project Engineer should direct that the material be immediately removed and replaced at no cost to WSDOT.

The Project Engineer may consult the State Construction Office, State Materials Laboratory, the State Bridge and Structures Office, or other design organizations for assistance in determining the usefulness of the nonconforming material. If consulted, these offices will offer technical advice to the extent that information is available. It is not intended to enter into extensive research to assess material which could be removed and replaced under the contract terms.

If the material is acceptable for continued use, a determination shall be made by the Project Engineer of the possible reduced service life caused by the material substitution and the resulting credit assessed by change order.

This determination of acceptability and the resulting credit must meet with the Region Construction Manager's approval for execution of the change order. In addition, prior review and approval must be obtained from the State Construction Engineer with a recommendation from the State Materials Engineer for the intended application of the material. With this determination for acceptance of non-specification material, discussions should be initiated with the Contractor and a change order completed.

If it is determined that the Specification violation will not compromise the performance of the material and the nature of the violation is more of a technical infraction of the Specification, the material may be accepted with a change order, possibly including a price reduction. If there is sufficient data and if the nature of the material makes analysis feasible, a pay factor may be determined using QC/QA methods similar to those described in [Standard Specifications](#) Section 1-06.2(2). If QC/QA cannot be applied, the Project Engineer may determine an adjustment subjectively, using whatever information is available. This assessment or price adjustment is typically based on the unit bid price and may vary from no price adjustment up to the total contract unit bid price for the item involved. If it is determined that the violation is serious enough that the material cannot be accepted for use on the project, the Project Engineer may direct its complete removal and replacement at no cost to WSDOT.

All change orders for acceptance of nonconforming materials are Contractor proposed and WSDOT is under no obligation to accept or approve any of them.

### **SS 1-05.9 Equipment**

The Contractor is required to furnish adequate equipment for the intended use. The Contractor's equipment must also be maintained in good working condition. Prior to the start of work, the Project Engineer should ensure, by inspection, that the Contractor's plant, equipment, and tools comply with the specifications.

Whenever the specifications contain specific equipment requirements, the Project Engineer should verify that the equipment provided meets these specifications. This should be documented in project records such as the Inspector's Daily Report. The Contractor is required to furnish, upon request, any manuals, data, or specialized tools necessary to check the equipment.

It is most important that the operation of automatically controlled equipment be checked carefully and that the Contractor be advised immediately whenever the equipment is not performing properly.

The Contractor's supervisory personnel must be experienced, and able to properly execute the work at hand. If, in the Project Engineer's opinion, the Contractor's supervisory personnel are not fully competent, the Project Engineer should immediately notify the Regional Construction Manager of the facts in the matter, seeking assistance and advice.

It is expected that, consistent with WSDOT's policies and delegated authority, the Project Engineer will assist the Contractor in every way possible to accomplish the work under the contract. However, the Project Engineer must not undertake, in any way, to direct the method or manner of performing the work. Contrary to popular legend, this statement is true of force account work as well. Should the Contractor select a method of operation that results in substandard quality of work, non-specification results, a rate of progress insufficient to meet the contract schedule, or that otherwise violates the contract specifications or provisions, the Contractor should be ordered to discontinue that method or make changes to comply with the contract requirements. Where cooperation cannot be achieved, the Project Engineer should notify the Regional Construction Manager of the facts in the matter, seeking assistance and advice.

### **SS 1-05.10 Guarantees**

*Standard Specifications* Section 1-05.10 and 1-06.5 specifies the Contractor shall provide to the Project Engineer all guarantees, warranties, or manuals furnished as a customary trade practice, for material or equipment incorporated into the project. The Project Engineer should transmit the originals of any such guarantees/warranties or manuals to the organization that will be maintaining the items covered by the guarantee/warranty or manuals. The Project Office should maintain a copy of the guarantee/warranty, and a letter of transmittal for manuals, with the materials documentation file for the project.

### **SS 1-05.14 Cooperation with Other Contractors**

When two or more Contractors, including any utility or their contractor, are working in the same area, [Standard Specifications](#) Section 1-05.14 will apply. The Contractor shall not cause any unnecessary delay or hindrance to the other contractors on the work, but shall cooperate with other contractors to the fullest extent. Progress schedules and plans for all contractors involved should be reviewed by the Project Engineer to detect possible conflicts which might be resolved before a delay of work is experienced or extra costs are incurred as a result. If an adjacent project requiring coordination is known prior to holding a pre-construction meeting, it would be beneficial to invite principals from that project to the meeting.

## **1-06 Control of Material**

### **SS 1-06.3 Manufacturer's Certificate of Compliance**

All material is to be accepted for use on the project based on satisfactory test results that demonstrate compliance with the contract plans and specifications. All work demonstrating compliance is to be completed prior to the material's incorporation into the work. In many cases, this testing has already been completed in advance by the manufacturer. A Manufacturer's Certificate of Compliance provides a means to utilize this testing in lieu of job testing performed prior to each use of the product. This provides for a timely use of the material upon arrival to the job site without a delay in waiting for the return of test results. The Project Office is required to complete and file a Manufacturer's Certificate of Compliance Check List (DOT Form 350-572). This must be done in a timely manner and is necessary to ensure that the material meets all the requirements of the contract.

[Standard Specifications](#) Section 1-06.3 describes the procedures for acceptance of materials based upon the Manufacturer's Certificate of Compliance. [Standard Specifications](#) Division 9 describes those materials that may be accepted on the basis of these certificates. Since a certificate is a substitute for prior testing, it is intended that all certificates be furnished to the Project Engineer prior to use or installation of the material.

However, there are some circumstances where the Contractor may request, in writing, the Project Engineer's approval to install materials prior to receipt and submittal of the required certificate. The Project Engineer's approval of this request must be conditioned upon withholding payment for the entire item of work until an acceptable Manufacturer's Certificate of Compliance is received. Examples of materials that shall not be approved by the Project Engineer for installation prior to the Contractor's submittal of an acceptable certificate are: materials encased in concrete (i.e., rebar, bridge drains); materials under succeeding items where the later work cannot be reasonably removed (i.e., culvert under a ramp to be opened to traffic); etc. The Project Engineer's approval or denial shall be in writing to the Contractor, stating the circumstances that determined the decision. If the requirements of this provision are followed, including the written request by the Contractor and the written approval by the Project Engineer, then the remedy for failure to provide the Certificate is the withholding of 100 percent of the cost of the material and the cost of the work associated with the installation of the material.



At the conclusion of the contract, there may still be some items that are lacking the required certificates. These items must be assessed as to their usefulness for the installation, prior to payment of the Final Estimate and subsequent Materials Certification of the contract. The review of these items may include:

- Comparison with the suitability of other shipments to the project or other current projects.
- If possible, sampling and testing of the items involved or residual material from the particular lot or shipment.
- Independent inspection on site of the completed installation.

If it is determined that the uncertified material is not usable or is inappropriate for the completed work that incorporates the material, the Contractor should be directed to immediately remove the material, replacing it with other certified materials. If the material is found to be usable and is not detrimental to the installation it was incorporated into, it may be left in place but, if the provisions of *Standard Specifications* Section 1-06.3 were followed, with a reduction to no pay. The reduction in pay will be the entire cost of the work (i.e., unit contract price, portion of lump sum) rather than only the material cost. The Contractor should continue to have the option of removing and replacing the uncertified material in order to regain contract payment for the installation. If the provisions of *Standard Specifications* Section 1-06.3 were not followed, then there can be no withholding beyond the value of the missing work itself (the preparation and submittal of the Certificate.)

## **SS 1-06.6 Recycled Materials**

### **SS 1-06.6(1) Recycling of Construction Aggregate and Concrete Materials**

Engrossed Substitute House Bill 1695 requires the use of recycled concrete aggregate in the amount of 25 percent on all WSDOT projects, and to report annual usage to the legislature. However, this requirement only applies to materials included in the Contract that are listed in *Standard Specifications* 9-03.21(1)E and that allow the use of recycled concrete aggregate.

Recycled concrete is hardened concrete that is crushed and may contain coarse and fine mineral aggregate with Portland cement. The *Standard Specifications* encourage the use of recycled materials and requires that recycled concrete aggregates be incorporated into the work by the Contractor.

Because it is important that the Contractor have a plan for using the required percentage of recycled concrete aggregates, the *Standard Specifications* require the Contractor to submit a utilization plan. The Contractor's Recycled Concrete Aggregate Utilization Plan is to be submitted on DOT Form 350-075A – Recycled Concrete Aggregate Reporting - within 30 calendar days of Contract Execution, preferably at the Pre-Construction Conference.

The recycled concrete aggregate utilization plan details how the Contractor will meet the 25 percent requirement. Each bid item that includes eligible material will be listed on the utilization plan and will include the percentage of anticipated recycled concrete aggregate that will be used. If the plan shows the Contractor will not meet the minimum 25 percent requirement, a cost estimate meeting the requirements of *Standard Specification* 1-06.6(1) A must be attached. The details of the plan are not required to be static as the Contractor should be actively managing their use of recycled concrete aggregate throughout the

Contract. Therefore, the Contractor may alter the utilization plan at their discretion without submitting a new one. Should the Contractor alter their plan, the Project Engineer may choose to review it.

Within 30 days after Physical Completion, the Contractor is required to re-submit the Recycled Concrete Aggregate Reporting form (DOT Form 350-075A) to include the actual amounts of recycled concrete aggregate and virgin material used on the project. If the final tally of recycled concrete aggregate does not meet the 25 percent requirement, the Contractor is required to attach a cost estimate meeting the requirements of *Standard Specification 1-06.6(1)A*. The Project Engineer should review the cost estimate for reasonableness; an independent verification of detailed costs is not required as the Contractor certifies the accuracy of the information.

The Project Engineer shall submit the Recycled Concrete Aggregate Reporting form to the Region Documentation Engineer for their review and approval prior to a copy of the form being sent to the Documentation Engineer at the State Construction Office. These reports will be used by the State Construction Office in the annual report submitted to the legislature.

## 1-07 Legal Relations and Responsibilities to the Public

### SS 1-07.1 Laws to be Observed

#### Safety

Safety is not optional in WSDOT. No employee will be permitted to disregard applicable safety and health standards of the State Department of Labor and Industries or other regulatory agencies.

The Secretary of Transportation's Executive Order E 1033 provides direction to all WSDOT employees to adhere to the following basic safety provisions in every work activity:

- Participate in your work group safety plan (or Safety Management System for WSDOT Ferries Division employees).
- Look for ways to prevent accidents.
- Immediately identify hazards and safety concerns.
- Always use personal protective equipment.
- Promptly report all injuries.

The Order also states that all employees at WSDOT Ferries Division are already covered and shall continue to be covered by the existing Ferries Division Safety Management System. Therefore:

- All Ferries Division employees will refresh their knowledge of existing Safety Management System procedures and shall follow them accordingly.
- A concerted effort will be made to address existing and new Safety Management System safety reports in a timely manner.
- All Ferries Division employees shall address issues of concern with existing safety procedures using the existing Safety Management System reporting program.

All other WSDOT employees are covered and continue to be covered by the policies and procedures in the [Safety Procedures and Guidelines Manual M 75-01](#), and other related policy documents. Therefore, a pre-activity safety plan is required prior to performing any new field work. Office staff will conduct a hazard assessment and mitigation plan for all office environments.

Since WSDOT employees on transportation construction projects are routinely exposed to a variety of hazards, they must take adequate safety precautions at all times. The following items represent common activities that workers or work crews may encounter, and should be addressed in pre-activity safety plans as needed.

- The employee shall ensure that an area is safe before entering it for the purpose of inspection. For example, a deep trench must be adequately shored and braced before entering it.
- Aggregate production and material processing plants should be inspected for safety hazards. Corrective measures should be called to the attention of the Contractor or producer. Corrections must be completed before WSDOT personnel will be permitted to proceed with entry or work upon the premises.
- The employee must, at all times, watch for backing trucks and not depend upon hearing alone for warning. The noise of plants and other equipment often make it impossible to hear trucks approaching and the truck driver's vision area is restricted when backing a truck.
- Parking WSDOT vehicles too close to the path of construction equipment, behind standing equipment, or in other hazardous locations is not permitted.
- Where traffic is maintained in work zones, care must be taken to avoid approaching traffic when it is necessary for inspectors and others to step onto or cross the traveled portion of the roadway. Whenever possible, work activities, ingress and egress, should be conducted within the relative safety of the work zone.
- WSDOT employees working on foot in the highway right of way and other areas exposed to vehicular traffic must comply with the high visibility clothing requirements of the WSDOT [Safety Procedures and Guidelines Manual M 75-01](#) Section 4.2, Chapter 3.
- Where the engineering crew is working adjacent to traffic, without positive barriers, the work area should be marked with proper signs and traffic control devices as shown on the appropriate Traffic Control Plan (TCP). The crew may be protected by a certified flagger as needed.
- When the engineering crew is working under the protection of the Contractor's flaggers and signs, other signs may not be needed, but a "STOP"/"SLOW" paddle should be available for use in special situations. Good communication with the Contractor and Flagger is needed to ensure that they are aware of crew activities within the work zone.
- A survey crew is typically exposed to traffic hazards and should conduct survey work under approved TCPs from the *Work Zone Traffic Control Guidelines M 54-44*. The Region Traffic Office will assist survey crews with TCPs for situations not covered in this publication.
- During blasting operations, employees are instructed to seek cover at least 500 ft from the location of the blasting.

In addition to the above requirements for workers and work crews, supervisors also have the following responsibilities:

- Each supervisory employee is charged with the responsibility of providing safety leadership and safety enforcement when necessary.
- Supervisors shall give thorough instructions to employees under their jurisdiction on the safe use of tools, materials, and equipment and the safe prosecution of work on construction projects.
- The Division of Occupational Safety and Health requires that every foreman, supervisor, or other person in charge of a crew have a valid first aid card.
- When employees are injured on the job to the extent that the services of a doctor are required, the Regional Safety Officer shall be notified immediately.
- When traffic control measures are necessary, approved Traffic Control Plans (TCPs) should be used in conformance with the *Manual on Uniform Traffic Control Devices* (MUTCD), as adopted by WSDOT. Supervisors should ensure that the appropriate TCP is used and that the necessary signs, devices and equipment are available. Contact Region Traffic Office for assistance.

### **Responsibility for Enforcement of Safety and Health Requirements**

All contractors doing work for WSDOT must provide safety controls for the protection of life and health of the Contractor's employees and other persons, for the prevention of property damage, and for the avoidance of interruptions in the performance of the work under the contract. As the owner contracting agency, WSDOT has the responsibility for enforcement of the provisions of the contract, however, provisions and regulations which are by law the fundamental responsibility of other agencies, both from the standpoint of interpretation and enforcement, should be monitored by WSDOT, but with full recognition as to the responsibilities and authorities of those agencies. The Project Engineer will cooperate fully with the responsible agency.

Any violations noticed by the Project Engineer will be brought to the attention of the Contractor for correction. The Project Engineer will also notify the responsible agency (if that action is deemed necessary by the Region Construction Manager) and utilize such sanctions as are consistent with contract terms in assisting the responsible agency in enforcing laws, rules, and regulations.

The Contractor is obligated by law to comply with both State and Federal safety regulations. State regulations are administered by the Washington State Department of Labor and Industries under the Washington Industrial Safety and Health Act (WISHA). Federal regulations are administered by the Occupational Safety and Health Administration (OSHA) and the Mine Safety and Health Administration (MSHA) of the U.S. Department of Labor, which has jurisdiction over federal safety requirements for pit and quarry operations up to the point where materials leave the quarry area or go into a batch plant. Inspectors from any or all of these agencies may review the Contractor's operations at any time. (See [Standard Specifications](#) Section 1-07.1.) In order to fulfill WSDOT obligations to monitor contract operations in accordance with the above, the following procedures should be followed on both Federal-aid and non Federal-aid contracts.

## Precontract Preparation

- The Project Engineer shall obtain the WISHA manuals, particularly Safety Standards for Construction Work [WAC 296-155](#), General Safety and Health Standards [WAC 296-24](#), and General Occupational Health Standards [WAC 296-62](#), and shall review them with the key field WSDOT inspectors to ensure reasonable familiarity to the extent that they can recognize important requirements.
- The Contract Plans and contract provisions should be reviewed to identify those aspects of the work meriting special attention from the standpoint of potentially dangerous types of work and hazard elimination.
- The project site should be reviewed to identify those aspects of the location that present hazards such as limited sight distance, confined spaces, difficult terrain, extreme temperatures, illegal encampments, or exposure to biological and physical hazards associated with animals or humans.

## Preconstruction Duties

As part of the Preconstruction Meetings and Discussions (see Section [SS 1-05.1](#)), the Contractor's safety program should be discussed. Some of the things that the Project Engineer may want to consider are:

- The contractual obligation of the Contractor for complying with State and Federal construction safety standards (see [Standard Specifications](#) Section 1-07.1).
- The availability of the safety standards that apply to the Contract.
- The accident prevention program of the Contractor – organization, staff, names of responsible individuals, meetings, training, reports, etc. A review of specific areas for which plans are required (especially those also affecting WSDOT personnel). These might include Fall Protection, Confined Spaces, Respirators, Hearing, and Hazardous Materials plans. Implementing a mechanism for employees to report “near misses” and/or work zone accidents.
- The Contractor's responsibility for seeing that subcontractors comply with safety regulations.
- The Contractor's plans for meeting specific safety requirements and for eliminating potentially critical hazards on the project for all Contractor employees, Contracting Agency employees, and the public.
- The Contractor's responsibility to meet the requirements of [WAC 296-800](#), which requires employers to provide a safe workplace. Particular mention must be made to [WAC 296-800-11025](#), which prohibits alcohol and narcotics from the workplace.

## The PE's Role in Safety on the Project

It is difficult to generalize about safety. It's a judgment call which is dependent on risk, knowledge, authority to direct corrections, etc. As people, professionals and representatives of the State, Project Engineers have an obligation to act if they become aware of a situation that presents an immediate threat. Project Engineers should advise their employees on what the lines of communication are and what the procedures are for alerting the responsible agencies regarding serious safety hazards.

Employees should be made aware that the Contractor is obligated to make the work-site safe, to their satisfaction, for inspection activities. Anyone who is uncomfortable with access for inspection should inform their supervisor of the situation and expect resolution. Project personnel should also be made aware of project specific hazards and

be trained in specific areas as the project warrants. For example: fall protection, confined space requirements, respirator training, lead paint hazards, hazardous material training, and exposure to medical waste (sharps). It is suggested that the expertise of the Regional Safety Officers or Headquarters Safety Office be utilized as appropriate.

Be aware that the construction contract requires the contractor to perform any measures or actions the Engineer may deem necessary to protect the public, and that the Engineer may suspend work if the Contractor fails to correct unsafe conditions. Project staff should continuously monitor the Contractors' work activities for potential violations of legal safety requirements, and for any condition that poses an immediate threat to the health of any person. Immediately notify the Contractor upon becoming aware of any such condition.

Additional information, such as safety regulations and Department of Labor and Industries (L&I) contacts are available on the internet at [www.wa.gov/lni](http://www.wa.gov/lni). Keep in mind that many WSDOT employees are not trained to interpret and apply safety regulations; however, employees need to have a reasonable understanding of what hazards may be encountered on a project. Many, but not all, of the requirements are listed under [WAC 296-155](#) Safety standards for construction work under the various "Parts a through V."

State L&I offers consultation service (advise is given) and enforcement (assessment of a violation would result in a citation being issued). A listing of the various L&I field offices is as follows:

- **Region 1**

Bellingham Field Services Location	360-647-7300
Everett Field Services Location	425-290-1300
Mount Vernon Field Services Location	360-416-3000
- **Region 2**

Bellevue Field Services Location	425-990-1400
Seattle Field Services Location	206-515-2800
Tukwila Field Services Location	206-835-1000
- **Region 3**

Bremerton Field Services Location	360-415-4000
Port Angeles Field Services Location	360-417-2700
Tacoma Field Services Location	253-596-3800
- **Region 4**

Aberdeen Field Services Location	360-533-8200
Kelso Field Services Location	360-575-6900
Tumwater Field Services Location	360-902-5799
Vancouver Field Services Location	360-896-2300
- **Region 5**

East Wenatchee Field Services Location	509-886-6500
Kennewick Field Services Location	509-735-0100
Moses Lake Field Services Location	509-764-6900
Yakima Field Services Location	509-454-3700
- **Region 6**

Pullman Field Services Location	509-334-5296
Spokane Field Services Location	509-324-2600

## SS 1-07.3 Fire Prevention and Merchantable Timber Requirements

### SS 1-07.3(1) Fire Prevention Control and Countermeasures Plan

A Fire Prevention Control and Countermeasures Plan (FPCC) Plan is required on every project, regardless of proximity to forestland. The plan is required to be submitted as a Type 2 Working Drawing no later than the date of the preconstruction conference. The Project Engineer will review the FPCC plan for completeness as outlined in *Standard Specification 1-07.3(1)A1*. The required elements listed in the plan must be periodically verified by Project Inspectors. An updated FPCC plan is due annually on multiple year Contracts, and a revised FPCC plan is required as site conditions change.

Most of Washington State is covered under the Industrial Fire Protection Level (IFPL) system which, by law, is managed by the Department of Natural Resources (DNR). The IFPL system was established to identify fire risk levels and accordingly prohibit certain high risk work activities during periods of dry weather. The risk level for a given area is regularly assessed and can change daily. In certain areas, jurisdiction is transferred to the United States Forest Service (USFS) or to the local fire authority.

The Project Engineer is encouraged to establish a working relationship with the local agency responsible for fire protection (DNR, USFS, Tribe, or the local fire district) early in the project. It is important for the Project Office to know and understand the different laws of the jurisdiction governing the work site. The Project Office should also check the [IFPL website](#) daily during the closed season (April 15 – October 15) to verify the fire threat level for the project site. It is recommended that fire protection be discussed at the weekly safety meeting, or more frequently if levels warrant further discussion.

In the event the IFPL requires either a partial or general shutdown of Work, the Contractor may obtain a waiver to continue certain work activities. The Project Office will verify that the Contractor has received a waiver from DNR before allowing continuation with prohibited Work. If the IFPL requirements prohibit the Contractor from performing Work, the Contractor may be eligible for an unworkable day in accordance with [Section 1-08.5](#).

When it is in WSDOT's interest to pursue a waiver, and after receiving ASCE approval, the Project Engineer will lead the effort to obtain the waiver while working closely with the Contractor and the agency responsible for fire protection. The Project Engineer must discuss pursuing a waiver with the ASCE, as the Department bears additional risk and cost when WSDOT is the initiating party. The potential need for a waiver should be discussed with the regulatory fire agency prior to or early in the fire season. Factors such as work activities, location, and shortened work windows are some examples of risks to consider at the beginning of the project. Requesting the waiver in the middle of the fire season, or at the last minute, is not advisable.

If the project is contained within the paved roadway surface or is an emergency operation, the Project Engineer can allow work to continue during restrictions, however, all effort should be made to follow the IFPL restrictions.

WAC 332-24-405 requires the Contractor and WSDOT Inspectors to have certain equipment available and in working order. The requirements are:

Contractor	WSDOT Inspector
1. Fire extinguisher of at least a 5 B C rating	1. Fire extinguisher of at least a 5 B C rating
2. Approved exhaust system	2. Approved exhaust system
3. Shovel (mounted on all vehicles/equipment)	3. Shovel
4. Two serviceable five gallon backpack pumps filled with water	
5. Firewatch (with portable power saw operation)	

The purpose of the equipment is to extinguish fire when initially started while it can be controlled or extinguished by portable fire extinguishers or small hose systems without the need for protective clothing or breathing apparatus. Project Inspectors are not required to compromise their personal safety in fighting fires.

If a waiver is issued to the Contractor to continue work during a shutdown, the Contractor must have all the required tools noted above in addition to the specific mitigation measures in place listed in the approved waiver.

### SS 1-07.3(1)A2 Forest Fire Prevention

When the project limits are next to or extend into a State or Federal forest, the Contract may contain an appendix with additional USDA Forest Service requirements that need to be included in the FPCC plan and the Contractor must take extra steps for fire prevention. When approving the FPCC Plan in these areas, the Project Engineer may elect to contact the local forest supervisor or regional manager to ensure the Contractor has obtained the information required in *Standard Specification 1-07.3(1)A2*.

## SS 1-07.4 Sanitation

### SS 1-07.4(2) Health Hazards

**Site Cleanup** – Some contracts contain specifications for site cleanup. This may include the removal of illegal encampments, unauthorized pedestrians, personal property, refuse, and other biological and physical hazards from the work area. The Contractor is required to perform all necessary work, and to take precautions to maintain the health and safety of all workers and the public, who may be in the work area. It is the responsibility of the Project Engineer to inspect the Contractor's work and ensure compliance with the contract requirements and with all applicable laws. Each Project Engineer should appoint a contact for encampment removal issues.

The Contractor is required to have a Health and Safety Plan, and to submit the plan to the Project Engineer prior to commencing any cleanup work. The Project Engineer should ensure that the plan is prepared in accordance with contract provisions.

The Contractor will furnish and install "No Trespassing" signs in all areas where pedestrians may be encountered, except where pedestrians are legally allowed. "No Trespassing" signs must be posted no less than 72 hours prior to beginning site cleanup work or any other potentially hazardous work. If the site contains encampments, the signs should be posted at each encampment. The Project Engineer should conduct a site



visit in order to verify that the signs are posted correctly and meet the requirements of the contract.

At the time the signs are posted the Contractor should provide written notification to the Project Engineer and local jurisdictions. When the work includes removal of encampments the Contractor should also notify local advocacy groups that site cleanup and removal is scheduled.

After the initial removal of encampments, the Contractor should revisit the area at regular intervals, and if encampments persist, permanently post the area with “No Trespassing” signs and proceed with removal activities.

Immediately prior to commencing cleanup and removal, brush clearing, or other potentially hazardous work, and periodically throughout the day, the Contractor should visually inspect the area to ensure that no unauthorized pedestrians are present. The Project Engineer should verify that the site is cleared of pedestrians and that periodic area checks are being done. Special attention should be given to areas hidden from view, such as in dumpsters or equipment, or under blankets. The Project Engineer may consider the use of non-invasive detection aids, such as infrared detectors, to ensure that no unauthorized persons are present.

**Removal, Storage, and Return of Personal Property** – The Contractor will remove personal property that is not refuse. Items will be placed in large transparent plastic bags, labeled, and stored for return to the property owner. The Project Engineer should ensure that personal property is handled and stored in accordance with the requirements of the contract and all applicable laws.

Further WSDOT policy information and guidance is available on the State Construction Office Webpage at: [www.wsdot.wa.gov/Business/Construction/TechnicalGuidance.htm](http://www.wsdot.wa.gov/Business/Construction/TechnicalGuidance.htm)

## **SS 1-07.5 Environmental Regulations**

The following procedure pertains to WSDOT personnel on all WSDOT contracts and contains duties and activities by persons other than the project staff, but all of which are related to construction contracts and affect the Project Engineer to one degree or another. The Project Engineer must stay aware of this procedure and follow it as written.

### **Environmental Compliance Assurance Procedure**

The purpose of the Environmental Compliance Assurance Procedure (ECAP) is to recognize and rectify environmental non-compliance events during the construction phase on WSDOT highway and modal construction sites, and to ensure prompt notification to WSDOT management and regulatory agencies. For purposes of this procedure, non-compliance events are defined as actions that violate environmental permits, agreements, laws, or regulations.

When non-compliance is suspected or known, the Project Engineer (PE) shall initiate the Notification and Resolution process. The Regional/Modal Environmental Manager will serve as a resource to the PE and give priority to addressing the non-compliance event. The Project Engineer and Environmental Manager will work together on an appropriate response to avoid or minimize environmental damage.

## Notification and Resolution Process

When a non-compliance event is suspected or known, the following steps must be taken:

1. The person who discovers an event must immediately notify the PE.
2. The PE must:

**Step A** – Immediately notify the Contractor of the situation and suspend all work that is causing non-compliance.

**Step B** – Immediately contact the Environmental Manager or designee to confirm whether or not it is a non-compliance event. If the event is compliant, stop the notification process and resume work activity. If not compliant, collaborate with the Environmental Manager to determine the regulatory agencies with jurisdiction. Notify all regulatory agencies with jurisdiction.

**Step C** – Consult with the Environmental Manager regarding response actions taken and any additional remediation actions that may be necessary.

**Step D.1** – Highway Projects: Notify the appropriate Assistant Region Administrator or Mega Projects Engineering Manager for Construction and the assigned Headquarters liaison (i.e. Assistant State Construction Engineer). If resolving the non-compliance event requires any design decision, notify the appropriate Assistant State Design Engineer.

**Step D.2** – WSF Projects: Notify the Terminal Engineering Construction Engineering Manager and the Terminal Engineering Design Engineering Manager.

**Step E** – Additional notifications from the PE are necessary when the non-compliance event:

- results in a formal written/verbal enforcement action from a regulatory agency;
- presents risk to public health or the environment; or
- creates a public controversy.

**Step E.1** – Region Highway Projects: Notify the Region Administrator and the State Construction Engineer.

**Step E.2** – Mega Projects Highway Projects: Notify the Mega Project's Program Administrator.

**Step E.3** – WSF Projects: Notify the Terminal Engineering Director.

3. The Region Administrator, State Construction Engineer, Mega Projects Program Administrator, and/or Terminal Engineering Director must notify the appropriate agency executives as warranted by the situation.

4. The Environmental Manager must:

**Step A** – Notify the Director of Environmental Services Office (ESO) when the non-compliance event:

- results in a formal written/verbal enforcement action from a regulatory agency;
- presents risk to public health or the environment; or
- creates a public controversy.

**Step B** – Assist the PE in recognizing the underlying cause that resulted in the non-compliance event, and determine how to prevent a reoccurrence of the event.

**Step C** – In consultation with the PE, identify and obtain new or modified permits, approvals, or agreements as needed to rectify the non-compliance event.

5. The Director of ESO must notify the ESO Compliance Solutions Branch Manager.

### Documentation

1. The PE and the Environmental Manager shall coordinate and prepare the appropriate responses to all regulatory agencies with jurisdiction. The responses shall include documentation about the non-compliance event and how it was recognized and rectified.
2. The Environmental Manager, with assistance from the PE, shall record the details of the non-compliance event in the WSDOT Commitment Tracking System (per [RCW 47.85.040](#)), including but not limited to:
  - Project Name and location, plus the name of PE and Contractor.
  - Date of event.
  - Location(s) on the project where the non-compliance event occurred.
  - The type of work and the underlying cause that resulted in the non-compliance event.
  - The environmental, permit, agreement, law, or regulation violated.
  - Description of how the non-compliance event was recognized, rectified, and the lessons learned.
  - Which regulatory agencies and staff were notified, including dates of notification and any tracking numbers provided.
  - Whether or not regulatory agency staff conducted a site review in response to the notification.
3. The ESO shall produce a yearly report of all written notifications or violations to the Washington State Legislature (per [RCW 47.85.040](#)).

### SS 1-07.5(3) Working in Water

When working in water, the Project Engineer shall ensure the Contractor complies with the environmental and navigation provisions of the contract. If the contract requires the Contractor to obtain special permits, the permits shall be obtained before the work covered by them is begun. Project work occurring in water must meet state water quality standards. Monitoring is required to verify the work achieves compliance with state water quality standards. WSDOT is required by law to report noncompliance with water quality standards to the Department of Ecology. Please follow the Environmental Compliance Assurance Procedures if standards are not achieved (see [Section SS 1-07.5](#)).

**(I) Monitoring Water Quality**

WSDOT is responsible for monitoring water quality during the Contractor's work in the water. Information is available that helps the Project Engineer successfully apply WSDOT's *Monitoring Guidance for In-Water Work* and collect a representative sample.

The Project Engineer may need to prepare a Water Quality Monitoring and Protection Plan (WQMPP) if required as a condition of a permit. Check the permits early and prepare the plan in advance to prevent delays in the Contractor conducting the work. A procedure exists (PRO610-e) that helps the Project Engineer develop the WQMPP. To help the Project Engineer develop the WQMPP, a template can be found on the [Stormwater & Water Quality](#) page under the tools, templates, and links tab.

Note that water quality monitoring of work occurring in water is different than monitoring construction stormwater discharging from a construction site. Refer to Section 8-1.3 for information about monitoring stormwater discharges from construction sites.

**(II) Work Area Isolation/Stream Diversions**

A meeting including the Contractor, Project Engineer, and WSDOT Hydraulics Office is required no less than 7 days prior to the start of the fish block net installation and the Contractor is required to notify the Project Engineer 14 calendar days before the meeting. The Project Engineer should include WSDOT Headquarters Hydraulics staff, Project Inspectors, and other stakeholders and permitting agencies to the meeting.

The Contractor will be required to submit a Temporary Stream Diversion (TSD) Plan for WSDOT to review and provide comments. Make sure to include your Region Environmental Permit Coordinator and Biology staff in reviewing the submittal. A TSD reviewer's checklist is available on the [WSDOT SharePoint](#) site. Do not allow any TSD Work until all comments on the Contractor's plan are addressed.

**(III) Fish Moving Protocols and Standards**

The Project Engineer should check project permits to determine whether WSDOT is required to isolate and remove fish from the work area in advance of the Contractor's work. The Project Engineer must coordinate these activities with the WSDOT biologist. Refer to the WSDOT Fish Exclusion Protocols and Standards to learn about the roles and responsibilities for these activities.

**(IV) Reporting Monitoring Data**

The Project Engineer is responsible for ensuring any monitoring data is submitted to the Washington State Department of Ecology's Federal Permit Coordinator. The Project Engineer should coordinate with Region Environmental Staff to ensure that reporting is done correctly.

**(V) Reporting Spills to Water**

Work that results in a spill to water generates multiple reporting obligations. At a minimum, the Project Engineer must follow the Environmental Compliance Assurance Procedure (see [Section SS 1-07.5](#)) of this manual) to start WSDOT's internal spill response. Also, the Project Engineer must ensure the Contractor enacts the spill response Section of their Spill Prevention, Control, and Countermeasures Plan.

## Infiltration of Slurry

In accordance with 8-01.3(1)C, some classifications of shaft drilling slurry wastewater may be disposed of on-site by using upland infiltration. If the Contractor plans to infiltrate these types of slurry wastewater on-site, they must submit a Shaft Drilling Slurry Wastewater Management and Infiltration plan in accordance with Section 8-01.3(1)C. Project specific site conditions, such as a high water table or contaminated soil, may exclude the use of on-site infiltration as a slurry disposal option. The Project Engineer shall review and accept the plan prior to any on-site slurry wastewater infiltration.

Guidelines for reviewing and accepting Contractor plans are as follows:

1. The classification of slurry wastewater to be infiltrated and the Contractor's Shaft Drilling Slurry Wastewater and Infiltration plan both meet the specified requirements in Section 8-01.3(1)C.
2. The proposed best management practices (BMPs), controls, or other methods included in the plan are adequate to prevent surface wastewater runoff from leaving the infiltration location. What is "adequate" is site specific and dependent on how much water is being infiltrated and where, some examples may include:
  - The basis for the selection of an infiltration location (e.g., subsurface conditions, soil type, estimated infiltration rate, location of surface water)
  - Barrier BMPs (e.g., sandbags, berms, water bladders, silt fence) used to prevent surface wastewater runoff from leaving the infiltration area.
  - Interceptor BMPs (e.g., trenches, traps, pipe drain to containment area) used to capture wastewater surface runoff before it leaves the infiltration area.
  - A metering device that can be adjusted to discharge water to the ground at a rate that will prevent surface runoff from developing.
  - Digging a temporary infiltration containment area to hold a specific volume of wastewater. Keep in mind that digging will diminish the layer of unsaturated soil (prior to infiltration occurring, there must be a minimum of 5 feet of unsaturated soil between the soil surface where the infiltration will occur and the saturated soil). In addition, using heavy equipment to dig the infiltration containment area may cause soil compaction at the location, thereby lowering the effective infiltration rate.
3. The Contractor's plan includes an adequate level of detail to demonstrate that the planned controls and methods will prevent potential impacts to receiving waters of the State, including groundwater, for example:
  - Containment strategy for wastewater prior to infiltration.
  - Strategy for managing wastewater pH neutralization prior to infiltration.
  - Monitoring strategy to ensure infiltration activity is in compliance.
4. The Contractor's plan identifies a contingency plan that will be implemented immediately if it becomes evident that the controls and methods in place are not adequate to meet the requirements in Section 8-01.3(1)C. Contingency plans must be capable of being implemented immediately, such as:
  - Identifying procedures for rectifying plan deficiencies.
  - Having additional BMP materials on hand.
  - Eliminating the discharge to the ground (stopping infiltration activity).

## Responsibility for Environmental Considerations

During the precontract period, the Project Engineer should obtain copies of the final environmental documents and permits related to the project. The Project Engineer should review all contract commitments in the WSDOT Commitment Files and participate in any Environmental Commitment Meetings. It is important that all key personnel become familiar with the environmental decisions considered during the design process. The contract documents should include any necessary provisions for protection of the environment and cultural resources, including requirements that the Contractor secure all permits as required by the contract and abide by regulations of appropriate Federal, State, and local agencies. Any changes in contract work that may become necessary must also be reviewed to ensure conformance with the requirements, and commitments established during the environmental design of the project. For more information on Environmental Commitment Meetings please reference the *Environmental Manual*, Chapter 590 - Incorporating Environmental Commitments Into Contracts.

### SS 1-07.5(6) U.S. Fish and Wildlife Service and National Marine Fisheries Service

#### *Bird Protection Plan*

The Project Engineer needs to work closely with the WSDOT biologist on:

- The need to complete monitoring while the Contractor drafts and finalizes the plan
- Notifications and actions by the Contractor as stated in the plan
- Prior removal of any nest

### SS 1-07.9 Wages

#### SS 1-07.9(1) *General*

The payment of predetermined minimum wages on Federal-aid Contracts is derived from the Davis-Bacon Act of 1931 and is prescribed by 23 USC 113. The payment of predetermined minimum wages on State funded Contracts is partly modeled after the federal Davis-Bacon Act. Both Acts are intended to protect the employees of Contractors who are performing public works construction from substandard earnings and to preserve local wage standards.

The guidance provided herein is intended to help those Project Offices administering construction Contracts understand the laws, regulations and contractual obligations regarding prevailed wages. It is not meant to be a substitute for reading and understanding Federal and State laws and it is not intended to be legal advice. If a labor issue arises and cannot be resolved at the Project Office level, it must be elevated to the Region Construction Office and if necessary, the State Construction Office.

#### Complaints

Any complaints regarding violations of minimum wage rate regulations that are referred to the Project Engineer by employees of the Contractor, Subcontractor, or lower-tier subcontractors should be treated as confidential.

All issues of noncompliance involving either the Contractor, Subcontractor, or any lower-tier subcontractors must be addressed through the Prime Contractor for resolution and elevated to the regulatory agency if necessary. If no violation is found, the employee making the complaint will be notified by WSDOT staff, however the Contractor does not need to be informed.

## Federally Funded Contracts

All complaints brought to any WSDOT staff by a worker employed on the project must be promptly investigated by the Project Engineer using [DOT Form 424-003](#). Follow the guidance provided in the Section titled Employee Interviews.

If the Project Engineer finds an apparent violation of prevailing wages, the Contractor must be informed and prompt corrective action must be made.

## State Funded Contracts

All complaints brought to any WSDOT staff by a worker employed on the project must be promptly investigated by the Project Engineer using certified payrolls that have been submitted through PWIA.

If the Project Engineer finds an apparent violation of prevailing wages, the Contractor must be informed and prompt corrective action must be made. WSDOT staff should also refer the individual to LNI's website under Workers Rights.

## Federal Prevailing Wage

### Enforcement of Federal Prevailing Wage Provisions

In addition to the requirements of [Standard Specifications](#) Section 1-07.9, all Contracts financed with Federal funding includes the Required Contract Provisions for Federal-aid Construction Contracts (FHWA-1273). These provisions identify Federal wage requirements. The Federal prevailing wage requirements included in these provisions are also commonly referred to as Davis Bacon and Related Acts (DBRA). It is the Project Engineer's responsibility to monitor and enforce these provisions to the degree necessary to ensure full compliance. In order to comply with these requirements, the Contractor must:

- Submit weekly certified payrolls to the Project Engineer through LNI's Prevailing Wage Intents and Affidavits (PWIA) system.
- Ensure each Subcontractor, and each agent or lower-tier subcontractor submits weekly certified payrolls to the Project Engineer through PWIA.
- Post wage rate posters.
- Post the Federal Wage Determination included in the Contract Provisions.
- Allow interviews of employees during working hours by authorized representatives of WSDOT, the Federal Highway Administration, and the U.S. Department of Labor (USDOL).

The Contractor is ultimately responsible for all Subcontractor, agent, or lower-tier subcontractor compliance with the requirements for Federal prevailing wages.

When the Contract is subject to both State and Federal hourly minimum rates, the Contractor is required to pay the higher of the two rates unless specifically preempted by Federal law. The wage must be verified using the specific wages included in the Contract Provisions.

## Federal Prevailing Wage Violations

In the event the Project Engineer identifies an error during an inspection of Federal certified payroll regarding:

- improper application or nonpayment of Federal prevailing wages
- improper application of overtime pay
- other requirements noted in the FHWA-1273s

The Project Engineer will immediately notify the Contractor requesting an explanation or prompt corrective action within a mutually agreed timeframe.

If the Project Engineer finds the Contractor has failed to make the corrections or provide an explanation within the time period determined, the matter must be elevated to the Region Construction Manager.

## Employee Interviews

The Project Engineer must conduct periodic employee interviews using Employee Interview Report Form [DOT 424-003](#). The purpose of these interviews is to establish, with reasonable certainty, that the provisions for Federal prevailing minimum wages are being complied with and that there is no misclassification of workers or disproportionate employment of laborers, helpers, or apprentices. The occupation description must be shown on the form used for the employee interview noted under current duties. The occupation description is noted in the wage listing included in the Contract Provisions.

Some employees may refuse to reveal their rate of pay. This is acceptable and should be noted in the remarks column. Many employees do not know or may guess the rate. If possible, a determination of the accuracy of the stated rate should be made, and any uncertainty noted in the remarks column to reduce the need for follow up interviews.

If either the stated rate (from the employee) or the record rate (from the certified payroll) is below the minimum rate (from the Contract wage listing), an investigation by the Project Engineer must be conducted. The investigation may be as simple as a follow up interview with the employee, or a more in depth investigation may result in a requirement for a supplemental payroll. In any event, the matter must be resolved so that the employee interview report describes what corrective action was taken to ensure that the employee has been paid the minimum prevailing wage rate. This corrective action is to be reported under remarks on the form or by an attached memo if more space is needed. All discrepancies found must be resolved.

The frequency and extent of these interviews will be sufficient to ensure a representative sampling has been made for all classes of workers employed on the Contract. A minimum sampling includes employees of the Contractor and a random sampling of 10% of all subcontractors. The interviews should be made with such frequency as may be necessary to ensure compliance.

## Department of Labor Investigation

USDOL may investigate compliance with the DBRA and the Contract Work Hours and Safety Standard Act (CWHSSA) when conducting any investigations relative to compliance with the Fair Labor Standards Act or any other acts under its enforcement authority. Investigative action taken by the USDOL with respect to DBRA and CWHSSA do not, in any way, change the degree of authority or responsibility of WSDOT for enforcement of these Acts. Any actions taken by USDOL should be considered a service we may



use to assist in our enforcement activities but does not relieve WSDOT of our basic responsibility to fully investigate all potential violations and to apply such sanctions that are deemed applicable under our enforcement authority to ensure compliance.

### **Request for Authorization of Additional Classification and Rate**

USDOL issues Wage Determinations under the Davis-Bacon Act (DBA) using available statistical data on prevailing wages and benefits paid in a specific locality. On occasion, the data does not contain sufficient information to issue rates for a particular classification of worker needed in the performance of the Contract. Because of this, DBA provisions contain a conformance procedure for the purpose of establishing an enforceable wage and benefit rate for the missing classification ([Standard Specifications Section 1-07.9\(1\)](#) and FHWA-1273).

Contractors are responsible for determining the appropriate staffing necessary to perform the Contract work. Contractors are also responsible for complying with the minimum wage and benefits requirements for each classification performing work on the Contract. If a classification considered necessary by the Contractor for performance of the work is not listed on the applicable Wage Determination, the Contractor must initiate a request for approval of an additional classification along with the proposed wage and benefit rates for that classification.

The Contractor initiates the request by preparing form SF1444, Request for Authorization of Additional Classification and Rate, at the time of employment of the unlisted classification. (Reference FAR 22.406-3 and 52.222-6(b), and Title 29 CFR Part 5, Section 5.5(a)). The Contractor completes blocks 2 through 15 on the form. Standard Form 1444 is readily available via the internet and is accessible by going to [www.gsa.gov/portal/forms/type/sf](http://www.gsa.gov/portal/forms/type/sf), and searching by the form number.

The Contractor submits the request to the State Construction Office via the Project Office. The Project Office will need to review the request and if applicable, provide backup data showing that the requested classification(s) have been prevailed in other counties within the state. The Project Office will also need to describe the work being performed and verify that the duties performed, as described in the request, are not covered by any other classification(s). This documentation, along with the request, will be forwarded from the Project Office, through the Region Documentation Office, to the State Construction Office.

The State Construction Office reviews the request for completeness and signs the form designating the Contracting Agency's concurrence or disagreement with the Contractor's proposal. If the Project Engineer or the State Construction Office indicates disagreement with the Contractor's proposal, a statement must be attached supporting a recommendation for different rates. The State Construction Office then submits the proposal with all attachments to USDOL for approval. The Contractor is obligated to pay the proposed wage and benefit rates during the request for determination and pending a formal response from USDOL.

When a determination has been received from USDOL, the Contractor is obligated to pay that determined wage and benefits. If the Contractor has underpaid the employee(s), they are required to make back payment and re-submit corrected certified payrolls.

## State Prevailing Wage

### Enforcement of State Prevailing Wage Provisions

Except as noted for missing Statements of Intent, routine monthly progress payments made to the Contractor for work completed should not be deferred for enforcement of State prevailing wage laws.

### State Prevailing Wage Violations

The State Construction Office will refer matters to LNI for further investigation that may be appropriate. If LNI chooses to investigate, they will establish the amount of unpaid wages due to employees.

In order to recover these wages for employees, LNI may choose to file a claim against the Contractor's retainage held under the Contractor by requesting that the Project Engineer withhold funds from monthly progress estimates for work completed by the Contractor.

Refer to [SS 1-09.9](#), Withholding of Payments, for more information.

### Owner-Operators of Trucks and Other Hauling Equipment

The FHWA neither defines the term "owner-operator" nor uses it in regulation. The FHWA regulates "employers" and "drivers." An owner-operator may act as both an employer and a driver at certain times or as a driver for another employer at other times depending on contractual arrangements and operational structure (Federal Register/Vol. 62, No. 65/Friday, April 4, 1997/Rules and Regulations).

Bona fide owner-operators of trucks and similar construction hauling equipment, who are independent Contractors, are not subject to enforcement of Contract labor standard provisions of the Davis Bacon Act and/or [RCW 39.12](#). Owner-operators of other non-hauling type equipment (dozers, scrapers, backhoes, etc.) are considered a Subcontractor, a lower tier subcontractor or an employee of the Contractor or of a Subcontractor. If they are an employee of the Contractor or a Subcontractor, they must appear on that Contractor's payroll as an employee, not as an owner operator.

A ruling by USDOL states in effect that:

Because owner-operators usually work under payment arrangements based on a unit price (e.g., so much per cubic yard hauled) rather than on an actual truck or equipment rental rate plus the driver's (or operator's) rate, and, because of difficulties that have arisen with respect to securing adequate data on rental arrangements in order to determine whether Contract minimum rates are being paid, therefore, as a matter of administrative policy, the provisions of Davis-Bacon and related acts will not be applied to bona fide owner-operators of trucks or other similar construction equipment used exclusively for hauling and who are independent Contractors.

Certified payrolls for owner-operators shall be in accordance with the FHWA-1273. The certified payroll only needs to show the owner-operator's name, the week ending date, and if any work was performed. This does not apply to owner-operators of other equipment such as bulldozers, backhoes, cranes, welding machines, etc. These other owner-operators are considered to be operators and subject to labor standard provisions.

If the owner-operator employs additional drivers, all such employees shall be listed on the payroll with a complete breakdown of hours worked, hourly rate paid, and all other required information according to the FHWA-1273.

Though owner-operators who drive their own trucks may not be subject to prevailed wages as defined in the Davis Bacon Act and [RCW 39.12](#), they are required under State statute to submit Statement of Intent to Pay Prevailed Wages and Affidavit of Wages Paid. The Statement of Intent will identify if the company filed as an owner-operator. There is no exception to this requirement.

### **SS 1-07.9(2) Posting Notices**

Jobsite posters are required on all Contracts administered by WSDOT. Funding on each of these jobs will determine which posters are required. Each poster must be visible and readily accessible to employees. See *Standard Specification 1-07.9(2) Posting Notices* for each poster that is required.

In addition to the required job site posters, the following publications will be made available and readily accessible to employees:

- A copy of the approved Statement of Intent to Pay Prevailing Wages for the Contractor and each Subcontractor and lower-tier subcontractor is required in accordance with [RCW 39.12.020](#)
- A copy of the Contractor's company EEO policy. In addition, Federally funded Contracts requires a copy of each Subcontractor's and lower-tier subcontractor's EEO policy.
- A copy of prevailing wage rates from the Contract Provisions
- Emergency phone numbers for Safety and EEO officers for the Contractor and each Subcontractor and lower-tier contractor.

### **Fraud Notice Poster**

Fraud Notice, FHWA-1022, Title 18 USC 1020, must be displayed on all Federally funded projects during the course of the work. This notice points out the consequences of any impropriety on the part of any Contractor or WSDOT employee working on the project.

### **Federal Prevailing Wage Rates**

The Contractor must post the Federal Wage Determination, consisting of the wage listing included in the Contract Provisions, in a prominent place where it can easily be seen by workers. Standard posters (form WH 1321) are also to be posted and are available to the Region from the Support Services Supervisor, FHWA, Olympia, Washington.

### **SS 1-07.9(3) Apprentice Utilization**

#### ***Apprentice Participation Special Provision – General***

Apprentice utilization of 15% of all labor hours is a requirement on every Contract estimated to cost \$2 million dollars or greater, regardless of the funding source or delivery method. The Apprentice Utilization Requirement is a separate obligation than the Federal Training Program and promotes the use of any apprentice enrolled in an apprenticeship program approved by the Washington State Apprenticeship Council.

It is important to note that while the State Apprentice Utilization Requirement and the Federal Training Program are two separate programs, both could be a requirement on a Contract with Federal funding. A female or minority apprentice enrolled in a program approved by the Washington State Apprenticeship Council may meet both requirements and could be counted toward both goals with appropriate approvals.

Only apprentices enrolled in an apprenticeship program approved by the Washington State Apprenticeship Council may be counted toward attainment of the Apprentice Utilization Requirement. The Apprenticeship Registration and Tracking System (ARTS) can be used to verify apprentice enrollment.

The Contractor may attain the Apprentice Utilization Requirement as part of their work activities or through the work activities of Subcontractors or lower tier subcontractors. Utilization will be calculated using the Department of Labor and Industries (LNI) Prevailing Wage Intents and Affidavits System (PWIA) automatically, using certified payrolls and Affidavits of Wages Paid submitted by the Contractor, Subcontractors and lower tier subcontractors.

Utilization is calculated in PWIA by dividing the total labor hours worked by apprentices into the total labor hours worked by apprentices and journey level workers on each project. Hours include those working offsite at fabrication sites, plant operations, and truck drivers. Per [RCW 39.04.310](#) the total labor hours performed on the project do not include hours worked by foreman, superintendents, owners, and workers if they are not subject to prevailing wage requirements. [WAC 296-127-015](#) defines a supervisor, while [WAC 296-127-026](#) defines owners.

A supervisor (foreman, general foreman, superintendent, etc.) is subject to prevailing wage requirements when they spend more than 20% of their week performing manual/physical labor on the project. If the supervisor performs physical labor between 20% and 50% of their time during the week, they must be paid prevailing wages for each hour worked performing trades work. These hours must be reported to LNI and be included in the total labor hours considered for apprentice utilization. If more than 50% of the supervisor's time is spent performing trades work during the week, all the supervisor's hours for the week must be paid prevailing wages. These hours must be reported to LNI and be included in the total labor hours considered for apprentice utilization.

### ***Apprentice Utilization Plan***

The Contractor is required to submit an Apprentice Utilization Plan on DOT [Form 424-004](#) within 30 days of execution of the Contract. The Apprentice Utilization Plan shall be submitted by uploading the document to the PWIA system. Although the plan is not submitted for approval, the Project Engineer must verify that the plan is reasonable to complete the Contract work. The intent of the plan is to provide the Project Engineer with enough information to track the Contractor's progress in meeting the Apprentice Utilization Requirements. If the plan indicates that the Contractor will not attain the Apprentice Utilization Requirements, then the Contractor must submit Good Faith Effort (GFE) documentation to the Project Engineer for review and comment with their Apprentice Utilization Plan. The GFE shall be uploaded to the PWIA System at the time of the Apprentice Utilization Plan submittal. Submitting a GFE early does not excuse the Contractor from continuous attempts to solicit apprentices.

### ***Apprentice Reporting***

Each Contract with an Apprentice Utilization Requirement will be marked as such in the PWIA system by the State Construction Office upon Contract setup. Apprentice reporting is done automatically through the PWIA system when the Contractor submits their certified payroll. The PWIA system calculates the apprentice utilization based on submitted certified payrolls by each Contractor working on the project and is considered

real time data. The Project Engineer must verify utilization through the life of the Contract at least monthly and should bring concerns up early and often if it appears like the goal is no longer attainable.

Apprenticeship must be discussed at the preconstruction conference, and the Project Engineer is encouraged to bring up apprenticeship goals as necessary, if it appears as though the goal will not be met. The Project Office should compare the PWIA generated report and the Apprentice Utilization Plan at least quarterly to measure the Contractor's progress toward attainment of the Apprentice Utilization Requirement. If apprentices are not being reported on the project when the plan shows that they should be working, the Project Engineer should request a revised plan.

### **Compliance**

A Contractor can meet the Apprentice Utilization Requirements by either of the following:

1. Meeting the Apprentice Utilization Requirements through labor hours performed by apprentices, meeting or exceeding 15% of total project hours or
2. Submitting GFE documentation explaining why the Contractor failed to meet the Apprentice Utilization Requirements, and the Project Engineer approves the GFE.

In the event that the Contractor is unable to achieve the Apprentice Utilization Requirement, the Contractor shall submit GFE documentation for review and approval to the PWIA system. The GFE documentation shall be submitted after Substantial Completion but no later than 30 days after Physical Completion. If GFE documentation was previously submitted as part of the Apprentice Utilization Plan, it shall be updated and resubmitted. The Project Engineer must notify the Contractor in writing of the approval or rejection of the GFE. The response letter must be uploaded into the PWIA system. It is at the Project Engineer's discretion to allow revisions to GFE documentation.

If the Contractor fails to submit GFE documentation or if the Project Engineer does not approve the GFE, the Contractor will be subject to disciplinary actions as allowed under [WAC 468-16-180](#).

### **Good Faith Effort**

#### **Notification of Rejection or Non-Submittal of the GFE**

The Project Engineer must notify their Assistant State Construction Engineer and the Construction Administration Specialist at the State Construction Office when a GFE is not approved or if it is known that a GFE will not be submitted by Contractor.

When a Project Engineer rejects a GFE, the notification needs to include a copy of the Contractor's GFE and Project Engineer's reason for not approving it. Notification of either acceptance or rejection must be in letter format and must be uploaded into the PWIA system.

#### **Disciplinary Measures for Non-Compliance**

The first and second offense in not meeting Apprenticeship Utilization Requirements requires that a letter be sent to the Contractor informing them that they failed to meet the requirement of the Contract Specifications for apprenticeship. The letter will be sent from the State Construction Office to the Contractor, with a copy of the letter to the Project Engineer and the Contract Ad and Award Office.

The letter will contain the following information at a minimum:

- Contractor name
- Contact person
- Contract number
- Contract title
- Percentage of Apprentice labor hours required
- Actual percentage of labor hours performed by apprentices
- Reason for the rejected GFE or statement that GFE documentation was not submitted
- Notification that the Project Engineer will note the missed requirement in the Prime Contractors Performance Report
- If second offense, a letter will provide the date the first letter was sent and inform the Contractor of the second offense in not meeting the Apprenticeship Utilization Requirements on a Contract.
- Notification that other active Contracts with WSDOT at the time of offense will require the Contractor to submit a Plan to the State Construction Office within 30 days of receipt of the letter. Failure to comply will lead to actions taken under [WAC 468-16-180\(3\)](#) and (4). The Plan will include the following at a minimum:
  - The Contract number and name of each active Contract with Apprentice Utilization Requirements; and identify the percentage of apprentice labor hours required per the Contract and the percentage of apprentice labor hours achieved at time of plan submittal
  - Provide the dates the Contracts were awarded and provide the substantial, or physical dates if those dates have been received
  - Provide, in Contractors best judgment at the time of plan submittal if they will meet the percentage of apprentice labor hours required in the Contract
  - If they do not plan to meet apprenticeship labor hours, what course of action will they pursue (such as GFE submittal) to meet apprenticeship attainment requirements
- Notice that future letters of non-compliance may result in action being taken as allowed under [WAC 468-16-180\(3\)](#) and (4)
- Inform the Contractor that this first offense will stay in effect until the Contractor has either:
  - Met Apprentice Attainment requirements on three consecutive completed Contracts, or
  - Two calendar years have passed

If after the second letter to the Contractor, they fail to meet apprenticeship requirements before they have successfully completed three Contracts meeting the Apprenticeship Utilization Requirement, a third certified letter will be sent to the Contractor.

The letter will contain the following information at a minimum:

- Contractor name
- Contact person
- Contract number
- Contract title

- Percentage of Apprentice labor hours required
- Actual percentage of labor hours performed by apprentices
- Reason for a rejected GFE or failure of a GFE to be submitted
- Notification that the Project Engineer will note the missed requirement in the Prime Contractors Performance Report
- Notification that this is the third offense letter on not meeting the Apprenticeship Utilization Requirements (provide the dates the first and second offense letter were sent)
- Should the Contractor have other active Contracts with WSDOT at the time of the third offense letter, then the letter will require the Contractor submit a Plan to the State Construction Office, within 30 days of receipt of the letter. Failure to comply will lead to further actions taken under [WAC 468-16-180\(3\)\(e\)](#). The requirements of the Plan submittal are the same as those listed in the first offense letter.
- Notification that the Contractor is suspended of qualifications for a period of six months as allowed under [WAC 468-16-180\(3\)\(f\)](#) and (4)(b) starting on date established by the State Construction Office. After the suspension period, the next offense will be a first offense. Inform that a third offense within two years of previous suspension, prequalification may be revoked as allowed under [WAC 468-16-190](#) Revocation of qualifications.
- Notification that if additional non-compliance occurs during the suspension period, the State Construction Office will determine further warranted action.

### **SS 1-07.9(5) Required Documents**

The requirements for the Contractor's compliance with prevailing wages are noted in [Standard Specifications](#) Section 1-07.9.

Specific wage rate determinations for State prevailing wages are noted in the Contract and are verified through the PWIA system. Effective January 1, 2020, all certified payrolls, Statement of Intent to Pay Prevailing Wages (Intents) and Affidavits of Wages Paid (Affidavits) are required to be submitted to the Project Engineer through LNI's PWIA system.

The State Construction Office will enter each Contract into PWIA after award and before execution. The funding source and apprenticeship requirements will be selected at the time the Contract is established in PWIA.

### **Statement of Intent**

Every Contractor, Subcontractor, agent, or lower tier subcontractor performing work on a public works contract must submit a Statement of Intent to Pay Prevailing Wages to LNI for approval. Separate Intents are required for each Request to Sublet submitted on the project. Hiring Contractors are required to file an Intent if they hire a lower tier subcontractor subject to prevailing wages.

The Project Office will verify Intents are filed and approved by LNI using PWIA.

No progress payments can be released to the Contractor for work completed by the Contractor, or for portions of work completed by Subcontractors, agents, lower-tier subcontractors, fabricators or suppliers, whom LNI have determined as being covered by State prevailing wage laws, prior to the Project Engineer's verification of the approved Intent for the entity performing the work.

Fabricators or suppliers of material whom LNI has determined as being covered by State prevailing wage laws will require an Intent. Project Office staff are required to monitor PWIA for Contractors that are not considered Subcontractors, but are subject to State prevailing wage laws.

LNI will approve the Intents and further certify that the documents meet the requirements of State laws. Submittal and approval dates of the Intents can be found within PWIA.

### **Affidavit of Wages Paid**

Prior to Contract Completion, the Contractor, all Subcontractors, agents and lower-tier subcontractors must submit an Affidavit of Wages Paid to the Project Engineer using PWIA. The form may be submitted earlier by a Subcontractor or lower-tier subcontractor if that firm's work is completed prior to Completion of the Contract. All Affidavits must be approved by LNI prior to Contract Completion.

In the event a Subcontractor or lower-tier subcontractor cannot or will not provide a completed Affidavit, the Contractor should consult with LNI to seek assistance in filing an Affidavit "On Behalf Of" these Subcontractors. Failure to provide all required Affidavits for all Contractors who worked on the project will result in the withholding of Contract Completion, the Notice of Completion and the release of retainage or bond. PWIA will display those Contractors who have not submitted their Affidavit. If an Affidavit has not been submitted after Physical Completion, the Project Office should send an email to the Contractor through PWIA requesting the missing Affidavits.

Affidavits are required for each fabricator or supplier who was also covered by State prevailing wages, and are required for every firm that submitted an Intent.

### **Certified Payroll**

Certified payroll must be submitted to the Project Engineer through PWIA for each Contractor, Subcontractor, and each lower tier subcontractor performing work on the project, regardless of funding source or delivery method.

Certified payrolls are required from the time each Firm begins performing Contract work until the time the Affidavit is visible in PWIA, or until the Contractor has identified their last certified payroll has been submitted. Once the Affidavit is visible in PWIA, the Affidavit has been approved by LNI. The last working day is included on the Affidavit, and the Project Office should compare this date to the last certified payroll submitted.

A tracking sheet is required to document when Project Office staff verify that certified payrolls are received through PWIA. The frequency of verification depends on the funding source of the project. Weekly verification is required for federally funded projects, while monthly verification is required for state funded contracts. The tracking sheet needs to indicate that all active Contracts have been checked for late or missing certified payrolls. PWIA will be used to track requests made for missing certified payrolls. Project Office staff must ensure payrolls are not printed and stored on computers or as paper copies due to privacy laws. A separate tracking sheet may be used to track which certified payrolls have been verified for each project.

State funded projects require a minimum of monthly submittals, however, each week must be reported.



**State funded Contracts:**

- Monthly submittals
- Affirmation Statement is electronically signed by the Contractor
- LNI will verify wage rate based on the prevailed wage at time of bid opening for bid build (at award time for design build), however, will allow the Contractor to enter a rate lower than the minimum
- Required for every week, including weeks that no work was performed

Federally funded projects require weekly submittals. Further review of the payroll will be required to ensure the Federal prevailed wage rate is met using the Wage Determination included in the Contract Special Provisions.

**Federally funded Contracts:**

- Weekly submittals
- No leniency on late submittals
- Statement of Compliance meeting CFR requirement is electronically signed by the Contractor
- System will redact employee addresses and display the last four digits of the employees SSN
- Wages must be verified using the Wage Determination included in the Contract Provisions (PWIA will not verify)
- Required for every week, whether work was performed or not
- Enforcement of all Federal requirements will remain WSDOT responsibility

**Certified Payroll Inspection – Federal Funded Projects**

The FHWA-1273 requires the Contractor, Subcontractors, agents or lower-tier subcontractors to submit certified payrolls for each week in which any Contract work is performed on the project for projects funded with any amount of federal dollars. These payrolls are to be checked by the Project Engineer to ensure that the required information has been included, is correct, and employees have been paid correctly. The Project Engineer should accomplish this by making a complete check of the first payroll submitted on the project by each Contractor, Subcontractor, and lower-tier subcontractors. Once satisfied the first payrolls are correctly prepared, subsequent payrolls may be accepted by a random spot checking of approximately 10 percent of the payrolls submitted.

If errors are found during any spot-checking of the payrolls, a more complete or thorough check should occur until the Project Engineer is satisfied that the Contractor is in compliance. Monitoring can then be returned to approximately 10 percent of certified payrolls submitted. The FHWA-1273 identifies the required items to be included in certified payrolls.

The first complete check of payroll submitted should confirm that the following items are present:

- The Contract number, title, and payroll period
- The name of the employer, identifying the Contractor, Subcontractor, or lower-tier subcontractor, must be shown.

- A specific minimum wage rate is to be identified for each worker. The [Standard Specifications](#) require the Contractor to use work descriptions for the labor classifications that are included in the Contract Provisions identifying federal wage rates, and are to be used on all payrolls. [Standard Specifications](#) Section 1-07.9 permits the Contractor to use an alternative method to identify or correlate the labor descriptions used, if approved by the Project Engineer, in order that they may be compared to the Contract Provisions.
- Each employee's unique identification number (i.e., last four digits of the employee's Social Security Number). The payroll shall not include the full Social Security Number or home address of the employee; however, the Contractor or Subcontractor shall maintain this information on file and provide this information upon request by the Agency.
- Payroll deductions must conform to Section IV of the FHWA-1273. If payroll deductions are questionable, contact the State Construction Office for assistance.
- Every laborer or mechanic working on the Contract must be classified for the proper minimum prevailing wage in accordance with the designated Wage Determination. If a classification of worker is used that does not appear in the Contract Special Provisions, [Standard Specifications](#) Section 1-07.9 requires the Contractor to contact the USDOL (through the Project Engineer) for a determination of the proper wage rate. The FHWA-1273 provides a method for resolving this.
- Each payroll submitted shall be accompanied by a Statement of Compliance, signed electronically by the Contractor or Subcontractor or their agent who pays or supervises the payment of the persons employed under the Contract, certifying the requirements listed in item (2), under part 3 of the FHWA-1273.

It is the Contractor's responsibility to ensure all Subcontractors and lower-tier subcontractors complete and submit their certified payrolls to the Project Engineer using PWIA. Any payrolls which do not comply fully with the requirements outlined above must be corrected by a supplemental payroll. This is done by amending the original payroll through PWIA.

Federally funded projects require weekly submittal of certified payrolls. If the Contractor is unable to submit their payroll electronically using PWIA, they must submit the certified payrolls directly to the Project Office. When accepting these payrolls, the Project Office should request the Contractor use a unique employee identification number that is not the last four digits of the SSN. In addition, the Contractor must still submit the certified payrolls to PWIA to remain compliant with State law.

Non-compliance or non-submittal could result in the Project Engineer withholding an appropriate portion of payment (see Section [SS 1-09.9](#)).

### **Other Requirements**

- A Contractor or Subcontractor may enter into an agreement with his or her employees to work 10 hours per day without having to pay overtime. This is provided that no employee works more than 4 calendar days a week. The 4-10 agreement must be uploaded into PWIA and will be verified by LNI. When working on Force Account copies of the 4-10 agreements will need to be verified by the Project Office if working 10 hour days to ensure proper payment. This can be done by either sending the agreements directly to the Project Office or uploading them in the FILES tab in PWIA.

- LNI has also defined “Contractor” to include some fabricators or manufacturers who produce nonstandard items specifically for use on the public works project. Additionally, some companies who may contract with the Contractor, Subcontractors, or lower-tier subcontractors for the production and/or delivery of gravel, concrete, asphalt, or similar materials may perform activities that cause employees of these firms to be covered by State prevailing wage laws.
- Specific circumstances that may cause employees of these firms to be covered by State prevailing wage laws are described in LNI publications. These publications are included in the Provisions of each Contract adjacent to the State Prevailing Wage listings. Where these firms are covered by State prevailing wage laws, an approved Intent and Affidavit must be submitted to the Project Engineer into PWIA.
- If a lower tier subcontractor submits an Intent through PWIA, the Hiring Contractor must also submit an Intent. This is monitored through PWIA. If the Hiring Contractor does not submit an Intent, the lower tier subcontractor will appear as an “orphan” Contractor in PWIA.

PWIA will verify that certified payrolls meet or exceed the State prevailed wage rate, however, it is the Project Office’s responsibility to verify the Federal prevailed wage rate has been met. The higher of the two rates (State prevailed wage and Federal prevailed wage) takes precedent.

References, but not limited to:

- Required Contract Provisions FHWA-1273
- [RCW 39.04](#)
- [RCW 39.12](#)
- U.S. Department of Labor Davis-Bacon Resource Book 11/2002
- Davis-Bacon Manual on Labor Standards for Federal and Federally Assisted Construction, Copyright © August 1993 by The Associated General Contractors of America

## **SS 1-07.11 Requirements for Nondiscrimination**

### **SS 1-07.11(1) General Application**

#### **DBE, MSVWBE, and Training**

Every Contract administered is funded either with State, Federal funds, or a combination of both. As a result, individual Contracts may have different guiding requirements depending on what laws were in place at the time the Contract was executed and how the Contract is funded. The Special Provisions, [Standard Specifications](#), and Amendments specify the specific requirements for each Contract.

### **SS 1-07.11(2) Contractual Requirements**

The type of funding used for each Contract will determine whether mandatory or voluntary goals are included. Contracts funded with only State funds have voluntary MSVWBE goals. Contracts over \$100,000 with any amount of Federal funding may include DBE mandatory Contract goals, of not less than two percent as part of a Condition of Award (COA), or a mandatory Federal Small Business Enterprise (FSBE) goal if no COA is established. FSBE goals are not a Condition of Award.

All payments made towards MSVWBE and DBE Subcontractors shall be reported by the Contractor using the application available at: <https://wsdot.diversitycompliance.com>. Payments made to MSVWBE and DBE Subcontractors will only be counted towards Contract goals if the noted Subcontractor is determined to be performing a Commercially Useful Function (CUF) and a type of Work for which they are certified through Washington State Office of Minority and Women's Business Enterprises ([OMWBE](#)).

The Department includes MSVWBE, DBE or FSBE goals to promote diversity in support of inclusion in each Contract, therefore, it is important that the Project Office diligently tracks and monitors the accomplishments of all programs. The State MSVWBE and Federal DBE program contribute to the Agency's inclusion goal as specified in the [strategic plan](#). Contractors are encouraged to achieve voluntary goals and required to meet mandatory Contract goals. The Office of Equity and Civil Rights (OECR) and the Region OECR Compliance Specialist should be contacted for Program questions and the State Construction Office should be consulted for Contract administration matters.

### **Minority, Small, Veteran and Women Owned Business Enterprise (MSVWBE) - State Funded Only Contracts**

MBE, SBE, VOB or WBE are the designations for holding State certification as a minority, small, veteran or women owned business enterprise. [OMWBE](#) certifies businesses as either a minority owned business (MBE), a women owned business (WBE), or a combination of both minority and women owned business (M/WBE). The Department of Veteran Affairs certifies a business as a veteran owned business (VOB), and small businesses (SBE) are registered in Washington's Electronic Business Solution ([WEBS](#)). Contracts funded only with State funds require the Contractor submit an MSVWBE Participation Plan, except for those Contracts with an estimated value of \$250,000 or less. WSDOT provides guidelines for creating a MSVWBE Participation Plan which is available at: [MSVWBE Participation Plan Drafting Guidelines](#)

When the Project Office receives the Contractor's MSVWBE Participation Plan, it will be reviewed for completeness. Incomplete plans will be returned for correction and resubmittal. The Project Office will transmit reviewed plans to their Region OECR Compliance Specialist who will review and either accept the plan as submitted, with or without comments, or return the plan if incomplete or inadequate.

### **Disadvantaged Business Enterprise (DBE) - Federally Funded Contracts**

As a condition of receiving Federal funding, WSDOT has given assurance to FHWA that it will comply with [Title 49 CFR Part 26](#). For Contracts under the authority of the Regions and State Construction Office, all contractual matters relating to the DBE program will be elevated through OECR. The OECR DBE Liaison Officer (DBELO) has the authority for the following:

- Regular Dealer determination
- Pre Award and Post Execution Contract specific approval
- Review and Approval of Pre Award, End of Contract and Termination/Substitution Good Faith Efforts (GFE)
- Pre Award clearing of DBE commitments
- Approval of changes to COA DBE commitments
- Commercially Useful Function reviews
- Applicable Sanctions
- Joint Check Agreements

Any contractual DBE issues, including those listed above must be elevated through the State Construction Office, who will seek the approval of OECR, including concurrence from the DBELO.

OMWBE certifies DBEs and maintains the certified DBE directory. Each DBE is certified in a North American Industry Classification System (NAICS) code that most closely represents the type of work that the DBE is said to perform. It should be noted that the NAICS code doesn't always represent the specific types of work in which the DBE owner has the ability to control, thus, the need for a more specific breakdown, as shown in the Description of Work section of the DBE's profile (in the DBE Directory). The NAICS codes listed on the certification directory are primarily used to determine whether the firm meets the size standards for a small business and may also aid in evaluating the degree of control exercised by the owners of the DBE firm.

Payments made to DBE Subcontractors will be counted toward DBE participation goals if the Subcontractor is determined to be performing a commercially useful function for Work in which they are certified to perform (per the Description of Work section as shown in their profile in the DBE Directory). COA DBE participation will only be counted towards Contract specific and Department goals if the DBE firm being listed as a Condition of Award and is certified in the type of work involved prior to the due date for bids on a prime Contract. Payments reported to non COA DBE firms for certified Work will count toward the Department goal as race neutral participation. In situations where subcontract opportunities arise subsequent to execution of a prime Contract, a DBE must be certified prior to execution of the subcontract in order to count as DBE participation.

### **Federal Small Business Enterprise (FSBE) - Federally Funded Contracts**

The Federal Small Business Enterprise (FSBE) program is an added element of the DBE program, requiring the same level of monitoring, reporting, and verification. FSBE goals are mandatory and assigned as a percentage of the final Contract amount, but are not a Condition of Award. It is important to remember that if the Contract increases in dollar value, the amount required to fulfill the FSBE goal will increase concurrently.

The FSBE goals are not attached to specific Subcontractors at the time of award, and can be met through utilization of any firm designated as a DBE, UDBE or SBE in the OMWBE certified directory.

Good Faith Effort documentation meeting the requirements of the Contract will be required if the FSBE goal is not met. If at any time during the Contract it appears that the FSBE goal will not be met, work with the ASCE and Region OECR Compliance Specialist to determine appropriate actions.

For purposes of tracking and reporting, a Federal Small Business will be designated as FSBE (Federal Small Business Enterprise) on the Request to Sublet and in CCIS.

### **Disadvantaged Business Enterprise (DBE) Condition of Award Participation – Federally Funded Contracts**

When a COA goal is specified, the Contractor shall be held to its DBE Contract commitments, unless otherwise established through a Change Order. The Contractor shall submit the DBE Utilization Certification Form (DOT [Form 272-056U](#)) with the Bid. The DBE Utilization Certification Form identifies the Contractors' monetary commitment amount and the general scope of certified work the DBE is to perform.

Once the Bid is submitted, the Bidder has 48 hours to submit the following documents:

- DBE Written Confirmation Document (DOT [Form 422-031U](#))
- DBE Trucking Credit Form (if required) (DOT [Form 272-058](#))
- DBE Bid Item Breakdown (DOT [Form 272-054](#))
- Good Faith Effort Documentation (required if the bidder did not certify adequate participation to meet the goal)

The DBE Bid Item Breakdown is the initial submittal for the Contractor's DBE Utilization Plan and is used to identify the bid items and dollar amounts specific to the scope of certified work being committed to the DBE. The information is verified and entered into CCIS by HQ OECR.

### **Subcontracts – Applies to DBE and FSBE**

Prior to a DBE or FSBE performing Work on the Contract, the Contractor is required to submit a copy of the executed subcontract between the firm and the Contractor that hired them to the appropriate email address identified in the Contract. The Region OECR Compliance Specialist will review submitted subcontracts and if no comments for noncompliance are issued, no further action is required by the Project Office.

If the Region OECR Compliance Specialist contacts the Project Engineer due to non-submittal or noncompliance of subcontracts, language will be provided by the Region OECR Compliance Specialist to be used to inform the Contractor of non-compliance or non-submittal.

### **Trucking – Applies to DBE and FSBE**

Each trucking firm performing only trucking or hauling Work, certified as DBE or FSBE must submit a Primary Truck Unit Listing Log, including all applicable rental/lease agreements. The form will identify all trucks that will be used on the Project by the trucking firm, and must be designated as Primary.

If additional trucks will be added to the Primary Truck Unit Listing Log, a new form will be required and identified as the Updated Primary.

The same form will also be utilized as a daily trucking report, required to be submitted for each day the trucking firm is on-site, listing not only the truck information but also the driver name(s) and hours worked, and marked as the Daily.

- **Primary Truck Unit Listing Log – DOT Form 350-077**
  - Initial Submittal due prior to trucking firm performing work
  - Updated and resubmitted as necessary (identified as Updated Primary)
  - Drivers names and hours worked are not required
  - Lease/rental agreements must be attached
  - Submitted to the Project Engineer
  - Project Office uploads into DMCS
  - Requires field verification with the CUF On-Site Review

Forms received with incomplete or missing supporting documentation must be returned to the Contractor for correction.

- **Daily Truck Unit Listing Log**

- Daily reporting
- Weekly submittal
- Driver names and hours are required to be reported
- Submitted to OECR Region mailbox
- Region OECR Compliance Specialist verifies a minimum of 10% of the Daily Truck Unit Listing Logs
- Region OECR Compliance Specialist uploads into DMCS

If the Region OECR Compliance Specialist contacts the Project Engineer due to forms received with incomplete or missing information, language will be provided by the Region OECR Compliance Specialist to inform the Contractor of non-compliance.

**Primary** – Prior to any trucking services being performed on the Contract, a Primary Truck Unit Listing Log must be submitted. The Project Office will review and upload the Primary Truck Unit Listing Log to DMCS. When reviewing the Primary DBE Truck Unit Listing Log verify:

- The trucking firm has signed each lease agreement
- The truck lease agreement is with DBE or FSBE trucking firms or commercial truck leasing companies
- The license plate numbers on each lease agreement match the Primary Truck Unit Listing Log
- The lease agreements are reasonable to perform the work

Updates to the Primary Truck Unit Listing Log must be resubmitted within 10 calendar days of the change. The Project Engineer will upload any Updated Primary Truck Unit Listing Logs into DMCS.

**Daily** – By the Friday of the week after Work was performed by the trucking firm, the Daily Truck Unit Listing Log is required to be submitted to the Region OECR mailbox. After the initial submittal, the Daily Truck Unit Listing Log will be required to be submitted on a weekly basis.

The Daily Truck Unit Listing Log will include the same list of trucks that was included on the Primary Truck Unit Listing Log, and will also include each driver's name and the hours worked for the specified day. In addition to CUF review(s), the Region OECR Compliance Specialist will verify a minimum of 10% of certified payrolls (listed truck drivers) against the daily logs throughout the life of the trucking firm's work on the project. The verification may require the use of supporting documentation such as:

- Inspector Daily Reports
- Delivery Tickets and Field Note Records – can be requested from the Project Office
- Dispatch Tickets – can be requested from the Contractor

If the Region OECR Compliance Specialist notices discrepancies during their review, the Project Engineer will be notified immediately. Additional field verification using the accepted Primary Truck Unit Listing Log may be required by the Project Inspector.

Field verification is required to ensure that trucks used on the Contract by the trucking firms are listed on the accepted Primary Truck Unit Listing Log. Verification records will be retained in the Contract files with the Project Offices' copy of the trucking firm's CUF On-Site Review, and it is recommended that the two activities occur at the same time. Use the accepted and most current Truck Unit Listing Log as the verification record.

If during the verification process a truck is found to be on-site that is not on the accepted Truck Unit Listing Log, the Project Engineer will immediately notify the Contractor of the following in writing:

- A trucking firm used trucks that were not included on the accepted Truck Unit Listing Log, therefore, cannot be counted as participation towards the commitment
- An Updated Primary Truck Unit Listing Log is required to be sent to the Project Engineer for acceptance within 10 days of when the truck started the work, in order to count its participation

Upon accepting the Updated Primary Truck Unit Listing Log, the Project Engineer will perform a field verification. A new on-site review is not required for every Truck Unit Listing Log verification. If the Contractor fails to provide an acceptable list within 10 days of the truck performing any work, contact the Region OECR Compliance Specialist for guidance, as the Contractor is at risk of a potential CUF infraction. Trucks not listed on the approved list cannot be counted towards the Contract goal, but are allowed to work on-site.

If the Project Inspector witnesses new trucks onsite at any time during the project, additional field verifications of the trucking inventory are required.

### **Changes to the Condition of Award (COA)**

Any change to reduce the COA DBEs scope or commitment amount will be processed as a Change Order, requiring State Construction Office and HQ OECR approval, to terminate COA work and a substitution is required to fulfill the COA commitment amount. If approval is not granted prior to any termination and substitution, the Contractor will not be entitled to any payment for COA work not performed by the existing DBE. Substitution of a COA DBE cannot occur without termination. The Project Engineer will discuss the Contractor's plan for substitution as part of the termination approval process.

Exceptions to the substitution requirement may be allowed in the following circumstances:

- WSDOT deletes the COA firm's intended work or,
- The work has progressed to the point where no other work remains to be acceptable subcontracted. The occurrence of this circumstance should be minimized through timely notification by the contractor to WSDOT of termination requests.

The State Construction Office will approve any substitution with concurrence from the Office of Equal Opportunity.

### **Condition of Award (COA) Change Orders**

Changes to COA DBE Subcontractors' scope or commitment amounts must be made through a Change Order executed by the State Construction Office. Approval is granted by the assigned ASCE, with the concurrence of OECR. This approval must be obtained and documented prior to the changed work, and any related work, being performed. Types of COA Change Orders may include:



- **Substitution** – Contractor requests to terminate a COA DBE Subcontractor in whole or part for good cause and substitute with another COA DBE Subcontractor. The COA Change Order will include a DBE termination for the DBE Subcontractor being replaced and assigning an equal or greater amount of COA work to another DBE Subcontractor.
- **Using COA DBE for Type of Work Not Listed** – Contractor requests to use COA DBE Subcontractor for a type of work that is not listed on the DBE Utilization Certification. In order to be counted toward the COA Goal amount, a COA Change Order must add this work to the COA items for the COA DBE Subcontractor. The COA DBE Subcontractor must be OMWBE certified to perform this type of work prior to execution of its original Subcontract on the Contract.
- **Change Due to Contractor Initiated Change** – Contractor proposes a change that deletes or reduces work to be performed by a COA DBE Subcontractor. This is a termination, and therefore must follow the requirements associated with terminating a DBE. The Contractor shall find substitute work to replace this COA work. If the Contractor cannot guarantee COA DBE participation the requested change order cannot be approved.
- **Change Due to Owner Initiated Change** – Owner initiates a change that deletes or reduces COA DBE work. This could have the same effect as termination, therefore, the ASCE should negotiate inclusion of additional COA DBE work (may include paying a premium) or require a GFE to be included in the change order.

The amounts shown in the COA Change Order should meet or exceed the credit necessary to accomplish the original Contract DBE commitment amount. The Request for Approval, Change Order and Change Order Package will contain the following information:

- An explanation of why the change is necessary
- Identification of all deleted work and all added work
- Revised subtotals for all affected COA DBE firms. The change order only needs to address each affected DBE firm, not all COA DBE firms.
- Revised total attainment for DBE participation.

When submitting the Change Order to the Contractor for signature, the Project Engineer will send copies to the affected DBE firms as notification of the change and will advise the Contractor that this has been done.

### Termination of DBE Subcontracts

Prior to requesting termination of a DBE Subcontractor, the Contractor shall submit, in writing, a letter to both the DBE Subcontractor and Project Office explaining the reason for termination. The DBE Subcontractor has five days to respond to the letter, either in support or objection to the termination. The Contractor must have good cause to terminate, as specified in the General Special Provision. The Project Office will work with the ASCE and HQ OECR for approval of the termination.

If termination of the DBE Subcontractor is approved, the Contractor shall substitute for the DBE with another DBE Subcontractor in an amount equal to the value remaining from the previous DBE's work. A revised Utilization Plan to achieve the UDBE commitment amount shall be submitted to the Project Engineer within two days of the approval of termination or the Contract may be suspended until the plan is submitted.

## Commercially Useful Function On-Site Reviews

The Project Engineer will assist WSDOT OECR in performing CUF On-Site Reviews on each MSVWBE, and DBE Contractor, Subcontractor, Regular Dealer (Federal funds only), Supplier or Manufacturer performing work or supplying materials. The reviews are required whether the Contract is established with voluntary or mandatory goals, and regardless of COAs.

Contracts funded with only State funds will use the following forms, as applicable:

- DOT [Form 226-013](#), *MSVWBE On-Site Review for Construction Subcontractors/Supplier/Manufacturers*
- DOT [Form 226-014](#), *Project Office On-Site Review for Architect & Engineering and Professional Services Firms*

Contracts funded with Federal funds will use the following forms, as applicable:

- DOT [Form 272-052](#), *Commercially Useful Function On-Site Review for Construction Contractors/Subcontractors*
- DOT [Form 272-064](#), *Commercially Useful Function On-Site Review for Regular Dealer/Manufacturers*
- DOT [Form 272-051](#), *On-Site Review Form/Commercially Useful Function Architect & Engineering/Professional Services Firms*

While it is the responsibility of the Project Inspector to complete the entire MSVWBE On-Site Review Forms, the Commercially Useful Function On-Site Review forms for Federally Funded projects are to be completed by three separate entities: the Project Inspector, the Office Engineer, and the Region OECR Compliance Specialist. Once the On-Site Reviews are completed within the Project Office, enter the following information into CCIS:

- The date the review was completed by the Project Office Staff
- The name(s) of the individuals conducting the review

The CUF On-Site Review form is sent to the Region OECR Compliance Specialist for completion with a copy of the Inspectors' Daily Report (IDR). The Project Inspector should attach a copy of the CUF On-Site Review form to their IDR. Photographs capturing the work, equipment, and materials used should be attached to the CUF On-Site Review and the IDR.

If a Regular Dealer is utilized, the Region OECR Compliance Specialist will notify the Project Office. Coordination between the Project Office and the Region OECR Compliance Specialist may be necessary to conduct the CUF On-Site Review for Regular Dealers, due to their rarity and typical short duration on the project site.

All CUF On-Site Reviews will be conducted at the peak of the firms' on-site work and whenever a firm begins performing work under a different scope of work or Contract. An additional CUF On-Site Review will be completed each calendar year for multi-year Contracts.

A CUF On-Site Review is a "snapshot in time" and should record the personal observations, personnel interviews, and results of documentation reviews. It is the Project Inspectors' responsibility to work with Contractor personnel to gather and report accurate data. If the interviewee is unsure of a question, this should be reflected in the answer. Instructions and clarifying statements are included in each of the forms. Once the review is complete and the date and initials of the interviewer have been entered into CCIS, the

Project Office will send the original review to the Region OECR Compliance Specialist within 10 calendar days.

An accurate and thorough CUF On-Site Review is critical, as the review is used to help determine participation credit to both the Contract and Department goals, as well as prevent fraud. If the Project Inspector or Office Engineer are unclear of a question, they are encouraged to inquire to either their Project Engineer or their Region OECR Compliance Specialist for further clarification.

As previously mentioned, the CUF On-Site Review assists when determining participation, but if at any time the Project Inspector witnesses activities that could result in non-participation, notify the Project Engineer immediately.

Any issues regarding DBE compliance should be brought to the attention of the assigned ASCE, who will then coordinate with OECR to take appropriate actions.

On rare occasions, OECR may elect to perform a more in-depth investigation after the CUF On-Site Review is complete. OECR will contact the Project Office directly to inform them of the investigation, however, no further action will be needed by the Project Office.

**Note:**

- Practices that violate CUF criterion may not be excused by forfeiting credit for that portion of the work. Violation may result in none of a MSVWBE or DBE's work being eligible for credit and will not count towards DBE goals.
- After the MSVWBE or DBE firm has met their obligation under their subcontract and total commitment, the Contractor may utilize the firm for additional work.

### **Brokering, Flagging, and Traffic Control Services**

The CUF for traffic control work is specific to the type of work and credit allowed under the terms of the Contract. The following is guidance specific to brokering, flagging and traffic control services.

#### **Brokering**

A business firm that provides a bona fide service, such as professional, technical, consultant or managerial services and assistance in the procurement of essential personnel, facilities, equipment, materials, or supplies required for the performance of the Contract; or, persons/companies who arrange or expedite transactions.

##### ***MSVWBE Participation Credit (State Funding)***

When a MSVWBE participates as a broker, only the dollar value of the fee or commission charged, or 20 percent of the total dollar value of expenditures by the MSVWBE (whichever is greater) counts toward the MSVWBE Voluntary Goal if the firm performs a CUF.

##### ***DBE Participation Credit (Federal Funding)***

When a DBE participates as a broker, credit may be allowed for the reasonable fees or commission charged by a DBE broker or a DBE behaving in the manner of a broker. To be considered reasonable, the fee must not be excessive as compared with fees customarily paid for similar services, and shall not exceed 5 percent of the value of the goods or services. If Brokering is identified as part of the commitment amount, the DBE Utilization Certification form (DOT [Form 272-056U](#)) is required.

The cost of materials and supplies provided by the prime Contractor cannot count towards any portion of the DBE goal, unless the prime Contractor is certified as DBE.

### **Flagging**

When MSVWBE or DBE traffic control companies are listed in the MSVWBE Participation Plan or DBE Utilization Certification as providing “Flagging”:

- The MSVWBE or DBE shall be in control of its work inclusive of supervision
- The Traffic Control Supervisor (TCS) shall be employed by the MSVWBE or DBE firm and be responsible for managing and supervising the flagging operation and perform all duties required in *Standard Specification 1-10.2(1)B*
- All Flaggers shall be employed by the MSVWBE or DBE firm
- The MSVWBE or DBE firm shall provide all flagging equipment

**Credit:** when providing both flaggers and TCS, the value of the labor is eligible to be credited toward the goal.

If the DBE is acting as a broker, only their fee for service would be eligible towards the DBE goal.

### **Traffic Control Services**

When MSVWBE or DBE traffic control companies provides “Traffic Control Services” as designated in the MSVWBE Participation Plan or DBE Utilization Certification:

- The MSVWBE or DBE shall be in control of its work inclusive of supervision
- The Traffic Control Supervisor (TCS) shall be employed by the MSVWBE or DBE firm and be responsible for managing and supervising the flagging operation and perform all duties required in *Standard Specification 1-10.2(1)B*
- The MSVWBE or DBE firm shall provide all traffic control items to perform the work under their subcontract
- The MSVWBE or DBE traffic control company shall not lease or use equipment supplied by the prime Contractor

The State Construction Office should be consulted if questions arise about required equipment.

### **Joint Checks**

Prior to the use of a joint check by a MSVWBE or DBE, for the purchase of materials or supplies required for the project, the MSVWBE or DBE shall submit the DBE Joint Check Request Form (WSDOT [Form 272-053](#)) accompanied by a copy of the Joint Check Agreement between the parties to the Project Office. The Project Office will forward these documents to the Region OECR Compliance Specialist for review. If the Project Office and Region OECR Compliance Specialist are satisfied that the Joint Check request meets the requirements of the Contract, the documents will be forwarded to the ASCE for approval and concurrence from OECR.

**Note:** Joint checks for anything other than materials and/or supplies will not be accepted. The Joint Check Agreement must be specific to the current project, and include, among other things, a detailed description of the materials/supplies covered by the Agreement.

## Escalation and Enforcement

The Department's MSVWBE and DBE programs are managed by OECR. For day-to-day issues, the Project Engineer should communicate with the Region OECR Compliance Specialist and their assigned ASCE. Any questions received from the Contractor or Subcontractor about MSVWBE or DBE Provisions or enforcement should be answered only with full knowledge and at the direction of the State Construction Office and HQ OECR.

Project Inspectors working with MSVWBE or DBE Contractors must notify the Project Engineer immediately if violation of CUF or other unfavorable practices are suspected. Once the Project Engineer is aware of the situation, it is their responsibility to escalate the problem as outlined:

Upon confirmation of any infractions found by the Region OECR Compliance Specialist, the Project Engineer will issue a Notice of Non-Compliance letter to the Contractor. The Contractor will have 14 calendar days from receipt of the letter to respond with a corrective action plan. The letter must contain a detailed list of the infractions that occurred and a list of all applicable sanctions if the Contractor remains non-compliant or non-responsive. The Region OECR Compliance Specialist will be available to assist the Project Engineer with the Notice of Non-Compliance Letter.

If it is determined the Contractor remains non-compliant, sanctions may be applied in accordance with *Standard Specification 1-07.11(5)*.

## On-the-Job Training (OJT) – Federally Funded Contracts

The Federal government requires Contracting Agencies to include these Training Provisions as a condition attached to the receipt of Federal Highway Funding. The training and upgrading of minorities and women is a primary objective of this Training Special Provision.

The amount of training hours are determined by HQ OECR. The requirements for trainee, training plan approval, and trainee payment are all specified in the Contract Special Provisions. On Design-Build Contracts, the Contractor does not submit a monthly invoice for payment. Refer to the Request for Proposal (RFP) for training requirements. The Contract Provisions allow the Contractor to accomplish required training hours as part of their work activities, or through the activities of their Subcontractors or lower-tier Subcontractors. However, the Contractor is designated as being solely responsible for the completion of the training requirements.

## Payment for Training

The Contractor shall submit a certified invoice requesting payment for training. The invoice shall provide the following information for each trainee:

- The related weekly payroll number
- Name of trainee
- Total hours trained under the program
- Previously paid hours under the Contract
- Hours due for current estimate
- Dollar amount due for current updated estimate

Retroactive payment may be allowed provided:

- The Training Program was approved prior to the trainee beginning work on the project
- There are no outstanding issues or circumstances that would have prevented approval of the trainee

Increases in training hours are allowable and may be approved on a case by case basis by the Project Engineer in consultation with the Regional EEO Officer.

### **On-the-Job-Training Required Reports**

- **DOT Form 272-049, Training Program**

This report shall be submitted to the Project Engineer for approval prior to commencing Contract work. The Project Office has the authority to approve Apprenticeship, Training, Employer and Labor Services (ATELS) or State Apprenticeship and Training Council (SATC) programs provided they meet the requirements specified in the Contract provisions. The Region OECR Compliance Specialist will review any non-ATELS/SATC training plans submitted under Section III of the form for compliance and submit the plan to HQ OECR for concurrence and submittal to FHWA for final approval.

- **DOT Form 272-050, Apprentice/Trainee Approval Request**

Approval of an individual trainee cannot be authorized until an approved Training Program is filed with the Region. This form shall be submitted by the Contractor for each trainee to be trained on the project. When an ATELS/SATC trainee is first enrolled, a copy of the trainee's certificate showing training registration shall accompany the Trainee Approval Request. Trainees are approved by the Project Office based on the criteria in the special provisions. If the Contractor submits a request for approval of a trainee who is neither female, nor a minority, the Contractor shall submit a GFE and the Project Office will obtain concurrence from the Regional EEO Officer and OECR prior to approval.

The form requires the Project Office assign a Trainee Tracking Number for use when entering trainee information in CCIS. Only accept forms with a revision date 1/2022 or later.

- **DOT Form 226-012, Trainee Interview Questionnaire**

One trainee interview is to be conducted for each craft designated on an approved training program for Contracts which have 600 or more training hours or as designated by the Region EEO. The Region EEO shall designate additional Contracts on which trainee interviews are to be completed in conjunction with those that meet the criteria above to ensure that trainee interviews are conducted on at least one fourth of all the Contracts that have training hours established for any given construction season. The intent of these training interviews is to document that the trainees are working and receiving proper training consistent with their approved programs, that the trainee is being paid at the appropriate wage rate, and that discrimination/harassment is not occurring. Interviews are to be confidential and aside from the Contractor and Subcontractors unless the Trainee states otherwise. The individual's identity should not be disclosed to the employer without employee's written permission.

Submit completed interviews to the Region EEO Office.

- **DOT Form 272-060, Federal-Aid Highway Construction Annual Project Training Report**

This report will be completed annually by the Project Engineer summarizing the training accomplished by the individual trainees during the reporting period beginning January 1 and ending December 31 of the calendar year. This report is due at the Regional EEO Office by December 20th of the same calendar year, for submission to FHWA.

## Requirements for Affirmative Action to Ensure Equal Employment Opportunity

### ***EEO (State Funded Projects)***

The Contractor shall comply with the EEO requirements detailed in [Standard Specifications](#) Section 1-07.11. The Project Engineer should be alerted and respond to any indications or accusations of discrimination. If the Project Engineer, or any other Project Office staff, becomes aware of any indications or accusations of discrimination, they will immediately notify the Region OECR Compliance Specialist, who will in turn immediately notify OECR. OECR will handle any investigation that is warranted.

### ***EEO (Federally Funded Projects)***

WSDOT has committed to FHWA to perform comprehensive construction compliance reviews, consistent with WSDOT's approved EEO Assurances Program document, to ensure compliance with the Federal non-discrimination requirements (ref. [Standard Specifications](#) Section 1-07.11 and the [FHWA 1273](#)). This review is performed by OECR on a select number of FHWA Funded Contracts and may take place at any time, including after Contract Completion. These reviews do not normally involve the Project Office other than notification of their occurrence and the resulting findings, however, OECR may elect to interview Project Office staff associated with the Contract as part of their review. OECR will contact the Region OECR Compliance Specialist or Project Office to facilitate the timing of the review.

### **SS 1-07.11(5) Sanctions**

The Project Engineer shall take steps to stop any acts that are harassing in nature as described in the [Standard Specifications](#) Section 1-07.11(2). These steps may include removing a Contractor's employee pending outcome of an investigation. ASCE approval is required in the case where the Project Engineer determines that the conditions warrant removal of a Contractor's employee. It is important to note that this is not a request that the employee be terminated by the Contractor, just that they are removed from this Project. The ASCE will consult with the Region OECR and investigate the conditions prior to directing the removal. Care should be taken to ensure that all parties are treated with respect and in a nondiscriminatory manner. The facts should be established and everyone should be given a chance be heard.

### **SS 1-07.11(10) Records and Reports**

- **FHWA-1391, Federal-Aid Highway Construction Contractors Annual EEO Report**

FHWA Form 1391 is required from both the Contractor and each Subcontractor on Federally funded Contracts that have construction activity during the month of July. These forms shall be submitted to the Project Engineer, and are due by August 25th of each year.

A Contractor who works on more than one Federally funded Contract in July is required to file a separate report for each of those Contracts. For multi-year projects, a report is required to be submitted each year work was performed for the duration of the Contract. A responsible official of the company must sign the completed report.

Upon receipt, the Project Engineer will review, sign and date, and forward the annual report to the Region EEO Officer by September 5th. The Region EEO staff at the direction of the OECR will compile and report the information noted on the forms.

- **[FHWA-1392](#), *Summary of Employment Data Report***

WSDOT is required to submit a summary of employment data to FHWA for each Federal fiscal year. This report is prepared using the data from FHWA-1391 (project specific annual reports) that have been submitted to the Region OECR Compliance Specialist by the Project Offices. The summary is prepared by the Region OECR Compliance Specialist or other Region designee for each federally assisted project. The report also includes Local Agency Projects administered through the Region's Highways and Local Programs Offices. The completed FHWA-1392 Report, including all FHWA-1391 reports, are then submitted by the Region EEO Officer to the WSDOT Office of Equal Opportunity by September 15th each year, for formal submission to FHWA.

- **[DOT Form 820-010](#), *Monthly Employment Utilization Report***

The information required by DOT [Form 820-010](#) may be accepted in an alternate format provided that format contains all of the data required by and is completed in accordance with the instructions for DOT Form 820-010. The Region EEO staff should be consulted regarding the acceptability of any alternate format proposed by the Contractor.

Instructions for completing the form can be found on the back of the form itself. This monthly report is to be maintained by the Contractor in the respective prime or Subcontractor's records for a period of three years from Acceptance of the Contract, and available to WSDOT and/or Federal reviewers upon request.

- **[DOT Form 272-055](#), *Final DBE Utilization Plan Report***

The Final DBE Utilization Plan Report is required on all Contracts that include DBE requirements and must be accompanied by a report of the final amounts paid to DBE's, as verified from the final report generated through DMCS. The signed Final DBE Utilization Plan Report and the attached final amounts paid report become part of the three-year Temporary Final Records retained by the Region. The form may be signed by the Project Engineer, Region Construction Manager or the Region OECR Compliance Officer.

The Final DBE Utilization Plan Report represents a certification that contracting records associated with DBE work have been reviewed, on-site performance has been monitored, and it has been determined that work committed to DBEs was performed by the designated DBEs. Signing this report also testifies that all DBE On-Site Reviews are complete, on file, and can be retrieved as supporting documentation for the certification. This certification is a requirement of [49 CFR Part 26.37\(b\)](#).



## **SS 1-07.12 Federal Agency Inspection**

### **Construction Work in International Boundary Strip**

The International Boundary Commission of Washington, D.C., by treaty with Canada, has the exclusive jurisdiction of the 20-ft boundary strip, 10 ft on each side of the International Boundary. Any construction work within this strip must be with the exclusive permission of the International Boundary Commission (IBC). Boundary monuments are not to be moved or disturbed in any manner without the expressed approval of the IBC. It is expected that permission for all work within the boundary strip will be obtained from the IBC during the design stage of a project. However, it is the Project Engineer's responsibility to ascertain that permission has, in fact, been obtained from the IBC for all work performed within the boundary strip. The Region shall be immediately notified if, upon construction, it is found that permission has not been obtained to relocate boundary markers or perform construction work in the 20 ft boundary strip.

### **Responsibilities When Working on Tribal Lands**

Indian nations have the political distinction of being sovereign. This is different from being designated as having protected group status based on racial classifications. Being sovereign, tribes have the ability to create and enforce tribal ordinances such as Tribal Employment Rights Ordinances (TERO). These are legal requirements pertaining to work within the boundaries of the reservation which are enforced by the respective tribes. When a contract includes work on a reservation, the project should include a general special provision "Indian Preference and Tribal Ordinances" that alerts the contractor to the possibility that TERO requirements may apply and provides a contact person for the tribe. The provision also reminds the contractor to bid any costs associated with TERO compliance into associated items of work. TERO requirements may take a variety of forms, some of which are listed in the noted provision. The provision also notes that complying with TERO requirements shall not be a violation of the contract equal employment opportunity requirements. The end result is that the contractor is expected to comply with TERO requirements as they would any other legal obligations. The underlying intent is to reduce Indian unemployment and most tribes are willing to work with contractors to best meet this goal. We want to avoid creating any contractual requirements that interfere with their ability to do so. Our role is to assist in communication but not become involved in determining or paying the tax.

### **Cargo Preference Act (CPA) 46 CFR Part 381**

The Contract Provisions for federal-aid construction contracts (FHWA 1273) requires the implementation of the Cargo Preference Act (CPA) of 1954. The regulations for the Act are given in 46 CFR Part 381, and require that at least 50 percent of any equipment, materials or commodities procured, contracted for or otherwise obtained with funds granted, guaranteed, loaned, or advanced by the U.S. Government, and are transported by ocean vessel, shall be transported on privately owned United States-flag commercial vessels, if available. A listing of United States-flag commercial vessels is maintained by MARAD at: [www.marad.dot.gov/wp-content/uploads/pdf/MAR620.US\\_Flag\\_Vessels.pdf](http://www.marad.dot.gov/wp-content/uploads/pdf/MAR620.US_Flag_Vessels.pdf)

The Federal Highway Administration has stated that Part 381.7 (a)-(b), shown below, are the appropriate clauses for use in the Federal-aid highway program.

(a) *Agreement Clauses. "Use of United States-flag vessels:*

*"(1) Pursuant to Pub. L. 664 (43 U.S.C. 1241(b)) at least 50 percent of any equipment, materials or commodities procured, contracted for or otherwise obtained with funds granted, guaranteed, loaned, or advanced by the U.S. Government under this agreement, and which may be transported by ocean vessel, shall be transported on privately owned United States-flag commercial vessels, if available.*

*"(2) Within 20 days following the date of loading for shipments originating within the United States or within 30 working days following the date of loading for shipments originating outside the United States, a legible copy of a rated, 'on-board' commercial ocean bill-of-lading in English for each shipment of cargo described in paragraph (a) (1) of this Section shall be furnished to both the Contracting Officer (through the prime contractor in the case of subcontractor bills-of-lading) and to the Division of National Cargo, Office of Market Development, Maritime Administration, Washington, DC 20590."*

(b) *Contractor and Subcontractor Clauses. "Use of United States-flag vessels: The contractor agrees-*

*"(1) To utilize privately owned United States-flag commercial vessels to ship at least 50 percent of the gross tonnage (computed separately for dry bulk carriers, dry cargo liners, and tankers) involved, whenever shipping any equipment, material, or commodities pursuant to this contract, to the extent such vessels are available at fair and reasonable rates for United States-flag commercial vessels.*

*"(2) To furnish within 20 days following the date of loading for shipments originating within the United States or within 30 working days following the date of loading for shipments originating outside the United State of cargo described in paragraph (b) (1) of this Section to both the Contracting Officer (through the prime contractor in the case of subcontractor bills-of-lading) and to the Division of National Cargo, Office of Market Development, Maritime Administration, Washington, DC 20590,tes, a legible copy of a rated, 'on-board' commercial ocean bill-of-lading in English for each shipment*

The CPA requirements would be appropriate for oceanic shipments of materials or equipment that is intended for use on a specific Federal-aid project, such as a precast concrete structural members, fabricated structural steel, tunnel boring machines, or large-capacity cranes.

The CPA requirements are not applicable for goods or materials that come into inventories independent of an FHWA funded-contract. For example, the requirements would not apply to shipments of Portland cement, asphalt cement, or aggregates, as industry suppliers and contractors use these materials to replenish existing inventories. In general, most of the materials used for highway construction originate from existing inventories and are not acquired solely for a specific Federal-aid project.

A test for whether CPA requirements apply or do not apply to shipped goods or materials would be if the goods or materials are what one would consider to be common inventory supplies for highway construction contractor, then CPA would not apply. If the materials or goods are considered to be supplies one would consider to be not common supplies of a highway construction contractor then CPA would apply.

When the CPA requirements apply, the Contractor must furnish within 20 days following the date of loading for shipments originating within the United States or within 30 working days following the date of loading for shipments originating outside the United

States, a legible copy of a rated, 'on-board' commercial ocean bill-of-lading in English for each shipment of cargo as described in 46 CFR Part 381.7 (b) (1). Copies shall be provided to the Contracting Agency (Engineer) by the Contractor (through the prime contractor in the case of subcontractor bills-of-lading), and also to the Division of National Cargo, Office of Market Development, Maritime Administration, Washington, DC 20590.

### **SS 1-07.13 Contractor's Responsibility for Work**

#### **SS 1-07.13(1) General**

*Standard Specifications* Section 1-07.13(1) specifically designates the Contractor as being solely responsible for the completed work or material until the entire improvement has been completed. All work and material, including change order work, is at the sole risk of the contractor and when damaged must be rebuilt, repaired, or restored. When these damages occur to either the permanent or temporary work, and have occurred prior to the contract Completion Date, the costs for these repairs shall be entirely at the Contractor's expense. However, the specification does provide the contractor exceptions for causes that are generally beyond the contractor's control.

While the Contractor is fully responsible for the work and materials, the Section does provide the contractor some options for relief. Relief is broken into 2 categories. The first category is relief of maintenance and protection for portions of works that have been completed. The second category is for relief of damage caused by the public when it is necessary that the public use the facility during construction. Both options for relief have specific criteria in order to exercise them. While a brief explanation of each option is provided, the Project Engineer should review the entire *Standard Specifications* Section 1-07.13 to ensure that the extent of responsibilities are understood and that any relief from responsibility is granted in accordance with those provisions.

#### **SS 1-07.13(2) Relief of Responsibility for Completed Work**

*Standard Specifications* Section 1-07.13(2) provides relief to the Contractor from maintaining and protecting specific portions of contract work as they are completed. The Contractor must submit a written request for relief to the Project Engineer. Before granting any relief, the Project Engineer will review the request to ensure that the items of work noted conform to the requirements and limitations outlined in *Standard Specifications* Section 1-07.13(2) and have been fully completed in all respects of the contract. The Regional Construction Manager or designee may approve these requests for relief. Relief may be granted for several specific items, for example: "Item 17, Beam Guardrail, Type I; Item 18, Beam Guardrail Anchor Type I; etc." Relief may also be granted for all work except certain items, for example: "All work except Item 38, Electrical." the approval of the Contractor's request must be in writing.

#### **SS 1-07.13(3) Relief of Responsibility for Damage by Public Traffic**

When it is necessary for public traffic to utilize a highway facility during construction, *Standard Specifications* Section 1-07.13(3) provides relief of responsibility to the Contractor for damage caused to the permanent work by the public traffic. When the conditions specified in this Section are met, the Contractor is automatically relieved of this responsibility. However, this Section may not provide relief for damage caused by vandalism or other causes. The Contractor will resume full responsibility for both temporary and permanent work if traffic is relocated to another Section of roadway.

This responsibility will again continue until contract completion unless the Section is reopened to public traffic or the Contractor is granted relief under *Standard Specifications* Section 1-07.13(2).

The first paragraph of *Standard Specifications* Section 1-07.13(3) refers to damage to “permanent work.” This refers to work included in the contract that is being constructed in accordance with the requirements noted in the plans and specifications and is damaged. The intent is to exclude equipment, temporary facilities and temporary materials such as formwork and falsework and “Temporary Traffic Control Devices.”

#### **SS 1-07.13(4) Repair of Damage**

Section [SS 1-07.13\(4\)](#) details when WSDOT assumes responsibility and pays for third party damages. The WSDOT *Enterprise Risk Management Manual* M 72-01, provides detailed guidance on procedures, including lines of communication. Payment should be made under the item “Reimbursement for Third Party Damages.” This item is only intended to be used for costs that are the responsibility of the contracting agency. If this item was not included in the contract, it may be added by change order using a separate group for each Control Section (as shown in the Plans) in which an incident occurs.

Risk Management has created a form that is to be used to report each new occurrence of Third Party Damages, “DOT [Form 350-013](#)”. The form is available from Forms Management. Any supporting documents should be attached to the form and submitted as well. The form should be filled out and submitted per the routing listed on the bottom of the form. This routing includes:

- **AFS – Contract Payments**
- **Enterprise Risk Management**
  - For AFS and Risk Management use [thirdpartydamage@wsdot.wa.gov](mailto:thirdpartydamage@wsdot.wa.gov)
- **Region Construction Office**

Region Construction may need to send to Region Program Management and to Region Financial Services if additional funds are required. If this item was not included in the contract, it may be added by change order using a new group for the Control Section (as shown in the Plans) in which an incident occurred. Once the item has been added to the contract, use DOT Form 350-013 when establishing the group for the occurrence. This group will be used for only one occurrence. A new group will be required for each new occurrence.

If the item is included in the contract and a new occurrence of Third Party Damage occurs, use DOT [Form 350-013](#) to add a group for each new occurrence. You will need a group for each occurrence of Damage.

If additional information (responsible party, police reports, Field Notes, paynotes, etc.) becomes available after the initial report form has been submitted, you may send an updated form to the same routing. Be sure to indicate that this is a revised form by selecting the “Revised Report” radio button.

## **SS 1-07.14 Responsibility for Damage**

### **Claims Against the Contractor – Damage**

The Department has a claims office, now known as the WSDOT Risk Management Office (RMO). All receptionist job descriptions, all Region operations manuals, and all telephone training is set up to refer citizens with damage claims related to construction to the RMO and to provide the toll free number (1-800-737-0615). The RMO will react to the call, issuing claims forms, contacting the contractor, and following up on the actions taken. The Project Engineer's role is to appropriately advise the RMO, if needed. There may be confusion about which contract is involved. Field office knowledge about the incident and the surrounding circumstances may be solicited. The contractor's insurance and the insurance provided by the Contractor for the State may be involved and information about the policy will, most likely, be requested.

If, in spite of the Department process, the claimant contacts the field office directly, the Project Engineer should refer the claimant to the State Risk Management Office (1-800-737-0615).

### **Claims Against the Contractor – Money**

Claims received by the Region for money owed by the Contractor should be referred to the Contractor. A claimant should be advised of the legal right to file a lien against the retained percentage or performance bond for claims involving labor, equipment, or materials used on the project and be referred to the Accounting and Financial Services Division for obtaining the necessary lien forms.

### **Claims Against Officials and Employees**

The statutes provide that claims may be filed against the State of Washington, State officers and employees, for damages resulting from their conduct and prescribes the manner in which the action must be taken. Whenever this occurs, the state will furnish the legal defense and pay any judgments if the act which caused the alleged damage was within the scope of the person's duties, was in good faith, and without negligence.

## **SS 1-07.15 Temporary Water Pollution Prevention**

### **SS 1-07.15(1) Spill Prevention, Control, and Countermeasures Plan**

Spill Prevention, Control, and Countermeasures (SPCC) Plans are written by the Contractor to prevent, respond to, and report hazardous material spills in a safe and effective manner. All WSDOT projects should have a project specific SPCC Plan and the plan must be submitted to the Project Engineer prior to starting any on-site work. The plan should be reviewed by the Project Office for compliance with the WSDOT [Temporary Erosion and Sediment Control Manual](#) M 3109. WSDOT personnel who review SPCC Plans are required to take the Spill Plan Reviewer and Preparedness Training class available through the Learning Management System (LMS).

SPCC Plans should include information regarding the project site and contractor activities as they relate to spill prevention, control, and response activities. Additionally, SPCC Plans should identify possible sources of hazardous materials, methods to prevent and control spills, and spill response procedures. SPCC Plans are written and maintained by the Contractor and are required on all WSDOT projects, regardless of the size or duration of construction activities.

SPCC Plans are applied to the life of a construction project and may need to be amended over time with changing conditions. Periodic inspections will ensure that the required preparation and preventative steps identified in the SPCC Plan have been taken to keep the site in compliance throughout the life of the project.

The [Standard Specifications](#) provide the complete list of required contents for the Contractors SPCC Plan in Section 1-07.15(1).

## **SS 1-07.16 Protection and Restoration of Property**

### **SS 1-07.16(1) Private/Public Property**

[Standard Specifications](#) Section 1-07.16(1) restricts the contractor from using Contracting Agency owned or controlled property other than property directly affected by the contract work without the approval of the Engineer. The Engineer has the authority to allow the use of Contracting Agency owned or controlled property within the project limits and any other property specifically listed for use in the contract. The use of any other Contracting Agency owned or controlled property would require a lease agreement as detailed in WSDOT [Right of Way Manual](#) M 26-01 Chapter 11.

In many cases the courts have held that where the Project Engineer has exceeded their delegated authority their actions are binding upon Contracting Agency. Because of this, it is important that the Project Engineer make no instructions, verbally or by written memoranda, that are outside of their authority.

### **SS 1-07.16(4) Archaeological and Historical Objects**

It is both National and State policy to preserve historical or prehistorical objects and ruins. These objects and ruins may include sites, buildings, artifacts, fossils, or other objects of antiquity that may have particular significance from a historical, cultural, or scientific standpoint.

If provisions for archaeological and historical salvage have not been made in the contract and it appears that significant historic or prehistoric objects or ruins have been or are about to be encountered, the Project Engineer should immediately take steps to preserve and protect the objects or ruins. Once the objects or ruins have been sufficiently protected, the Project Engineer should immediately notify the Region Construction Manager, who will provide any necessary initial assistance to the Project Engineer. Where the Region determines appropriate, the Project Engineer will contact and inform through existing Region Environmental staff, the Cultural Resources Consultant, the State Historic Preservation Officer (SHPO), FHWA, and affected tribes of the discovery. The Project Engineer will also help facilitate any on-site meetings for the appropriate parties should either FHWA, SHPO, or the cultural resources consultant believes it necessary.

### **Cultural Resource Monitoring**

When cultural resource monitoring is necessary for a project, the Project Engineer will invite the Cultural Resource Specialist to the preconstruction meetings to review and explain project specific cultural monitoring requirements.

The Project Engineer will coordinate with the Contractor to ensure that notice is provided to the Region Environmental Office seven (7) calendar days prior to the beginning of any ground disturbing activities in any area designated as requiring monitoring.

The Project Engineer will coordinate with the Region Environmental Office to ensure that a monitor will be present on-site prior to the Contractor beginning any ground disturbing activities in any area designated as requiring monitoring.

On any project that has Cultural Resource Monitoring commitments, the Project Engineer will coordinate with the Region Environmental Office to ensure that a monitor is present and the appropriate notifications are made prior to the Contractor beginning any ground disturbing activities in any area designated as requiring monitoring.

### **Responsibilities Following Unanticipated Discovery of Cultural Resources**

Given the wealth of historical and archeological resources found in Washington, the Project Engineer should be familiar with the requirements of the National Historic Preservation Act (NHPA), *Standard Specifications* Section 1-07.16(4), and any contract specifications regarding the discovery of cultural resources. The Project Engineer should discuss these requirements with the Contractor and WSDOT staff at the Pre-Construction Conference. These resources include, but are not limited to:

- Human skeletal remains
- Anthropogenic soil horizons (areas showing the influence of humans on nature), occupational surfaces (areas showing evidence of human activity or habitation), midden (refuse heap), etc.
- Areas of charcoal or charcoal-stained soil and stones.
- Stone tools or waste flakes (i.e., arrowheads or stone chips).
- Bones, burned rocks, or other food related materials in association with stone tools or flakes.
- Clusters of tin cans or bottles.
- Logging or agricultural equipment more than 50 years old.

The Project Engineer will include a project-specific unanticipated discovery plan (UDP) in the project provisions for use by the Contractor. The UDP outlines the notification process and provides guidance to the Contractor should archaeological or historic resources be encountered during project activities. The Regional or Modal Cultural Resources Specialist will assist with completing the plan. The UDP template is available at: [www.wsdot.wa.gov/Environment/CulRes/Compliance.htm](http://www.wsdot.wa.gov/Environment/CulRes/Compliance.htm).

### **Discovery of Human Skeletal Remains**

The following guidance is given to assist the Project Engineer when construction activities cause disturbance to human skeletal remains. All human skeletal remains, which may be discovered, shall at all times be treated with dignity and respect.

Should any WSDOT employee, contractor, or subcontractor believe that he or she has discovered human skeletal remains; the following steps shall be initiated:

1. Ensure that all work adjacent to the discovery has ceased. The area of work stoppage shall be adequate to provide for the total security and protection of the integrity of the human skeletal remains.
2. The Project Engineer shall:
  - a. Notify the Region Construction Manager.

- b. Immediately notify the local coroner and the local sheriff, or other appropriate law enforcement official, requesting that a person who is competent and qualified to identify human skeletal remains be present. Do not call 911 or the media.
  - No persons other than the coroner or proper law enforcement personnel, WSDOT Cultural Resources staff, SHPO (State Historical Preservation Officer), and DAHP (Department of Archeological and Historic Preservation) staff will be authorized direct access to the discovery location. This access must comply with all safety and security procedures.
  - The coroner will make a determination as to whether the human skeletal remains are forensic (evidence of a possible crime) or non-forensic (historical). If the human skeletal remains are determined to be forensic, the coroner will retain control of the human skeletal remains and the discovery site will be treated as a crime scene. If the human skeletal remains are determined to be non-forensic, the coroner will notify DAHP.
  - The DAHP state physical anthropologist will make the initial determination as to whether the human skeletal remains are of Native American ancestry. If the human skeletal remains are determined to be of Native American ancestry, DAHP will notify the affected tribe(s).
- c. Notify the WSDOT Cultural Resource Manager at Environmental Services Office, who will notify:
  - FHWA Area Engineer or Environmental Program Manager.
  - State Historic Preservation Officer (SHPO).
  - WSDOT Tribal Liaison Office. The WSDOT Tribal Liaison Office will contact the affected tribe(s) and notify them of the unanticipated discovery.
  - Region Environmental Manager.
3. If the human skeletal remains are determine to be of Native American ancestry, tribal access will be allowed to the designated representative(s) of the affected tribe(s). WSDOT and FHWA will make a good faith effort to accommodate requests from affected tribe(s) to be present, prior to implementation of mitigation measures. The Project Engineer, WSDOT Cultural Resources, SHPO, and the affected tribe(s), in consultation, will determine what treatment is appropriate. If disinterment of Native American remains becomes necessary, FHWA, WSDOT, SHPO, and the affected tribe(s) will jointly determine the final custodian of the human skeletal remains for re-interment.

### Discovery of Other Cultural Resources

The following guidance is given to assist the Project Engineer when construction activities cause the disturbance of cultural resources, other than human skeletal remains.

Should any WSDOT employee, contractor, or subcontractor believe that he or she has uncovered a cultural resource, at any point in the project, the following steps should be initiated:

1. Ensure that all work adjacent to the discovery has ceased.
2. Immediately notify the Project Engineer. The Project Engineer shall immediately notify:
  - a. The Region Construction Manager



- b. The WSDOT Cultural Resource Manager at the Environmental Services Office who will notify:
  - FHWA Area Engineer or Environmental Program Manager
  - State Historic Preservation Officer (SHPO)
  - WSDOT Tribal Liaison Office
  - Region Environmental Manager
3. Ensure that the area of work stoppage is adequate to provide total security and protection of the integrity of the resource. Vehicles, equipment and unauthorized personnel will not be permitted to traverse the site, nor will work resume, until treatment of the cultural resource is completed.
4. All archeological deposits discovered during construction are to be treated as if they are eligible for inclusion in the National Register of Historical Places (NRHP). Intentional disturbance of archeological sites without a permit from DAHP is prohibited by [RCW 27.53](#). Disturbance of Indian burials, cairns and glyphs is prohibited by [RCW 27.44](#).
5. If cultural resources are discovered, but additional project effects to the resource are not anticipated, project construction may resume, away from the site of the discovery, while documentation and assessment of the resource proceeds.

## **SS 1-07.17 Utilities and Similar Facilities**

### **Relationship with Public and Private Utilities**

In some cases, utility adjustments will be completed prior to contract work. In other cases, adjustments are to be made concurrently with the work. The Project Engineer and the Contractor should meet with the public utility companies, individuals, and others owning or maintaining utility features within the limits of the highway right of way and confirm the relationship, the terms of the relocation agreements, and the relocation work schedule. Where the feature will require adjustment during construction, notice should be provided far enough in advance to allow the utility to perform the adjustment without affecting the Contractor's work schedule.

Utilities should have been given prints of the preliminary plans, prior to awarding of the contract, showing grade lines and right of way to enable them to prepare plans and estimates for making the necessary changes to their facilities in as timely a manner as possible. The Project Engineer should determine that plans for the work have been made, that the relocated facilities will be clear of the construction, and that the utilities coordinate with the Contractor's operations to the fullest extent possible.

When utilities are known to exist within the limits of the project and are not planned for relocation but may be affected by the Contractor's construction activities, the Project Engineer and the Contractor should become familiar with the requirements of [RCW 19.122](#), Underground Utilities. The Project Engineer may wish to obtain copies of the RCW for review at Preconstruction Meetings.

The approximate locations of most existing underground utilities are shown on the contract plans. However, the existence of some underground utilities may not have been known or detected during design. If a one number locator service is available, the Contractor must utilize it in an attempt to locate all affected utility features. If no one number locator service is available, notice shall be provided individually to those owners

of underground facilities known to have or suspected of having underground facilities within the area of proposed excavation. Even areas covered by a one number service may contain utilities not included in the service. If the Contractor discovers underground facilities which are not identified, the Contractor shall cease excavating in the vicinity of the facility and immediately notify the owner or operator of such facilities, or the one number locator service.

### **Work Performed Under Utility Agreements**

Utility agreement work associated with a contract exists in two categories. The first is work done for a utility by WSDOT that is included in the contract and performed by the WSDOT contractor. The second is work done, either by the utility or the utility's contractor, that is associated with and done near the WSDOT project.

If the utility work is included in the contract, the plans will show the work and will include pay items exactly as if the work was part of the transportation improvement. The responsibility of the Project Engineer is to treat this work the same way that "normal" work is handled. There will be a necessity for communication with the utility itself, inviting comments and joint reviews and inspection of the work. In many cases, the utility will provide materials or equipment to be incorporated into the work. The utility will also provide certification that provided material meets the requirements of the contract. If problems arise and changes are considered, there are additional paperwork demands. The Project Engineer should consult with the Utility and the Region Utility Engineer.

If the work is associated with the project, or if unrelated work is being done nearby, and the utility or its contractor is performing the work, the Project Engineer should treat the neighboring work in the same manner that adjacent WSDOT work would be treated (see [Standard Specifications](#) Section 1-05.14 and Section [SS 1-07.17](#).)

### **Responsibility for Coordination of Railroad Agreements**

When railroads are involved within the project limits, an agreement covering the work involved is usually entered into between WSDOT and the Railroad Company. Upon identifying that the contract involves work or involvement by a railroad, the Project Engineer should immediately obtain a copy of the Railroad Agreement or contact the Region Utilities Engineer to determine the status of the agreement and to make sure it contains all elements needed to accommodate the construction of the project. If an agreement has not been made with the railroad, the Project Engineer should coordinate and monitor the development and processing of the agreement through the Region Construction and Region Utilities Engineers. Where notices are required, The Project Engineer should ensure that proper notice is provided to the railroad company and that such notice is acknowledged by them. The Project Engineer should work with the Region Construction Manager and Utilities Engineer to resolve any conflicts with the Railroad Company and prevent delays to the Contractor's operations.

### **Work Performed Under Railroad Agreements**

Railroad work associated with a contract exists in three categories. The first is work done for a railroad by WSDOT that is included in the contract and performed by the WSDOT contractor. The second is work done, either by the railroad or the railroad's contractor, that is associated with and done near the WSDOT project. The third category is railroad protective services. Protective services, such as flagging, are typically provided by the railroad.

If the railroad work is included in the contract, the plans will show the work and will include pay items exactly as if the work was part of the transportation improvement. The responsibility of the Project Engineer is to treat this work the same way that “normal” work is handled. There will be a necessity for communication with the railroad itself, inviting comments and joint reviews and inspection of the work. In many cases, the railroad will provide materials or equipment to be incorporated into the work. The railroad will also provide certification that provided material meets the requirements of the contract. If problems arise and changes are considered, there are additional paperwork demands. The Project Engineer should consult with the Railroad Company and the Region Utility Engineer.

If the work is associated with the project, or if unrelated work is being done nearby, and the railroad or its contractor is performing the work, the Project Engineer should treat the neighboring work in the same manner that adjacent WSDOT work would be treated (see [Standard Specifications](#) Section 1-05.14 and Section [SS 1-07.17](#).)

Protective services may be called for when the Contractor is performing work on railroad facilities (first category above) or when the Contractor’s work is conflicting or adjacent to a railroad facility that is not being changed. Typically, the railroad will determine the need for service, provide the protective services, and send the bill to WSDOT. There may be an agreement in place, or the railroad’s actions may be unilateral. On all projects including railroad flagging, the Project Engineer will notify the Railroad Company when all work involving the railroad is physically complete.

The addition or revision of agreements with the railroad can be lengthy processes. The Project Engineer should stay alert for possible changes and the need for revisions to the agreement. When these arise, the Railroad Company and the Region Utility Engineer should be contacted early and often.

### **Railroad Flagging**

All dollar amounts actually incurred by the Railroad Company for railroad flagging, under the terms of the typical railroad agreement, will be paid by WSDOT. The Contractor will incur no costs for railroad flagging unless the flagging is for the Contractor’s benefit and convenience. In this case, the Project Engineer will deduct this cost on monthly progress estimates as a below the line item in the Contract Administration and Payment System.

### **SS 1-07.18 Public Liability and Property Damage Insurance**

Projects which include work on railroad right of way generally require special insurance protection. Pay particular attention to the Contract Special Provisions for project requirements because they vary from project to project. It is the responsibility of the Project Engineer to enforce the provisions. The required insurance documents are to be furnished by the Contractor (usually through the Project Engineer) to the Accounting and Financial Services Division who will (a) review the documents and (b) obtain approval of the insuring documents from the railroad company. Written notification of approval by the railroad company will be furnished to the Project Engineer by the Accounting and Financial Services Division as soon as approval is obtained.

No work shall be started on railroad property until the necessary approvals have been obtained. The railroad insurance must be maintained until the date of physical completion of the project unless otherwise stated. However, the Contractor may make a written request to be relieved of the responsibility to continue all or part of the railroad protective

liability insurance before the completion date under certain conditions. The details and conditions for this relief are specifically set forth in the special provisions of the contract. If the Contractor should make a request for relief, the Project Engineer should contact the Region Construction Manager and Utilities Engineer for guidance and assistance in coordinating this effort with the railroad.

### **SS 1-07.23 Public Convenience and Safety**

#### **SS 1-07.23(1) Construction Under Traffic**

##### **General**

Under the many special conditions encountered where traffic must be moved through or around construction operations, serious problems of traffic control can occur. Most conditions are temporary and are, therefore, dangerous and difficult to deal with because they are unexpected and not in accordance with the normal pattern of highway traffic. *Standard Specifications* Section 1-07.23(1) requires the Contractor to conduct all operations with the least possible obstruction and inconvenience to the public and to provide adequate safeguards, safety devices, protective equipment, and any other needed actions to protect the life, health, safety, and property of the public. The responsibility to comply with these requirements is the Contractor's. It is the Project Engineer's responsibility to ensure that the Contractor complies.

Any deviation from these requirements shall only be allowed if the Contractor has requested the deviation in writing and the Engineer has provided written approval. The Region Traffic Office should be contacted to help evaluate the deviation and determine if the requested deviation is approvable.

##### **Speed Reductions**

If speed reductions are considered, the Project Engineer shall follow Executive Order E 1060 and the guidance found in *Traffic Manual* Appendix 5B.

##### **Temporary Breaks in Limited Access for Construction**

The Federal Highway Administration (FHWA) cannot delegate its approval authority to add access points to existing limited access controlled Interstate facilities through the WSDOT-FHWA Stewardship Agreement. The FHWA has granted approval to break limited access in order to gain access to the worksite from adjacent properties. This approval was granted through the FHWA approval of *Standard Specifications* Section 1-07.16. This approval does not extend to allowing the contractor to use this access to merge construction vehicles and equipment with public traffic in the traveled way, auxiliary lanes, or shoulders. It is therefore necessary to seek approval from the FHWA when proposing to break limited access and merge construction vehicles with public traffic in the traveled way, auxiliary lanes, or shoulders.

*Standard Specifications* Section 1-07.16 allows the contractor to access the worksite from adjacent properties but does not allow the contractor to merge construction vehicles or equipment (including contractor workforce vehicles of any type) from that access with public traffic. *Standard Specifications* Section 1-07.23 allows the Interstate highway system to be accessed through existing facilities or through access points allowed within the contract only. These access points allowed in the contract will either be in the form of site-specific traffic control plans or by contract provisions included in the contract documents.

If the contractor proposes to merge construction vehicles with public traffic in the traveled way, auxiliary lanes or shoulders and the contract contains the General Special Provision (GSP) that allows this access, then the contractor shall submit a site-specific plan for traffic control in accordance with the MUTCD Part VI. The Region Traffic Engineer should review this plan and it should be submitted to FHWA.

During construction on Interstate projects the Project Engineer will notify the appropriate Assistant State Construction Engineer (ASCE) who will forward the information to the FHWA Area Engineer and the WSDOT Access Manager by sending them a copy of the approved vicinity map showing the location of the access break and site-specific traffic control plan. FHWA approval of a PS&E containing this GSP constitutes approval of access from adjacent properties to the traveled way, auxiliary lanes or shoulders. Consultation with Region and Headquarters Design offices and approval by FHWA must occur prior to deciding to include this GSP in a contract on Interstate facilities.

While some contracts may not contain provisions for breaking limited access for construction and for merging of construction vehicles with mainline and/or interchange ramp traffic, the contractor may request one. If the Region agrees and the project is on limited access-controlled Interstate, the Project Engineer shall contact the appropriate ASCE who will forward the request to the FHWA Area Engineer for approval. The ASCE will cc the Access Manager when forwarding the request to FHWA. The contractor shall submit a vicinity map showing the location of the access break, a site-specific plan for traffic control in accordance with the MUTCD Part VI, and the duration for which the accesses will be in operation. On non-interstate limited access-controlled facilities, approval will be required by the Region. If approval is granted and the facility is a limited access facility, the GSP will be added to the contract by change order. On managed access roadways the Project Engineer, with Region concurrence, has approval authority to grant the contractor temporary access, in accordance with the [Standard Specifications](#).

### **Public Information and Customer Focus**

Most drivers still have the expectation of proceeding to their destination with little or no delay even though traffic conditions on many of our highways are deteriorating, primarily due to increased traffic volume. This increased volume may create congestion, delays, accidents, and aggressive driving during normal daily operation. Highway construction will usually require a more restricted roadway to accommodate work zones and can further reduce traffic mobility and safety. Even some of our lower volume rural highways can present a challenge due to factors such as drivers not expecting construction work and seasonal/recreational traffic increases. Construction and user delays present significant costs in addition to costs associated with crashes and worker safety. These delays and costs can be minimized by implementing a traffic control strategy based on traffic conditions and construction requirements, and which includes public information and customer focus considerations.

Our goal on every highway construction project should be to provide the best overall balance of work zone safety and traffic mobility while constructing quality highway projects. Much of our effort is directed at engineering responses to safety and mobility issues and is generally included in the contract requirements. Recent customer focused highway construction studies have shown that accurate and timely project information is a valuable element in an overall traffic control strategy. Advance planning and coordination between the project engineer and contractor is necessary to ensure that there is an opportunity to provide public information for all phases of the project that

impact traffic. Proper use of public information and customer focused techniques will provide safety and mobility benefits that would not otherwise be gained, as listed below:

- Alert drivers to potential delays by advance notice through project signing and the news media that would allow drivers to take alternate routes, adjust scheduled trips and have better awareness of traffic impacts and how to avoid them.
- Provide benefits to the Contractor from reduced traffic volume and better driver awareness through fewer crashes, less material delivery delay, better worker safety, fewer complaints, and overall public acceptance of the project.
- Achieve better driver acceptance, reduced aggressive driving and improved work zone credibility by minimizing delays and providing accurate and timely information.
- Consider innovative construction techniques and shorter-term intense work stages with more severe traffic restrictions, such as weekend closures, if possible.
- Closely monitor traffic conditions when traffic is restricted to determine the need for any traffic control or work hour adjustments that would improve traffic flow. Specified working hours and the accompanying traffic restrictions are critical elements of the project traffic control strategy and should not be adjusted without proper traffic analysis.
- Maintain ongoing communication during the life of the project with local law enforcement, emergency services, local agencies, transit groups, affected local businesses, etc.
- Continue use of innovative devices such as portable, changeable message signs, project information signs with information phone number and highway advisory radio systems.

The Regional Construction Manager, Traffic Engineer, and Public Information Officer should be involved in the project traffic control strategy and may be able to offer assistance.

### **Road/Ramp Closures and Use Restrictions**

When it is necessary to close a road, street, or ramp, the Project Engineer shall submit a request that includes the appropriate closure/detour plan to the Region Traffic Engineer in advance of the need. Per [RCW 47.48.010](#), the Regional Administrator may close a road, street, or ramp.

With proper planning and implementation, road/ramp closures can be an effective and safe method of traffic control. As required by RCW, notice of the closure shall be published in one issue of a newspaper in the area in which the closure is to take place. Signs indicating dates and times of the closure shall be placed at each end of the Section to be closed on or before publishing the notice in the newspaper. Publishing the notice and placing of the signs shall be a minimum of three days in advance of the closure. Advance notice using local radio, portable changeable message signs or HAR may be effective in diverting traffic from the closed or impacted locations.

Coordinate with the Region Public Information Officer for assistance with public notification.

In cases of emergency, or closures of 8 hours or less, the road, street, or ramp may be closed without prior notice to the public. If possible, a notice should be posted one working day in advance of the closure.

When planning to close or restrict use for more than 8 hours on one or both directions of mainline on Interstate systems, system to system ramps or Federal-aid Primary Routes, FHWA must be notified as shown in the table below. Use restrictions are defined as any limitation on the vehicle type, load or function of the facility. These notification requirements apply even to projects with onsite or offsite detours in place. Federal-aid Primary Routes are US routes 2, 12, 97, 101, 395 and State Routes 16, 18, 99, 167, 520, 522. FHWA notification shall be made to the following email address: [washington.fhwa@dot.gov](mailto:washington.fhwa@dot.gov)

WORK Activity	WSDOT Action
Interstate closures or use restrictions of 7 or more consecutive days	Send notification to FHWA 60 days in advance of potential closure and provide updates as available
Federal-aid Primary Routes closures or use restrictions of 7 or more consecutive days	Send notification to FHWA 14 days in advance and provide updates as available
Interstate closures or use restrictions between 48 hours and 7 consecutive days	Send notification to FHWA 14 days in advance and provide updates as available
Interstate closures or use restrictions between 8 hours and 48 consecutive hours	Send notification to FHWA 7 days in advance and provide updates as available

### Pedestrian Safety

When the work area encroaches upon a sidewalk, crosswalk, or other areas that are near an area utilized by pedestrians or bicyclists, special consideration should be given to their accommodation and safety. Pedestrians are more susceptible to personal injury in work areas than are motorists. Visibility and recognition of hazards is an important requirement for the safety of pedestrians and bicyclists.

Protective barricades, fencing, handrails, and bridges, together with warning and guidance devices, should be used so that pathways for pedestrians, bicyclists, equestrians, and other non-motorists are safe and well defined. Where walks are closed by construction or maintenance, an alternate walkway should be provided where feasible. Where it is necessary to divert pedestrians into the parking lane of a street, barricades and delineation should be provided to separate the pedestrian walkway from the adjacent traffic lane. Pedestrians should not be diverted into a portion of the street used by vehicular traffic. At locations where adjacent alternate walkways cannot be provided, pedestrians can be diverted across the street by placing appropriate signs at the construction limits and at the nearest crosswalk or intersection. When hazardous work conditions exist overhead, it may be necessary to install a fixed pedestrian walkway of the fence or canopy type to protect and control pedestrians. In such cases, wood and chain link fencing can be used with warning lights and illumination to warn and guide both pedestrians and motorists. These accommodations for pedestrians and bicycles should be included in Traffic Control Plans.

Fences around a construction area are often necessary and may be a requirement of the local jurisdiction building code. They are often constructed in conjunction with a special pedestrian walkway or when there are deep excavations or when pedestrian access to the job site is not desirable. Installation of such fencing must consider relocation of existing control devices and facilities such as traffic signals, pedestrian signals, traffic signs, and parking meters. The use of chain link fencing which can be seen through may be needed at intersections to provide adequate sight distance.

Relocating a walkway without unreasonable inconvenience to pedestrians, residents, or commercial interest, is the safest practice of all. Remember, however, that pedestrians like to “see what’s going on.” Simply denying them access does not, of itself, prevent their encroachment onto the worksite. Sometimes it is advisable to design and construct a pedestrian observation area for this purpose.

### SS 1-07.23(2) Construction and Maintenance of Detours

Construction zone detours will normally be detailed in the plans. When detours not shown in the plans are required, the design will likely be done by the Project Office under the direction of the Project Engineer and requirements of the MUTCD. If the detour is a full-fledged roadway, design and traffic reviewers should check the design. Short-term minor detours may be installed and operated without formal review, but the Project Engineer must be satisfied that the facility is suitable and safe for traffic use.

Existing pavement markings on asphalt pavement shall never be merely blacked out with oil or paint; this is not allowed by the MUTCD. Rather, the striped and adjacent areas should be hydroblasted, or ground in a pattern different from the original marking until the marking is no longer visible. This change in pattern minimizes the possibility that the original marking will still be visible to drivers, especially at night or in rainy weather when covered-over stripes tend to shine in contrast to the pavement. Temporary pavement marking tape, either for temporary lane marking or masking of existing markings may offer another option and approved removable tapes are listed on the Qualified Products List (QPL). Existing conflicting markings should never be allowed to remain in place. When markings remain from an alignment shift or the marking goes under a device (like barrier), the existing marking must be removed to eliminate confusion to the motorist.

Temporary concrete barrier should be part of the plan design for positive protection of the work area. Barrier is not to be used as primary delineation to guide traffic. A combination of pavement markings and temporary channelization devices are to be used along with the barrier. Temporary barrier delineators must be maintained and kept clean. When delineators become covered with grime or are damaged, they become ineffective. The condition and positioning of these devices should be checked daily.

### SS 1-07.23(3) Work Zone Clear Zones

When a project requires traffic control, a Work Zone Clear Zone (WZCZ) shall be established and will apply during both working and non-working hours. During non-working hours no equipment or materials shall be within the WZCZ, unless it is protected by permanent guardrail or temporary concrete barrier (location and installation to be approved by the Project Engineer). During working hours, unless protected as stated for non-working hours, only materials or equipment absolutely necessary to construction shall be allowed in the WZCZ or allowed to park on the shoulder of the roadway.

The minimum clear zone distance, measured from the edge of traveled way, shall be based on the posted speed as follows:

Posted Speed	Distance From Traveled Way
35 mph or less	10 ft
40 mph	15 ft
45 to 50 mph	20 ft
55 to 60 mph	30 ft
65 mph or greater	35 ft



## 1-08 Prosecution and Progress

### SS 1-08.1 Subcontracting

Requests by the Contractor to sublet Work are submitted on a Request to Sublet Work (RTS) DOT [Form 421-012](#) for approval by the Project Engineer or designee. The request will not be approved if the Contractor is debarred from bidding on or performing work on a public works Contract (search Debarred Contractors on the Labor & Industries webpage). The request must be reviewed in order to ensure that the proposed Subcontractor meets the requirements of [WAC 296.127.10](#).

The request must be approved prior to the performance of any work on the Contract by either the Subcontractor or a lower-tier Subcontractor. If more than one Subcontractor on a project wants to utilize the same firm as a lower-tier subcontractor, a separate RTS is required.

A copy of the Statement of Intent to Pay Prevailing Wages (SOI), approved by the Washington State Department of Labor & Industries (LNI), must be provided to the Project Engineer by the Contractor prior to payment for any work performed by that subcontractor or lower-tier sub. An SOI will be required for each subcontract, even if the subcontractor has already submitted an SOI for work under another subcontract. A SOI is required for every Subcontractor or lower-tier sub unless documentation is provided from LNI stating that their work is not covered by prevailing wage laws.

In addition, for Federal-aid projects, a Certification for Federal-Aid Projects DOT [Form 420-004](#) must be submitted with the Request to Sublet (RTS) prior to any subcontractor or lower tier subcontractor beginning work. Non-submittal of the Certification for Federal-Aid Projects will result in rejection of the RTS.

*Standard Specifications* Section 1-08.1 defines what is not considered to be subcontracting. By default, any entity performing bid item work on the project is a Subcontractor, unless: (1) they are the Prime Contractor, (2) an Owner furnished resource (such as WSP, utility owner or its Contractor or consultant), or (3) they are specifically excluded from consideration as a Subcontractor in *Standard Specifications* Section 1-08.1.

Do not be confused by the distinction between Professional Services and Subcontractors in the markups for force account work described in *Standard Specifications* Section 1-09.6. Those provisions apply only to how the markup for overhead and profit is applied to force account work, and they have no relationship to the requirement for a RTS. If a Contractor is performing bid item work on the Contract, and they do not qualify for one of the two exceptions listed in *Standard Specification* 1-08.1, a RTS is required.

*Standard Specifications* Section 1-08.1 outlines the requirements to approve the RTS and also sets limitations on the amount of work a Subcontractor or lower-tier Subcontractor may perform. The dollar value to be used for determining the amount of work that must be performed by the Prime Contractor is the total original Contract amount less the amount of any specialty items which have been subcontracted.

In order to ensure proper tracking and reporting of sublet information, the Project Office will enter data from each RTS into CCIS. When the Project Office is in a situation where CCIS is not utilized during the administration of a project (i.e., Emergency Contracts, State Aid Contracts), and requires the “hand calculation” of the percentage of amount sublet, the percentage will be calculated for all items except specialty items, using the amount shown on the RTS or the bid amount whichever is smaller.

Every Contractor is required to report payments as described in Section 1-08.1. A Contractor withholding payment from a Subcontractor must notify the Subcontractor and the Contracting Agency identifying the reason for the withholding and providing remedy for the release of payment. If the Contractor fails to make the proper notifications, and the Project Office becomes aware of a withheld Subcontractor payment, the Project Engineer shall notify the Prime Contractor in writing. If the issue is not resolved prior to the next progress estimate, the Project Engineer will withhold same amounts that were withheld from the Subcontractor.

On Federal-aid projects, the request may indicate that the Subcontractor is a Disadvantaged Business Enterprise (DBE) or a Federal Small Business (FSBE).

When Condition of Award (COA) items are sublet, compare the RTS and the Utilization Plan with the information entered into DMCS to ensure accuracy. The RTS could include additional bid items and could have a sublet amount greater than the COA amount. The RTS cannot be approved if the sublet amount is less than the COA amounts shown in DMCS.

On projects funded wholly by the State, the request may indicate that the Subcontractor is a Minority Business Enterprise (MBE), Small Business Enterprise (SBE), Veteran Business Enterprise (VOB) or a Women Business Enterprise (WBE).

Upon receipt of the request, the Project Office should verify that the Subcontractor is certified by using the links at: <https://wsdot.diversitycompliance.com>.

Once the request has been verified and approved, enter the information into CCIS and verify the Subcontractor has been added to DMCS to enable tracking and reporting. DOT [Form 421-012](#) allows the Contractor to indicate more than one type of certification for Subcontractors, however only one type may be entered into CCIS. Use the following order of precedence when determining the certification for CCIS:

Federal Funded	State Funded
DBE	MBE
FSBE	WBE
MBE	VOB
WBE	SBE
VOB	DBE
SBE	FSBE

### **SS 1-08.1(1) Prompt Payment, Subcontract Completion and Return of Retainage Withheld**

The Project Engineer will ensure that the Contractor and all subcontractors make payment to all subcontractors of whatever tier in accordance with the requirements of [RCW 39.04.250](#).

The Project Engineer shall also ensure that if a contractor or subcontractor withholds payment from a subcontractor they follow the procedures as described in [Standard Specifications](#) Section 1-08.1(1).

If the withholding is not resolved prior to the next progress estimate payment to the Contractor, the Project Engineer will withhold an amount equal to the amount withheld from the subcontractor from the next progress estimate payment to the Contractor. If the withholding is not justifiable or the Contractor fails to comply with the prompt pay requirements, the Project Engineer shall consult with the State Construction Office to determine the appropriate use of the remedies described in Section 1-08.1(1), No. 7.

Within 15 calendar days after the Prime Contractor receives their monthly progress payment, a current copy of the Monthly Retainage Report (WSDOT Form 272-065) shall be emailed by the Prime Contractor to the appropriate Region email address as listed in the General Special Provision. The Monthly Retainage Report shall be submitted each month until every subcontractor and lower tier subcontractor's retainage has been released. The form shall be made available to the Prime Contractor at the Pre-Construction Conference. No further action is needed by the Project Office, unless the Region OECR Compliance Specialist requests that the Project Engineer contacts the Prime Contractor due to non-submittal. A letter of non-compliance will be issued, and payment may be withheld in the event of habitual non-compliance.

### **SS 1-08.3 Progress Schedules**

#### **SS 1-08.3(1) General Requirements**

The requirements for progress schedules are specified in [Standard Specifications](#) Section 1-08.3. A copy of the specified reference, Construction Planning and Scheduling, Second Edition, published by the Associated General Contractors of America, was sent to each Project Office and each Region Construction Office. Regions and Project Offices may order additional copies from: <http://store.agc.org/ePubs/ePubs/3502EB>. One of three progress schedules will be specified in the Contract. Two types of progress schedules are identified in the [Standard Specifications](#), Type A and Type B. A third type may be inserted in the contract as a General Special Provision specifying a Type C Progress Schedule. The three types of progress schedules represent levels of job complexity. Type A being the simplest and easiest to produce and Type C being the most complex. Application is such that the complexity of the project (whether it be timing, coordination, or the work itself) will be reflected in the complexity of the schedule.

In addition, a preliminary schedule is required on contracts requiring Type B or C Progress Schedules. Preliminary progress schedules show the work to be accomplished within the first 60 working days. As always, the Contract Provisions may contain requirements that add to, or supersede, all or parts of [Standard Specifications](#) Section 1-08.3 to allow for special circumstances.

There are four basic reasons that we ask for a schedule:

- To better understand the Contractor's plan to deliver the project within the time allowed
- To plan our work force and other resource requirements
- To advise the public and executive staff of major milestones
- And to enable us to actively manage impacts to the contract

Progress schedules should have sufficient detail such that the progress of the work can be evaluated accurately at any time during the performance of the contract. The owner is obligated by contract to return the schedule for correction or approve it within 15 calendar days of receipt. Approval requires that the schedule complies not only with [Standard Specifications](#) Section 1-08.3 but it demonstrates compliance with other contract requirements such as interim completions, staged work, order of work, etc. Periodically, as warranted by progress, delays, or changes, the Project Engineer should review the schedule for accuracy and progress of work. If it is determined that the current schedule does not provide the required information or is no longer accurate, a schedule update may be requested from the Contractor. Monthly updates are required when Type C progress

schedules are specified, and the cost of the updates is included in the Lump Sum price of the Bid item.

The cost of Type B schedule updates is not included in the Lump Sum price of the bid item. When work is added to the project or the work method is changed at the request of the contracting agency, the respective cost to update the Type B progress schedule should be included in the change order. Type B schedule updates driven by the Contractor's actions shall be provided to the Contracting Agency and are considered incidental to other work. No payment is made for Type A Progress Schedules or Type A schedule updates. Type B and C Progress Schedules are paid as a lump sum. Eighty percent of the lump sum payment is paid upon approval of the initial schedule. The remaining portion is paid when eighty percent of the original work is completed, provided updates have been provided as requested. Weekly look-ahead schedules are considered incidental to other items of work in the contract and therefore are not paid for separately.

When the Contractor has failed to provide a required schedule, the Engineer may:

- Withhold payment for the Type B or Type C schedule if it is not received (but not for other conforming work).
- Withhold all progress payments for failure to comply with the terms of the contract as specified in [Standard Specifications](#) Section 1-09.9 (this should be a rare event).
- Suspend work and continue to charge each day as workable (this should only be implemented when the Agency is harmed by lack of knowledge of the contractor's intended approach to the work).

In extreme cases, the Agency may determine that the Contractor is in breach of contract according to [Standard Specifications](#) Section 1-08.10 (usually accompanied by other serious breaches).

When lacking a progress schedule, the Engineer must base progress on the information available and their best judgment. According to [Standard Specifications](#) Section 1-08.5, the Contractor may protest working day charges, but must support the protest in sufficient detail to enable the Engineer to ascertain the basis and amount of time disputed by following the protest procedures in Section 1-04.5.

### Review and Approval of Progress Schedules

It is the responsibility of the Project Engineer to ensure that the Contractor submits a correct and complete progress schedule in the time specified. Progress schedules must meet the general as well as type-specific criteria. Once it is determined that the progress schedule submitted is of the type specified by the contract, the Project Engineer should evaluate the schedule to determine if it meets the requirements of [Standard Specifications](#) Section 1-08, the Special Provisions and the Contract.

- The progress schedule must include all activities necessary to physically complete the project. By definition, activities consume time and usually consume resources. Activities like concrete curing time and slope staking earthwork may be rolled-up into the overall duration of the activity.
- The progress schedule must show the planned order of work in logical sequence, and in compliance with any requirements of the contract. The reviewer should remember that some work is sequenced by factors inherent in the work, but the Contractor may sequence the work by their preference as long as the project is completed within the authorized time and in conformance to the contract.

- The progress schedule must show durations of work activities in working days. Except for defining nonworking days, the calendar has no relationship to administering contract time. An activity may be stalled by unsuitable weather for days or weeks and remain “on schedule.”
- The progress schedule must show activities in durations that are reasonable for the intended work. Since durations of work are a function of resource allocation, the Project Engineer may be required to estimate production rates using estimating manuals, experience or other resources, or to ask the Contractor to explain their planned resource allocation to support the duration.
- The progress schedule must define activities in sufficient detail that progress of individual activities may be evaluated daily. The reviewer should keep in mind that the level of detail required in a progress schedule is driven by the amount of precision required to perform and monitor the work. For example, a single activity that represents several miles of grading may not provide adequate detail and may need to be subdivided into smaller activities described by station limits.
- The progress schedule must show the physical completion of all contract work within the authorized contract time.

WSDOT may accept a Progress Schedule indicating an early physical completion date but cannot guarantee that WSDOT’s resources will be available to meet an accelerated schedule.

If the progress schedule does not provide the required information, it should be returned to the Contractor for correction and resubmittal. Because the [Standard Specifications](#) do not specify timelines for resubmittal, the Engineer should provide a reasonable amount of time for the Contractor to revise and resubmit the schedule, and advise the Contractor of the expected date of resubmittal.

## SS 1-08.3(2) Progress Schedule Types

### Type C Progress Schedule

Type C Progress Schedules are required for all projects that include the bid item for Type C Progress Schedule. The Contractor is to submit a preliminary Type C Progress Schedule to the Engineer no later than the first working day (as defined in [Standard Specifications](#) Section 1-08.5). The preliminary schedule must meet all requirements of a Type C Progress Schedule and of [Standard Specifications](#) Section 1-08.3(1) except that it may be limited to activities occurring within the first 60 working days.

The Contractor is required to submit a Type C Progress Schedule no later than 60 calendar days after the contract is executed.

Each time that a preliminary schedule, Progress Schedule, or Schedule Update is submitted, the Contractor is required to provide the Engineer with an electronic copy of that schedule, in Primavera Project Manager Enterprise Version, P6.

Type C Progress Schedules must contain all of the information required of a Type B schedule, and the following additional information:

- A timed scale logic diagram.
- Activities for traffic detours and closures.
- Milestones for required delivery of State furnished materials (if any)
- Activities for State furnished traffic control resources (if any).

- Activities for fabrication of materials with longer than 90 calendar days lead time.
- Fixed constraints shall be identified on the activity listing and be supplemented with a written narrative describing why the constraint exists.
- Milestones for interim or stage completion dates.
- Activities for scheduled outages on illumination systems, ITS systems, traffic signal systems and other electrical service outages.
- Nighttime activities shall be so coded.
- Activities for all submittals requiring State review, including the allowable review duration.

If requested by the Engineer, the Contractor shall provide a written narrative describing assumed production rates and planned resource allocation to support activity durations.

### **SS 1-08.3(2)A Type A Progress Schedule**

Type A Progress Schedules are required for any projects that do not include the bid item for Type B Progress Schedule or Type C Progress Schedule. The Contractor is required to submit the Type A Progress Schedules to the Engineer no later than 10 days after the date the contract is executed, or some other mutually agreed upon submittal time. This may be a critical path method (CPM) schedule, a bar chart, or other standard schedule format, such as fenced bar charts, linear schedules, PERT networks and others. These scheduling methods are described in detail in the benchmark document "Construction Planning and Scheduling, Second Edition, ". The Contractor is required to identify the critical path of the project, because a bar chart schedule does not rely on network calculations to determine the critical path.

The Engineer will evaluate this schedule and approve or return it for correction within 15 calendar days of receiving the submittal.

### **SS 1-08.3(2)B Type B Progress Schedule**

Type B Progress Schedules are required for all projects containing the bid item for Type B Progress Schedule.

The Contractor is required to submit a preliminary schedule to the Engineer no later than five calendar days after the date the contract is executed. Preliminary schedules must meet all requirements of a Type B Progress Schedule except that they may be limited to activities occurring in the first 60 days of the project.

The Contractor is required to submit a copy of the Type B Progress Schedule to the Engineer no later than 30 calendar days from the date that the Contract is executed. This schedule must be a critical path method (CPM) schedule developed by the Precedence Diagramming Method and may employ restrains provided the restraints do not alter the network logic or critical path. As a minimum the Type B Progress Schedule must show:

- The Contract Number and Title
- Construction Start Date
- Critical Path
- Activity Description
- Milestone Description
- Activity Duration
- Predecessor Activities
- Successors Activities
- Early Start and Early Finish for each activity
- Late Start and Late Finish for each activity
- Total Float and Free Float for each activity
- Physical Completion Date
- Data Date

(Many of these terms are defined in “Construction Planning and Scheduling.”)

The reviewer should watch for fixed date constraints that override network logic and force activities to become critical. Specific work windows or “open to traffic” milestones may legitimately influence sequence and duration of related activities. Fixed completion milestones for work that is susceptible to unsuitable weather are inappropriate because completion may be extended by the determination of unworkable days.

It is not unusual to see dual critical paths on a CPM schedule, nor is it prohibited. Multiple critical paths are generally very short in duration. Lengthy occurrences of parallel critical activities should be cause for scrutiny of activity durations and sequencing.

The Engineer will evaluate this schedule to ensure that all required information is included in the schedule, check the network calculations, and approve or return it for correction within 15 calendar days of receiving the submittal.

### **SS 1-08.3(2)D Weekly Look-Ahead Schedule**

Weekly Look-Ahead Schedules are required for all projects. The Contractor is required to submit a Weekly Look-Ahead Schedule, for each week that work is to be performed on the project, showing Contractor and all subcontractor activities for the next two weeks. The Weekly Look-Ahead Schedule must show:

- Description of the work.
- Duration of the work.
- Sequence of the work.
- Planned hours of work.

The specification requires that Look-Ahead Schedules show the contractor’s planned hours of work. This information is necessary to evaluate the results of unsuitable weather on the critical path and to assess working days charges correctly.

This schedule is to be submitted by mid-week of the week preceding the scheduled work, or other mutually agreed upon submittal time.

### **SS 1-08.3(3) Schedule Updates**

Schedule Updates are required for all projects. The Engineer may request schedule updates when any of the following events occur:

- A change that affects the critical path.
- The sequence of work is changed from that in the approved schedule.
- The project is significantly delayed (10 days or 10 percent of the original contract time, whichever is greater).
- An extension of contract time is requested.

It is important to note that schedule updates are only required when they are requested by the Project Engineer, when a contractor submits a request for a time extension, or monthly in the case of a Type C Progress Schedule. The Project Engineer may request an update when any of the triggers occurs but may choose to forego the update if the impacts to the schedule are readily evident.

The Contractor is required to submit a copy of the Schedule Update for approval within 15 calendar days of a written request, or when an update is required by Contract Provisions.

In addition to all other requirements, a Schedule Update must show:

- Actual duration and sequence of as-constructed work activities, including changed work.
- Approved time extensions.
- Construction delays or other conditions that affect the progress of work.
- Modifications to sequence or duration of remaining work.
- Physical completion of all remaining work within the remaining time authorized.

It is important to know the difference between an as-planned schedule and an as-constructed schedule. All updates must show the as-constructed sequence and actual durations of all activities prior to the status date.

When the need for a schedule update is triggered by an event that is the contractor's doing, they are responsible for the cost. When WSDOT causes an event or requests an update for their need, payment will be made as part of an equitable adjustment. When WSDOT is adding work or time by means of a change order, the price of the schedule update can be included as part of the work.

Any unresolved request for time extension must be shown by assuming that no time extension will be granted, and by showing the effects to follow-on activities necessary to physically complete the project within the currently authorized time for completion.

#### **SS 1-08.4 Prosecution of Work**

The Work will start as established in accordance with [Standard Specifications](#) Section 1-08.4 or such other date as prescribed by the contract provisions. [Standard Specifications](#) Section 1-08.4 indicates that Work may start at a time different from that specified if "otherwise approved in writing." Such other approval is intended only for very unusual circumstances, usually associated with mishandling of contract documents. It will only be granted in consultation with the State Construction Office.

#### **SS 1-08.5 Time for Completion**

Time associated with each phase of work established in the contract is to be shown on the Weekly Statement of Working Days. The Project Engineer is to furnish a weekly statement advising the Contractor of the current status of working day charges against the contract. Weekly Statements are generated by the CCIS computer system. This statement is to be issued in accordance with [Standard Specifications](#) Section 1-08.5. **The weekly statement must be provided to the Contractor by 5:00 PM the following Thursday.** The purpose of this statement is to advise the Contractor about the Project Engineer's decision for each passing day. The questions to be answered when determining if a day is chargeable are:

- Is it a nonworking day (holiday or a day the contract does not allow critical work to advance)?
- Was it a chargeable working day (critical work progressed uninhibited)? or
- Was it an unworkable day (critical work delayed by weather or conditions caused by the weather)?



When evaluating each day, the Project Engineer should take into consideration the following conditions:

1. The effect of inclement weather on critical activities.
2. The effect of conditions caused by inclement weather on critical activities.
3. Critical work restrictions imposed by the contract or the Project Engineer.

If any of the above conditions prevent work or reduce the Contractor's efficiency on critical activities on the project, working day charges shall be adjusted accordingly. If the Contractor can continue Work on critical activities but the efficiency is significantly reduced, a half day may be charged. When determining unworkable days the Project Engineer shall take into consideration the prolonged effects of weather events. If the Contractor is required to divert resources from working on critical path activities due to the lasting effects of a weather event the Project Engineer may determine a half day, the whole day or several days as unworkable.

If the contract does not specifically define a working day, a working day will be considered a 24 hour period. The contractor establishes the hours of work in the Weekly-Look Ahead Schedule and the start of the day should be by mutual agreement. The contractor shall be charged for one day during the defined 24 hour period regardless of how many shifts are worked.

The Project Engineer will complete Weekly Statements of Working Days throughout the course of the project, showing workable, nonworking and unworkable days as they occur. Statements will continue to be completed until the project has reached Substantial Completion and the Working Days assigned to the Contract have been exhausted.

Following are the three possible scenarios:

- The working days are exhausted prior to reaching Substantial Completion. Weekly Statements of Working Days continue until Substantial Completion.
- The working days are exhausted on the day Substantial Completion is achieved. Weekly Statements of Working Days cease upon Substantial Completion.
- The working days are not exhausted upon reaching Substantial Completion. Weekly Statements of Working Days continue until the working days are exhausted or until physical completion.

Weekly Statements of Working Days are considered Written Determinations by the Engineer. If the Contractor does not agree with the Weekly Statements of Working Days, they are required to follow the procedures identified in *Standard Specification 1-04.5*.

Upon Substantial Completion the Project Engineer will ensure that the date is entered into CCIS and is noted in the remaining Weekly Statements of Working Days. After Weekly Statements have stopped, comments concerning weather and other events beyond the Contractor's control should be documented, and the effect of these conditions on remaining Work and on the scheduled completion should also be noted.

The contract duration specified for physically completing the contract is stated in the contract provisions under the general special provision "Time For Completion." Although there are exceptions, the guidance in this chapter pertains to contracts in which time is accounted for in terms of working days.

The Contractor may begin work as soon as the contract is executed and shall prosecute the work diligently until physical completion has been reached.

Between the execution of the contract and the acceptance by the State Construction Engineer, the Project Engineer will likely encounter time-related issues. These will be documented through Weekly Statements of Working Days (*Standard Specifications* Section 1-08.5), Suspensions of Work (*Standard Specifications* Section 1-08.6), Protested Work (*Standard Specifications* Section 1-04.5), and Time Extensions (*Standard Specifications* Section 1-08.8).

**Contract Completion Milestones** – There are two milestones that establish the end of contract time. They are defined *Standard Specifications* Section 1-01.3 as Substantial Completion Date and Physical Completion Date. These two milestones are discussed in greater detail later in this chapter.

### Substantial Completion

Substantial Completion may be granted when only minor, incidental items of work, replacement of temporary facilities or correction remain in order to physically complete the contract. In determining Substantial Completion, the Project Engineer should consider whether:

- The public has full use and benefit of the facility.
- Major safety features are installed and functional, including guardrail, striping, and delineation.
- Illumination, if required, is installed or a temporary system with equal functional capabilities is operating.
- Signals, if required, are installed or a temporary system with equal functional capabilities is operating.
- The need for temporary traffic control on a regular basis has ceased. Only minor traffic restrictions will be needed for the remaining work.
- The traffic is operating in its permanent configuration.

The Project Engineer is responsible for determining the Substantial Completion date. When this has been done, the Contractor will be notified by letter, specifically noting the date on which Substantial Completion was achieved. Per *Standard Specifications* Section 1-07.18, Substantial Completion is tied to the contract insurance requirements and the Contract Administration and Payment System (CAPS) Unit of Accountability and Financial Service (AFS) must also be notified of the substantial completion date (email to [caps@wsdot.wa.gov](mailto:caps@wsdot.wa.gov)). In order to be in concurrence, the project engineer will also provide notification of Substantial Completion to the State Materials Laboratory Materials Quality Assurance Section (email to [mlrom@wsdot.wa.gov](mailto:mlrom@wsdot.wa.gov)) and to the State Construction Office (email to [DOTconstruction@wsdot.wa.gov](mailto:DOTconstruction@wsdot.wa.gov)).

### Physical Completion

The date on which the Project Engineer determines that all physical work has been completed is noted and then established as the date of Physical Completion. The Project Engineer will immediately notify the Contractor by letter of the date determined for Physical Completion. The letter will include a statement asking the Contractor to complete and return the Contractor's Construction Process Evaluation (DOT Form 410-029), and will provide a copy of the form as an attachment. Copies of the letter will be sent to:

- The Railroad companies, if applicable.
- The Contract Administration and Payment System (CAPS) Unit of Accountability and Financial Services (AFS) by means of a copy of the letter sent by email to [caps@wsdot.wa.gov](mailto:caps@wsdot.wa.gov).
- The Regional Local Programs Engineer on all city and county projects.
- The GIS and Roadway Data Office (GRDO) Roadway Geometrics Office (email to [roadway@wsdot.wa.gov](mailto:roadway@wsdot.wa.gov)).
- The State Construction Office, (email to [DOTconstruction@wsdot.wa.gov](mailto:DOTconstruction@wsdot.wa.gov)).
- State Materials Laboratory, (email to [mlrom@wsdot.wa.gov](mailto:mlrom@wsdot.wa.gov))
- Any other distribution that the Region deems appropriate.

Actions the Project Engineer should consider taking once Physical Completion has occurred include:

- Identify any unresolved disputes and initiate discussions.
- Initiate a full review of item quantities, seeking contractor concurrence.
- Initiate a final review of materials documentation.
- On Federal-aid projects, initiate a Stewardship Final Inspection and Acceptance.
- Compile a list of all approved subcontractors performing work on the project and transmit to Contractor, who will review the list for completeness and return the list annotated with each subcontractor Universal Business Identifier (UBI).

### Assembly of Delinquent Records

Immediately after the Physical Completion date has been established, the Project Engineer is to notify the Contractor of all outstanding documents that are required to establish a project Completion Date. Once all the obligations of the Contract have been performed by the Contractor, the Project Engineer will provide the Contractor written notice of project completion, identifying the Completion Date established for the contract.

For the project Completion Date to be established, all the physical work on the project must be completed, and the Contractor must have furnished all documentation required by the contract. This includes all approved Affidavits of Wages Paid, and the signed Final Contract Voucher Certification. (**Note:** Establish the Completion Date as soon as the last item of paperwork is received.) The notice to the Contractor should be prepared and mailed on the same day that is designated as the completion date. A copy of the completion letter, with attached completed *Contractor UBI and AWP Identification Number List* (LIST) must be emailed to [caps@wsdot.wa.gov](mailto:caps@wsdot.wa.gov) (CAPS) on the day the letter is written and sent. The LIST must include the UBI number and the Affidavit of Wages Paid (AWP) identification number for the Prime Contractor, subcontractors, applicable suppliers and manufacturers, delivery firms, and other firms that have filed an AWP with the Department of Labor and Industries (LNI). The LIST must be accurate and legible as errors will cause delays when requesting the release from LNI. To assure accuracy, it is recommended that offices compare their LIST against LNIs Prevailing Wage Intents and Affidavits system before issuing Contract Completion.

If the Contractor refuses, or is unable to return, a signed FCVC or any of the required documents, the Project Engineer, the Region and the State Construction Office can work together to move the project towards closure by establishing a unilateral completion date allowing WSDOT Acceptance of the contract. See Section [SS 1-09.9](#) for Unilateral Acceptance procedures.

## **SS 1-08.6 Suspension of Work**

The Project Engineer may order suspension of all or part of the Work if:

1. Inclement weather, or conditions caused by inclement weather, make it impracticable to achieve satisfactory results on a critical item of work,
2. The Contractor does not comply with the Contract, or
3. When, in the judgment of the Project Engineer, it is in the best interest of the public

If possible, suspensions for weather should be made with the concurrence of the Contractor. If the Contractor does not agree to a weather suspension, the Project Engineer should consult with the Region Construction Manager before issuing a unilateral suspension.

During suspensions of long duration, for example a winter shutdown, the publication of Weekly Statements may be suspended. Notices to suspend or resume work should be written. DOT Forms 421-006 and 421-007 have been developed for this purpose. A letter may accomplish the same purpose. If it is determined that some items of noncritical work on the project could be continued unaffected by weather conditions, those items may be excluded from the order to suspend work. The prime consideration for unworkable days or suspensions is always the ability to work on critical items.

The Project Engineer must decide if the Contractor made sufficient efforts to pursue Work before the suspension of work. If it is determined that the Contractor worked diligently before the suspension, WSDOT will maintain the temporary roadway, which includes:

1. The Traveled Way, Auxiliary Lanes, Shoulders, and detour surface
2. Roadway drainage along and under the traveled Roadway or detour
3. All barricades, signs, and lights needed for directing traffic through the temporary Roadway or detour in the construction area

All costs of roadway maintenance in this instance will be the responsibility of the Contracting Agency. The Project Engineer should coordinate these efforts with the area maintenance superintendent before any maintenance work takes place. If the Project Engineer deems the Contractor did not make sufficient efforts prior to the suspension of work, the maintenance described above will be the responsibility of the Contractor, along with the expense.

In either scenario, the Contractor is responsible for protection and maintenance of all other work areas not used by traffic during the suspension.

The suspensions described above as related to weather apply only to critical work items and, therefore, always result in a determination of an unworkable day. If the Engineer and the Contractor agree to stop working on a noncritical item for one of these causes but to continue critical work, then the agreement should be noted in the records and weekly statements should be issued in the normal fashion.

The contract also gives the Engineer the right to suspend work on any part of the project when the Contractor is not complying with the contract's terms or the orders of the Engineer. This would be a significant action and, except in an emergency situation, should not be undertaken without the full and informed consent of the Region Construction Manager and the State Construction Office. If work is suspended under this contract

provision, then weekly statements and the charging of workable days will continue in the normal fashion.

Suspending the Work because it is in the public interest is a serious action and should be taken with great care. Unless there is imminent danger, the Project Engineer should consult with the Region Construction Manager and State Construction Office before suspending for public interest. Reasons for suspending for public interest may include natural disaster or emergency that necessitates the Work being halted.

Suspension of the Work may increase the cost or time necessary to perform the Work and gives the Contractor the right to protest when they believe the Work has been suspended, interrupted, or delayed by the Contracting Agency for an unreasonable amount of time. If the Contractor believes this has happened, they must submit their protest within 14 calendar days of the start of the suspension or delay. The Contractor is not entitled to an adjustment for any costs incurred more than 14 calendar days prior to the notice they provide. Additionally, the Contractor is not entitled to an adjustment if performance would have been delayed by any other cause including the fault of the Contractor or if an adjustment is excluded under another provision of the Contract.

### **SS 1-08.8 Extensions of Time**

In general time extensions are appropriate whenever the critical work is delayed due to an action or inaction of the Contracting Agency, or by a cause that is not the responsibility of the Contractor. [Standard Specifications](#) Section 1-08.8 includes a list of reasons that entitle the Contractor to a time extension, and a list of reasons for which no time extension will be granted. In all cases, the change or delay must delay critical work or an extension is not appropriate.

The Contract requires the Contractor to identify a delay within 14 days of recognizing that one exists. If a delay is readily identifiable, the Project Engineer should enforce this provision. If the delay is not immediately apparent the time extension discussion should take place as soon as the delay is recognized. Before discussing a potential delay for which adequate notice was not given, the Project Engineer should discuss the situation with the Region Construction Manager to seek guidance. The Contractor should be encouraged to identify delays and bring them to the State's attention at the earliest opportunity. This allows the Contracting Agency to mitigate the delay by adding time, modifying the work or recovering the schedule. In the interest of actively managing a delay the project engineer may act unilaterally to address time if the contractor avoids the discussion. In any case, the Contractor is not entitled to a time extension for any Contract time that was incurred more than 14 days prior to the date the Project Engineer receives their request of time extension.

All time associated with Work added by change order should be addressed as part of the change order. If the Project Engineer is unable to come to agreement on the number of working days to add, the Region Construction Manager should be consulted concerning the need to unilaterally add time to the Contract. Deferring the discussion of time in a change order to a later date should be a last resort, and should be by mutual agreement between the parties, with a specific time when the discussion will resume. This mutual agreement must be documented in the Change Order.

If the Contractor is not granted time for Work added by a change order, they are still required to complete the Contract in the number of working days that remain. This situation may cause the Contractor to accelerate their efforts, by adding additional crews,

equipment or working longer hours or extra days. If these actions are taken as a result of the Contracting Agency not granting a time extension for which the Contractor is entitled, the Contracting Agency may be responsible for the additional cost of these efforts. This is known as constructive acceleration. If the Project Engineer determines that the Contractor is entitled to time, but an agreement cannot be reached, the Project Engineer should consider unilaterally executing a change order to add the justified amount of time to the Contract. The Contractor can then pursue the matter under the procedure for protest as outlined in Section 1-04.5.

The State has a responsibility to inform the Contractor's surety whenever increased time is being considered and the current extension, combined with previous extensions, would exceed 20 percent of the original allotted time in the contract. This information could be represented by the Surety's signature on the change order that adds time, by a separate letter from the Surety, or by a notice letter direct to the Surety office. Such notice and surety consent is a legal requirement and will help maintain the State's rights to be protected by the performance bond.

*Standard Specifications* Section 1-08.6 provides under what circumstances the Contractor may be entitled to compensation. Anytime a project is delayed for any cause, the Project Engineer and the Contractor must consider methods of mitigating the delay damage. A common approach is to pursue schedule recovery by allocating additional resources to the work to get the project back on schedule. When the Project Engineer suspects that the State may be responsible for the delay, then compensation for the mitigation efforts may be proposed as necessary.

The Project Engineer must respond to the Contractor with a Written Determination within 21 calendar days of receiving the time extension request or supplemental information. Any time extension will be documented in a change order with approval levels defined in Section [SS 1-04.4](#).

### **SS 1-08.9 Liquidated Damages**

Liquidated Damages and Direct Engineering, or other related charges, are to be addressed as described in the contract specifications, *Standard Specifications* Section 1-08.9. Direct Engineering charges are a form of Liquidated Damages and must be listed on the monthly progress estimates on the line for Liquidated Damages. Traffic related damages as described in Section [SS 1-08.9](#) are to be listed under Miscellaneous Deductions. The Project Engineer must evaluate potential Liquidated Damages that have accrued as a result of the expiration of contract time before the damages are withheld from moneys due the Contractor. The work and circumstances that have occurred over the course of the project should be reviewed to determine if there is potential entitlement for granting additional contract time. Liquidated Damages that have accrued should be adjusted for this evaluation. Liquidated Damages deemed chargeable should then be withheld from moneys due the Contractor each monthly progress estimate as Liquidated Damages accrue. While the Project Engineer takes the action to withhold damages as the work progresses, only the State Construction Office may actually assess those damages.

Liquidated Damages must be resolved before the final estimate can be completed and processed. Guidance for assessing Liquidated Damages can be found in *Standard Specifications* Section 1-08, and in some cases in the contract provisions.

Any withholding or assessment made against the Contractor's payments, is to be preceded by a fair notice written communication to the contractor. For those issues that could be remedied with actions taken or initiated by the Contractor, this notice should also include a reasonable period of time that will allow the contractor to take action to mitigate or completely avoid the withholding or assessment.

The term "withhold" refers to a temporary deduction shown on a progress estimate. The term "assess" refers to a permanent deduction that could be shown on a progress estimate, but will be shown on the final estimate. Liquidated damages fall into two categories – one deals with contract time and the other deals with miscellaneous provisions such as ramp or lane closures. These two categories are described below.

### Contract Time Liquidated Damages

*Standard Specifications* Section 1-08.9 establishes the amount of Liquidated Damages to be assessed if the Contractor overruns contract time. These assessments are either: (1) included in the Contract Provisions or (2) in the form of direct engineering and related costs.

The State Construction Engineer has not subdelegated to the Region the authority to assess time related damages on progress estimates or the final estimate. However, the authority to withhold below the line "Liquidated Damages" on progress estimates has been subdelegated to the Regions, and may be further subdelegated to the Project Engineer. Liquidated Damages should be addressed whenever it is apparent that the number of working days provided in the contract will be used before Substantial Completion. It is emphasized once again that fair notice and communication is necessary as a legal requirement.

In some cases, there are legitimate reasons for time extensions which would preclude withholding liquidated damages on progress estimates. If the Project Engineer is aware of or anticipates a possible time extension that would preclude withholding liquidated damages on progress estimates, the Region and/or the State Construction Office should be consulted for guidance. If the Project Engineer determines that withholding of liquidated damages on progress estimates would not be appropriate, the reasons for not withholding are to be documented by a memorandum to the files. The following describes the procedures for addressing contract time related liquidated damages in the various stages or phases of the project:

- **Phases (Interim Physical Completion Dates)** – Liquidated damages for phases will be shown in the special provisions. When the contract includes additional phases, and the time for physical completion of a phase has overrun, the overrun should be resolved as it occurs. This involves the Contractor either being granted an extension of time or being assessed liquidated damages by the State Construction Office.
- **After Substantial Completion Date of the Contract** – If substantial completion is granted after the expiration of contract time the amount in the Contract Provision for liquidated damages will be assessed for that period of time between the expiration of contract time and the substantial completion date. Liquidated damages assessed after the date of substantial completion will be only those costs identified as Direct Engineering and related costs that have been incurred by WSDOT. The direct engineering and related costs are defined as field engineering and inspection time charges plus any vehicle, travel pay, per diem, or other charges connected with the delayed contract physical completion. Engineering costs such as computing grades,

quantities, etc. which would have been incurred by WSDOT under normal conditions should not be included in the determination of direct engineering and related costs. If substantial completion is granted on or prior to the expiration of contract time, direct engineering costs will only be assessed for that period of time between the date contract time expired and the physical completion date.

- **Before Physical Completion** – If Substantial Completion has not been established, the amount in the Contract Provisions for Liquidated Damages, will be assessed for that period of time between the expiration of contract time and the Physical Completion date.

Working days added to the contract by time extensions when time has overrun shall only apply to the days on which Liquidated Damages or Direct Engineering have been charged, such as:

- If Substantial Completion has been granted prior to all of the authorized working days being used, then the number of days in the time extension will eliminate an equal number of days on which Direct Engineering charges have accrued.
- If the Substantial completion date is established after all of the authorized working days have been used, then the number of days in the time extension will eliminate an equal number of days on which Liquidated Damages or Direct Engineering charges have accrued.

### **Miscellaneous Liquidated Damages**

The contract provisions may provide for assessment of other liquidated damages not connected to contract working days. These liquidated damages are recorded in CAPS as miscellaneous deductions. Miscellaneous liquidated damages may include, but are not limited to, failure to open traffic lanes or ramps within the prescribed time, fabrication inspection costs, or the cost of challenge tests that do not show a passing result. The State Construction Office has subdelegated the authority to the Regions to withhold and assess these types of liquidated damages on progress estimates and the final estimate. The Project Engineer shall notify the Contractor in writing when these types of liquidated damages are to be assessed. The Project Engineer shall include an explanation of miscellaneous liquidated damages with the Final Estimate package when it is submitted to the State Construction Office.

### ***Processing Liquidated Damages***

Both categories of liquidated damages affect project expenditures differently and must be entered correctly in CAPS.

- **Liquidated Damages** – Amounts withheld due to contract time overruns and direct engineering costs. All temporary withholding or final assessment of these damages are to be shown as a below the line “Liquidated Damages” deduction on progress estimates and the final estimate. Withholding liquidated damages reduces the contract construction engineering (CE) expenditures; and releasing them will increase the contract CE for the same amount. The Project Engineer should be aware of the potential charges to the project CE cost prior to over spending or releasing the surplus CE expenditure prior to the Contract Completion.



- **Miscellaneous Liquidated Damages** – Amounts withheld for activities not connected to contract working days, such as failure to open traffic, fabrication costs or challenging test results. All temporary withholding or final assessment for these liquidated damages shall be shown as a below the line “miscellaneous” deduction on progress estimates and final estimate. Miscellaneous liquidated damages do not affect work order expenditures and are released back to the funding source when the contract is complete.

### **SS 1-08.10 Termination of Contract**

Contract termination is divided into two major categories, termination for default and termination for public convenience. *Standard Specifications* Section 1-08.10(1) defines the situations when a contract may be terminated for default (doesn't happen very often.) *Standard Specifications* Section 1-08.10(2) defines the situations when a contract may be terminated for public convenience.

Keep in mind that the conditions of the termination may be negotiated in the event that the termination is in the best interest of both parties. An example would be if a major change is beyond the abilities of the contractor. Negotiations with regard to conditions of the termination may include pricing partially completed items, mobilization payment, or the State taking possession of fabricated/purchased materials.

In both categories, if federal funds are involved, FHWA needs to be notified and informed of the situation early in the process. Specifically, Federal participation eligibility should be discussed prior to making a decision on termination. Formal notification and discussion should use normal channels through the Region to the State Construction Office. Authority to terminate a contract rests with the same position that had authority to execute the contract.

#### **SS 1-08.10(2) Termination for Public Convenience**

- A. Authority to Terminate** – As provided in *Standard Specifications* Section 1-08.10(2), WSDOT may cancel all or portions of the Work included in a contract. If the project is to be terminated in whole and contains Federal funds, FHWA must be notified and a discussion of Federal participation eligibility should take place prior to the decision to terminate is finalized. The authority to terminate a contract resides in the same position that is authorized to execute the project. Change order approvals, per the Change Order Checklist, are required for termination change orders.
- B. Cost Associated With Deleted Work** – The Contractor must submit a request for payment of costs associated with termination of the contract no later than 90-calendar days from the effective date of the termination. There are some limitations to payment that should be noted under *Standard Specifications* Section 1-09.5. When Work is deleted by the termination of a contract by the contracting agency, payment will only be for the costs actually associated with the termination. No profit will be allowed for Work that was not completed. Consequential damages are also not allowed. Consequential damages may include such things as loss of credit, loss of bonding capacity, loss of other jobs, loss of business reputation, loss of job opportunities, etc.

- C. **Payment for Materials** – When Work is deleted from the project by termination and the contractor has already ordered acceptable materials for such Work, payment for these materials may be negotiated in accordance with [Standard Specifications](#) Section 1-09.5.
- D. **Deletion of Contract Items** – Since a termination change order is deleting work from the contract, uncompleted and unused contract items, if they are to remain uncompleted, must be deleted from the contract by the change order. “Zeroing out” these items assists in releasing funding from the project. When terminating a contract that contains work that is condition of award (COA), be sure to delete that work from the COA requirements by completing the condition of award portion of the change order in CCIS. Due to limited character space in CCIS, it may be necessary to create more than one change order to complete the termination change order. Be sure these multiple change orders are concurrent.
- E. **Physical Completion** – If the Contractor is not required to complete any contract Work after execution of the change order, the execution date of the change order should be established by the Project Engineer, and entered into CCIS, as the Physical Completion date for the contract. If the Contractor must complete some items of the Work, Physical Completion will be granted by the Project Engineer upon satisfactory completion of the Work ([Standard Specifications](#) Division 1-03). This date assists the CAPS unit of AFS to know if insurance must be maintained on the project.
- F. **Time** – The change order should contain a time statement, just like any other change order.
- G. **Waiver** – The change order should contain waiver language similar to that found in Section [SS 1-04.4](#).

## 1-09 Measurement and Payment

### SS 1-09.4 Equitable Adjustment

#### Pricing

[Standard Specifications](#) Section 1-04.4 specifies that an equitable adjustment (EA) in accordance with [Standard Specifications](#) Section 1-09.4 will be made when changes cause an increase or decrease in the cost of performing work on the contract. The basic theory of an EA is to leave the parties to the contract in the same position cost wise and profit wise as they would have been without the change, preserving to each as nearly as possible the advantages and disadvantages of their agreement. Although the contractor is entitled to profit on the changed work, the profit (or loss) on the unchanged work should remain unaffected by the equitable adjustment.

- This is an important point, for unchanged work, the contractor is entitled to the profit bid or a windfall, if the work turns out to be easier than expected.
- On the other hand, for unchanged work, the contracting agency is not obligated to make the contractor well for an under bid item.

Consequential damages are never allowed as part of a negotiated equitable adjustment. Consequential damages may include such things as: loss of credit, loss of bonding capacity, loss of other jobs, loss of business reputation, loss of job opportunities, impacts to another project, etc.

- A. **Unit Prices** – An appropriate price may be established using average unit bid prices, citing similar unit bid prices, a determination of market value, by estimating the cost to perform the work, or a combination of these methods. Unit bid price is one indication of an equitable price; however the contracting agency should be prepared to support the price by other means.
- B. **Force Account** – When added work is paid by force account, a change order shall be prepared detailing the added work to be performed and the estimated cost. Standard Item Number 7715 is to be used for all force account items that do not have an assigned standard item number. Force account should be a last resort used only if the work can't be clearly defined.
- C. **Overhead** – There are two basic types of overhead as follows:
- **Distributed Fixed Costs** – Offsite “home office overhead” is the cost of running a company. These costs are assumed to be distributed among all the projects performed by the company. Onsite overhead is incurred as a function of time needed to accomplish the project. Onsite costs are assumed to be evenly distributed among contract items. This category of overhead is eligible under an equitable adjustment if working days are added to the contract as part of the adjustment.
  - **Variable Fixed Costs** – these costs are directly associated with performing an item of work on the project and therefore vary with the quantity, the contractor is entitled to recover these costs as a part of an equitable adjustment.

### Forward Pricing and Risk

The first and best option for an equitable adjustment is agreement in advance between the contractor and WSDOT on the increased or decreased cost and time for performance of the changed work. The Project Engineer should expend every effort possible to obtain a satisfactory negotiated equitable adjustment prior to submitting the change order to the contractor for endorsement. The Project Engineer must remember that the contractor is a full participant in the contract and retains all the rights and privileges during a negotiation. When bidding a job, the contractor must be optimistic and take appropriate risks. When negotiating, it is understandable and acceptable for the contractor to be pessimistic and avoid risk, unless compensated. Some key points to remember are:

- A negotiated price will likely be higher than a competitive bid price.
- A proposal which assigns extensive risk to the contractor will likely be more costly yet.
- The contractor may be willing to take on this risk if the price is a bit higher
- The significant advantage of reaching a price agreement before the work is started (forward pricing) is that the contractor assumes the risk of the accuracy of the pricing assumptions and predicted duration for performing the work.
- (when forward pricing) the Project Engineer may utilize the high end of the estimating range in justification.
- (when forward pricing) an audited overhead rate may be substituted for the markups described in [Standard Specifications](#) Section 1-09.6. Contractors can usually provide an estimated home office overhead rate which may be checked by an annual audit, if warranted.

## Pricing After Fact

When establishing prices after the work has been performed, actual costs should be used to the extent they are available. The following are key points to keep in mind:

- Costs for equipment cannot exceed the rates established by the AGC/WSDOT Equipment Rental Agreement for an equitable adjustment.
- When pricing after the fact, the markups described in *Standard Specifications* Section 1-09.6 are appropriate for measuring time and materials because there is no risk involved in after the fact pricing.

## Unilateral Pricing

In the interest of being timely, the change order should be a tool to document agreement and not a negotiation tool back and forth. Ideally we will have agreement with the contractor when pricing the work. On occasion, however, due to time constraints and difference of opinion, we can't always come to agreement. The difference of opinion may be for only a small portion of the work. *Standard Specifications* Section 1-09.4(2) provides, "If the parties cannot agree, the price will be determined by the Engineer using unit prices, or other means to establish costs." This is not to say that the contractor is obligated to honor unit bid prices for work that qualifies for an equitable adjustment. This allows us to proceed with changed work prior to reaching an agreement on the price. In the interest of being timely, and provided the Project Engineer is comfortable that the included price can be supported, there's nothing wrong with issuing a change order to the contractor unilaterally. This orders the work to proceed, establishes the State's position on cost, and puts the decision to continue negotiations in the contractor's hands as detailed under *Standard Specifications* Section 1-04.5. The contractor is obligated to endorse, write a separate acceptance, or protest as described in the specification and a timeline is provided for these actions.

## Time

The completed equitable adjustment should include provisions for any increases or decreases in contract time based on impacts to overall contract duration. The decision on time should be supported by an analysis of the project schedule. Analyzing time in advance encourages communication between the parties allowing the contracting agency to make an informed decision on the true costs. It also enables the contracting agency to mitigate time impacts if that is in the agency's best interest.

## SS 1-09.6 Force Account

### General

When it is difficult to provide adequate measurement or to estimate the cost for certain items of work, force account may be used in order to pay the Contractor for performing the work. Some contract items may be set up to be paid by force account. Some change orders may require payment by force account. *Standard Specifications* Section 1-09.6 describes the boundaries for payment of work performed by the force account method. In any case, the purpose of force account is to fully reimburse the Contractor for costs incurred on the work. These costs may also include indirect segments, such as travel, per diem, safety training, industrial safety measures, overhead, profit and other hidden costs. The objective is to minimize the inclusion of any "contingencies" included in the contract

bid in anticipation of costs that may be incurred during force account work and not reimbursed.

When work is added to the contract and is to be paid by force account, a change order will have been prepared describing the added work to be performed. The change order package will also contain an independent estimate of the cost to perform the added work. All non-standard force account items are assigned the Standard Item Number 7715.

Force account payments are typically not authorized for employees engaged in management or general supervisory work. The cost for this type of activity is presumed to be included in the Contractor's markups for overhead and profit. However a foreman or, in some cases, a dedicated superintendent devoting full time to the force account work is eligible for payment on the force account.

On projects that require the Contractor to employ trainees, these employees may be utilized in force account work.

In the case of some Emergency Contracts (see the WSDOT [Emergency Funding Manual M 3014](#)) which will be measured and paid by Force Account, it is appropriate for the Engineer to consider payment for mobilization of equipment to the site of the emergency, including all staff time employed to procure and coordinate the mobilization. It may also be appropriate to include the labor payment for a dedicated superintendent and foremen employed solely to oversee the emergency work. On emergency contracts the mark ups may not be enough to cover the cost of performance bonds; the Project Engineer may consider payment for performance bond costs when making payment under emergency force account contracts.

The Project Engineer should consider a decision to direct force account work with the same degree of caution that would be applied to directing any other work on the contract. The Contractor should have the expertise to schedule the work and determine what equipment is required. In most cases, it is best that we allow the Contractor to propose the method and approach to the work. Our most effective role would be to concur or approve of the Contractor's proposal or suggest modifications to it. Before any work is performed by the Contractor on a force account basis, the Project Office should review and agree with the Contractor upon:

1. **Labor** – The classification and approximate number of workers to be used, the wage rate to be paid those workers, whether or not travel allowance and subsistence is applicable to those workers, and what foreman, if any, will be paid for by force account. This agreement will be closely tied to the development of the Labor List.
2. **Materials** – The material to be used, including the cost and any freight charges whether the material is purchased specifically for the project or comes from the Contractor's own supply. For materials representing a significant cost, or where the industry experiences fluctuations in price, the contract allows for shopping and the Contractor may be directed to obtain quotations.
3. **Equipment** – The equipment to be used including the size, rating, capacity, or any other information requested by the Engineer. Whether the equipment to be used is owned by the Contractor or is to be rented. The cost per hour for the equipment to be used. In the case of rented equipment, the Engineer may ask for competitive quotations, provided the request is made in advance and there is time to obtain them.

Payment for force account work should be made on the same timely basis as any other item of work. When money is being withheld from a progress estimate, the criteria for withholding should apply equally to all items of work, not just to force account work, because of its method of payment.

The procedure for record keeping and payment of force account work on change orders shall be the same as for contract items to be paid by force account. Separate records are to be kept for each force account whether it is an item in the original contract or established as a result of a change order.

### Payment Procedures for Force Account Work

1. **Labor** – The specifications require the Contractor to prepare and submit a “Labor List” in advance of force account work. Once approved by the Project Engineer, this list provides the hourly rate for force account calculations until a new list is approved. New lists will not be approved retroactively and calculations previously made from an approved list will not be changed when a new list is approved. If the Contractor fails to submit a list before the first force account calculations are made, then the Project Engineer will determine the rates from the best data available (payrolls on this job, payrolls on other jobs, prevailing wage requirements, union information, etc). Labor list rates will include all the pieces of wage expense – base rates, benefits, assessments, travel, with allocations shown where necessary. Examples of Labor List entries might be:

Generic Laborer (Straight Time)		John Doe, Teamster (Overtime)	
Basic Wage/hr	\$21.36	Basic OT Wage/hr	\$32.81
FICA (7.65%)	FICA (7.65%)		
FUTA (0.80%)	FUTA (0.80%)		
SUTA (5.42%) Total =	2.96	SUTA (5.42%) Total =	4.55
Indust Ins \$1.01/hr	1.01	Indust Ins \$1.01/hr	1.01
Benefits/Hr	5.45	Benefits/Hr	8.00
Subtotal	\$30.78/hr	Subtotal	\$46.37/hr
Travel Expense	Travel Expense		
\$250/40 hrs	6.25/hr	\$250/40 hrs	\$6.25/hr
Total	\$37.03/hr	Total	\$52.62/hr
Use	\$37per hr	Use	\$53per hr

These examples show the rate rounded to the nearest dollar, which is permissible. If either party would prefer to use the unrounded amount, that is also acceptable. When deciding how many hours require compensation, the specification allows all hours that are a contractual obligation or are customary payments made to all employees. This means that, if a labor contract calls for 4 hours of pay for any call out, then that is a contractual obligation and the 4 hours would be eligible for reimbursement. (As always, the Contractor is expected to reassign the employees, if possible, to avoid the penalty.) In the same vein, a non-Union contractor, who has made call out payments to all employees for years, would be eligible for reimbursement for similar payments in a force account.

**Per Diem and Subsistence** – This item must be agreed to in advance of the work. A daily allowance for expense generally prescribed by a labor contract or a company policy. When requested, a copy of the labor contract/company policy which describes how the Contractor is paying Per Diem must be obtained. Per Diem costs will be paid on an actual cost (invoiced and receipted) basis incurred as the direct result of the Force Account work, if the Per Diem is paid to workers for similar pay item work.

2. **Materials** – Materials also work from a list, but the list is generated in a different fashion. The Project Engineer provides the basic list of materials observed by the inspector. This is done in a timely manner (daily, unless the Contractor agrees otherwise). The Contractor adds prices to the list and attaches invoices or affidavits to support the prices. Once the list is returned and checked, payment can be made.

If a shipment of material is only partially consumed during the force account reporting period, the inspector may choose to include the entire amount in the first report or to estimate the amount consumed during each reporting period. The decision should be based upon the amount of the shipment, the nature and cost of the shipment and the security of the stockpile. A case of empty sandbags to be utilized throughout the winter for pollution control would adapt well to a single report, while a stockpile of galvanized conduit should probably be reported piecemeal as it is used in the work. The Contractor may use copies of the original invoice when the material is reported incrementally. If the Contractor has to restock unused material, restock charges can be reimbursed if the original order was reasonable for the work planned.

Along with supplying prices and invoices, the Contractor may suggest additions or corrections to the Materials List. These suggestions will be reviewed by the Project Engineer and, if appropriate, added before payment is made.

If the Contractor does not have an invoice, as in the case of stockpiles or some warehouse stock, then an affidavit will suffice. The Engineer may review the affidavit and, if it is an unreasonable price that cannot be supported, the Engineer may substitute another price, utilizing the best data available. The reasonableness of the price must consider the circumstances of the purchase and all costs associated with obtaining material from another source.

The specifications allow the Engineer to require competitive quotations, if this is done before the work is started and sufficient time is available. If the Contractor has to divert an employee to obtain the quotations, then that employee may be included in the labor reimbursement for the force account.

3. **Equipment** – The Project Engineer should review and comply with the rules governing payment for equipment as outlined in the most current AGC/WSDOT Equipment Rental Agreement. This agreement was developed as a supplement of the specifications and is relatively self explanatory.

There are three methods of acquiring equipment for use on a force account. “Owned” means that the Contractor controls and operates the equipment. A long term lease arrangement would be the same as ownership. Owned equipment is priced according to the Blue Book. For equipment not listed by Equipment Watch, a rental rate may be requested from the Engineer by completing and submitting the Force Account Equipment Rental Rate Request (WSDOT Form 422-010). “Rented to Operate” means that the Contractor has obtained a piece of equipment through a short-term rental and will operate that equipment with its own employees. Rented to Operate

equipment is priced according to the invoice from the rental agency. “Rented Operated” means that the Contractor has obtained a service from an individual or a company to provide a piece of equipment with an operator. An operated rental is not paid as equipment, but rather as a Service. In some cases, the Service will be reclassified as an entity performing in the manner of a subcontractor (see below).

Damage waivers are compensable. The Engineer has the discretion to reimburse for a damage waiver when it makes good business sense. Upon request, the Contractor should be able to demonstrate that the purchase of the damage waiver is consistent with their standard business practice. Consideration should be given to the potential risk of damage to the equipment versus the cost of paying for the damage waiver. In most cases, the cost of the waiver is minimal. The damage waiver does not cover damage caused by operator negligence, nor should the Department reimburse the Contractor for repair of any damage caused by operator negligence.

Normal wear and tear on equipment is included in the Blue Book rental rates. The ownership rates include major overhaul of the equipment. The Blue Book defines major overhaul as the periodic rebuilding of the engine, transmission, undercarriage, and other major equipment components. The operating rates include the cost of daily servicing of the equipment, including the replacement of small components such as pumps, carburetors, injectors, filters, belts, gaskets and worn lines. The operating rates also include the cost of expendables such as fuel, lubricants, filters, tires, and ground engaging components, such as pads, blades bucket teeth, etc.

The costs of extraordinary operating expendables are not covered in the operating rates due to their highly variable wear patterns. These extraordinary operating expendables may include certain ground engaging components, such as hammer and drill bits, drill steel, augers, saw blades, and tooth-bits. The cost for these items will normally be recovered separately, based upon invoices for their cost.

Repair of damage is considered a risk of providing equipment. The cost of this risk is assumed to be in the markup for overhead and profit. Costs for repair of damage should not be included in the force account direct charges. A common event is the offer of a Damage Claim Waiver by a renting agency. If such a charge appears on an invoice, it will be considered for inclusion when payment is calculated.

As with Materials, the Engineer may require competitive bids for equipment rentals. Normally, this requirement must be made in advance before the work is started. However, if the rental is not made in an “arm’s length” transaction, for example when the contractor rents the equipment to himself through some sort of business structure, then after the fact quotations may be obtained from independent rental agencies and the lowest such quotation may be used in place of the rental invoice.

Any contractor-owned equipment, not considered part of equipment already being paid for, listed in the Blue Book with a monthly rate of less than \$100 and any other equipment with a purchase price of between \$100 and \$500 are considered Small Tools (except for rentals). Small tools may include specialty safety equipment required for the force account work, like respirators, entry/retrieval gear for confined space and hand tools. Safety equipment that is used day in and day out and/or consumable is not included. The Contractor needs to provide supporting invoices or affidavit of purchase costs. The negotiations should consider discussions of shared use with other work and residual value. Small tools should be paid for by a lump sum agreement, or



other means as agreed to by the parties, that may be paid monthly or after the force account work is completed.

Finally, as a special insertion into this manual, there is a separate method of paying for Pavement Routers for Crack Sealing. WSDOT has agreed to set aside the Blue Book rate for this equipment and to pay \$20 per hour for the operated router.

4. **Services** – Services billed by invoice will be compensated according to the invoice if that is the typical method in standard industry practice. Typical industry practice might include specialized technical services, such as Testing Labs and Environmental Cleanup firms. Also included might be unit price invoices, such as Sweeping per mile or Concrete Pumping per cubic yard, or lump sum quotation invoices, such as Remove Danger Tree or Pump Septic Tanks.

The markup for services depends on the nature of the firm's activities on the project. If the firm is clearly an uninvolved supplier, then the Service markup will apply. If the firm is acting as a subcontractor, then the markup will be made under the subcontractor provisions described below, with the underlying (subcontractor's) overhead and profit assumed to be embedded in the invoice.

It should be noted that payment of force account work through an invoice does not excuse the Contractor from other requirements of the contract. Wage rate rules, subcontractor approvals and other provisions are still contract requirements and must be enforced. Such enforcement, however, is independent of the administration of force accounts and force account payment will not ordinarily be withheld to aid in the enforcement. Note that the statutes associated with some provision requirements do involve the withholding of payment for associated work.

As with materials and equipment rentals, the Engineer may require competitive bids for invoiced services. Normally, this requirement must be made in advance, before the work is started. However, if the service is not obtained in an "arm's length" transaction, for example when the invoice comes from a subcontractor without sufficient effort to find competitive prices, then after the fact quotations may be obtained from independent service providers and the lowest such quotation may be used in place of the service invoice.

5. **Mobilization** – Mobilization and demobilization are reimbursable expenses for assembling equipment, materials, supplies and tools for any force account item and then returning those items to the previous location when the work is finished. Demobilization can include restocking costs for materials not utilized. Force account mobilization applies to original bid item force accounts as well as force accounts added through change orders. The standard bid item "Mobilization" is assumed to not include mobilization activities for force account work.

Mobilization may occur within the project limits if special efforts are required to assemble needed items to the force account location. For example, if a lowboy is required to move a bulldozer from one end of a project to the other, then that mobilization effort would be reimbursed.

If off site preparation work is needed, the Contractor must notify the Engineer in a timely enough manner that the work can be observed, if that is desired. Without such notice, that preparation work will not be reimbursed.

The AGC Agreement allows for pro-rating mobilization costs for equipment that will be used in both force account and bid item work. This will be done by negotiation and agreement. For example, if the Project Engineer and Superintendent agree that a mobilized backhoe will be used three hours on regular work for each hour on force account, then 25 percent of the mobilization costs would be paid on the force account.

All mobilization activities can be categorized as Labor, Equipment, Materials, or Services and will be listed under those categories for payment.

## 6. Other Payments

- **Permits or Fees** – When a force account requires the Contractor to pay for permits or fees (hazardous waste dumping, etc.) that would fall outside the scope of overhead, these costs are reimbursable and may be included in the “Services” Section of the force account payment.
- **Retail Sales and Use Tax** – How retail sales tax and use tax is handled on the overall project depends on the ownership of the property upon which it rests. The retail sales tax consequences related to construction projects and land owned by the state of Washington or privately is addressed by [WAC 458-20-170](#) (“Rule 170”), while the retail sales tax consequences related to construction projects and land owned by a municipal corporation, political subdivision of the state of Washington, or by the United States is addressed by [WAC 458-20-171](#) (“Rule 171”).

With respect to Rule 171, ownership refers to ownership for the street, place, road, highway, easement, right of way, etc. being constructed and not the underlying real property. See [RCW 82.04.050\(10\)](#); Rule 170; and Rule 171. Thus, for instance if WSDOT has an easement with respect to a road subject to a construction project, then Rule 171 treatment will not apply even if the underlying real property were owned by the United States, Indian tribe, or municipal entity.

The Contractor’s books may be audited by the Department of Revenue upon completion of each project to ensure compliance.

- **State and Local Tax: [WAC 458-20-170](#) – Retail Sales and Use Tax** – Item quantities listed in the summary of quantities under *Standard Specifications* Section 1-07.2(2) require retail sales tax on the item to be paid by the Contracting Agency; therefore; Contractor would not include the tax in their bids. The Contracting Agency provides this tax payment to the Contractor on the total cost summation of the bid items listed under Section 1-07.2(2). Contractor remits this retail sales tax through to Department of Revenue. Under state tax law project Work requires remittance of retail sales tax on the full contract price.
  - **Resale Items** – Materials purchased for incorporation into the permanent project.
  - **Use of Reseller Permits** – Generally, purchases of tangible personal property by persons without a valid reseller permit are subject to retail sales tax. See [WAC 458-20-102](#). For example, a Contractor’s purchases of materials incorporated permanently into the structure being built or improved as part of the project Work (including but not limited to cement concrete, lumber, finished hardware, asphalt concrete pavement) are treated as a retail sale at the point of purchase unless the contractor has

a valid reseller permit. If the contractor has a valid reseller permit, the Contractor can provide it to their vendors to purchase these materials permanently incorporated into a structure being built or improved under a project without paying retail sales tax. These materials if purchased with a reseller permit are considered to be purchased for “resale”.

- **Tax Paid at Sourced Deduction** – If the contractor does not have a valid reseller permit when purchasing materials permanently incorporated into a structure being built or improved as a part of the project Work, the contractor must pay retail sales tax at point of purchase and then may take the appropriate deduction (tax paid at source) when filing its Washington state excise tax return. The Contracting Agency pays retail sales tax to the Contractor when the material is incorporated into the permanent work of the project.
- **Consumables Items** – There may be items that the contractor is required to pay retail sales tax on at the point of purchase because they are consumed by the Contractor rather than resold (“consumables”). For example, tools, machinery and equipment, and supplies consumed (including but not limited to concrete forms, fuel or tools, equipment purchased or rented) during the performance of the project work are “consumables”, which are a part of the overall cost of doing business for the Contractor. The Contractor is required to pay retail sales tax at the point of purchase/rental for these items or use tax if retail sales tax is not paid. These costs are bid as a part of the associated bid items.

The contractor is considered the “consumer” when renting equipment for use in Washington State and must pay sales tax on the total charge. This is no different than purchasing a tool the contractor must have in order to perform its services and passing the cost on to the customer. The sales tax paid by the contractor to the rental company is a cost of doing business and, if it is passed on to the customer, it is considered to be part of the gross contract price that is subject to sales tax.

When calculating or estimating the cost of force account or change order work, retail sales tax will always be applied and paid by the Contracting Agency on the whole summation of daily force account cost including labor, equipment and material costs, which can in the case of “consumable” items include paying retail tax on a tax.

- **State and Local Tax: [WAC 458-20-171](#) – Retail Sales and Use Tax** – For item quantities listed in the summary of quantities under [Standard Specifications](#) Section 1-07.2(1) retail sales tax is not required on the item.

However, the Contractor is required to pay retail sales tax on all of its own retail sales taxable purchases regardless of use (“consumable” or not) or use tax if retail sales tax is not paid. For contract work, this expense is incidental and therefore included in the individual contract items as a part of the bid amount.

- **Ownership By Covered Persons** – Rule 171 applies where the operative public road construction is owned by a municipal corporation, political subdivision of the state of Washington, the United States, or an Indian or Indian tribe in Indian country. [RCW 82.04.050\(10\)](#); Rule 171, and [WAC 458-20-192](#).

- **WSDOT Not A Covered Person** – WSDOT is not a municipal corporation, political subdivision of the state of Washington, the United States, or an Indian or Indian tribe. Therefore, where the operative public road construction is owned by WSDOT, the construction is subject to retail sales tax consistent with Rule 170 above.
- **WSDOT Easements** – Washington Excise Tax Advisory (ETA) 3068.2009 explains that where “title to the land upon which the highway, street, place, or road is being constructed vests in the state of Washington, the construction contract is a retail sale.” ETA 3068.2009 further makes clear that this vesting provision refers to the street, place, road, highway, easement, right of way, etc. being constructed and not the underlying real property. Thus, for instance if WSDOT has an easement with respect to a road subject to a construction project, then Rule 171 treatment will not apply regardless of whether the underlying real property is owned by another party.

When calculating or estimating the cost of force account or change order work, sales tax should be included on all invoices. As stated previously, the fact that taxes are shown or not shown on invoices is not a reliable indication of what the contractor is obligated to pay. The contractor may receive reimbursement later or be required to pay additional taxes when the contract is complete.

- **Exceptions** – Consistent with Rule 171, construction of the following facilities has been specifically exempted. Work on these facilities falls under Rule 170 even if they are on non state owned land:
  - Water mains.
  - Telephone, telegraph, electrical power, or other conduits or lines in or above streets and roads, unless such power lines become a part of a street or road lighting system.
  - Construction of sewage disposal facilities.
  - The installing of sewer pipes for sanitation, unless the installation thereof is within, and a part of, a street or road drainage system.
- **Conclusion** – Most of the time, retail sales tax on invoices is required. In turn, we need to reimburse the contractor for the tax (paid or deferred) on force account invoices and include the costs when estimating the value of change order work. The one exception is “resale” items if the contract falls under Department of Revenue rule 170 where retail tax sales need not be paid at the point of purchase. These rules should be adhered to regardless of whether retail sales tax is shown on the invoice.
- **Contractor Markup on Subcontractor’s Work** – If work is being performed by a Subcontractor (or by a service supplier acting in the manner of a Subcontractor), a supplemental markup will be added. This supplement will be added one time for each payment, even if a lower-tier subcontractor is doing the work. No additional markups will be applied to force account work done by a Subcontractor’s lower tier subcontractors.

If more than one Subcontractor performs work on the same force account item, the supplemental markup is applied separately to each Subcontractors computed cost for their work.

Additional markups are not applied to force account work done by a Subcontractor's lower tier subcontractors. Section 1-09.6 of the *Standard Specifications* states the additional markup is applied to each Subcontractor doing force account work. Section 1-01.3 of the *Standard Specifications* defines Subcontractor as an individual, partnership, firm, corporation or joint venture that is sublet part of the contract by the Contractor. A lower tier subcontractor does not have a sublet with the Contractor. Their sublet is with the Subcontractor; therefore the additional markup is only applied to Subcontractor per the *Standard Specifications*.

The supplemental markup is a graduated step down rate, which gets smaller as the amount of payment to a given Subcontractor for that force account item increases. The supplemental markup rate is determined by the accumulated value of work that a specific Subcontractor has performed on each specific force account item. For example, if Subcontractor X performed force account work on bid item A in the amount of \$150,000 for the first estimate, the markup would be calculated at 12% for the first \$25,000, 10% the next \$75,000, and 7% on the remaining \$50,000 and all subsequent payments for this bid item work  $((\$25,000 \times 0.12) + (\$75,000 \times 0.10) + (\$50,000 \times 0.07) = \$14,000$  markup).

The amounts on which the rate is determined will be tracked separately for each Subcontractor on each force account item included in the original contract or added by change order. If two Subcontractors work on the same force account item, then the accumulated total will be tracked for each, and markup for work done by each will be according to the respective total. If a single Subcontractor works on two force account items, then there will be a running total of work done by that Subcontractor on each force account item and the markup rate for the same sub on different force account items could be different.

## Records and Source Documents

Accurate daily time records should always be kept when performing force account work. A Daily Report of Force Account Worked DOT Form 422-008A is provided for the Project Engineer's use to help facilitate timely, accurate, and complete records of the daily force account activities. Whatever method of record keeping is used, it is recommended that the document be signed by both the Inspector and a representative of the Contractor agreeing on the materials used and the hours noted for labor and equipment. A copy of the daily report must be provided to the Contractor. When the work is performed by a subcontractor, a copy should also be provided to the subcontractor.

The costs for force account work should be determined and entered into the CAPS system in as timely a manner as possible.

All calculations for determining force account costs should be checked, initialed, and dated. After the cost of the work has been computed in the office, a copy of calculations shall be furnished to the Contractor.

## Summary

To summarize, the purpose of force account is to fully reimburse the Contractor for costs incurred on the work. The objective of force account administration is to minimize the inclusion of any “contingencies” included in the contract bid in anticipation of costs that may be incurred during force account work and not reimbursed.

Items which are bid or negotiated with a unit price or a lump sum agreement will not be converted to force account unless a change (as defined in *Standard Specifications* Section 1-04.4) has occurred. On the other hand, any work to be done or the remaining portion of work underway on a force account basis may be converted to unit prices or a lump sum at any time the parties can reach an agreement. Such a conversion is highly desirable and should always be a goal of the Project Engineer.

### **SS 1-09.8 Payment for Material on Hand**

Payment for material on hand (MOH) may be considered for materials intended to be incorporated into the permanent work. The requirements for payment of MOH are noted in *Standard Specifications* Section 1-09.8. Payments for MOH are made under the 900 series of item numbers as ledger entries and need to be backed out as material is utilized such that 900 series entries are zeroed at close out of the Contract. Payment for MOH must not exceed the value of the corresponding bid item. It is the responsibility of the Project Engineer to devise procedures that assure this is done correctly.

Payments may be made provided the Contractor submits documentation verifying the amounts requested, the materials meet the requirements of the contract and the materials are delivered to a specified storage site or stored at the suppliers/fabricators as approved by the Project Engineer. Payment cannot be made until the material has been inspected, approved, and stamped or tagged (as required). Materials shall be segregated, identified and reserved for use on a specific Contract or project. Payments commensurate with the percentage of completion may be paid for partially fabricated items.

All materials paid for as MOH must be readily available for inspection by the owner. Steel materials must be available for inspection but this availability need not be immediate. Reasonable notice should be given to allow the Contractor to locate and make the material available for inspection. The Project Engineer may accept a higher level of risk that steel material may not be reserved for our use. The Contractor's obligation to perform the work and the surety's guarantee of this obligation serve to offset the risk that reserved materials are diverted to other projects.

When materials paid for as MOH are stored in areas outside the general area the region shall make arrangements for inspection as deemed necessary prior to making payment. The region may utilize other regions or the State Materials Laboratory in doing so.

When contracts are estimated to cost more than \$2 million and require more than 120 working days to complete, a General Special Provision (GSP) will be included in the contract provisions, requiring documentation from the contractor as the basis for MOH payments and deductions. When this GSP is included in the contract provisions, the following procedure is used to determine how much of the MOH payment should be deducted from an estimate:

- Each month, no later than the estimate due date, the contractor will submit a document and the necessary backup to the Project Engineer that clearly states:
  - The dollar amount previously paid for MOH,
  - The dollar amount of the previously paid MOH incorporated into the various work items during the month, and
  - The dollar amount that should continue to be retained in MOH items.

If work is performed on the items and the contractor does not submit a document, all previous associated MOH payments may be deducted on the next progress estimate.

## SS 1-09.9 Payments

### General

Payment for work performed by the Contractor and for materials on hand must be made in accordance with [Standard Specifications](#) Section 1-09. To facilitate payments to the Contractor and ensure proper documentation, WSDOT utilizes an automated computer system to record project progress in terms of bid item quantity accomplishment. This is then used to pay the Contractor for actual work performed during each designated pay period or for materials on hand. The automated system that completes this task is called the Contract Administration and Payment System (CAPS). CAPS utilizes an electronic tie between each Project Office's computer system and the mainframe computer. This system provides access to a large volume of corporate data and facilitates the maintenance of this data by different groups in different locations. Some of these different activities include:

- **Contract Initiation** – A Headquarters action whereby new contracts are created and stored in a computer file. The information consists of the names of the Contractor and the Project Engineer, project descriptive data, accounting identifier numbers, preliminary estimate, proposal date, bid opening date, award date, execution date, accounting groups and distributions, and an electronic ledger.
- **Project Ledger** – An updating process by the Project Office which keeps track of work performed on the contract as it is completed.
- **Estimate Payments** – A Project Office action whereby progress estimates and Regional final estimates are processed directly from the Project Office. The Headquarters Final Estimate process activates the Region Final when all the required paperwork is in place. Supplemental final estimates are processed by Headquarters only. Complete instructions for use of the CAPS computer system are included in WSDOT Contract Administration and Payment System M 13-01.

### Progress Estimates

Progress estimates are normally processed on the 5th of the month for odd numbered contracts and on the 20th of the month for even numbered contracts. Where the Project Engineer deems it appropriate, estimates may also be run on other dates.

Estimates may also be run on other dates if the progress estimate or parts of the progress estimate were withheld to encourage compliance with some provision of the contract and the Contractor resolves the issue that caused the withholding. These estimates should be paid immediately upon resolution by the Contractor.

Within the CAPS system, the basis for making any estimate payment is information from the project ledger. Every entry in the ledger is marked by the computer as paid, deferred, or eligible for payment. Before an estimate can be paid, a Ledger Pre-Estimate Report (RAKD300C-PE) must be produced. In constructing this report, the CAPS system gathers all the ledger entries that are identified as eligible for payment, prints them on the report summarized by item, and shows the total amount completed to date for that item but not yet paid for by progress estimate. The report also shows any deferred entries or exceptions if they exist and includes a signature block for the Project Engineer's approval.

If there are errors or omissions in this report, the ledger must be changed to reflect the correct data. After corrections are made, the Ledger Pre-Estimate Report must be run again in order to get the corrections into the report and made available for payment by progress estimate. Once the Ledger Pre-Estimate Report is correct, an actual estimate can be paid. The report containing the Project Engineer's signature should be retained in the project files.

The estimate process is then accomplished with a few keystrokes in option 2, estimate payments, in the CAPS main menu. At this point, the CAPS system will automatically calculate mobilization, retainage (on projects containing no Federal funds), and the sales tax. The warrant will be produced, signed, and sent to the Contractor along with the Contract Estimate Payment Advice Report and two different sales tax summary reports. Copies of these reports will also be sent to the Project Office. When the Project Office receives their copy of the Contract Estimate Payment Advice Report, the total amount paid for contract items should be checked against the Pre-Estimate Report. This helps to verify that the amount paid was what the Project Engineer intended to pay. In addition, the ledger records that produced the estimate will now be marked by the CAPS system as being paid.

Once the estimate is paid, the Project Engineer should ensure that estimate payment information is available to all subcontractors and any other interested parties who request the information. This may be accomplished by posting to a project specific webpage, a Region Construction webpage, email, or other means as determined by the Project Engineer and the Region Construction Office.

Up to the point of actually producing the warrant, the entire process for making a progress estimate payment is initiated and controlled by the Project Office.

Particular attention should be given to the comparison of the plan quantities and the estimate quantities for the various groups on the project as shown on the Ledger Pre-Estimate Report. Overpayments on intermediate progress estimates are sometimes difficult to resolve with the Contractor at the conclusion of the project.

New groups which do not change the termini of the original contract or changes in groups should be accomplished by memorandum from the Region to the Accounting and Financial Services Division.

An additional estimate may be prepared if considerable work has been done between the date of the last progress estimate and the date of physical completion when the Engineer anticipates delays in preparing the final estimate. Should this circumstance occur, the additional estimate should show the work done to date no later than the day before the date of physical completion.



## Payment for Lump Sum Items

The Contractor is required to submit a detailed Lump Sum price breakdown for those items specified as Lump Sum for which there is no specified payment described in the payment clause of the applicable specification. Estimate payments for items specified as Lump Sum will be a percentage of the price in the Proposal, based on the Project Engineer's determination of the amount of work performed. Consideration will be given to, but payment will not be based solely on, the Contractor's Lump Sum breakdown. The Project Engineer should verify that the price breakdown is based upon a reasonable proportioning of the work, and detailed enough to allow a determination of the work performed on a monthly basis.

Payment of the first 80 percent of the Lump Sum price for Type B Progress Schedules will be made on the next progress estimate following the submittal and approval of the Type B Progress Schedule. The payment will be increased to 100 percent of the Lump Sum price when the Contractor has attained 80 percent of the Original Contract Award amount, as shown on the CAPS Pre-Estimate Report (inclusive of payments made for Material on Hand).

On WSDOT contracts for which payment is made through CAPS (Contract Administration and Payment System), payment for mobilization is calculated and paid automatically by the system. On contracts that do not use CAPS, the Project Office must calculate, and make payment for, the Contract item "Mobilization." Payment will be made in accordance with [Standard Specifications](#) Section 1-09.7. Based on the lump sum Contract price for "Mobilization," partial payment will be made as follows:

1. When 5 percent of the original Contract amount has been earned from other Contract items, excluding any amounts paid for materials on hand, the Contractor is also entitled to a partial payment of the Bid item "Mobilization." This payment, which is in addition to payment for contract work performed, will be calculated as 50-percent of the amount bid for "Mobilization" or 5 percent of the original Contract amount, whichever is the least.
2. When 10 percent of the original Contract amount has been earned from other Contract items, excluding any amounts paid for materials on hand, the Contractor will be paid 100 percent of the amount bid for "Mobilization" or 10 percent of the original Contract amount, whichever is the least. This payment is in addition to payment for contract work performed.
3. When the Substantial Completion date has been established for the project, payment of any remaining portion of the lump sum item "Mobilization" will be made.

## Payment for Falsework

On those projects which include a lump sum item for bridge superstructure, payment may be made on request by the Contractor for falsework as a prorated percentage of the lump sum item as the work is accomplished. The Project Engineer may require the Contractor to furnish a breakdown of the costs to substantiate falsework costs. For any given payment request, the Contractor may be required to furnish invoices for materials used and substantiation for equipment and labor costs.

## Payment for Shoring or Extra Excavation

When Shoring or Extra Excavation Class A is included as a bid item, payment must be made as the work under the bid item is accomplished, the same as for any other lump sum bid item. When Shoring or Extra Excavation Class B is included as a bid item, measurement and payment shall be made in accordance with [Standard Specifications](#) Section 2-09.4 and 2-09.5. [RCW 39.04](#) provides that the costs of trench safety systems shall not be considered as incidental to any other contract item, and any attempt to include the trench safety systems as an incidental cost is prohibited. Accordingly, when no bid item is provided for either Shoring or Extra Excavation Class A or Shoring or Extra Excavation Class B and the Engineer deems that work to be necessary, payment will be made in accordance with [Standard Specifications](#) Section 1-04.4.

## Payment for Asphalt, CRS-2P, Steel, and Fuel Cost Adjustment

Some projects may include the specifications for Asphalt Cost Adjustment, CRS-2P Cost Adjustment, Steel Cost Adjustment, or Fuel Cost Adjustment (one or more) as a General Special Provision. Not all projects will contain these provisions, since their use depends on the type of work, the duration of the contract, and Region preference. For those contracts containing one or more of the cost adjustment bid items, an adjustment (payment or credit) will be calculated monthly for qualifying changes in the index price of the commodity. No adjustment (payment or credit) shall be made if the 'Current Reference Cost' is within the percentage of the 'Base Cost' specified in the contract, and only those items that are included in the provision are eligible for adjustment. Worksheets are available, in the "Shared Documents" folder of the State Construction Office Sharepoint site at: <http://sharedot/eng/cn/hqconstr/Shared%20Documents/Forms/AllItems.aspx>, to assist the Project Office in computing these price adjustments, and on the State Construction Office web page ([Construction - Escalation Clauses | WSDOT \(wa.gov\)](#)) to assist the Contractor and local agencies.

It is important to understand that the adjustments provided by these provisions are not a guarantee of full compensation for changes in the contractors cost, and that they are intended only to absorb some of the risk of severe cost escalation during contract performance. Because of this, the method of computing the adjustment has been simplified to eliminate tedious considerations that would otherwise be required to provide precise reimbursement of actual costs.

The Reference Cost is posted twice each month on the external website at: <http://www.wsdot.wa.gov/Business/Construction/EscalationClauses.htm>

Payment for "Asphalt Cost Price Adjustment", "CRS-2P Cost Adjustment" and "Fuel Cost Adjustment" is based on quantities of the eligible material(s) incorporated during the period covered, as demonstrated by pay notes for those items. Regardless of the Contract estimate cutoff date – the 5<sup>th</sup> or 20<sup>th</sup> of the month – adjustments will be calculated once per month using the Current Reference Cost, as defined in the Contract, for the total quantity of each eligible item for which we have tickets. If an unusual number of late tickets are received, work with your ASCE to determine the appropriate calculation.

The Current Reference Cost will be selected from the website using the "Date Effective" that immediately precedes the current month's progress estimate end date.

Payment for “Steel Cost Adjustment” is based on the quantity of eligible steel items incorporated or paid as Materials on Hand for the period covered. The Contractor is required to provide documentation of the quantities and the date shipped from the producing mill to the manufacturer.

If the Contractor fails to provide the required documentation, any adjustment credit will be unilaterally computed by the Project Office using a shipment date determined by the Engineer. If the Contractor wishes to protest this adjustment, it must be done in accordance with [Standard Specifications](#) Section 1-04.5.

When a portion of the payment for an eligible item is deferred, a similar portion of the price adjustment for that item should be deferred.

The provisions for these cost adjustments are silent regarding changed work because there are other Contract clauses that address how the Department will pay for changed work. Should changes occur in bid items that are eligible for adjustment, equitable adjustments should adhere to the guidance provided in Section [SS 1-04.4](#). Under no circumstances should eligible items that were not included in the specifications at the time of bid be added by change order after award and execution of the contract. Likewise, these provisions should not be added by change order. FHWA will not participate in the cost of retroactive price adjustments.

## Credits

Dollar amounts may be deducted as a “Below the Line Miscellaneous Deduction” from progress or final estimates when WSDOT is due a credit from the Contractor. Routine credits from the Contractor to WSDOT include, but are not limited to, the following items:

- Engineering labor costs when due to Contractor error or negligence, additional engineering time is required to correct a problem. This includes the costs of any necessary replacement of stakes and marks which are carelessly or willfully destroyed or damaged by the Contractor’s operation.
- Lost and/or damaged construction signs furnished to the Contractor by WSDOT. The Contractor should be given the opportunity to return the signs or replace them in kind prior to making the deductions.
- Assessment to WSDOT from a third party that is the result of the Contractor’s operations causing damage to a third party, for example, damage to a city fire plug. Actual costs will be deducted from the estimate.
- Other work by WSDOT forces or WSDOT materials when the Contractor cannot or will not repair damages that are the responsibility of the Contractor under the contract.
- Liquidated damages not associated with contract time, i.e., ramp closures, lane closures (see Section [SS 1-10](#)).
- As provided for in the specifications, specific costs or credits owed WSDOT for unsuccessful contractor challenged samples and testing.

The authority to withhold and assess routine “Below the Line Miscellaneous Deduction” on progress and final estimates has been delegated to the Regional Construction Manager, and may be further subdelegated to the Project Engineer. The Project Engineer must give written documentation to the Contractor describing the deduction and provide sufficient notice of the impending assessment.

Credit items which are specifically provided for by the *Standard Specifications* or contract provisions, such as non-specification density, non-specification materials, etc. may be taken through the contract items established for those purposes. A change order is required for credit items which are not specifically provided for by the contract provisions.

Occasionally a Contractor will send a check directly to a Project Office for payment of money due WSDOT. (The Project Office should not request payment.) Whenever a Project Office or WSDOT employee receives a check or cash directly from a Contractor, it is very important that the guidance found in the WSDOT [Accounting Policy Manual M 13-82, Section 2-1, Control of Cash Receipts](#), be followed.

### Withholding of Payments

Withholding payments for work the Contractor has performed and completed in accordance with the contract should not be done casually. There must be clear contract language supporting the action. The authority to withhold progress payments is subdelegated to the Regions. Further delegation to the Project Engineers is at the discretion of each Region.

There are very few occasions when it would be appropriate to withhold the total amount of a payment for completed work. If a minor amount of cleanup remains, if a portion of the associated paperwork has not been submitted, or if minor corrective measures are needed, then the correct action is to pay for the work and defer an amount commensurate with the needed remaining effort.

The concept of “allowing the Contractor to proceed at his own risk” and then withholding payment is not often supported by the contract. There is a contractual obligation to finish the work correctly, there would certainly be a “moral obligation” on the part of the Contractor to live up to the bargain, but there is no contract language that allows such an action. Specific exceptions to this rule are listed below.

Once a decision to withhold any part of the monthly payment has been reached, then it is imperative that the Contractor receive fair notice of this action. The method of this notice can be negotiated with the Contractor and could be a listing at the time of estimate cutoff, a copy of the pre-estimate report or other mechanism. Once notice has been provided, then it is also necessary to allow a reasonable time for corrections to be made.

**No Payment for the Work** – [Standard Specifications](#) Section 1-06.3 is unique in that this is a situation, specified as part of the contract, where the contractor may request permission to assume the risk for no certificate and end up never being paid for the related work.

**Progress Payment Deferral** – In the following situations, the contract specifies that the contracting agency has the authority to defer the entire progress payment:

- The contracting agency may not make any payments for work performed by a Prime/ Subcontractor until the contractor performing the work has submitted a Statement of Intent to Pay Prevailing Wages approved by Labor and Industries ([RCW 39.12.040](#)).
- Failure to submit the “required reports” by their due dates ([Standard Specifications](#) Section 1-07.11(10)B).

**Wage Administration in General** – The administration of wages and payment for the work are separate issues. Holding a force account payment for certified payrolls is not appropriate. Withholding payments on the contract is suggested as a method to achieve compliance under [Standard Specifications](#) Section 1-07.9(1) pertaining to wages. This remedy should not be used without approval of the State Construction Office. Routine enforcement of wage requirements should be done on their own merits utilizing the sanctions specified as follows:

**State Wage Administration** – Labor and Industries is the enforcement agency for state prevailing wage administration. The State (WSDOT) is protected under the contract from wage claims by reserving 5 percent of the moneys earned as retained percentage. This 5 percent is made available for unpaid or underpaid wages liens among other claims. Contract payments should not be deferred due to a contractor's failure to pay the State minimum prevailing wage.

**Federal Wage Administration** – FHWA-1273 specifies that the State Highway Administration (SHA) is in the enforcement role for federal prevailing wage administration. Under Section IV "Payment of Predetermined Minimum Wage" subsection 6., "Withholding," the State Highway Administration (contracting agency) is authorized to withhold an amount deemed necessary to make up any shortfalls in meeting Davis Bacon prevailing wage requirements. It goes on to authorize the deferral of all payments, under certain conditions, until such violations have ceased. This is only for federal wage requirements and the amount "deemed necessary" must be based on the amount of the underpayment.

**Application of the Standard Specifications** – [Standard Specifications](#) Section 1-05.1 reads in part as follows: "If the Contractor fails to respond promptly to the requirements of the contract or orders from the Engineer: .... 2. The Contracting Agency will not be obligated to pay the Contractor, and ...."

[Standard Specifications](#) Section 1-09.9 reads in part as follows: "Failure to perform any of the obligations under the contract by the Contractor may be decreed by the Contracting Agency to be adequate reason for withholding any payments until compliance is achieved."

Sounds good and we can do so, but withholding of payments owed the contractor must not be done on an arbitrary basis. Other than the previously noted exceptions, money is normally withheld because work/work methods are not in accordance with contract specifications. Also, the amount withheld must have a logical basis. We cannot penalize the contractor by withholding more than the out of compliance work is worth.

Withholding payments should not be used routinely as a tool for forcing compliance on general contract administration requirements. The State is protected against nonperformance by requiring a performance bond. In the event that lack of contract compliance puts the State at substantial risk monetarily or safety wise, it may be appropriate to inform the contractor of the compliance problem and suspend work under [Standard Specifications](#) Section 1-05.1 until corrections are made.

When withholding money, remember that delaying the contractor's cash flow may damage the contractor's ability to perform work. Before doing so, the State should be able to demonstrate:

- Specifically what was not in accordance with the contract and where the requirement is specified in the documents.
- That the amount withheld is commensurate with the amount of the unauthorized, uncompleted or defective work.
- That the contractor was notified in a timely manner (within eight days per prompt pay laws) and given a chance to make corrections.
- That the State has worked with the contractor to mitigate corrections to non-specification work in order to minimize the cost.

The State is required to pay the contractor in a prompt manner within 30 days after receipt of the work or after recognition of entitlement to additional compensation. The Project Engineer must keep an eye on the calendar when scheduling monthly estimate payments.

Regions are not authorized to withhold amounts that are greater than the estimated cost of the missing or incorrect portion of the work. Any such excess withholding must be approved by the State Construction Office.

### **Delinquent Contractor Submittals**

Missing submittals is a principal source of delays in closing out the project and processing the final estimate. As the project proceeds toward completion, the Project Engineer and the Contractor should attempt to obtain all submittals as the need arises. These might include such things as materials certificates, certified payrolls, extension of time requests, or any other item or document that might delay processing the final estimate. Attention is needed to assure the receipt of these items from subcontractors as they complete their work.

### **Final Estimates**

The final estimate for a Contract is processed in CAPS by selecting the "Final" option when running the estimate. The final estimate is a two part process that begins with the Region running the Region Final and is completed when the Accounting and Financial Services (AFS) Division runs the Headquarters Final.

Running the Region Final in CAPS will not generate a warrant for the Contractor, but instead will generate the following reports:

- Final Comparison of Quantities
- Contract Estimate Payment Advice
- Contract Estimate Payment Total and
- Sales Tax Summary

*The Work Done to Date entry on a final estimate is the Physical Completion Date. CAPS cannot process estimates if the Work Done to Date entered is after the Physical Completion Date.*

Review the reports generated for accuracy, verifying quantities posted and costs accumulated during the life of the Contract. Corrections can be made to the project ledger in CAPS and the Region Final can be rerun as needed to ensure it is correct.

Region Finals showing an overpayment to the Contractor will be processed in the same manner. If this occurs, the Contract Estimate Payment Totals report will show a negative amount due to the Contractor. When AFS receives the accepted final estimate package, they will request reimbursement from the Contractor for the amount owed. The Project Engineer should not request reimbursement from the Contractor.

Once the Project Engineer has validated the amounts, forward the following documentation to the Contractor using the approved electronic software:

- Contract Estimate Payment Totals Report - CAPS report RAKC300F-EA - Informational only, Contractor signature not required
- Final Contract Voucher Certification (FCVC) DOT Form 134-146 - Requires Contractor signature

The person signing the Final Contract Voucher Certification must be authorized to do so. Authorized signatures are submitted by the Contractor at the beginning of each Contract.

Submit the documentation noted above to the Contractor for electronic signature as soon as reasonably possible, but within six months of Physical Completion.

Once the Contractor and PE signatures are obtained, the FCVC will automatically be sent to Region by the electronic signature software. Region cannot proceed with signatures and approvals until all outstanding documentation has been received and the Project Office sends the final estimate package for review.

After Contract Completion has been granted and the Region has reviewed and approved the FCVC, submit the final estimate package to the State Construction Office. Project Offices must submit documentation to the region for region executed contracts. Include recommendations for assessment of liquidated damages associated with Contract time if not submitted previously. The State Construction Office must resolve all issues of liquidated damages before the final estimate package can be accepted and submitted to the AFS and Financial Services Division.

### **Final Estimate Package**

The final estimate package consists of the following:

- **Project Status Report will include:**
  - Contract time and recommendations for liquidated damages related to contract time.
  - Amount of railroad flagging used if any.
  - Identify Miscellaneous Deductions by including backup documentation equal to the amount deducted
  - Explanation of any Monies Due WSDOT as indicated in the Contract Estimate Payment Totals.
  - Identification of overruns/underruns in Contract quantities and a brief explanation of resolution.
  - In addition, indicate whether or not all Affidavits of Wages Paid have been received for the Contractor, and all Subcontractors, agents or lower-tier subcontractors. List all Contractors, subcontractors, etc. for whom an Affidavit has not been received.
  - Federally funded projects advertised after October 17, 2022 - Confirmation that all Build America/Buy America (BABA) CMO forms are on file and resolutions are documented.

- **Final Contract Voucher Certification** – DOT Form 134-146, original only.
- If an assessment of liquidated damages has been made previously, include a copy of the letter from the State Construction Engineer to the Contractor assessing these.
- If an assessment of miscellaneous damages or liquidated damages resulting from causes other than time, include copies of letters from the Region to the Contractor to document assessments.
- **Contract Estimate Payment Totals** – RAKC300F-EA.

The final estimate package for contracts executed by the Region will be reviewed by Region Construction and the Final Contract Voucher Certificate will be signed by the Region Administrator (as Designee) accepting the Contract. The date on which the Region Administrator signs the Final Contract Voucher Certificate becomes the final acceptance date for the Contract. The final estimate package is retained with the permanent final records.

When the final estimate package is reviewed by the State Construction Office for acceptance of the Contract, the date the State Construction Engineer signs the Final Contract Voucher Certification becomes the final acceptance date for the Contract. The final estimate package is then submitted to AFS.

### Final Estimate Claim Reservations

Should the Contractor indicate a claim reservation on the Final Contract Voucher Certification, it must be accompanied by all the requirements of [Standard Specifications](#) Section 1-09.11(2) (provided these have not been met in a previous claim submittal). The Project Engineer must assure that the requirements have been met prior to submitting the final estimate package to the State Construction Office. If the claim package is incomplete, return the FCVC to the Contractor with notice of the missing parts.

### Unilateral Acceptance

The Project Engineer cannot establish Contract Completion if the Contractor is unwilling or unable to submit one or more of the required documents noted in [Standard Specifications](#) Section 1-08.5. However, the Region can request that the State Construction Engineer accept the Contract by signing the Final Contract Voucher Certification (FCVC) in spite of the missing documents.

If the Contractor has not signed the FCVC, the Region can request that the State Construction Engineer accept the Contract without the Contractor's signature. The Region is responsible for notifying the Contractor before such a request is made. The State Construction Office will send the email and delivery confirmation required in [Standard Specifications](#) Section 1-09.9. The date the State Construction Engineers signs the FCVC becomes both the final acceptance date and the Contract Completion date for the Contract, both established unilaterally.

### Formal Claim Settlements After Acceptance

Formal claim settlements are negotiated and approved by the Assistant State Construction Engineer, and may require payment adjustments after the Final Contract Voucher Certification (FCVC) is signed. To process a payment or take a credit after a project is accepted by the State Construction Engineer, the Project Engineer should complete, assemble and route the following items.



1. Send the formal claim settlement (which has been approved by the Assistant State Construction Engineer) and a letter to the Contractor that includes the following information:
  - A claim decision has been determined
  - The formal claim settlement documentation
  - The amount of the claim settlement
  - Who made the decision and what process was utilized
  - Timeframe for paying the settlement
  - Request the Contractor sign and return the attached formal claim settlement
  - Include the statement: "This Claim Settlement Statement is issued in connection with the settlement of a claim, as evidenced by the attached settlement agreement. The execution of this Statement does not change the established Completion Date and Final Acceptance Date of the contract or cause the need for a new final contract voucher."
2. Contact region program management to determine if work order needs to be reopened in TRAINS. If a separate group will be used to track settlement payments, request the new group and provide a copy of the letter.
3. Send the original, contractor signed, settlement agreement, a copy of the letter and payment information (group/control Section to be used) to the State Construction Office. The State Construction Engineer or the Deputy State Construction Engineer will sign the settlement agreement, and forward received documentation to CAPS. A copy of the agreement will be returned to the Project Office for inclusion in the contract Permanent Final Records. CAPS will inform the Project Office of the new item number created in CAPS.
4. Prepare a Field Note Record to document the payment, and post as an entry for the new item number using the appropriate group(s). Taxes will be assigned based on the group(s).

Once complete, the Project Engineer runs a Supplemental Final Estimate and contacts HQ CAPS for further instructions.

### **Supplemental Final Estimates**

A Supplemental Final Estimate is a payment adjustment made to a contract after the Final Estimate has been processed and the project has been accepted by the State Construction Engineer. A Supplemental Final Estimate may be necessary to correct an inadvertent under payment or where a claim settlement may require additional payment be made to the Contractor. In order to complete a Supplemental Final Estimate, the Project Engineer should complete and assemble the following items, routing them through the Region to the State Construction Office for review and further processing:

1. Complete any corrections or additional postings necessary in CAPS, including any postings to change order items added to CAPS for the settlement of a claim. (Please note, where additional CAPS postings are necessary after the Physical Completion date has been established, the "Work Done To" date in CAPS must be entered as the Physical Completion date or prior.)

2. Complete a Pre-Estimate report including the Project Engineer's recommendation for payment.
3. Assemble the backup information supporting the necessity and substantiating the cost of the changes to be made.
4. Send 2 and 3 above via email or campus mail to the State Construction Office.

After review, the Pre-Estimate report will be signed by the State Construction Engineer authorizing payment to proceed.

While postings and corrections to CAPS may continue, once the Completion date has been established for a contract, CAPS will no longer allow the Project Engineer or the Region to process further payments to the Contractor. As a result, payment of the Supplemental Final Estimate will need to be completed for the Project Engineer by the Accounting and Financial Services Division.

If this process requires a more timely response, the above documentation may be scanned and emailed to the State Construction Office and CAPS; and the contract payments Section can be requested to print out the pre-estimate report to be taken to the State Construction Engineer for signature prior to processing the supplemental final estimate. Once the supplemental payment is completed, the signed and executed Pre-Estimate report will be returned to the Project Engineer where it can be maintained as a part of the project payment files and made a part of the Region Temporary Final Records.

The above process will also be used when there has been an inadvertent over payment to the Contractor, the Final Estimate has been processed, and the project has been accepted by the State Construction Engineer. In this case, the Project Engineer must work with the Region, the Contract Payments section of the Accounting and Financial Services Division and the State Construction Office to make the correction.

If the Accounting and Financial Services Division requires a supplemental Final Contract Voucher to reflect the new cost of the contract due to the supplemental estimate, the new voucher will not be signed by the Project Engineer as that would reestablish the final acceptance date and restart the 30 day period to file claims against the bond ([RCW 39.08.030](#)) and restart the 180 day period for Contractor to file suit (Section 1-09.3(11)). The original acceptance dates will not change from the dates the Construction Engineer signed the original Final Contract Voucher Certificate.

### **SS 1-09.9(1) Retainage**

Retained percentage withholding is based upon [RCW 60.28](#), which provides that:

- A sum not to exceed 5 percent of the money earned by the Contractor on estimates for projects containing no Federal funds is to be retained by the Contracting Agency.
- The Contractor may submit a bond for all or any portion of the amount of funds retained by WSDOT.

When a Contract is awarded, the Division of Accountability and Financial Services (AFS)/Contract Administration and Payments System (CAPS) unit or the Region Plans Office sends a package of contract documents to the Contractor.

This package of Contract documents also includes the necessary instructions for the Contractor to make application for a bond to replace all or any portion of the retainage. The bond form will be processed by AFS/CAPS without involvement from Project Engineer's Office, although the payment system will not allow them to process a payment until some form of retainage is in place.

The Contractor, at any time during the life of the contract, may make a request to the Project Engineer for the release of all or any portion of the amount of funds retained. This request does not need consent of surety since the retainage bond form, for this purpose, requires their consent. The Region must forward this request by transmittal letter to AFS/CAPS, which will furnish the appropriate bond form to the Contractor for execution. The Contractor may return the executed bond form directly to AFS/CAPS for final approval and signature by WSDOT.

- Effective July 27, 2011, for projects containing no Federal funds that include landscaping work the Contractor may request that, 30 days after completion of all contract work other than landscaping work, WSDOT release and pay in full the amount of funds retained during the life of the contract for all work except landscaping. In order to initiate this release of funds, DOT Form 421-009 should be completed by the Contractor and submitted to the Project Engineer. In signing the request, the Project Engineer will confirm that all work, except landscaping work, is in fact physically completed. For any landscaping work that may have been completed, the Project Engineer will designate the amount of landscaping moneys, if any, that have been earned to date by the contractor. In the space designated for remarks the Project Engineer will identify the landscaping or plant establishment work that remains to be completed and its approximate value. Except for landscaping work, the Project Engineer will determine if all Statements of Intent and Affidavit of Wages Paid have been received for the work that has been physically completed. The Project Engineer will transmit to the Contractor a list of all subcontractors, including UBI numbers, believed to have performed work on the project. The Contractor will verify which subcontractors did work on the project and that the UBI number listed is correct for each subcontractor. DOT Form 421-009 will not be transmitted to AFS/CAPS until the Contractor has verified the subcontractors and UBI numbers. WSDOT will continue to withhold a 5 percent retainage of any moneys earned for landscaping work that may have been completed to date and will continue to retain 5 percent of the moneys that are to be earned for landscaping that is yet to be completed. A bond is not required.

The completed request along with the Project Engineer's cover memo confirming receipt of Statement of Intent and Affidavit of Wages Paid for the Contractor, subcontractor, and any lower-tier subcontractors, who were involved in the completed work, is then forwarded to the State Construction Office, through the Region Construction Office, for approval. Once approved, the Construction office will submit the request to AFS/CAPS for further processing. If there are no claims against the retainage still in place and releases have been received from Revenue and Employment Security within the designated 60 day period, AFS/CAPS will release the appropriate portion of retainage to the Contractor.

### **SS 1-09.10 Payment for Surplus Processed Materials**

When excess aggregate is produced by the Contractor from a WSDOT furnished source, the Contractor will be reimbursed actual production costs if the excess materials meet the requirements of *Standard Specifications* Section 1-09.10. If more than one type of aggregate is involved, the provisions of *Standard Specifications* Section 1-09.10 apply to each type. When excess aggregate for HMA is produced, adjust the planned and actual HMA quantity by deducting the quantity of Asphalt and RAP or other materials used in the mix.

If WSDOT has a need for the excess aggregate for either maintenance or future construction contracts, the material may be purchased into the appropriate inventory account. The Project Engineer should contact Region Maintenance and the Accounting and Financial Services Division for guidance. If aggregates are to be disposed of as surplus, the Project Engineer should contact the State Administrative Services Office, Purchasing and Inventory Section, for additional assistance.

### **SS 1-09.11(2) Claims**

#### **Claims by the Contractor**

The *Standard Specifications* contains specific requirements in Section 1-04.5 which, if not followed, may result in a waiver of the Contractor's rights to submit a Certified Claim. The Project Engineer should monitor whether the Contractor has met these requirements. If all the requirements have been met, the Project Engineer must evaluate the merits of the Certified Claim.

If the Contractor has pursued and exhausted all the means provided in *Standard Specifications* Section 1-04.5 to resolve a dispute, the Contractor may file a Certified Claim. A Certified Claim, filed in accordance with *Standard Specifications* Section 1-09.11(2), is a much more structured device and demands a high level of conformance with the contract requirements. The objective is to utilize the rights that WSDOT has under the contract to identify the issues, obtain a sufficient level of information from the Contractor and limit the discussion to a defined subject matter. To accomplish this, and to maintain the Department's rights in a situation that may lead to court action and expensive lawsuits, the Project Engineer must insist on rigid conformance with the requirements of the provision. In fact, the first evaluation must not be of the claim's merit, but rather of the claim's structure and content. If the package fails the specification requirements in any way, it should be returned to the Contractor immediately with a written explanation. Conversely, if the package meets the contract requirements, then the Project Engineer must comply with the demands for WSDOT actions that are included in the same specification.

The notarized statement that is required to accompany the Certified Claim states that it is a "true statement of the actual costs incurred and time sought and is fully documented and supported under the Contract between the parties." The Contractor is acknowledging that they have expended the cost and time that they are seeking. Therefore, a Certified Claim may only be submitted after the costs have been realized. If the Project Engineer receives a Certified Claim for costs that have not been realized by the Contractor they should contact the State Construction Office.

The existence of a Certified Claim does not diminish the responsibility of the Project Engineer to pursue resolution. The only difference is that State Construction Office final approval of a proposed settlement is required. The change order settling a formal claim must include waiver language similar to the following:

“The Contractor, (company name), by the signing of this change order agrees and certifies that:

Upon payment of this change order in the amount of \$\_\_\_\_\_, any and all claims set forth in the letter(s) to the Department of Transportation, dated \_\_\_\_\_ and signed by \_\_\_\_\_ of (company name) in the approximate amount of \$\_\_\_\_\_, have been satisfied in full and the State of Washington is released and discharged from any such claims or extra compensation.”

If the settlement is intended to close out all dispute discussions for the contract, use language similar to:

“The Contractor, (company name), by the signing of this change order agrees and certifies that:

Upon payment of this change order in the amount of \$\_\_\_\_\_, any and all claims in any manner arising out of, or pertaining to, Contract No. \_\_\_\_\_, (including but not limited to those certain claims set forth in the letter(s) to the Department of Transportation, dated \_\_\_\_\_ and signed by \_\_\_\_\_ of (company name) in the approximate amount of \$\_\_\_\_\_, have been satisfied in full and the State of Washington is released and discharged from any such claims or extra compensation in any manner arising out of Contract No. \_\_\_\_\_.”

## Legal Filing

Once the Contractor has submitted a Certified Claim in acceptable form and the State has either denied the claim or failed to respond in the time allowed, the Contractor is free to seek judicial action by filing a lawsuit or, in some cases, demanding binding arbitration. Note that the Contractor must fully comply with the provisions of [Standard Specifications](#) Section 1-09.11 before it can seek judicial relief. Once any legal action has been started, the Project Engineer may only continue with settlement efforts if the Attorney General’s office has given specific permission to do so. Such permission may be sought through the State Construction Office. Settlements of claims which have resulted in a judicial filing need review and approval by the Attorney General’s office and different waiver language similar to the following:

“The Contractor, (company name), by the signing of this change order agrees and certifies that:

Upon payment of this change order in the amount of \$\_\_\_\_\_, any and all claims in any manner arising out of, or pertaining to, Contract No. \_\_\_\_\_, (including but not limited to those certain claims set forth in the complaint filed under Thurston County Cause No. \_\_\_\_\_ (Contractor’s name) vs. State of Washington), have been satisfied in full and the State of Washington is released and discharged from any such claims or extra compensation in any manner arising out of Contract No. \_\_\_\_\_.”

Any documents pertaining to a settled claim which has resulted in a judicial finding must be kept for a period of six (6) years following the date of the court order dismissing the lawsuit.

## Final Contract Voucher Certification

The Final Contract Voucher Certification requires the Contractor to acknowledge and certify that the final estimate is a correct statement showing all monies due from the State. The dollar amount shown in the Final Amount section of the form is shown on CAPS report RAKC300F-EA. Use the dollar amount shown in the Total of Contract Items in the column titled TOTAL TO DATE:

HWY-RAKC300F-EA		STATE OF WASHINGTON DEPARTMENT OF TRANSPORTATION CONTRACT ESTIMATE PAYMENT TOTALS		DATE: 05/05/22
CONTRACT: [REDACTED]		ESTIMATE NUMBER: 9999 DIST. FINAL		TIME: 10:32:17
DISTRICT: 3		WORK DONE TO: 07-30-2021		PAGE: 1
WARRANT REGISTER NO.		JOURNAL VOUCHER NO.	VOUCHER NO.	
		<-TOTAL-TO-DATE-->	<-PREVIOUS AMOUNT>	<-PRESENT AMOUNT-->
TOTAL OF CONTRACT ITEMS		5,847,638.50	5,847,638.50	
LESS: NO RETAINAGE				
31 RAILROAD FLAGGING				
12 LIQUIDATED DAMAGES				
34 MISC. DEDUCTIONS		250.00	250.00	
32 MONIES DUE WSDOT				
PLUS: SALES TAX				



The final amount reported on the FCVC will be the total paid for Contract Bid Items and does not include amounts paid in retail sales tax or miscellaneous liquidated damages.

The Final Contract Voucher Certificate releases the State from any claims arising from performance of the Contract. The Contractor must submit any Certified Claims with, or prior to, signing the FCVC and must note any Certified Claims as exceptions on the FCVC. If there is no exception above the Contractor's signature on the FCVC, the Contractor's right to submit a Certified Claim has been waived.

Once the project is physically complete, the Project Office will assemble the final estimate and send it to the Contractor with the FCVC for signature. If the Contractor does not sign and return the FCVC in a reasonable time, WSDOT may unilaterally set the completion date and process the final estimate without the Contractor's signature. The Project Engineer will send at least one reminder to the Contractor prior to pursuing unilateral final acceptance. Discuss proposals to unilaterally accept a Contract with Region managers before contacting the State Construction Office to request unilateral final acceptance. Include evidence of the initial transmittal of the FCVC and any reminders sent to the Contractor when sending requests to the State Construction Office for unilateral final acceptance. The Contractor must submit any Certified Claims prior to unilateral final acceptance or their rights to said claims shall have been waived.

**Note:** Contracts executed by the Region do not require acceptance by the State Construction Engineer. The final signature will be the Region Administrator, Area Administrator, or designee.

### SS 1-09.12 Audits

The Project Engineer is responsible for preparing all necessary records to document the work performed on the Contract. Detailed instructions on the records required and methods of preparing them are covered in Chapter 10.

#### Construction Quality Audits

Construction Quality Audits will be performed by the Construction Division - State Materials Laboratory to document conformance of project records to DBE compliance, construction administration and materials certification standards.

The Construction Quality Audit consists of documentation review and may include a field review. The documentation review will normally be conducted at the Project Office unless arrangements are made for it to be conducted elsewhere.

The goal is to perform a Construction Quality Audit on at least one project per Project Office every three years. Construction Quality Audits may be conducted more frequently at the discretion of the Construction Division. Projects will be selected with consideration given to project size and complexity.

Audits are typically performed during the active life of the project; generally, 20 percent to 80 percent complete, but also may occur after substantial completion has occurred. Construction Quality Audits are performed to validate that construction inspection, contract administration, materials testing and documentation are completed in accordance with established requirements and standards.

Records reviewed will include those maintained and developed by the Project Engineer for DBE compliance, inspection requirements, approval, testing, acceptance and field verification of materials placed and paid for on the Contract.

In addition to general audit deficiencies found, the following are audit performance measures:

- Record of Materials: Accuracy maintained with less than 10 percent errors
- Materials Approval: Accuracy maintained with less than 10 percent errors
- Materials Acceptance: Accuracy maintained with less than 10 percent errors
- Field Verification: Accuracy maintained with less than 10 percent errors
- Materials Testing Frequencies: Within 10 percent of minimum required frequencies

Audit areas with less than 10 percent deficiency are exit items, while audit areas that exceed 10 percent are audit findings.

Upon completion of the audit, the findings will be discussed with the Project Engineer and/or their representative. Audit exit items are areas for the Project Engineer to make improvements to processes and can require corrective action be taken to resolve the issue. General audit deficiencies and audit findings are more serious and require a corrective action plan to document the Project Office process improvements. The final audit report will be sent to the Project Engineer with copies sent to the Region Documentation Engineer, Region Construction Engineer, State Construction Office, Construction Materials Office, and the FHWA Division Office.

The Project Engineer will address any general audit deficiencies, exit items and audit findings found by the audit, documenting the correction, deviation or change that resolved the deficiency. Deficiencies not rectified or meeting the requirements of [Section 9-1.2F](#) shall be noted during the Materials Certification.

The Project Engineer is responsible for developing and implementing a corrective action plan to ensure audit deficiencies and audit findings are avoided on future audits and to review the corrective action plan with the Region Construction Engineer for their concurrence.

All contract documentation shall be available for review by the Audit Team. The following items of documentation may be requested by the Audit Team:

1. Request to Sublet Work Form 421-012
2. DOT Form 420-004
3. DBE On-Site Review Form 272-052
4. Record of Materials, as revised and amended by the Project Office (see [Section 9-1.2C](#))
5. Approval Documents
  - a. Request for Approval of Material (see [Section 9-1.3B](#))
  - b. Qualified Products List pages (see [Section 9-1.3A](#))
6. Acceptance Documents
  - a. Test Results
    - Acceptance Test Reports
    - Assurance Test Reports (where applicable)
    - Independent Assurance Test Reports (where applicable)
    - Verification Test Reports (Cement and Liquid Asphalt)
    - Toxicity Test Reports (Recycled Materials)
  - b. Manufacturer's Certificate of Compliance (see [Section 9-1.4D](#))
  - c. Miscellaneous Certificates of Compliance (see [Section 9-1.4E](#))
    - Lumber Grading Certificate
    - Certification of Cement Shipment
    - Notice of Asphalt Shipment or Certified Bill of Lading
    - Any other certificates required by the contract documents
  - d. WSDOT Fabrications Inspected Items (see [Section 9-1.4B](#))
  - e. Concrete Pipe Acceptance Report (see [Section 9-1.4B\(3\)](#))
  - f. Catalog Cuts (see [Section 9-1.4G](#))
  - g. Proprietary or Agency Supplied Items (see [Sections 9-1.3B\(1\)\(IV\)](#) and [9-1.3B\(1\)\(V\)](#))
  - h. Visual Acceptance Items (see [Section 9-1.4C](#))
  - i. Reduced Acceptance Criteria Checklist (see [Section 9-1.1](#))
7. Field Verification Documentation (see [Section 9-1.5](#))
8. Inspectors Daily Reports
9. Field Note Records
10. Comparison/Summary of Quantities
11. List of Change Orders
12. Project Office Signature/Initial List
13. List of all materials testers and their qualification records
14. Other documentation as requested by the Auditor.



## 1-10 Temporary Traffic Control

### SS 1-10.1 General

#### Work Zone Traffic Control

The primary function of work zone traffic control is to move vehicles and pedestrians safely through or around work zones while protecting on-site workers and accommodating the Contractor's construction operations.

All work is to be performed by the Contractor under the Contractor's control and supervision. All resources are to be provided by the Contractor unless the Special Provisions of the Contract specifically states that the Department will provide some resource(s), what those resources will be and how they are to be utilized. Such provided resources will be placed in the Contractor's control to be used in the Contractor's operation. Any additional resources provided to the Contractor during the project should be accompanied by a change order to the Contract and, where appropriate, a price reduction.

The "General" requirements for traffic control (*Standard Specifications* Section 1-10.1) address the responsibility to provide adequate traffic control measures at work zones as follows:

- No Work shall be done until all necessary signs and traffic control devices are in place and conflicting or confusing signs are covered.
- If the Contractor does not provide necessary traffic control, WSDOT may do it and deduct the cost from the Contractor's payments.
- The Contractor is responsible regardless of whether or not WSDOT orders, furnishes, or pays for necessary traffic control.

It is important for the Project Engineer to ensure that the Contractor has an accepted traffic control plan in place and implemented providing all necessary signs and other traffic control devices so that the traveling public is aware of all deviations from the normal traffic conditions and is furnished adequate direction and guidance to permit safe travel through the construction area.

#### Law Enforcement Traffic Control Assistance

Law Enforcement traffic control assistance is considered an enhancement to the required work zone traffic control and should be reserved for those work zones that have unusual hazards or a high degree of worker exposure to traffic, which cannot be addressed by traditional traffic control means.

The use of Law Enforcement Officers in work zones follows two scenarios. Each scenario differs in the duties, management, administration, and payment for the officers.

## Uniformed Police Officer (UPO)

In the first case, a Contractor provided UPO may be included in the plans to participate in a Contractor's traffic control activity, perhaps for intersection flagging. The UPO is provided by the Contractor and their use will be defined in the Contract Provisions and traffic control plans. The Contractor shall direct the activities of the UPO and payment will be made in accordance with the Contract Provisions. It is important to note that Washington State Patrol (WSP) Troopers may be used in the roll of a UPO.

## Washington State Patrol (WSP)

The second case, WSP Troopers are dispatched for active enforcement for speed control or roadway/ramp closures around an active work zone. In this case, WSP does not participate in the Contractor's traffic control work with the possible exception of a rolling slowdown on the interstate. The Contract Provisions will identify the number of hours and tasks that will be provided at no cost to the Contractor. Costs for hours beyond what is noted in the provisions will be split between the Department and the Contractor if the Project Engineer approves the need for additional hours. There shall be no entitlement to their services and no entitlement for any impacts for any reason as a result of WSP personnel.

It is important to establish and maintain communication through all phases of Work that include WSP, beginning at the pre-construction conference. Topics of discussion might include: WSP tasks, Trooper scheduling coordination, and communication strategies.

Daily communication is necessary between the Project Inspector and WSP Trooper(s) assigned to the project at the beginning their shifts so they understand their roles and ensure that the appropriate traffic control strategy is applied. On each shift of WSP traffic control assistance, DOT Form 421-045, WSP Field Check List, shall be filled out. WSDOT will fill out the top portion of the form and give it to the WSP Trooper on the project to complete. At the end of the Trooper's shift, the completed form shall be returned to WSDOT.

WSDOT has agreement GC 5080 to reimburse the WSP for Trooper assistance on construction projects. Instructions for WSP assistance including contact information for the Districts and detachments are in the [Traffic Manual M 51-02 Chapter 5](#).

A mid-project decision to provide troopers would be a change order. To be fair to unsuccessful bidders, adding the WSP specifications to a Contract should have the initial number of hours set at zero if nothing else has changed so that all costs are shared between the Contractor and WSDOT. Routine enforcement by WSP in our work zones is always welcome.

## Records of Construction Signing, Collisions, and Surveillance

It is important that detailed documentation of temporary traffic control installations be maintained. The following are recommended procedures and methods of documentation:

- Use photos and video records.
- The Contractor's installation must adhere to the traffic control plan (TCP), and the records must confirm that the installation is checked against that plan. Involve the Regional Traffic Engineer for significant changes to the TCPs.

- Documentation of the Contractor's activity for traffic control, including signing, should be completed by the Contractor's Traffic Control Supervisor (TCS). In accordance with the *Standard Specifications*, the TCS must maintain a daily project traffic control diary. DOT Form 421-040A Contractor's Daily Report of Traffic Control – Summary, and 421-040B Contractor's Daily Report of Traffic Control – Traffic Control Log, are provided to the Contractor for this purpose.

The Summary report will typically contain a brief description of the daily activities of the TCS with expanded details of any important event such as traffic collisions, meetings, decisions, or rapidly deteriorating conditions of traffic or weather. The Summary report is usually sufficient to verify the location and status of Class A signs once they are installed.

- The Traffic Control Log report is used to specifically identify all details of each Class B work zone setup. This includes identification of specific signs used, location of the signs, location of Flaggers, location of the work zone, the time it was set up, and the time it was removed. Additional information includes cone layout, if used, comments about piloted traffic, and comments about the setup of an accepted TCP.

The Project Inspector must work with the Contractor to ensure the Project Office is informed when collisions occur. It is important that the Project Office be aware of all traffic collisions within the project area. Thorough records must be maintained about the collision, including site conditions, status of signing, other traffic control measures, and anything else that may have contributed to the incident.

When an incident is investigated by the WSP, do not move signs until released to do so by the Trooper. Attempt to make contact with the Trooper to obtain a copy of the incident report or a case number.

When inspections are made of the work zone, either by project or region personnel, document the inspection and maintain the reports in the project files along with responses to any action items that resulted from the inspection.

### **Work Zone Safety and Mobility**

In keeping with the above recommendations, the Project Engineer should utilize the information obtained from traffic control reports, collision reports, and other field observation in order to better manage Work Zone impacts. This will allow the Project Engineer to implement any necessary changes to traffic control in order to increase safety and to enhance mobility through the work zone.

At the completion of each project, the Project Engineer should review the traffic control used on the project in order to identify trends, etc. that may be used to improve Work Zone practices or strategies. This information should be summarized and provided to the Region Traffic Office for inclusion in annual reports.

## **SS 1-10.2 Traffic Control Management**

*Standard Specifications* Section 1-10.2 addresses the requirements and duties of the Contractor's management personnel responsible for traffic and the Traffic Control Supervisor (TCS). The Contractor has the responsibility for managing traffic control and providing safe traffic control measures that are appropriate for the type of work and consistent with the requirements of the contract plans and specifications. The Contractor's traffic control work is a contract activity. Just like other contract activities, it is associated with pay items. The activity must be inspected for adequacy

and conformance with the contract. Once it is performed and inspected, associated contract items must be measured and paid. Traffic management actions affect not only the Contractor's work operations, but also those of subcontractors. The process for coordinating and approving those actions must be well defined and consistent with the contract requirements.

Contractor management and the TCS work together with the Project Engineer and WSDOT's traffic control contact person to address traffic control issues as the work progresses. Planning and coordination of the Contractor's work efforts with appropriate traffic control measures are the primary responsibilities of contractor management. It is also the responsibility of management to ensure that any adopted State-provided or accepted Contractor-proposed Traffic Control Plans (TCPs) needed to implement the contract work operations are provided to the TCS and that any necessary resources to implement the TCP are available.

## SS 1-10.2(1) General

### SS 1-10.2(1)B Traffic Control Supervisor

The Traffic Control Supervisor (TCS) ensures that the traffic control measures shown on the accepted traffic control plans (TCPs) are properly implemented, operating, and documented on the project. The Contractor's TCS may not be required full time on the project, but is required to perform all the duties required by the Specifications. When the Contractor is working multiple shifts, it may be necessary to have more than one person assigned to the role.

In addition to the Contractor's responsibility to designate a Traffic Control Supervisor, WSDOT may designate a DOT employee who is qualified, but not necessarily certified, to serve as the State's traffic control contact. It is intended to have qualified, trained representatives from both the Contractor and WSDOT work together to achieve safe traffic control operations on the project.

Among the duties of the Project Engineer in the area of Traffic Control are the following:

- **Communication** – About the planned work, traffic control needed and adjustments to the accepted Traffic Control Plan. During the work, to stay aware of changes, events and issues.
- **Monitoring** – The activities of the Contractor TCS and traffic control workers. The status of signs and control devices. Conformance with specifications and requirements.
- **Documentation** – Obtaining and reviewing daily reports. Handling Traffic Control Plans and their approvals.
- **Coordination** – With adjacent projects, with DOT Traffic offices, notices to the media.

The Project Engineer may assign these duties in any manner. It would make sense to include the State's traffic representative in these activities.

When reference is made to the Traffic Control Supervisor (TCS) in these provisions or in the *Standard Specifications*, it shall mean the Contractor's Traffic Control Supervisor unless stated otherwise.

Verify the Traffic Control Supervisor is certified by one of the firms listed in the Special Provisions by recording their full name, TCS card number, and card expiration date in the Inspectors Daily Report. Do not take a copy of the TCS certification card.

## SS 1-10.2(2) Traffic Control Plans

*Standard Specifications* Section 1-10.2(2) addresses the requirements of Traffic Control Plans (TCPs). The Contractor must either adopt the TCPs appearing in the contract or propose modified TCPs to be used for the project. The Contractor must submit proposed modifications to plan TCPs or alternate plans at least ten calendar days in advance of the time the traffic control will be required. Approval of these plans must be obtained before the work can begin.

The possibility of alternate plans is covered by the contract. No change order will be needed because of that reason. However, if a price adjustment is needed then a change order will be necessary to accomplish that. We would allow additional payment, either through added units or revised lump sums, only if the original contract TCP was shown to be inadequate or in the case of traffic control needed for another change in the work. If the proposal is only for contractor convenience or preference, then a discussion of no pay for added traffic control or a credit for less traffic control would be appropriate. If the contractor should balk at this, the response could be “build according to plan.”

Minor modifications to the TCP may be made by the Traffic Control Supervisor to accommodate site conditions. Modifications or adjustments to the plan must maintain the original intent of the plan. When there is a change in the intent and/or substantial revisions are needed, a revised TCP shall be submitted for approval through the TCM to the Project Engineer. The Regional Traffic Office should be consulted when this situation occurs. Again, changes may call for a formal change order.

Traffic Control Plans should not only address all work zones and standard devices and signs but should also address issues such as:

- Conflicting or temporary pavement markings.
- Maintaining existing operational signs and covering conflicting signs.
- Staging requirements.
- Temporary vertical or lateral clearance restrictions.
- Temporary work zone illumination.
- Consistency with any existing work hour restrictions.
- Position of positive barriers for traffic hazards or worker protection.
- Vertical drop-offs.
- Work zone access.
- Intersections or access control (traffic signals, road approaches).
- Pedestrians and bicycles.
- Work zone capacity and related mobility impacts.

If the Contractor’s method of operation or the work area conditions require other than minor modification of the specific TCP appearing in the contract or any of the TCP’s previously designated and adopted by the Contractor, the Contractor shall submit a proposed modification of the TCP for approval. If the Contractor’s proposed modifications comply with the MUTCD requirements and are consistent with contract requirements as well as State and Region policy, the Project Engineer may approve these proposed modifications (perhaps utilizing a change order, if appropriate.) If the Contractor’s proposed modifications do not comply with the MUTCD requirements, the Project Engineer should consult with the Region Traffic Engineer.

Any Contractor proposed TCP or modifications to an existing TCP should be evaluated for their effects on work zone safety and mobility. The Project Engineer should refer to the guidance in the [Design Manual](#) M 22-01 Chapter 1010 when evaluating how the new TCP works within the projects overall Transportation Management Plan (TMP).

On heavily used freight routes (I-5, I-205, I-405, I-90, I-82, I-182, SR 18, SR 167, and US 395-Tri-cities to Spokane), the contract may require that the Contractor provide the Engineer 30 calendar days of notice before implementing a TCP that reduces the travelled way to a single lane with a clear width of less than 16 feet for more than 4 calendar days. The request from the Contractor will include a schedule showing the dates of the width reduction, details of the limits and amount of the width reduction, description of available detour routes and a plan to provide unrestricted travel windows through the work zone when possible. The Engineer must provide 21 days of advance notice to Commercial Vehicle Services (CVS) at [CVSPermits@wsdot.wa.gov](mailto:CVSPermits@wsdot.wa.gov). The Engineer should provide details of the width reduction to CVS and provide updates if there are any changes or adjustments in the schedule for the width reduction.

If there is any doubt that the proposed TCP complies with the MUTCD or provides for the safe movement of traffic, the Project Engineer shall consult with the Region Traffic Engineer or the Region Construction Manager.

### **SS 1-10.2(3) Conformance to Established Standards**

Must meet standards of the MUTCD, and MASH 16 for devices made after 12/31/19 EXCEPT:

If a device is not available with a manufacture date of 12/31/19 or later, then the Contractor may use a device that is compliant with either NCHRP 350 or MASH 09 with approval from the engineer.

If the device was made prior to 12/31/19 and it was tested by NCHRP report 350 or MASH 09 it can be used through normal service life.

Small devices – channelizing and delineating including cones, tubular markers, flexible delineator posts, plastic drums can meet either NCHRP 350, MASH 09, or MASH 16 as determined by device.

Determination of crashworthiness is not required for trailer mounted devices like arrow displays, temporary traffic signals, area lighting supports and PCMSs.

**Standard Specifications** Section 1-10.2(3) addresses the requirements for standards and condition of signs and all other traffic control devices. In addition to standards established in the latest adopted edition of the MUTCD and/or as specified in the contract plans, all traffic control devices shall meet the crashworthiness standards of the “National Cooperative Highway Research Project, 350 (NCHRP 350) or the AASHTO *Manual for Assessing Safety Hardware* (MASH). There are four categories of traffic control devices. Category 1 devices consist of small lightweight devices that generally do not present a hazard. Typical Category 1 devices are cones, tubular markers, and plastic drums with no attachments. The Contractor is required to keep the manufacturer’s certification document on file and available for inspection if needed. Inspection of certification documents by WSDOT is not routinely required but should be considered if operational or safety issues are observed.

Category 2 contains devices that are more hazardous due to their rigid construction, such as barricades, portable sign stands, and drums with lights. The collision test certification rules apply to all Category 2 devices. The Inspector should verify, and document, that all portable sign stands have an identifying label affixed. The label will display the FHWA approval letter designation and will appear similar to the image below.

Category 3 devices are fixed or substantial in mass and could cause significant damage to a vehicle or its occupants. Devices such as barriers, fixed sign supports, and TMAs are included in this category. WSDOT maintains a list of approved devices in this category on the QPL. Barrier is to be included in the contract plans to ensure that it meets WSDOT design standards.

Category 4 devices are typically trailer or truck mounted devices such as arrow boards, PCMS, portable signals, and portable lighting units. Crash testing is not required for these devices but care must be given to their placement to ensure that they do not pose an undue hazard to drivers, and that they meet the requirements of Section [SS 1-10.3\(3\)](#).

### Resources for Traffic Control and Work Zone Safety

The following information may provide additional guidance and more specific detail. Also, this list includes the staff, reference documents, and manuals mentioned throughout Section [SS 1-10.2\(3\)](#).

- *Work Zone Traffic Control Guidelines* M 54-44
- [Traffic Manual](#) M 51-02 Chapter 5
- MUTCD Part VI
- Work Zone Safety Task Force Recommendations
- Quality Guidelines for Temporary Traffic Control Devices (ATSSA)
- Work Zone Traffic Control Supervisor's Notebook
- Highway Work Zone Reviews, 1997 (Work Zone Safety Task Force)
- Planning and Scheduling Work Zone Traffic Control (FHWA-IP-81-6)
- Executive Order E 1060 Speed Limit Reductions in Work Zones
- [Traffic Manual](#) M 51-02 Appendix 5A Work Zone Traffic Control
- Traffic Control Supervisor Evaluation – Final Report
- Region Construction or Traffic Office (Traffic Engineer or Work Zone Traffic Control Specialist) and Public Information Officer
- State Traffic Office (Mobility and Safety Manager or the State Traffic Control Engineer)

## SS 1-10.3 Traffic Control Labor, Procedures, and Devices

### SS 1-10.3(1) Traffic Control Labor

All traffic control labor must be trained to ensure safety in the work zone. Flaggers have additional requirements concerning flagging cards and apparel.

All flaggers working on WSDOT construction projects must have a valid State of Washington flagging card or a flagging card issued by the states of Oregon, Montana, or Idaho. Document verification of the card by recording the flaggers full name, card number and card expiration date in the Inspectors Daily Report. Do not take a copy of the flaggers card. Flaggers and all other personnel performing the Work described in [Standard Specifications](#) Section 1-10, are required to wear high visibility apparel as specified in

[Standard Specifications](#) Section 1-07.8. Other workers may certainly use this type of clothing, but doing so is not a contract requirement, unless they are performing work on foot within the work zone of a Federal-Aid highway.

### **SS 1-10.3(1)A *Flaggers***

Typically, flaggers have the highest exposure to traffic hazards than other workers, so flaggers should only be used when all other forms of traffic control are inadequate. When flaggers are used, flagging stations must be shown on the TCP along with warning signs and other devices. Flagger stations shall be illuminated at night and should be protected with a positive barrier, if possible. The flagger must also have in mind an “escape plan” to avoid errant vehicles. Flaggers are not allowed on freeways and the use of flaggers to exclusively display the “SLOW” message is also not allowed. The provisions call for a flagger with intermittent responsibilities to direct traffic to step back from the flagging station between tasks. Additional guidance on the use of flaggers is located in Part 6 of the MUTCD and [WAC 296-155-305](#).

### **SS 1-10.3(1)B *Other Traffic Control Labor***

For some projects, labor in addition to the assigned Flaggers is needed for a variety of traffic-related tasks. Some of these tasks are listed in the provisions. Hours for this item are measured only for work on certain defined tasks (see [Standard Specifications](#) Section 1-10.4(2)).

## **SS 1-10.3(2) *Traffic Control Procedures***

### **SS 1-10.3(2)A *One-Way Traffic Control***

The major points to note in [Standard Specifications](#) Section 1-10.3(2)A are:

- The provision does not limit one-way traffic control to treated bases, surface treatments, and pavements. This type of configuration can be used in other operations, such as grading, when appropriate.
- Line of sight is important in coordination of side roads and approaches with the limits of the one-way operation.
- When the contract does not stipulate a pilot car operation, it may be established by change order if the Engineer deems that method of traffic control to be most appropriate; and
  - Contractor vehicles and equipment may utilize the closed lane in any manner. The one-way controlled open lane is for public traffic and, should the contractor use that lane, all rules and procedures applicable to public traffic will apply to the contractor. There will be no “wrong-way” travel in the open lane, no heavy equipment will join the public traffic and any additional traffic control will be performed according to accepted plans only.
  - The contractor is required to plan and conduct operations so that the roadway can be reopened to two-way traffic at the end of the shift. If the nature of the work prevents this or if the work area is left in a condition unsafe for public two-way traffic, then the contractor must continue the one-way operation throughout the off-shift hours.



**SS 1-10.3(2)B Rolling Slowdown**

This can be a useful method of creating gaps in traffic for specific, very short-term non-repetitive activities such as sign bridge removal or utility wire crossing. Rolling slowdown traffic control operations are not to be used for routine work that can be addressed by standard lane or shoulder closure traffic control. The Contractor may implement a rolling slowdown on a multilane roadway, as part of an accepted traffic control plan per [Standard Specifications](#) Section 1-10.3(2)B. The key is planning and communication so the work can be completed without stopping traffic. If the work is not completed the contractor must undertake the most expeditious method of opening the roadway. If demobilizing and pulling off is faster than finishing the task, then it shall be done without regard to cost, efficiency, or schedule.

**SS 1-10.3(2)C Lane Closure Setup/Takedown**

The use of truck-mounted attenuators (TMA) with arrow boards is required by the provisions. This combination is to be used during the transition from open lane to closed lane. Once a lane is closed, the TMA may be removed, leaving the arrow board alone.

**SS 1-10.3(2)D Mobile Operations**

The key to this operation is to keep the traffic control equipment effectively close to the work and moving to match the work operation. Two traffic protection devices are used. One is a TMA/Arrow Board combination upstream of the work. The primary purpose of this device is to protect the errant vehicle from fixed object collisions. The second device (preferably a TMA) is immediately adjacent to the work area. Its purpose is to protect the workers from the errant vehicle.

**SS 1-10.3(2)E Patrol and Maintain Traffic Control Measures**

This activity is to observe, repair and maintain traffic control devices and layout. The provisions require an hourly visit to each device and layout. Depending on the extent of the control measures, more than one patroller may be required.

**SS 1-10.3(3) Traffic Control Devices****SS 1-10.3(3)A Construction Signs**

The standard of these provisions is that the contractor provides all signs, posts and supports. If the special provisions do not promise that some or all of these will be furnished by the State, then the contract requires the contractor to do it all. All signs shall be constructed from either aluminum or aluminum composite materials.

“Do Not Pass” and “Pass With Care” signs are the responsibility of the Contractor. The provisions explain how to determine the number of these and that determination is to be made by the Contractor as well.

Construction Signs ([Standard Specifications](#) Section 1-10.3(3)) divides construction signs into two categories, Class A and Class B, and lists the work required for the Contractor.

At no time should signs be left in traffic control position during periods when they are not necessary to traffic safety. Indiscriminate use of traffic control signs soon destroys public confidence and respect for the signs. Unnecessary traffic restriction and inconvenience tends to reduce the effectiveness of all signing and causes difficulty in enforcement by

authorities. The Project Engineer should ensure that signs are removed or completely covered per [Standard Specifications](#) Section 8-21.3(3) during the hours they are not needed, either before or after working hours and on nonworking holidays or nonworking weekends. Tripod-mounted signs in place more than 3-days in any one location, unless approved by the Project Engineer, shall be required to be post mounted to improve visibility, and to keep useable shoulders clear.

Signing for nighttime traffic is more difficult than that required for daylight hours. A review of the project signing should be made and recorded during the hours of darkness.

Signs and other traffic control devices should be shown on the traffic control plan (either State-provided or contractor-submitted), approved and in use, and should be installed with adjustments for work zone and traffic conditions. The Contractor and WSDOT should ensure proper use and placement of signs and devices. For situations not addressed by the TCPs, the Project Engineer will determine who is responsible for preparing a revised TCP. Refer to the *Work Zone Traffic Control Guidelines* Book, MUTCD, or seek assistance from the Region Traffic Engineer for appropriate TCP revisions. A modified or new TCP may be needed if adjustments to signs and devices do not adequately address existing hazards or resolve observed traffic problems or accidents.

Judgment will be required when a traffic control plan is changed. The project engineer must determine if the change has arisen because of a flaw in the original plans or because of the contractor's activities or preferences. In the first case, a change order, perhaps with compensation, may well be needed.

The remaining devices listed in the provisions are the following:

- Sequential Arrow Signs
- Portable Changeable Message Sign
- Barricades
- Traffic Safety Drums
- Traffic Cones
- Tubular Markers
- Warning Lights and Flashers
- Truck-Mounted Attenuator
- Tall Channelization Devices
- Portable Temporary Traffic Control Signal

The specifications for these devices should be sufficient to explain their use and requirements.

#### **SS 1-10.4 Measurement**

Measurement is the key element of the new provisions, which now contain lump sum bid items. The provisions will define one of several pay item strategies, which will determine the measurements to be made.

First, the “normal” project with these provisions will contain items. The items are different from previous contracts and are non-standard, although several have very similar item names. Each of these is described below.

Instead of items, the project may be designated as a “Total Project Lump Sum.” This will be the case if the item “Project Temporary Traffic Control, Lump Sum” is included in the proposal. If this is the strategy of the project, then all measurement and payment provisions for all other pay items are deleted from the contract. When this occurs, then all temporary traffic control costs of whatever nature (everything defined in [Section 1-10](#)) are included in the lump sum.

The project may be a lump sum hybrid. In this case, the Total Project Lump Sum item will be present, but the provisions will reinstate one or more of the deleted standard items. If that happens, the measurement and payment of the reinstated item(s) will be separate from and not included in the lump sum.

These are the items and a discussion of the features of the measurement spec for each:

- **Traffic Control Supervisor (Lump Sum)** – Previously paid by the hour, this item is now a fixed cost. Overtime is not considered, a second TCS for a night shift makes no difference. This lump sum status will likely cause TCS to become a part of change order negotiations. If the change does, in fact, require additional TCS work, then there would be entitlement. This will also apply to extended contract duration, as the TCS can be considered part of on-site over-head.
- **Flaggers (Per Hour)** – This contract activity is separated from other kinds of traffic control labor. It is measured according to the hours that an approved flagging station is manned. We will not count minutes and seconds; time will be rounded up to the half hour as specified in *Standard Specifications* Section 1-09.1. If a station is manned, but full-time presence of the flagger is not necessary (trucks entering roadway, equipment crossing) then the flagger is expected to step back out of harm's way until the next event. No deduction will be made for this stepping back, provided the flagger cannot be assigned to other duties while waiting. In measuring flagging, disregard overtime, split shifts, union rules for show-up time, the trade classification of the flagger and any other payroll issues. The flagging is a service that is provided and paid by the hour. It is only peripherally related to the flagger's paycheck.
- **Other Traffic Control Labor (Per Hour)** – There are other duties for traffic control labor besides flagging. Some of them are included in this item for separate measurement. If one of the activities listed in the provision is provided, then measurement of that activity is appropriate. Only the hours that the activity is performed will be measured. Again, this is not a payroll measurement.

Note the limit under patrolling and maintaining. No matter how many people are involved in this activity, measure only one hour for each hour that each approved route is operated.

Another little feature shows up under the last bullet (Installing and removing devices). Time spent ahead of the setup marking layout points on the shoulder or getting signs ready in the yard will be measured under this item.

Do not succumb to pressures to add other hours to this item. As the payment spec for "Other Temporary Traffic Control" states, all costs not compensated by other items are covered there.

Construction Signs, Class A (per sq ft) to qualify for payment under this item, the sign must be designated as Class A on an accepted TCP or be directed installed by the Engineer and designated as Class A at the time of direction. After-the-fact re-designations of signs that have been originally thought to be Class B should not be considered.

- **Other Unit Price Items** – The traffic control provisions limit unit items to major devices. These include Sequential Arrows, Changeable Message Signs, Portable Signal and Transportable Attenuators. The measurement and payment requirements for these are similar or identical to those which have been in use for some time and are relatively straightforward.

One point to make is with the force account item for Repair Transportable Attenuator. Because this is a temporary installation and not a part of the permanent work, the Third Party Damage item does not apply and that is why a separate force account is established. If the damage was caused by a third party, the department may well be able to recover the costs paid to the Contractor under this item. The Project Engineer should take steps to protect the department's interest and involve the Maintenance, the Accounting and Financial Services Division, and Risk Management offices to initiate the efforts to recover costs.

### **SS 1-10.5 Payment**

The payment provisions of the new specifications are intended to provide a mechanism that accounts for all of the Contractor's costs for temporary traffic control. The total project lump sum item is self-explanatory. There is no additional payment unless there is a change order.

If the job contains items, the pay definition for each describes the limited portion of the Contractor's costs that are covered by each item. The summary lump sum item (Other Temporary Traffic Control) is written to be a catchall cleanup that lets nothing escape for "additional compensation" discussions.

Watch out for change orders. A principal concern over lump sum items is that work will be added that is not required by the original contract and no mechanism exists to increase traffic control payment. This can be straightforward in identified changes, merely becoming an additional aspect of the negotiation. More troubling are constructive changes, which are not written, but which do end up in negotiation. An "overrun" of asphalt pavement to add a few driveways may be a convenient way to do field decisions, but may also create a dispute over the related traffic control costs (not to mention the dispute about the changed nature of the paving).

## 2-01 Clearing, Grubbing, and Roadside Cleanup

### SS 2-01.3 Construction Requirements

#### SS 2-01.3(1) Clearing

Before starting grading operations, it is necessary to prepare the work area by removing all trees, brush, buildings, and other objectionable material and obstructions that may interfere with the construction of the roadway. From the standpoint of roadside appearance and control of erosion on the right of way, it is advantageous to preserve natural growth where possible. When shown in the Plans, the first order of work will be the installation of high visibility fencing (HVF) to delineate all areas for protection or restoration. The Project Engineer should double check the placement of the HVF and ensure it matches the locations indicated on the Joint Aquatic Resource Permit Application. In addition, the Project Engineer should discuss with the Landscape Architect the preservation of natural growth which will not interfere with roadway and drainage construction before starting clearing operations. If vegetation outside the clearing limits is damaged during the clearing or grubbing operations, or if pruning is required, the Landscape Architect or State Horticulturist may be contacted for assistance. Areas to be omitted from clearing or extra areas to be cleared should be determined before starting work and an accurate record made during staking operations.

#### Staking

Clearing stakes at least 4 feet long and marked "Clearing" should be set at the proper offset marking the limits of the area to be cleared. These stakes should be set at 100 foot intervals on tangents and at shorter intervals on curves, depending on the sharpness of the curve. Where slope treatment is provided, clearing should be staked to a distance of 10 feet beyond the limits of the slope treatment with a distance of 5 feet being considered the absolute minimum distance required. Grading stakes should not be set until clearing and grubbing work in a given area is completed. The method of measurement used at interchange areas should be such as to preclude the possibility of duplication or overlapping of measured areas.

#### SS 2-01.3(2) Grubbing

Grubbing provides for additional preparation of the work area by removal of remaining stumps, roots, and other obstructions which exist on or in the ground in all areas designated for grubbing. It should be noted that complete grubbing is not required under embankments where the fill height above natural ground, as measured to subgrade or embankment slope elevation, exceeds 5 feet. This exception does not apply to any area where a structure must be built, subdrainage trenches are to be excavated, unsuitable material is to be removed, or where hillsides or existing embankments are to be terraced. Grubbing is important to the structural quality of the roadway and every effort should be made to obtain a thorough job. Grubbing should be completed at least 1,000 feet in advance of grading operations.

The Contractor may accomplish clearing and grubbing in one operation. Complete grubbing under fill heights in excess of 5 feet is not required unless the Contract Provisions specifically modify *Standard Specification* Section 2-01.3(2).

## Staking

Grubbing stakes must be set at the limits of the slopes as specified. Where slope treatment is required, grubbing must be extended to the limits of the slope treatment. Accurate records of grubbed areas need to be kept in the form of sketches and measurements.

### SS 2-01.3(4) Roadside Cleanup

This work consists of cleaning up, dressing, and shaping the roadside area outside the limits of construction. In advance of completion of other work on the project, the Project Engineer and the Contractor need to determine the work to be done, the equipment and labor necessary, and estimate of the cost of the work. Do not use this item for any work to be paid under "Trimming and Cleanup," or any other item.

Any trees or snags outside the limits of areas to be cleared which may endanger traffic on the roadway itself should be removed under this work. Before removing danger trees outside of the right of way, the matter should be referred to the Regional Office for negotiations with the property owners. If, however, an emergency arises, which endangers traffic, the danger trees may be removed immediately and the Project Engineer should notify the Region as soon as possible.

The work required in shaping the ends of cuts and fills so they appear natural with the adjacent terrain will be greatly reduced if proper warping of the cut and fill slopes has been accomplished during the grading operations.

### SS 2-01.4 Measurement

When the Contract provides for measuring clearing and grubbing by the acre, it is the intent of the Specifications to measure all areas actually cleared and grubbed. Minor uncleared areas within the clearing limits may be included in the quantity if they are less than 50 feet long, measured parallel to the centerline and contain an area less than 2,500 square feet.

Small, isolated areas to be cleared, located between areas excluded from measurement and which contain less than 2,500 square feet, shall be measured as containing 2,500 square feet. Where isolated areas occur intermittently, the sum of the areas allowed by this method of measurement shall not exceed the total area (containing the several isolated areas) when measured as continuous clearing. This condition can occur when clearing narrow strips less than 25 feet in width.

## 2-02 Removal of Structures and Obstructions

### GEN 2-02.3 General Instructions

When water wells, resource protection wells, or septic tanks are encountered, the Project Office needs to ensure they are meeting all the requirements in [WAC 173-160](#) Minimum Standards for Construction and Maintenance of Wells, [WAC 246-227A](#) On-site Sewage Systems, and all environmental considerations for leaving in place, decommissioning, or abandonment. Contacting the Regional Environmental Office for guidance is suggested.

Resource protection wells include piezometers, slope inclinometers, and other instruments installed in boreholes. Resource protection wells and water wells must not be disturbed during construction. Before they can be disturbed, they must

be decommissioned by a Driller licensed in Washington State and reported to the Department of Ecology. Only decommissioned water wells and decommissioned resource protection wells can be destroyed or buried during construction. If well construction records are not available, the well may need to be removed by drilling to remove the well in its entirety as part of the decommissioning process. All wells having artesian characteristics will require special consideration. The Geotechnical Office can assist with well decommissioning.

If the Contractor or agents acting for the Contractor decommission wells on WSDOT property, it is imperative that the Project Engineer obtain copies of all paperwork for the well decommissioning and that the Project Engineer forward copies to the Field Exploration Manager within WSDOT's Geotechnical Office.

If a Contractor destroys, damages, buries, paves over, or obscures a well which has not been properly decommissioned, the Project Engineer must report the incident to the Department of Ecology, the Assistant State Construction Engineer, and the Field Exploration Manager of the Geotechnical Office.

### **SS 2-02.3 Construction Requirements**

Buildings, foundations, structures, fences, and other obstructions which are on the right of way and are not designated to remain, shall be removed and disposed of in accordance with the *Standard Specifications*. All salvageable materials designated to remain the property of the WSDOT shall be removed carefully and stored in accordance with the Special Provisions. Foundations shall be removed to the designated depth and basement floors shall be broken to provide drainage of water. Basements or cavities left by their removal shall be backfilled as specified, and if the areas are within the roadway prism, care shall be taken to see that the backfill is properly compacted.

Care shall be taken to see that pavements or other objects which are to remain are not damaged during this operation.

## **2-03 Roadway Excavation and Embankment**

### **GEN 2-03.1(1)**

#### **GEN 2-03.1(1)A General Instructions**

Present day earth-moving equipment and practices have accelerated grading operations to the point where the Project Engineer must make every effort to plan ahead and foresee conditions which may require changes in plans, special construction procedures, or specific coordination with Subcontractors or other Contractors. Delays in work progress are costly both to the Department and to the Contractor, and must be avoided whenever possible.

The Project Engineer needs to become familiar with the subsurface soil, rock, and groundwater conditions in the Contract and the available reference information. The Project Engineer should compare the Contract subsurface information with the actual conditions in the field. This will allow for adjustments in the Work, such as changes in haul to make best usage of better materials, changes in surfacing depth, variations in drainage, or a determination of same or changed conditions from what was expected.

The Project Office should examine each newly exposed cut as soon as possible after it is opened in order that necessary changes may be made before excavating equipment has been moved away. This will necessitate an inspection of the cut slopes and the ditch cuts to locate any objectionable materials or faulty drainage conditions which should be corrected. Objectionable materials are those having characteristics which may cause an unstable subgrade or lead to instability in the cut. Among the conditions the Project Engineer must watch for are soil moisture contents which are so high as to render the subgrade unstable under the designed surfacing, high water tables and seeps, and soils where frost heaving may be serious, such as silts and very fine sands having high capillary attraction, and unstable rock structure. In the event such conditions are discovered, the Project Engineer needs to contact the Regional Materials Engineer for assistance in determining corrective action to ensure a stable subgrade and cut slope is achieved.

*Standard Specifications* Section 2-03.3(10) provides for selecting excavation material for special uses as directed by the Project Engineer. Judicious application of this provision should be made whenever the project will be benefited.

### **SS 2-03.1 Description**

Roadway excavation is specified in accordance with *Standard Specifications* Section 2-03.1 and shall include all materials within the roadway prism, side borrow areas, and side ditches. Borrow, unsuitable excavation, ditches and channels outside the roadway section, and structure excavation are separately designated. Area designations shall not be construed to imply classification based on the type of material involved.

#### **GEN 2-03.1(1)B Staking**

See [Section 1-05](#) for listed tolerances and the *Highway Surveying Manual* M 22-97.

#### **GEN 2-03.1(1)C Contaminated Media**

Discovery of contaminated media (i.e., soil and water) is usually identified during pre-construction investigations and Special Provisions are subsequently developed for its handling and disposal. Occasionally, contamination is discovered where it was not expected during excavation and/or dewatering activities. Indicators of contamination often include soil staining, oily sheens in water, and chemical, fuel, foul, or sweet odors.

When physical evidence indicates discovery of contamination, a series of response activities must begin to ensure that appropriate actions are initiated to minimize project delays, additional project costs, and WSDOT liability. Upon proper notification, WSDOT can direct characterization, removal, and disposal of the contaminated media through one of its On-Call Environmental Consultants or, if preferred, through the Contractor if they have the necessary equipment and certifications. Regardless of who performs the work, the WSDOT Hazardous Materials Program should be notified in order to provide guidance for proper management of the contaminated media.

Discovery of unanticipated contaminated media will be considered a change as outlined in *Standard Specifications* Section 1-04.4 and work associated with removal and disposal of discovered contaminated media will be compensable.



**GEN 2-03.1(1)D Temporary Water Pollution/Erosion Control**

Temporary Erosion and Sediment Control (TESC) and Spill Prevention Control and Countermeasures (SPCC) plans must be developed and implemented for all projects. Requirements for managing erosion and water pollution on the project are covered in [Chapter 8](#) of this manual and in *Standard Specification* Sections 1-07.15, 8-01, and 9-14.

**SS 2-03.3 Construction Requirements****SS 2-03.3(1) Widening Of Cuts**

Normally, excavation will be made to the neat lines of the roadway section as indicated on the plans. When material shortages occur, additional quantities may be obtained either from borrow sources or from an enlargement of the Contract cuts as designated by the Project Engineer. Early determination of additional needs is desirable so that necessary enlargement can be made during the original excavation. The Project Engineer should ensure that enlargement of cuts is not in opposition to environmental commitments, does not impact protected areas, does not extend outside right of way, and remains in compliance with Contract Permits. Should it be necessary to return to a completed cut for additional material, effort should be made to cause no change in the Contractor's normal method of excavation. If the original excavation was dressed to proper slopes, it will be necessary to pay for sloping the second time in accordance with [Standard Specifications](#) Section 2-03.3(1).

**SS 2-03.3(2) Rock Cuts**

Most projects involving rock cuts will provide for controlled blasting of the faces of the rock slopes to minimize blast damage of the face and overbreak. The Project Engineer may require controlled blasting for other slopes, even if the Contract does not require it. Usually this determination is made at the design stage, but formations may be encountered during the construction which were not anticipated during the design. The Project Engineer should advise the Geotechnical Office when rock excavation is in progress so that the Geotechnical Office may monitor the progress of the Work and check to see that the slopes are suitable for the rock as revealed. The Project Engineer should also contact the Regional Operations/Construction Engineer and Materials Engineer when it appears desirable to change the method proposed for any operational reason.

It is the responsibility of the Contractor to determine the method of controlled blasting to use. The Contractor is required to drill and shoot short test sections to see that the method used is producing a satisfactory face and to develop the best methods for the particular rock formation encountered. The Project Engineer should review the results being obtained in the test section in coordination with the Geotechnical Office to see that they are satisfactory, and if they are not, discuss with the Contractor necessary changes in procedures to produce satisfactory results. Coordination, collaboration, and agreement between the Project Engineer, Geotechnical Office, and the Contractor is essential prior to proceeding with production blasting.

Most rock faces will be formed by the preshear method consisting of drilling and blasting a line of holes on the face of the cut ahead of any other blasting. The cushion blasting method consists of blasting and removing the main part of the cut prior to blasting the line of holes on the face of the cut. It is important that the blasting for the main part of the rock does not shatter the rock behind the face of the cut. With either method, proper hole alignment is very important. Rock cuts are often made using a series of cuts or lifts. The lift height or depth of rock excavation is often dependent upon the depth that the holes can be drilled while maintaining proper hole alignment. For each lift, a setback of about 1 foot minimum is required since it is often impossible to position the drill flush to the rock face of the previous lift.

The results obtained are dependent not only on the properties of the rock but upon the hole size, spacing, amount and type of explosive, spacing of the explosive in the hole, stemming and the timing of the blast. It is desirable that the Project Engineer keep a record of these procedures used by the Contractor, especially in the early phases of the work while the best methods are being sought.

After excavating the rock cuts, the slopes shall be scaled and dressed to a safe, stable condition by removing all loose spalls and rocks not firmly keyed to the rock slope. Mechanical scaling using dozers, front end loader, etc., as the face is developed, is desirable. Any rock exposures which are felt to be a potential hazard to project personnel should be called to the attention of the Contractor. Loose spalls and rocks lying outside the slope stakes which constitute a hazard to the roadway shall be removed and payment made for their removal in accordance with *Standard Specifications* Section 2-03.3(2). Controlled blasting of rock faces may be measured by running a true profile over the top of the rock at each drill hole and quantities computed using cutoff elevations established for the bottom of the drill hole.

### **SS 2-03.3(3) Excavation Below Subgrade**

Where excavation is in solid rock, the excavation shall be completed full width of the roadway to a depth of 0.5 feet below subgrade. Particular attention is directed to the Provisions of the Specifications regarding drainage of pockets below subgrade in solid rock cuts. Pockets formed by blasting operations must be drained by ditching to the side ditches, and then backfilled with fragmentary rock, gravel, or other suitable material. Silty or clayey soils should not be used.

Should soft areas exist in the subgrade of a completed earth cut, excavation below grade and replacement shall be accomplished in accordance with *Standard Specifications* Section 2-03.3(3). Particular attention should be given to areas of transition between cut and fill. Top soil and other organic or unsuitable material should be removed from these areas and replaced with material suitable for subgrade in accordance with *Standard Specifications* Section 2-03.3(14).

The subgrade of cut sections must be checked for density as it is required and necessary that the entire roadway subgrade meet the compaction requirements specified for the project and set forth in *Standard Specifications* Section 2-03.3(14)C, Method B. Density tests shall be taken for each 500 feet or fraction for each roadway. If the density of the subgrade is less than the required density, the subgrade material shall be improved in accordance with *Standard Specifications* Section 2-03.3(3).

### SS 2-03.3(5) Slope Treatment

Earth cuts, soft or decomposed rock cuts, and overburden in all rock cuts shall have the tops of the slope rounded in accordance with Standard Plans for Slope Treatment to produce an aesthetic and pleasing appearance. The slope treatment shall be constructed at the time of excavation so the material resulting from the rounding of the slopes may be used elsewhere on the job or disposed of along with the excavation from the cut.

The Project Engineer should go over the slope treatment procedure with the Contractor at the beginning of the excavation operation to ascertain that proper rounding is being constructed and reduce extensive reworking.

### SS 2-03.3(7) Disposal Of Surplus Material

When there is a surplus of material which cannot be handled by changing grade or alignment, it shall be disposed of in accordance with *Standard Specifications* Section 2-03.3(7). If the surplus is wasted by widening the embankments, care must be taken to avoid creating a condition conducive to embankment erosion. If possible, the widening should be made in conjunction with the original embankment and placed in accordance with Method B embankment compaction specifications unless the Special Provisions require another method. If this is not possible, it is preferable to waste along low embankments where Method A compaction can be accomplished. Dumping of loose material on high embankment slopes must be avoided.

When the Geotechnical report indicates settlement is anticipated in embankments at bridge ends, surplus material shall not be wasted by widening embankments or by building up the adjacent ground line near the structure. Wasting material in this manner adjacent to a structure can result in increased, unanticipated, and adverse settlement of the embankment or structure even if the structure is founded on deep foundations.

In areas where a preload or surcharge is required, any required contour grading must be done at the time the preload or surcharge is constructed. When the preload or surcharge is removed, the material must be removed entirely from the area and not placed on slopes or wasted in the adjacent area.

Wasting excavation material and borrowing may be necessary, however, such operations must be kept to an absolute minimum. Carelessness in this respect is expensive and leads to an unsightly job. Careful planning of work and proper selection and mixing of available materials often will eliminate the need to waste and borrow.

### SS 2-03.3(11) Slides

The Project Engineer's attention is directed to *Standard Specifications* Section 2-03.3(11), providing for the removal of slides in cut slopes and in embankment slopes. The Project Engineer is cautioned that before allowing the Contractor to perform this work the Geotechnical Office should be contacted to evaluate the potential cause of the slide and if removal and repair in accordance with Section 2-03.3(11) is in the Agency's best interest. Large slides may require additional stabilization or design changes to ensure long term performance. Generally, slides and slumps involving less than 20 yards of material can be repaired with minimal risk and little geotechnical consultation.

Any slides coming into the roadway after the slopes have been finished by the Contractor shall be removed by the Contractor at the unit contract price per cubic yard for the excavation involved. If the Project Engineer orders the slope to be refinished, payment for refinishing would be eligible for an equitable adjustment as defined in [Standard Specifications](#) Section 1-09.4.

In case of slides in embankment slopes, the Contractor shall replace the embankment material from sources designated by the Project Engineer at the unit Contract prices.

In the event the slide repair is such that quantities cannot be measured accurately, or if the Contractor must use a different type of equipment for removal than that available on the project, payment may be made as provided in [Standard Specifications](#) Section 1-09.4.

The Project Engineer's attention is directed to [Standard Specifications](#) Section 1-07.14, providing for the Contractor's responsibility for sloughing and erosion of cut and embankment slopes. The ordinary sloughing and erosion of cut and embankment slopes shall not be considered as slides, and the Contractor is responsible for providing temporary control facilities to prevent this.

The following guidelines are provided to assist in determining responsibility for repairs to eroded areas:

- a. **Slides** – Slide repair costs will be borne by WSDOT, where there is no evidence of neglect by the Contractor.
- b. **Erosion of Slopes**
  - i. In places where water has run over the edge of the roadway and where the Contractor has neglected to provide adequate protection, the Contractor must assume the costs of repair.
  - ii. Where rain on cut and embankment slopes cause rills and wash, the Contractor must assume the cost of repairs except as noted hereinafter.
  - iii. Where erosion of cut or embankment slopes occur from ground water seepage, WSDOT will assume the cost of repairs except when identified in the Plans and Provisions. The Geotechnical Office often recommends including a detail in the Plans when this has a high risk of occurring. If the Contract contains a repair detail, this is Work that should be included as part of the Contract and paid for under Contract items.
- c. **Repairs**
  - i. In b.ii., the Contractor must, at no expense to WSDOT, remove eroded material from the toe of slope, ditches, and culverts and restore the eroded areas with this material where practicable. If additional top and/or embankment material is needed or different materials are ordered by the Project Engineer, it will be furnished and placed by the Contractor at unit Contract prices.
  - ii. In b.i. and b.ii. where erosion has occurred and repairs are the Contractor's responsibility, the Contractor must restore the area at no expense to WSDOT, including the seeding, mulching and fertilizing.
  - iii. In a. and b.iii. where seeding, mulching, and fertilizing have been damaged, payment will be made for restoring same at the unit Contract price for seeding, mulching and fertilizing.

### SS 2-03.3(12) Overbreak

Overbreak should not be paid for in any manner except when the planned roadway excavation is not sufficient to complete the embankment and borrow excavation has not been included in the Proposal. With the approval of the Project Engineer, overbreak material may be used to complete the embankment and payment made at the unit Contract prices for Roadway Excavation and Haul.

When approved by the Project Engineer, available overbreak material may be used in accordance with *Standard Specifications* Section 2-03.3(12).

In the event that conditions causing the overbreak justify reestablishing the slopes to include part or all of the overbreak section, the material reverts to roadway excavation material and shall be so paid for. Justifiable reason for reestablishing the slopes may be uncontrollable overbreak resulting from the existence of natural cleavage or faults in rock formations, planned slopes resulting in an unsafe and unstable condition, or other such reason. Overbreak may be expected on unstable slope projects involving rock cuts if the reason for the project is the rock cut is unstable. When a question occurs as to justification for reestablishing slopes because of overbreak, the Project Engineer must consult with the Regional Construction Engineer.

When overbreak is surplus material and reestablishment of slopes is not justified, the materials shall be removed and wasted as provided for "Surplus Materials" under *Standard Specifications* Section 2-03.3(7) except that the work shall be at the Contractor's expense, including the cost of hauling and wasting.

Where pay quantities of material are wasted and overbreak is used in lieu thereof, no allowance will be made for such overbreak. Haul in this case will be paid upon the basis of the pay quantities of excavation.

### SS 2-03.3(13) Borrow

Borrow must be satisfactory for the use it is intended. Depending on the Borrow use and type, sampling and testing may be required to verify the quality and the quantity of suitable material available before use. Specific material requirements and acceptance criteria are detailed in Section 9-03.14 of the *Standard Specifications*.

The Contract may designate a material source for borrow, but more recent practice is to not include a material source in the Contract documents and have the Contractor provide a material source. For Contractor supplied sources, the Project Engineer should contact the Regional Materials Engineer early to see if the proposed source has a history of material acceptance issues. This detail could save considerable time, expense, and future problems if it is determined that a pit is unsatisfactory before extensive work is performed in opening the pit and then discovering that the material is not acceptable.

*Standard Specifications* Section 9-03.14 provides for the use of borrow. There are four types of borrow; gravel, select, common, and borrow for use specifically in structural and earth walls.

Gravel borrow is intended for use where embankments need strength and compaction to perform well. With a lower fines content than other borrows, gravel borrow is also considered to be more workable in wet weather, but in dry summer months, it may require more watering to maintain moisture for optimum compaction. In recent years, natural deposits meeting gravel borrow requirements are becoming fewer. Gravel borrow is often a processed material requiring screening or crushing to meet gradation requirements.

The gradation for select borrow is more open than that of gravel borrow. Accordingly, there tends to be more naturally occurring materials available. Select borrow has more fines than gravel borrow and is often considered to be a slightly weaker material and more difficult to work and compact in wet weather. However, select borrow is still a preferred material for embankment construction.

Of the three borrows used for embankment construction, common borrow, has the fewest restrictions for material acceptance, meaning most materials in Washington State meet the material requirements for common borrow. However, plasticity and fines content are major concerns when using common borrow. Common borrow embankments with plasticity have historically resulted in higher maintenance costs, instability, and poor performance. Accordingly, plastic materials should be used with caution. The Specification allows for the use of more plastic (clayey) common borrow when approved by the Project Engineer. The use of more plastic (clayey) material may require approval of the Regional Materials Engineer or the State Materials Lab. The 3 percent maximum organic material requirement for common borrow may be determined visually, or, as necessary, by one of the following test methods: AASHTO T 194 (Determination of Organic Matter in Soils by Wet Combustion) or AASHTO T 267 (Determination of Organic Content by Loss on Ignition). The correct test method is determined based on the type of organic material present in the soil sample. The Regional Materials Engineer should be consulted as to the appropriate test method. The sample may be field determined to be nonplastic if the fraction of the material which passes the U.S. No. 40 sieve cannot be rolled into a thread at any moisture content using that portion of AASHTO Test Method T 90 (Determining the Plastic Limit and Plasticity Index of Soils) which describes rolling the thread.

Gravel borrow for structural earth walls, is essentially the same as gravel borrow with a few notable exceptions. The coarse materials are limited in size to minimize installation damage to geosynthetic materials during placement and compaction, and the material has addition requirements to prevent corrosion and degradation of wall reinforcing.

The requirements of [Standard Specifications](#) Section 2-03.3(13) must be observed in the operation and cleanup of borrow pits. With the requirement for reclamation of all pits, a plan must be developed to meet the requirements of the Specifications and Special Provisions and approved before the start of pit operations. See [Standard Specifications Section 3-03](#) for additional requirements.

### **SS 2-03.3(14) Embankment Construction**

It is expected that the Contractor will construct roadway embankments in accordance with the Plans and Specifications using construction methods and equipment considered suitable for the type of work involved. All operations must be directed toward constructing a uniform, well-compacted embankment true to grade and cross-section.

It is sometimes necessary to construct an embankment across wet and soft grounds which will not support the weight of heavy construction equipment. It is the responsibility of the Contractor to select a method of construction and type of equipment which will least disturb the soft foundation. The Project Engineer may have to use judgement and experience to decide if the Contractor's methods will impair or make an embankment unstable. If the natural ground or base is considered unstable by the Project Engineer, it will not be possible to construct a uniform well compacted embankment and the unstable base materials will need to be removed or stabilized in accordance with [Standard Specifications](#) Section 2-03.3(14)E.

It is permissible to start the embankment by dumping and spreading the first layer to a thickness capable of supporting construction equipment across the soft ground, however, this initial lift should be held to the minimum thickness required for equipment selected in conformance with the above. The remainder of the embankment shall be constructed in layers and compacted as specified. Compaction will be required on initial embankment lifts wherever conditions will permit placement and compaction as specified.

Where embankments are built on hillsides or existing embankment slopes, the existing surface soil may form a plane of weakness, unless the slope is terraced or stepped by plowing deeply to key the new embankment to the slope. Hillside Terraces are a standard requirement for embankment construction as specified in [Standard Specifications Section 2-03.3\(14\)](#).

Settlement indicating devices are occasionally called for on the Contract Plans and Special Provisions when it becomes necessary to determine the extent and rate of embankment settlement. Settlement data is necessary for establishing construction schedules for adjoining or adjacent structures where the downward movement of the embankment and its foundation will influence the stability of the structure.

There are several types of settlement indicating devices in current use. The principals of each type and the instructions for installation and monitoring must be understood by all involved project personnel. The Regional Materials Engineer or the Geotechnical Office should be consulted in these cases.

#### **SS 2-03.3(14)A Rock Embankment Construction**

As established compaction tests cannot be applied to coarse granular material with any degree of accuracy, embankment construction has been divided into two classes: rock embankments and earth embankments, as defined in [Standard Specifications Section 2-03.3\(14\)](#). It should be noted that this designation is made for the fundamental purpose of determining the method of embankment construction and compaction control to be used, and that it depends only upon the gradation of the excavation material. It is not necessary that an embankment be built entirely of rock material to be designated as rock embankment. Rock embankment is defined as “all, or any part, of an embankment in which the material contains 25 percent or more by volume of gravel or stone 4 in or greater in diameter.” The Inspector must make visual inspection of the embankment material to ascertain whether it contains 25 percent or more of material 4 inches or greater in diameter. For rock embankment, in lieu of controlling compaction by performing tests, a given amount of compactive effort is specified in [Standard Specifications Section 2-03.3\(14\)A](#). Where the stability of a rock embankment is in question, moisture and density control as specified in [Standard Specifications Section 2-03.3\(14\)B and C](#) shall pertain. It is considered that uniform compaction to the full width of the embankment normally will not be achieved by routing hauling equipment over the roadway. Rolling equipment shall be required as specified whenever it is possible to operate such equipment on the material being placed. The decision to require or delete the use of rollers as specified shall be based on feasibility of operation rather than on an arbitrary estimate of benefits achieved, as this factor is very difficult to evaluate without conducting extensive and expensive tests.

**SS 2-03.3(14)B Earth Embankment Construction**

Procedures for constructing earth embankments are described in *Standard Specifications* Section 2-03.3(14)B. Compaction in accordance with one of three methods designated as Method A, Method B, or Method C as specified in *Standard Specifications* Section 2-03.3(14)C shall be utilized. Unless otherwise specified in the Special Provisions, Method B will apply. The basic requirements of all three methods are the same in that each requires lift construction, uniform compaction throughout the embankment width and depth, control of moisture content to not more than 3 percent above optimum, and the addition of moisture should it be necessary for proper compaction. The difference between the three methods lies in the thickness of lifts specified, the degree and control of compaction required, and the degree of control of moisture below optimum. The use of suitable compaction units is required for Method B and Method C, although routing of hauling units may be used to obtain partial compaction.

Method A normally will not be specified for state highway work, but may be applied on county or city projects or on certain secondary state highway projects. Embankment lifts up to 2 feet in thickness may be placed, and compaction is achieved by routing the hauling equipment over the entire width of the embankment. Inspection should determine that the routing schedule is such that all parts of the fill receive the same amount of compaction, including the outer edges of the fill. Drying of soil or addition of moisture may be required, if necessary.

Method B will be used on all state highway projects except where other methods are specified. This method requires that the embankment be constructed in lifts not exceeding 8 inches in loose thickness except that lifts in the upper 2 feet shall not exceed 4 inches in loose thickness. 90 percent of maximum density is required throughout the embankment except that 95 percent of maximum density is required in the upper 2 feet. Control density tests must be performed to verify compliance with Specifications. The Contractor shall be required to dry soil or add moisture as necessary to ensure proper, uniform compaction. The selection of compaction equipment or methods is the responsibility of the Contractor; however, the use of any method or equipment that does not achieve the required density within a reasonable time may be ordered discontinued. The entire embankment, including the side slopes, shall be compacted to specification requirements.

Method C will be required when it is considered essential to the structural quality of the embankment that the entire fill be compacted to a high density. This method differs from Method B in that the entire embankment must be compacted to 95 percent of maximum density. Also, a limit is specified for minimum moisture content in addition to the maximum to ensure moisture content uniformity. In all other respects, the two methods are the same, and each requires a high standard of compaction control.

**SS 2-03.3(14)C Compacting Earth Embankments**

Proper compaction of roadway embankments and embankment slopes is of vital importance to the structural quality of the final roadway and strict adherence to specification requirements is essential. The type and thickness of the final surfacing and pavement is designed on the basis of the strength of the underlying materials, and the strength of these materials is affected greatly by their state of compaction, therefore, it is essential that the specified density be obtained. To enable the Project Engineer to



determine that embankments are being compacted properly, control test procedures and density standards have been developed for use during construction. It is expected that these aids will be utilized to the fullest extent necessary to determine that all embankments are constructed in accordance with specifications. Complete instructions for making maximum density and optimum moisture content determinations for soils and for making field density control tests are furnished with the appropriate testing equipment and in [Chapter 9](#).

The Project Engineer and the Inspector should understand thoroughly the elements of the compaction process and compaction control procedures. The following brief resume should be supplemented by study of appropriate publications on this subject and by consultation with the Regional Materials Engineer. In general, it can be stated that each soil has a maximum density to which it can be compacted with a given compactive effort. For this compactive effort, the maximum density will be obtained only at one moisture content. Increases or decreases in moisture cause a reduction in the density obtainable with the given compactive effort. When the moisture content is lower than optimum, additional compactive effort is necessary to achieve the specified density. When the moisture content is above optimum, low densities will result, and a soft, spongy condition may develop during the compaction process. In most cases, the moisture content of the material should be less than optimum when the material is covered, due to the fact that frequently materials are over-compacted by the heavy construction equipment now in use. Once the material is covered with another layer of material, it is very unlikely that the moisture content of the material will decrease.

Certain soils, primarily fine grained soils having high silt content, may become unstable by virtue of being over compacted even at moisture contents at or slightly above optimum but within specification limits. When working with these soils, the moisture content should be reduced below the maximum allowed if at all feasible, this may require aeration. Specifications provide for payment for this work. Also the Contractor should be requested to compact only to the minimum requirements; however, this is difficult to control. With modern heavy hauling and compacting units, over-compaction occurs with increasing frequency. When high fills are involved, not only may the subgrade be unstable, but the overall stability of the fill may be reduced to the point that slump failure will occur. When such soil and moisture conditions are encountered, the Project Engineer should recognize the potential danger and notify the Regional Operations/Construction Engineer. Should corrective measures be necessary, one or more of several procedures may be used. When low fills are involved, increasing the surfacing depth, mixing with granular materials available, or allowing the fill to set undisturbed for a period of time may prove satisfactory. When a high fill is to be built, sandwiching layers of free-draining material, incorporating a system of trench drains, or mixing with other materials may prove satisfactory. In all cases, the correction must be aimed at neutralizing the excess pore-water pressure or changing the character of the material. [Standard Specifications](#) Section 2-03.3(14)J provides for the use of gravel borrow material for this type of work.

The gravel borrow may be mixed with the embankment material by placing a layer of the embankment material on a layer of gravel borrow and mixing the two materials using aeration equipment. The materials shall be mixed and the moisture content reduced to a satisfactory level. During drying weather, the gravel borrow material will tend to speed the reduction in moisture of the embankment material. After the moisture has been reduced to a satisfactory level, the layer of material must be compacted to the required

density before another layer of material is placed. It is quite important that the moisture be reduced to a satisfactory level or the advantage of mixing with the gravel borrow will be lost.

An alternate method is to intersperse layers of gravel borrow throughout the embankment to reduce the pumping action of the soil and provide drainage for excess moisture. This method is preferred over mixing. The embankment material must be uniformly graded and sloped to the outside of the embankment so any excess moisture will have a chance to drain off. Care must be taken in placing the layer of gravel borrow so ruts or pockets are not formed in the embankment material which will trap moisture and prevent its draining off. The depth of the layers of embankment materials that will maintain the desired embankment stability shall be determined by field tests.

Drainage problems occur quite frequently when an existing embankment is widened, if there is moisture present in the existing embankment, through capillary action, subterranean drainage, or otherwise. If the new embankment traps the water in the existing embankment, usually the moisture saturates the embankment to a point that slump failure occurs. Whenever an existing embankment that could receive moisture is to be widened, drainage must be provided through the new embankment area. If the new embankment material is not free draining, one method of providing drainage is to layer the new embankment with gravel borrow layers at approximately 10 foot intervals vertically. Where seepage is noted, the Regional Materials Engineer should be consulted so that an adequate drainage system is provided.

When it is anticipated that certain cuts or borrow areas will contain considerable amounts of material with moisture content in excess of the optimum for proper compaction of embankments, aeration equipment may be included in the proposal for the project.

The inclusion of aeration equipment in the proposal will not relieve the Contractor of the responsibility of employing sound and workmanlike procedures in the prosecution of the work which are effective in constructing embankments with wet materials. Ditches to remove surface or subterranean drainage should be constructed whenever they can be effective and preferably in advance of excavation, thus permitting time for drainage.

The function of aeration equipment is to provide thin, loose layers of material from which moisture can evaporate. Most soils tend to form a crust which retards the evaporation of moisture. Unless this material is worked to break up this crust, evaporation is quite slow. During good drying weather, a sheepsfoot roller is quite effective in certain soils in breaking up the surface of the soil and, in thin lifts of material, leaves large surface areas of soil exposed to the air. However, no separate payment for a sheepsfoot roller will be made and the costs of same are incidental to embankment compaction.

If the material has a considerable amount of moisture above the optimum for proper compaction of embankments, it may be necessary to operate aeration equipment in the excavation areas as well as the embankment areas to increase the amount of material exposed for evaporation. The amount of moisture that will evaporate from the material is dependent on the prevailing weather conditions, the surface area of material exposed and the length of time the material is exposed to the air.

It must be kept in mind that thin, loose layers of material will also soak up large amounts of moisture if it rains, so the surface of the materials must be sealed and sloped to drain off moisture whenever rain is imminent. It is the responsibility of the Contractor to seal the material against rain and in many cases this will have to be done at the end of work each day to protect against sudden, unexpected storms.

### **SS 2-03.3(14)D Compaction and Moisture Control Tests**

The maximum density and optimum moisture content for a soil are determined by testing the soil in accordance with one of three test methods:

AASHTO T 99 Method A

AASHTO T 180 Method D

WSDOT Test Method No. 606

Determination of which test to perform is based upon the gradation of the material. Section 2-03.3(14)D discusses the gradations and which tests are applicable. Materials with 30 percent or more by weight retained on the No. 4 sieve and less than 30 percent retained on the  $\frac{3}{4}$  inch sieve can use either WSDOT T 606 or AASHTO T 180. For those materials, the Agency decides which test to use. The Project Engineer should consult with the Regional Materials Engineer when deciding which test to use.

Each different soil may, and probably will, have a different maximum density and optimum moisture content, and it is necessary that tests be performed in the field for each different soil encountered. As each of the materials is being tested, a representative sample should be taken and placed in a sealed sample jar to serve as a future reference for identifying the materials on the grade during construction. It is the responsibility of the Project Engineer to arrange for all field testing necessary to supplement data furnished with the soils report.

Noncohesive sandy and gravelly soils and surfacing aggregate cannot be tested by the above-noted test method. Samples of these materials must be sent to the Regional Materials Engineer with a request for maximum density determination. This test method is described in [Chapter 9](#). A gradation vs. density curve will be established for use by the Inspector during construction.

To determine if the embankments are being compacted properly, in-place density tests must be taken at frequent intervals. Results of these tests are compared to the density standard established for the soil (noncohesive granular material) being compacted, and are used as the basis for accepting or rejecting the work of the Contractor. Each lift of embankment should be tested before subsequent lifts are placed. When loose free draining sandy material is used for embankment construction, the Inspector should dig down 1 foot and run a density test on the undisturbed material. In selecting an area to be tested, the Inspector should choose sites where the least compactive effort has been applied. A continuous record of the Contractor's method of compaction should be kept and compared to test results to assist in selecting a routine procedure which will yield required results. Compaction is required to the neat lines of the embankment, which include the shoulders and slopes. Proper compaction of embankment slopes will tend to minimize slope surface erosion which occurs often on newly constructed embankments.

Care must be taken to see that uniform density is obtained throughout each fill rather than to have some areas compacted greatly in excess of the density requirements, while other areas are below requirements. In order to achieve uniform density, it is essential that the water content be uniform since the density obtainable with a given soil is a function of the water content for any one compactive effort. In most cases, the required density can be obtained with the least effort if the water content is very close to, but less than, the optimum established by standard moisture-density test. Noncohesive granular soils usually compact most easily when wetted to near saturation. The Contractor should be encouraged to establish a definite routine for compaction that will result in uniform

compactive effort. When a considerable amount of grading equipment is concentrated in a small embankment area, it is difficult to maintain uniform compaction methods on each lift and the Inspector must be especially alert. When the size of the embankment area can be increased, uniform compaction methods can be more readily established, thinner lifts of material can be placed and moisture content can be better controlled.

The Speedy Moisture Tester is a good tool for the Inspector to use to check the moisture content of the material while it is being worked in the embankment. This will quickly tell the Inspector whether moisture must be removed or added before the layer is covered with additional material. The Inspector must be cautioned that due to the small amount of material used in the Speedy Moisture Tester, it is essential that the sample used is actually representative of the material being worked. If the moisture content of the material being worked is quite uniform, this does not present too much of a problem.

When embankment construction is first started, the Inspector should give particular attention to the compaction methods and take more than the minimum number of density tests to determine the most advantageous compaction pattern that will give the desired compaction results. After a satisfactory compaction pattern has been established for the type of material being placed, the density testing may be reduced to the minimum rate specified.

Where it is necessary to add water for compacting, this may be done either in the cut (or borrow pit) or on the fill. Water must not be added to material obtained from a borrow pit before weighing when payment is by weight. Addition of water in the cut allows the scrapers and hauling equipment to mix the water into the soil so that rolling can proceed immediately after spreading. Sprinkling should be done on a rough loose surface rather than on one which is smooth and tight because the water will not be so apt to run off or form ponds.

Daily compaction reports must be submitted on DOT Form 351-015. If there are questions concerning operational procedure on moisture-density tests, in-place tests, and reporting of results on the above form, consult the Regional Materials Engineer for advice and assistance.

Special attention must be given to compaction around structures and bridge ends, where rollers cannot operate. Mechanical tampers or other approved compactors are to be used in these areas. Sufficient density tests shall be taken to ensure that compaction is continued on each lift until the specified density is attained. Failure to do so can result in settlement near the structure.

### **SS 2-03.3(14)E *Unsuitable Foundation Excavation***

The natural ground upon which an embankment is to be constructed may be such that it will impair the stability of the completed roadway. Such conditions must be corrected prior to starting embankment construction. Unsuitable ground such as peat, soft organic clay, and silts must be removed or otherwise stabilized to prevent unequal or excessive roadway settlement or embankment failure. Areas requiring special foundation treatment will be shown in the plans and/or specified in the Special Provisions with the exception that possible detrimental soil at the transition between cut and fill and under shallow embankments may not be indicated. Particular attention should be given to these areas and in the event that highly compressible or unstable top soil or other undesirable material exists, it should be removed in accordance with [Standard Specifications](#) Section 2-03.3(14).

Where specified in the Contract Plans and/or the Special Provisions, unsuitable foundation materials shall be removed or otherwise stabilized as required. When removal is required, inspection should determine that the removal is complete to solid foundation.

Where backfilling must be done under water, granular material should be used, and special care must be taken to avoid segregation of the material, and the trapping of unsuitable material in the backfilled area.

#### **SS 2-03.3(14)F *Displacement of Unsuitable Foundation Materials***

Removal of unsuitable foundation material by displacement with or without the use of explosives is not a preferred method of dealing with these materials. Often this method has unintended consequences and environmental impacts and should only be attempted where specified and permitted, or where recommended by the State Geotechnical Engineer and approved by the State Construction Office.

In the event that other unsuitable foundation material exists and is not indicated in the Contract and is beyond the limits as described in *Standard Specifications* Section 2-03.3(14), the State Construction Office should be contacted through the Region for assistance in reaching a resolution.

#### **SS 2-03.3(14)G *Backfilling***

Where water exists in the excavation areas, it should be drained, if possible, by ditching so that excavation and backfilling can be accomplished in the dry.

#### **SS 2-03.3(14)H *Prefabricated Vertical Drains***

Embankment settlement can be accelerated by the use of overloads, vertical sand drains, or by vacuum pumping to lower the water table. These treatments should not be attempted unless specified by the contract provisions or recommended by the State Geotechnical Engineer and approved by the State Construction Office.

### **GEN 2-03.4/5 *Measurement and Payment***

#### **GEN2-03.4/5(2) *Computer Generated Quantities***

All applicable records of computed generated quantities shall be kept and become a part of the final records.

## **2-04 Haul**

### **SS 2-04.4 *Measurement***

The measurement of haul is expressed as a unit of one hundred cubic yards hauled 100 feet.

Haul shall be calculated and included in the section from which the material is hauled. Haul on roadway quantities, including borrow obtained by the widening of cuts and including waste deposited along roadway embankment slopes, will be computed on the basis of transporting material along the centerline or base line of the highway.

## Haul on Borrow or Waste

Quantities of material hauled from a borrow site to the roadway or from the roadway to a waste site are computed normal to the long axis of the borrow or waste site. When computing the amount of haul, determination of the direction of movement of the mass and the distance it is transported requires good, practical judgment by the Project Engineer. The size and shape of a borrow pit and egress from the pit to the highway improvement must be considered in the proper determination of the amount of haul. The same conditions are true in the case of waste sites. Instructions herein for computing haul from borrow pits shall be applicable to computing haul to waste sites.

The long axis of the borrow pit should be used for the base line of the cross-section which, theoretically, would pass through the centers of gravity of the sections; however, the base line may approximate the centers of gravity of the sections. Borrow pits which are provided by widening of the roadway cuts would be an exception to this since the *Standard Specifications* define them as "Roadway Excavation" and not "Borrow."

The measurement of the distance from the pit to the center line of the roadway should originate at the center of mass as measured in the pit and be computed via the most direct and feasible route to the nearest practical point on the center line of the roadway.

The route of haul will be indicated on the plans, and, where possible, will be via existing roads. If no road exists, provision will be made in the plans for constructing a haul road and for rights therefor.

If the Contractor chooses to haul over a route shorter than the computed or designated route, payment for haul will be based on the length of the actual haul route. If the Contractor chooses to haul over a longer route than the computed or designated route, payment for haul will be based on the length of the computed or designated route.

## 2-06 Subgrade Preparation

### SS 2-06.3 Construction Requirements

The subgrade shall be constructed in accordance with the lines, grades, and typical sections shown on the plans or as established by the Project Engineer and the *Standard Specifications*.

The entire subgrade should be uniformly compacted to the density specified. The subgrade shall meet the tolerance in [Section 1-06](#). On some separate grading projects where the surfacing Contractor will be required to or elects to trim the subgrade with an automatically controlled mechanical trimmer, the tolerances for the subgrade must be changed to provide material for the subgrade trimmer to trim, but the trimmed subgrade must meet the tolerance stated above.

After the subgrade is prepared, the Contractor shall maintain it in the required condition until the next course of work is performed.

## 2-07 Watering

### SS 2-7.3 Construction Requirements

Water shall be applied as ordered by the Project Engineer, in accordance with the Specifications, uniformly to the material so that all of the material will have approximately the same moisture content. It is more economical and effective to apply water at night or in the early morning hours when loss from evaporation is lower. In many instances, this is the only time that it is possible to increase the moisture content to that required.

The Inspector should be alert to see that the subgrade is not damaged from too much water being applied or that more water is being applied than is necessary. Usually light applications applied more frequently are more advantageous than heavy applications. The water should not be applied on surfacing materials with such force that it will wash the fine particles off the coarser ones causing segregation.

If water is a pay item, the Project Engineer shall verify the size of the water truck by measuring or weighing and if gauges are used and should also verify the accuracy of the gauge. A record of measurements or weights, and calculations must be made for future references.

Use the Contactless Receipt Log (DOT Form 410-001) or a Contractor provided Item Quantity Ticket to record the time of each load and where it was placed on the project. See CM [Section 10-2.3A](#).

## 2-09 Structure Excavation

### SS 2-09.3 Construction Requirements

#### SS 2-09.3(1) General Requirements

##### SS 2-09.3(1)A Staking, Cross-Sectioning, and Inspecting

Before starting structure excavation, stakes should be set to locate the structure and cross-sections should be taken to determine the quantities of material involved.

##### SS 2-09.3(1)B Depth of Excavation

Excavations shall be carried to the elevation shown on the plans or as established by the Project Engineer. The Project Engineer should take into consideration the fact that when a clamshell bucket is used, it is very difficult to clean the hole to an exact given elevation. For direct-bearing footings, the corners and sides of the excavation should be cleaned out as well as possible and there should not be an excess of loose material left in the bottom. If the character of the material found at plan elevation is questionable, consult the Regional Materials Engineer.

When the excavation for the footing has been completed, elevations to establish the footing elevation shall be taken in the corners of any footing and recorded in the project records.

**SS 2-09.3(1)C Removal of Unstable Base Material**

During the progress of excavation, the character of material being removed and exposed should be examined to determine if it is suitable for use as backfill and to ensure that acceptable foundation conditions exist. This should be done especially on streams subject to high velocity flood water and which carry drift.

Open pit excavation or “glory holes” are not allowed without permission. This Specification is of special importance in application to the construction of foundations in or adjacent to running streams, where the approval of the State Construction Office must be secured.

**SS 2-09.3(1)D Disposal of Excavated Material**

Material obtained from structure excavation may be used for backfilling over and around the structures, for building embankments, or it may be wasted. When this material is stockpiled for backfilling, the Contractor is required to protect it from contamination and the elements. If not properly protected, the Contractor must replace the lost material with acceptable backfill material at no expense to WSDOT.

**SS 2-09.3(1)E Backfilling**

The backfilling of openings made for structures must be made with acceptable material from the excavation, other acceptable backfill materials indicated in the plans and Special Provisions, or as specified in [Standard Specifications](#) Section 2-09.3(1)E.

When specified in the Contract or approved by the Project Engineer, acceptable material may include Controlled Density Fill (CDF) – also known as Controlled Low-Strength Material (CLSM).

Before the CDF is placed, the Contractor is required to develop a mix design in accordance with [Standard Specifications](#) Section 2-09.3(1)E and to submit the CDF mix design in writing to the Project Engineer on DOT Form 350-040. [Standard Specifications](#) Section 2-09.3(1)E requires the Contractor to utilize ACI 229 and testing methods ASTM D 4832, ASTM D 6023, and WSDOT FOP for AASHTO T 119 in developing the CDF mix design. The ASTM and AASHTO tests required in [Standard Specifications](#) Section 2-09.3(1)E are for use by the Contractor in developing the CDF mix design, and with the exception of providing the 28-day compressive strength test results on DOT Form 350-040, the test results are not required as part of the CDF mix design submittal. The Project Engineer must review the mix design before placement of the CDF will be allowed.

The Inspector must verify and document that each truckload of CDF is accompanied by the producer supplied Certificate of Compliance, meeting the requirements of [Standard Specifications](#) Section 6-02.3(5)B. The Inspector must also verify that the components, as listed on the Certificate of Compliance, conform to the mix design per [Standard Specifications](#) Section 6-02.3(5)C. Acceptance of the CDF will be based upon an acceptable Certificate of Compliance. In accordance with [Standard Specifications](#) Section 1-05.2, the Inspector may reject any load of CDF that does not conform to the mix design.



When water is encountered in the excavation area, it must be removed before backfilling. Cost for accomplishing this is considered incidental and is done at the Contractor's expense unless otherwise provided for in the Contract.

### **SS 2-09.3(2) Classification of Structure Excavation**

Structure excavation is classified into two classes. The excavation necessary for the construction of bridge footings, pile caps, seals, wing walls, and retaining walls is classified as Structure Excavation Class A. All other Structure Excavation is classified as Structure Excavation Class B. See [Standard Specifications](#) Sections 2-09.3(2), 2-09.3(3), and 2-09.3(4).

### **SS 2-09.3(3) Construction Requirements, Structure Excavation, Class A**

#### **SS 2-09.3(3)D Shoring and Cofferdams**

All excavations 4 feet or more in depth shall be shored, protected by cofferdams, or shall meet the open-pit requirements of [Standard Specifications](#) Section 2-09.3(3)B.

The Contractor must submit their shoring plans in accordance with [Standard Specifications](#) Section 2-09.3(3)D. The shoring design shall be in compliance with the [Geotechnical Design Manual](#) M 46-03, and be designed for site specific conditions, which must be shown and described in the working drawings. These drawings must be approved before construction begins. WSDOT's approval, however, does not relieve the Contractor of responsibility of satisfactory results.

For excavations using open pits - extra excavation, the Contractor shall submit Working Drawings and in accordance with [Standard Specifications](#) Section 2-09.3(3)B.

[WAC 296-155 part N addresses temporary excavations](#). If the Contractor follows the WAC, Type 2 Working Drawings are required. Within the WAC requirements, it may be necessary for the Contractor to do engineering. Should this occur, the Contractor will need to submit Type 2E Working Drawings. This can occur if the soil types are not consistent with those of the WAC, if there are surcharge loads or sensitive structures near the slope, or if the slope height exceeds the WAC max height of 20 feet.

The excavation stability design shall be conducted in accordance with the [Geotechnical Design Manual](#) M 46-03 and must be designed for site specific conditions, which must be shown and described in the Working Drawings. These drawings must be approved before construction begins.

[The Contractor shall submit detailed plans of cofferdams for approval per Standard Specifications](#) Section 2-09.3(3)D when their use is required. This requirement shall be strictly followed. When a cofferdam is required on a railroad right of way, excavation must not be commenced before the Plans have been approved by the railroad company. The Contractor should be notified of this requirement well in advance of starting such Work, as it usually takes several weeks to get plans approved by the railroads. See Section 6-1.5 for the number of copies to submit and distribution of approved plans.

Cofferdams, in general, must be removed to the bed of the stream, or to below the low water mark. In some cases, it may be advisable to leave the cofferdam in place. The Cofferdam is, however, the property of the Contractor.

Sheet piling, designed in accordance with the USS Steel Sheet Piling Design Manual, may be used for shoring walls that do not support other structures and that are 15 feet in height or less. When sheet piles are used for cofferdams, the Project Engineer shall see that the sheets are held tightly together during driving and placing, so that no cracks or holes are left, through which water can flow. If timbers are used in the cofferdam, the use of wood preservatives needs to be monitored to be sure that all environmental constraints are met. Cofferdams should be built slightly larger than the neat size shown on the plans. This is to allow for inaccuracy of driving sheet piles.

Where bearing piles are to be driven, the excavation should be carried deeper to allow for upheaval of soil due to pile driving. This extra depth will depend on the character of the material. Usually in sand and gravel from 6 inches to 1 foot and in a river or tide mud from 1 foot to 1.5 feet is sufficient. Such over-excavation is the Contractor's responsibility. Over-excavation shall be backfilled with gravel backfill to the footing elevation if the upheaval is less than anticipated.

In soft mud, when the driving of piles tends to liquefy the foundation material, it is sometimes necessary to excavate below plan grade and backfill with gravel before concrete is placed. When the Engineer considers this to be necessary and approval of the State Construction Office has been secured, the additional excavation shall be paid for at the unit Contract price for structure excavation and the gravel backfill shall be paid for on force account basis or at an agreed price.

The material on which spread footings are to be constructed must be adequate to support the design soil pressure per square foot shown in the plans. The Regional Materials Engineer should be consulted to review the foundation conditions if the bottom of the footing is materially different than what is identified in the Contract plans. If a change of design or the lowering of a footing appears to be advisable, the State Construction Office must be advised.

Occasionally, foundations adjacent to large piers are founded at a higher elevation than the large pier foundation. In these cases, the Contractor must carry on operations so that the foundation at the higher elevation will not be disturbed when excavation is made for the lower pier.

Backfilling holes made for piers and column bents up to the surface of the surrounding ground may be done at any time after the forms are removed, providing the backfilling is brought up evenly on all sides of the pier or column.

Backfilling around piers and bents in streams shall be done carefully with material suitable to resist scour, and be brought up to a height not less than the original bed of the stream. Embankment backfill against abutments, piers, walls, culverts, or other structures shall not be placed until the concrete has attained 90 percent of its design strength and has cured for at least 14 days or as otherwise specified in the Contract.

It is very important that drainage be provided in back of retaining walls, tunnels, and structures having wing walls or abutments to eliminate excessive soil pressure. Weep holes shall be placed as shown on the plans and as low as possible. Gravel backfill for walls or other suitable materials shall be placed directly behind the structure. If drainage is a major problem, it may be necessary to also construct perforated drain pipe or French drains behind the structure.

The construction of embankments and backfill around bridge ends shall be in accordance with *Standard Specifications* Section 2-03.3(14)I. The fill around bridge ends shall be brought up equally on all sides of the bracing, columns, and bulkheads to avoid distortion and displacement of these members.

In addition, *Standard Specifications* Section 2-03.3(14)I requires that the superstructure be in place before the backfill behind an abutment can be placed. It further states that this requirement can be waived by the Engineer provided the Contractor submits abutment stability calculations to back up their proposal. When designing the bridge, the designers check the abutment stability using the final condition which includes the dead load of the superstructure. This superstructure dead load increases the resistance to sliding and reduces the overturning moment of the abutment. Since placement of the backfill prior to placement of the superstructure is a condition not analyzed by our designers, we require that stability calculations be submitted for each bridge by the Contractor to reflect this unchecked condition. These stability calculations need to include a surcharge load of at least 2 feet to account for the live loading due to the backfill equipment weight.

Around structures and bridge ends, where rollers cannot operate, compaction shall be obtained by the use of mechanical tampers. Density tests shall be taken frequently enough to ensure that compaction is continued on each lift until the specified density is attained.

## 2-10 Ditch and Channel Excavation

### SS 2-10.3 Construction Requirements

Areas where open ditches are to be constructed shall be cleared and grubbed the same as areas for roadway excavation.

The excavated material may be used for the construction of dikes, berms, or otherwise disposed of as shown on the plans or as directed by the Project Engineer. The materials should not be placed in embankments unless it is suitable for embankment construction.

## 2-11 Trimming and Cleanup

### SS 2-11.3 Construction Requirements

This work shall consist of dressing and trimming the entire roadway or roadways improved under the Contract. The shoulders, ditches, and back slopes shall be trimmed to the specified cross-section to produce a neat and pleasing appearance. All channels, ditches, and gutters shall be opened up and cleaned to ensure designed drainage. This includes existing drainage within the project limits specified in the Contract.

## 2-12 Construction Geotextile

### SS 2-12.3 Construction Requirements

Construction geotextile fabric needs to be fully covered at all times until placement. It should be stored in a protected area off the ground and away from items that can cause damage such as sunlight, heat, precipitation, chemicals flames including welding sparks and any other environmental condition that may damage the physical properties of the fabric.

The area to be covered should be graded to a smooth, uniform condition free from ruts, holes, and protruding objects such as rocks and sticks. The fabric needs to be placed immediately ahead of the covering operation with as few wrinkles as possible. The material should not be dragged through the mud nor over sharp or protruding objects which could damage the material.

The cover material is to be placed in front of the placing equipment. This equipment should be sized to minimize the rutting that may occur during the placement. Turning of vehicles on the first lift of material may cause damage to the fabric and should not be allowed.

Sewing of seams is described in [Standard Specifications](#) Section 2-12.3.

Fabric damaged during placement needs to be repaired as soon as possible. The backfill material needs to be removed and the fabric repaired either as recommended by the manufacture or as listed in the contract. Visible evidence of damaged material may include subgrade pumping, intrusion of subgrade, or roadbed distortion.

#### Placement

[Standard Specifications](#) Section 2-12.3 lists the required placing and lapping requirements for each type of use of construction geotextile. Following is a short explanation for the placement types.

- **Underground Drainage** – The fabric is used as a wrap around the drain rock and the pipe to not only separate the backfill material from the drainage material but also to act as a filter of fine sands and silts. This prevents the fines from flowing into the drain rock and clogging the drainage system.
- **Separation** – The fabric is placed directly on a subgrade that contains a large amount of fine sand and silts. Normally the subgrade can be constructed during fair weather, however, almost any amount of moisture can make working on the grade impossible.
- **Soil Stabilization** – Soft subgrade that cannot support the weight of equipment constructing the roadbed, is usually removed, a fabric placed and covered with backfill. This allows a stable enough surface to continue construction. Here the fabric not only separates the two materials but also adds strength to the roadbed.
- **Permanent Erosion Control and Ditch Lining** – The fabric is utilized to reduce or minimize the ground surface's exposure to erosion. The material is placed directly on the surface to be protected and then backfill is placed over the fabric. Rock surfacing should not be placed in a lined ditch under the fabric as this would allow the water to erode the ground under the fabric thus eliminating its effectiveness.
- **Temporary Silt Fences** – As the title states, the fabric is used to trap silt and other fine particles from continuing from the project site to open water.

### 3-01 Production From Quarry and Pit Sites

#### GEN 3-01.1 General Instructions

In the production of crushed and screened materials, continuous and effective inspection throughout all phases of the work is essential in order for the Washington State Department of Transportation (WSDOT) to obtain the best possible product from the available material. The Project Engineer is responsible for the enforcement of all specifications governing pit operations, crushing and screening procedures, and handling and placing of the product, as well as the various specifications governing gradation and quality.

The Project Engineer and Region Materials Office provides the Inspectors with the proper tools to test and inspect the production of materials. They also ensure that facilities are available at the plant site to enable the Inspector to carry out the work in the proper manner and obtain test results which are accurate and complete. The Project Engineer makes certain that the Inspector understands the nature of the work to be performed and is acquainted thoroughly with the applicable specifications and that the Inspector is proficient in the various testing techniques.

The Inspector needs to be familiar with the methods and procedures involved in crushing and screening operations so that the Inspector can appraise the causes of troubles when they occur. The Project Engineer or Inspector must never attempt to tell the Contractor how to conduct their operations (except where required by the specifications), but a good working relationship with the Contractor, based on a mutual respect for each other's knowledge and ability, will do much to ensure an efficient operation and a good product.

#### GEN 3-01.2 Outline of Inspector's Duties

Some of the most important duties of inspection are listed below:

- Check special provisions for special requirements in pit operation (area to be excavated, depth of excavation, etc.).
- See that overburden is stripped from pit in proper manner.
- Watch for radical changes in the character of material in pit.
- When required, see that washing and/or scalping are conducted in a proper manner.
- See that the plant, belts and loaders operate at a constant rhythm.
- Watch for evidence of segregation of the material. Advise the Contractor to take steps to correct any segregation.
- All sampling and testing of the product(s) is to be performed by a Qualified Tester.
- Keep complete records of field tests.
- See that the prime Contractor is informed of test results.
- When required, submit samples for mix design. Be sure to allow ample time for testing.
- Submit samples for determination of standard density.

## SS 3-01.2 Material Sources, General Requirements

### SS 3-01.2(2) Preparation of Site

The portion of the pit or quarry site to be used is prepared in accordance with the requirements of *Standard Specifications* Section 3-01. The strippings from the pit are stockpiled or disposed of in accordance with the reclamation plan as covered in [Section 3-03](#). Care is taken in this operation so that usable material is not fouled or lost. In most cases, the manner in which the site is worked will determine how much work will be required to dress it up in accordance with the reclamation plan.

### SS 3-01.2(4) Production Requirements

Prior to sampling and testing the material produced by the Contractor, the Inspector is required to satisfactorily complete the Method Qualified Tester Program in [Chapter 9](#) for the tests to be performed.

It is imperative that the Project Engineer keep the Contractor informed of test results at all times. If the material being produced does not meet the requirements of the specifications, the Contractor must be informed immediately that the material is unacceptable so that corrections may be made. The Inspector's Record of Field Tests is used to record the test results completed by the Inspector. The Contractor Foreman's copy of the test results should be delivered as soon as practical after completion of each test to the foreman in charge of producing the material. When the test results show the material fails to meet specification requirements, the Inspector shall explain in the remarks section on the test form what action was taken to correct the deficiency. This form has the twofold purpose of providing a record of the test results and of keeping the Contractor informed of the quality and gradation of the material being produced.

Several field control tests may be required by the specifications for the type of material involved. These tests must be performed by a Qualified Tester and may include:

- Screen analysis for gradation.
- Sand equivalent test for detrimental fines.
- Examination of the material to determine percentage of fractured pieces.
- Moisture determination test.
- Organic matter content test.

The Inspector shall conduct these tests as often as necessary following the instructions for sampling and test methods described in [Chapter 9](#). When production is first started, and until the production has resulted in a uniform product well within specification requirements, tests need to be taken more frequently than the minimum specified. Special care must be exercised to ensure that the sample taken for testing is representative of the material being produced.

Samples are taken and forwarded to the Region Materials Laboratory or State Materials Laboratory in the amounts and at the intervals specified in [Chapter 9](#). Job site samples shall be obtained, tested, and recorded in accordance with the *Standard Specifications*, the contract special provisions, and Sections 9-5 and 10-3.

Samples of aggregate for bituminous mixtures are submitted to the State Materials Laboratory for determination of a mix design. These samples must be representative of the average grading of separate materials produced and information concerning the proportions of coarse and fine aggregates produced shall be included in the letter of transmittal. If blending sand may be required, a sample of this material shall be included in the shipment.

Ample time for testing of the materials must be allowed. A minimum time of one to two weeks is required by the laboratory to complete the tests and advise the Project Engineer of the recommended mix design. The *Standard Specifications* require allowance of 25 calendar days for mix design work after receipt of material and data in Tumwater.

### **Pit Operations**

The Inspector must be alert to detect changes in test results, and look for evidence of changes in the character of the pit, or changes in crushing or screening procedures, as possible causes of variations. The use of production control charts provides an excellent visual means of detecting changes in the material being produced. Use of these charts is recommended for any significant production operation. Some quarries and pits contain pockets or areas of unsuitable material. The Inspector should keep familiar with the condition of the site so if areas of unsuitable material do appear, steps can be taken to bypass these materials. The Inspector should also be aware of the tempo of the plant operations. A steady operation in all phases is desired. In particular, the plant should not run faster after a sample has been taken than it was prior to sampling.

Many quarries and pits require scalping to remove a portion of the fine material. When scalping is required, it is necessary for the Inspector to check to be sure the scalping screen does not become coated or plugged and allow the fine material to be incorporated into the finished product. When a scalping screen of a certain size is required in the special provisions, the Inspector shall check to see that it is of sufficient size and capacity that most of the material finer than the specified size is removed.

The Inspector must watch for evidence of segregation of the material on conveyor belts, in bunkers, or in discharging material into trucks. If any evidence of segregation is found at any stage of manufacture or handling, corrective devices, such as baffles, mixing chutes, rock ladders, etc., must be required.

### **SS 3-01.2(5) Final Cleanup**

When the Contractor has completed work in a WSDOT furnished material source, the Project Engineer shall prepare a pit evaluation report on WSDOT Form 350-023. The information contained in these reports is needed to determine the future use of the pit. Also the information is very helpful in preparing plans for future projects in estimating stripping or special requirements that may be necessary to produce satisfactory products.

### SS 3-01.3 State Furnished Material Sources

WSDOT furnished material sources normally are to be used on future projects as well as the present one so it is necessary that the material be removed in such a manner that the future usefulness of the pit is not impaired. *Standard Specifications* Section 3-01.3(1) requires the Contractor to submit a work plan for approval of the proposed operations in the pit before starting work in the pit so that it can be ascertained that the Contractor will not impair the future usefulness of the site.

In addition to the source containing sufficient material for the project, there should also be adequate area for the plant setup. If the project includes treated materials, consideration should also be given to provide sufficient area for the temporary stockpiling of the aggregates for the treated material and the mixing plant.

Disposal of strippings and scalpings in the site is of utmost importance if satisfactory reclamation of the site is to be accomplished with the minimum amount of work. This material should be placed where it will not interfere with future development of the site.

Surplus material accumulated during the production of specified materials will remain the property of WSDOT and must be stockpiled in the pit area where directed by the Project Engineer in accordance with the specifications for stockpiling material. The Contractor may be eligible for reimbursement of the production costs of the surplus material up to 110 percent of plan quantity or as specified by the Project Engineer.

If more than one source is provided in the special provisions, the Contractor may obtain the material from any of the sources. If the Contractor sets up in a site, and it is found that the quantity of raw materials from that site, when the site is exhausted, is less than that specified by WSDOT, then WSDOT may pay for moving the crushing plant in accordance with the provisions of *Standard Specifications* Section 3-01.3(5). If the new source of material necessitates a longer haul of the materials, WSDOT may also pay for the additional haul as specified.

### SS 3-01.4 Contractor Furnished Material Sources

If the Contractor is required to furnish a source of materials or elects to use materials from a source different from those provided by WSDOT, the Contractor shall make arrangements for obtaining the materials and testing the source at no expense to WSDOT. The Contractor shall submit Request for Approval of Material, WSDOT Form 350-071, identifying the source. If sampling is required, the contractor is responsible for providing the preliminary samples which are taken at locations designated and witnessed by the Region Materials Engineer or a designated representative. Use of the materials from the Contractor's source will not be permitted until after the materials have been tested, the source approved, and authority granted for the use of it. Acceptance of the materials will be based on their meeting the requirements of the specifications at the point of acceptance in Section 9-3.4.

If the Contractor has elected to use a source listed in the Aggregate Source Approval (ASA) Data Base, and the material has been approved for the intended use, the Project Engineer can approve the Contractor's request. If the Contractor has selected a source not in the ASA Data Base, WSDOT may sample and test the material for a specified use on a project. All cost associated with this sampling and testing will be the responsibility of the Contractor. The Project Engineer can approve the request based on test results showing the material meets the specifications for which its use is intended.



Before preliminary samples of the materials are taken, the Contractor is required to have done enough testing of the source to ensure the quantity of material available so samples can be obtained which are representative of the material available from the source. The material in the Contractor's source must be of a quality equal to or better than that of the WSDOT provided source if test values are listed in the special provisions; otherwise they must meet the minimum specification requirements. Any surplus screening accumulated during the manufacture of specified material will remain the property of the Contractor.

When measurement is by weight and the specific gravity of the material in the Contractor's source is greater than in the specified source, [Standard Specifications](#) Section 3-01.4(1) require that any additional material required to construct the minimum specified surfacing depth shall be furnished by the Contractor at no cost to WSDOT. The following procedures shall be used to administer the specification:

When the Contractor's source of material has a specific gravity greater than the WSDOT provided source, a variation up to and including 0.05 above the specified source will be considered within the limit of working variation and will not affect course depths by a measurable amount. A variation in specific gravity greater than 0.05 will require a correction item for a credit deduction in treated and untreated items to compensate for the heavier materials. The credit deduction will be based on the following formula:

$$D = T * \left( \frac{C}{S} - 1 \right)$$

Where:

- T = Gross Weight of Product Furnished in Tons
- C = Specific Gravity of Contractor's Source
- S = Specific Gravity of WSDOT Furnished Source
- D = Credit Weight to be Deducted in Tons

Payment under the item will be made for:

$$T - D = \text{Net Tons}$$

The preparation, production, and cleanup of the Contractor's material sources shall conform to the requirements of [Standard Specifications](#) Section 3-01.4. Clearing, grubbing, and stripping are not to be paid for on Contractor's sources.

### SS 3-01.5 Measurement

The area to be used to obtain material, for plant setup and any necessary stockpiles, shall be staked and measured for clearing and grubbing as specified in Section 2-01. The area to be stripped must be staked and final ground measurements taken to determine the volume of material excavated. It is important that an area be stripped which is slightly larger than the area required for the material. This will permit stripping additional area without leaving some material to contaminate the pit and it will also prevent working the pit to the edge of the strippings.

## 3-02 Stockpiling Aggregates

### SS 3-02.2 General Requirements

#### SS 3-02.2(6) Construction of Stockpiles

Stockpiles shall be constructed in conformity with the provisions of the *Standard Specifications*. The area upon which the material is to be stockpiled is prepared carefully by removing all vegetation and constructing a uniform, flat ground surface. Preparation of a good base for the stockpile will minimize wastage of material, and will prevent contamination of the material when removing it from the stockpile.

The Project Engineer indicates to the Contractor the location of each proposed stockpile by placing marked stakes at each corner of the area to be used. If the material is to be stockpiled for later use by the Contractor, as in the case of aggregates for bituminous mixtures, the Project Engineer must consult with the Contractor and locate these stockpiles to conform with Contractor's plans for erecting the mixing plant, etc.

Stockpiles shall be located to ensure easy access by trucks and loading equipment and care must be exercised to see that a sufficient distance is maintained between the various stockpiles so there will be no possibility of mixing the various classes of materials. For all stockpiles, the maximum height is 24 feet. For stockpiles in excess of 200 cubic yards, the material shall be placed in the stockpile in layers not to exceed 4 feet in height, and in such a manner that segregation of the fine and coarse portions of the material does not occur. The Inspector must be watchful to see that segregation is held to a minimum. End dumping, dozing material over the side of the stockpile, or allowing material to roll down the slope is not permitted as severe segregation will occur as a result of such procedures.

After completion of each lift of material during the construction of a stockpile, it is common practice to use a pneumatic dozer to level the top of the lift before placing the next layer. This practice may be permitted but the Inspector must see that the operation of the dozer is limited to the minimum amount of work required to level the top of the layer, as excessive operation of the dozer on the pile can result in serious degradation of the material. If it is known that the stone is rather soft and subject to severe degradation under abrasion, the use of dozers on the pile must be prohibited and the pile leveled by hand or other methods which will eliminate the possibility of excessive degradation of product.

It is important to protect stockpiles from becoming contaminated with mud or other material tracked onto the stockpile. If the surrounding ground is wet and soft, or for any reason contaminates are carried onto the stockpile, the Contractor shall provide a means of preventing the contaminates from contaminating the stockpile. This may be by the placement of granular material on the haul routes to keep the equipment tires clean.

When the Contractor is stockpiling two or more classes of materials at the same time, the Inspector must be alert to see that the materials are placed in the proper stockpiles. A few loads of fine screenings inadvertently placed in a stockpile of coarse screenings can destroy or greatly reduce the quality of a large amount of material.

The Inspector is cautioned to be especially alert when stockpiling is being done during hours of darkness to see that all phases of the work are carried out in accordance with the specifications. In many instances, when difficulties are encountered in the use of stockpile material, it is found that the trouble occurred during the night shift when inspection and testing work are very difficult to accomplish in the proper manner. If the Contractor elects to stockpile aggregates prior to use in the immediate work, the requirements of [Standard Specifications](#) Section 3-02.2(4) must be complied with. The Project Engineer's attention is directed to [Standard Specifications](#) Section 3-02.3 for additional requirements for stockpiling certain aggregates.

Some of the important duties of the Inspector are listed below:

- See that stockpile area is prepared properly.
- Stake each corner of proposed area for piles.
- Watch to see that material is placed in the stockpile in an approved manner.
- Watch for evidence of degradation or segregation of the material in the pile.
- See that piles are kept separate and are neatly finished.

### **SS 3-02.4 Measurement**

The area to be used for stockpiles shall be staked and measured for clearing and grubbing as specified in Section 2-01.

## **3-03 Site Reclamation**

### **GEN 3-03.1 General**

All surface mines are to be reclaimed in accordance with [RCW 78.44 Surface mining](#) and the Contract Reclamation Plan. [Standard Specifications](#) Section 3-03 covers the requirements for site reclamation.

The intent of site reclamation is to develop an area that remains useful and aesthetically pleasing in appearance after the materials are removed from the site.

Costs involved in complying with the requirements and restrictions imposed by WSDOT, the Department of Natural Resources (DNR), or other agencies in order to comply with the Surface Mining Act do not constitute a basis for additional compensation. Any request for an extension of time resulting from plan approval delays will be considered only if complete and adequate plans were submitted in a timely manner.

To permit positive identification of the pit sites when the various surface mining forms are filled out, the pit site number should be included in the description box in the upper right hand corner of the forms.

## SS 3-03.2 General Requirements

### SS 3-03.2(1) Contracting Agency-Provided Sources

Contract reclamation plans for sources furnished by WSDOT will normally be included in the Contract Plans. When this is not done, or when a change to another state source is required, a new plan shall be prepared by the Project Engineer and submitted to the Region Materials Office for review. The Region Materials Office will review the contract reclamation plan to verify that it is in compliance with the DNR Reclamation Permit. The Project Engineer prepares the plan and related papers in accordance with the instructions issued by the Environmental and Engineering Programs Division. These instructions are located in Section 400.06(6) of the *Plans Preparation Manual* M 22-31.

### SS 3-03.2(2) Contractor Provided Sources

Sites operating under a valid reclamation permit issued by DNR will not require a plan to be submitted to the Project Engineer, nor the DNR form, since the Contractor will be corresponding directly with DNR. Evidence of the permit and the conditions contained therein shall be furnished by the Contractor to the Project Engineer. DNR shall perform the inspection and administration of these sites.

Sites with less than 3 acres of newly disturbed land or with walls less than 30 ft in height and one to one or flatter slopes, waste sites, and stockpile sites are not surface mines and do not come under the provisions of the Surface Mining Act but must be reclaimed in accordance with the Contract Plans.

## SS 3-03.3 Reclamation Plans

Reclamation plans are not required for stockpile or waste sites. However, all stockpile and waste sites are to be graded to the extent necessary to control erosion and provide satisfactory appearance consistent with anticipated future use.

Compliance with the State Environmental Policy Act (SEPA) is required for sites on WSDOT right of way involving more than 100 cubic yards of excavation or landfill throughout the lifetime of the site. For waste sites not on WSDOT right of way, the Contractor must comply with the SEPA regulation adopted by the local jurisdiction. Sites involving more than 500 cubic yards of excavation or landfill throughout the lifetime of the site always require compliance with SEPA.

As an assurance of compliance, it is recommended that a site plan for reclaiming stockpile and waste sites be agreed upon by the Region and the Contractor.

In areas where local City or County ordinances exercise control of stockpile or waste sites, the Contractor shall submit copies of the governing agency's permit and evidence of approval by the property owner to the Project Engineer.

In all cases, the Region will be expected to inspect the sites, devoting special attention to aesthetics and ensuring that any diversion of drainage waters due to the wasting or stockpiling operations will not produce any adverse conditions.

## 4-02      Gravel Base

### **GEN 4-02.1    General Instructions**

Gravel Base is typically used in the construction of the roadway section and provides support for the pavement. For the pavement to provide a long life, it is important the gravel base be placed uniformly and compacted properly.

### **SS 4-02.2    Construction Requirements**

When gravel base is specified in the contract, the Contractor may request, in writing, that gravel borrow be used in lieu of gravel base. When gravel borrow is substituted for gravel base, the top 0.10 feet of gravel borrow shall be replaced with 0.10 feet of crushed surfacing top course (CSTC). Testing and sampling frequencies will be as required for the material actually placed. The CSTC and gravel borrow used in lieu of the gravel base is measured and paid for as gravel base and not as CSTC or gravel borrow. The inspector should note on the item quantity ticket that the CSTC or gravel borrow is being used in lieu of gravel base. The as-built plans will identify sections where gravel borrow and CSTC were substituted for gravel base.

## 4-04      Ballast and Crushed Surfacing

### **GEN 4-04.1    General Instructions**

Ballast and crushed surfacing is used in the construction of the roadway section and provides support for the pavement. Ballast may be naturally occurring or manufactured, crushed surfacing is a manufactured material. Careful inspection during the manufacturing process is required to verify that the material meets the contract specifications. This is important so the material will have the properties needed to provide support to the pavement and drain water from beneath it. For the pavement to provide a long life, it is important that ballast or crushed surfacing be placed uniformly to the line, grade, and cross section specified in the plans and compacted properly.

#### **Staking**

See Section 1-05 for listed tolerance and the [Highway Surveying Manual](#) M 22-97 for additional instruction concerning staking.

### **GEN 4-04.2    Inspector's Checklist**

Inspection duties include but are not limited to:

1. Watch for segregation of material on roadway. Make sure each course of surfacing is properly prepared and meets density specifications before allowing the next course to be placed.
2. When applying water to a surfacing course, see that it is distributed evenly over the entire course. Avoid over-watering which may cause soft spots in subgrade.
3. Make frequent checks of yield to see that the specified quantity of material is placed.

4. See that surfacing courses are completed and compacted true to profile and section. See that humps and sags in the profile are removed.
5. See that surfacing is maintained properly. Should irregularities develop in any surfacing the Contractor shall repair the defects prior to placement of the next course.
6. Make depth checks to ensure conformance with the roadway section.
7. Make daily moisture checks on material paid for by the ton when excess moisture is present.
8. Make sure that adequate survey hubs are used in order to verify that the grade will be smooth and uniform.

### **SS 4-04.3 Construction Requirements**

#### **SS 4-04.3(2) Subgrade**

Subgrade for ballast or crushed surfacing is prepared in accordance with the appropriate specifications. Any soft or spongy areas shall be removed or stabilized before the ballast or surfacing material is placed over it.

#### **SS 4-04.3(3) Mixing**

The *Standard Specifications* require the material to be mixed by the Central Plant Mix Method, the Road Mix Method, or a combination of the two methods. On some projects, the Central Plant Mix Method is the required method.

#### **SS 4-04.3(4) Placing and Spreading**

Ballast and crushed surfacing materials shall be hauled and placed on the roadway with the equipment and in accordance with the *Standard Specifications*.

It is imperative that the Inspector watch for segregation of materials during all stages of hauling and placement. The design of the roadway section is based on all materials meeting all requirements of the specifications, including gradation requirements. If crushed surfacing materials are deposited on the roadway in a segregated condition, the only corrective measure available is processing of the material on the roadway, using motor graders or other mixing equipment. Excessive processing of material on the roadway is a poor substitute for placement of material in the proper condition in the first place. Therefore, it is very important that every effort be made to ensure correct handling of the materials at all stages of surfacing operations.

Various types of equipment have been developed in order to facilitate placing the required amount of material with a minimum of segregation to the correct cross-section. When the material is mixed with water in a central plant before placing on the roadway with a spreading machine, it can be compacted and shaped to the proper grade and cross-section with a minimum of handling and shaping on the roadway. Some equipment operates from grade control wires to ensure the material is placed at the proper elevation and transverse slope. If this type of operation is proposed to be used by the Contractor, the Inspector should become familiar with the operation and intricacies of the equipment.

Before each course of surfacing is placed, the Inspector should verify that the underlying course is uniformly graded and compacted properly. The Inspector should also see that each course is finished to a true, smooth profile with no humps or hollows. A good way to

locate irregularities in the roadway profile or crown is by careful visual inspection. Viewing the grade from a prone position or using stringlines between hubs may be helpful. In this way, additional material can be spot-placed to eliminate low and irregular areas, and the material graded and compacted to a true, smooth surface.

It is important the Contractor place the courses of surfacing material in such a manner as to minimize any deleterious effect on the quality of the material already placed. One of the best ways to minimize damage to the previously placed materials is to reduce the amount of hauling equipment traveling over each course. The placement of the surfacing should begin at the extreme end of the haul and proceed toward the point of loading. In this way, the least amount of hauling over completed courses will be required.

#### **SS 4-04.3(5) Shaping and Compaction**

Prior to placing any surfacing material, the Project Engineer submits representative samples of each surfacing material to be used on the project to the Regional Materials Engineer sufficiently in advance of the time of its intended use to permit completion of the compaction control test. For each surfacing material, the Project Engineer will receive a Maximum Density Curve worksheet from either the Regional Materials Laboratory or State Materials Laboratory. This worksheet shows the standard density for all gradations of the tested material as related to the percent passing the U.S. No. 4 sieve.

Each layer of surfacing material placed, including gravel base, is to be compacted with approved compaction equipment and checked for compliance with density specifications before the next layer of material is placed. When individual layers are placed to a depth of less than 1 inch, testing of two layers at one time is permissible. Field in-place density tests are performed in accordance with the test procedures and testing frequencies outlined in [Chapter 9](#). A minimum of 95 percent of the standard density as determined by the compaction control test for granular materials is typically required before the next layer of material is placed.

During processing and compaction, the moisture content of the material should be maintained at the optimum water content. The optimum water content is determined by the State Materials Laboratory and is listed on the Maximum Density Curve worksheet. Frequent light applications of water rather than periodic heavy applications are preferable as light applications tend to avoid saturation of the surfacing material below the surface. Some projects, typically ones with a large quantity of crushed surfacing, will require the water be added to the surfacing by the central mix plant method. With this method, the amount of water added can be closely controlled and mixed thoroughly with the aggregate. This will result in a material that is uniform both in gradation and water content which will be easier to compact.

If the special provisions require that the surfacing courses be trimmed with an automatically controlled trimming machine, the top of each course of different surfacing courses shall be trimmed to grade and cross-section. The cutting of the surfacing by the trimming machine is controlled by wire lines setup along each side of the roadway. It is therefore important that frequent checks of the wire be made both at the initial setup of the wire and during the trimming operation. This is necessary to verify that the wire has not been disturbed and that the grade will be trimmed correctly. The Project Engineer should be aware that the trimming machines now in use only trim the top surface and do not move material longitudinally from high spots to low areas. The Project Engineer shall see that the materials are placed in reasonably correct amounts and slightly higher than

the finished elevations. After completion of the trimming and compaction of the surfacing the finished grade should be checked. Most of the existing trimming machines do a good job of trimming if they are cutting a nominal amount and they tend to chatter and leave an unacceptable washboard surface when operating over a surface that is at or below the finished grade elevation or very hard. On some projects subsequent operations such as concrete paving will also require wire lines and the Contractor will typically use the same wire for both operations. The wires for these cases will need to be set far enough out to allow for the operation of the paving equipment. An alternative to requiring trimming machines for some projects is to use motor graders with automatic controls.

### **Maintenance of Surfacing**

Upon completion of the surfacing courses, the Contractor is required to maintain and water the surface if any traffic is allowed to travel upon the roadway. When traffic is heavy, considerable damage can result if maintenance is not performed daily. It is much better to perform frequent light maintenance on a surfacing course than to wait until considerable rutting, potholing and segregation occur in which event heavy processing and blading will be required. Testing for density in the top surfacing course shall be deferred until just prior to commencing paving operations.

The specifications provide that WSDOT may perform routine maintenance of a traveled roadway only in the event of a suspension of work for an extended period, as in the case of a shutdown for the winter.

### **SS 4-04.3(6) Keystone**

Keystone may be used as needed to provide a tight surface for ballast, gravel base, crushed surfacing base course, or any other surfacing. If the Contractor's operation are such that a considerable amount of coarse rock accumulates on the surface of the completed course that will not compact tightly, keystone may be constructed in accordance with the requirements specified in *Standard Specifications* Section 4-04.3(6). If the Contract includes crushed surfacing top course, the Project Engineer may order the construction of keystone and include the quantity in the measurement and payment of crushed surfacing top course. If the Contract does not include the item crushed surfacing top course, approval for adding the item to the Contract is required before it may be used. Keystone placed for the convenience of the Contractor, with approval of the Project Engineer, is paid for at the lower unit Contract price for either the base material being keyed or the crushed surfacing top course.

The Specifications require that when keystone is necessary that it be placed at the end of each day on the course prepared that day. This requirement is especially important when traffic is being carried through the project to protect the course just completed and also to maintain a satisfactory roadway for the traffic. In areas where the pavement is subject to freeze thaw conditions, the use of crushed surfacing top course may not be appropriate if the crushed surfacing top course is frost susceptible. The Regional Materials Engineer should be contacted prior to using crushed surfacing top course in freeze thaw locations.



### SS 4-04.4 Measurement

The *Standard Specifications* require that surfacing materials be weighed and paid for by the ton or measured by the cubic yard in the hauling vehicle at the point of receiving the material.

For surfacing materials paid for by the ton, water in excess of the maximum permissible amounts, as specified in *Standard Specifications* Section 3-01.5, will be deducted from the weight of material to be paid for on a daily basis. The deduction will be determined by the following formula:

Based on dry weight:

$$D = \frac{T(M - A)}{100 + M}$$

Where:

- D = daily tonnage deduction for excess moisture
- T = total daily tonnage over the scales
- M = percent of moisture
- A = allowable moisture

#### Measurement by the Ton

Refer to Section 10-2.2 for instructions for measuring materials by the ton.

The following is a list of the scaleman's duties:

1. Check scale for zero at least twice during a day.
2. Tare each truck at least twice a day and enter on tare sheet.
3. Check the scales often and enter in diary.
4. Fill in appropriate spaces on each ticket.

#### Measurement by the Cubic Yard

Refer to Section 10-2.3A for instructions for measuring materials by volume, truck measure.



## 5-01 Cement Concrete Pavement Rehabilitation

### SS 5-01.1 *Description*

Rehabilitation of Cement Concrete Pavement is used to repair damage to the roadway, extend the life of the pavement, prevent further damage to the pavement, and to provide a smoother ride to the traveling public. The various types of rehabilitation each have specific methods and requirements for performing the work. The Project Engineer and the inspection team must be familiar with the specifications, Contract requirements, and techniques to be employed to accomplish the Work. In addition, all personnel must be familiar with and adhere to the traffic control plans.

Prior to beginning work, the Project Engineer must ensure that the Project Inspectors and Testers are properly qualified in the test procedures, are familiar with the testing requirements, and that the testing equipment is calibrated and available.

When saw cutting or diamond grinding is required, pay special attention to environmental requirements for the removal and disposal of concrete slurry.

### SS 5-01.3 *Construction Requirements*

#### SS 5-01.3(1)A *Concrete Mix Designs*

Concrete patching material is used for spall repair and dowel bar retrofitting and cement concrete is used for replacing cement concrete panels.

##### SS 5-01.3(1)A1 *Concrete Patching Materials*

**Materials** – Concrete patching materials will meet the requirements of *Standard Specifications* Section 9-20. The Project Inspector needs to inspect and document all prepackaged cementitious materials to ensure that they are properly labeled and that the Contractor mixes them to the correct proportions, as specified by the manufacturer.

##### SS 5-01.3(1)A2 *Cement Concrete for Panel Replacement*

**Concrete** – Cement Concrete mixes used in concrete panel replacement have to meet the requirements of Section 5-05.3(1) and 5-05.3(2).

The Project Inspector will:

- ensure the mix design has been accepted prior to use

and

- visually verify that the concrete delivery ticket has all required information and that the concrete is in compliance with the mix design.

Acceptance of the mix is verified on the grade by testing the air content and taking 28 day compressive strength cylinders for testing. Acceptance testing for air content and compressive strength is required to be performed once per shift. The rapid compressive strength gain of some proprietary concrete mixes makes taking air content tests difficult and the field test may be waived at the Project Engineer's discretion.

Concrete for panel replacement may come from a ready mix plant or mobile mixer. The Contractor is required to calibrate mobile mixers in the presence of the Project Engineer prior to use on the project.

### **SS 5-01.3(1)B Equipment**

The Project Inspector will verify that all equipment used by the Contractor is in good working order and can produce a panel to the correct grade and in compliance with the Contract Specifications.

### **SS 5-01.3(4) Replace Portland Cement Concrete Pavement (PCCP) Panel**

When a PCCP panel is damaged too severely, the only repair possible is replacement of all or a portion of the panel. This is accomplished by saw cutting and removing the PCCP panel and placing new PCCP, dowel bars and tie bars.

The Project Inspector must ensure that panels to be removed are laid out according to the Plans or as designated by the Project Engineer. All perimeter saw cuts must be full depth. To prevent damage to adjacent slabs that are to remain, a second full depth relief cut is required 6 to 18 inches inside the panel in both the transverse and longitudinal directions. If these full depth relief cuts are not made the energy imparted lifting out and/or breaking up the panel may be transmitted to the adjacent panels that are to remain and cause damage. Overcutting of panels in adjacent lanes that are to remain is not allowed for relief cuts and should be minimized for the perimeter sawcuts.

Once the panel has been removed, inspect the Subgrade material and the adjacent panels for any damage. Ensure that Subgrade is compacted to grade prior to placement of new concrete. Crushed surfacing base course or hot mix asphalt may be needed to provide a level and firm surface. This is already included in the standard bid price of the Work. If the material is not compactable, remove it, place geotextile and crushed surfacing base course as detailed in *Standard Specifications* Section 5-01.3(4)D at the Project Engineer's direction. Should the material need to be removed, this Work, as detailed in items 1 through 5 of the *Standard Specifications*, is to be paid by force account.

Ensure dowel bars and tie bars are placed in accordance with the plan and meet the requirements of *Standard Specifications* Sections 9-07.5 and 9-07.6. Collect Manufacturer's Certificate of Compliance documentation (and Certificates of Materials Origin on federally funded projects) for all dowel bars and tie bars prior to use on the project.

If new concrete pavement is to be placed against existing concrete pavement, epoxy-coated dowel bars shall be drilled and grouted into the existing concrete pavement. Tie bars are required whenever four or more concrete pavement panels in a row are placed next to existing pavement. Corrosion Resistant Dowel bars may be used in place of epoxy-coated dowel bars in panel replacements described in *Standard Specifications* Section 5-01. Verify that placement and tolerances of dowel bars and tie bars are in accordance with *Standard Specifications* Section 5-01.3(4).

Ensure that bond breaking material is properly installed so there are no folds or tenting that will result in voids under the concrete panel.

The position of dowel bars may be adjusted in order to avoid unsound concrete or an existing dowel bar. It may be necessary to cut back the face of the adjacent panel to reach sound concrete to install dowel bars.

Panels replaced should be the full width of the existing panel and at least 6 feet in length.

The lift-out method of removing panels is less likely to damage adjacent panels than a breakup and clean-out method. The Project Engineer should consider allowing alternative relief saw cuts patterns if the Contractor is using the lift-out method provided the alternative method does not damage adjacent panels. A relief saw cut is not necessary along edges of the panel that are not adjacent to cement concrete pavement such as when the concrete panel abuts an HMA shoulder.

A smooth uniform foundation is one of the most important factors affecting PCCP performance. Ensure that the panel foundation does not have excessive variation in elevation or soft spots.

### **SS 5-01.3(5) Partial Depth Spall Repair**

This work consists of removing and replacing a small portion of a concrete panel.

The Project Inspector must ensure that removal of existing pavement does not cause damage to any pavement that is to remain. The saw cut must be a minimum depth of 2 inches around the area to be removed. The saw cut area should be rectangular or circular and a minimum of 3 inches outside the area of spalled concrete. The pavement shall be removed to a minimum depth of 2 inches or to sound concrete as determined by the Project Engineer.

**Materials** – The concrete patching material needs to meet the requirements of *Standard Specifications* Section 9-20. Inspect and document all prepackaged cementitious materials to ensure that they are properly labeled and that the Contractor mixes them to the correct proportions, as specified by the manufacturer.

**Equipment** – Verify that all equipment used by the Contractor is in good working order, and meets the requirements of the Contract. Verify that jackhammers weigh no more than 30 pounds and chipping hammers weigh no more than 15 pounds.

#### **Spall Repair Checklist**

1. Ensure that quick setting concrete is placed and finished within the time limit set by the manufacturer.
2. Small repair areas that are less than 6 inches on a side and shallow spalls that will be removed by grinding are done at the Project Engineer's discretion.
3. Spall repairs that abut working joints or cracks require a compressible insert to reestablish the joint or crack. If the crack is not reestablished the patch material may delaminate or spall.
4. Check the area around the spall for delamination. If delaminated areas are found they should be included in the spall repair.
5. Limit spall repairs to  $\frac{1}{2}$  the thickness of the panel. Deeper repairs require a partial or full panel replacement.

**SS 5-01.3(6) Dowel Bar Retrofits**

Dowel bar retrofitting is used to ensure transfer of loads between adjacent roadway panels and is combined with pavement grinding to extend the service life of the pavement. This increases the stability of the roadway by restricting differential movement of the panels and reducing vertical movement. Dowel bar retrofits are accomplished by cutting slots in the pavement, placing dowel bars, and filling with concrete patching material.

The Project Inspector will verify that the slots are:

- located in accordance with the plan
- cut parallel to the centerline of the roadway and to each other
- centered over the transverse joint

All exposed surfaces and cracks in the slot must be sand blasted to a clean concrete surface. All grout residue and debris must be removed from the slot, using either an air compressor or, if allowed, a high-pressure water blast.

Ensure that dowel bars meet Contract requirements and are placed in accordance with the Plans. Foam core inserts shall be placed at the middle of the dowel, in line with the transverse joint, must fit tightly to the sides and bottom of the slot, and extend to the top of the existing pavement. It is important that the foam core inserts line up with the transverse joints. The top of the foam core insert will be removed when the joint is saw cut through the section. Transverse joints open  $\frac{1}{4}$  inch or more must be caulked to prevent patching material from entering the joint.

Concrete patching material shall be placed in the slots in a manner that does not disturb the dowel bar and to a level slightly above the level of the surrounding roadway.

Diamond grinding of the roadway surface is required within 10 working days of placement of the concrete patching material to provide a smooth surface.

**Materials** – The Contractor shall use concrete patching materials meeting the requirements of *Standard Specifications* Section 9-20. Inspect and document all prepackaged cementitious materials to ensure that they are properly labeled and that the Contractor mixes them to the correct proportions, and follows any placement restrictions, listed on the packages.

Ensure that dowel bars are placed in accordance with the Plans, and meet the requirements of *Standard Specifications* Section 9-07.5(1) or 9-07.5(2). Collect Manufacturer's Certificate of Compliance documentation (and Certificates of Materials Origin on federally funded projects) for all dowel bars prior to use on the project.

**Equipment** – Verify that all equipment used by the Contractor is in good working order, and meets the requirements of the Contract. Ensure that air compressors are of sufficient size and capacity to perform the work.

**SS 5-01.3(9) Portland Cement Concrete Pavement Grinding**

Diamond grinding of PCCP panels increases ride smoothness, reduces bumps following dowel bar retrofitting and increases the PCCP pavements life.

The Project Inspector will ensure that grinding begins within 10 working days of dowel bar placement and once begun, is a continuous operation until completed. Pavement shall be ground in a longitudinal direction removing a minimum of  $\frac{1}{8}$  inch from 95 percent of the surface to be ground.

If new cement concrete pavement is to be placed adjacent to rehabilitated cement concrete pavement, one pass must be ground along the edge of the rehabilitated pavement adjacent to where the new pavement will be placed. This will assure a smooth surface for the paving screed.

**Equipment** – Verify that all equipment used by the Contractor is in good working order, and meets the requirements of the Contract. Ensure the diamond grinder is of sufficient size and capacity to perform the work.

**SS 5-01.3(10) Pavement Smoothness**

Longitudinal surface smoothness of Cement Concrete Pavement grinding is accepted by the percentage of improvement when using the Mean Roughness Index (MRI).

The Contractor is responsible for providing the inertial profiler and operator used for smoothness testing. To ensure the profiler is accurate and the measured profile is repeatable, the inertial profiler must have been certified within the last 12 months and the operator must have been certified within the last three years. Inertial profilers will either be certified by a certification facility or by another state. Profilers certified by a certification facility are required to display a decal or other approved marking as evidence of certification and the certification expiration date. If the inertial profiler is certified by another state, the Contractor is required to submit documentation verifying the profiler certification. Contact the State Pavement Office to verify that the certification meets the requirements of AASHTO R 56.

The Contractor is required to collect a control profile of the existing pavement before any pavement rehabilitation work has started. Work such as panel replacement or spall repair will alter the MRI and make accurate determinations of the pre-existing MRI impossible. After completion of Work in the travel lanes the Contractor is required to collect an acceptance profile. Acceptance is based on the percentage improvement between the control profile and acceptance profile. There is no incentive or disincentive for MRI of cement concrete pavement grinding. The Contractor is required to perform corrective action if the MRI does not meet requirements. If the Project Engineer determines that corrective action does not or will not produce a satisfactory result the pavement may be accepted with a credit in accordance with Section 5-01.5.

The Contractor is not responsible for cracks in the existing roadway and dips that are too deep to remove by grinding and 0.01-mile sections with these deficiencies are excluded from the MRI analysis. Tenth mile sections should also be excluded if they contain more than three 0.01-mile sections with these types of deficiencies. However; individual 0.01-mile sections that did not have deficiencies must still meet the 160 inches/mile requirement for 0.01-mile sections even though they are in the excluded 0.10 section.

## 5-02 Bituminous Surface Treatment

### GEN 5-02.1 General Instructions

Bituminous Surface Treatment (BST) construction proceeds very rapidly and it is very important that the Project Inspector be entirely familiar with the specifications and methods applicable to the Work. If the Work begins without proper preparation and planning, it is entirely possible that a major portion of the job will be completed before correction of any improper methods or procedures can be made. Project Inspectors should thoroughly review *Standard Specifications* Section 5-02, the Plans and the Contract Special Provisions well in advance of BST construction.

Carefully review *Standard Specifications* Section 5-02.3(10) concerning unfavorable weather and calendar cutoff dates well in advance of any bituminous paving work. In no case should bituminous surface treatments be placed before May 1 or after August 31 of any year except upon written order of the Project Engineer.

To correct the volume of the material to 60°F, the Project Inspector may use 240 gallon per ton at 60°F for all grades of emulsified asphalt.

When payment for asphaltic materials is by the ton, they should be measured by weighing. When it is impractical to weigh the materials, the quantity of asphaltic material used may be measured by the gallon and the number of gallons converted to tons with the appropriate temperature volume correction.

### GEN 5-02.3 Inspection and Sampling of Materials

**Emulsified Asphalt** – Each shipment of emulsified asphalt arriving on the job by tank truck shall be inspected and must have a Certification of Shipment. The tank must be inspected after it is unloaded to see that no emulsified asphalt remains in the tank.

The Project Inspector must check and record the temperature of each load of emulsified asphalt as it is delivered to the roadway for spreading.

Samples of the emulsified asphalt shall be taken as required in Section 9-4.2, and shall be submitted to the State Materials Laboratory for Testing.

**Aggregates** – No aggregate shall be used without the acceptance of the State Materials Laboratory. If any question arises concerning quality of the material, a sample shall be sent to the State Materials Laboratory for testing before use and preferably during plan preparation.

### GEN 5-02.4 Miscellaneous Inspection Duties

**Control of Traffic** – Make frequent checks of traffic control operations to see that traffic is being conducted through the job in a safe, orderly manner. When spreading emulsified asphalt, traffic should not be allowed to travel past the distributor. Control of the speed of traffic is very important, especially during the early curing stage of the asphalt, to ensure the aggregate covering the asphalt is disturbed as little as possible. Control of traffic must be maintained as long as required to prevent excessive loss of the aggregate. The Project Inspector must ensure that all warning signs are properly in place throughout construction.



**Maintenance and Finishing Roadway** – The Project Inspector shall see that the newly completed roadway is properly maintained until brooming is completed. The Contractor shall be required to keep sufficient equipment on the job to adequately handle any situation that may develop, including application of a fog seal or additional emulsified asphalt or aggregates if deemed necessary by the Project Engineer per SS 5-02.3(6). Before the Work is accepted, the Contractor is required to finish the roadway and clean up any debris resulting from their operations, as required in the *Standard Specifications*.

**Measurement of Stockpiles** – Before construction begins, measure and compute quantities from stockpiles that will be utilized for materials. Upon completion of the Work, the Contractor shall be required to leave the remaining materials in neat, presentable stockpiles. The stockpiles shall again be measured and quantities determined. The difference in quantities obtained by this procedure will aid in checking pay quantities determined by truck volumes. It will also serve as an accurate basis for reporting quantities withdrawn from stockpiles. Measurement of stockpiles will not be necessary on projects where the aggregate is furnished by the contractor.

**Notice to Maintenance Superintendent** – The Project Engineer should keep the area Maintenance Superintendent informed of the Contractor's proposed progress schedule so that maintenance operations can be coordinated to accommodate the construction work. The Project Engineer must also notify the Maintenance Superintendent of the date when the Contractor's maintenance period will expire so that maintenance of the roadway may be taken over by WSDOT and maintained without interruption. These notices should be given sufficiently in advance to enable the Maintenance Superintendent to provide equipment and organize the work.

### **GEN 5-02.5 Reports and Records**

A Daily Report of BST Operations (DOT Form 422-644) shall be completed by the Project Inspector at the end of each day's work, showing type of work, areas treated, quantities used, etc. This report shall be submitted in duplicate for the Project Engineer and Region.

Records of quantities of emulsified asphalt and aggregate used shall be kept in the Inspector's Daily Report, and shall be checked daily against quantities shown on tickets issued to the Contractor. Accurate, neat records are invaluable to the Project Engineer in preparing estimates and final records. See Section 10-2 for instructions concerning quality control procedures.

The Project Inspector shall include all pertinent information concerning each day's Work in the Inspector's Daily Report.

### **SS 5-02.3 Construction Requirements**

#### **SS 5-02.3(1) Equipment**

**Inspection Tools and Equipment** – Before construction begins, the Project Inspector shall ensure all equipment necessary to carry out the inspection duties is available and on-site. This equipment shall include air and asphalt thermometers, a device to measure surface temperature, wind gage, sieves and scale, tapes and rules, canvas sample sacks, containers for sampling asphalt, notebooks, ticket books and diary book.

**Inspection of Contractor's Equipment** – Prior to construction of the bituminous surface, inspect the Contractor's equipment. Check to see that all required equipment is available, in good condition, and is properly adjusted.

Carefully check the asphalt distributor to ensure that it meets the requirements of the Specifications. Verify the capacity of the distributor, and ensure that the volume gauge is calibrated to correctly indicate quantities in the tank.

Special attention should be given to the condition and adjustments of the asphalt pump, spray bar and spray nozzles. The nozzles should be set uniformly at the proper angle from the axis of the spray bar, normally 15 to 30 degrees, to eliminate interference of the sprayed material from one nozzle with that from an adjoining nozzle. Each nozzle should be set at the same angle. The height of the spray bar must be checked to see that the correct overlap of the spray from each nozzle is obtained. This can be accomplished by plugging alternate nozzles and adjusting the height of the spray bar until the edges of the spray fans from the unplugged nozzles just meet at the roadway surface. When all nozzles are spraying, an exact coverage of emulsified asphalt will be obtained, resulting in an application of emulsified asphalt free from longitudinal streaking.

The asphalt pump must be checked to ensure that the manufacturer's required pressure can be maintained uniformly.

The Project Inspector must check the motor patrol graders, rollers, spreader boxes, etc., to ensure that they are in good operating condition, and that the motor patrols are equipped with the required moldboard brooms. Determine the capacity of hauling trucks and water tanks from measurements obtained on the job, and record the results for future reference.

### **SS 5-02.3(2) Preparation Of Roadway Surface**

#### **SS 5-02.3(2)A New Construction**

The roadway surface shall be shaped and compacted to a smooth, uniform grade and cross-section before application of the emulsified asphalt. If possible when setting grade, do not place stakes, hubs, etc. in the roadway, as this may cause faults in the finished surface. If stakes or hubs must be placed in the roadway in order to set the grade, these stakes or hubs must be removed and the void filled and compacted prior to placement of the surface treatment. No traffic will be allowed on the prepared surface until the first application of asphalt emulsion and aggregate is applied. It is essential that the grading of the surfacing material be uniform over the area to be treated to allow uniform penetration of the emulsified asphalt. This is different work than that associated with shaping and compacting of crushed surfacing as required in *Standard Specifications* Section 4-04.3(5). The quality and smoothness of the finished roadway depends to a great extent on the quality of the work done in preparing the roadway. Careful inspection during this operation will lay the groundwork for a smooth riding and uniform appearing finished project.

In many instances, the surfacing course upon which the bituminous surface treatment is to be placed will be segregated, rutted and pot-holed by traffic using the roadway prior to oiling. Such a surface must be completely processed to the depth of the ruts or potholes, and re-laid. Do not allow the Contractor to merely lightly blade the surfacing course, filling the holes with loose, segregated material. Such procedures are sure to result in a rough uneven pavement, due to differential compaction and penetration.

*Do not allow the Contractor to merely lightly blade the surfacing course, filling the holes with loose, segregated material. Such procedures are sure to result in a rough and uneven pavement, due to differential compaction and penetration.*

The surfacing must be damp, bladed, and thoroughly rolled to obtain a dense, unyielding base for the bituminous surface treatment. If additional water is required, it shall be applied in the amount and at the locations designated by the Project Inspector. The final coverage must be with a steel-wheeled roller to produce a smooth surface upon which to apply the first application of emulsified asphalt. The blading and rolling of the surfacing shall be coordinated so the emulsified asphalt will be applied while the surfacing material is still damp. If the surfacing material compacts to a very tight surface, the emulsified asphalt will not penetrate as much as if the material is more open. If this is the case, the Project Inspector should ensure that the top coat of emulsified asphalt is not applied too heavy.

### **SS 5-02.3(2)B Seal Coats**

- **New Construction** – The surfacing needs to be dampened, trimmed, and rolled to provide a uniform grade and cross section according to the plans. Surface soft spots need to be excavated and repaired with the same type of surfacing material. The amount of water applied needs to be the optimum amount necessary to tighten the surfacing enough to minimize its porosity and absorption of the first application of emulsified asphalt. Traffic should not be allowed on the prepared finished surfacing.
- **Existing Roadway** – Prior to the first application of emulsified asphalt, the Project Inspector shall ensure that the existing surface is broomed clean and that holes and breaks are patched as required. Inspect the existing surface carefully over the length of the job, noting the surface characteristics of the roadway, so that the rate of application of emulsified asphalt best suited to the conditions can be determined. Document varying conditions and plan to vary the application of emulsified asphalt accordingly.

Areas of the roadway showing failure caused by soft Subgrade or poor drainage must be removed to correct the cause of the failure.

Open or porous paved surfaces, particularly on recently constructed bituminous pavements found in the area to be treated, the Project Inspector shall require the application of a fog seal to be applied before construction of the seal coat. If fog seal is not shown on the Plans, inform the Project Engineer so that a supplemental agreement may be reached with the Contractor.

The Project Inspector is responsible to see that a newly constructed bituminous surface be allowed the required time for curing before allowing construction of the seal coat over the affected area.

### **SS 5-02.3(3) Application of Emulsified Asphalt and Aggregate**

The Project Inspector shall require that the Contractor provide a minimum 1,000-foot test strip to verify that the Contractor's equipment is functioning according to specification.

Building paper shall be placed at the joint, each time the distributor starts, in a manner that assures a uniform asphalt emulsion spread across the area of the joint.

During the application of the emulsified asphalt, maintain a close inspection of the roadway to see that the emulsified asphalt is applied in a uniform manner. Longitudinal joints will be allowed only at the centerline of the roadway, the center of the driving lanes, or the edge of the driving lanes. If evidence of improper application is apparent, the operation must be stopped to make required corrections. Check to see that the asphalt pump pressure and the speed of the distributor are maintained at uniform rates to ensure

even application of the emulsified asphalt. A record shall be made of each distributor load applied, showing area treated, gallons spread, temperature of emulsified asphalt, etc. The Project Inspector should compute the yield of each spread in gallons per square yard depending on diluted or undiluted emulsified asphalt.

Part of the first application of emulsified asphalt applied to the surfacing penetrates the material and the rest remains on the surface and surrounds the aggregate. Constant checking is necessary to ensure that enough emulsified asphalt is applied to fill the voids and adhere to the aggregate. Conditions may change during the day due to weather or the preparation crew's efforts to stay ahead of the oiling crew. Some bleed can be tolerated on the first application as it can be corrected on the second application if uniform in nature. The final mat will be thicker and better if the optimum amount of emulsified asphalt is used, without excessive bleed, on the first application.

Stockpiled aggregate shall be inspected to ensure that the grading of the material meets specification, and to verify that it is damp at the time of loading onto trucks for hauling to the roadway. If dry or dusty, the material in the stockpile must be watered to produce a damp surface condition. The emulsified asphalt does not readily coat a dry dusty surface. During warm weather, the moisture on the surface of the aggregate will quickly evaporate after the aggregate is spread and the emulsified asphalt is applied to the roadway.

The Project Inspector must frequently check the truckloads of aggregate at the point of delivery, to verify that the trucks are completely loaded and that the material is damp. Tickets shall be issued for each load of material received or a receiving report record made as the loads of material are received. A record shall be made of the quantities of material used on each section.

Following the application of emulsified asphalt, the Project Inspector is responsible for ensuring that the aggregate is applied in accordance with the specifications. The aggregate needs to be applied at the correct rate within the allotted time limit. The roadway shall be inspected for signs of skips or omissions in the application of the aggregate. Any omissions shall be immediately covered by re-spreading with the chip spreader or by hand-spotting methods. Do not allow excessive amounts of aggregate to be applied, as this will result in waste of the material and require harmful excessive brooming.

Careful inspection and control of the rolling operation must be made to ensure that the requirements of the specifications are met. It is important that rolling be conducted as soon as possible following application of the aggregate in order to properly imbed the aggregate in the asphalt. Adequate rollers must be present to provide complete coverage without excessive speeding and abrupt starting/stopping motions.

Chips are broomed once the emulsified asphalt cures enough to adhere the chips to the roadway. Brooming is necessary to prevent wheel tracking promoted by loose aggregate on the roadway. Areas of severe bleeding will need to be blotted with ¼-inch material during the cure period. Emulsified asphalts do not really cure except for water evaporation when they break. The constructed area will be tender, although probably ready for the next construction step.

When the asphalt has set, adhesion has developed and the chances of bleeding are remote.

The excess aggregate on the edge of the roadway shall be broomed off as it is a hazard to traffic and reduces the usable width of the roadway.

### **SS 5-02.3(5) Application of Aggregates**

#### **Construction of Seal Coat**

When constructing a seal coat, the emulsified asphalt thickness is critical to ensure the layer of aggregate placed on the emulsified asphalt is covered appropriately. Constant checking is required to ensure that embedment of the major stone in the asphalt is 50 to 70 percent. When ½-inch to No. 4 chips are used on routes with moderate traffic volumes, choke stone may be used either ahead of or immediately behind the main rollers. Some bleed is inevitable at intersections, on steep hills, and at severe horizontal or vertical curves. This is preferable to losing rock on long sections in between, due to insufficient emulsified asphalt being placed.

Continuously inspect the aggregate application on the freshly spread emulsified asphalt, to ensure that the material is placed within the time allotted, to ensure the spread of emulsified asphalt is not extended beyond the area which the Contractor can cover.

Omissions or skips in the spreading of aggregates must be immediately covered by re-spreading with the chip spreader or by the hand spotting crew.

The best seal coats are obtained on those jobs where the time elapsed between spreading of asphalt and application of aggregates is held to the time allotted.

The Project Inspector must ensure that the rolling operation is not allowed to lag far behind the spreading of aggregates. It is important that the aggregate be rolled into the asphalt film as soon as possible following application.

**Spreading Choke Stone** – When constructing Bituminous Surface Treatment Seal Coats, the specifications may require application of choke stone following the spreading and rolling of the coarse aggregates. The Project Inspector must exercise judgment in determining the time for applying the choke stone. When using emulsified asphalt, the choke stone should be applied immediately, sometimes even before initial rolling.

Choke stone, applied at the proper time, will key the gaps between the particles of coarse aggregate and provide a smoother riding surface, as well as absorb any free asphalt which might bleed to the surface of the coarse particles.

By observing conditions and results carefully, the experienced inspector will determine the procedure which produces the best results under any particular condition.

If the sealed roadway is rained on before the asphalt has cured and the asphalt starts to emulsify under the traffic, the roadway can usually be saved from damage by applying choke stone on the roadway to prevent the traffic from picking up the asphalt. Refer to the Spill Prevention Control and Countermeasures Plan (SPCC plan) for guidance on using Best Management Practices (BMPs) to protect the environment.

### **SS 5-02.3(9) Protection of Structures**

When spreading emulsified asphalt or aggregate near curbs, bridge rails, drainage inlets, monument covers or other structures, adequate protection must be provided to prevent damage to the structures. The Project Inspector shall see that any emulsified asphalt sprayed, or aggregate spread, on or in a structure is satisfactorily removed by the Contractor.

## **5-03 Crack and Joint Sealing**

### **GEN 5-03.1 General Instructions**

Crack sealing is one of the most cost-effective methods of pavement preservation. Joint sealing is required anywhere there is a joint including between different surface types, at bridge ends, and between PCCP panels. Joint sealing helps restrict the infiltration of water into the Subgrade and prevents incompressible material from entering the joint causing spalling when the joint closes up during warmer conditions.

The Project Inspector should ensure the proper material has been selected for the application. For bituminous pavements the material must follow the selection table in SS 5-03.3(2)A. Material selection depends on whether the sealant is used in a crack or a joint. Furthermore, if sealing cracks, there are different materials depending on the size of the crack and if there will be any additional surfacing materials placed over the crack after sealing. Placing Hot Mix Asphalt over the top of a crack sealed with Hot Poured Sealant can cause bumps. Different types of crack and joint sealant material are required for use with Cement Concrete Pavements; see SS 9-04.2.

A properly constructed crack or joint seal will adhere to the sides of the crack or joint and flex with the thermal expansion and contraction of the pavement. To ensure proper adhesion the crack or joint will be properly prepared in accordance with SS 5-03.3(1)B and the Work should be done under the proper weather conditions, see SS 5-03.3(1)A. Review the Standard Specifications and manufacturer's installation instructions to identify any additional weather or preparation requirements specific to the material being used and the type of pavement being sealed, and the handling, heating, and storage requirements.

When filling cracks or joints the Project Inspector should be aware that in some situations the sealant may settle requiring the Contractor to return to top off the sealant material. The sealant material should also be confined to the crack or joint minimizing any sealant on the pavement surface. Hot Applied Joint Sealants often remain tacky after placement. When the cool tires roll over the hot HMA mix, the mix tends to stick to the tires, and is "picked" up from the mat on to the tires. Project Inspectors should watch for picking when the pavement is opened to traffic.

## 5-04 Hot Mix Asphalt

### GEN 5-04.1 General Instructions

The technology of asphalt materials and mixes is continuously changing, and this in turn drives changes to the Contract Specifications. It is imperative to study Contract documents and Specifications prior to the start of any paving Contract. There also are many excellent handbooks that can be obtained to assist paving Inspectors and testers. It is recommended that the Project Engineer obtain copies of these handbooks as a resource for their office. Recommended books include “Hot Mix Asphalt Materials, Mixture Design and Construction” by the National Center for Asphalt Technology and “Construction of Hot Mix Asphalt Pavements (MS-22)” by the Asphalt Institute.

Good work and a successfully completed job depend on good equipment, skillful operation of the equipment, competent, knowledgeable supervision and inspection, and open lines of communications. Maintaining open lines of communication through informal daily meetings between the Inspector and Contractor can greatly improve the success of any job.

Hot mix asphalt (HMA) projects are not always built as originally scheduled. Changes may occur because of problems with material supply, equipment breakdown, Contractor and Subcontractor schedules, and weather conditions. Informal meetings on a regular basis provide a forum for the exchange of information and discussion of problems. To begin the communication process a prepaving meeting is recommended. The Project Engineer, paving Inspectors and testers together with the paving superintendents and paving foremen should be present to go over all activities and plan the entire operation. It is also advisable to include the Traffic Control Supervisor (TCS). The following checklist may be used as an outline for the prepaving meeting:

#### Prepaving Checklist

1. Review the HMA Contract requirements with the Contractor to include:
  - a. HMA class
  - b. Grade of asphalt binder
  - c. Evaluation and acceptance procedures
  - d. Mix design being approved on the QPL
  - e. Mix design submittal for approval to use on the Contract
  - f. Mixture test section (HMA mixture if required or requested)

If an HMA additive that reduces the optimum mixing temperature or serves as a compaction aid for producing HMA is proposed the Contractor is required to submit the request on Form 350-076 (*Standard Specifications* Section 5-04.2(2)B)

2. Review procedures in *Standard Specifications* Section 5-04.2(2)A for modifying the job mix formula (JMF)
3. Discuss construction of HMA mixture test section (*Standard Specifications* Section 5-04.3(9)A)
4. Discuss the communication procedure to be used for weather shut downs and other potential construction problems

5. Review what type of material transfer equipment (vehicle or device) the Contractor plans on using
6. Discuss testing for low cyclic density (*Standard Specifications* Section 5-04.3(10)B) and what to do if segregation of the mix is occurring
7. Discuss the preparation of the existing paved surfaces (*Standard Specifications* Section 5-04.3(4)) including cleaning the pavement, application of tack, pickup problems, weather limitations (*Standard Specifications* Section 5-04.3(1), crack sealing (*Standard Specifications* Section 5-03), and pavement repair (*Standard Specifications* Section 5-04.3(4)C)
8. Discuss aggregate sampling and testing requirements (*Standard Specifications* Section 5-04.3(8) and 3-04
9. Mixture sampling and testing:
  - a. Who and how (*Standard Specifications* Section 5-04.3(9)),
  - b. When (*Standard Specifications* Section 5-04.3(9)B1)
  - c. Notification of mixture acceptance test results (*Standard Specifications* Section 5-04.3(9)E)
  - d. Mixture acceptance pay factors (*Standard Specifications* Section 5-04.3(9)B4)
  - e. Mixture acceptance Composite Pay Factors (CPF) (*Standard Specifications* Section 5-04.3(9)B5)
  - f. Mixture acceptance price adjustments (*Standard Specifications* Section 5-04.3(9)B6)
  - g. Contractor requests for mixture sublots to be retested (*Standard Specifications* Section 5-04.3(9)B7)
10. Review the requirements for the Contractor to maintain a CPF greater than 1.00 for aggregates in 3-04.3(7)D3, and for mixture and compaction in 5-04.3(11)F. The intent of these particular Specifications is to maximize the likelihood that WSDOT will receive all materials and all compaction at CPF's and pay factors of 1.00 or greater. This requires the Paving Inspector and Contractor to evaluate the updated CPF and pay factors every time a test on aggregate, mixture, or compaction is completed. When the CPF and pay factors fall below threshold values of 1.00, 0.95, or 0.75, the Contractor must immediately take the actions described in the Specification. The need for the Contractor and Paving Inspector to be made immediately aware of the changing CPF and pay factors after each test reinforces the need for the test results to be processed into the Materials Testing System (MATS) and the Statistical Analysis of Materials program (SAM) within 24 hours.
11. Review sampling of the asphalt binder, the maximum recommended temperature for heating the asphalt binder and the maximum allowable temperature for discharge of the HMA (*Standard Specifications* Section 5-04.3(3)A item 3 and 5-04.3(6) respectively) for the type(s) of asphalt binder being used on the Contract. The Contractor will supply the information from the manufacturer of the asphalt binder.
12. Review the procedure and timing in obtaining density gauge correlation factors



13. Review Contract requirements for asphalt densities:
  - a. When (*Standard Specifications* Section 5-04.3(10)C1)
  - b. Who and how (*Standard Specifications* Section 5-04.3(10)C2)
  - c. Notification of compaction test results (*Standard Specifications* Section 5-04.3(1)F)
  - d. Contractor requests for cores and utilization of core results (*Standard Specifications* Section 5-04.3(10)C4)
14. Review construction of transverse joints (*Standard Specifications* Section 5-04.3(12)A), and longitudinal joints including the notched wedge joint and when/where it will be required (*Standard Specifications* Section 5-04.3(12)B)
15. Traffic control procedures and lines of communication including allowable times for lane closures
16. Other factors specific to Contract or of concern by those attending

In the construction of HMA, it is extremely important that the material meets all requirements of the Specifications. It should be remembered that Specifications are not arbitrarily arrived at, but have evolved through the years as a result of experience and research.

Experience has shown that pavements that do not meet all Specifications will not perform satisfactorily, resulting in high maintenance costs and reduced service life. The responsibility for obtaining a mixture in close conformance with the Contract mix design and meeting the Specification requirements rests with the Contractor. The importance of this cannot be overemphasized, since the best possible construction at the lowest cost to WSDOT cannot be obtained unless the mixture produced at the plant is uniform and of good quality. One of the key words used to describe quality production of HMA is UNIFORMITY.

- The aggregate in the stockpile must be of UNIFORM quality and gradation.
- Aggregate must be fed into the plant in a UNIFORM, controlled manner.
- The heating and drying of the aggregate must be UNIFORM.
- The separation of the aggregate in the bins must be UNIFORMLY controlled.
- The aggregates and asphalt must be combined and mixed in a UNIFORM, consistent manner.

In order to achieve this uniformity, it is necessary that the entire operation be conducted so that each phase of the production operation is in balance with all other phases. To accomplish this most Contractors have a Quality Control (QC) program.

With the advent of Quality Assurance (QA) Specifications and statistical evaluation of HMA, the role of inspection has evolved from one that was highly involved in the operation of the asphalt plant to one that is involved in verification that the material the Contractor produces is in conformance with the JMF and in accordance with the Specifications.

An Inspector's Daily Report must be kept, showing all instructions received from the Project Engineer and instructions issued to the Contractor.

Careful review of *Standard Specifications* Section 5-04.3(1) concerning weather limitations and calendar cutoff dates should be made in advance of any HMA paving so the Work can be planned and completed prior to any unfavorable weather. Pavement performance

is highly dependent on the weather conditions in the first weeks and months following paving. Invariably, when these Specifications are not closely adhered to, early pavement performance problems occur. Therefore, beginning October 1 of any year through March 31 of the following year, no wearing course is to be placed without written authorization of the Project Engineer. The Project Engineer will review this decision with the Region Construction Office prior to allowing any paving outside these dates.

In addition, use of a pneumatic tired roller is required from October 1 through March 31 (*Standard Specifications* Section 5-04.3(10)A). It has been shown that during warmer weather, traffic will knead the HMA providing a more durable pavement. To duplicate this benefit for late season paving, use of pneumatic tired rollers is part of the Specifications.

Placement of HMA less than 0.10 feet or less is not recommended for surface temperatures less than 55°F for wearing course and 45°F for other courses (*Standard Specifications* Section 5-04.3(1)). Heat loss in thin lifts is very quick and in most cases inadequate time is available for placement or to achieve needed compaction.

A word about the writing style used in Section 5-04:

For those parts of *Standard Specifications* 5-04 which tell the Contractor what to do, the writing style, beginning with the February 2016 Amendments, is different from the rest of the *Standard Specifications*. Referred to as “active voice, imperative mood”, this style is more “directive” in its tone, and has been adopted as the writing style of preference for all Contract Specifications by AASHTO and FHWA. It is used in Section 5-04 on a trial basis to see how well it is received and understood by users, including industry and Inspectors. If well enough received, it may be adopted as WSDOT’s standard style for writing Contracts.

## **SS 5-04.2 Materials**

Mix design approval involves two steps - (1) approval on the QPL, and (2) approval for use on a particular Contract.

### **SS 5-04.2(1) How to Get an HMA Mix Design on the QPL**

The process for getting a mix design approved for listing on the QPL does not involve the Project Engineer’s office. This is because the process occurs outside of any construction Contract. The HMA producer works directly with the State Materials Laboratory in all aspects of this process. Refer to SS 5-04.2(2).

If the HMA producer’s proposed mix design is approved for listing on the QPL, the State Materials Laboratory will assign a mix ID number (a unique identification number) that has “MD” as its prefix. The “MD” prefix indicates the associated mix design is the original mix design approved by the State Materials Laboratory, and therefore does not include any changes to the JMF which are allowed under SS 5-04.2(2)A.

## SS 5-04.2(2) Mix Design - Obtaining Project Approval

The Contractor is required to use a QPL approved mix design for the HMA that meets the requirements of the Contract. After identifying the mix design it intends to use from the QPL, the Contractor submits WSDOT Form 350-041 to the Project Office. The Project Office then requests approval for using the proposed mix design on its Contract by completing an HMA mix design submittal using the MATS program.

**Note:** It is extremely helpful to the State Materials Laboratory, when evaluating the mix design approval request, for the Project Office to make sure to convey the correct Specification year of the HMA required by the Contract. This is when the acceptance settings are first established in SAM for both mixture and compaction for that mix design on your Contract. If the Contract requires something other than an exact match of a Specification year for any of the items in the table in *Construction Manual* Section GEN 5-04.3(9)B3, contact the Assistant State Construction Engineer (ASCE) or the State Materials Laboratory, Bituminous Testing Engineer, at the same time the mix design approval request is submitted.

The State Materials Laboratory will evaluate the mix design approval request and respond to the Project Office. If approved, the mix design prefix will change from MD to RD, indicating "reference design".

Each approved HMA mix design will be listed on the QPL for 24 consecutive months.

The Contractor may propose a mix design that does not meet the Contract requirements, which would require an approved Change Order. (See the table below for information regarding HMA mix design Change Orders)

### Change Order Approval Process for HMA Mix Design Substitutions

1. Purpose: Consistent approvals throughout the state (HQ, Region and PEO),
2. Use correct materials to ensure performance,
3. Consistent with the cost associated with change orders,
4. Avoid unintentional precedents and potential unfair bidding advantage,
5. Involve the right people in the approval process.

### HMA Mix Design Change Order Approval Process

Change orders allow substitution, but do not guaranty HMA mix design approval.

Questions that need to be answered before processing a change order:

1. Does the plan HMA tonnage exceed 1,000 tons? If yes, stop and do not proceed with HMA mix design substitution.
2. What Class, ESAL level (gyration) and grade of binder does the Contract require?
3. What Class, ESAL level (gyration) and grade of binder is being proposed?
4. Are there any Special Provisions that need to be considered?
5. Where is the HMA to be placed? Is it structure, leveling, repair, etc.?
6. What is the risk of using a mix design that does not meet the Contract requirements? (Pavements & Materials)
7. How much time has the Contractor had between Award and Proposal of Change Order?
8. What is the anticipated date of paving?

**Unacceptable Change Order Criteria:**

1. A Contract that specifies a 100 gyration (> 3 mil. ESAL) asphalt mix design and a proposed change to use of a 75 gyration (< 3 mil. ESAL) mix design.
2. A Contract that specifies a PG “V” grade binder and a proposed change to use of a PG “H” grade asphalt binder.
3. Modifications to an approved QPL mix design such as increase or decrease to the binder content, require a test section, etc.
4. HMA Contract plan quantities exceed 1,000 tons.

**Potentially Acceptable Change Order Criteria:**

1. A Contract that specifies a 75 gyration (< 3 mil. ESAL) asphalt mix design and a proposed change to use of a 100 gyration (> 3 mil. ESAL) mix design.
2. A Contract that specifies a PG “H” grade binder and a proposed change to use of a PG “V” grade asphalt binder.
3. HMA Contract plan quantity of 1,000 tons or less.

**Who to contact in determining if a Change Order is acceptable?**

1. Project Engineer, Region Materials Engineer and HQ Construction Office; need to discuss what the Contract requires and the proposed change to the Contract?
2. Consult Pavement Design for pavement structure assessment to determine if proposed mix design is acceptable?
3. Consult Construction Materials for mixture specific details on proposed HMA mix design questions and to assist with determining if the proposed material change will meet performance and service life criteria.
4. If the answers to any questions 1 – 3 are No, or concerns are identified:  
The Contractor needs to use an approved mix design that meets the original Contract requirements.
5. If the answer to all the three questions above are yes:  
Then a Change Order could be processed to allow the alternative mix design from the QPL.

**SS 5-04.2(2)A Mix Design - Making Adjustments to the JMF**

During HMA production it may be necessary to make adjustments to the JMF to improve workability, compactibility, and volumetric properties ( $V_a$  and VMA). *Standard Specifications* Section 9-03.8(7) Sub-Section 2, defines the maximum adjustment allowed for aggregate and the asphalt binder content that can be approved by the Project Engineer. These adjustments can be made at the request of the Contractor and approved by the Project Engineer, provided the change will produce material of equal or better quality. The Project Engineer should consult the State Materials Laboratory or ASCE to confirm that the Contractor’s proposed JMF change will indeed provide equal or better quality, before approving the proposed change.

Adjustments to aggregate gradation and asphalt binder content beyond the limits defined in *Standard Specifications* Section 9-03.8(7) may be allowed only with approval by the State Materials Engineer.

During construction, guidance for adjustments is provided through the use and interpretation of the compaction control and mixture test results.

The Contractor's plant operator must be advised of all results of sampling and testing performed.

### **GEN 5-04.2 Inspector Roles and Responsibilities**

**Testing Equipment** – Before the production of HMA commences, the Inspector needs to ensure that all of the equipment needed to accomplish all of the test procedures has been obtained. In addition, qualified testers using calibrated or verified equipment are required. The Inspector needs to make sure that this equipment is in good working order and has a current calibrated or verified sticker on it, and that all tester qualifications are current.

The Inspector is charged with responsibility for care and safekeeping of all testing equipment that is issued. The equipment must be maintained in a clean and proper operating condition to ensure accuracy of test results. Special care must be exercised in the use and maintenance of sieves to see that they do not become clogged or damaged. Thermometers must be handled carefully to avoid breakage.

Electronic scales are expensive and delicate equipment. Particular care should be taken to protect them from theft or voltage spikes.

The ignition furnace is a high temperature oven, so care must be exercised in its operation and testers must be qualified in its use.

Given reasonable care, HMA testing equipment will give long and satisfactory service.

**Required Tests** – The Inspector is responsible to the Project Engineer for the required field tests as well as for submission of required samples to the State Materials Laboratory for testing. Testers must be qualified in the "Asphalt Module" or for the particular method of sampling and testing they will be performing. The QA Specifications intend for the Contractor to be totally responsible for the maintenance and operation of equipment and the production of the HMA. It is the Inspector's role to direct the Contractor when to take samples and observe the Contractor taking the samples while the Inspector performs the tests. However, it is not possible or desirable for the Inspector to take a "hands off" approach to the production of HMA. If the Inspector notices anything at all that affects the quality of the HMA, this information should be brought to the Contractor's attention in a cooperative manner so the situation can be corrected.

Notifying the Contractor of Test Results - Sections 5-04.3(9)E and 4-04.3(10)F of the *Standard Specifications* address how and when we are expected to provide the Contractor with official acceptance test results for mixture and compaction. We must do our best to get the results into SAM within 24 hours of receiving the sample from the Contractor, then the SAM program will email the test result to the Contractor if the Contractor has requested the email service. The intent of these Specifications is to be both correct and timely. The State Construction Office has no objection to providing unofficial test results to the paving Contractor as soon as the field test is complete, when so requested.

When providing preliminary test results to the Contractor before they have gone through the checks and approvals of MATS and SAM, remind the paving Contractor that the results are preliminary and therefore unofficial and, when appropriate, acceptance is by statistical evaluation.

The email to the Contractor mentioned above requires the Contractor to send a written request to the Project Engineer identifying the name of its designee and email address. Then, the Project Engineer's staff input the email address of the Contractor's designee

into SAM. For questions on how to make this happen in SAM contact the IT Help Desk at the State Materials Laboratory. Furthermore, because the information input into SAM is the official basis of notification and acceptance, it is critical that the data be input correctly, checked and done in a timely manner.

### **GEN 5-04.3 Street Inspection**

**General** – In the construction of HMA pavements, it is the responsibility of the Street Inspector to see that construction methods and equipment used, as well as the finished pavement, meet the requirements of the Specifications. In order for the Street Inspector to properly discharge this responsibility, it is necessary that the Street Inspector thoroughly understand the *Standard Specifications*, the Special Provisions of the Contract, and the instructions set forth herein. The Street Inspector must also have a good working knowledge of methods and equipment involved in the construction of HMA pavements.

A means of communication between the Street Inspector and the Plant Inspector must be established, and the Street Inspector must keep the Plant Inspector informed of any difficulties encountered in the placement or compaction of the mixture or of any faulty mixture received at the paving site.

**Street Inspector's Checklist** – Some of the most important details of inspection on HMA paving are listed below:

1. Check condition and adjustment of paving machines and rollers before and during operation to verify no tearing or pickup of the mat.
2. Has width of spread in successive layers been determined to ensure joints are covered?
3. See that traffic control is organized and functioning properly; make sure required signs are in place and document it.
4. Check application of tack coat and do not allow tacking of more base than will be paved each day. Be sure the pavement is swept and clean ahead of the tack application (*Standard Specifications* Section 5-04.3(5)A). The tack coat should be broken and cured prior to allowing construction traffic on it, and must be broken and cured before HMA is placed on it. Remember that proper application of tack coat is essential to long life for the pavement.
5. Examine the pavement base, and verify that all required patching and/or pre-leveling is completed. Verify the planned surfacing depths before paving begins.
6. If the paving Contractor elects to use control wires for grade control, verify they are to the correct grade and are adhered to during the paving operation (*Standard Specifications* Section 5-04.3(3)C).
7. Check transverse joints for smoothness and appearance (a straightedge should be used).
8. Watch trucks dumping into paver hopper or transfer device for adverse effect on paver operation. Ensure a material transfer vehicle (MTV) or material transfer device (MTD) is being used if required. Pay particular attention to constant uniform paver speed and minimum operation of the hopper wings. If a transfer vehicle is not used or the hopper wings are being folded, the Street Inspector should check for significant temperature differences on the paved mat prior to compaction. These temperature differences can lead to non-uniform compaction.

9. Check temperature of HMA occasionally and watch for evidence of incomplete mixing.
10. Maintain constant inspection of the mat behind the paver for signs of roughness or non-uniformity of mixture.
11. Ensure the longitudinal joints are raked and compacted properly. The Contractor should be doing minimal handwork with a rake and should only “bump” the material at the joint and stay away from “raking” the material.
12. Make frequent checks of yield and depth.
13. Watch the rolling operation and verify that the rollers are operated in accordance with the manufacturers recommendations (*Standard Specifications* Section 5-04.3(4)). See that nuclear density readings are maintained. Check the internal temperature of mix to verify that static rolling is used when the mat temperature is below 175°F.
14. Keep a record of truckloads used each day.
15. Make sure the job is in good shape and safe for traffic before you leave at the end of the day, that the transverse night joint is properly constructed (*Standard Specifications* Section 5-04.3(12)A1), and that any excess paper is trimmed from the transverse night joint.

### Duties Before Paving Begins

The Street Inspector is a key participant in the prepaving meeting and typically oversees all aspects of the operation at the jobsite. The Street Inspector should be knowledgeable as to the project limits, hours of operations, the direction in which paving is to proceed, methods of performing any unusual features of work peculiar to the project, proposed traffic control methods, etc. The plan of operation agreed upon at the prepaving meeting should be followed faithfully whenever possible.

**Traffic Control** – The Contractor shall conform to the requirements of *Standard Specifications* Section 1-10. The Project Engineer and the responsible Inspector must work closely with the Regional Traffic Engineer and the Contractor to ensure that the proper signs are placed in the best possible manner. All applicable signs shall be installed on the job before paving begins.

**Inspection Tools** – Before paving work begins, the Street Inspector must verify that all tools and equipment necessary for the inspection work are available. These would include such things as surface and probe thermometers, tape measure, depth gauge, 10-foot straightedge, notebooks, Inspector’s Daily Report, report forms, etc.

**Inspection of Paving Equipment** – It is the duty of the Street Inspector to inspect the Contractor’s paving equipment to verify the equipment meets the Contract Specifications. For the best possible surface finish, it is essential that all machines are in good condition and all parts are in proper adjustment. All equipment, including trucks, should be observed for hydraulic and fuel leaks when systems are under pressure. If leaks are detected, notify the Contractor immediately to clean up the leaks and repair or remove the equipment creating the leaks.

Listed below are some of the most important details the Street Inspector should check during the inspection of paving equipment:

- (a) **Paving Machines** – Several types and makes of paving machines are in use in this State, all of which are capable of producing satisfactory surface finishes. The differences between types of paving machines are primarily in the methods used in striking off, compacting, and smoothing the mixture. The Street Inspector should be familiar with the mechanical features of the type of paver to be used on each job. Handbooks of operating instructions are available from each manufacturer, in which the various adjustments and operating details are shown. The Street Inspector can obtain copies of these instructions from the Contractor or the manufacturer if needed. The requirements for paving machines are in *Standard Specifications* Section 5-04.3(3). Ask the Contractor to explain the operation of the attachment intended to construct the notched wedge joint. The Street Inspector must be familiar with these Specifications.

Extensions may be added to the paving machine to allow the Contractor to pave a wider section. When the extensions are used in the traveled way they are required to have augers and screeds that vibrate and are heated. Most paving machines will be equipped with automatic screed extensions.

On all track paving machines, correct adjustment of the track linkage is essential for smooth operation. A poorly adjusted track, or a badly worn one, can produce an uneven, lurching movement in the travel of the machine which will be reflected in an uneven, “choppy” pavement surface. Observation of the machine in motion will usually show up any defects in the track or drive mechanisms.

Some pavers are suspended on rubber-tired wheels. For proper operation of this type of paving machines all tires must be inflated to the correct pressure and the drive system must not have any slack.

The paving machine is required to be equipped with the most current equipment available for the prevention of segregation and the Contractor is required to provide a certification, upon the Street Inspector’s request, that it is properly equipped.

- (b) **Rollers** – The proper operation of the roller is a key factor in quality pavement. When done properly the HMA will be compacted to a dense uniform mat free of defects. Improper operation produces a poor quality mat that may include tears, roughness and low or uneven compaction. All of these will result in a reduced life of the HMA and increased long term cost to WSDOT.

The Street Inspector should be especially watchful for flat spots on the drums of steel rollers. The steering and driving mechanisms must be free of excessive play or backlash. Observation of the roller in motion and reversing direction will disclose any deficiencies in the drive and clutch mechanisms. The manufacturer of the roller provides the maximum rate of travel.

Pneumatic-tired rollers, to function properly, must have tires of equal size and in good condition. All tires must be equally inflated, so that all exert equal unit pressure on the pavement. Tire pressures may be varied to suit conditions on the job, but, in general, should be such that ground contact pressures range between 40 and 80 psi. The Street Inspector should observe the roller in motion to see that all wheels are rolling true, without wobble or creep. Pneumatic tired rollers should have full skirts as the tires must be warm to prevent “picking.” (When the cool tires roll over the hot HMA mix, the mix tends to stick to the tires, and is “picked” up from the mat onto the tires.)



Current vibratory rollers are capable of operating in three modes: static, vibratory, and oscillating. In static mode, the only movement of the drum is rolling on the pavement. In vibratory mode, eccentric cams inside the drums add rapid movement of the drum that is primarily up and down. In oscillatory mode, eccentric cams inside the drums add rapid movement of the drums that is primarily forward and back. An individual drum can operate in only one mode at a time but it is possible for a roller to operate the front drum in a different mode from the back. Compaction on a bridge deck is allowed with drums in either static mode or oscillatory mode – vibratory is not allowed. The Street Inspector cannot see the difference between vibratory and oscillatory by looking at the drum because the movement is too rapid. The only way to tell whether a drum is vibrating or oscillating is to learn how to read the control panel by discussing it with the roller operator. Each roller manufacturer has a different control panel. A pre-pave meeting is the ideal time for the Street Inspector to view the controls and discuss how to best ensure oscillation or static mode on bridge decks.

- (c) **Other Items** – The Street Inspector should be satisfied that the Contractor is properly equipped with portable barricades, cones, or other means of protecting the freshly laid pavement from damage by traffic.

Upon completion of the check of the paving equipment, the Street Inspector should call any deficiencies of equipment to the attention of the Contractor, so that correction can be made.

**Preleveling** – The Project Engineer must give careful consideration to the use of a preleveling course over areas of unusual roughness, wheel ruts, or sags in the profile of the pavement base. The Contractor should be given as much advance notice as is possible of the intent to place a preleveling course. The areas that need prelevel should be marked out and reviewed with the Contractor prior to the pre-pave meeting. The extent of prelevel and the methods to be used should be discussed at the pre-pave meeting.

There are several methods the Contractor is allowed to use for preleveling. One method is the use of a motor grader. A paving machine may be used if better results can be obtained by this method and particularly where long undulations occur. When conditions warrant, a reference line may be erected for preleveling and an electronic paving machine reference should be used for placement of subsequent pavement courses. Ruts can be economically preleveled by dragging a paver screed if the Contractor elects to use this method. In order to outline areas and amount of preleveling, the Contractor may elect to erect a single reference line along the crown point for the first pass. The practice of directly marking depths and limits of preleveling required on the pavement surface is considered beneficial. When the area is small or irregular the Contractor may choose to use hand methods to prelevel.

The nominal compacted depth of any layer of any course, including preleveling lifts, shall not exceed the depths outlined in the *Standard Specifications* for the class of mix being used. The purpose of this requirement is to reduce the differential compaction that takes place and to ensure adequate compaction of thick lifts between two humps. Compaction of pre-level should be accomplished with a pneumatic roller. When preleveling wheel ruts, a pneumatic tire roller is required.

To produce a satisfactory riding surface, preleveling, in theory, should continue regardless of plan quantities until a uniform lift of HMA can be placed by paving machines with the electronic reference. If it appears that the plan quantity of prelevel must be exceeded due to the condition of the existing pavement, the situation should be immediately brought to the attention of the Project Engineer and the Region Construction staff. The Project Engineer must take care to clearly distinguish between preleveling operations and paving operations, especially for lifts under wearing courses.

### **Duties During Paving Operations**

Prior to beginning of paving work each day the Street Inspector must verify that grade control lines, if used, are set for the day's work, that the base is properly prepared, and that tack coat has been adequately and uniformly applied through the area (including vertical edges) to be paved during the day. It is not a good practice to apply tack coat over more area than can be paved in a day or an hour or two if the weather appears to be questionable. Traffic conditions may also dictate how far the tack coat should be placed ahead of the paving operation.

### **Miscellaneous Duties of the Street Inspector**

Prior to placing HMA against gutters, curbs, cold pavement joints, manhole castings, etc., the Street Inspector must verify that all contact surfaces are painted with an accepted tack coat.

A detailed Inspector's Daily Report (DOT Form 422-004, 422-004A, and 422-004B) will be kept by the Street Inspector, noting all unusual occurrences, orders received from the Project Engineer, orders issued to the Contractor, and other pertinent information.

The Hot Mix Asphalt Compaction Report (DOT Form 350-092) must be prepared by the Density Inspector.

### **Multiple Asphalt Plants**

When two or more asphalt plants are used on one project, the mix from each plant must be placed with separate paving machines and compaction equipment. This is necessary because of the required adjustments on each paving operation to accommodate the different mixes and the various rolling patterns that may be necessary.

#### **GEN 5-04.4 How to...**

**Compute Yield** – During the paving operation, a careful record shall be kept, showing truckloads, the weight of each truckload and other pertinent data. Periodically, the Street Inspector is required to compute the quantity of mix placed per square yard, and must compare the yield against the proposed quantities. Overruns or underruns in quantities may be avoided by making a constant check of quantities placed.

HMA pavements are designed on a weight/volume relationship of 137 pounds for one square yard of pavement at a compacted depth of 0.10 feet. It is the intention in the construction of the pavement to spread the mixture according to an average yield in pounds per square yard.

Remember that the minimum compacted depth of pavement must also be met. If the aggregates are heavier than anticipated when the quantities were computed, or if the surface that the pavement is being constructed on is not true, the average yield can be attained without meeting the minimum thickness requirement.

Weigh tickets must be collected and a daily total weight of mixture received will be obtained and entered on the daily report for submission to the Project Engineer. To eliminate possible errors, totals as recorded by the Plant Inspector shall be compared against the total obtained by the Street Inspector. Careful attention given to those details may save argument with the Contractor concerning pay quantities.

**Determining Minimum Lift Thickness** – On occasion, the thickness of an individual lift of HMA is not specifically indicated on the roadway sections, or a Contractor requests permission to place the HMA in more than one lift. Although maximum lift thickness is specified in the *Standard Specifications*, there is no guidance as to the minimum.

Lift thickness is governed by aggregate size. Adequate lift thickness ensures proper aggregate alignment during compaction, so that density and an impermeable mat can be achieved. Lifts placed too thin can lead to aggregate segregation, tearing, and more rapid cooling of the mat. It is generally more difficult to achieve proper density and pavement smoothness with a thin lift. As a guide, the following table may be used to determine the minimum lift thickness for the various classes of mix.

HMA Class	Minimum Lift Thickness (ft)
3/8"	0.08
1/2"	0.12
3/4"	0.20
1"	0.25

### SS 5-04.3 Construction Requirements

#### SS 5-04.3(3)A Mixing Plant

**Plant Inspector's Checklist** – Some of the most important details of inspection on asphalt plants are listed below:

1. Verify that testing tools, equipment, and samples are on hand at the plant site and in good condition. Make sure you understand all of the required tests.
2. Inspect all components of the asphalt plant listed in the *Standard Specifications*, and make sure all deficiencies are corrected *before* production has begun.
3. Verify that the truck scales are currently certified in accordance with *Standard Specifications* Section 1-09.
4. Post mix designs, including all revisions to the JMF. When a reference mix design is accepted the Inspector should verify if any changes to the mix design were accepted on another Contract.
7. Watch for evidence (dark smoke from plant exhaust and oily coating of aggregate) of incomplete combustion of burner fuel.
8. Check frequently the temperature of the asphalt.
9. Observe plant operation occasionally to verify that correct weights and proportions are obtained, including asphalt content and recycled asphalt pavement (RAP).
10. Make frequent visual inspections of mix leaving the plant for evidence of non-uniformity or incomplete mixing.

11. Check temperature of mix frequently. The mix design has the temperature requirements. An infrared heat gun may be used.
12. Inspect truck beds before loading and verify that the bed is free of congealed chunks of mix and excess release agent.
13. Observe the Contractor taking samples of aggregate before mixing with asphalt, and HMA mixture, for acceptance testing and submission to the laboratory.
14. Make accurate, complete record of all test results, asphalt used, and other pertinent data.
15. Have copies of all test reports available for review.
16. Fill out the required daily reports.
17. Keep in constant communication with the plant foreman and the Street Inspector and give immediate notification regarding any problems.

**Acceptance Testing** – On all projects involving HMA, job site samples shall be obtained, tested, and recorded in accordance with the *Standard Specifications*, the Contract Special Provisions, and [Chapter 9](#) of this manual. A split of the field sample will be retained by the field tester for further testing if necessary. This sample may be used when the Contractor requests a subplot be retested in accordance with *Standard Specifications* Section 5-04.3(9) B7. Asphalt content of the mix shall be determined by use of the Ignition Furnace in accordance with WAQTC FOP for AASHTO T 308, gradation determined in accordance with WAQTC FOP for AASHTO T 30, and voids in mineral aggregate (VMA) and air voids ( $V_a$ ) in accordance with WSDOT SOP 731.

**Samples Required by Materials Laboratory** – Mix design “conformation samples” are not used for acceptance so they impose no liability risk to the Contractor. Conformation samples are samples that shall be submitted to the State Materials Laboratory Bituminous Materials Section. For all projects, beginning with the first acceptance sample, submit one sample (two representative quarters) every 10,000 mix tons (one conformation sample for every ten acceptance samples). The conformation samples should be taken in conjunction with and be representative quarters of the acceptance samples taken for the project as described in WSDOT Test Method 712. When taking a sample for mix design conformation testing, a sufficient quantity of the mix should be obtained so that two representative quarters of the same sample are submitted to the State Materials Laboratory. Samples shall be taken as provided in [Chapter 9](#).

**Sampling Methods** – Samples of the complete asphalt mixture should be taken by the Contractor, at the request of and in the presence of the Plant Inspector, in accordance with WAQTC FOP for AASHTO R 97. Acceptable locations are either by mechanical sampler between the discharge of the silo and the haul truck if approved by the Regional Materials Engineer, or from the truck without entering the truck. The Plant Inspector should then reduce the sample to size for testing in accordance with WAQTC FOP for AASHTO R 47. Remember that the value of material quality testing is dependent on exact parallel tests of identical splits from representative samples.

**Verification of the Ignition Furnace Calibration Factor** – The State Materials Laboratory prepares 12 ignition furnace calibration samples for every HMA mix design. Four samples are shipped to each Region along with the reference HMA mix design so they can calibrate their ignition furnace. The “Ignition Furnace Calibration Factor” shall be determined in accordance with WSDOT SOP 728 and should be done prior to beginning the production of any paving mixture using initial mix design.

The verification shall be done using the furnace that will be used for acceptance testing. In some circumstances it may be necessary to use production data to verify acceptance results but should be only utilized when all verification procedures have been used and validated.

### Inspection of Mixing Plant

Plant Inspectors should familiarize themselves with plant operations prior to beginning of paving. A visit to the plant will do this and additionally provide an opportunity to inspect the plant for conformance to *Standard Specifications*. Specification violations should be brought to the attention of Contractor so they may be corrected prior to beginning paving.

When doing plant inspection, particular attention should be given to examination of gates, feeders, drier and dust collector, screens and bins, pugmill, and all thermometers, pyrometers, and weighing scales. To assist in this inspection, one of the previously recommended hot mix asphalt paving handbooks will provide excellent guidance.

With the increased emphasis on aggregate structure, voids in mineral aggregate (VMA) and air void content ( $V_a$ ), it may be necessary for the Contractor to use multiple stockpiles.

Allowable methods of heating the asphalt are stated very clearly in the Specifications, and the limits of the range of application temperatures are also specified. An asphalt thermometer is required to be installed in the asphalt line. This thermometer should be checked for accuracy before work starts. Close control of variations in temperature of the asphalt binder is very important, as overheating of asphalt oils will cause hardening and may cause substantial decrease in pavement life. The Project Engineer may allow increasing the mixing temperature, in accordance with the manufacturer's recommendation, as allowed in the *Standard Specifications*.

*Standard Specifications* Section 5-04.3(3)A Item 1 requires that a valve be placed in either the asphalt supply line to the mixer or the storage tank for sampling the asphalt binder. This valve should provide a safe method of obtaining samples of the asphalt binder that are representative of the material being incorporated in the mixture. All samples must be taken by the Contractor in the Plant Inspector's presence. If for any reason the asphalt binder is suspected to have become mixed or contaminated in the storage tank, additional samples from the asphalt supply line should be taken and noted on sample submittals.

### Inspection During Mixing Operations

After the mixing begins and throughout the day, the Plant Inspector, who is a qualified tester, shall perform the required tests of the HMA mixture. It is very important, however, that the testers spend some of the time observing the operation of the plant and the condition of the mixture being produced. Changes in the mixture can quickly be detected by observing changes in appearance or color of the mixture.

Periodic checks of the temperature of the liquid asphalt, as well as the mixture produced must be made to ensure that maximum allowable temperatures are not exceeded and uniform material is being produced. The Contractor will choose the desired temperature of the mixture within Specification limits, depending on weather conditions, length of haul, and other factors. Plant Inspectors should watch for excessive variation in temperatures, and notify the Contractor of any variation that occurs. Variable temperatures of the mix may cause compaction and segregation problems; therefore close monitoring of temperatures is an essential part of HMA paving.

When stockpiled, aggregates may contain a high percentage of moisture. With excess moisture in the aggregate difficulty may be encountered in heating the material to the proper temperature. In some cases, the Contractor may try to correct this condition by increasing the amount of fuel oil fed to the burner. This can be done satisfactorily until incomplete combustion of the fuel oil occurs. Black smoke coming from the exhaust stack is an indication that incomplete combustion is occurring. Black smoke is also a sure sign that air quality standards are being violated. The Plant Inspector should watch for this condition, as the unburned fuel can deposit a sooty, oily film on the aggregate particles that is detrimental to proper coating of the material with the asphalt film. A reduction in the rate of aggregate fed to the drier will usually correct the situation and allow proper heating and drying of the material.

Frequent inspections of the condition of the mixture leaving the plant should be made, noting the consistency of the mix, the distribution of asphalt and aggregate throughout the mixture, and the temperature of the mixture. Trucks should be loaded by multiple dumps of three or more as recommended by the National Asphalt Pavement Association (NAPA). If the quality of the mixture varies from truck to truck, an immediate check should be made to locate the source of trouble. Uniform distribution of asphalt binder throughout the mix is extremely important. If portions of each truckload vary from rich to lean, the Plant Inspector must advise the Contractor to correct the problem. It may be necessary to increase the mixing time to correct this situation. By examining the mixture in bright light, the experienced Plant Inspector can quickly detect non-uniformity in the mixture.

### **Miscellaneous Duties of the Plant Inspector**

One of the duties of the Plant Inspector may be to oversee the work of the scale person on truck weighing scales at the plant, and verify that the required tests of the scales are performed. The Plant Inspector must verify that tickets are properly made out and issued for each truckload of mixture delivered, and must also verify that daily totals are promptly obtained and entered on the daily report. When HMA is produced using a warm mix asphalt (WMA) process the tickets are required to identify the mixture as WMA.

Before trucks are allowed to be loaded at the plant, a check shall be made to verify that the truck beds are properly lubricated as required in the Specifications. No pools of bed release agent shall be allowed to remain in the truck bed following this operation. The truck bed should be raised to allow any excess material to be drained off.

When the Contractor is using a site furnished by WSDOT, the Plant Inspector should ensure that the Contractor shapes up any remaining aggregate into neat stockpiles, and removes all debris from the plant site when the project is complete.

### **SS 5-04.3(3)D Material Transfer Device or Material Transfer Vehicle**

Material Transfer Devices (MTD) and Material Transfer Vehicles (MTV) are machines used between the delivery trucks and paver. An MTD is attached to the paver while an MTV is self-propelled and not attached to the paver. These devices/vehicles provide for remixing of the HMA prior to placement which brings the HMA mixture to a more consistent temperature. This will greatly reduce or eliminate "cold spots" in the mat when the HMA is placed. In addition, the use of these machines will allow for a more constant operation, minimizing stops and starts. This will provide a smoother mat.

At the Contractor's request the Project Engineer may approve paving without a Material Transfer Device or Materials Transfer Vehicle (MTD/V). It is intended that these request be approved for work at intersections, etc. These requests will not be approved if they reflect work on mainline paving. The Project Engineer should evaluate these requests for equitable adjustments in monies or time.

### **SS 5-04.3(4) Preparation of Existing Paved Surfaces**

Proper application of tack is one of the most important construction processes for ensuring the full service life of the pavement. Too much tack, too little tack, streaks, or failure to allow time for the tack to break before being covered with hot mix can reduce the pavement life by half or more.

The Specifications require an application of tack coat that is uniform and free of streaks and bare spots. The application rate will depend on several factors and include the condition of the existing pavement, the Contractor's equipment, the type of asphalt used, if it has been diluted with water and the application temperature. Tack coat is always applied to all paved surfaces prior to the placement of HMA including projects that have multiple lifts of HMA. Tack coat is not required when HMA is placed directly on crushed surfacing. For many pavements an application rate of approximately 0.05 gallons per square yard of residual asphalt is adequate. When paving a second lift of HMA a lower application rate is typically applied. Thin lifts of pavement require heavier applications of tack coat to prevent raveling, spalling, and delamination. As a guide, existing surfaces that are coarse, dry or milled require a higher application rate of tack coat than surfaces that appear rich or bleeding.

#### **SS 5-04.3(4)B Soil Residual Herbicide**

Weeds cause considerable damage to thin asphalt pavements such as sidewalks, shoulder overlays, and asphalt lined ditches. It is typically recommended that chemical weed control be used under all asphalt pavements less than 0.35 feet in depth unless a full depth base preparation was included in the construction. Check the Contract requirements to see if soil residual herbicide is required.

### **SS 5-04.3(7) Spreading and Finishing**

In the construction of HMA pavements, it is extremely important for the paving machine to be in good adjustment and the machine and screed operators be experienced and capable. The Street Inspector should be quick to note operational practices that have an adverse effect on the work, and *request* the Contractor to make immediate corrections.

Compaction procedures will be as specified in *Standard Specifications* Section 5-04.3(10).

During the paving operation, constant inspection must be maintained to see that the machine is producing a smooth pavement having the required characteristics of texture and uniformity. The Street Inspector must require immediate action be taken by the Contractor to correct any trouble that may develop.

Listed below are some common difficulties encountered on HMA paving work, together with the most common causes of the difficulty:

- **Wavy Surface (short, choppy waves)** – Worn or poorly adjusted tracks or drive train; truck driver setting brakes too tightly; excessive paving machine speed; vibratory roller operating too fast.

- **Wavy Surface (long waves)** – Excessive variation in amount of mix carried in auger box ahead of screed; over-controlling screed; milling machine operated too fast.
- **Excessively Open Surface Texture** – Improper adjustment of strike off; screed plate surface is rough or galled; excessive paving machine speed.
- **Varying Surface Texture** – Insufficient mixing; trucks being loaded improperly at the plant; segregation of mix in trucks; poor gradation control at mixer; screed not uniform across paving machine.
- **Streaked Surface Texture** – Insufficient mixing; segregation of mix in trucks; worn or damaged screed plate.
- **Bleeding Patches on Surface** – HMA not uniformly mixed; excessive moisture in mix, or high binder content in the mix.
- **Irregular Rough Spots on Pavement** – Roller standing on fresh surface; abrupt reversing of roller; trucks backing into paver; poor workmanship at transverse joints.
- **Cyclic Open Texture or Mat Temperatures that Vary More Than 25° (that usually matches up with the distance that each truck load of material covers)** – This may be caused by a couple of problems. One is the result of thermal segregation. In this case, the differential temperatures in the HMA result in inconsistent compaction and a cyclic open texture. The use of an MTV/D will reduce or eliminate thermal segregation. Secondly, the machine operator may be allowing the head of material to fall below the top of the augers or by dumping the wings of the paver when the hopper is low on material. Hopper wings should be operated only occasionally and then with some load in the hopper.
- **Crooked or Irregular Longitudinal Joint Lines** – Careless machine operation or no guide string placed for the machine operator to follow.

Some paving machine operators have a tendency to operate the paver at speeds in excess of that required to handle the quantity being produced at the plant, resulting in a jerky, stop and go operation. *This must not be allowed.* Generally, when the paver is operated consistent with plant production and roller capacity, the finished surface will be smoother. The ideal speed of the paver will be that which will result in a smooth, nearly continuous process with a minimum of stops required in waiting for trucks and/or the compaction equipment. If the production rate of the mixing plant is very high, requiring excessive speed of the paver, the Contractor will be required to correct the situation by slowing the production or using additional paving machines and generally, additional compaction equipment. Delivery must be adjusted to match production and uniform lay down.

The Street Inspector should periodically check for difficulties while truckloads of mixture are dumped into the hopper of the paving machine. Trucks must not be allowed to back into the paver in such a manner that they bump the paver, nor shall trucks that bear against any part of the machine other than the pushing rollers be permitted to dump into the paver. Any mix spilled onto the pavement in front of the paving machine must be shoveled into the hopper of the machine or back into the truck before paving is resumed. The Street Inspector should be especially watchful to see that mix spilled in the paths of the tracks or wheels of the machine is removed.

Checks should be made of the crown adjustment of the screed, to ensure that the finished surface will conform to the required section.



Particular attention must be given to the construction of the longitudinal joint when paving adjacent to a previously laid lane. The Street Inspector must insist that hand raking be held to a minimum, by adjusting the screed so that the freshly laid pavement is of the proper depth, allowing for compaction, to meet the grade of the previously laid lane. The uncompacted mixture immediately adjacent to the joint should be left slightly high so that the roller can compact the mixture thoroughly at this point. The rakers must not be permitted to cast excess mixture over the uncompacted, freshly spread lane. The Street Inspector must insist that segregated coarse particles of mix remaining after making the joint be removed and wasted, to avoid construction of a coarse, porous joint.

### **GEN 5-04.3(9)B3 Mixture Statistical Evaluation – Acceptance Testing**

Beginning with the 2018 paving season, several changes to Specification requirements for HMA compaction and mixture are being phased in incrementally over four years. The goal of these changes is to increase the service life of our HMA by at least one year. We are implementing these changes incrementally over four years to provide time needed by Industry to adjust means and methods to successfully meet the new requirements.

Changing Specifications so frequently creates a challenge for staff responsible for entering and evaluating HMA test results, making sure that HMA data is being evaluated in accordance with each Contract, and ensuring that incentive/disincentive payments are being made per Contract. Offices administering multi-season HMA projects could be dealing with as many as three different Specifications in one paving season, until 2023.

The key to ensuring that you are following the correct Specification when performing statistical evaluation and making the incentive/disincentive payments is to make sure the settings in SAM are correctly set to match the requirements of the Contract. It is easy to see what the SAM setting for HMA evaluation is for a particular Contract by looking at what is indicated in the drop-down list for “Material”. For example, if the material drop-down list shows “Class  $\frac{3}{8}$  inch, 9-03.8(7) – 2018”, SAM is using what is referred to as the 2018 settings. A drop-down indicating “Class  $\frac{3}{8}$  inch, 9-03.8(7) – 2019” indicates the 2019 settings are being used, and so on.

The difficulty arises in determining which “year” in the “Material” setting is required by your Contract. It is not the Specification book year, because these changes have been made by Amendments and in some cases by Special Provision. The only way to correctly determine if SAM is correctly performing the statistical evaluation on your HMA is as follows:

1. Find the values in your Contract for each of the Specifications listed in the table below. Be sure to look in the Amendments to the *Standard Specifications* and in the Special Provisions to see if any changes have been made to the *Standard Specifications*.
2. Compare the values in your Contract to those in the table below. Find the column in the table below that exactly matches all the values in your Contract. Find the Specification year at the top of that column. If your Contract does not exactly match all of the values in one of the columns, contact your ASCE in the State Construction Office.
3. Look at the “Material” drop-down list in SAM. The Specification year indicated by SAM must be the same as the one you determined from your Contract and the table below. If they do not match, change the SAM pic-list item so it matches the Specification year determined from the Table.

## Field Acceptance – HMA Spec Changes: Mixture and Compaction

SPEC	SPEC REQUIREMENT	2016	2018	2019 & 2020	2021 & 2022
9-03.8(7)	VMA Tolerance	N/A	-1.5%	-1.0%	-0.5%
9-03.8(7)	Binder Tolerance	-0.5% to +0.5%	-0.4% to +0.5%	-0.4% to +0.5%	-0.4% to +0.5%
2016: 5-04.3(10)B1 2018 & 2020: 1-06.2(2)D5 2021: 5-04.3(10)C3	Compaction Lower Spec Limit - disincentive	91.0	91.0	91.5	92.0
2016: 5-04.3(10)B1 2018 & 2020: 1-06.2(2)D5 2021: 5-04.3(10)C3	Compaction Lower Spec Limit - incentive	91.0	91.5	92.0	92.0
2016: 5-04.5(1)B 2018 & Newer: 5-04.3(10)C3	Compaction Price Adj. Factor - Disincentive	0.40	0.40	0.60	.40
2016: 5-04.5(1)B 2018 & Newer: 5-04.3(10)C3	Compaction Price Adj. Factor - Incentive	0.40	0.80	1.00	1.00

**SS 5-04.3(10) HMA Compaction Acceptance****SS 5-04.3(10)A HMA Compaction - General Compaction Requirements**

Compaction of the HMA is very important in the construction of a durable pavement. When good compaction is coupled with the proper mix design, extended service life of the pavement can reasonably be expected.

The importance of thorough compaction of HMA cannot be over stressed. Two major factors are working simultaneously in a well-designed mixture to resist good compaction: (A) the stability of the mix in place increases with each pass of the roller, and (B) the viscosity of the asphalt increases as the temperature drops. A temperature-viscosity curve for the type of asphalt used in the mix is a useful tool in determining the ideal compaction temperature of the mix.

Although densities for some HMA may be increased at temperatures below 175°F, vibratory rollers may damage the mat internally in ways that cannot be seen at the time of compaction. To prevent this damage, compaction with static rollers is required when the internal temperature of the mix is below the minimum Specification of 175°F. When paving in air temperatures over 90°F, some or all of the compactive effort may have to be delayed, but in no case should it be delayed below 175°F mat temperature.

Vibratory rolling is prohibited on bridge decks and within 5 feet back of the pavement seat, however, rollers may be operated in oscillatory mode unless otherwise noted on the plans.

The desirable end product of a properly compacted HMA is a dense and nearly impermeable mat. Acceptable densities can be obtained if the mix proportions are proper. If not, no reasonable amount of compaction can produce acceptable density. Without proper density, the HMA will be subject to early distress and failure. Some mixes may be difficult to compact because they will move under the roller instead of compact. This is referred to as a tender mix and may result from several causes including gradation, fracture and asphalt binder properties.

The asphalt binder content in a mix is based on several factors including traffic levels, aggregate structure and asphalt binder properties. The Contractor develops the mix design to meet specific volumetric properties. Field changes in the mix design asphalt content should only be allowed after careful consideration of all of the impacts. The maximum adjustment the Project Engineer may allow may not exceed 0.3 percent from the accepted mix design (*Standard Specifications* Section 9-03.8(7)). The Region Materials Laboratory is a good resource when considering changes in the asphalt binder content. Increasing the asphalt binder content on high traffic volume routes carries more long term performance risk than on low volume roads.

The use of thicker lifts of pavement permits more time for compacting and will increase the effectiveness of the equipment. With careful organization and planning, the production of over 400 tons per hour may be compacted by as few as three rollers on deeper lifts. It is also apparent that high production rates with thin lifts might require twice as many rollers or more. It is the Contractor's responsibility to determine how many rollers are needed to match the asphalt plants production rate.

Usually the Contractor has a companion group of rollers, pavers, and production equipment for use together on paving projects that have been proven to be compatible.

Before production begins, the Region Materials Engineer should be notified to arrange for the coring of the pavement to correlate nuclear densities to core densities for calculation of a nuclear gauge correlation factor, and to core bridge decks for compaction if the Contract assigns these cores to WSDOT.

In general, compacting should begin on the outer edge of the course and progress toward the center of the pavement except on superelevated sections where the initial effort shall be on the lower side with the progressive compaction toward the higher side.

The type of rollers and their relative position in the compaction sequence shall generally be at the Contractor's option provided Specification densities are attained and it is not specified otherwise in the Contract Provisions. Exceptions are (1) a pneumatic tired roller is required for compaction of the wearing course from October 1 through March 31, and (2) a pneumatic tire roller is required to compact preleveling in areas that are severely wheel rutted. Coverage with a vibratory or steel roller may precede pneumatic tired rolling. The maximum speed of rollers shall not exceed the recommendations of the manufacturer of the roller for the compaction of HMA. When requested by the Project Engineer, the Contractor is required to provide a copy of the manufacturer's recommendations. When the roller reverses direction the vibrators must be turned off momentarily.

The steel drum vibratory roller is generally used for the primary compaction on HMA mixes and sometimes for finish rolling in a static mode. Two terms frequently used with vibratory rollers are frequency and amplitude. Frequency is how often the impacts are applied and is normally stated in cycles per second. Amplitude is the greatest vertical movement, up or down, of the drum during a cycle.

Vibratory rollers achieve their compaction effect from the kinetic energy produced by the vibrating components of the roller. Vibratory rollers usually work best when operated with high frequency and low amplitude on dense graded leveling and wearing courses. On hills, it usually works best to operate the vibrators only while traveling uphill. Over vibrating can cause a decrease in compaction. Operated in the static mode, despite their apparent bulk, they are less effective than even intermediate size conventional steel drum rollers due to their lower mass.

Vibratory rollers may not be practical in areas where there are mortar joint concrete or certain other vintage pipe used for utilities or irrigation. In locations with this type of pipe the Special Provisions will restrict the compaction to static rolling.

With pneumatic roller breakdown it will be necessary to hold in about 6 inches from unsupported edges to avoid lateral displacement of the HMA. A narrow overlap of successive trips is desirable and the roller should be kept in constant motion. During initial compaction, the rollers orientation should be such that the powered axle passes over the uncompacted mix first. Breakdown tiller wheels should be turned the least possible amount in the uncompacted area to avoid pushing and shoving the hot mat near the wheels. The steel drum roller should follow closely behind the pneumatic roller to compact the centerline joint and the edge of the pavement as well as iron out the pneumatic tire marks. The steel drum roller will exert extra pressure on the uncompacted edge and should have no difficulty in properly compacting this edge if the roller is close behind the pneumatic rollers. Cold rubber tires usually “pick” the mat. Every effort should be made to warm the tires before compacting the mat. Sending the rollers for a drive before the work is fully organized prior to paving will help with the tires.

The axles of the roller are weighted by the use of iron pigs, chain, rivets or other concentrated loading in addition to the usual water and aggregate tank loading to control the total roller weight. Ground contact pressure is determined by the tire inflation pressure, a ground contact pressure of 70 psi is a reasonable pressure to start with. Variation in the mixture and tire pressures will soon determine the most desirable combination of mixture, temperature, contact pressures and number of applications.

Steel drum rolling is generally used for finish rolling; however, it is sometimes used for breakdown and primary compaction. It is important that vibratory roller operation on pavement with temperatures below 175°F not be permitted. Over-rolling by the steel drum roller may damage the pavement more than under-rolling.

Preferably, rolling equipment should be wide enough so that a uniform application of compactive effort can be distributed over the entire course without creating hard streaks or leaving narrow porous strips. Breakdown and intermediate rolling should be completed while the mixture is above 185°F with the finish rolling completed above 150°F. With lower temperature mixes and thin lift applications it becomes obvious that the rollers must be kept up close to the paver.

### **SS 5-04.3(10)B HMA Compaction – Cyclic Density**

Temperature variations in the newly placed HMA mat have the tendency to cause variations in density. These variations are more common when the HMA is dumped directly into the paver hopper, where there is limited re-mixing of the HMA to provide a consistent temperature. The requirement to use an MTV/D allows for re-mixing of the HMA, providing a more constant temperature as the HMA is being placed, reducing or eliminating the temperature variations in the mat behind the paver screed.

The Street Inspector should review the surface condition of the mat after rolling to determine if there are any areas which appear coarse in comparison to the rest of the mat. These suspect areas should be noted and marked for testing with the nuclear gauge to verify the compaction requirements have been met. Another effective method of identifying suspect areas is to use an infrared surface heat thermometer or thermal imaging camera. The thermometer or camera scans must be performed behind the paver screed prior to compaction of the mat. Any areas that are excessively cooler than

the rest of the mat (25° or greater) need to be noted and marked for testing with the nuclear gauge.

Areas marked as suspect for low densities are to be independent from the required random density acceptance testing. Readings taken for cyclic density are to be reported separately from acceptance testing on WSDOT Form 350-170.

Each 500 foot section of the mat will be evaluated. If there are two or more areas with a density of less than 90 percent of reference maximum density within the section, a \$500.00 price adjustment will need to be assessed.

### **SS 5-04.3(10)C HMA Compaction Acceptance - Statistical Evaluation**

Refer to Table 14 in *Standard Specifications 5-04* to determine which pavements are statistically evaluated for acceptance of HMA compaction. Note also that 5-04.3(10)C1 requires all HMA compaction on a bridge deck to be evaluated statistically, regardless of whether the HMA is in a lane, shoulder, gore, et cetera.

Refer to Table 16 in Standard Specification 5-04 to determine whether pavement density is measured by testing with the nuclear density gauge or cores. If density is measured on cores, Table 16 also shows what role, if any, the Contractor will play in taking the cores.

Determine the percent compaction for each density test by dividing the density into the maximum density (Rice Density) as determined by WSDOT SOP 729 when using the nuclear density gauge and WSDOT SOP 736 when using cores. Enter the data into the MATS program. Be sure that MATS and SAM are using the correct Lower Specification Limit (LSL) for compaction required by your Contract. See the table above, under GEN 5-04.3(9)B3.

The compaction results are then evaluated statistically for acceptance by the SAM program. SAM calculates a CPF. If the CPF is greater than 1.00, the Contractor will receive an incentive payment for exceeding the minimum statistical requirements. If the CPF is less than 1.00, the Contractor will provide WSDOT a credit (a “disincentive”) for failing to meet minimum statistical requirements. If the CPF is equal to 1.00, the Contractor will receive neither incentive payment nor disincentive credit, because 1.00 represents “meeting” the statistical requirements.

Compaction lots not meeting the prescribed minimum CPF of 0.75 will need to be evaluated for removal and replacement with satisfactory material.

### **GEN 5-04.3(10)C1 HMA Compaction Acceptance – Statistical Evaluation**

HMA density on bridge decks will always be determined using cores, and acceptance of HMA compaction on bridge decks will always be by statistical evaluation. When taking a core on a bridge deck, care must be taken to avoid damaging the concrete deck or waterproofing membrane. To mitigate any possible damage to the membrane or concrete deck, the bottom of the core hole must be swabbed with PG grade asphalt binder before backfilling the core hole with HMA.

WAQTC FOP for AASHTO T 355, regarding using the nuclear density gauge, requires all HMA density testing to be done with a thin lift gauge, or if one is not available, by using the backscatter mode.

**SS 5-04.3(10)D HMA Compaction - Visual Evaluation**

Visual evaluation is the basis for acceptance of compaction for preleveling and pavement repair. Refer to Table 14 in *Standard Specification 5-04*. For preleveling mix, the compaction control shall be to the satisfaction of the Project Engineer. A pneumatic tired roller is required for compacting HMA that is used for preleveling wheel rutting.

**SS 5-04.3(10)E HMA Compaction - Test Point Evaluation**

For any condition that does not require either statistical evaluation for compaction or visual evaluation for compaction, the Contractor shall construct a test point in accordance with instructions from the Project Engineer. The number and timing of passes with an accepted compaction train, that will yield maximum density with the nuclear gauge readings at the test point, shall be used on all succeeding paving. The Street Inspector should make sure the Contractor is making the required number of passes and reconstruct a new test point if conditions change. When this evaluation is used to determine density, WSDOT Form 350-073 is to be completed for project records.

In order for HMA to be accepted by a test point evaluation the Project Engineer shall, at the beginning of paving, select a section approximately 200 feet long upon which to conduct the evaluation. Select a spot within the section near the center of the pavement area for density testing with a nuclear density gauge. After each roller pass, a density reading is taken with the nuclear gauge at this test spot. Gauge readings are taken in the backscatter or thin layer mode; marking the footprint of the gauge with crayon or paint stick as there will be multiple tests required at the same location. Record the information required on DOT Form 350-073. Continue this process until the density readings level off or start to drop. This indicates the relative density has reached its maximum with the compaction equipment being used. After the relative density has reached the maximum, the Street Inspector may request the breakdown roller to make an additional pass or two to see if the density reading increases or stays the same.

The test section should be repeated when there is a change to the work. Examples of a qualifying change would be a different pavement section (depth of pavement/surfacing and not a different roadway section with the same structure), compaction equipment, mix design or JMF (JMF changes to the percent of asphalt binder or gradation).

When a Contractor is paving HMA which will be accepted by both statistical evaluation and test point evaluation in a single operation (e.g., lane and shoulder) the test point evaluation may be omitted if the Contractor uses the same rolling pattern on the area accepted by test point evaluation as that used for the statistical evaluation.

**SS 5-04.3(12) Joints****SS 5-04.3(12)A1 Transverse Joints**

The *Standard Specifications* provide that transverse joints, also called butt joints, be constructed. The use of heavy paper is recommended to form the butt joint at the end of the day's work, with a temporary ramp laid on the paper beyond the joint to assist traffic over the change in elevation. Paper protruding above the pavement shall be carefully trimmed flush with the pavement so that there will not be an illusion of a hazard at night. When the ramp and paper are removed prior to beginning the succeeding day's paving, a well-constructed joint will require a minimum of cutting back to form the required butt joint. When hand raking is performed on a joint, all segregated coarse aggregate shall be removed, to avoid a coarse, porous surface at the joint.

If the roadway is open to traffic, the transverse joint must be feathered to provide a smooth transition for the traveling public and joints between successive lifts in each lane should not be less than 100 feet apart. The higher the speed on the roadway, the longer the taper on the joint must be to provide an acceptable transition. The required slope ratio is 1 vertical to 50 horizontal or flatter.

This slope will usually require use of more than one width of paper. Sufficient material must be temporarily placed in front of the paver to prevent a deformation from occurring in the permanent HMA joint. Care should be taken to construct a straight line taper without humping.

At the beginning of the day's work, special care must be exercised in the construction of the transverse joint joining the freshly laid mixture with the previous day's work. The paver should be allowed to proceed at a low rate of speed (creep) ahead of the joint, until hand finishing of the joint is completed. The paver should not come to a full stop or the screed may settle and cause a dip at that point. The Street Inspector should check this work closely, using the 10 foot straightedge to see that the requirement for surface smoothness is met.

### **SS 5-04.3(12)A2 Longitudinal Joints**

The long term performance of longitudinal joints is highly dependent on the quality of construction. Improperly and poorly constructed joints can fail prematurely; raveling and cracking are common problems with these joints. Proper joint construction includes the following:

- The joint is constructed at the lane line or an edge line of the Travelled Way;
- When multiple lifts of asphalt are placed a joint is offset from the joint below from 2 to 6 inches;
- Tack coat is applied to the joint, including the vertical face of the joint, to bind and seal the joint;
- Industry standards for compaction of the joint are followed to achieve density; and
- For a wearing course where new pavement abuts new pavement a notched wedge joint is required (unless otherwise approved by the Project Engineer).

A notched wedge joint has benefits by the shape of the joint in that there is a better bond, with tack, between the pavements and the density may be improved. This method of joint construction should be used in all locations in the wearing course; not using a notched wedge joint should be an exception and only allowed where the specific project conditions do not allow for this method of joint construction. A notched wedge is not required when new HMA is placed against existing HMA such as at the edge line of a grind and inlay project. The intent of the notched wedge joint is to partially confine the edge for paving while still leaving a "notch" to match to. The wedge needs to be adequately compacted and the notch needs to be there (i.e., not flattened or rounded by traffic or equipment driving across it) when the adjacent lane is paved.

When a roller is compacting HMA adjacent to a longitudinal joint the goal is to confine and densify the material at the joint. The sequence that is recommended by research on longitudinal joint construction is for the first pass of the roller that is adjacent to the joint to be approximately 6 inches from the joint on the "hot" side. This roller pass compacts and provides confinement for the HMA at the joint. This is followed with a roller pass that overlaps to the "cold" side of the pavement and the 6 inch strip of HMA is densified in the

joint area. Other methods of joint compaction have been demonstrated to push the HMA away from the joint resulting in lower density and poorer joint performance.

When HMA is placed adjacent to cement concrete pavement the joint is required to be sawed and filled with a joint sealant to prevent the intrusion of water.

### **SS 5-04.3(13) Surface Smoothness**

When a course is being constructed below the wearing course, an attempt must be made to remove all depressions and sags in the grade line by adjusting the depth of the course. The Street Inspector should work closely with the screed operator to accomplish this result by pointing out irregularities in the base far enough ahead of the machine to allow proper adjustment of the screed to eliminate the irregularity. The objective to be attained during construction of each course is the complete elimination of all irregularities, so placement of the wearing course can be accomplished with a minimum of screed adjustments. If the base is excessively rough, pre-leveling should be completed prior to construction of the first course.

*Standard Specifications* Section 5-04.3(3)C requires the use of automatic screed controls on the paver. It must be remembered that as the equipment becomes more sophisticated, it also becomes more necessary that it be properly adjusted and operated or satisfactory results will not be achieved. With proper operation, this equipment will give excellent performance.

When reference lines are required, or the Contractor elects to use reference lines, particular attention must be given to verify the line is properly set and tensioned. If the line is offset too far from the paving machine, vibrations of the machine may affect operation of the automatic controls, which in turn affect the smoothness of the pavement. The reference line for asphalt paving machines normally will not be used when the roadway is under traffic. The Specifications provide that if the course the pavement is to be placed on is superior to established smoothness requirements, the paver may operate from a mat referencing device such as electronic sensors instead of the wire. The Street Inspector must ascertain that smoothness of the pavement continues to be superior to the requirements of the Specifications.

Normally, when the surface for paving is properly constructed using a reference line or the first course of pavement is constructed using a reference line, subsequent courses of pavement may be constructed using a mat referencing device with continued improvement in the surface smoothness.

Manual operation of the screed controls will be permitted in the construction of irregular shaped and minor areas, such as gore areas, road approaches, left turn channelization lanes, and tapers.

Surface smoothness and good ride qualities of a pavement are secured only by hard work and strict attention to small details. The Street Inspector should continually study the conditions peculiar to the job, and strive to obtain the smoothest surface possible. A smooth riding pavement costs no more than an unsightly, poor surface, but it does require constant, careful inspection of all details of construction to obtain the desired results.



*Standard Specifications* Section 5-04.3(13) outlines the smoothness requirements using a 10 foot straight edge oriented in both the longitudinal and transverse directions. Smoothness checks should be made at the starting point of paving, at transverse “night joints,” whenever the paver is stopped for any length of time, or wherever the Street Inspector suspects a smoothness problem.

Some projects may include the “Smoothness Compliance Adjustment” pay item. The State Materials Laboratory Pavement Office will provide the beginning IRI results from the inventory lane of the previous year for informational purposes. The inventory data will not include data from all lanes. This data will be placed into the Contract for informational purposes.

After the paving is completed on the project, a specially equipped van will travel each lane to determine the final IRI. Payment for the “Smoothness Compliance Adjustment Factor” is determined from the pay schedule based on the type of roadway and associated opportunities to obtain smoothness.

See the General Special Provisions for more information. Ensure the proper usage of the Special Provisions and pay close attention to the intent of using the Smoothness Compliance Adjustment. It is not intended for short sections of paving, ramps or sections that have a speed limit less than 35 MPH. It is intended for mainline paving sections greater than 1 mile in length.

In order to measure the final IRI, the Project Office must inform the Pavement Office ([MLPavementProfileTest@wsdot.wa.gov](mailto:MLPavementProfileTest@wsdot.wa.gov)) and provide the form that can be found at <http://sharedot/eng/cn/sml/pave/SitePages/Home.aspx> After the paving is complete and the roadway is returned to final lane configuration, a request to the Pavement Office is required so the final IRI smoothness can be determined. Final measurements require that traffic control or any detours be completely removed from the roadway and all paving is complete.

## **5-05 Cement Concrete Pavement**

### ***GEN 5-05.1 General Instructions***

Concrete paving is a highly complex, mechanized operation and proper organization and planning of the work is essential on the part of both Contractors and WSDOT. Cement concrete pavement has a relatively high initial cost and WSDOT expects many years of satisfactory service from this type of pavement. It is imperative that the Project Engineer and Inspectors are thoroughly familiar with the specifications and techniques applying to the work, if this objective is to be attained.

Before construction begins, the Project Engineer should review all phases of the work, and see that all members of the crew are familiar with the duties to which they are to be assigned. Advance planning and organization of the engineering and inspection teams will do much to eliminate the confusion and improper construction sometimes found during the first day’s work. All inspection equipment and testing tools should be on hand, and properly calibrated or certified, in advance of beginning of paving, and WSDOT materials testers properly qualified to perform the necessary concrete testing.

The Project Engineer should make certain that all Inspectors are instructed in the proper methods of keeping notes, records and diaries. Accurate records of construction progress and test results are absolutely essential in evaluating pavement performance through the years.

The Contract may contain the GSP, *Just in Time Training*. The purpose of this training is to bring all the parties to the table, and to raise understanding about the means and methods the contractor is proposing in order to comply with the Contract.

## **GEN 5-05.2 Testing Equipment/Reports**

### **GEN 5-05.2A Testing Equipment**

- Specified screens, sieves, and scales.
- Air meter.
- Straightedges and stringlines.
- Thermometers.
- Cylinder molds for casting concrete test specimens.
- Stop watch.
- Flashlights.

### **GEN 5-05.2B Records**

The Project Engineer is responsible for the keeping of proper records that must include the following information:

- Record of cement received and used.
- Screen analysis of aggregates (see [Chapter 9](#)).
- Air-entraining agent used, and air meter test results.
- Rate of application of curing compound.
- Inspector's diaries.

## **GEN 5-05.3 Checklists**

For the convenience of the Inspector, some of the most important inspection duties on concrete paving work are listed below:

### **GEN 5-05.3(1) Concrete Mix Design Approval**

The Contractor's mix design should be reviewed by the Project Office to ensure that it meets the requirements of the Contract. The following items should be reviewed:

- Cementitious materials (Portland Cement, Low Alkali Cement, Blended Hydraulic Cement, Fly Ash, Ground Granulated Blast Furnace Slag, Microsilica Fume, and Metakaolin)
  - Verify products are listed on the QPL or have been approved through the RAM process.
  - Check that mill certification demonstrates specification compliance.
  - Verify the proposed quantities within specification limits for the concrete class.

- Aggregate (Coarse, Fine, and Combined Aggregate)
  - Ensure the aggregate is from an approved source by verification of the ASA database.
  - Check if ASR mitigation is required by verifying the ASA database.
  - Verify the mix design submittal includes data for Deleterious Substances.
  - Ensure the Nominal Maximum Aggregate Size (NMS) is correct for the proposed concrete class.
  - Verify the proposed gradation meet the requirements of the concrete class.
  - Make sure the mix design indicates the quantities of aggregate.
- Alkali Silica Reactivity (ASR)
  - If the aggregate source is ASR reactive, verify the Contractor provided mitigations measures.
  - Ensure the mitigation measures demonstrate compliance with *Standard Specifications* Section 9-03.1(1).
- Admixtures
  - Verify products are listed on the QPL or have been approved through the RAM process.
  - Ensure proposed quantities are within manufacturer's recommendations.
  - Verify all admixtures are from the same manufacturer.
- Water
  - Ensure the quantity of water is indicated on the mix design.
  - Verify the calculated water/cementitious materials ratio is equal to or less than 0.44.
  - If reclaimed water is proposed, verify it complies with *Standard Specifications* Section 9-25.1.
- Design Performance
  - Flexural Strength (650 psi or greater)
    - Verify that five 14-day flexural strength results are included with the mix design.
    - Ensure the flexural strength data indicates a quality level equal to or greater than 80% percent.
  - Compressive Strength
    - Verify that five sets of 28-day compressive strength results are included in the mix design.
    - Ensure the compressive strength data indicates an average compressive strength of 4000 psi or greater.
  - Air Content
    - Verify the mix design indicates air content between 3.0 -7.0 percent.

To assist with the mix design review process the State Materials Laboratory has developed a mix design checklist that can be found at the [Construction Office SharePoint](#) site.

The State Materials Laboratory is available to assist with the review of concrete mix designs.

**GEN 5-05.3A Pre-Pave**

1. Review Contract requirements (Plans, Standard Specifications, amendments to the Standard Specifications, and Special Provisions).
2. See that all testing tools and equipment are on hand and in good condition. Working with the Contractor, determine location(s) for the Contractor provided curing box(es) used for initially curing concrete test cylinders (*Standard Specifications* Section 5-05.3(4)A).
3. Check preparation of Subgrade; watch for soft spots. Check Subgrade elevations to ensure there are no high or low spots (*Standard Specifications* Section 5-05.3(6)). If HMA pavement placed on Subgrade prior to PCCP, refer to *Standard Specifications* Section 5-04 for HMA requirements.
4. Check that forms are in good condition and are set securely, true to line and grade (*Standard Specifications* Section 5-05.3(7)B). If a slip form paver is used, check position of wire, string line across the wire and check the depth to Subgrade or HMA pavement in at least three locations across the proposed paving area at each pin location.
5. Check that Subgrade or HMA is moist before the concrete is placed (*Standard Specifications* Section 5-05.3(6)).

**GEN 5-05.3B Paving**

6. Watch for variations in slump of mixed concrete batches (*Standard Specifications* Section 5-05.3(2)). In the case of slip-form paving, make frequent checks of the condition of the wire and edge slump (*Standard Specifications* Section 5-05.3(11)).
7. Make tests of air content, temperature, compressive test cylinders, and make complete, accurate records of test results and computations (*Standard Specifications* Section 5-05.3(4)A, 5-05.3(5)A, and [Chapter 9](#)). If maturity meters are used, document locations and periodically check output against maturity curve.
8. Check tie bars and dowel bars for rust and defects, that they are installed properly, secured to the grade, and located mid-depth of the slab if placed in baskets. Ensure that dowel bars receive a bond breaker if they are not pre-coated (*Standard Specifications* Section 5-05.3(10)). Be alert to anything in the paving operation that results in movement of the bars.
9. Watch for excessive movement of forms under weight of concrete paving equipment.
10. Check frequently to see that vibrators are operating properly (*Standard Specifications* Section 5-05.3(7)). If a dowel bar inserter is used, check spacing and alignment of dowel bars. Ensure that PCCP is consolidated after the bar is inserted and that slurry does not fill the insertion point.
11. Watch finishing operations to make sure excessive amount of water is not added to surface; allow fine spray only to be used (Section 5-5.3B).
12. Check the surface texturing operation to see that proper, uniformly textured surface is obtained (*Standard Specifications* Section 5-05.3(11)).

13. See that curing compound is placed uniformly, at the required rate, and at the proper time. The curing compound needs to completely coat the surface of the concrete (*Standard Specifications* Section 5-05.3(13)A). Note other curing methods are allowed in *Standard Specifications*.
14. See that concrete is consolidated properly at night headers (*Standard Specifications* Section 5-05.3(8)C).

### **GEN 5-05.3C Post Pave**

15. Inspect joint sawing operation to see that required depth is cut, and that the best possible saw cuts are obtained (*Standard Specifications* Section 5-05.3(8)A).
16. Watch removal of forms; see that damage to pavement does not occur; require curing compound to be applied on edge of slab immediately following form removal (*Standard Specifications* Section 5-05.3(7)B).
17. See that additional curing compound is applied over areas scuffed by foot traffic.
18. Check that pavement is protected from traffic with necessary barricades, lights, etc. (*Standard Specifications* Section 5-05.3(16)).
19. Check that sawed contraction joints are sealed properly with joint sealant filler. Fill to between  $\frac{1}{4}$  inch and  $\frac{5}{8}$  inch below the surface of the concrete and minimize any overflow (*Standard Specifications* Section 5-05.3(8)B).
20. Check pavement for early age cracking. Early age cracking is caused by volume changes as the concrete cures. These are usually hairline cracks and if they go unnoticed will lead to premature slab repair in the future.

## **SS 5-05.3 Construction Requirements**

### **SS 5-05.3(1) Concrete Mix Design for Paving**

The Contractor shall provide a concrete mix design for each design of concrete specified in the Contract. The proportions shall be determined in accordance with ACI 211.1. The same concrete Mix Design No. may be used in several of a concrete suppliers Plants. Note that a unique identification for the mix design is comprised of the combination of the Mix Design Number and the Plant Number.

### **SS 5-05.3(3) Equipment**

A very important factor in obtaining a superior product with slip form paving is uniformity of operation. The Engineer should ensure that the plant, mixing facilities and hauling units are in quality and quantity balance to supply the paver with an adequate quantity of concrete for continuous operation at the recommended speed, without sacrificing uniform slump. Considerable pavement roughness can be attributed to spasmodic operation, and this should be held to a minimum.

#### **SS 5-05.3(3)B Mixing Equipment**

Nonagitating trucks are permitted to haul plant mixed concrete provided the concrete is delivered and discharged within 45 minutes after the introduction of mixing water to cement and aggregates, and the concrete is in a workable condition when placed Paver.

**SS 5-05.3(3)C Finishing Equipment**

The slip form paving equipment must be self-propelled and capable of placing, spreading, consolidating, screeding, and finishing the freshly placed concrete to the proper pavement elevation and cross-section within the specified tolerances. Sliding forms on the paver must be rigid to prevent spreading of the forms. The paving equipment must finish the surface in a manner which will minimize hand finishing.

Slip form pavers contain various combinations of all or some of the following components: auger spreader, spud vibrators, oscillating screeds, tamping bars, and pan floats. The equipment should be checked for calibration and satisfactory operation in accordance with the manufacturer's manual before paving is allowed to proceed.

If it is necessary to stop the forward movement of the paver, the vibratory and tamping elements should also be immediately stopped. No tractive force should be applied to the machine except that which is controlled from the machine.

**SS 5-05.3(5) Mixing Concrete**

It is very important that uniform consistency of the concrete be maintained with the water/cementitious ratio not exceeding 0.44 and the edge slump not exceeding ¼-inch. The *Standard Specifications* requirements for the water/cementitious ration is in Section 5-05.3(2) and the edge slump requirement is in Section 5-05.3(11). The current requirements for water/cementitious ratio and edge slump are intended to control consistency.

**SS 5-05.3(6) Surface Preparation**

Ahead of the paving operation, the Subgrade must be properly prepared with some type of "fixed" control template to accommodate the width of the paver. The Subgrade must be properly dampened so as to have no water demand from the mix, but, also, the concrete must not be placed on Subgrade on which pools of water have formed. If concrete is delivered by trucks on the grade, Subgrade disturbance should be kept at a minimum.

The Subgrade should be shaped and thoroughly compacted. Special attention should be directed to see that all parts of the Subgrade are firm and unyielding. Soft spots should be removed and backfilled with suitable material. *Standard Specifications* Section 5-05.3(6) requires that the Subgrade be prepared and compacted a minimum of 3 feet beyond each edge of the area to receive the concrete pavement in order to accommodate the width of the slip form paving equipment. The 3 foot extensions on each side of the Subgrade are tracklines that the slip form paving machines tracks will follow, and the smoothness of the tracklines directly affects the smoothness of the concrete pavement.

The Subgrade must be trimmed to the proper Subgrade elevation and shape. After trimming, the Subgrade shall be thoroughly wetted and compacted to achieve a dense unyielding surface. The Subgrade must be kept in this condition until the concrete is placed.

The elevation of the Subgrade should be checked either by stretching a stringline between the control wires and measuring down to the surface or by another method that provides for a satisfactory check. Extra checks should be made through crown and super transitions to be sure proper adjustments were made in the machine through this area and that no high spots exist.

## Controls

If control stakes have not been set for previous operations, they need to be installed at this time. If the control stakes have previously been set, the installation of the wire shall be checked to verify that it is set to the proper line and grade. This is especially important if the wire is offset from its original position.

### SS 5-05.3(7) Placing, Spreading, and Compacting Concrete

As paving progresses, the Inspector should be alert to the wire position just ahead of the machine, since the most precisely set control can be disturbed by workers or equipment hitting it. If you notice anyone or anything bumping, touching, leaning on or otherwise in contact with the control wire, notify the Contractor immediately. It is much easier to correct a misaligned control wire than repair the pavement after it has been placed.

The unconsolidated concrete in front of the paver should be kept well distributed by spreading or by dumping. As the truck or mixer discharges the mix onto the grade in front of the paver, the forces delivered to the machine should be held to a minimum, with all systems functioning as designed. If the paver is not moving, the vibration should be off. When vibration is in progress, it is important that the concrete becomes uniformly plastic for the full slab width as it passes through the vibration area. A lack of consolidation at one position on the machine could cause a potential fracture line parallel to the direction of movement and also a rough and uneven finished surface. The head of material in front of the paving machine should always be in accordance with the manufacturer's recommendation.

It is possible that experimentation may be necessary at the beginning of paving. To start, no trailing forms should be used on the machine and all finishing equipment should be engaged. This could then be modified if problems occur. One of the prime contributors to edge slump is high slump concrete. This should not be tolerated. Another is tie bar insertion for abutting lanes, which should be installed ahead of the final finishing.

Edge slump of the unsupported sides behind the paver is one of the major problems to be combated on slip form paving. The surface should be immediately straight edged by the Contractor and methods corrected to deliver a consistently true edge. Trailing forms can be used to give support beyond the length of the paver, but this may not be the answer. It is possible that more damage than good is done by trailing forms in some cases, by drag resistance pulling down the edge, or by mechanical vibration transmitted through the paver linkage to the form. This comment is also applicable to a trailing finisher. Remember that the concrete is between the moving forms only a few minutes and does not take its initial set until long after the forms leave it.

If water is added to the surface from a spray bar at the rear of the machine it should be in the form of a fine fog spray to avoid washing of the surface and extreme care must be exercised to see that the amount of water added is held to a bare minimum. Addition of excessive amounts of water during finishing will weaken the surface of the concrete and may result in hair checking or scaling of the pavement surface at an early date. If a considerable amount of water is continually required to finish the concrete, it may be better to add more water to the concrete mix to reduce the need for spraying water on the surface. Rain on a green unformed slab can cause disastrous edge slump and erosion. The Contractor should be encouraged to halt operations previous to this circumstance, and should be prepared to protect the pavement at all times.

Soon after the paving starts, and periodically thereafter, the slab template should be checked to insure that the “dry” template has not changed. This is done by stretching a line over the transverse wires and measuring down. This check should also be made through curves and transitions to ensure that the proper section adjustments are being made.

The slip form paver behaves similarly to an asphalt paver with the front probe approximately  $\frac{3}{16}$  inch higher than the rear. This will probably vary with the machine, due to mass distribution, etc.

Slope of less than this produces an unstable characteristic and an undulating profile, slopes in excess of the correct one cause the machine to repeatedly build up and then slump down. If the symptoms occur, this is one place to check. The machine also has about  $\frac{3}{4}$  inch convergence in the sides, to encourage stability. Hand finishing, water adding, and other surface manipulation should be kept at a minimum.

### **SS 5-05.3(7)B Stationary Side Form Construction**

Metal side forms or other forms accepted by the Project Engineer, conforming to the requirements of *Standard Specifications* Section 5-05.3(7)B, shall be used for the construction of cement concrete pavement when a slipform paving machine is not used unless the Contractor requests to use an accepted slip form machine.

It is essential that the base of the forms used have full, equal bearing upon the Subgrade throughout their length and width. The forms should be set true to alignment and grade and firmly staked with steel pins to avoid movement. The forms must never be set on blocks or pedestals. After the forms are firmly staked in place, a final inspection of line and grade should be made by sighting along the tops of the forms. Minor adjustments in grade can be accomplished by tamping additional Subgrade material under the form base by an accepted mechanical form tamper or by inserting small leveling wedges under the forms. It is important that the leveling wedges do not protrude into the cement concrete pavement so as to prevent uncontrolled cracking in the concrete pavement at the locations of the wedges. A small amount of concrete may seep under the forms and this concrete needs to be removed flush with the vertical face of the existing concrete pavement prior to placing new cement concrete pavement next to existing concrete pavement.

If major changes in alignment or grade are required, the forms should be removed and the Subgrade reshaped to the proper elevation and recompact before resetting the forms.

### **SS 5-05.3(8) Joints**

**Isolation Joints** – Drainage features and manholes placed within the concrete pavement are likely to cause a crack to develop in the concrete and need to be isolated from the rest of the concrete pavement by some type of premolded joint filler. Consult the contract plans and or *Standard Plans* for details. If no details are found contact the State Construction Office for guidance.

### **SS 5-05.3(8)A Contraction Joints**

Longitudinal and transverse contraction joints shall be provided by saw cutting the surface in accordance with *Standard Specifications* Section 5-05.3(8) to the depth specified in *Standard Plan A-40.10*. The joints shall match transverse joints on adjacent concrete pavement and be at 15 foot intervals transversely on other areas.



As concrete cures and hardens, a change in volume occurs due to loss of moisture and cooling. This shrinkage results in tensile stresses being set up in the pavement, causing cracks to develop. History has shown that transverse cracks will develop at about 15 foot intervals along the length of a slab, and that a slab wider than 15 feet may crack longitudinally. The spacing for transverse contraction joints is a maximum of 15 feet; see *Standard Plans A-40.10-00* for more information on spacing of transverse joints.

The purpose of contraction joints is to control the cracking of the concrete, thereby preventing ragged random cracks that spall and require expensive maintenance. Good construction of these joints is of the utmost importance, and inspection of this work is one of the most important phases of the Engineer's duties.

Contraction joints are weakened planes that collect the cracking into a controlled joint. These joints are made by sawing and pouring a hot or cold filler into the joint. The purpose is to create a maintainable joint in the slab and cause the crack to form along the plane of the joint.

This type of joint is constructed by sawing a groove in the hardened concrete to create a plane of weakness along which the crack will form. The saw cuts are made with the circular saw blades edged with diamonds. On full width construction, a gang sawing machine using several blades simultaneously is generally used to saw the transverse joints. When the gang sawing machine is used, the Inspector must see that the individual blades are properly aligned and set to cut the required depth.

It is necessary to control the time of sawing transverse joints very carefully, so that sawing may be done when concrete has hardened as much as possible without delaying so long as to allow development of random cracks. It is impossible to state a sawing schedule that will be ideal for every job, since curing conditions vary a great deal from job to job. Some generalizations can be made concerning sawing, but the Contractor on each job must determine from experience the most suitable schedule for that job.

It is desirable to delay sawing as long as possible to allow the concrete to gain enough strength to resist raveling adjacent to the saw cut. Sawing green concrete produces excessive wear on the saw blades, and causes washing, raveling, and other structural damages to the concrete near the joint. However, it may be necessary to make some early cuts to control cracking.

In general, a program of sawing control joints should be followed, sawing every fifth joint, not to exceed 64 feet, as soon as the concrete hardens sufficiently to resist excessive raveling. The beginning of sawing may vary depending on the type of base, concrete mix characteristics and weather. Sawing of the intermediate joints should follow the sawing of the control joints. It will usually be found possible to delay sawing the rest of the joints until the day following placement of the concrete (see *Standard Plan A-40.10-00* for more information).

By observing the frequency of cracking and opening of joints the next day, it will be possible to lay out a sawing schedule that will give best results. If only the control joints are cracked, the sawing of the intermediate joints can be delayed further, given fairly constant weather conditions.

The Contractor should mark off the locations of the transverse joints and the inspector should check the spacing and frequently check to see that the specified depth of cut is sawed. The locations of the dowel bar baskets need to be marked on the grade prior to the dowel bar baskets being covered by the concrete pavement in order to correctly

locate the transverse joint saw cut in the middle of the dowel bars. Since much of the sawing will be done at night, the Inspector should be equipped with a good flashlight to properly examine the condition of saw cuts and to watch for random cracks.

When paving a lane adjacent to a previously paved slab, an early morning examination of joints in the existing lane will show the joints that are open and working. These locations should be marked for sawing control joints in the second lane. Friction at the construction joint and the tie bars will transmit stresses to the new slab and may cause random cracking to occur. For the same reason, uncontrolled cracks in the first lane should be matched with a control joint in the second. In addition, when cement concrete pavement is placed adjacent to existing cement concrete pavement, the vertical face of all existing working joints shall be covered with a bond breaker, such as polyethylene film, roofing paper or other material as accepted by the Engineer to prevent uncontrolled migration of the crack into the adjacent slab (*Standard Specifications* Section 5-05.3(8)A). If the Contractor proposes to use material other than polyethylene film or roofing paper as a bond breaker, the Project Engineer shall consult with the State Construction Office on the suitability of the proposed bond breaking material.

#### **SS 5-05.3(8)B Sealing Sawed Contraction Joints**

Prior to opening of the pavement to traffic, sawed joints must be sealed with an accepted type of filler material. Before application of the filler material, the joints must be thoroughly clean and dry. The sawed joints shall be free of dirt and dust. It is important that the saw cut be completely filled to within  $\frac{1}{4}$  inch to  $\frac{5}{8}$  inch below the top of the concrete surface with the joint filler material. The Inspector can check this by probing the joint after sealing with a stiff wire and watching for sagging of the filler below the top of the joint.

#### **SS 5-05.3(8)C Construction Joints**

A construction joint shall be made at the end of each day's paving by placing a header board transversely across the pavement. Uncapped dowel bars should be installed in the joint, seeing that the dowels are parallel with the centerline and profile of the pavement. The ends of the dowels projecting from the header should be protected so that they will not be disturbed or moved from their correct positions.

Prior to beginning paving the following day, any broken curing seal on the end of the previous day's work must be re-sprayed with curing compound, and exposed dowel bars shall be coated with a parting compound, such as curing compound or grease to allow for future slab movement.

#### **SS 5-05.3(9) Joint Matching Pre-Existing Pavement Joints**

Prior to paving new PCCP in a driving lane, diamond grind a minimum of 3 feet of any preexisting pavement, that is scheduled to remain at the completion of the project, and is longitudinally adjacent to the new PCCP. This will produce a smooth surface to tie the new PCCP in to. The preexisting pavement shall be ground regardless if it is PCCP or bituminous.

**SS 5-05.3(10) Tie Bars and Dowel Bars**

Tie/dowel bars must be installed where specified in the *Standard Plans* M 21-01 (see *Standard Plan Series* A-40 and A-60). Tie bars must be placed so that equal lengths of the bars project into the two lanes of adjoining pavement. When paving two or more lanes at a time, the tie bars are placed at the juncture of the lanes by mechanical means. The Inspector must be alert to see that the bars are set at the proper spacing and depth and are properly centered between the two lanes.

When placing tie/dowel bars in the edge of a slab, the ends of the bars projecting from the forms should be protected against disturbance that might destroy the bond between the concrete and steel. The bars already in place shall be bent to lie close to the slab to permit preparation of the Subgrade of the adjoining lane, and carefully straightened to their proper position before placement of concrete.

**SS 5-05.3(11) Finishing**

After the concrete has been given the preliminary finish by the paving machine, minimal hand finishing may be required before the Contractor checks the surface with a straightedge device not less than 10 feet in length. High and low areas indicated by the straightedge shall be corrected. The requirements of checking the surface with the straightedge may be waived if it is demonstrated that other means will consistently produce a surface that meets the requirements for surface smoothness.

The final pavement texturing shall be either a tined finish or a finish produced by cement concrete pavement grinding.

For a tined finish, the pavement shall be given a final finish by texturing with a wire comb parallel to the center line of the pavement. The tining on small or irregular areas may be either parallel or perpendicular to centerline. It is important that the comb be used when the concrete is at the proper consistency. If the concrete is too soft, it will not retain the proper texture obtained by the comb, and if the concrete is too hard, the proper texture will not be achieved. The comb should be set up and ready to use well in advance of the time it will be required.

For a ground surface the pavement surface shall be ground to produce a uniform corduroy like texture in compliance with SS 5-01.3(9)A.

**SS 5-05.3(12) Surface Smoothness**

Smoothness is one of the most important pavement characteristics to road users. A smooth pavement provides a comfortable ride and reduces road noise. In addition to comfort, longer pavement life, reduced fuel consumption and less vehicle wear and tear are all attributes associated with smoother pavements. It is one of the factors that the public associates with the quality construction which reflects on the agency constructing it.

WSDOT uses the International Roughness Index (IRI) to evaluate pavement smoothness. IRI is a measure of smoothness in one wheel path only. Since both wheel paths affect pavement smoothness WSDOT averages the IRI in each wheel path to produce the Mean Roughness Index (MRI). When the term IRI is used within WSDOT, what is most often meant is MRI.

Driver comfort depends on how much of the pavement roughness is transmitted through a vehicle's suspension to the driver and occupants. MRI predicts driver comfort by using an algorithm to simulate the suspension movement felt by the driver of a virtual car. The higher the MRI the more the driver feels roughness in the pavement. When evaluating the MRI of a pavement it should be remembered that the goal of MRI testing is to improve driver comfort.

The Contractor is responsible for providing the inertial profiler and operator used for smoothness testing. To ensure the profiler is accurate and the measured profile is repeatable, the inertial profiler must have been certified within the last 12 months and the operator must have been certified within the last three years. Inertial profilers will either be certified by a certification facility or by another state. Profilers certified by a certification facility are required to display a decal or other approved marking as evidence of certification and the certification expiration date. If the inertial profiler is certified by another state, the Contractor is required to submit documentation verifying the profiler certification. Contact the State Pavement Office to verify that the certification meets the requirements of AASHTO R 56.

The specifications require MRI testing on all lanes of cement concrete pavement 0.25 miles in length or longer. Ramps, tapers and shoulders are exempt from IRI testing. All cement concrete pavement must meet 10-foot straightedge requirements regardless of whether it is subject to MRI testing or not.

The Contractor is responsible for collecting and analyzing the MRI data. The Contractor evaluates the profiles and submits the results to the Project Engineer for verification. Verification of the profile should include the following:

1. The filter setting used at the time of certification were used for the testing
2. The location of start, stop and excluded areas are correct
3. The MRI for each 52.8 foot (0.01 mile) segment has been measured (including excluded areas)
4. Incentive/disincentive is calculated correctly
5. Locations requiring corrective action are indentified.

The Contractors data should be verified using the Ride Quality Analysis tool in ProVal. The Project Engineer should request verification testing if there is reason to believe the Contractors testing is not accurate. Contact the State Pavement Office for assistance using ProVal or verification testing.

The Contractor is required to measure the smoothness of 52.8 foot segments that have an MRI greater than 125 inches per mile with a 10-foot straightedge. Locations that vary more than  $\frac{1}{8}$  inch from the lower edge of a 10-foot straightedge placed on the surface parallel to the centerline require corrective action. The goal of corrective action is to improve driver comfort by removing bumps that are causing the high MRI. If the Project Engineer determines that corrective action will not improve driver comfort the rough concrete pavement may be accepted with a credit as provided for in Section 5-05.5.

Travel lanes that are not subject to incentives and disincentives for MRI testing are still required to meet straightedge requirements. The Contractor is required to check them no later than 5:00 pm following the day of paving. If these areas do not meet the straightedge requirement, corrective action is required.

**SS 5-05.3(13) Curing**

Immediately following final finishing of the concrete or after free water leaves the surfaces, the curing compound should be applied. The purpose of curing, whatever method is used, is to prevent the loss of moisture required to hydrate the cement so that the concrete will gain its proper strength and durability. It is essential that a complete coverage of curing compound be applied to seal the exposed surface of the pavement.

On most paving work, specifications will call for machine application of the curing compound. It should be seen that the spray nozzle is adequately protected from the wind by shielding so that the compound is not blown off the pavement surface. The Inspector shall check to see that the specified rate of coverage is obtained.

The efficiency of the curing compound in preventing escape of moisture from the concrete is dependent upon the thickness of the membrane. For this reason, it is essential that the compound be evenly applied over the exposed surface at a rate of 1 gallon to not more than 150 square feet. Refer to *Standard Specifications* Section 5-05.3(13) for additional requirements for curing.

The curing membrane must be protected from damage by foot traffic or equipment. There is a certain amount of foot traffic required in sawing joints, operating the profiler and other operations. This traffic should be held to a minimum, and if damage from undue scuffing or other causes does occur, the area shall be re-sprayed with the required amount of curing compound. Care must be exercised so that curing compound is not sprayed into saw cuts, as the joint sealing compound will not adhere to the concrete in the joints if the curing compound is present.

When pavement is being constructed in early spring or late fall, the Project Engineer must be alert to predictions of freezing weather, and see that the Contractor is prepared to protect the fresh concrete from freezing, as required in *Standard Specifications* Section 5-05.3(14).

When special protection against freezing is required, the protective earth or straw covering must be placed against the sides of steel forms, if used, as well as on the surface of the pavement, since steel offers poor insulation to the change in temperature.

**SS 5-05.3(17) Opening to Traffic**

*Standard Specifications* Section 5-05.3(17) covers the requirements for opening cement concrete pavement to traffic. During the curing period designated for the concrete mix, the pavement must be properly barricaded to close it to all traffic. If necessary, the Contractor may be required to furnish a person to prevent traffic from using the pavement.

When the pavement has developed a compressive strength of 2500 psi, as determined from cylinders made at the time of placement, it may be opened to traffic. The pavement should be cleaned either by brooming or a pickup sweeper prior to opening.

**SS 5-05.3(22) Repair of Defective Pavement Slabs**

Broken slabs, slabs with random cracks, nonworking joints near cracks, edge slumping and spalls along joints and cracks must be replaced or repaired prior to completion of joint sealing. Areas of concrete pavement that are identified as needing replacement or repair need to be reviewed by the Project Engineer to determine if a repair or replacement of the concrete is most appropriate in accordance with *Standard Specifications* Section 5-05.3(22). There are times that small defects or spalls in the concrete should not be repaired as the repair is worse than leaving small defects or spall alone. The Project Engineer shall consult with the State Construction Office in making the determination on which areas should be repaired, replaced or leaving small spalls or defects alone.

**SS 5-05.5 Payment****SS 5-05.5(1) Pavement Thickness**

*Standard Specifications* Section 5-05.5(1) outlines procedures for thickness determinations and provides penalties when prescribed tolerances are exceeded. Before final payment, the pavement thickness will have to be determined in order to calculate the quantities.

## 6-01 General Requirements for Structures

### GEN 6-01.1 Bridge Construction De-Briefing Session

In an attempt to continually improve the quality of bridge contract plans, specifications and estimates and to obtain feedback on engineering and construction practices, the Bridge and Structures Office is available to assist in conducting post construction De Briefing Sessions for “Capturing Lessons Learned.” The purpose of these De Briefing Sessions is to provide designers with feedback on positive things that worked well and things that could be improved.

The Project Engineer, Bridge Technical Advisor, or Bridge Design Unit Manager should consider initiating a De-Briefing Session on those projects where they feel feedback to the designers would benefit the quality of future construction plans. Suggested projects include Bridge Rehabilitation Projects, Bridges with complex staging, substructure conditions, or new material applications. Suggested attendees at these sessions should include Region Project Office Staff, State Construction Office, Bridge and Structures Office, Design Consultants, and the Contractor involved in the structural work.

The Bridge and Structures Office will assist the Project Engineer in organizing and facilitating the De-Briefing Session once it is agreed to go forward with a De-Briefing Session. The Project Engineer will be responsible for making all contacts with Contractor personnel.

The Project Engineer should determine the timing of the De-Brief session with respect to the contract work. Scheduling the session too long after the contract work is complete may diminish the Contractor’s willingness to participate or recall of the issues for discussion. Scheduling a session too soon before completion of all contract related activities may cloud issues currently under discussion. The Project Engineer should exercise caution in selecting the proper timeframe for this session.

More information on these sessions, including De-Brief Meeting guidelines, typical agenda, and De-Brief report outline, are available on the Bridge and Structures Office’s homepage at [www.wsdot.wa.gov/eesc/bridge/cecw/index.cfm](http://www.wsdot.wa.gov/eesc/bridge/cecw/index.cfm).

### GEN 6-01.2 General Inspection Procedures

The intent of the Contracting Agency inspection is to provide Quality Assurance (Q/A) for the work performed. Often this task creeps into the Quality Control (Q/C) function which is the contractor’s responsibility. There is usually no need for an inspector to observe the entire construction operation unless there are compelling reasons.

Because of the wide variety of types and designs of structures, the Project Inspector should be thoroughly familiar with all of the Contract documents as they provide the specific materials requirements, dimensions, and other details that make each structure unique.

Set up part of the inspection documentation records in advance so that the actual dates, dimensions, quantities, and other values can be more easily filled in as the work progresses.

### **GEN 6-01.4 Safety Nets and Staging**

Fall arrest and protection shall be provided. Reference [WAC 296-880](#) *Fall restraint, fall arrest systems*. A Fall Protection Work Plan shall be on site.

*Standard Specifications* Section 1-05.6 requires the Contractor to furnish sufficient, safe, and proper facilities such as walkways, railings, ladders, and platforms for inspection of the work. The Project Engineer should insist that the Contractor provide safe facilities and should not permit WSDOT personnel on the project when it is not safe for them.

### **SS 6-01.2 Foundations**

Elevations of bottoms of footings, as shown in the plans are determined from information secured from test holes or borings or other sources. The Project Engineer shall observe the character of the materials removed to confirm the material is similar to that identified in the test borings. If the material is similar, they shall note the elevation of such material and approve the footing elevation. If the material differs from the test borings, the State Construction Office shall be consulted for an evaluation. Except in solid rock foundations, it is necessary to carry all footings well below any possible line of scour. Footings in streams are often carried to greater depths when hard material exists than they would be in the same material where danger of scour exists. Footings on solid rock shall be well keyed into the rock to prevent sliding of the structure. Keys should not be less than 1 foot deep and the rock surface should be rough so it has more value as a key. Arch abutments may be designed with bottoms on an inclined plane. Care must be taken that the rock or other material is cut as nearly as possible to the plane shown. If this cannot be done, the material should be removed to a satisfactory foundation, cross-sections taken and the State Construction Office should be advised and requested to secure a new design of the abutment. Material at the heel, or back of the abutment, shall be carefully removed and all loose material removed. In placing concrete in arch abutments, the concrete is placed directly against the undisturbed foundation material at the back of the abutment for the reason that an arch abutment is subject to very high vertical and horizontal loads. Footings in hard material are sometimes sloped or stepped. Steps must be carefully made and if the material is not hard enough to stand vertically the steps shall be inclined or beveled. The slope shall not be steeper than the angle of repose. Backfilling to level up foundations or to fill holes will not be allowed except by permission of the State Construction Office. Under certain conditions, permission will be granted to fill a hole with a lean concrete mix. If the design soil pressure is low, unsuitable material may be replaced by granular material compacted to 95 percent density. If there is no contract unit price for the replacement material, an agreed unit price must be secured by change order. Just prior to placing concrete, all loose material shall be removed and, if in the dry, shall be well sprinkled with water before concrete is placed.

### **SS 6-01.4 Appearance of Structures**

Bridge traffic barriers, curbs, bridge railings and rail bases shall be carefully aligned to give a pleasing appearance. See Section 6-06 for further instructions.

### **SS 6-01.6 Load Restrictions on Bridges Under Construction**

It is important that bridges under construction remain closed to all traffic, construction equipment, and material storage (that will not become part of the bridge span) until the Substructure and the Superstructure, through the bridge deck, are complete for the entire Structure. The Contractor may request to allow traffic, construction equipment



and material loads (in addition to those that will become part of the bridge span) if it is necessary and safe to do so through a Type 2E Working Drawing. See the *Standard Specification* for the specific submittal requirements. Completion includes release of all falsework, removal of all forms, and attainment of the minimum design concrete strength and specified age of the concrete in accordance with the *Standard Specifications*. Once the Structure is complete, Section 1-07.7 shall govern all traffic loading, including vehicle traffic and construction equipment.

The Contractor may only store material on a bridge span under construction that will become part of that bridge span. The material shall not be stored within the middle third of the span. At the request of the Engineer, the Contractor shall provide supporting documentation of all material loads. The reasoning for not allowing materials in the middle third of the span is to avoid overstressing girders. They do not have full capacity until the bridge deck gains strength and becomes composite with the girders.

### SS 6-01.9 Working Drawings

The Contractor is required to submit for review detailed plans for falsework, concrete forms, cofferdams, shoring, and cribbing. These plans must comply with the requirements of the contract plans and specifications and shall be designed under the supervision of or by a Washington State licensed professional engineer and shall bear their seal and signature.

The Project Engineer should review the submittal, when appropriate, for the following content:

1. Ground line at time of construction when falsework, shoring, and cribbing are involved.
2. Horizontal clearances to adjacent roadways, existing structures, and railroads when shoring and cribbing are involved.

A change order is required for any deviation from the contract. Deviation from a working drawing requires Headquarters' review and concurrence. Review of these submittals must be completed before the Contractor starts construction of the structure.

If a project has a large number of working drawings associated with it the Project Engineer should talk to the contractor about prioritizing his submittals. The project engineer should share this information with the State Bridge and Structures Engineer so that the review process can be accomplished in the most efficient manner for the contractor.

The Contractor shall submit drawings per the contract and Section SS 1-05.3 of this manual.

The Project Engineer will review the plans to see that they comply with the submittal requirements of the contract and send any comments to the State Bridge and Structures Engineer (or Terminal Design Engineer) about any field conditions or contract deficiencies that would affect the checking of the plans.

When pre-contract reviewed formwork plans are used, the Contractor shall submit a copy of the plans to the Project Engineer. The Project Engineer must then advise the Contractor that construction may proceed unless a field condition needs to be resolved before doing so.

Forms for concrete deck on steel or prestressed concrete girder spans shall be fully supported on the girders. They shall in no case extend to the ground unless the steel girders are also supported on piles or posts.

The Project Engineer shall see that the falsework and forms are constructed in accordance with the submitted plans. If it becomes necessary, or the Contractor desires to deviate from the submitted plans, a revised plan for review shall be submitted and the Contractor shall not start construction in accordance with the revised plan until the review is complete. All revisions to the plan shall be reviewed by the State Bridge and Structures Engineer (or Terminal Design Engineer) to ensure the structural integrity of the falsework and formwork.

### **SS 6-01.12 Final Cleanup**

When the structure is completed, the Contractor shall clean up the site and remove all materials and debris. The decks of the structures shall be clean. The Contractor shall level off and fine grade all excavated material not used for backfill, and fine grade around all piers, bents, abutments, and on slopes so that the entire site and structure is left in a clean and presentable condition.

Unless environmental permits require otherwise, remove all falsework piling, cofferdams, shoring, curbs, and test piles to a minimum of 2 feet below the finished ground line. Removal limits within a stream or channel are described in *Standard Specifications* Section 2-09.3(3)D.

After a permanent or temporary bridge or a bridge modification is complete and preferably before opened to traffic, the State Bridge and Structures Office's Bridge Preservation Section needs to perform an inventory inspection. The purpose of this inspection is to field verify certain contract plan details, to provide a base-line condition assessment of the bridge, and to identify any potential problem features.

When the bridge is nearing completion, two to four weeks before completion, the Project Engineer should notify the State Bridge Preservation Engineer of the anticipated completion date. The Bridge Preservation Engineer will make arrangements with the Project Engineer for an inventory inspection.

### **SS 6-01.16 Repair of Defective Work**

The purpose of this section is to contractually allow structural repairs without requiring a change order and to define requirements for structural repairs. It is not intended to overwrite or duplicate submittal requirements or require submittals for repairs described elsewhere in the Contract Documents.

The WSDOT Project Engineer shall consult with the ASCE and an appropriate licensed professional engineer (such as the engineer-of-record, the Bridge Technical Advisor (BTA), the State Bridge Construction Engineer, etc.) to make a determination of whether a repair procedure that is not pre-approved requires engineering as well as whether a pre-approved repair procedure is appropriate for use for the intended repair.

Pre-approved repair procedures for precast and prestressed concrete plants are located in their annual approval document. They are reviewed and approved by the State Construction Office. The process is described in the *WSDOT Materials Manual*, Standard Practice QC 6 and QC 7.

Working drawing submittals for repairs are primarily intended to provide the Engineer an opportunity to review and comment on repair procedures, facilitate proper inspection of the repair work, provide documentation of the repair, and assist the Engineer in preparation of the as-builts. All repairs shall be documented in the as-builts.

When construction issues at precast/prestressed concrete plants and steel fabrication plants need to be expedited, the fabricator may prepare a problem resolution form describing the problem and proposed resolution. The fabricator notifies the WSDOT Fabrication Inspection Office and receives their concurrence the problem has been accurately described on the Problem Resolution document. The concurrence is noted on the problem resolution form. The document is then emailed to both the Contractor (the Contractor forwards this on to the Project Engineer) and to the WSDOT Construction Office. The email addresses "[structuralsteelprr@wsdot.wa.gov](mailto:structuralsteelprr@wsdot.wa.gov)" for steel structures and "[precastprrr@wsdot.wa.gov](mailto:precastprrr@wsdot.wa.gov)" for precast concrete structures distribute to all of the WSDOT Construction Engineers and to the WSDOT Seattle Inspection Office. The WSDOT Construction Office reviews the document and prepares a recommendation for the Project Engineer. The WSDOT Project Engineer and the WSDOT Construction Office work together to address the fabricators proposed problem resolution. The Project Engineer will send the approval (or disapproval) to the Contractor and the WSDOT Fabrication Inspection Office.

#### **SS 6-01.16(2)A Concrete Spalls and Poor Consolidation (Rock Pockets, Honeycombs, Voids, etc.)**

This pre-approved repair procedure requires the Engineer to make a determination of whether the intended repair may affect structural adequacy. The Project Engineer shall consult with the ASCE and an appropriate licensed professional engineer (such as the engineer-of-record, the Bridge Technical Advisor (BTA), the State Bridge Construction Engineer, etc.) to make this determination.

Repairs that may be considered to affect structural adequacy include but are not limited to:

- Areas that extend deeper than the outer layer of reinforcement in members (or portions of members) that are or will be in compression such as columns, walls and portions of beams. Note that many repairs in compression areas will be able to be effective over time as the original un-damaged concrete creeps and transfers compression to the repair. This is especially true for high strength, low shrinkage repair materials.
- Areas in concrete that are already loaded by subsequent actions such as prestressing, release of falsework, subsequent material placement, or applied earth pressure
- Areas with significant reinforcing steel damage, corrosion or section loss.
- Areas with significant overhead work
- Areas that have been previously repaired
- Areas adjacent to post-tensioning anchorages
- Areas with numerous or large spalls in the concrete surface

The full extent of the damage may not be known until the damaged concrete is removed. For this reason the Contractor is directed to stop work after initial concrete removal. The Project Engineer may require the Contractor to submit a modified repair procedure. This may be appropriate when the area or volume of concrete is significantly greater than originally estimated or reinforcement/embedments are damaged or displaced. Other unforeseen conditions may also arise which may bring the validity of the pre-approved repair procedure into question. The Project Engineer should consult with the ASCE and appropriate licensed professional if it is suspected that the pre-approved repair is no longer appropriate. The Project Engineer can then require a revised repair procedure be submitted by the Contractor.

Shrinkage-compensating repair materials are made with an expansive cement or expansive component system in which initial expansion, if properly restrained, offsets strains caused by drying shrinkage. Shrinkage-compensating repair materials may not be appropriate if the repair area will not sufficiently restrain the initial expansion of the repair material with forms, surrounding concrete and reinforcement passing through the repair area.

## 6-02 Concrete Structures

### GEN 6-02.1 Use of Epoxy Resins

Quite frequently, the use of epoxy resin systems on our projects is considered; either at the design stage or during the progress of a contract. Generally this use is in connection with repair of distressed concrete or in setting rebar.

Epoxy resins are quite versatile materials and are capable of providing the answer to numerous bonding or grouting problems. However, like a number of products, there is a tendency to treat them as a universal cure-all and they occasionally are applied without proper consideration of inherent limitations.

Epoxy systems are capable of providing many different properties through the formulation of their various components. To a certain extent, the systems can be tailored to fit the particular need and conditions of time, temperature, humidity, etc., that will prevail. Use of a material under conditions beyond those for which it was formulated can result in considerable trouble rather than benefit. Probably the greatest potential for trouble exists in the use of epoxies at temperatures below which a normal reaction can occur. Generally speaking, unless a specially formulated epoxy is being used, trouble can occur when application is attempted below 50°F.

The State Materials Engineer is available as a technical resource on the use of such systems, in the resolution of pertinent problems should they occur during preliminary design considerations, or as a result of problems during construction. It is strongly recommended that any contemplated use of epoxy resin systems at application temperatures below 50°F be checked with the State Chemical Materials Engineer to forestall potential difficulties.

If epoxy resin is used, the following elements need to be carefully checked by the Inspector:

- Proper mixing and curing of the epoxy resin.
- Temperature and/or moisture limitations of the epoxy being used.
- That the areas are clean and prepared in accordance with the manufacturer's recommendations.
- That the epoxy covers the entire repair area.
- That the epoxy fills the entire space between bar and the hole (if bars are being set with epoxy resin).
- That the epoxy is still tacky (not set) when it is being used to bond two structural elements together (just before elements are put together).

For setting rebar or anchors, it is best to determine the volume required to be filled by the epoxy and measure the epoxy being used. A method of measurement should be agreed to with the Contractor for inspection purposes. Also, occasional samples should be taken of the epoxy resin being placed to be sure it is setting up properly. If there is any question of filling the void or adequacy of the epoxy resin, the Inspector shall advise the Contractor, document the discussion, and report it to the Project Engineer.

## SS 6-02.3 Construction Requirements

### SS 6-02.3(2) Proportioning Materials

Mix design, proportioning, and mixing concrete is the responsibility of the Contractor. General information regarding proportioning and mixing concrete is provided in Appendix A at the end of this chapter to provide a better understanding of the variables involved.

#### SS 6-02.3(2)A Mix Designs

The *Standard Specifications* require the Contractor to provide a mix design for all classes of concrete specified in the Plans except for those accepted based on a Certificate of Compliance. The mix design should be submitted on Proposed Mix Design (DOT Form 350-040). The same concrete Mix Design No. may be used in several of a concrete suppliers Plants. Note that a unique identification for the mix design is comprised of the combination of the Mix Design Number and the Plant Number. The average 28-day compressive strength shall be selected in accordance with ACI 301, Chapter 4, Section 4.2.3.3 and ACI 201 shall be used to determine proportions. The Project Engineer should review all Contractor proposed mix designs for conformance to the contract. Specific items to look for are:

- Total water soluble or acid soluble chloride ion content
  - Verify the water soluble or acid soluble chloride ion content complies with *Standard Specifications* Section 6-02.3(2).
- Cementitious materials (Portland Cement, Low Alkali Cement, Blended Hydraulic Cement, Fly Ash, Ground Granulated Blast Furnace Slag, Microsilica Fume, and Metakaolin)
  - Verify the products are list on the QPL or have been approved through the RAM process.
  - Verify the type of cement is allowed by the Contract.
  - Check that mill certification demonstrates specification compliance.
  - Verify the proposed quantities within specification limits for the concrete class.
- Aggregate (Coarse, Fine, and Combined Aggregate)
  - Ensure the aggregate is from an approved source by verification of the ASA database.
  - Check if ASR mitigation is required by verifying the ASA database.
  - Verify the mix design submittal includes data for Deleterious Substances.
  - Ensure the Nominal Maximum Aggregate Size (NMS) is correct for the proposed concrete class.
  - Verify the proposed gradations meet the requirements of the concrete class.
  - Make sure the mix design indicates the quantities of aggregate.
- Alkali Silica Reactivity (ASR)
  - If the aggregate source is ASR reactive, verify the Contractor provided mitigation measures.
  - Ensure the mitigation measures demonstrate compliance with *Standard Specifications* Section 9-03.1(1).

- Admixtures
  - Verify products are listed on the QPL or have been approved through the RAM process.
  - Ensure the proposed quantities are within manufacturer's recommendations.
  - Verify all admixtures are from the same manufacturer.
- Water
  - Ensure the quantity of water is indicated on the mix design.
  - Verify the maximum water/cementitious ratio provided is equal to the total water divided by the total cementitious materials indicated on the mix design.
  - Ensure the full amount of water specified in the mix-design is in the test sample.
  - If reclaimed water is proposed, verify that it complies with *Standard Specifications* Section 9-25.1.
- Design Performance (applies to all concrete classes)
  - Compressive Strength
    - o Ensure the break data and ACI equations supporting the concrete are provided with the mix design.
    - o Verify the calculated average compressive strength meet the requirements for the concrete class.
  - Air Content
    - o Verify the mix design indicates entrained air content between 4.5 – 7.5 percent. This criterion does not apply to concrete Class 4000D.
- Design Performance Concrete Class 4000D (additional requirements)
  - Permeability, AASHTO T 277.
    - o Verify the mix design indicates a permeability of 2,000 coulombs or less at 56 days.
  - Freeze-thaw Durability
    - o Verify the mix design indicates an air content between 4.5 – 7.5 percent, or
    - o Resistances of Concrete to Rapid Freezing and Thawing, AASHTO T 161 Procedure A.
    - o Verify the mix design indicates a durability factor of 90 percent minimum, after 300 cycles.
    - o Verify the mix design indicates an air content equal to or greater than 3.0 percent.
  - Scaling Resistances of Concrete Surfaces Exposed to Deicing Chemicals, ASTM C 672.
    - o Verify the mix design indicates a scaling visual rating less than or equal to 2 after 50 cycles.
  - Length Change of Hardened Hydraulic Cement Mortar and Concrete, AASHTO T 160.
    - o Verify the mix design indicates a length change (shrinkage) at 20 days, less than or equal to 0.032 percent.
  - Density (Unit Weight), Yield, and Air Content (Gravimetric) of Concrete, ASTM C 138.

- Design Performance Self-Consolidating Concrete (additional requirements).
  - Slump Flow
    - Ensure the mix design includes the targeted slump flow (WSDOT FOP for ASTM C 1611).
    - Verify the mix design indicates a Visual Stability Index (VSI) less than or equal to 1 (Appendix X1 of ASTM C 1611)
    - Verify the mix design indicates a T50 flow rate less than or equal to 6 seconds. (Appendix X1 of ASTM C 1611).
  - Column Segregation
    - Verify the mix design indicates a Maximum Static Segregation less than or equal to 10 percent (ASTM C 1610).
    - Verify the mix design indicates a Maximum Hardened Visual Stability Index (HVSII) less than equal to 1 (AASHTO PP 58).
  - Passing Ability of Self-Consolidating Concrete by J Ring, WSDOT FOP for ASTM C 1621.
    - Verify the mix design indicates J Ring results equal to or less than 1.5 inches.
  - Rapid Assessment of Static Segregation Resistance of Self-Consolidating Concrete Using Penetration Test, ASTM C 1712.
    - Verify the mix design indicates a penetration depth equal to or less than 15 millimeter.
  - Air Content of Freshly Mixed Self-Compacting Concrete by Pressure Method, WSDOT Test Method T 818.
    - Verify the mix design indicates entrained air content between 4.5 – 7.5 percent.
  - Density (Unit Weight), Yield, and Air Content (Gravimetric) of Concrete, AASHTO T 121.
    - Ensure the mix design includes the unit weight (lbs/ft<sup>3</sup>).
  - Temperature of Freshly Mixed Portland Cement Concrete, AASHTO T 309.
    - Ensure the mix design includes the temperature of the freshly mixed concrete

Air-entrained concrete is required all cast-in-place structural concrete above ground. The use of air entrained concrete below the finished ground line is optional with the Contractor.

To assist with the mix design review process the State Materials Laboratory has developed mix design checklists that can be found on the [Construction Office SharePoint site](#).

The State Materials Laboratory is available to assist with the review of the concrete mix designs.

### **SS 6-02.3(4) Ready Mix Concrete**

#### **SS 6-02.3(4)A Qualification of Concrete Suppliers**

All concrete production facilities which produce concrete other than commercial concrete or lean concrete will be prequalified. Commercial concrete and lean concrete may be batched in production facilities which are not prequalified. The concrete production facility prequalification requires certification by the National Ready Mix Concrete Association (NRMCA). Information concerning NRMCA certification may be

obtained from the NRMCA at 900 Spring Street, Silver Springs, MD 20910 or online at [www.nrmca.org](http://www.nrmca.org). The NRMCA certification shall be valid for a two year period from the date of certification.

The Contractor is required to submit Request for Approval of Materials Source (Form 350-071) listing the name and location of the plant which will supply the concrete and also the source of the cement, aggregates, and admixtures that will be used in the concrete. Concrete from the plant shall not be used until the plant has been approved. The Project Engineer shall take approval action based upon the batch plant prequalification submittal meeting the requirements of the Standard the Approved Source of Material Listing. If the batch plant prequalification submittal indicates that the scale certification has expired the Project Engineer shall confirm that the scales have been recertified or the source will not be approved.

Whenever ready mix concrete is used on the project, the Inspector shall be alert to the condition of the trucks being used for delivery. All trucks used for delivery of concrete (other than commercial concrete or lean concrete) must be preapproved prior to use on the project. Preapproval of delivery trucks is a part of the plant approval process described in Section 6-2.2A. Approved trucks will be identified on an NRMCA truck list for plant manager inspected facilities. Approved trucks will be identified by an NRMCA sticker (for the years of approval) for NRMCA approved facilities. In some cases an approved truck may not have yet received an NRMCA sticker. In these cases, the ready-mix producer shall notify the Project Engineer in writing that the truck has passed NRMCA inspection, and is approved for use. The Inspector should verify that all delivery trucks meet the requirements of Standard All delivery must have operational revolution counters and a device to measure the amount of water added at the site. All trucks are required to be operated within the rated capacity stated on the manufacturer's data plate. The Inspector needs to check the concrete as it is being discharged down the chute to ensure that the concrete is uniformly mixed. If the concrete does not appear uniformly mixed, the Inspector can request that the concrete producer re-inspect the truck. If the concrete delivery truck cannot deliver uniformly mixed concrete, the delivery truck needs to be rejected.

When necessary, the Project Office shall make an inspection of the batch plant to confirm: the accuracy of the batching process; that the scales have current certifications; the accuracy of the water metering devices; and to sample the coarse aggregate and fine aggregate.

#### **SS 6-02.3(4)D Temperature and Time for Placement**

The purpose of upper temperature limits of concrete for placement is to limit the ultimate temperature of the concrete reached during cement hydration and curing. This in turn tends to reduce the thermal differential between the ambient environment and the concrete. The reduction in the thermal differential helps reduce cracking of the concrete by limiting tensile strains. Cracking, particularly in decks, reduces the durability of the concrete and reinforcement.

Some techniques that concrete producers can use to meet the upper temperature for placement limit for concrete include:

- using minimum cement content,
- using pozzolans (such as fly ash) to replace a portion of the cement,
- using water-reducing admixtures,



- using air-entrainment,
- using large aggregate,
- shielding aggregate piles from direct sunlight,
- using cold water or chipped ice for mixing water,
- using liquid nitrogen.

While ideally the temperature of Class 4000D concrete for placement will be below 75 degrees F, it may be difficult for concrete producers to achieve this, especially during the warmer summer months. The specification allows the Engineer to approve requests from the Contractor to exceed the 75 degree F upper limit for placement, up to a maximum of 80 degrees F. Before allowing this, the Project Engineer shall obtain the approval of the ASCE. Circumstances that may warrant raising the upper temperature placement limit include:

- Concrete placements that begin consistently within the specification limits, but placement temperature rises later on
- Concrete that is within specification limits at discharge from the truck, but is subsequently heated past specification limits by placement with a concrete pump
- Time delays for placing concrete where trucks wait at the jobsite and heat up
- Availability of ice
- Expense and construction/safety risks of liquid nitrogen

### SS 6-02.3(5) Acceptance Concrete

The Contractor is required to provide a certificate of compliance for each load of concrete delivered to the job. Based on who is supplying the mix, the format of the certification may vary. All certifications must contain the information required by the *Standard Specifications*. If a Contractor Certification sheet is not provided by the Contractor, the form provided by WSDOT may be used. Example forms are available as follows:

- Manufacturer's Certificate of Compliance for Ready Mix Concrete (DOT Form 450-001)
- Proposed Mix Design (DOT Form 350-040)

A Certificate of Compliance is all that will be required for acceptance of commercial and lean concrete. It is advised that as inspectors are collecting the Certificate of Compliance (batch ticket), they do a visual inspection of the concrete. Visual inspection should verify that the items listed on the batch ticket are included in the mix. If the concrete does not appear satisfactory for its intended use, it should be rejected.

### Prior to Placement

It is the responsibility of the Inspector to compare the actual batch weights on the concrete delivery ticket to the proposed mix design weights. The cement, coarse and fine aggregate weights are required to meet the following tolerances:

Concrete batch volumes less than or equal to 4 cubic yards:

Cement	+5 percent and -1 percent
Aggregate	+10 percent and -2 percent

Concrete batch volumes greater than 4 cubic yards:

Cement	+5 percent and -1 percent
Aggregate	+2 percent and -2 percent

If the total cementitious material weight is made up of different components, the component weights shall be within the following tolerances of the amount specified in the mix design:

Portland cement weight	+5 percent and -1 percent
Fly ash weight	+5 percent and -5 percent
Microsilica weight	+10 percent and -10 percent

For all mix designs the water weight shall not exceed the maximum water specified in the mix design. These batching tolerances apply to all mixes.

Acceptance testing will be performed by WSDOT in accordance with WSDOT standard test methods and Field Operating Procedures. Lean concrete and commercial concrete will be accepted based on a Certificate of Compliance, provided by the supplier as described in *Standard Specifications* Section 6-02.3(5)B. All other concrete will be accepted based on conformance to the requirements for temperature, slump, air content for concrete placed above finished ground line, and the specified compressive strength at 28 days.

The Inspector must be familiar with the type of concrete mix and who is responsible for the mix. The Contractor is responsible for the mix design and is responsible for 28 day strength.

The Inspector must be prepared to test materials for conformance. The Inspector must also be prepared to deal with nonconformance.

Preparation as a concrete testing inspector requires knowledge of concrete properties and construction procedures. Knowledge of how to use testing equipment and understanding the reliability of testing is also important. A continual evaluation of the testing equipment is needed to be sure it is operating and performing as required. Care and caution are recommended when transporting testing equipment and handling test materials, i.e., cylinders, molds, fresh concrete cylinders, and other samples).

### **Slump Acceptance**

The maximum slump for vibrated and nonvibrated concrete is listed in *Standard Specifications* Section 6-02.3(4)C.

When a high range water reducer (super plasticizer) is used, the maximum slump limit may be increased an additional 2 in while the concrete is affected by the admixture.

### **Air Content Acceptance**

All cast-in-place concrete above the finished ground line shall be air entrained. The air content shall be a minimum of 4.5 percent and a maximum of 7.5 percent, unless otherwise specified.

When commercial concrete is placed in sidewalks, curbs, and gutters, air content is very important. It is recommended that the inspector perform air content testing sufficient to ensure that the concrete has between 4.5 and 7.5 percent air entrainment.

The Contractor may elect to use air entrained concrete below finished ground line. If so, the 28-day compressive strength shall meet the requirements for the class of concrete specified.

## Placement Time

It is the Inspector's job to ensure that:

- The concrete is placed in the forms as soon as possible after mixing, but no later than 1.5 hours after cement is added to the mix.
- The concrete is always plastic and workable while being placed.
- The concrete is placed continuously with interruptions no longer than 30 minutes.
- Each layer of concrete is placed and consolidated before the preceding layer takes initial set. Initial set has begun if the vibrator will not penetrate the preceding layer under its own weight while being operated.

The discharge time may be extended to 1.75 hours if the temperature of the concrete being placed is less than 75°F. With the approval of the Project Engineer, this may be extended to two hours, if the temperature of the concrete being placed is less than 75°F. If it is apparent that the 30-minute time limit will be exceeded for a continuous pour, a construction joint should be established. The State Construction Office shall be contacted when this occurs. A vibrator can be used to determine if initial set has taken place when evaluating the need for a construction joint as described previously.

In certain instances, it may be difficult to meet the above criteria due to long transit times. The *Standard Specifications* allow the Contractor the option of requesting in writing to extend the time for discharge. The extension of time will be considered on a case by case basis and requires the use of specific retardation admixtures and coordination with the State Construction Office.

## Point of Acceptance

Acceptance tests for specification compliance are to be determined from samples taken at the discharge of the placement system for bridge decks, overlays, bridge approach slabs, and barriers, and at the truck discharge for all other placement. For bridge decks, overlays, bridge roadway slabs, bridge approach slabs, and barriers, acceptance samples should be taken as close to the point of deposition as possible. (e.g., taking a sample from the end of a pump down below the bridge instead of up on the deck is not acceptable as it may have substantially different characteristics.)

If a pump is used as a placement system, the initial acceptance test must be delayed until the pump has been cleared of all initial priming slurry. Do not allow placement of pump slurry in the forms.

The Inspector should arrive in advance of the concrete placement and prepare the testing location. It is the Contractor's responsibility to provide adequate and representative samples of the fresh concrete to a location designated by the Engineer. Above all, the equipment must be in good working condition with records of the last calibrations for the air meter and scales. The Inspector should have all the information, including the mix design, and all the forms needed for documentation of the placement operation.

## Test Cylinders

Concrete test cylinders shall be molded in forms conforming to the requirements for single use molds as detailed in ASTM M 205. Cardboard test cylinder molds shall not be used.

See [Chapter 9](#) for instructions for making, curing, and shipping concrete test cylinders and for the number of test cylinders to be made.

Extra cylinders that are tested for early removal of forms and falsework shall be the responsibility of the Contractor. Early cylinders are cylinders tested in advance of the design age of 28 days. Their purpose is to determine the in place strength of concrete in a structure prior to applying loads or stresses. The Contractor shall retain an independent testing laboratory to perform this work. This lab shall be approved by the Engineer.

The cylinders shall be cured in accordance with WSDOT FOP for AASHTO R 100. Special cure boxes to enhance cylinder strength will not be allowed. The number of early cylinder breaks shall be in accordance with the Contractors need and as approved by the Engineer.

Prior to the removal of any forms, the Contractor is required to furnish the Engineer with all test results. Forms shall not be removed without approval of the Engineer.

If set retarders are used in a mix, the State Materials Lab should be consulted for curing, handling, and storage instructions prior to use.

### **Retesting Concrete**

Once the Contractor has turned over the concrete for acceptance testing, no more mix adjustment will be allowed. The concrete will either be accepted or rejected.

### **Multiple Placements from One Concrete Truck**

Only one set of acceptance tests are required per concrete truck.

### **SS 6-02.3(6) Placing Concrete**

A Concrete Placement Checklist was developed as an inspection aid and is available on the State Construction Office [SharePoint](#) site in the *Construction Manual Resources* folder.

If it is necessary or desirable to place structural concrete in service prior to the time stated in the *Standard Specifications*, authority must be obtained from the State Construction Office. In such cases, test cylinders from each pour are taken and tested by the Contractor to determine the early break strength.

All sawdust, nails, dirt, and other foreign material, including ponded water, must be removed from within the forms and the forms shall be inspected and approved before placing any concrete.

The bottom of footings and forms must be thoroughly soaked with water prior to placing the concrete so they do not absorb water from the concrete mix. Care must be taken to be sure there is no ponded water when placing the concrete.

Concrete in all reinforced footings shall be placed in the dry. All reinforcing, including vertical wall or shaft bars and dowels, shall be securely fastened in place before placing of concrete begins. Driving of dowel bars into concrete must not be permitted, except in seal concrete when the seal is also the footing block, but they must be placed immediately after the concrete is placed. The placing and spacing of footing reinforcing steel is as important as in any other part of the structure.

Care must be exercised in placing reinforcing steel in the columns where it splices with the dowel bars into the footings. In many instances, if the dowel bars and column bars are not carefully placed, there is not enough space between the steel bars for proper placement of concrete. Considerable care must be taken in placing and vibrating the concrete in the columns so that no rock pockets are formed. Column details must be strictly adhered to since they are critical to the earthquake resistance of the bridge.

Care must be taken in placing and vibrating the concrete of sloping walls or columns to get proper consolidation and to avoid rock pockets.

**Figure 6-1**

**Vacant**

Concrete shall be placed in one continuous operation from top of footing to bottom of pier cap or crossbeam unless construction joints are shown in the plans or preapproved by the State Construction Office. Concrete shall be placed at the rate for which the formwork is designed. This rate, in ft of height per hour along with the concrete temperature, should be stated on the falsework plans. Spacing of studs, wales and form ties shall be as shown on the falsework plans. Rails, barriers, and parapets on retaining walls shall not be placed until all backfilling is completed. Vibrators shall be used at all times when placing concrete, unless otherwise specified.

**SS 6-02.3(6)A Weather and Temperature Limits to Protect Concrete**

Concrete may not be placed when rain is hard enough to:

- Cause a muddy foundation.
- Wash or flow the concrete.

The temperature of the concrete for cast-in-place concrete must be between 55°F and 90°F during placement. The temperature for precast concrete that is heat cured must be between 50°F and 90°F.

The air temperature must be at least 35°F during and for seven days after placement (unless the contractor has a cold weather plan in place).

The temperature measuring device shall be capable of measuring the temperature of freshly mixed concrete to  $\pm 1^\circ\text{F}$  with a range of 0°F to 130°F.

**SS 6-02.3(6)A1 Hot Weather Protection**

- Cool the component materials of the mix, transport and placement equipment, and the contact surfaces at the site.
- Methods shall be reviewed prior to implementation.

When the concrete is being placed in the bridge deck during hot weather, additional precautions must be taken in order to prevent surface evaporation. See *Standard Specifications* Section 6-02.3(6)A for estimated evaporation rates.

The temperature of the concrete at the time it is placed in the forms must be kept under 90°F. Concrete with high temperature loses slump rapidly and is difficult to place and finish. This temperature can be controlled by shading the concrete trucks while loading and unloading and shading the conveyors or pump lines used in placing the concrete. The forms and reinforcing steel should be cooled prior to placing the concrete. This can be done by covering them with damp burlap and then spraying them with cool water immediately prior to placing the concrete. Care must be taken to see there is no standing water in the forms when the concrete is placed.

Water reducing retarder admixture should be used in the concrete so the water-cement ratio and slump of the concrete can be maintained within the specification limits. The mixing time of the concrete should be held to the minimum. The concrete must be placed and finished as soon as possible. If there is a delay in applying the curing compound after

the concrete has been finished, a fog spray should be applied to reduce the moisture loss due to evaporation. If plastic cracks form and the concrete is still in a plastic state, they can be eliminated by revibrating the concrete and refinishing. Care must be taken to not revibrate the concrete after initial set has been obtained.

The requirements for curing the concrete shall be enforced. As soon as the visible bleed water has evaporated from the finished deck, the curing compound should be applied. The curing compound should be applied in two applications to ensure full coverage of the concrete. The second coat should be applied in a direction perpendicular to that of the first application. The amount of curing compound applied in the two applications should meet the minimum amount specified. Immediately after application of the curing compound and initial set, the concrete deck should be covered in accordance with *Standard Specifications* Section 6-02.3(11).

In summary, the difficulties arising from hot weather concreting may usually be minimized by:

1. Using cool mixing water.
2. Keeping the aggregate temperature as low as is economically feasible.
3. Reducing the length of mixing time.
4. Placing the concrete as soon as possible after mixing and with a minimum of handling.
5. Keeping the surfaces shaded during placing.
6. Placing curing compound as soon as possible.

#### **SS 6-02.3(6)A2 Cold Weather Protection**

- Concrete shall not be placed against any frozen or ice-coated foundation, forms, or reinforcement.
- A plan for cold weather placement and curing is required, if temperatures are below 35°F or anticipated to be below 35°F in the next seven days.
- Heat aggregate and/or water to maintain mix temperatures above 55°F.
- Control temperature and humidity after placement by:
  - Enclosing concrete.
  - Heating to 50°F to 90°F for seven days.
  - Add moisture for six days (discontinue 24 hours before heat is stopped).
  - An accurate recording thermometer is required.
  - Corners and edges require special attention to prevent freezing.

When heating water and aggregates, the approximate resulting temperature for a batch of concrete can be estimated from the following formula:

$$X = \frac{Wt + 0.22W't}{W + 0.22W'}$$

Where

- X = temperature of the batch
- W = weight of the water
- W' = weight of the aggregates and cement
- t = temperature of the water in degrees F
- t' = temperature of the aggregates and cement

Several precautions must be taken when placing concrete in cold weather. If temperatures below 35°F are anticipated within seven days following placing the concrete, the Contractor will normally be required to enclose the structure and provide heat and moisture so the concrete will obtain its initial strength without freezing. The addition of moisture should be discontinued 24 hours before discontinuing the heat so there will not be an excess of moisture on the surface of the concrete to form ice in case of cold weather following the seven-day protection. If the temperature is below 35°F when placing the concrete, the concrete must be heated to at least 60°F by heating the aggregate and/or water in accordance with the *Standard Specifications*. The temperature of the concrete, as well as the slump, must be consistent from batch to batch.

When heating water and aggregates, the resulting temperature for a batch of concrete can be computed from the formula in Section 6-2.3A(1).

### **SS 6-02.3(6)B Placing Concrete in Foundation Seals**

When constructing foundations in streams and other locations below water, it is usually necessary to place a concrete seal in the cofferdam so that the cofferdams may be dewatered. The weight of the concrete seal resists the buoyant force on the cofferdam when it is dewatered. Seal concrete is placed underwater by means of a tremie. Concrete pumps may be used.

Handling of the tremie requires the use of a crane to raise and lower it into place. Hand winches are sometimes used in small seals but they must be equipped with a brake and drum for quick release and stop.

The tremie pipe shall be at least 10 inch in diameter, made of heavy steel pipe, with flange or sleeve connections. Sleeve connections are preferable for seals placed in pile foundations. Flanges sometimes hang up on tops of piles and the concrete charge is lost. The tremie pipe must be absolutely water tight, at the joints as well as at the connections to the hopper. The hopper should be of at least, one-half cubic yard capacity.

Before any concrete is placed, the bottom of the tremie pipe shall be sealed with a plug. A satisfactory plug can be made with a 2-inch board slightly larger in diameter than the tremie pipe; on top of this board fasten a ¾-inch round piece cut to the neat size of the inside of the pipe. Place a piece of cloth or burlap over the end of the pipe and drive the plug in place. Lower the tremie until the plug rests on the bottom, then fill the tremie pipe with concrete. When the tremie is raised the weight of the concrete will push out the plug. The plug can be salvaged by fastening a piece of wire to it before it is lowered into the water.

Further details for handling a tremie are found in *Standard Specifications* Section 6-02.3(6)B.

The thickness of seals without piling are generally not less than 0.43 times the height of high water above the bottom of seal. Seals in footing with piling require special design. The thickness of the seal is computed for the water elevation shown in the plans. The cofferdams must be designed and vented for this elevation. The design and vent elevations are noted in the plans. If concrete is placed in the seal during a period of high water, the dewatering of the cofferdam will have to be delayed until the water level drops to the vented elevation. No change in the vent elevation shown in the plans shall be allowed without approval from the State Construction Office. Such approval should be obtained before the cofferdam is designed. All cofferdams must be vented at the

elevation used for computing the seal thickness in order to prevent an unsafe hydrostatic pressure on the seal. Cofferdams shall not be dewatered before the concrete has been placed and cured.

The vertical sheathing of the cofferdam or shoring shall extend below the bottom of the excavation in accordance with the working drawings. Sheet piles in cofferdams shall be placed tightly together so that there will be no flow of water through the cofferdams while seal concrete is being placed.

The tops of seals should slope slightly toward one end. At that end, provision shall be made for a sump for the pump intake. Cofferdams should be tightly constructed so that a minimum of pumping is required after the cofferdam has been dewatered. Space for water courses shall be provided on top of the seal and around the footing block, between the footing block and the walls of the cofferdam.

Before starting to place seal concrete, all equipment should be checked to see that it is in good working order. It is necessary that concrete in a seal be placed continuously until completion, with the end of the tremie always extending into the fresh concrete.

It is not desirable to leave cofferdam struts and waling in the seal concrete but it is sometimes necessary to do so, especially in soft foundation material, when a set of struts and waling is required near the bottom of the cofferdam. The concrete displaced by such struts and waling is not deducted from the Contractor's pay items.

After the cofferdam is dewatered, a film of scum or laitance will usually be found on top of the seal. This must be cleaned off before the footing concrete is placed. If the seal is designed as a footing, the laitance will have to be removed only from the areas that will support pier shafts, columns, or walls.

### **SS 6-02.3(9) Vibration of Concrete**

Vibrators are usually specified to be used when placing concrete. Their use is important for the purpose of consolidating the concrete in the forms, thus producing a dense uniform concrete.

Adequate vibration is necessary for placing concrete in difficult places, such as under and around closely spaced reinforcement. When steel forms are used for curbs, traffic barriers, or rail bases, external vibration may be required to eliminate voids at the surface caused by entrapped air. It is desirable to have the Contractor designate one person to operate the vibrator. This person could then be instructed in its use and an effort could be made to have that person kept on the same work whenever it is required.

The quantity of mixing water to be used shall be the minimum amount possible to produce the required workability. Vibrators shall be used only in freshly placed concrete. As soon as the concrete is dumped it should be spread out and vibrated by inserting the vibrator torpedo directly into the fresh concrete. However, it should be kept in one place only long enough to make the concrete uniformly plastic. Dependence should not be placed on the vibrator to work the concrete into corners and along the faces of the forms. Metal or wooden spades should be used to whatever extent is necessary in places where the vibrator cannot be satisfactorily employed, however, spades should be used only to accomplish complete filling of the forms and not for the purpose of puddling the concrete.

In regard to the desired consistency of concrete and the use of vibrators, the *Standard Specifications* should be carefully studied and followed. Every effort should be made to see that the specifications are followed.



Concrete shall be placed in accordance with the requirements of *Standard Specifications* Section 6-02.3(6). The Inspector should be alert to see that any method of placing concrete that causes segregation of the concrete mix be discontinued. Some of the conveyor belt systems tend to cause segregation of the mix after several exchanges from one belt to another. The Inspector shall see that the length of conveyor belt is limited so segregation does not occur. Aluminum pipe or sheeting shall not be used in contact with fresh concrete.

In heavily reinforced sections, the maximum concrete slump may be increased 2 inches with the use of a high range water reducer, as discussed in *Standard Specifications* Section 6-02.3(4)C. It is anticipated that possible candidates for this increase of concrete slump may be columns, cross-beams, and post-tensioned box girder web walls and other heavily reinforced members.

### **SS 6-02.3(10) Bridge Decks and Bridge Approach Slabs**

Bridge deck construction is critical because this part of the structure receives the most abuse from traffic and the environment. Construction of maintenance-free bridge decks requires close attention to details. One or two weeks before placing the concrete in the deck, a placement conference should be held to go over the procedures to be used and to emphasize the critical areas of construction. As a minimum, this should include a discussion of the rate of placement, personnel and equipment and backup equipment to be used, type of finish, and curing details. The rate of placement should normally provide for at least 20 feet of finished deck per hour.

The position of the reinforcing steel is very important because of the thin concrete section. Adequate blocking and ties are necessary to hold the steel in place. If foot traffic on the reinforcing steel causes it to deflect, the spacing of the chair supports is not adequate. A pre-check of the screed setting for proper elevations and clearances to the reinforcing steel is essential prior to any concrete placement. The finishing machine should be run the full length of the placement after the screed is adjusted to check deck thickness and cover of the reinforcing steel, this check should also continue over all bulkheads and expansion joints to verify their clearances. The finishing machine should not be adjusted while it is finishing concrete to clear bulkheads and expansion joints. These adjustments must be made prior to the concrete placement. During the placement, frequent checks should be made of the actual cover obtained directly behind the finishing machine and recorded in the Inspector's Daily Report.

Quality concrete is required, particularly in the bridge deck. Uniform consistency of the concrete should be maintained throughout the placement. The water-cement ratio is very important. It should be the minimum possible to produce the required workability and not exceed the specification limit. To keep the water-cement ratio as low as possible, the specifications require the use of a water reducing additive for all bridge deck concrete. Frequent checks of the free water contained in the aggregates is necessary to determine the amount of water actually contained in the concrete mix.

#### **SS 6-02.3(10)A Preconstruction Meeting**

Construction of crack-free and maintenance-free bridge decks requires close attention to details during concrete placement and curing. One or two weeks before placing the concrete in the deck, a pre-deck pour meeting shall be held to go over the procedures to be used and to emphasize the critical areas of construction. Points of discussion should

include concrete delivery and sampling, placement rates, personnel and equipment to be used, finishing, and curing details. The placement and operation of the temperature measuring and recording devices should also be discussed. The rate of placement should normally provide for at least 20 feet of finished deck per hour. Attendance at the pre-deck pour meeting should include:

1. Representing the Contractor, the superintendent, foremen in charge of placing and finishing concrete, a representative from the concrete supplier and the pump truck operator.
2. Representing WSDOT, the Project Engineer, Chief Inspector and key inspection and testing personnel. A representative from the State Construction Office should be invited.

A sample pre-deck pour meeting agenda for use by the Project Office can be found on the *Construction Manual Resources* website.

### **SS 6-02.3(10)D Concrete Placement, Finishing and Texturing**

Finishing of roadway slab and bridge approach slab surfaces shall be as outlined in *Standard Specifications* Section 6-02.3(10). The principal objectives to be attained are a good wearing surface and a smooth riding roadway. The Engineer should ensure that adequate preparation has been made to do a good job in accordance with the specifications. The Engineer should insist that a float be available. When a good strike-off and finish has been obtained by a finishing machine, floating may be, and should be, kept to a minimum because excess floating can be detrimental. A light aluminum float carefully and sparingly used will not harm a well finished deck, but will expose poor adjustment and misuse of a good machine. It will also smooth out mortar ridges left by the finishing machine and seal the surface. The Contractor is required to check the deck with a 10-ft straightedge immediately after it is floated.

Low and high spots can possibly be corrected by operating the finishing machine over the area (if the concrete is still plastic).

The Engineer should be cautioned that hard floating of the concrete surface with aluminum floats may cause a chemical reaction between the aluminum and the fresh concrete which could decrease the strength of the concrete at the surface of the concrete. Excessive wear or pitting of the aluminum float could be an indication that chemical reaction is taking place between the float and the concrete.

It is important that the texturing comb be used when the concrete is at the proper consistency. If the concrete is too soft, it will not retain the proper texture obtained by the comb and, if the concrete is too hard, the proper texture will not be achieved. The comb should be set up and ready to use well in advance of the time it will be required. Surface texturing is normally done with a comb except when an overlay is required.

The finished and cured deck slabs must be checked with a 10-ft straightedge and corrected by cutting down the high spots and building up low spots until the entire surface comes within the specified tolerance.

Sidewalks shall be finished smooth with a wood float and then brushed with a fine bristle brush. Use an edger tool at all joints and edges. Block lines on sidewalk surfaces are not desired on structures.

### SS 6-02.3(10)D3 Concrete Placement

During concrete bridge deck placement, it is important that the amount of concrete placed in front of the finishing machine be kept to a minimum, so it is placed, consolidated, and struck off before it starts to set. Set time may vary depending on a number of factors. The *Standard Specifications* specify that the rate of placement is such that the concrete is placed, consolidated, and struck off within 30 minutes, unless otherwise accepted by the Engineer at the pre-deck pour meeting. The Contractor should know by the pre-deck pour meeting if they will require more than 30 minutes and may request an extension at that time. One example of when they may need to place more concrete in front of the finishing machine is for bridges with extreme skews where concrete is placed to preload girders and equalize girder deflections. The timing should still be as minimal as possible.

### SS 6-02.3(11) Curing Concrete

Proper curing of concrete is important to securing strong, good wearing concrete and in reducing cracking. Curing periods and methods specified should be strictly observed.

The last step in ensuring a good concrete job is to provide proper curing. Concrete begins to cure from the time cement and water are added in the mixing chamber and continues for many years after. Concrete is very susceptible to damage during initial curing, if proper steps are not taken. Three of the most important factors are:

1. Surface drying (evaporation).
2. Rapid temperature changes between segments of the concrete as it is curing.
3. Stresses or loads applied before the concrete has reached adequate strength.

All of the specifications regarding curing, form removal, hot and cold weather concreting, etc., are designed to provide protection for the concrete during this critical stage. For example: If the surface begins to dry, the surface will begin to shrink and cracking can occur. To prevent this, the Inspector should be aware that fog misting, curing compounds, wet blankets, plastic sheeting, etc., are designed to be applied before surface drying begins to prevent loss of surface moisture. Some concrete mixes such as microsilica and latex are very susceptible to surface drying and require closer attention due to the effects of thin lift application.

**Note:** Curing compounds are not chemicals that cure concrete. They prevent water loss by forming a waterproof membrane.

Two Classes (A and B) and Types (1 and 2) of curing compounds are used depending on what is being cured. Class A is a wax resin type of curing compound which can hamper bonding of HMA and pigmented sealer and can cause concrete surfaces to be slick; it is therefore not allowed on travelled surfaces such as bridge decks, bridge approach slabs, and sidewalks. Type 2 curing compound is generally desired because it is white and will reflect solar heat, and it is easier to verify that application quantity is sufficient. Type 1 (clear) is specified when aesthetics are of concern or removal isn't required.

For bridge decks, it is extremely important to keep the finished surface fogged until presoaked burlap can be applied. Also, the burlap should continue to be fogged until soaker hoses and white, reflective sheeting is placed. The presoaked burlap should be applied within one hour after the finishing machine has passed, unless otherwise accepted in the cold weather protection plan or by the Engineer during deck casting. Cold

weather and mix design constituents can slow concrete set time, and placing burlap onto concrete that has not attained initial set can damage the deck surface.

Like most materials, concrete expands when heated and contracts when cooled. Therefore, the concrete should not be subjected to extreme temperature changes as hardening takes place.

Hardening of concrete is also slowed down by cooler weather. Concrete must not be exposed to freezing conditions to avoid permanent damage.

Concrete (as it hardens) contains a high percentage of moisture and could crack if the water in the mix freezes and expands. Air entrainment will not protect the concrete from damage during the initial curing period.

### **Summary**

1. Prevent surface moisture loss.
2. Maintain constant temperature (no freezing).
3. Prevent stress loads.

### **SS 6-02.3(12) Construction Joints**

The specifications require that construction joints shall be located and constructed as shown in the plans. Approval to add, move, or delete construction joints must be obtained from the State Construction Office. *Standard Specifications* Section 6-02.3(12) requires that shear keys shall be provided at all construction joints unless a roughened surface is shown in the plans, and where the size of keys is not shown in the plans, they shall be approximately one third of the area of the joint and approximately 1½ inches deep.

Construction joints are to be either vertical or horizontal. Wire mesh, wire lath, and other similar items can be used for a roughened surface construction joint but shall be removed and the joint cleaned before making the adjacent pour. Construction joints in roadway slabs and approach slabs must be formed vertical and in true alignment. An edger shall not be used on the joint but lips and edgings must be removed before making the adjacent pour. If the joint is properly formed, a good straight edge will be obtained with a minimum amount of lips and edgings to be removed.

Shear keys in construction joints shall be formed with 1½ inch thick lumber and shall be constructed the full size shown in the plans. For box girder webs, these shear keys are normally shown in the plans to be full width between stirrups. The specifications require shear key forms to be left in place at least 12 hours after the concrete has been placed. The plans will indicate certain joints to have a roughened surface. These joints shall be finished and prepared for the next pour in accordance with the instructions given in the specifications or as shown in the plans.

Expansion dams or the expansion dam blockout shall be carefully placed before concreting the roadway decks. They shall also be carefully aligned for crown and grade.

Blockouts for expansion joint seals must be carefully formed to the dimensions shown in the plans for proper placement and operation. Be sure to check that the rebar in the blockout does not conflict with the expansion joint anchors. The joint seal must be placed using a lubricant adhesive.

### SS 6-02.3(13) Expansion Joints

Bridge expansion joints are installed to accommodate bridge movements while preventing water, salt, and debris infiltration to substructure elements below, thus they must be installed watertight. The *Standard Specifications* require strip seal and compression seal systems to be tested for watertightness by providing a 3 inch minimum head of water for at least one hour. In practice, this is often accomplished by building a trough with plastic sheeting and sandbags and applying a stream of water sufficient to maintain the required water head. Roadway cross-slopes often make it impractical to test the entire joint at once. This can be remedied by performing the test in sections along the joint.

During the test, the expansion joint should be observed from the underside for any signs of leakage. In the case of joints behind abutments without underside access, the joint should be observed from the sides and front face of the abutment. Any amount of water observed is cause for repair.

### SS 6-02.3(14) Finishing Concrete Surfaces

As soon as possible after the forms are stripped, the concrete surfaces shall be examined and all lips or edgings where form boards have met, shall be removed with a stone or sharp tool. Bolt holes and rock pockets shall be filled with cement mortar and floated to a smooth finish. The mortar patch shall be the same color as the adjoining concrete surfaces. Finishing of concrete surfaces shall be done in accordance with the provisions of the *Standard Specifications* and special provisions.

The amount of work necessary to complete the finishing satisfactorily, depends entirely on the quality of the original concrete work. If the forms have been poorly constructed and the concrete surfaces are rough and uneven, it will be necessary for the Contractor to do sufficient rubbing and finishing after the forms are removed to secure a satisfactory job. Grinding leaves a surface that is off color and should be kept to a minimum.

The primary purposes of finishing formed surfaces are:

- To seal the surface from water and other elements that can rust or corrode metal ties and reinforcement within the concrete.
- To provide a uniform, pleasing appearance for surfaces that will remain visible to the public.

There are two different classes of finish. They are:

#### **Class 1**

- All rail bases, curbs, traffic barriers, pedestrian barriers, and ornamental concrete members.
- As designated in the Plans and in accordance with *Standard Specifications* Section 6-02.3(14).

#### **Class 2**

- Required for all other surfaces.

See the *Standard Specifications* for additional requirements.

### SS 6-02.3(17) Forms and Falsework

Falsework construction is a critical part of the bridge construction process. Generally, the factor of safety used for design of falsework is less than that of permanent construction. Therefore, it is extremely important that the falsework is constructed in accordance with the falsework drawings. Any changes to the falsework drawings must be reviewed by the Bridge and Structures Office.

The forms for the structure shall be constructed in accordance with the falsework and form plans and the requirements of *Standard Specifications* Section 6-02.3(17). In general, the forms used for all concrete surfaces which will be exposed, shall be faced with plywood. All plywood used shall be exterior type except where CDX is allowed by the specifications. All forms have to be strong enough to hold the plastic concrete in place until it has hardened. Forms should be designed to permit easy removal without damage to the concrete. Forms are a critical part of the concrete bridge construction process. Generally, the factor of safety used for design of forms is less than that of permanent construction. Therefore, it is extremely important that the forms are constructed in accordance with the form drawings. Any changes to the form drawings shall be reviewed by the State Bridge and Structures Office.

The Contractor is responsible for designing and constructing the forms and falsework for fixed-form concrete. The Contractor must submit detailed plans and calculations in accordance with Section 6-02.3(16):

Prior to placing concrete, the Inspector should verify that all forms:

- Provide forming faces that are:
  - Smooth and firm.
  - Clean of dirt, laitance, oil, or any other material that would contaminate or discolor the concrete.
  - Treated with an approved form-release agent.
- Are mortar tight to avoid any leakage (including tape or caulking if needed for surfaces that will require Class 2 finish).
- Are constructed in accordance with the forming plans.
- Are adequately rigid and well supported to hold and retain the concrete without distortion or displacement.
- Are set at the locations, dimensions, lines, and grades as specified in the plans.

If wood forms are used, see that plywood is used for the form faces with:

- The joints and grain generally in line with the line of the structure.
- The face grain of the plywood running perpendicular to the supports.
- No offsets or projections that would leave an impression in the concrete surface.

Also verify that:

- Uniform chamfer strips are set at the correct line and grade as required for filleted edges.
- Adequate tie rods, snap-ties, hairpins, studs, walers, and braces are securely placed as needed support.

If metal or fiberglass forms are used, the same basic requirements apply, but particularly check for:

- Any dents or other defects that would harm the uniformity of the concrete surface.
- Any rust or other foreign material that would discolor the concrete surface.

- Countersunk bolts and rivet heads.
- Adequate support clamps, rods, and pins.

Prior to placing any reinforcing or concrete loads on the falsework, verify that:

- The bottom of the falsework is set on a solid foundation, with mudsills, minimum pile diameter, etc., all constructed per plans.
- The upper portion provides firm, uniform support.
- Devices such as screw-jacks and wedges are used to hold the forms at the correct elevation, and that they are free from defects, and undamaged or not bent.
- When wedges are used, they are placed in pairs to provide uniform bearing.
- The falsework construction is in accordance with the falsework plans and the *Standard Specifications*.

Major failures with loss of life have occurred as a result of poor falsework and formwork construction. It is critical that the Inspector check these temporary structural elements very carefully. Any deficiencies must be corrected before construction loads are applied. If there is a question, the State Bridge and Structures, Construction Support Engineer, or the State Construction Office should be contacted.

Suggested acceptance tolerances are as follows:

1. Bridges and similar structures:

- a. Variation from the plumb or the specified batter in the lines and surfaces of columns, piers, walls, and abutments.

Exposed, in 10 feet	½ inch
Backfilled, in 10 feet	1 inch

- b. Variation from the level or from the grades indicated on the drawings in slabs, beams, horizontal grooves, and railing offsets.

Exposed, in 10 feet	½ inch
Backfilled, in 10 feet	1 inch

- c. Variation in cross-sectional dimensions of columns, piers, slabs, walls, beams, and similar parts.

Minus	¼ inch
Plus	½ inch

- d. Variation in thickness of bridge slabs.

Minus	⅛ inch
Plus	¼ inch

- e. Footings: Variation in dimensions in plan.

Minus	½ inch
Plus	2 inches

- f. Misplacement or eccentricity 2 percent of the footing width in the direction of misplacement but not more than 2 inches.

- g. Reduction in thickness.

Minus	5 percent of specified thickness
-------	----------------------------------

- h. Variation in the sizes and locations of slab and wall openings

½ inch
--------

Forms for concrete surfaces which will be exposed shall be treated with a parting compound consisting of a chemical release agent. Form oil or other oils shall not be used. The parting compound shall be applied before the reinforcing steel is placed. The forms shall be thoroughly wetted on both sides in advance of placing the concrete.

The basic requirements for the removal of any forms and falsework are that:

- The curing temperature was above 50°F during the cure period and that strength is adequate.
- No forms or falsework may be removed until the minimum time has been met as listed in Section 6-02.3(17)N or as authorized by the Engineer.
- All forms and falsework must be removed unless there is no access for removal (i.e., inside a box girder bridge).
- All forms and falsework must be removed in a manner that will not damage the structure.

Timing is a key consideration in the removal of forms and falsework. In terms of curing, the concrete, forms, and falsework must remain until the concrete has sufficient strength to support itself. For finishing purposes, it is generally better to remove the forms as early as possible to finish the surface while it is still green. Therefore, the timing of falsework and form removal depends largely on the type of structure as well as how it is cured and finished. If forms are removed during the required curing period, the Contractor shall provide the required curing method to the exposed concrete surface as described in Section 6-02.3(11).

### **SS 6-02.3(24) Reinforcement**

For most concrete structures, some type of reinforcement is required to resist high tension stresses. Reinforcing materials include:

- Uncoated deformed steel bars, which are most commonly used.
- Other types, such as welded wire reinforcement epoxy-coated bars, wire, prestressing cable.  
**Note:** Epoxy-coated bars require special handling to prevent damage to the coating.
- Wire ties and other devices to securely hold the reinforcement in place.

The Contractor is responsible for determining and ordering quantities from the plans.

As reinforcing steel is delivered and stored at the project site, the Inspector should verify that:

- All positioning, spacing, sizes, lengths, shapes, and splice locations conform with the plans.
- Any field bending is done as specified and any cracked or split bars are rejected. If in doubt, reject the bar in question.

The Inspector should verify that the reinforcing placed is:

- Tied at all intersections if bar spacing is 1 ft or more.
- Tied at alternate intersections if spacing is less than 1 ft.
- Supported in accordance with the *Standard Specifications*.
- Tack welding is not allowed. It can severely damage the reinforcing steel.
- Check that clearances between the forms and the reinforcement are within  $\frac{1}{4}$  in of those specified in the plans.



- Check that splices are located and constructed only as shown in the plans using either:
  - Lap splicing:
    - \* Not permitted for No. 14 or No. 18 bars.
  - Welded splices:
    - \* Special inspection is required (steel fabrication inspector).
    - \* Advance review of welding procedures.
    - \* By certified welders (test welds).
  - Mechanical splicing (if allowed in the plans):
    - \* This type of splice must be approved by the State Materials Lab before use.
      - Check that reinforcement is securely supported and held in place as follows:
        - By preapproved metal or plastic chairs, hangers, support wires, or mortar blocks that are at least as strong as the structure (mortar blocks require manufacturer certification).
        - With such supports having the correct dimensions to provide the required clearances.
- Check that all damaged epoxy-coated rebar is repaired in accordance with the *Standard Specifications*.

See the Bar Identification Guide ([Figure 6-2](#)) for proper identification of rebar at the job site.

The ASTM specifications for billet-steel, rail-steel, axle-steel, and low-alloy steel reinforcing bars (A 615M, a 616M, a 617M, and a 706M respectively) require identification marks to be rolled into the surface of one side of the bar to denote the producer's mill designation, bar size, type of steel and minimum yield designation (see [Figure 6-2](#)). Grade 60 bars show these marks in the following order:

1<sup>st</sup> – Producing Mill (usually a letter)

2<sup>nd</sup> – Bar Size Number (#3 through #18)

3<sup>rd</sup> – Type Steel:

S for Billet meeting Supplemental Requirements S1 (A 615M)

N for New Billet (A 615M)

R for Rail meeting ASTM a 617M, Grade 60 bend test requirement (A 616M)  
(per ACI 318-83)

I for Rail (A 616M)

A for Axle (A 617M)

W for Low-Alloy (A 706M)

4<sup>th</sup> – Minimum Yield Designation

Figure 6-2

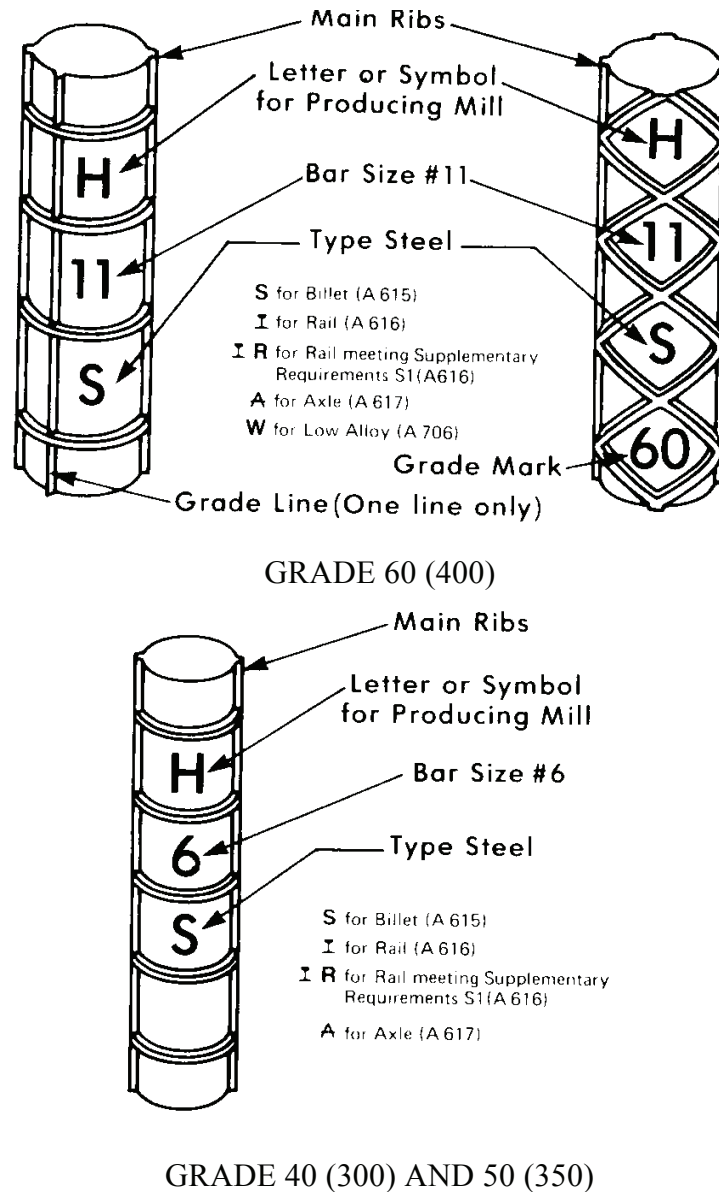

Minimum yield designation is used for Grade 60 bars only and can either be one (1) single longitudinal line (grade line) or the number 60 (grade mark).

A grade line is smaller and between the two main ribs which are on opposite sides of all U.S. made bars. A grade line must be continued at least 5 deformation spaces. A grade mark is the 4th mark on a bar.

Grade 40 and 50 bars are required to have only the first three identification marks (no minimum yield designation).

Bar identification marks may be oriented as illustrated or rotated 90 degrees. Grade mark numbers may be placed within separate consecutive deformation spaces. Grade line may be placed on the side opposite the bar marks.

Reinforcing steel shall be placed in position as shown on the plans and held securely during the placement of the concrete. The strength of a reinforced concrete structure depends not only upon the amount of steel placed but also on its proper location. Improper location of the steel can impair the strength of the structure.

In instances where reinforcing steel is shown in detail in specific relationship to other material and details such as inserts, openings, etc., the Inspector should make sure that this relationship exists when inspecting the placement of the reinforcing steel. If the shown relationship is impossible to maintain or results in a conflict with other details, the State Construction Office shall be consulted to obtain clarification of the details.

The reinforcing steel shall be securely blocked from the forms by means of small mortar blocks, with a groove or tie wire embedded, not more than 2 inch square, or by other approved devices. If metal chair supports are used as supports for steel reinforcing bars, all surfaces of the chair supports not covered by at least  $\frac{1}{2}$  inch of concrete shall be treated in accordance with the requirements of *Standard Specifications* Section 6-02.3(24)C.

Runways for wheelbarrows or concrete buggies used in placing concrete shall not be supported on the steel reinforcing bars.

Steel delivered to the job far in advance of its use should be stored under cover to prevent rust. Mill scale is sometimes present on the reinforcing steel to such an extent that it must be removed. This is especially true with the larger bars. Removal can usually be accomplished by the use of wire brushes or by tapping the bars with hammers. Hardened concrete mortar must be removed from the reinforcing steel before placing the concrete. All reinforcing steel shall be in its proper place before concrete is placed. Driving of dowels, rail bars, etc., into concrete (wet setting) shall not be permitted. See the *Standard Specifications* for further details.

Before concrete is placed, the reinforcing steel shall be inspected to see that it conforms to the plans and that the steel is properly fastened in position. The amount of cover of concrete over the reinforcing steel in bridge roadway slabs and bridge approach slabs is critical. The Inspector must verify compliance with plan dimensions in the slabs by an adequate number of measurements of the steel reinforcing bar locations in the forms before and immediately after placing concrete. These measurements can be taken at the same time checks on the depth of the concrete in the slabs are taken. These measurements shall be recorded as to depth and location and made a part of the project construction documents.

When steel reinforcing bars protruding from columns or walls are exposed to weather for several months, they rust and exposed surfaces below become stained with rust. To prevent this, the bars should be protected to prevent rust. Coatings used for this purpose may prevent adequate bonding of concrete to the steel bars and should be removed from the bars before concrete is placed, except as allowed by the *Standard Specifications*.

### **SS 6-02.3(24)E Welding Reinforcing Steel**

Reinforcing bars shall not be welded unless welding is indicated in the plans or special provisions. If welding is specified, the WSDOT welding inspector must be contacted for purposes of certifying welders and procedures. Reinforcing bars which are to be welded must be furnished of steel which is suitable for welding as specified.

Only operators qualified as specified in *Standard Specifications* Section 6-02.3(24)E shall be allowed to weld reinforcing steel.

AWS specifications require that Low Hydrogen type electrode (welding rod) be used for welding reinforcing steel. Generally, grade E7018 electrodes shall be used for grade 40 reinforcing bars and grade E8018 electrodes shall be used for grade 60 reinforcing

bars. If semiautomatic welders are used equivalent grade electrodes shall be used. It is important that moisture be eliminated from the electrode and the steel reinforcing bars. The electrode must be prepared as called for in *Standard Specifications* Section 6-03.3(25). To do this, a drying oven is essential and must be available and used at the site where welding is done.

The recommended procedure for welding steel reinforcing bars is given in *Standard Specifications* Section 6-02.3(24)E. The Contractor shall submit a welding procedure to the Engineer for review. The Project Engineer shall transmit the Contractor's welding procedure to the State Bridge and Structures, Construction Support Engineer for review.

### **SS 6-02.3(25) Prestressed Concrete Girders**

Shop inspection of the manufacturing process of prestressed concrete products will be done by an inspector working under the direction of the State Materials Engineer. The State Materials Laboratory has instituted a procedure of inspecting each prestressed concrete plant in the State on an annual basis. During this inspection, the State Materials Laboratory obtains a list of the sources of the component parts to be used in manufacture of the prestressed concrete members. When the Contractor submits a request for approval of source of prestressed products, the complete member and the prestress plant which will manufacture it need only be listed.

The Inspector prepares a weekly Fabrication Progress Report and Inspectors Daily Report, and submits them to the Project Engineer for information and records. When the prestressed unit is completed, including finishing, the Inspector will attach an Approved for Shipment tag, and/or the girder will be stamped with an "approved for shipment" and a lab I.D. number. The Approved for Shipment tag properly signed and dated or the "approved for shipment" and a lab I.D. number will be the Project Engineer's basis for accepting the product at the job site. The Project Engineer will be required to inspect the item only for any damage which may occur during shipment or after the item arrives at the job site.

Finishing of concrete surfaces of prestressed units shall be in accordance with *Standard Specifications* Sections 6-02.3(14) and 6-02.3(25)H unless specifically changed by the special provisions. The Shop Inspector shall require that the finishing done in the shop is in accordance with the specifications.

Prestressed concrete girders shall be maintained in a plumb, upright position at all times and shall be lifted by means of the lifting strands provided at the ends of the girders. All prestressed girders have been designed for a vertical pickup at the ends as indicated in the contract plans, and any other method will induce stresses which could cause failure of the girder during pickup. Some deviation from the vertical is safe for some girders. If the Contractor wishes to deviate from the vertical pickup, they shall have the proposed method analyzed by their engineers and shall submit the method, with supporting calculations, for review. The Project Engineer submits the calculations to the State Construction Office for review. If the girders are broken or damaged during handling or erection, they will have to be replaced at the Contractor's expense.

The girders shall not be placed on the finished piers or abutments until the concrete in the piers or abutments has obtained at least 80 percent of its design strength. If grout pads are required, they shall be constructed and cured as required by the plans and specifications before placing the girders. The girders must meet the dimensional tolerances listed in *Standard Specifications* Section 6-02.3(25)I.

**SS 6-02.3(25)A Shop Drawings**

The Contractor is required to submit shop detail plans to the Project Engineer for review. The Project Engineer shall check these plans for compliance with the contract plans and specifications.

Manufacture of these members shall not begin until the Contractor has received comments on the method, materials, and equipment they propose to use in the prestressing operations. Deviations from the shop drawings shall not be permitted.

Welding of the reinforcing bars will not be permitted unless shown in the contract plans.

The State Materials Lab has published a manual entitled "Inspectors Guide for Prestressed Plant Inspection and Quality Control" which contains more detailed instructions for this work.

**SS 6.02.3(25)K Girder Deflection**

Precast prestressed girders start creeping up immediately after prestressing strands are released in the casting bed. Over time, creeping or girder deflection upward continues. Bridge plans estimate the expected creep at 120 days, from prestress release to deck placement, and designate the letter "D" for this deflection. Theoretical girder camber at mid span vs. Actual girder camber measured in field, after girder erection, should be compared for compliance with *Standard Specifications* Section 6-02.3(25)K.

The camber diagram is a parabolic curve. In order to have a smooth vertical profile the pad dimension on top of girder flange varies through the length of span (see Figure 6-3). This dimension is usually least (depending on the vertical profile curve) at center span and maximum at center line of bearings which bridge plans refer to as "A" dimension. The designation "C" is the amount of camber added to the deck grade elevations to account for the anticipated downward girder deflection due to all superimposed loads (slab, overlay, sidewalks, utilities and traffic barriers).

Finished roadway grade elevations should be calculated along the center line of the prestressed girders at a minimum of every 10 feet for each span. Camber values at these locations need to be added to the finished roadway grade elevations to compensate for the girder deflection due to superimposed loads. Equation 6-1 calculates the camber at any point along the span.

$$Y = C - 4C(M - 0.5)^2 \quad \text{(Equation 6-1)}$$

Where

- Y = camber at any point along the span length in inches
- C = deflection due to superimposed dead load at span mid point in inches
- M = location of span in decimal percent

The following example shows how tenth point span camber can be calculated.

**Example:**

Calculate camber at 0.20 point span for a prestress girder when girder length (ctr. - ctr. bearing) is 174.2 feet and "C" dimension at mid span given as 3 inches (see Figure 6-4).

$$Y = 3 - 4(3)(0.20 - 0.5)^2$$

$$Y = 1.92 \text{ inches}$$

Once the girders are set in place and before any load is added to the girders, elevations are taken at the tenth point locations (or minimum spacing of 10 feet as determined by the span length) to be used to determine an adjusted "A" dimension. The adjusted "A" dimension is determined by subtracting the as built elevations from the calculated finished roadway grade elevations plus camber to determine the new adjusted "A" dimension at each location. The adjusted "A" dimension is used to string line between two adjacent points to determine soffit location.

Figure 6-3

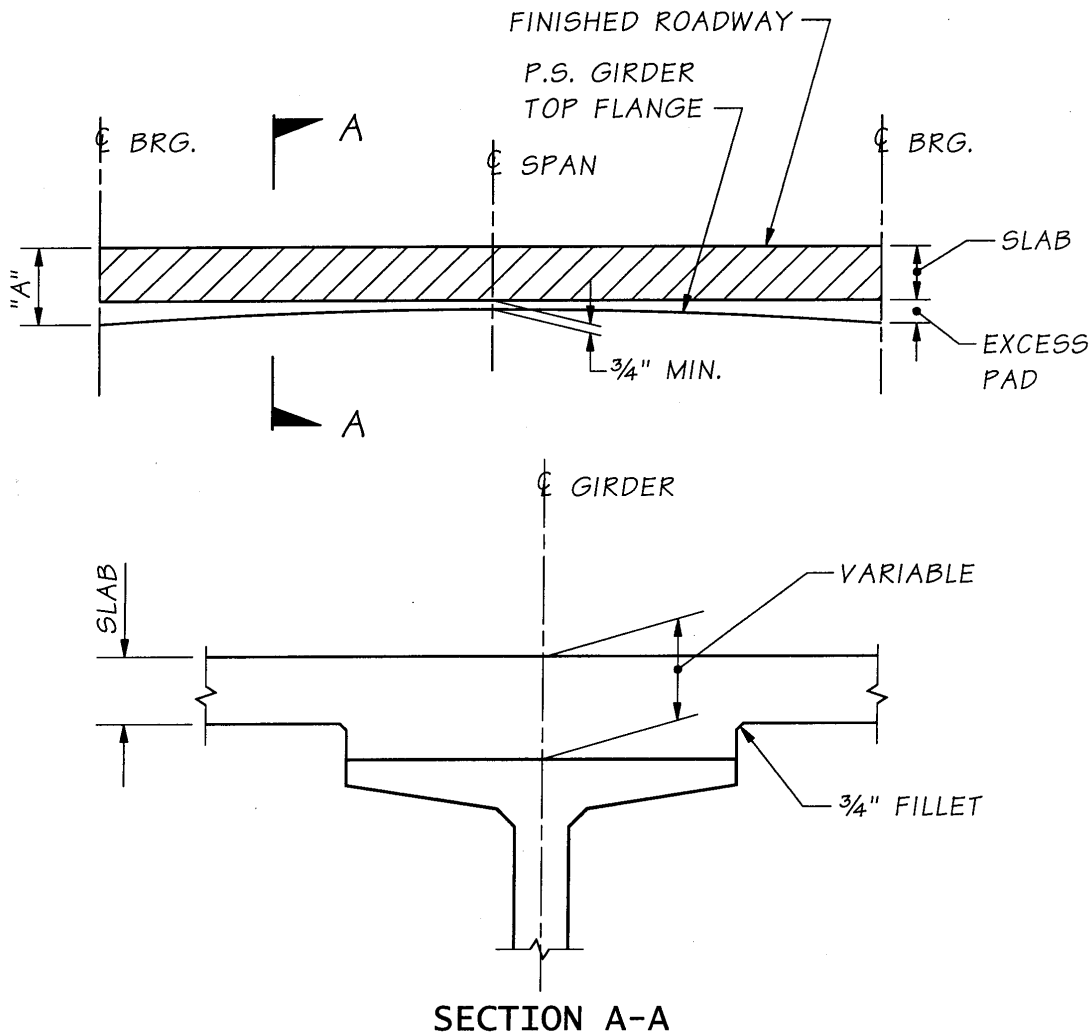
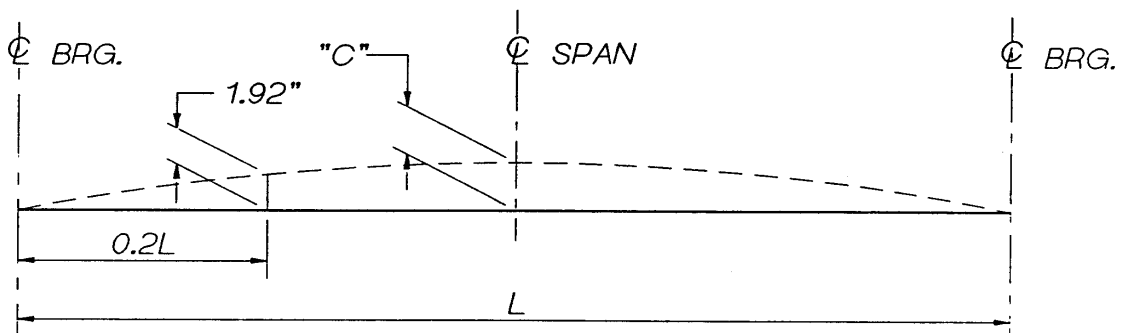

Figure 6-4



**SS 6-02.3(26) Post-Tensioned Concrete**

The construction of cast-in-place post-tensioned bridges requires considerable attention to details of construction by the Contractor and Inspectors. The State Construction Office is available to present job-specific training on post-tensioned bridges. They should be contacted after the post-tensioning shop drawings have been reviewed and before post-tensioning ducts and anchors are to be placed.

In addition to the falsework and form plans for the structure being reviewed by the Bridge and Structures Engineer, post-tension detail plans shall be submitted for review as shown in the Shop Plans and Working Drawings Table in Section 1-2.4H. Included in these details will be the anchoring details, jacking forces, lift off forces, tendon profile, elongation of the tendons, and the tendon stressing sequence. In many structures, the dead load of the structure is increased at the jacking ends during the jacking operation. In these cases, the falsework at the jacking ends must be designed to carry the additional dead load.

The installation of the post-tension system begins with the placing of assemblies consisting of bearing plate, transition cone or trumpet and grout inlet. Duct sections consisting of rigid conduit are assembled with couplers and are tied to the stirrups. Anchorages and bearing plates are securely fastened to the forms to prevent movement and loss of mortar during concreting. Connections between trumpets and ducts, ducts and couplers, and ducts and vent saddles are taped with a durable and waterproof tape to prevent intrusion of mortar.

It is necessary that the ducts be located in the position shown in the post-tension details in order for the structure to function as designed. A misaligned duct will cause increased friction and localized stress which can result in failure of the member during the stressing operation. The Inspector must check to see that the ducts are properly located and securely fastened in place to prevent movement during concreting.

On continuous structures, vents must be placed at the high and low points of the tendon and grout inlets at the ends of the tendon.

At the completion of the duct installation and prior to placement of concrete in the top slab, a device of slightly smaller diameter than the inside diameter of the duct shall be blown through the ducts to ensure no undetected damage or blockage has occurred (see *Standard Specifications* Section 6-02.3(26)E).

The prestressing reinforcement strand is delivered to the site in sealed reel-less packs or reels containing desiccant to prevent corrosion. It is necessary that the prestressing reinforcement is free of rust and kept clean while it is assembled, stressed, and grouted. Normally, the grouting shall take place within 10 days of the time the strand is removed from the packs to prevent the accumulation of rust. The Inspector should check the reels of strand intended for use and reject those which show damage to the strand or visible rust. See *Standard Specifications* Section 6-02.3(26)F for further requirements.

Some projects may be designed for the use of high strength steel rods instead of the strand. These rods come in various sizes to give the required steel area for the tendon in one bar instead of bundling several strands in the tendon.

Jacking operations shall not be started until the concrete in the structure has cured for the specified time or reached the specified strength. Jacking shall be carried out in the sequence shown on the post tension details to minimize the amount of eccentric

loading on the structure. During the jacking operations, no person should be directly behind either end of the tendon. Occasionally a tendon will let go, resulting in a very dangerous situation.

Each jack used to stress tendons shall be equipped with either a pressure gauge or a load cell along with certified calibration charts for determining the jacking force.

Gauging devices should be re-calibrated at intervals of not more than 180 days; however, if during the progress of the work, any gauging system appears to be giving erratic results, or if gauge readings and elongation measurements indicate materially different stresses, the jack and the gauges shall be re-calibrated.

A starting load, usually 20 percent of the jacking load, as shown in the post tensioning schedule, is applied to the tendon. The purpose of this starting load is to take up the slack in the tendon so that an accurate elongation measurement may be made. This load is applied by hydraulic jacks and measured by the jack gauges. During the stressing operation, the tendons shall be jacked to the specified load and the jacking load and elongation shall be recorded. Also the elongation after seating must be measured and recorded (see [Figure 6-5](#)).

In the event of discrepancies between measured elongations and calculated elongations (see Stress Acceptance Criteria), the entire operation should be carefully checked and the source of error determined and corrected before proceeding further. A discrepancy between the elongation and the jacking force usually indicates that the gauge on the jack is not correctly calibrated, there is undue friction between the duct and the tendon, or the tendons are not properly anchored.

#### ***Stress Acceptance Criteria***

##### **Strand Tendon (lengths 50 feet and less):**

1. The tendon may be accepted provided: The measured elongation is equal to or exceeds 93 percent of the calculated elongation.
2. A force verification lift-off is performed: The verification lift-off force is between -5 percent and +5 percent of the calculated force.

##### **Strand Tendon (lengths greater than 50 feet and less than 150 feet):**

1. If the measured elongation is between -7 percent and +7 percent of the calculated elongation, the tendon can be accepted.
2. If the measured elongation exceeds 107 percent of the calculated elongation, confirm the jack/gauge calibration, and then perform a force verification lift-off:
  - a. If a force verification lift-off is performed on one end of the tendon only and the lift-off force is between -1 percent and +5 percent of the calculated force, the tendon can be accepted.
  - b. If a force verification lift-off is performed on both ends of the tendon (jacking end and anchor end) and the lift-off forces are between -5 percent and +5 percent of the calculated force, the tendon can be accepted.



**Strand Tendon (lengths 150 feet and greater):**

1. If the measured elongation is between -7 percent and +7 percent of the calculated elongation, the tendon can be accepted.
2. If the measured elongation exceeds 107 percent of the calculated elongation, confirm the jack/gauge calibration, and then perform a force verification lift-off.
  - a. If a force verification lift-off is performed on one end of the tendon only and the lift-off force is not less than 99 percent of the calculated force nor more than  $0.7 f'_s A_s$ , the tendon can be accepted.
  - b. If a force verification lift-off is performed on both ends of the tendon (jacking end and anchor end) and the lift-off forces are not less than 95 percent of the calculated force nor more than  $0.7 f'_s A_s$ , the tendon can be accepted.

**Singularly Jacked Four-Strand Transverse Deck Tendon:**

The tendon may be accepted provided:

1. The measured elongation of an individual strand is between -10 percent and +10 percent of the calculated elongations.
2. The average of all four individual strand percent elongations is between -7 percent and +7 percent of the calculated elongation.

**Bar Tendon:**

1. The tendon may be accepted provided: The measured elongation is equal to or exceeds 93 percent of the calculated elongation, and
2. Perform a force verification lift-off: The verification lift-off force is between -5 percent and +5 percent of the calculated force.

If acceptance tolerances are exceeded, notify the State Construction Office.

$f'_s$  = specified minimum ultimate tensile strength of prestressing steel  
(270 ksi for strands and 150 ksi for bars.)

$A_s$  = cross-Section area of the tendon (0.153 square inch for ½-inch diameter strand, 0.217 square inch for 0.6 inch diameter strand.)

The grout used is fluid and quite different from the mortar we usually associate with the term grout. The component materials of the grout mix must be accurately measured. The maximum amount of water specified must not be exceeded. The grout should be screened after it has been mixed and before it is added to the grout equipment to remove lumps which might cause clogging of the ducts.

Immediately, prior to grouting, the ducts shall be blown out with oil free compressed air. Grout is applied continuously by pumping under moderate pressure at the lower end of the duct toward an open vent at the upper end until all entrapped air is forced out the open vents. The open vents are closed under pressure of issuing grout after a steady solid stream of grout is discharging. The grouting pressure is gradually increased to a minimum of 100 psi and 200 psi maximum and held at this pressure for a minimum of 10 seconds. The grouting entrance is then closed.

After grouting of the tendons, the recesses for the anchorages are cast solid with concrete.

A complete record must be kept of the stressing operations.

An example of the Post-Tensioning Record (DOT Form 450-005) is shown in Figure 6-5. The following explanations will help in completing the record:

- A. Required jacking force for the tendon is obtained from the post-tensioning details.
- B. Gauge pressure is obtained from the certified calibration chart for the jack to obtain the required jacking force listed in "A" above.
- C. Gauge pressure for the initial force to take up the slack in the tendon and is usually 20 percent of the force obtained in "B" above.
- D. The designed elongation is obtained from the post-tensioning details, however the stress strain curves prepared by the steel manufacturer shall be used to determine the modulus of elasticity for adjusting the designed elongation based on the average value of all strands to be incorporated in the tendon.
- E. This required seating take up is obtained from the post-tensioning details. This is usually  $\frac{1}{4}$  inch to  $\frac{3}{8}$  inch.
- F. & G.  
The elongation must be measured at the initial force of 20 percent of the required jacking force, at the specified jacking force, and again at the 20 percent loading.
- H. The difference in the elongation measured at full force and the elongation measured at the initial force of 20 percent (minus any dead end slip). This elongation should be reasonably close (see Stress Acceptance Criteria) to the required elongation in "D" above.
- I. Seating take-up is the difference in the elongation measured at full force and the elongation measured after the tendon has been seated and the jacking force reduced to the initial force of 20 percent of full force. However, since the elongations are measured at the end of the jack, the elongation of the tendon from the wedges to the measuring point must be accounted for to obtain the true seating takeup. After finding the difference between the full jacking force elongation and the 20 percent of full jacking force, (I1) the elongation of the tendon inside the jack must be subtracted from the difference to obtain the true seating take-up. (I2) The elongation of the tendon inside the jack is approximately  $\frac{1}{16}$  inch per foot. This seating take-up should be the same as the required take-up in "E" above. It is important that the specified seating take-up be obtained as it has an appreciable effect on the stress in the tendon.
- J. Percent elongation per tendon is a comparison of the calculated elongation and the measured elongation. If the elongation obtained at full jacking force is not reasonably close to the required elongation, the following conditions are usually indicated:
  - There is more (or less) friction in the tendon than was anticipated in the calculations of the post-tension details.
  - The gauging devices on the jack are not properly calibrated.
  - The strands of a tendon are not properly anchored.

If tendon stressing is performed at an air temperature below 60°F, the Contractor should not be allowed to use jack pressure gauges that utilize oil or glycerin. This will ensure accurate jack pressure readings. The reason for this is that these gauges tend to react slowly at lower temperatures. What can happen with these gauges is the jack operator will bring jack up to the required gauge pressure and shut the jack off. Since the gauge is slow in reacting, it will continue to rise until it “catches” up, resulting in over stressing the tendon. Once this occurs, the tendon will usually need to be replaced.

- J. Percent elongation per tendon is a comparison of the calculated elongation and the measured elongation. If the elongation obtained at full jacking force is not reasonably close to the required elongation, the following conditions are usually indicated:
- There is more (or less) friction in the tendon than was anticipated in the calculations of the post-tension details.
  - The gauging devices on the jack are not properly calibrated.
  - The strands of a tendon are not properly anchored.

If tendon stressing is performed at an air temperature below 60°F, the Contractor should not be allowed to use jack pressure gauges that utilize oil or glycerin. This will ensure accurate jack pressure readings. The reason for this is that these gauges tend to react slowly at lower temperatures. What can happen with these gauges is the jack operator will bring jack up to the required gauge pressure and shut the jack off. Since the gauge is slow in reacting, it will continue to rise until it “catches” up, resulting in over stressing the tendon. Once this occurs, the tendon will usually need to be replaced.

### **SS 6-02.4/5 Measurement and Payment**

Measurement and payment instructions are covered in *Standard Specifications* Sections 6-02.4 and 6-02.5.



## 6-03 Steel Structures

### SS 6-03.3(7) Shop Plans

The Contractor shall submit shop plans of all steel fabrication for review. Fabrication of the steel shall not be started until the shop plans have been reviewed by the Bridge and Structures Engineer (or Terminal Design Engineer for the Ferries Division projects) and the materials source and fabricator have been given approval by the State Materials Engineer. The State Materials Engineer shall advise the State Bridge and Structures Engineer (or Terminal Design Engineer) when the materials source or fabricator has been approved. The plans will not be returned to either the Contractor or the fabricator by the Project Engineer until the approval of source has been given by the State Materials Engineer. WSDOT reviews the shop plans for sufficiency of the materials and connections and not for the correctness of dimensions. Some details of the design drawings may, with the approval of the State Bridge and Structures Engineer (or Terminal Design Engineer), be changed to suit the erection methods the Contractor desires to use. These revisions may require a change order.

The Contractor shall submit eight sets of all shop detail plans required for fabrication of the steel directly to the State Bridge and Structures Engineer and two sets to the Project Engineer. For the Ferries Division projects, all ten sets shall be submitted to the Terminal Design Engineer. If a railroad is involved, four additional sets are required for each railroad involved. See the shop plans and working drawings table in Section 1-2.4H. The Project Engineer should advise the State Bridge and Structures Engineer of any conditions that would affect the checking and review of the drawings. These comments should be shown with a green color marker on the Project Engineer's copy.

Shop inspection is performed either by inspectors or representatives of the State Materials Laboratory. Material Acceptance Reports are obtained by these inspectors and provided to the Project Engineer upon completion of the shop fabrication. Erection plan sheets generally accompany the shop plans.

Prior to completion of the project, the Contractor is required to furnish shop drawings on mylar or equivalent, which will be sent to the State Bridge and Structures Office for their permanent file. These drawings must be suitable for reproducing by microfilming.

#### SS 6-03.3(7)A Erection Methods

Falsework and erection plans for structural steel structures shall be submitted for review in the same manner as for concrete structures.

Camber diagrams are normally shown in the contract plans. It is the Fabricator's responsibility to fabricate the members to the prescribed camber shown in the plans. The Fabrication Inspector should verify that the members are fabricated in accordance with the shop drawings.

The use of heavy equipment for erection purposes requires the review of the State Bridge and Structures Engineer. See *Standard Specifications* Section 6-01.6.

Laying out work for structural steel spans requires greater accuracy than for other structures. Use precise instruments, standardized tapes, scales and thermometer when making layout. Spacing of piers, bents, and anchor bolts shall be as shown in the plans, providing the span after fabrication in the shop is the correct length.

The fabrication shop is required to furnish a sketch showing the length of span and amounts of camber measured in the shop at the time the spans are assembled. The Project Engineer should have a copy of this sketch before erection is begun. The lengths as measured in the shop seldom vary more than  $\frac{1}{4}$  in to  $\frac{3}{8}$  in from the design drawings, and there is sufficient play in the anchor bolt sleeves for this tolerance.

Allowance will be made on the design drawings for stretch of the span due to loss of camber. The Project Engineer shall compute camber elevations from the shop camber measurements taken by the shop. Elevations shall be set above the falsework at each panel point for the camber blocking. Most erectors set the camber blocks high to allow for settlement of the falsework. The amount of allowance for settlement should be decided by the erector. The Project Engineer shall give the exact elevations for the finished camber. Elevations shall be given and carefully checked as an error means that an unnecessary amount of jacking and adjusting may be required.

The adjustment of spans is often a source of argument between erectors and engineers. Accurate work on the part of the Engineer will do much to avoid such arguments. Elevations set on the falsework before the load is applied may not be correct after the load is applied. It is the responsibility of the Contractor to determine the allowance that may be necessary to compensate for settlement in the falsework. It is easier to lower the span than to raise it.

### **SS 6-03.3(9) Handling, Storing and Shipping of Materials**

Structural steel members shall be handled carefully to prevent twisting, bending, or scraping the member. The material shall be supported on suitable skids or platforms to keep it off the ground or out of water and it shall be protected from deterioration by rust.

Structural steel members should not be unloaded and stored on adjoining concrete approach spans. If the Contractor proposes to use the concrete approach spans to support the structural steel members, the proposal must be submitted in writing to the Bridge and Structures Office for review. This proposal shall include drawings describing the support locations, loads, and supporting stress calculations. The structural steel members shall be placed on timber blocking, spaced so that the weight will be carried on the girders (load carrying members) and not on the comparatively thin concrete deck slab. Bridge decks are designed for carrying traffic and not as storage or dock space. This is especially true for concrete sidewalk slabs. Sidewalk concrete slabs shall not be overloaded by loads such as building material, tool sheds, or paint sheds.

### **SS 6-03.3(10) Straightening Bent Material**

Methods for straightening of plates, angles, other shapes, and built-up members shall not produce fracture or other injury to the metal, and shall be reviewed by the State Construction Office. Distorted members shall be straightened by mechanical means or by the carefully planned and supervised application of a limited amount of localized heat. The temperature of the heated area shall not exceed 1,100°F (a dull red) and shall be controlled by temperature indicating crayons, liquids or bimetal thermometers.

Following the straightening of a bend or buckle, the surface of the metal shall be tested for evidence of fracture.

**SS 6-03.3(25) Welding and Repair Welding**

Welding of structural steel shall be in accordance with the requirements in *Standard Specifications* Section 6-03.3(25). Welding will not be accepted as a substitute for bolting and should be done only where indicated in the plans. Adding even small welds not shown in the plans can induce high stresses in the members. This could seriously impair the strength and structural capability of the structure involved. The structure has been designed assuming that no additional welding will be done. The approval of the Assistant State Construction Engineer is required before doing any welding not shown in the plans.

Good workmanship and proper materials are essential. Welding operators should be qualified for the type of welding they are required to do. Welding procedures shall be reviewed by the Bridge Engineer before starting to weld on the structure.

Welding defects should be corrected as indicated in the *Standard Specifications*.

Low hydrogen type electrodes must be dry when used. The care and use of these electrodes as given in the *Standard Specifications* should be completely observed. No relaxation of these requirements can be tolerated.

**SS 6-03.3(30) Painting**

Steel structures shall be painted in accordance with the requirements in *Standard Specifications* Section 6-07.

**SS 6-03.3(32) Assembling and Bolting**

Before erection of the steel is commenced, the structural steel members shall be inspected for damage during shipping and handling. Any members that have been damaged must be repaired or replaced before being erected.

All members should have been match-marked and shall be assembled in accordance with the erection drawings from the Contractor. As the erection progresses, the Inspector should compare assembled members against the erection plans to see that proper members are in correct positions.

If during assembling, it is discovered that various members do not fit together, do not allow undue force to be applied to make them fit. The application of such a force can introduce stresses in several components of the structure. These stresses can be of a magnitude high enough to cause serious structural problems. The structure has not been designed to take these stresses. In such cases, the Assistant State Construction Engineer shall be informed.

Structural steel members that are improperly fabricated, or do not fit, shall be rejected and either repaired or replaced with new. If the Contractor elects to repair the structural member, the proposed repair procedure shall be reviewed by the Assistant State Construction Engineer prior to any repair work.

Unless otherwise shown or specified, structural steel connections shall be bolted. Simple truss spans shall be completely erected with all field-bolted connections and/or splices held in place with the minimum number of drift pins and bolts as specified in *Standard Specifications* Section 6-03.3(32). Once the minimum number of drift pins and bolts are installed in all the connections, final adjustments for span length and camber shall be made prior to completion of bolting and release of falsework. The assembly and bolting sequence for all structural steel structures shall strictly follow the erection plan. Erection

and bolting sequences, especially cantilever and arch spans, are usually detailed in the contract documents.

Field connections shall be pinned and bolted in accordance with the requirements of *Standard Specifications* Section 6-03.3(32). This Section applies to connections and splices made in the field. Connections are when one structural steel member is bolted directly to another structural steel member; such as, cross-members and braces. Splices utilize structural steel plates to connect two structural steel members; such as, a plate girder. It also requires all connections and splices be securely drift-pinned and bolted before the weight of the member can be released or the next member is added. The field erection drawings must specify pinning and bolting requirements. *Standard Specifications* Section 6-03.3(32) then specifies the required minimum number of pins and bolts for field connections and splices.

Steel railings may be erected in place at the same time the trusses are erected but they shall not be finally aligned or bolted until after the concrete deck is placed. Railings shall be true to line, and for single spans shall show the camber of the span. For two or more spans the railing shall show a uniform camber over all of the spans; that is, the individual camber of each span shall not be carried in the railing.

### **SS 6-03.3(33) Bolted Connections**

All bolted connections are designed by WSDOT to be friction connections. A friction connection transfers the stress by friction between surfaces in contact and does not depend on shear or bearing between members and bolts. The friction is provided when the connection or splice members are compressed through tension on the bolts (measured by turn-of-nut or direct-tension-indicator method). To develop design contact surface friction, all bolts in a bolted connection must be properly tightened to the minimum specified tension. The *Standard Specifications* recognize that final design loads are not present during erection of the structural steel members. Therefore, during erection, all the bolts are not needed in order to develop the friction necessary in the connection or splice for erection loads. The *Standard Specifications* recognize this and require a minimum percentage of the holes to be filled during erection; for instance, 50 percent for normal structures and 75 percent for cantilevered structures. These holes are filled with a combination of drift pins and bolts. Drift pins are required to properly align the members since bolts are usually smaller in diameter than the holes. Bolts are required to develop the minimum friction required to transfer erection loading. The minimum friction or load-carrying capacity is not developed until the bolts are tightened to the specified minimum tension.

Once the member is released from its support (support falsework or crane), the *Standard Specifications* specify the procedure required to complete bolting of each connection.

Sometimes fabricators will temporarily bolt-splice plates to the appropriate member. The fabricator will usually use the minimal number of bolts to secure the splice plate during shipping and handling. These temporary bolts shall be removed and replaced with high-strength bolts.

Structural steel field connections are made with high tensile strength bolts conforming to the requirements of *Standard Specifications* Section 9-06.5(3) and the special provisions. A special heat treatment gives these bolts a high tensile strength.



WSDOT designed bolted connections generally operate by a transfer of stresses by friction between surfaces in contact and do not depend on shear or bearing between the members and the bolts. Therefore, it is imperative that the contact surfaces of the metal shall be properly cleaned and the required minimum tension be obtained in the bolts.

The required tension in the bolts may be obtained by using either the Turn-of-Nut method or the Direct Tension Indicator (DTI) Method unless the specifications for the project state otherwise. If required because of bolt-entering and wrench operation, tightening by either procedure may be done by turning the bolt while the nut is prevented from rotating. *Standard Specifications* Section 6-03.3(33) requires a hardened washer under the turned element. Therefore, if the bolt is turned, a hardened washer is required under the bolt head. A hardened washer is also required with the DTI Method.

Bolted parts shall fit solidly together when assembled. Where an outer face of the bolted parts has a slope greater than 1:20, with respect to a plane normal to the bolt axis, a beveled washer shall be used to compensate for the lack of parallelism. See [Figure 6-6](#). Bolts shall be tightened beginning from the center of each connection towards the edges of the connection. All joint surfaces, including those adjacent to the bolt heads, nuts or washers, shall be free of scale, except tight mill scale, and shall also be free of burrs, dirt, and other foreign material that would prevent solid seating of the parts.

**Figure 6-6**

	AASHTO M 164	AASHTO M 253
Type 1	A 325	A 490
	8S	10S
Type 2	A 325	A 490
	8S	10S
Type 3*	A 325	A 490
	8S3	10S3

\*At the manufacturer's option, Type 3 bolts may have additional distinguishing marks to indicate the bolt is atmospheric corrosion resistant and of weathering type.

AASHTO specifications require that bolts bear specific identification marks. The following identification is marked on the top of the bolt heads:

Nuts of all classes, in nominal diameter M5 and larger, shall be marked with the property class designation (5, 9, 10, 12, 8S, 10S, 8S3, 10S3) on the top or bearing surface, on the top of flange, or on one of the wrenching flats. Additionally, nuts of Classes 10, 12, 8S, 8S3, 10S, and 10S3 shall be marked with a symbol to identify the manufacturer. For Classes 8S3 and 10S3 nuts, the manufacturer may add other distinguishing marks to indicate the nut is atmospheric corrosion resistant and of a weathering grade of steel.

Type 3 bolts must be used when the structure is not being painted (WSDOT rarely utilizes unpainted structural steel for new structures). Nuts and washers used with Type 3 bolts must also have weathering characteristics.

Each fastener shall be tightened to provide, when all fasteners in the joint are tight, at least the minimum tension shown in the *Standard Specifications* for the size and grade of fastener used.

## Turn-of-Nut Method

When the turn-of-nut method is used to provide the specified bolt tension, all of the required minimum number of bolts within a bolted connection or splice shall be brought to a “snug tight” condition. The bolts shall be tightened to “snug tight” in a systematical order to ensure that all parts of the joint are brought into full contact with each other. This usually requires that the bolts located near the center of the connection or splice be tightened first. Then all remaining bolts shall be tightened from the center progressing toward the outer edges. “Snug tight” is defined as the tightness attained by (1) a few blows from an impact wrench, or (2) the full effort of a man using an ordinary spud wrench. The “snug tight” requirement also establishes the starting point for full tensioning by the turn-of-nut method.

Once the bolts are snug tight, the outer face of the nut and protruding part of each bolt shall be match-marked with crayon or paint. The match-marking provides the control to both ensure the bolt does not rotate during tightening and measure the nut rotation. The required minimum nut rotation is listed in Table 4 of *Standard Specifications* Section 6-03.3(33). During this tightening operation, there shall be no rotation of the part not turned by the wrench.

Contractors often suggest a tightening method that eliminates marking the bolt as required in the turn-of-nut method. This suggested method requires calibration of the air impact wrench(es) and the inspection torque wrench. After calibration, the Contractor wants to snug tighten each bolt, then tighten to minimum tension using the air impact wrench without marking the nut and bolt. This method is heavily dependent upon the torque wrench test and is not accepted by WSDOT.

## Direct Tension Indicator Method (DTI)

When the direct tension indicator method is used to provide the specified bolt tension, all of the required minimum number of bolts within a bolted connection or splice shall be brought to a “snug tight” condition. The bolts shall be tightened to “snug tight” in a systematic order to ensure that all parts of the joint are brought into full contact with each other. This usually requires that the bolts located near the center of the connection or splice be tightened first. Then all remaining bolts shall be tightened from the center progressing toward the outer edges. “Snug tight” is defined as the tightness attained by (1) a few blows from an impact wrench, or (2) the full effort of a man using an ordinary spud wrench.

This method uses a direct-tension-indicator washer that has formed protrusions on one face, leaving a gap. As the bolt is tensioned, the formed gap is reduced. The measurement of this gap verifies the bolt tension. *Standard Specifications* Section 6-03.3(33) addresses the maximum gap opening for direct tension indicators.

WSDOT has two concerns associated with the use of direct-tension-indicator washers. These concerns are (1) potential corrosion within the washer gap and (2) undetected bolt loosening as bolt tightening of a connection or splice proceeds. Following is a brief discussion of each item:

1. **Potential Corrosion** – The Specifications address this potential corrosion problem by limiting the maximum gap opening for painted and unpainted structures. These gap opening limits are governed by both tension requirement and required corrosion protection. The direct tension indicator manufacturers address only the minimum bolt

tension requirement. It is, therefore, very important that the Inspector be aware of this additional concern of potential corrosion.

2. **Undetected Bolt Loosening** – The manufacturers of the direct-tension-indicator washers emphasize the ease and reliability of their product. They claim, and it is true, that if the gap is reduced to the specified maximum opening, the respective bolt is properly tensioned. The concern we have is that through the process of tightening all the bolts in a connection or splice, a warped plate may be progressively flattened, potentially loosening the initially tightened bolts. If this happens, the indicator washer still indicates the bolt(s) are fully tensioned. For this reason, WSDOT requires that bolt tension inspection, usually with a calibrated torque wrench, be performed. The Inspector should be aware of this potential problem and observe the tightening procedure with this in mind.

### **SS 6-03.3(33)B Bolting Inspection**

The Inspector shall determine that the requirements of the *Standard Specifications* are met in the work. The Inspector shall observe the installation and tightening of bolts to determine that the selected tightening procedure is properly used and shall determine that all bolts are tightened and, in the case of the direct-tension-indicator method, that the correct indication of tension (gap) has been achieved. Bolts may reach tensions substantially higher than the value in Table 3 of *Standard Specifications* Section 6-03.3(33), but this is not cause for rejection.

The condition of the bolts is critical to the bolt-up operation and inspection. Bolts to be installed in the structure shall be lubricated in accordance with the *Standard Specifications*. A good check is a nut that is easily turned on the entire threaded portion of the bolt.

The following inspection procedure shall be observed for:

1. **Bolts tightened Using the Turn-of-Nut Method** – The Contractor, in the presence of the Engineer, shall use an inspection wrench which may be a torque wrench. Calibration of the inspection torque wrench is explained in a following section.

Bolts that have been tightened using the turn-of-nut method shall be inspected by applying, in the tightening direction, the inspecting wrench and its job-inspecting torque to 10 percent of the bolts, but not less than two bolts, selected at random in each connection. If no nut or bolt head is turned by this application of the job inspection torque, the connection shall be accepted as properly tightened. If any nut or bolt head is turned by the application of the job inspecting torque, this torque shall be applied to all bolts in the connection, and all bolts whose nut or head is turned by the job inspecting torque shall be tightened and re-inspected. As an alternate, the Contractor may retighten all of the bolts in the connection, and then resubmit the connection for the specified inspection.

2. **Bolts Tightened Using the Direct-Tension-Indicator Method** – The Contractor, in the presence of the Engineer, shall use a feeler gauge to verify that each bolt has been properly tensioned to the maximum specified gap.

If a bolt that has had its direct-tension-indicator washer brought to full load loosens during the course of bolting the connection, the bolt shall have a new direct-tension indicator washer installed and be re-tensioned. Reuse of the bolt and nut are subject to the provisions in the *Standard Specifications*.

### Calibration of Inspection Torque Wrench

Five bolts of the same grade, size, and condition as those under inspection shall be placed individually in a calibration device capable of indicating bolt tension at least once each working day. There shall be a washer under the part turned in tightening each bolt. Each bolt shall be tightened in the calibration device by any convenient means to the specified minimum tension. The inspecting wrench then shall be applied to the tightened bolt and the torque necessary to turn the nut or head 5 degrees (approximately 1 inch) at a 12 inch radius) in the tightening direction shall be determined. The job-inspection torque shall be taken as the average of three values, thus determined after rejecting the high and low values.

If the bolts to be installed are not long enough to fit in the tension calibrator, five bolts of the same grade, size, and condition as those under inspection shall be tested using Direct-Tension-Indicator (DTI) to measure bolt tension. This tension measurement test shall be done at least once each inspection day. The DTI shall be placed under the bolt head. A washer shall be placed under the nut, which shall be the element turned during the performance of this tension measurement test. Each bolt shall be tightened by any convenient means to the specified minimum tension as indicated by the DTI. The inspecting wrench shall then be applied to the tightened bolt and the torque necessary to turn the nut 5 degrees (approximately 1 inch) at a 12 inch radius) in the tightening direction shall be determined. The job-inspection torque shall be taken as the average of three values, thus determined after rejecting the high and low values.

Figure 6-7 shows the operator calibrating a hand-indicator torque wrench. The bolt is brought to the proper tension by either method described above. The dial on the wrench was set at “zero” and sufficient torque applied to rotate the nut 5 degrees in the tightening direction. At this point, the wrench dial shows the kips required to further rotate the nut or bolt head. The torque wrenches used by inspectors of both the Contractor and WSDOT should be tested and compared at the same time for purposes of uniformity.

Figure 6-7

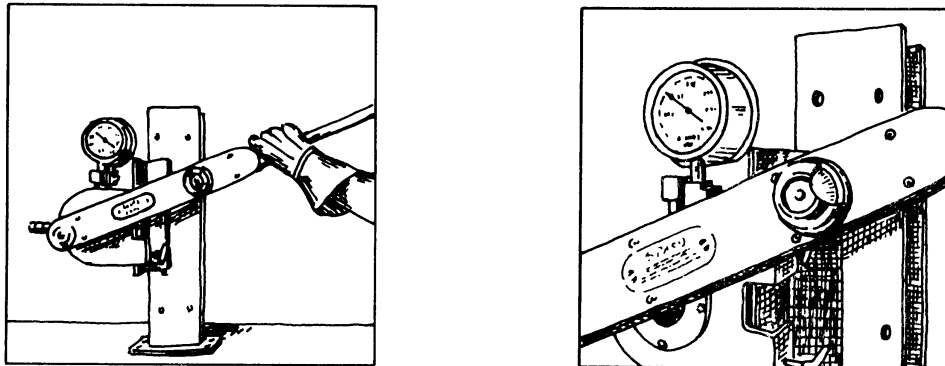

#### SS 6-03.3(35) Setting Anchor Bolts

Anchor bolts are usually plain round bolts with the head and plate washer on the lower end and the thread and nut at the top end. These bolts are set in pipe sleeves to allow room for adjustment of the span. Location of anchor bolt sleeves is very critical and must be verified by the inspector. Also, the exposed length of anchor bolts should be checked to ensure enough thread is exposed out of the pier cap to tie down the lower bearing assembly.

Anchor bolt sleeves, when anchor bolts will not be grouted until after freezing weather, must be protected against damage from expanded ice by filling the sleeves with a nonevaporating antifreeze solution. Without exception, when piers and superstructures are constructed under separate contracts, the anchor bolt sleeves shall be filled with a nonevaporating antifreeze solution by the substructure Contractor. Before the bolts are grouted, the antifreeze solution shall be removed, the space well cleaned and the holes then filled with grout. The antifreeze solution shall be diluted with water and completely removed from the sleeves or it will have a detrimental effect on the filler grout. See *Standard Specifications* Section 6-02.3(18).

### **SS 6-03.3(36) Setting and Grouting Masonry Plates**

It is important to set bearings level on all piers. Bridge plan bearing details usually show a leveling method. Bearings shall be set so that they are at zero movement at 64°F after the total load is applied and the span is released. The amount of offset varies with the length of the span and the temperature at time of erection.

Anchor bolt holes and the void underneath masonry plates shall be grouted, after all structural steel is erected and adjusted for length and camber, and at least seven days before the deck concrete is placed. Portland cement shall be used for grouting and the procedure should be as outlined in *Standard Specifications* Section 6-03.3(36).

Do not grout underneath masonry plates with dry mortar unless specifically shown in the plans. The Contractor shall build forms around the masonry plate about 4 in high and pour grout in the form from one side until the whole area is well filled. Use a wire or steel band to keep the grout flowing. After the grout has taken its initial set, remove the form and cut the edges of the grout with a trowel to about a 45 degree bevel from the bottom of the shoe to top of the pier. Do not allow the finished grout to extend above the bottom of the masonry plate.

### **SS 6-03.3(39) Swinging the Span**

As required in *Standard Specifications* Section 6-03.3(39), the masonry plates shall be grouted and steel work, except railing, completely bolted and released from the falsework before forming for the roadway slab begins. Expansion dams shall not be bolted down until after the span is released from the falsework.

The camber diagram shown in the plans, especially for welded steel plate girders, quantifies the calculated deflection of the steel girder weight and the deflection of the girders due to the concrete slab weight. The camber diagram for the weight of the steel girders only is utilized by the girder fabricator.

Once all the temporary girder supports are removed, it is important that elevation control points on the top of the flanges of the girders or floor beams be established and permanently marked before any external load, such as form lumber, reinforcing steel, etc., is applied. These control points should be located at proper intervals to establish elevations for formwork and finished roadway slab grades. These control points should be at the span tenth points or at cross-frame locations (panel points).

Once these control point elevations are established, fills at each of these control points shall be calculated utilizing the camber diagram for the weight of the roadway slab and the profile grade. These control point fill values shall be used from that point on because it is extremely difficult, if not impossible, to calculate the deflection of the girders as

formwork and reinforcing steel are added. These control point fill values will be used for the final adjustment of the roadway slab finish machine.

A pouring sequence for the roadway slab may be shown in the plans to reduce the size of the concrete pours, control deflection, and minimize tension cracking of the concrete slab during construction. Placing and finishing the concrete in the roadway slab shall be the same as for Concrete Structures covered in Section 6-2.

### **SS 6-03.4/5 Measurement and Payment**

Measurement and payment instructions are covered in *Standard Specifications* Sections 6-03.4 and 6-03.5.

## **6-04 Timber Structures**

### **SS 6-04.3(3) Construction Requirements**

#### **SS 6-04.3(1) Storage and Handling Material**

Timber and lumber shall be stored off the ground and piled to shed water and prevent warping. Treated timber shall be handled carefully to prevent breaking of the outer fibers and rope or chain slings shall be used. Pike poles and peaveys are not to be used in handling treated timber.

All cutting, framing and boring of treated timbers shall be done before treatment insofar as is practicable. Framing shall be done in accordance with the requirements of *Standard Specifications* Section 6-04.3.

#### **SS 6-04.3(3) Shop Details**

Framing plans and details for treated timber structures shall be furnished by the Contractor and reviewed by the Project Engineer. After review of the framing details, one set shall be returned to the Contractor and one set furnished the shop inspector. Inspection of shop framing and treating of timber is performed by shop inspectors of the Materials Lab. Inspection reports showing details of treatment and lists of materials shipped will be mailed to the Project Engineer. Representative pieces of each shipment will be stamped by the shop inspector.

Untreated timber may be accepted on the basis of an inspection certificate in accordance with *Standard Specifications* Section 9-09.2(3).

#### **SS 6-04.3(4) Field Treatment of Cut Surfaces, Bolt Holes, and Contact Surfaces**

When field framing cannot be avoided, the cuts and holes shall be treated as required in the *Standard Specifications*. Timber for field treatment must be dry before applying the required treatment. Holes shall be bored for all bolts, drift bolts, boat spikes, dowels and truss rods using augers of the size specified in *Standard Specifications* Section 6-04.3(5).

After removal of temporary scaffolding and formwork, the nail and bolt holes in treated timber shall be repaired in accordance with the *Standard Specifications*.

Field treatment for structures of untreated timber shall be in accordance with the requirements in *Standard Specifications* Section 6-04.3(4).

**SS 6-04.3(18) Painting**

Painting of timber structures shall be in accordance with the requirements in *Standard Specifications* Section 6-07.

**SS 6-04.4/5 Measurement and Payment**

Measurement and payment instructions are covered in *Standard Specifications* Sections 6-04.4 and 6-04.5.

**6-05 Piling****GEN 6-05.1 Vibration Monitoring during Pile Driving**

On some projects, pile driving vibrations will be monitored for potential damage to adjacent structures or buildings. When that monitoring indicates a potential for damage, the Project Engineer should ensure that the minimum size hammer specified for the piling being driven is actually being used. If so, and vibrations are still potentially damaging, the State Construction Office should be notified to determine if preboring or jetting should be used to reduce vibrations. Should preboring or jetting, or other methods be determined necessary, such work shall be considered a change in accordance with *Standard Specifications* Section 1-04.4.

**GEN 6-05.2 Pile Driving Records**

Pile driving records are to be kept in the Pile Driving Record Book (DOT Form 450-004) or on the Pile Driving Log (Form 450-004A), which becomes part of the project final records. This book has sufficient room for a condensed pile driving history, pile layout, and miscellaneous notes in addition to the driving log for each pile. Number the piles on the sketch in the pile layout and use these for the Pile No. on the pile driving log.

The pile driving record book contains instructions for completing the driving log. In order for this log to furnish complete information on the pile driving work, it is imperative that it be filled out completely in accordance with the instructions in the book. If more space is necessary, use more than one page for the pile. Items in the heading which are the same for several piling, may be marked "Same as Pile No. \_\_\_."

The piling should be marked every foot of their lengths with crayon or paint unless there is some other method of determining when each foot of the pile has been driven. Count and record the number of blows per foot and hammer energy as the pile approaches bearing.

**SS 6-05.3 Construction Requirements****SS 6-05.3(2) Ordering Piling**

Piling shall conform to the requirements of *Standard Specifications* Section 9-10. When piling is received on the project, it shall be inspected and a notation made in the Section of Miscellaneous Notes in the Pile Record book. Untreated timber piles will be inspected in the field and accepted for use there. All other piling, except concrete piles cast on the job, will be inspected by Fabrication Inspectors before delivery.

The lengths of piling required are determined by driving test piles or by other information which may be available. The Project Engineer provides the Contractor with an order list

for timber and precast concrete piles. This list must show the length of piles required below cutoff (the top of the pile within the footing). The Contractor should be informed that the lengths shown on the order list should be increased, at their expense, the necessary amount to provide for fresh heading and to reach from the cutoff elevation up to the position of the driving equipment. Payment for piling will be made for the number of feet shown on the order lists except that if greater lengths are driven, with the concurrence of the Project Engineer, payment will be made for the lengths actually driven below cutoff. Itemized lists for cast-in-place piles or steel piles will not be furnished by the Engineer.

### **SS 6-05.3(3) Manufacture of Precast Concrete Piling**

#### **SS 6-05.3(3)A Casting and Stressing**

Curing beds for steam cured concrete piles shall not rest directly on the floor but shall be elevated enough to permit the complete circulation of steam around the piles.

Lifting loops shall be removed to ½ inch below the surface of the concrete and the hole filled with mortar.

Concrete piles shall be handled as described in the *Standard Specifications*, the *Standard Plans*, or as shown in the plans in order to avoid excessive deflections and strains.

### **SS 6-05.3(6) Splicing Steel Casings and Steel Piles**

When steel piles must be spliced and splicing details are not shown in the plans, the splice should be made with a single V-butt weld over the whole cross-sectional area of the pile. Welding shall be done with specified welding rod and suitable equipment in accordance with American Welding Society Specifications and good industry practice. A qualified welder is required. See *Standard Specifications* Section 6-05.3(6).

No Engineer's order list will be given for steel piling.

### **SS 6-05.3(7) Storage and Handling**

#### **SS 6-05.3(7)A Timber Piles**

Chain slings will be permitted in handling treated timber piles. Treated timber piling shall be furnished and driven full length, i.e., without splices. The entire length shall be pressure treated. Therefore, the pile tip shall not be cut after treatment. If splices become necessary and the order length furnished by the Engineer is insufficient, the State Construction Office should be contacted for direction. However a splice probably will not be considered if it cannot be located below the permanent water table elevation.

#### **SS 6-05.3(7)B Precast Concrete Piles**

Precast concrete piles require special care in storage and handling, especially when raising them into the leads. The general method of attaching slings for handling is described in the *Standard Specifications*. Long piles must be supported at the ends and at intermediate points to prevent undue bending and cracking of the concrete. In special cases the plans may show the method for lifting long piles. Some pile driving crews lack experience with concrete piles and handle them as they are accustomed to doing with timber piles. Such handling will probably result in damage to the concrete piles and must not be allowed.



**SS 6-5.3(7)C Steel Casings and Steel Piles**

Steel piling shall be handled in such manner as to prevent bending of the flanges, and when stacked they shall be supported in such a manner that the piles will not bend.

No Engineer's order list will be given for cast-in-place concrete piling.

**SS 6-05.3(9) Pile Driving Equipment****SS 6-05.3(9)A Pile Driving Equipment**

The type and size of hammers to be used to drive piling are specified in *Standard Specifications* Section 6-05.3(9)B. The Project Engineer shall require the Contractor to furnish full information on any hammer proposed for use so it can be determined whether or not the hammer meets the requirements of the specifications and that the bearing capacity of driven piles may be computed. It is very important to verify that the drop of the ram is in accordance with the submitted data. Otherwise, the pile bearing calculations will not be correct. A useful formula to determine the drop of a single acting diesel hammer determined from measuring the blows per minute is:

$$\text{Stroke Formula (ft of drop)} = (4.01((60/\text{BPM})^2) - 0.3)$$

Where BPM is the blows per minute of the hammer.

This drop can then be used in the bearing equation shown in *Standard Specifications* Section 6-05.3(12) to determine the bearing of the piling.

This formula calculates the drop from the rate of blows per minute that the hammer is hitting at and makes it no longer necessary to watch the top of the hammer and estimate the distance that hammer is coming out of the casing. Since the rate the hammer runs at is dependent on the drop of the hammer, and this hammer drop is accelerated at a constant by gravity, the distance the ram travels can be determined from the formula.

**SS 6-05.3(9)B Pile Driving Equipment Minimum Requirements**

*Standard Specifications* Section 6-05.3(9)B and the special provisions, govern the hammer size by specifying the minimum ram weight and the minimum energy required for each type of pile, required bearing, and hammer. The most commonly used hammers are air, hydraulic, or diesel activated. The hammer energy output is simply the weight of the ram times the distance the ram falls. This energy determination is a simple matter with a drop, hydraulic, or air/steam activated hammer. The measurement of the energy output of a diesel activated hammer is more complex. The minimum energy required by the specifications is the energy output of the hammer at the point of impact at the required pile bearing. The hammer needs to operate at or above the required minimum energy level in order to achieve the specified pile bearing capacity.

The Project Engineer may concur with the Contractor's proposed hammer if it meets the criteria of the *Standard Specifications* and the special provisions. During field operations, the pile driving hammer must be capable of delivering at least the required minimum energy at the required pile bearing value. The State Construction Office should be consulted for any other hammer submittals or insufficient performance in the field.

Drop hammers, which are rarely used, must be weighed, in accordance with *Standard Specifications* Section 6-05.3(9)B, before any piles are driven. The drop hammer stroke should be carefully measured. This can be done by taping a piece of rope or rag around

the hammer line at the height above the hammer for the drop desired. The hammer operator can then gauge the drop with reasonable accuracy. The stroke (drop) of the hammer ram must be consistent with the required minimum energy.

Air or steam activated hammers lift the ram by either air or steam pressure to a predetermined distance and release the ram. The energy is produced by the falling ram. These hammers usually operate at 50 to 60 blows per minute depending on the hammer manufacturer. A count of the actual blows per minute will provide verification that the hammer is operating properly. If the blows per minute exceed the published manufacturer's data sheet for the specified minimum energy, and the Contractor is not able to find and rectify the problem, the State Construction Office shall be notified. No additional piling are to be driven until the problem is resolved.

Hydraulic activated hammers lift the ram by hydraulic fluid pressure to a predetermined distance and then release the ram. The energy is produced by the falling ram. There are two types of hydraulic activated hammers, single and double acting. The hydraulic activating systems for both of these types of hammers are totally enclosed using a vegetable oil medium, rendering them environmentally friendly. The method for measuring the energy output is different for each type of hydraulic activated hammer. The energy output for each type can be varied by using simple adjustment procedures. Again, the respective hammer must be operating at or above the specific minimum energy when the required pile bearing capacity is reached.

Diesel activated hammers lift the ram by energy produced when diesel fuel is ignited. The energy produced is a combination of the fuel explosion and the drop of the ram. There are two types of diesel activated hammers, single and double acting. The method for measuring the energy output is different for each type of diesel activated hammer. Diesel hammers produce a variable energy. The variable energy output of a diesel hammer is dependent on a number of factors, which include fuel quality, fuel setting, soil conditions, and resistance from the pile being driven. As the pile resistance increases, the energy output of a diesel hammer usually increases. The manufacturer's maximum energy value for each diesel hammer is measured in the laboratory using a hammer in tip top shape. For this reason, it is a good idea to have a hammer on the project with a maximum rated energy higher than the contract minimum required energy. A good rule of thumb when selecting a diesel hammer is that, if 80 percent of the maximum energy of a hammer equals the contract minimum required energy, the diesel hammer will produce sufficient energy to meet the contract energy requirements.

A single acting diesel activated hammer is open at the top, and at the top of the ram stroke a portion of the ram is usually visible. The bearing value of the pile being driven is determined by the number of blows per foot at a blows per minute rate. The energy output of a single acting diesel hammer is determined by the blows per minute of the running hammer. The manufacturer is required to submit this energy data. The rate (blows per minute) is dependent on how high the ram raises up (stroke) due to the diesel fuel combustion. Thus, the longer the stroke, the greater the energy and the longer it takes. In other words, as the rate (blows per minute) decreases, the energy output increases.

A double acting diesel activated hammer is closed at the top. This closed top acts as a pressure chamber driving the ram back down where the diesel fuel explosion occurs. The bearing value of the pile being driven is determined by the number of blows per foot at a measured pressure within the top bounce chamber. The energy output of a double acting diesel hammer is determined by the measured bounce chamber pressure while the hammer is operating. The manufacturer is required to submit this energy data. Each

double acting diesel hammer comes with a hose running from the bounce chamber to a box containing a pressure gauge. There is usually a button on this pressure gauge box. When the button is depressed the gauge is activated with the bounce chamber pressure. If this button is depressed continuously, the hammer efficiency decreases because of the pressure bleed off created by the pressure gauge operation. The button should only be depressed periodically when an energy reading is required. The pressure reading and corresponding energy shall meet the minimum energy at the required pile bearing value.

The Contract allows the use of vibratory hammers to initially set piles. As of yet, there is no reliable means of determining the actual bearing capacity of a pile driven by a vibratory hammer. Often, the contractor wants to initially set piles with vibratory hammers if the soils and/or limited access are such that impact hammer operation would be difficult. The Contract allows this but requires that an impact hammer be used to acquire the bearing capacity. Since static friction is usually much higher than dynamic friction, the actual bearing capacity is determined while the pile is in motion. This requirement is governed by the contract requirement that the pile must be driven at least an additional 2 feet using an impact hammer with the blow count (blows per inch) constant or increasing. If the contractor uses a vibratory hammer to initially set the piles, there must be a comprehensive procedure to ensure proper location and plumbness of each pile. This is usually accomplished by providing a rigid steel template and using good conscientious control while setting and initially driving each pile.

#### **SS 6-05.3(9)C Pile Driving Leads**

Pile driving leads shall be fixed at the top and bottom as discussed in *Standard Specifications* Section 6-05.3(9)C, to ensure that the piling can be accurately driven both as to position and batter.

#### **SS 6-05.3(10) Test Piles**

A careful study should be made of the foundation exploration data shown in the plans and/or included in the Geotechnical Report before driving any test piles. Care should be taken that the test piles are not stopped on a relatively thin hard layer overlaying softer material. After the test piles have been driven, an effort should be made to correlate the results with the foundation data before ordering the permanent piles. The results from driving the test piles should be discussed with the Regional Operations/Construction Engineer if they do not correlate with the foundation data.

Test piles shall be driven to at least 15 percent more than the ultimate bearing capacity required for the permanent piles, except where pile driving criteria is determined by the wave equation. When pile driving criteria is specified to be determined by the wave equation, the test piles shall be driven to the same ultimate bearing capacity as the production piles. Test piles shall penetrate at least to any minimum tip elevation specified in the Contract. If no minimum tip elevation is specified, test piles shall extend at least 10 feet below the bottom of the concrete footing or groundline, and 16 feet below the bottom of the concrete seal.

Preboring, jetting, or other means may be used to secure minimum penetration with the test pile if such means is necessary and will be used for the permanent piles. The reason for driving the test pile is to obtain information for ordering the permanent piles, and to obtain additional information relative to driving the permanent piles.

It is the responsibility of the Contractor to supply test piles of sufficient lengths to provide for variation in soil conditions. If the piles furnished are not long enough, or are unsuitable in other ways, it will be necessary for the Contractor to supply acceptable piles. Followers will not be permitted in driving test piles. A follower is a member interposed between a pile hammer and a pile to transmit blows while pile head is below the reach of the hammer (pile head below the bottom of leads).

The State Construction Office should be notified of the date test piles will be driven.

Test piles shall also be recorded in the pile driving record book. In addition, following the driving of each test pile, the Test Pile Record form shall be completed and sent to the appropriate offices the following day. This form should be filled in completely, including the rate/pressure of the hammer. Record the bearing value of the test pile for each foot as it is driven.

### **SS 6-05.3(11) Driving Piles**

It is suggested that the State Construction Office be contacted before any piling are driven.

#### **SS 6-05.3(11)A Tolerances**

Foundation piles must be driven true to line and in their proper position so that full bearing and lateral support is secured for each pile. Each pile has been definitively positioned in the design, and piles should be driven as nearly as practicable to the position shown. Any variation of 6 inches or more from the plan shall be reported to the State Construction Office before accepting the pile. The tolerance for all types of battered piles is  $\frac{1}{4}$  inch in 12 inches. Any deviation exceeding this tolerance shall be reported to the State Construction Office for evaluation.

Care shall be taken in driving steel H piles to ensure that the driven pile is oriented as close as possible to that shown in the plans. Pile design usually involves horizontal forces due to temperature, concrete shrinkage, earthquake, and wind as well as axial forces, and if a driven pile is not aligned as shown in the plans, the pile may become overstressed due to excessive bending stresses. Any deviation of more than 20 degrees from the pile axis or more than 6 inches from the position shown in the plans shall be reported to the State Construction Office for evaluation and acceptance.

Large diameter prestressed concrete cylinder piles are not completely covered in the *Standard Specifications*. The requirements of the special provisions must be observed. Accuracy of placing and driving is most important. Every effort should be made to prevent these piles from drifting out of line or out of plumb during driving, but care must be taken to avoid applying excessive lateral force which may crack the pile. These piles do not have to be very far out of plumb before excessive overstress occurs. When a driven pile is found to be cracked or is out of plumb, it should be referred to the State Construction Office for a decision regarding corrective action to be taken.

#### **SS 6-05.3(11)D Achieving Minimum Tip Elevation and Bearing**

Piling shall be driven to develop the bearing value as shown in the plans or in the *Standard Specifications*. The penetration of the piles under the last few blows must be carefully gauged and the bearing value computed by use of the formula shown in the *Standard Specifications*. Pile driving specifications should be administered with a great deal of common sense. There is no substitute for experience and good judgment.

Often the foundation reports contain two pile tip elevations, “estimated tip” and “minimum tip” elevations. The estimated tip elevation is simply the elevation that the tip is estimated to be driven to and is utilized to determine driving length quantities in the bid item for furnishing piling. Minimum tip elevations are often specified in the contract plans. These are usually to ensure that piles do not hang up on logs, a thin hard soil layer and other obstructions, or to achieve a minimum pile penetration (e.g., uplift and/or lateral load capacity). Minimum tip elevations are also specified where resistance to uplift is taken into consideration in the design of the foundation seal thickness. The minimum tip elevations should be higher than the estimated tip elevations. The Project Engineer should always review the tip elevations in the plans and compare them to the foundation report recommendations. Any discrepancies should be reported to the State Construction Office.

The minimum tip elevations is a design parameter that may come from the geotechnical design or the structural design. A pile tip elevation that is less than minimum cannot be accepted in the field, it must be reviewed by the State Bridge and Structures Office, the State Bridge Construction Office, and the State Geotechnical Engineer. If, during the initial pile driving operations, minimum tip is not being achieved, no additional piling should be driven until concurrence is obtained to change the minimum tip elevation, or the contractor will have to change his method of installation so that the minimum tip elevation can be achieved.

The use of water jets may be required for driving piles, especially for concrete piles. The piles must be driven at least 6 inches after the jet is removed, or to the required bearing. Do not allow the nozzle of the jet to penetrate below the tip of piling previously driven. Mark the jet pipe in such manner that the operator and Inspector can determine the depth required. The State Construction Office should be notified if water jets are proposed for use.

Preboring may also be used to secure the minimum specified penetration. Usually the prebored hole should be slightly smaller in diameter than the pile and the depth of preboring should be less than the minimum specified penetration. However, conditions may exist which make it necessary that a larger hole be prebored and the space around the pile be filled with sand while the pile is being driven to the specified bearing. Unless water-jetting, preboring, or other means of securing minimum penetration is specified and payment is provided for in the contract provisions, this work will be at the Contractor's choice and expense. However, the procedure used must be reviewed by the Engineer and shall result in a satisfactory pile and will not damage the integrity of the structure, roadway, adjacent structures, or utilities. Any damage done must be repaired to the satisfaction of the Engineer at the Contractor's expense.

Where the specified minimum tip elevations cannot be reached the State Construction Office shall be notified.

### **SS 6-05.3(11)F Pile Damage**

Rejected piles shall be removed or cut off 2 feet below the bottom of the footing.  
Rejected casings for cast in place piles that are left in place shall be filled with sand.

In driving precast concrete piles, several layers of plywood or a 3½ inches wood block should be placed between the top of the pile and the steel driving head of the hammer. Care should be taken to prevent crushing of the pile head before the desired penetration is reached. Where crushing occurs, the top of the pile should be checked to determine if the end is square with the body of the pile; also, the hammer should be checked to

determine if a fairly flat blow is being delivered to the pile. In driving concrete piles, it may be advisable, in order to prevent crushing of the head and to obtain the required penetration, to operate a hammer at less than full throttle until just before completing the driving, after which the throttle should be fully opened in order to obtain the true bearing value of the pile.

### **SS 6-05.3(13) Treatment of Timber Pile Heads**

The handling and driving of treated piling require special care. Heads of piles should always be freshly cut, and rings or wire mesh screens placed on top during driving. In wet weather the final cutoff should be at least 1 foot long and the creosote, pitch and fabric cover placed immediately after the pile is cut. Do not make a cutoff and then wait until the next day to place the cover. Fabric covers should be well tacked to the pile and neatly trimmed to within 3 inches of the top of the pile so that the fabric will not have ragged edges. A follower driving cap should be used on treated piles. This is to help hold the pile in line to minimize the use of chocks in the leads during driving. Timber piles must be strapped in accordance with the requirements of *Standard Specifications* Section 9-10.1 before they are driven.

### **SS 6-05.3(15) Completion of Cast-In-Place Concrete Piles**

The casings for piles cast in place shall be carefully checked after driving, for water tightness and deformation of the casing due to the driving of adjacent piles. A mirror for reflecting light into the casing is the most common method for this check. On cloudy days, a flashlight may be lowered into the casing.

Immediately after driving, the pile casing shall be covered to prevent dirt and water falling into it. All debris and water shall be removed from the casing prior to placing the reinforcing steel cage. No water will be permitted in the casing when concrete is placed.

Due to the ever increasing loading from earthquake activity, most cast in place piling require reinforcement for the full depth of the pile. This full depth reinforcement presents extreme difficulty in placing concrete with a rigid conduit the full depth, especially if the pile is battered. For this reason, Class 4000P concrete is required. This class of concrete has small aggregate and fly ash making the mix rather sticky and cohesive, which reduces the likelihood of segregation during placement. This concrete shall be placed continuously through at 5 foot rigid conduit directing the concrete down the center of the pile casing, ensuring that every part of the pile is filled and the concrete is worked around the reinforcement. The top 5 foot of concrete shall be placed with the tip of the conduit below the top of fresh concrete. The Contractor shall vibrate, as a minimum, the top 10 feet of concrete. In all cases, the concrete shall be vibrated to a point at least 5 feet below the original ground line.

### **SS 6-05.4/5 Measurement and Payment**

Measurement and payment instructions are covered in *Standard Specifications* Sections 6-05.4 and 6-05.5.

## 6-06 Bridge Railings

### GEN 6-06.1 Railing Alignment

Railings shall be carefully aligned, both horizontally and vertically, to give a pleasing appearance. On multiple span bridges, the rail and wheel guard or curb heights at the ends of each span should be varied a sufficient amount to produce a uniform camber or grade from end to end of the bridge.

At the beginning and ends of horizontal curves and through vertical curves, the height of curbs may need to be varied so that the rail heights will be uniform above the curb. On any structure on which occurs a break in grade, horizontal curve with superelevation, vertical curve, or a combination of the three, the Project Engineer should plot to a large scale, the profiles of the roadway grades at the curb lines. From these profiles the grades for the tops of the curbs and railings can be properly determined. A slight hump in the rail over the whole structure is usually not objectionable, but a hump and then a sag is not permissible.

### SS 6-06.4/5 Measurement and Payment

Measurement and payment instructions are covered in *Standard Specifications* Sections 6-06.4 and 6-06.5.

## 6-07 Painting

### GEN 6-07.1 General

When inspecting bridge painting for steel structures, the Inspector should prepare a plan for the structure they will be inspecting. This plan will enable the Inspector to locate sections of the structure where painting activities occurred.

An Inspector's Daily Report should be filled out after every work day with the activities performed and related to the Inspector's bridge plan. In the daily report, the Inspector should identify the activities such as cleaning, blasting, and applying the base, intermediate, and finish coats. These daily reports should accurately represent the work accomplished and any noted deficiencies.

The Inspector should become familiar with the latest safety requirements. Contract environmental requirements should be reviewed as well.

Manufacture and shop mixing of paint materials are controlled from the State Materials Laboratory. Each container in each shipment of paint should bear a lot number, date of manufacture, type of paint and manufacturer's name.

When quantities of paint required for a particular job are 20 gallons or less, they may be manufactured and shipped without inspection and testing by the laboratory. A certificate of compliance with specifications signed by the manufacturer shall be presented to the Project Engineer by the Contractor at the time the paint is brought to the project site.

All paint shall be thoroughly mixed before using. Paint may be mixed by stirring with hand paddles or by using power stirrers.

All paints bearing dates of manufacture over one year old should be sampled on the basis of one sample per batch. Paint showing appreciable deviation from normal should be sampled and set aside until checked and released by the State Materials Laboratory.

The paint should be capable of application at the required thickness without any sags or runs. If it is not possible to do this, the State Materials Laboratory should be contacted for necessary steps to be taken.

### **SS 6-07.3(9) Painting New Steel Structures**

#### ***SS 6-07.3(9)I Application of Field Coatings***

New steel, shop coated before erection, shall have all erection and transportation scars, rivet heads, and welds cleaned and spot coated. If a dirt film has accumulated on the steel during the erection period this must be removed by flushing. All concrete residue must be removed from the floor system after the deck pour is completed. Generally, this may be accomplished by flushing before the residue has set up and while the pour is in progress.

All coatings shall be applied per the manufacturers recommendations.

Brushes and spray equipment should be in good condition. An intermediate stripe coat should be applied to the metal edges, inside angles, welds, bolt heads, nuts and rivets prior to the application of the full intermediate coat of paint. The use of inspection mirrors is required for reflecting light into the interior of boxed sections or members for locating painting defects.

The Inspector must check to see that the proper film thickness of paint is applied. Wet film thickness is to be measured immediately after the paint is applied and the dry film thickness is to be measured after the paint has become thoroughly dry and hard. It is difficult to measure the dry film thickness of paint on galvanized metal so it is necessary to measure the wet film thickness for each coat of paint as it is applied.

When an Inspector finds an area where the painting does not meet the specifications, they should mark the area with contrasting brightly colored alkyd paint from an aerosol can. A light coat of this spray paint will not adversely affect the paint job and it will effectively mark the area to tell whether correction work was performed on the area. Marking the area with spray paint provides the Inspector with an easy method of marking deficient areas and provides the Contractor a ready method of locating the areas that require additional work. This will also free the Inspector to concentrate on areas of serious deficiencies without losing control over those requiring minor corrections. When marking the final coat, be careful to mark only the area to be reworked.

Adequate staging, scaffolding, ladders, and fall protection are required to be provided by the Contractor to ensure safety to workmen, room for good workmanship, and adequate facilities for proper inspection.

Technical assistance and equipment are available at the State Materials Lab, and on request can be provided at the job site to ensure a good paint job.

### **SS 6-07.3(10) Painting Existing Steel Structures**

#### ***SS 6-07.3(10)A Containment***

Containment systems are required by the Contract. Containment systems are required during the cleaning and painting of the bridge. These systems are necessary to prevent contaminants from entering state waters.



**SS 6-07.3(10)D Surface Preparation Prior to Overcoat Painting**

Cleaning for removal of rust or corrosion spots in repainting and cleaning of new steel shall mean “commercial” abrasive blasting as defined in the *Standard Specifications* or the special provisions.

Wire brushing and scraping shall normally be limited to removal of dirt and loose paint where corrosion is not involved.

All rust which cannot be removed by abrasive blasting shall be removed with chisels, hammers or other effective means as directed by the Engineer.

When called for in the *Standard Specifications* or the special provisions, the entire structure shall be pressure flushed with water from the top down before other cleaning or painting is started. The nozzle should not be more than 9 in from the surface being cleaned. A biodegradable detergent may be added to the water jet to remove oil and grease. Biodegradable detergents shall be reviewed by the State Materials Laboratory and precautions taken to avoid harmful residue on the steel.

In addition to the initial pressure flushing, all abrasive blasting residue must be removed after blasting and spotting and before application of additional paint. Pressure flushing may be required for this purpose if the Project Engineer deems it necessary.

On repainting projects, the Engineer or Inspector should observe and report to the State Bridge and Structures Engineer any spot or area where corrosion or other deficiencies are of such extent as to threaten the strength of the steel member. They should also observe areas where water becomes trapped to ultimately endanger the steel through corrosive action, and advise the Regional Operations/Construction Engineer, so the condition may be corrected.

**SS 6-07.3(10)F Collecting, Testing, and Disposal of Containment Waste**

During the preparation and painting of steel bridges, it is very important that the Inspector be aware of the potential impact to the surrounding environment. The air, water, and land quality are of major concern. WSDOT and environmental agencies are working together to establish guidelines for bridge painting. Policies and procedures involving environmental concerns will be addressed in the contract. Compliance to these specifications should be closely monitored.

Many bridges that are being repainted have been previously painted with lead based paint. When this is the case, the Contractor must submit a “Lead Health Protection Program” ([WAC 296-155-176](#)). The waste generated from cleaning the bridge (bird guano, paint chips, etc.) must be tested as outlined in the contract provisions. Handling and disposal of this waste must be as prescribed by current state law. Contact your Regional Environmental Office regarding disposal of lead paint waste.

The protection of the structure, traffic, and property from splatters and airborne paint spray is the responsibility of the Contractor. Since WSDOT may be criticized because of damage from paint, the Engineer must enforce the provisions of the contract to ensure protection therefrom.

## 6-08 Bituminous Surfacing on Structure Decks

### GEN 6-08.1 Description

Most paved structures have a BST or HMA philosophy that manages the asphalt depth economically in the long term. The intent of the management is to protect the structures from excessive pavement weight, and minimize the risk of equipment loads and planer damage. Therefore, Section 6-08 addresses structural paving issues not addressed in Division 5.

### SS 6-08.2 Materials

The intended use of Bridge Deck Repair Material in Section 9-20.5 is for deck patching prior to placing a membrane.

### SS 6-08.3(2) Contractor Survey for Grade Controlled Structure Decks

The Plans specify Grade Controlled or Not Grade Controlled for each structure. This information is necessary for the Contractor QC and WSDOT QA, if desired. A Grade Controlled structure requires a Contractor survey of the existing grade profile and includes measurement of the asphalt depth prior to pavement removal when removal is to be achieved by rotary milling/planing. The Contractor needs to know the existing planing depths, in advance, to avoid damaging the concrete. The Contractor needs to know the Final Grade Profile for tolerance acceptance.

When scraping is the method of Full Removal, the asphalt depths do not need to be known prior to removal.

The Project Engineer must review the Contractor survey for safe planing depths and adjust the Final Grade Profile to meet the desired uniform depth specified in the Plans. Adjusting the Final Grade Profile and planing depths should consider the following:

1. Contractor survey for removal: Submittal review should always assume the existing asphalt depths were unknown or inaccurate at the Design stage and use the measured depths provided in the survey. Grade Controlled, Partial Removal milling depth should not be within 0.10 foot or 1¼ inches of the concrete structure at any location to preserve the deck and membrane.

Full Removal planing should not contact the concrete deck surface. Prior to milling, the Project Engineer must check the asphalt depth to the original concrete surface at all locations. The maximum mill depth should be as close as possible or to within 0.01 foot or ⅛ inch of the top of the existing deck, and not below. The planed surface should be uniform, flat, and not remove the concrete. Ideally, the asphalt removal exposes the deck without removing a layer of concrete rebar cover. Practically, there will be areas of thin pavement in previous ruts, and areas of over milling or damage. In these areas, the asphalt depths will vary and appear as inconsistent data because the original grade has changed. Using the Contractor survey, it is up to the Project Engineer to determine original grade and safe removal depths. Profile changes are often undocumented and buried on structures that have been widened in the past. Excessive pavement depth also contributes to inconsistent surveyed data.

2. Contractor survey for Final Grade Profile: The survey includes the profile beyond the structure for two reasons:
  - a. To provide a smooth transition from the existing roadway to the structure profile grade.
  - b. To identify existing problems in the transition zone.

If there is a grade profile problem on or off the structure, the Project Engineer should address the Final Grade Profile adjustment with the Contractor. If it is necessary to raise or lower the Final Grade Profile, or transition the grade, the maximum rate of grade adjustment or slope is 0.2 percent (1'/500'), per Standard Plan A60.30. Skewed bridge ends, cross slope transitions, and significant summit or sag vertical curves require extended grade transitions.

If previous paving has not been transitioned smoothly (too short), the length of the transition must be extended. If extending the transition places it outside of the project limits, contact the HQ Construction Office. An improper transition is unacceptable for two reasons:

- a. This is the common cause of many "bumps at the bridge" and may reduce the load rating. The Bridge Office may have to restrict truck loading if the transition is bad enough.
- b. It is a waste of Maintenance resources to place a temporary wedge patch to address smoothness.

#### **SS 6-08.3(4) Partial Depth Removal of Bituminous Pavement from Structure Decks**

Grade Control applies to Partial Removals when a grade correction is required on or off the structure. Partial Depth or Mill/Fill planing should never contact the concrete deck surface, see SS 6-08.3(2)1, Paragraph 1. Milled areas which contact the concrete deck or membrane should be marked for repair as damaged concrete and require a membrane repair.

#### **SS 6-08.3(5) Full Depth Removal of Bituminous Pavement from Structure Decks**

Prior to milling operations, the Inspector must verify the rotor head  $\frac{1}{4}$  inch tooth spacing and tooth length tolerance. Common planer tooth spacing of  $\frac{5}{8}$  inch or planer teeth that are not uniform length provide a surface that is too rough for waterproof membranes. Planer teeth that are worn down and not sharp severely damage concrete.

Remove loose, unbonded, or substandard HMA prior to placing a membrane. HMA in good condition and firmly bonded to the concrete does not have to be removed or chained. A Chain Drag applies to the remaining area of exposed concrete to identify repairs.

#### **SS 6-08.3(6) Repair of Damage due to Bituminous Pavement Removal Operations**

Full Removal planing must be uniform and smooth where occasional tooth strikes in the deck are unavoidable within the planing tolerance.

Milled areas below the maximum mill depth tolerance should be marked for repair as damaged concrete.

Planer damage consisting of concrete edges and ridges should be repaired flush to grade with a grout material to avoid stretching or tearing the membrane when HMA is compacted. Do not pay for this work in the Bridge Deck Repair item.

**SS 6-08.3(7) Concrete Deck Repair**

Standard Plan A-60.40, "HMA Overlay Further Deck Preparation" is available for reference and details of Bridge Deck Repair.

A qualified Region Materials staff or Inspector must be available during or shortly after the removal process in order to complete a Chain Drag test timely. The chaining identifies the existing Bridge Deck Repair quantity on the structure, whereas the Plan quantity for the Bridge Deck Repair item is an estimate that limits the cost risk and closure time to the contract. Administration of Bridge Deck Repair should follow these guidelines:

1. Section 1-04.6, Variation of Estimated Quantities applies for payment since the Chain Drag quantity and the Plan quantity will seldom match.
2. If the Chain Drag testing indicates more repairs than the Plans, it is preferred but not mandatory to negotiate more or all of the repairs within the contract. If the chained quantity exceeds 125 percent of the Plan quantity, contact the Bridge Office and the HQ Construction Office for a recommendation to proceed because excessive Bridge Deck Repair may not be cost effective and concrete deck rehabilitation may be required.
3. If the contract cannot complete all repairs, the priority repair areas are:
  - a. Full depth repairs or holes in the deck
  - b. Areas with exposed rebar to protect the steel
  - c. Fill in spalled areas to provide a level surface for the membrane
  - d. Delaminated areas
4. The Project Engineer must submit the Chain Drag Report spreadsheet to the Bridge Deck Program Manager in the Bridge and Structures Office in order to manage the concrete deck needs statewide. The Chain Drag Report spreadsheet can be obtained on the State Construction Office [SharePoint](#) site.

A Chain Drag Report documents the deck conditions after Contract. The spreadsheet has instructions to document the area (square foot) of patches, spalls, delaminations and other defects. The primary function of the report is to describe the total patching completed in the contract, and to note any deck defects or paving construction issues for future reference. The secondary function is to document the amount of incomplete repair, which is the basis for estimating the future Bridge Deck Repair quantities in the next Full Removal.

If rotary milling exceeded the depth tolerance and damaged the concrete, these areas are marked for repair at the contractor's expense in accordance with Section 6-08.3(6), Repair of Damage due to Bituminous Pavement Removal Operations.

**SS 6-08.3(8) Waterproof Membrane for Structure Decks**

The Contractor must install the Bridge Deck Waterproof Membranes in accordance with the manufacturer's recommended products and installation documents. Primers must cure or the membrane may not stay in place during compaction. At night, a hand held spotlight will show a dull finish when the primer has cured vs shiny when wet. Cooler temperatures or higher humidity will take longer to cure. Inspect the membranes during placement for construction defects that poke holes during compaction; and while paving to ensure the paver does not drag on the membrane or other equipment does not tear the membrane with turning movements.

**SS 6-08.3(9)A Protection of Structure Attachments and Embedments**

Bridge expansion joints vary in size, materials and complexity. Contractor placement operations must not leave BST or HMA in expansion joints. The Contractor shall remove all materials dumped through the joints to the substructure. Bridge Maintenance is not funded to clean up or repair this contract work.

**SS 6-08.3(11) Paved Panel Joint Seals and HMA Sawcut and Seal**

The Contractor must mark the locations of the exact ends of sawcut for a string line before paving unless there is a gap in the bridge curb clearly indicating the location. Usually, it will be difficult to find after paving and sometimes the gap in the curb does not line up with the expansion gap. Watch for joints that have a jog or are not a straight line from curb to curb.

Standard Plan A-40.20, Detail 3 or Detail 4 shows HMA  $\frac{1}{4}$  inch higher than concrete. This should apply to all paving up against any hard materials in the surfacing, such as steel joints or headers, for the following reasons:

1. This insures compaction effort is applied to the HMA and not the hard material. Lack of compaction in the butt joint is the primary reason for raveling and early failure of HMA, which is a chronic maintenance problem. It is acceptable for HMA to be placed flush at the gutter line to avoid ponding where compaction is not critical.
2. The slightly raised grade prevents snowplows from destroying the bridge joint.
3. Within a short period of time, the tires provide additional compaction and/or rutting that will produce a smooth surface with the best performance.

**6-10 Concrete Barrier****SS 6-10.3 Construction Requirements****SS 6-10.3(2) Cast-In-Place Concrete Barrier**

On some projects, the Contractor has the option of using slipform techniques in addition to the usual fixed forms as specified in *Standard Specifications* Sections 6-02.3(6), 6-02.3(11)A, 6-02.3(24)C, 6-10.3(2), and 9-03.1(2)B.

In either method, barriers and rail bases should be carefully aligned both horizontally and vertically to give a pleasing appearance; refer to *Standard Specifications* Section 6-01.4. The vertical adjustment for the pleasing appearance is intended for localized camber and deck profile variables. This adjustment is not intended to eliminate grade breaks, such as vertical curves and superelevation transitions. The Project Engineer should plot to a large scale the profiles of the roadway grades at the curb lines. From these profiles, the grades for the tops of traffic barriers, pedestrian barriers, and rail bases can be properly determined. A slight hump in the barriers or rail base over the whole bridge is not usually objectionable.

On the safety-shape traffic barriers, some of the height variation may be accommodated in the vertical face at the base. Any height variation shall maintain the 2 foot 8 inch total height. The vertical toe face at the base is usually 3 inches unless the structure is receiving an immediate overlay. To accommodate the overlay, the vertical face at the base is increased to 3 inches plus overlay thickness. The front face geometry of the safety-

shape traffic barrier is critical and should not be varied except as noted herein. Ideally, all height adjustment required to provide a pleasing appearance should be accomplished by modifying the total height of the traffic barrier by varying the vertical toe face at the base, i.e., 2 inch minimum. The front and back faces of the traffic barrier are parallel on the upper part to accommodate all height adjustment necessary. The 7 inch height of the intermediate sloping face shall be maintained. To ensure proper alignment, carefully check the top of forms or the Contractor's control wire prior to placing concrete.

On slipformed traffic barriers and pedestrian barriers, the same cross-Section as shown for fixed-form construction shall be used, except the top chamfer may be shaped to a  $\frac{3}{4}$  inch radius. Although slipforming may be allowed in the contract, the reinforcing steel bars may not be sufficient to resist the forces during the concrete placement operations. The contractor should evaluate the stiffness of the reinforcing and, if necessary, provide additional reinforcing steel crossbracing, both longitudinally and transversely. Slipformed concrete is usually placed with a slump of  $1\frac{1}{4}$  inches plus or minus  $\frac{1}{4}$  inches. This slump is critical and should be carefully controlled by the Contractor. It is not unusual to encounter conditions which produce sections of unsatisfactory barrier or rail base due to slump, finish, alignment or other problems. When this occurs, do not hesitate to have the unsatisfactory sections removed. Occasional removal is inherent in slipform construction.

Placement of the reinforcing steel bar cage to ensure adequate concrete cover and proper reinforcing bar location is very important and difficult to check for slipformed traffic barrier, pedestrian barrier, and rail bases. When fixed forms are used, final adjustment of the reinforcing steel bar cage can be accomplished after the forms are set prior to concrete placement. The slipform method does not present this opportunity. For that reason, *Standard Specifications* Section 6-02.3(24)C requires that the Contractor check reinforcing steel bar clearances and placement prior to slipform concrete placement. This check can be accomplished by either the use of a template or by operating the slipform machine over the entire length of the barrier. The final grade control must be set prior to the check. All reinforcing steel deficiencies must be corrected by the Contractor.

### **SS 6-10.3(5) Temporary Barrier**

The condition of temporary concrete barrier shall be verified with a visual inspection by the Engineer. Any section of temporary barrier determined to be in good condition is allowed to be used on the project. Any section of temporary barrier determined not to be in good condition shall be handled as follows:

1. For temporary barrier sections being placed in a new run of temporary barrier: Any section(s) deemed not to be in good condition by the Engineer will be rejected and are not allowed to be installed in the new run of temporary barrier. The rejected barrier section(s) shall be removed from the project.
2. For temporary barrier sections that have already been placed in a run of temporary barrier: Any section(s) which are deemed not be in good condition by the Engineer shall either be repaired immediately to the Engineer's satisfaction, or the section shall be removed from the temporary barrier run and replaced with a section of temporary barrier determined to be in good condition by the Engineer. The rejected barrier section(s) shall be removed from the project.

Temporary concrete barrier sections shall be deemed to be in good condition and may be accepted when they have:

- Only minor blemishes (i.e. dirt, scuffs, traffic marks, superficial surface cracking, etc.)
- No excessive amounts of cracks (1/2 inch or deeper) or chips
- No spalls in the concrete with a depth greater than 1.5 inches
- End connection hardware that is intact, undamaged, and functional

Temporary concrete barrier sections shall be deemed not to be in good condition and rejected when they have:

- One or more cracks that penetrate through the entire section
- One or more spalls in the concrete with a depth of greater than 1.5 inches
- Exposed rebar or bolts that are protruding through the barrier surface
- Cracked or broken concrete that could be easily dislodged if struck by a vehicle
- End connection hardware that is deformed, bent, broken, corroded/rusted, or no longer functional

## 6-14 Geosynthetic Retaining Walls

### **GEN 6-14 Description**

Geosynthetic retaining walls may be Standard Plan walls or specially designed walls that are used in both permanent and temporary applications. Permanent walls usually have different material acceptance requirements than temporary walls and usually have a facing to protect the geosynthetic from damage and sunlight. In temporary applications, it is common to see a Standard Plan wall called out in the Plans. When this occurs, the wall is still a temporary wall. The Standard Plan wall was called out because the internal design of the wall has already been completed for the Standard Plans. This simplifies the submittal process and speeds up construction, as internal design is not needed.

Regardless of the wall's status as permanent or temporary, most geosynthetic walls require the Contractor to do some geometric design to lay out wall lift heights and layer elevations to meet the specific geometry needs in the Plans and achieve the proper grades and lines of the Contract.

### **SS 6-14 Geosynthetic Retaining Walls**

#### **SS 6-14.2 Approval of Material**

Geosynthetic reinforcement for permanent geosynthetic retaining walls are accepted on receipt of "Satisfactory" test reports from the State Materials Laboratory. Sampling must be completed by a tester qualified in sampling geosynthetic material.

Section 9-33.4(3) defines a "lot" and outlines the process for retesting. The Project Inspector must be familiar with the retesting procedures and understand the definition of a "lot". It is important to discuss the acceptance procedures with the Contractor well before the material is needed, as testing can take up to 30 days.

Geosynthetic materials for temporary geosynthetic walls do not need to be tested and are accepted by Manufacturers Certification of Compliance, unless specified otherwise in the Contract. The handling and storage requirements in Section 2-12.2 apply to both permanent and temporary geosynthetic retaining wall materials.

Gravel borrow for structural earth walls is used in the construction of geosynthetic retaining walls. Refer to section SS 2-03.3(13), Borrow for more information.

### **SS 6-14.3 Construction Requirements**

Type 2 Working Drawings must be followed by the Contractor with respect to geosynthetic material type, material strength, and geosynthetic reinforcement length. The Project Inspector must ensure the requirements for backfill and compaction are met. Temporary geosynthetic retaining walls have the same construction requirements as permanent retaining walls.

#### **SS 6-14 3(2) Submittals**

The Contractor is required to submit Type 2E Working Drawings complying with the requirements of the *Standard Specifications*, Standard Plans, and Contract Plans prior to Work performed on the geosynthetic retaining wall. The Project Office should verify that working drawings include all required submittal elements and have the correct plan and profile geometry prior to forwarding for further review per Figure 1-1 (Working Drawings, Shop Plans, or Submittal Type).

Geosynthetic retaining wall designs are provided in the Standard Plans and/or Contract Plans for each Contract. The designs dictate the wall geometry, material strength requirements, and geosynthetic reinforcement length. The Contractor, by way of the Type 2E Working Drawings, can determine where steps are needed to facilitate the plan profiles. The Contractor also can determine the lift thicknesses for each layer, as allowed by the wall design. The geosynthetic reinforcement lengths shown in the Contract documents are based on wall height and do not change. This is an important note when determining measurement limits.

### **SS 6-14.4 Measurement**

The Standard Plans or Contract Plans show the measurement limits for structure excavation, backfill, and compaction as the limits of the geosynthetic reinforcement. At abutment walls, measurement for the face of wall would include both the area of the wall parallel to the roadway as well as the area of wall transverse to the roadway. In that same situation backfill is only measured once.

If wall drains are called for in the Plans at the back of the reinforcement, the measurement for backfill should be extended to the back of the drains. As stated previously the reinforcement lengths are determined by the design provided in the Contract and do not change.

In a cut wall situation, it may then be necessary to compensate the Contractor for required excavation beyond the limits of the reinforcement under the Specifications for shoring or extra excavation class A or shoring or extra excavation class B, per the Contract documents. In either case, backfill for extra excavation and shoring is included in the shoring or extra excavation items. Based on Section 2-03.4 embankment compaction is also measured.



## 6-19 Shafts

### SS 6-19 Shafts

Drilled shaft foundation construction is often very technical and is always critical because the shafts are supporting the structure. Any shaft foundation malfunction will be devastating both economically and safety wise. Construction of maintenance free bridges requires close attention to details during the construction of drilled shaft foundations.

Training on shaft construction is available through the State Construction Office. The training covers specifications, equipment, site geological conditions, and general questions.

At least 5 working days before any drilled shaft foundation work begins, a conference should be held to go over the procedures and equipment to be used and to emphasize the critical areas of construction. As a minimum, this meeting should include a discussion of the contractor's shaft installation plan and order of work. In addition to this discussion, both WSDOT personnel and the Contractor's personnel should discuss specifics of the project; such as, Crosshole Sonic Log Testing (CSL Testing), site subsurface conditions, site access, traffic control, staging areas, excavation disposal, slurry storage and transfer, slurry disposal, and environmental protection.

Meeting attendees should include key personnel from WSDOT, the Prime Contractor, and the shaft drilling Contractor. The WSDOT personnel should include the Project Engineer, key inspection personnel, and representatives from the Geotechnical Division, the State Materials Laboratory, and a representative of the State Construction Office.

#### ***Nondestructive Testing of Shafts***

There are two main types of non-destructive tests that WSDOT allows for drilled shafts. Cross-hole Sonic Logging (CSL) and Thermal Integrity Profiling (TIP). Either method is acceptable. Both tests need to be performed by an experienced tester, and the findings/report require the seal of the engineer in responsible charge of the testing. Shafts poured in the dry do not require nondestructive testing, but all others do.

For Quality Assurance (QA) purposes, WSDOT has moved to contractor supplied non-destructive testing of shafts. This means that the drilled shaft contractor or a testing subcontractor will test the shafts and provide the Contractor a report. The Contractor is then responsible to forward the report to the Project Engineer (PE). The PE is responsible to review the report and if the test report does not identify anomalies, the PE may allow construction of the shaft to continue. If the test report identifies anomalies, the PE shall not allow shaft construction to continue on that shaft, may suspend further shaft construction on the project, and shall forward the test results and Inspector Daily Reports to the Construction Office. The Construction Office will provide the PE with further instructions.

WSDOT has retained the right to perform Quality Verification (QV) testing on 10 percent of the shafts that are tested by the Contractor. The purpose of the QV testing is to verify the Contractor's results. Currently, WSDOT is only performing CSL tests for verification. The PE is responsible to select shafts for QV testing and shall coordinate the testing with the Contractor and the Geotechnical Office. Ideally, WSDOT QV tests should occur on the same day as the Contractor's QA test, to minimize delays and impact to the Contractor. If the Contractor has selected TIP testing for shafts, the PE must identify the

QV shafts during cage fabrication so that CSL tubes can be installed when the cage is fabricated. Once the shaft concrete has been successfully placed, call the Geotechnical Office to schedule QV CSL testing.

Contact	Name	Phone	Email
Primary	Bob Grandorff	360-709-5468	<a href="mailto:GRANDOR@wsdot.wa.gov">GRANDOR@wsdot.wa.gov</a>
Alternate	Andrew Fiske	360-709-5456	<a href="mailto:FISKEA@wsdot.wa.gov">FISKEA@wsdot.wa.gov</a>
Alternate	Jim Cuthbertson	360-705-7825	<a href="mailto:CUTHBEJ@wsdot.wa.gov">CUTHBEJ@wsdot.wa.gov</a>
Alternate	Dale Gietz	360-709-5466	<a href="mailto:GIETZD@wsdot.wa.gov">GIETZD@wsdot.wa.gov</a>

A key aspect of the QV test is comparing the WSDOT test results to the Contractor's test results. Accordingly, the PE will need to forward the Contractor's test report to the Geotechnical Office as soon as possible. The Geotechnical Office will prepare a report for the QV test. If the WSDOT test corroborates the Contractor's test, no further action will be necessary. If the tests disagree, the Construction Office will provide the PE with instructions.

## 6-20 Buried Structures

### 6-20.1 Construction Requirements

Many of the instructions for the construction of culverts covered in Section 7-02 are equally applicable to the construction of buried structures.

Equipment should not operate across buried structures until the backfill has been constructed as required in the Installation Plan (see *Standard Specification* Section 6-02.3(2)F).

### Precast Concrete Buried Structures

#### *Fabrication*

Precast forms may not be able to produce the exact geometry shown in the Plans. *Standard Specification* Section 6-20.3(1)A2 allows for alternate designs to accommodate minor deviations. When the deviations exceed the limits specified, the alternate structure proposal must meet the Value Engineering Change Proposal (VECP) requirements in *Standard Specification* Section 1-04.4(2)A.

For Class 1 and Class 2 concrete three sided structures and concrete split box culverts, unless otherwise shown in the Plans, the Contractor is required to progressively shop assemble the top and bottom units of at least the first 3 adjacent units for inspection of fit-up for each set of forms used. The shop assembly may be considered successful if:

- Joints and units align and meet construction tolerances
- Point or edge loading does not occur within joint locations

The fit-up should be performed on a flat, solid surface such as concrete or solid ground with a layer of sand.

- WSDOT Fabrication Inspectors are typically onsite to observe the fit-up and verify tolerances are met. It is encouraged that a Contractor's representative and staff from the Project Office also attend to observe. As an alternate to being physically present, the Contractor and Project Engineer may agree to observe the fit-up via a video conference. The Project Engineer may delegate a representative to accept the fit-up.

The Fabrication Inspector should not stamp Approved for Shipment until the Project Engineer or delegate has approved the fit-up. This should all be discussed at the Pre-Construction Conference.

### **Bedding Preparation**

The quality of the bedding prepared by the Contractor has significant impact on the difficulty of installation and quality of the final project. It is best practice to install bedding for flat precast units as flat and even as possible on the proper grade.

High or low points in the bedding or soft/unsuitable materials can cause gaps or steps in the joints between units. A mud slab or leveling pad may be considered as bedding preparation for some buried structures. It could provide a flat, even, dry, and firm foundation and prevent loose material from inhibiting jointing efforts.

### **Installation**

*Standard Specification 6-20.3(2)F* requires the Contractor to submit a detailed Installation Plan. It is important that this Installation Plan address in detail the circumstances described below. Sequence of installation is important. Unit installation sequence should be such that precast units can be lowered into their final position if possible. It is best practice to avoid sliding units on bedding material, as loose or disturbed bedding material can become trapped within the joints. When sliding the units cannot be avoided, trapping material within the annular joint space could be prevented by preparing a narrow channel or trough across the front of the previously set unit to capture any loose or disturbed material as units are jointed. Alternatively, a metal plate, or other material, could be placed over the bedding material at the joint.

Precast units may need to be pulled together to achieve the required joint openings and maintain compression of the butyl rubber sealant. Once the required joint gap is achieved, jointing forces should be maintained for at least 30 seconds to ensure the butyl rubber gasket is seated and distributed evenly within the annular space of the joint. It may be necessary to brace or weigh down previously set units to inhibit movement during jointing.

Ensure precast concrete units join squarely. Also, it is best to avoid jointing one side first and then trying to join the other side, as this can cause damage to the units.

Bedding material leveling adjustments can be made after unit placement by a gentle side to side movement of the unit to encourage it to settle into the bedding.

The Contractor may make alignment adjustments by jacking from the side of the trench or trench box, ensuring the jacking load is distributed over a large area on the precast unit to avoid damage. They can also be made by gently pulling or pushing with an excavator (using a suitable buffer).

Leveling and alignment adjustments should not be done using a downward pressure on the units.

It is important to maintain geometric control and perform real time geometric checks as units are placed. This will help avoid:

- Over or under runs for the total length of the buried structure
- Misaligned vertical joints between lower and upper units for split box culverts
- Out of tolerance joint adjustments

Point loadings on precast units should be avoided. Point loadings can be caused by construction equipment, uneven joints or lack of adherence to tolerances. They can cause corner, edge or “dinner plate” spalling or shear cracks.

If the Installation Plan has not addressed some of these topics, they should be discussed at the Pre-Construction Conference so there is no misstep while the Work is being performed.

### **Structural Plate Buried Structures**

#### **Assembling**

Those inspecting the installation of metal plate structures should be familiar with the requirements of AASHTO LRFD Bridge Construction Specifications Section 26. *Standard Specifications* Section 6-20.3(8)B requires construction of metal plate structures to conform to those requirements.

All Class 2 structural plate buried structures shall meet the structure dimension tolerances for the assembly of long span structures. Structure shape shall be checked regularly during construction by the Contractor as described in *Standard Specification* Section 6-20.3(9)A. Installation deflection inspections by direct measurement shall be performed by the Contractor immediately after construction and 30 days or more after construction as described in *Standard Specifications* Section 6-20.3(9)A. These activities are critical as metal structural plate structures may not function or distribute loads properly otherwise.

Manufacturers of multi-plate structures are required to supply detailed assembly instructions with their structures, which should be closely followed.

Plates on different parts of the structure can be of different sizes and thicknesses. Ensure that the correct plates are used in the correct locations. Plates should be labeled with unit identifiers shown in the working drawings as well as the thickness or gage in accordance with *Standard Specifications* Section 6-20.3(7)B.

It is important that the bottom plates be correctly positioned for alignment and grade of their edges before the other plates of the section are bolted up so the completed structure will be in proper alignment. If the structure starts to creep or spiral, the only way to correct this condition is to remove the plates to where it is in correct alignment and reconstruct the structure.

High-strength bolts are used in bolting the plates together. In order for the connections to function as designed, the bolts must be tightened to the specified tension. Section 6-02.3(33) covers the instructions for construction and inspection of high tensile strength bolts. Impact wrenches must be calibrated as specified since overtightening may overstress the bolts and under-tightening will not give the connection the required strength. If more than one crew is assembling the structure, the impact wrenches must be calibrated to tighten the bolts to the same torque. Bolts have been observed to loosen and back out during compaction of backfill so it may be beneficial to tighten the bolts towards the higher end of the range of recommended torque.

### Submittal

For Contractor supplied designs, the Project Office shall ensure fabrication shop drawings are not submitted prior to approval of the site specific Plans, Specifications and supporting calculations. Fabrication shop drawings shall reflect any and all comments made during the review of the Plans, Specifications and calculations.

In order to help reduce the duration and number of review cycles, it is recommended that WSDOT reviewers for buried structures be available for direct meetings with fabricators to help resolve review comments. This will help address concerns raised by precasters that the duration and number of review cycles is causing hardship during construction. Recommended meeting invitees include the Project Engineer or PEO representative, ASCE, BTA, Contractor representative, and fabricator. The BTA or Bridge and Structures Office reviewer shall ensure all communication conforms to *Construction Manual* Section GEN 1-00.11(2).



### 7-01 Drains

#### **GEN 7-01.1 Roadway Subdrainage**

Underground streams and seepage zones which require installation of water collection systems may be encountered in roadway excavation. The gradation of gravel used in water interception channels is of prime importance. Gravel backfill for drains has been developed for this use. This drain material is an open graded gravel which will become plugged with fines if not protected with a filter. It should always be used with a filter cloth which has proven effective in inhibiting the infiltration of fines. The filtration ability of construction geosynthetic depends upon the Geotextile Class. The class must be determined following the guidance in the [Design Manual](#) M 22-01 Exhibit 630-1.

When installing perforated drain pipe, the perforations should be in the lower half of the pipe. This will minimize infiltration of fine material and ensure longer service.

Where a subdrain installation is intended to pick up flow from intermittent seepage zones, nonperforated pipe should be used between the seepage areas to avoid possible loss of water into otherwise dry areas. In some cases, it may be necessary to supplement the pickup system with a carrier pipe system.

It is imperative that if the Engineer requires the installation of water collection systems not already included in the plans, or a modification is made to the collection system in the plans, to update to the hydraulic report. Detailed as-builts of the added system(s) must be prepared, documented, and preserved in WSDOT's records by the Engineer so that maintenance can be performed and the systems can be identified on future projects.

The Project Engineer's attention is directed to the fact that control of water during construction is the responsibility of the Contractor. See Section 2-03.4 for temporary water pollution/erosion control.

## 7-02 Culverts

### GEN 7-02.1 General Instructions

The life of the roadway depends largely upon proper drainage, and it is essential to give diligent attention to adequacy as well as to quality of construction. In addition to providing for the passage of existing natural drainage channels through the project, a highway drainage system must provide for the collection and disposal to natural drainage channels of all rainfall on the right of way and of all ground water flow that may be intercepted during roadway construction.

It is attempted during location and planning to provide for necessary drainage systems, however, particularly with respect to underground water flow, it is impossible to foresee all drainage problems that may result from the construction of the highway. It is the responsibility of the Project Engineer to evaluate the sufficiency of the provided drainage systems and to initiate action for changes or additions where necessary.

The Project Engineer should carefully review all provisions of the applicable environmental documentation, right of way agreements, and other commitments made by the Washington State Department of Transportation (WSDOT) which have direct bearing on the project. Many of these commitments involve drainage matters. Although such elements should have been incorporated into the design, in some cases, they have been overlooked or require revision. Such a lack of oversight which directly affects adjacent property or individuals is sure to trigger an immediate negative response reflecting on WSDOT integrity.

The Project Engineer should go over the project, particularly during severe storms, closely observing the quantity and action of the storm water runoff to determine the sufficiency of openings and ditches or the need for larger openings and ditches than those contemplated, reporting the results of this observation to the Regional Office. Any changes made in the size of drainage openings must be approved by the Regional Office before the Contractor is advised of the change.

Tables showing the allowable heights of embankments over the various types of pipes are in the [Hydraulics Manual](#). Quite often, upon locating culverts to fit the drainage conditions, the height of embankment is more than was anticipated during the location work. After the culverts are staked, a check should be made to see that the allowable embankment height for the particular type of pipe is not exceeded. It is also important to check that minimum cover requirements, during all stages of a project are also satisfied.

Pipe arches shall not be constructed until the site has been investigated by the Regional Materials Engineer and the materials and methods for the construction have been approved by the Regional Materials Engineer.



### **GEN 7-02.2 Roadway Surface Drainage**

Curb and gutter systems must be constructed in such a manner that water will not pond on the roadway or flow at random over fill slopes. Manholes, catch basins, and spillways should be checked for location, size, and number to ensure efficient removal of collected water. Controlled drainage should be carried to a point beyond the roadway to where damage to the roadway cannot occur.

Water pockets are very apt to be formed in superelevation transitions and roadway width transitions, especially where the roadway grade line is quite flat. It is necessary that the Project Engineer investigate these areas to be sure that proper drainage is installed.

In placing the grates for catch basins and gutter inlets, it is imperative that they are placed at the proper elevation. If they are placed too low, they constitute a traffic hazard and if they are placed too high, they will not intercept the water. In keeping with design safety requirements, many culvert entrance structures utilize catch basins or grate inlet facilities. Such installations are particularly susceptible to deciduous debris and roadside trash. Grate opening size allowing passage of such debris is very critical in rural and mountainous locations.

Surface ditches may be necessary above cut slopes to prevent water from flowing over the cut face. Roadside ditches at the ends of cut sections should be diverted well away from the adjacent embankment to avoid erosion of the fill material.

### **GEN 7-02.3 Design of Culverts**

Present standard design practice permits the Contractor to select the type of culvert and drain pipe to be installed except in those instances where a specific type is called for in the plans. Approved types are detailed in the contract plans and specifications.

When changes or additions are determined necessary by the Project Engineer, consideration must be given to the type of pipe being furnished to the project. Specific types should be required only when engineering considerations substantiate that preference should be given to one type or another.

Corrugated metal pipe arches fill a need where headroom above the invert is restricted and where more capacity and wider clearance for discharge of debris is required than would be afforded by a multiple pipe installation. Due to the method of forming the pipe arches, it is usually more difficult to obtain a well-fitting joint. The construction of the joints must receive careful attention when the installation is in material susceptible to erosion.

### SS 7-02.3(1) Placing Culvert Pipe - General

The ability of the culvert to withstand the height of cover as shown in the tables is based on the culvert being constructed in accordance with the *Standard Specifications* and the *Standard Plans*. All phases of culvert installation should receive thorough attention and inspection to achieve that end.

#### Grade and Flow Line

Unless shown otherwise in the plans, the flow line grade of a culvert should match the stream channel which it replaces. Where the flow line grade of a culvert is relatively steep, debris and sediments tend to pass more easily through the culvert, but increased abrasion in the invert and increased erosion potential at the outlet can be expected. Where the flow line grade is relatively flat, sediment deposition within the culvert can become a problem. This is especially true with culverts that are placed on a flatter grade than the existing stream channel.

When necessary to construct an inlet channel to the culvert, the channel shall provide a smooth transition into the culvert without constricting the flow.

The destruction of vegetation, and rip rap resulting from the modification of culverts will lead to an increase in erosion around the culvert. The outlet side of the culvert is particularly susceptible to increased damage, even under normal flow. If you disturb or change either the culvert inlets or outlets during construction, consideration needs to be given to providing protection. This protection should extend upstream or downstream as needed. At the completion of the work all culvert inlets, outlets, and the channels leading to and from them shall present a neat and workmanlike appearance. At the completion of the contract, they shall be open and ready for operation.

#### Foundation

Care must be taken to ensure that the ground upon which pipes are to be laid has sufficient stability to support the pipe without excessive or nonuniform settlement. Where the underlying soil is soft or spongy, or subject to excessive consolidation under load, adequate support shall be obtained by excavating and removing the unstable soil and replacing it with satisfactory (usually granular) material, provided this procedure is feasible. In some cases, installation of the pipe should also be laid with a slight camber to overcome anticipated settlement. Where the unstable foundation soil is of such depth that the above procedure is not practical, other means must be used. This may involve the use of partial backfill of granular material to spread the load, placement of a timber or brush mat, the construction of a pile and timber cradle, or other such means. Before selecting a method, the Regional Materials Engineer should be consulted.

Uniformity of support is essential to successful installations. Where transition is made from foundation soils that may consolidate to firm, unyielding ground, special consideration should be given to the transition zone. The Regional Materials Engineer should be consulted.

## Bedding

Where pipe is laid on existing ground, care must be taken to ensure full, uniform support along the barrel of the pipe. Hand shaping and checking with a template may be necessary. When placing concrete pipe with bell-type joints, depressions must be constructed to receive the bell so that full barrel support is achieved. Isolated stones or boulders which may cause point bearing must be removed.

When granular bedding material is used (as is usually the case in trench construction or where rock soils exist), workers sometimes become careless on the assumption that the bedding material will in itself ensure adequate support. Inspection should ensure that proper depth is used and that the pipe is seated in the bedding material to provide full, uniform barrel support.

Care must be exercised in placing pipe in rock fills or where solid rock, hardpan, or cemented gravel is encountered. Pipe installed on these hard materials must be bedded on a cushion of suitable earth, fine gravel, or sand at least 6 in in depth to eliminate concentrated points of loading.

Gravel having sizes larger than 1 in should not be used for bedding material. The importance of good quality material and good installation practices cannot be overstressed. The load supporting capacity of the pipe is directly affected by the quality of the bedding.

When suitable material is not readily available on the project for bedding the pipe, Gravel Backfill for Pipe Zone Bedding should be used. Normally, this material is to be used only from 6 in below the pipe to the limits shown on the *Standard Plans*. In areas of rock embankment, where there is only fragmentary rock material available on the jobsite to backfill the pipe installation, gravel backfill for pipe zone bedding should be used for the backfill within 12 in of the sides and top of the pipe. If it is necessary to remove the material under the pipe excavation zone to produce a firm foundation, this void should be backfilled with Gravel Backfill for Foundations which is more stable than Gravel Backfill for Pipe Zone Bedding.

If the Engineer deems it desirable or necessary to construct part of the embankment prior to construction of the culvert, the embankment shall be constructed at least 5 diameters of the culvert each side of the installation and compacted to 95 percent of the maximum density of the material. The embankment shall be constructed to a minimum height above the pipe invert elevation of at least one half the diameter of the pipe, more if equipment is to be routed over the pipe installation. No tractors or other heavy equipment shall be operated over the top of the pipe until the backfill has reached a height of 2 ft above the top of the pipe. If the Contractor elects to construct the embankment to final grade, shoring will be required for embankments more than 4 ft in height above the bottom of the trench. The upper limit for measurement of structure excavation is a maximum of 4 ft above the invert of the pipe as specified in [Standard Specifications](#) Section 2-09.4.

Concrete pipe must be laid with the bell or groove end up grade. Metal pipe with riveted or resistance spot welded seams must be laid with the outside laps of circumferential joints pointing up grade and with the longitudinal laps positioned other than in the invert.

It is important that concrete pipe with elliptical reinforcement, fabricated to form an elliptical section, be installed with the "top" or "bottom" position as marked on the pipe exactly on the vertical axis. There are special cases, such as on side-hill installations, where the imposed load will be at some angle other than vertical. In these cases, the

pipe should be tilted to meet the direction of load. Theoretically, a small departure from the correct position does not greatly affect the supporting strength of the pipe, as the reinforcement cages may not be shaped to true ellipses, or they may not remain in the true shape during placing of the concrete. Practically, the steel may be in such a position that a large percentage of its effectiveness is lost a short distance away from the vertical axis. Elliptically reinforced concrete pipe is manufactured with lift holes in the top of the pipe or is clearly marked to simplify true positioning. Many culvert pipe failures have resulted because of carelessness in installation with respect to position of the vertical axis.

### Backfill

The load supporting strength of any pipe is directly affected by the condition of the material around and above the pipe as well as the bedding material under the pipe. In general, the higher the degree of compaction of the fill or backfill under the haunches and along the sides of the pipe, the less the pipe will deform under load. Also, the higher the compaction, the less the material along side the pipe will consolidate. Consolidation can result in an increased transfer of embankment load onto the pipe. For these reasons, the backfill or embankment material adjacent to the pipe should be selected material free from large rocks and lumps, containing sufficient fines so that it will compact to a relatively impervious mass and it must be compacted to a density and width not less than that required by the *Standard Specifications* or *Standard Plans*.

Care must be taken to obtain proper compaction under the haunches of the pipe and to place and compact the backfill uniformly on both sides of the culvert. Firm support must be obtained. Caution shall be used to avoid over-tamping to the extent that the pipe is lifted out of position.

Many failures of culvert pipe in the past could have been avoided by proper backfilling. No type of pipe can withstand heavy embankment loads unless the backfilling is performed in strict accordance with the *Standard Plans* for Pipe Zone Bedding and Backfill and the *Standard Specifications*.

### Placement of Fill Over Culverts

The load that will be imposed on a culvert pipe is affected largely by the manner in which the embankment around and above the culvert is constructed. The maximum height of fill allowable over various sizes and types of pipe and pipe arch culvert is dependent upon backfilling and constructing the embankment over the culvert in strict compliance with the *Standard Plans* and the *Standard Specifications*. Careful attention shall be given to constructing pipe installations in accordance with the appropriate standard except as modified by special provisions.

Equipment shall not be permitted to operate across the culvert until the embankment has been constructed 2 ft above the culvert. The operation of equipment over the culvert installation shall be in accordance with [Standard Specifications](#) Section 1-07.7.

Mitered ends of metal and thermoplastic culverts may require some type of weighted protection to keep the end of the culvert from floating due to hydrostatic pressure. Usually concrete headwalls are specified for this purpose. Concrete headwalls must be constructed as soon as the embankment is constructed to the height of the headwall so the mitered ends of the culvert will be protected when the first storm is encountered.

### **SS 7-02.5 Payment**

There is no specific payment for any bedding or backfill material placed in the pipe zone, as covered in [Standard Specifications](#) Sections 7-08.4 and 7-08.5 unless the proposal specifically includes an item for bedding materials. When bedding materials are included in the quantities, they are measured and paid by the cubic yard. If there is no item for bedding materials, all costs associated with furnishing and installing the bedding and backfill material within the pipe zone are included in the unit contract price for the pipe.

It should be noted that if the Contractor constructs pipe in excess of the length designated by the Engineer, the excess length will not be measured or paid for. It is quite often undesirable to have culvert pipe constructed in excess of the necessary length from both hydraulic and aesthetic considerations thus the Engineer should have the excess removed at the contractor's expense when this occurs.

## **7-03 Vacant**

## **7-04 Storm Sewers**

### **GEN 7-04.1 General Instructions**

Most of the instructions for the construction of culverts covered in [Section 7-02](#) are equally applicable to the construction of storm sewers.

The grade line that storm sewers are constructed on is rather critical since the capacity of the pipe is dependent on its flow line grade. The storm sewer system has been designed to carry the anticipated flow if it is constructed on the grade lines shown in the plans. It is quite important that the effect on the capacity of the pipe be checked whenever it becomes necessary to vary the flow line grade to avoid obstacles that may be encountered on construction.

Careful attention must be paid to the construction of the joints or the storm sewer line may not meet the tests that may be required in the contract.

### **SS 7-04.3 Construction Requirements**

Trenches shall be constructed as specified in *Standard Specifications* Section 7-08.3(1)A.

If the trench is 4 ft or more in depth, Shoring and Cribbing shall be constructed or the sides of the trench sloped as necessary to protect the workers in the trench. See [Standard Specifications](#) Section 2-09.3(4) and Section 2-09.1.

Backfilling will be in accordance with *Standard Specifications* Section 7-08.3(3).

### **SS 7-04.5 Payment**

There is no specific payment for any bedding or backfill material placed in the pipe zone, as covered in *Standard Specifications* Sections 7-08.4 and 7-08.5. All costs associated with furnishing and installing the bedding and backfill material within the pipe zone are included in the unit contract price for the pipe.

This page intentionally left blank.

## 8-01 Erosion Control and Water Pollution Control

### GEN 8-01.1 Introduction

Federal, State, and local water quality regulations prohibit sediment and other pollutants associated with construction activity from impacting air and water quality. The requirements in this section exist to comply with these laws and the required Permits, and to prevent impacts to water quality. However, the scope and complexity of each project will affect what each project needs to do to manage these aspects of construction.

This section is predominantly written from the Transfer of Coverage (TOC) perspective because it is WSDOT's standard practice for Design-Bid-Build (DBB) projects to transfer Construction Stormwater General Permit (CSWGP) coverage to the Contractor the day after Contract execution. The TOC process helps ensure Contractors are invested in the Temporary Erosion and Sediment Control (TESC) planning, implementation and CSWGP compliance. In some cases, it may not be appropriate to transfer Permit coverage (e.g., Contracts with long winter shutdown or with multiple overlapping phases). Procedures vary for non-transfer DBB projects and Design-Build (DB) projects in which the Contractor obtains CSWGP coverage (see TESC Manual Section 4-1.6.11 for more information). TOC is addressed in Division 8-01 of WSDOT's [Standard Specifications for Road, Bridge, and Municipal Construction](#), and additional TOC guidance is referenced in the TESC Manual and available on the [Stormwater & Water Quality webpage](#).

Once WSDOT transfers Permit coverage, the Contractor becomes responsible for all Permit requirements and WSDOT's role becomes that of compliance assurance through Contract enforcement. Inspection of erosion control work is a specialized task and it is important that the Project Engineer allocate adequate Inspector resources and provide proper training for enforcement of the Contract Work. Internal training expectations can be found in TESC Manual Section 1-1.2, and in 8-01.3.1.A of this chapter. A detailed list of inspection expectations can be found in TESC Manual Section 4-1.

It is important for the Project Office to communicate early and often with regulatory agencies and other stakeholders. Establishing open communication early, prior to construction, sets up a good working relationship that may prove invaluable later in case problems occur during construction. Permits often require notification to regulatory agencies prior to conducting construction activities. The Project Engineer should consider inviting representatives from regulatory agencies to participate in the preconstruction conference to discuss environmental concerns.

The National Pollutant Discharge Elimination System (NPDES) Construction Stormwater General Permit (CSWGP) is one of the most common permits on our Contracts. While many of the requirements in this section exist to comply with CSWGP conditions, even if a Contract does not have a CSWGP, the Contractor is required to comply.

Contracts not required to obtain Permit coverage must comply with all Federal, State, Tribal, or local laws, ordinances, and regulations that affect work in accordance with *Standard Specifications* Section 1-07.1. Washington State laws and regulations as codified in the Washington Administrative Code (WAC) and the Revised Code of Washington (RCW) provide specific requirements related to the protection of waters of the state ([Chapter 173-201A WAC](#), [Chapter 173-200](#), and [Chapter 90.48 RCW](#)).

This section of the *Construction Manual* does not replace the TESC Manual. Inspectors that are tasked with TESC inspection should reference the [TESC Manual](#) for in-depth guidance.

### GEN 8-01.2 References

- [Temporary Erosion and Sediment Control Manual](#)
- [Spill Prevention, Control, and Countermeasures Plan](#)
- [Stormwater & Water Quality webpage](#)
- Department of Ecology [Construction Stormwater General Permit](#)
- [Standard Specifications for Road, Bridge, and Municipal Construction](#)
- [RCW 90.48](#) – Water Pollution Control
- [WAC 173-200](#) – Water Quality Standards for Groundwaters of the State
- [WAC 173-201A](#) – Water Quality Standards for Surface Waters of the State
- [Standard Plans](#)

### GEN 8-01.3 Definitions

**Best Management Practice (BMP)** – means physical, structural, and/or managerial practices that, when used singularly or in combination, prevent or reduce pollutant discharges.

BMPs typically fall into three categories: design, structural, and procedural.

**Design BMP** – procedures or practices that minimize the erosion-related risk of a project, either during or after construction. Examples include projects that minimize the gradient and continuous lengths of temporary grade slopes or projects that phase work or save existing vegetation to minimize risk.

**Structural BMP** – devices that are installed in the field during construction. They may be designed to control erosion (source control) or sedimentation (treatment).

**Procedural BMP** – procedures or practices that minimize the erosion-related risk of a project, either during or after construction. For example, weekly site inspections and discharge sampling are important procedural BMPs that must be used to determine if site BMPs are functioning as needed or if they need to be maintained or enhanced.

#### Erosion and Water Pollution Control Process

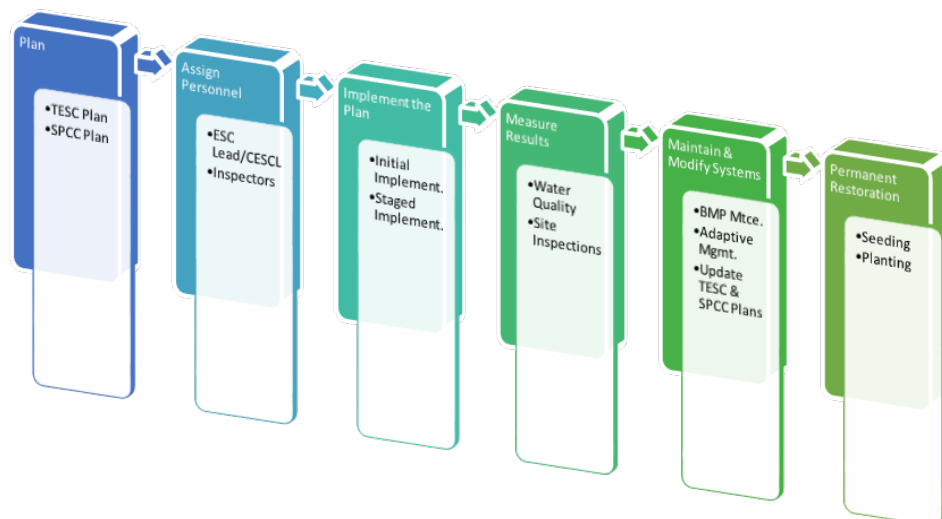



### SS 8-01.3(1)A TESC and SPCC Plans

The TESC Plan and the Spill Prevention, Control and Countermeasures (SPCC) Plan are used to manage erosion and spill-related risks during construction. Together, the TESC and SPCC plans are designed to meet the Stormwater Pollution Prevention Plan (SWPPP) requirements of the CSWGP and ensure smaller Contracts that do not trigger the CSWGP do not violate water quality standards.

A TESC Plan is required if the project will disturb certain amounts of impervious surface or soils, or if the Plan is required by Ecology or local permitting authority. Consult the TESC Chapter 2 for these details. Chapter 2 also provides required contents for the narrative and plan details.

It is especially important to include a descriptive narrative when Erosion Control and Water Pollution Prevention is paid as lump sum.

#### Projects Covered by a CSWGP

The Contractor is required to either adopt and modify the TESC Plan provided by WSDOT or develop their own TESC Plan in accordance with the TESC Manual – The Contractor's TESC plan must be submitted as a Type 2 Working Drawing for review and comment in accordance with the Contract. The TESC Plan review checklist is available on the [Stormwater & Water Quality webpage](#) and will be used by the Project Engineer when reviewing the TESC Plan.

#### Projects Not Covered by a CSWGP

WSDOT requires an abbreviated TESC plan for Contracts that disturb soil and have the potential to discharge waters of the state, but do not trigger CSWGP coverage. While Contract plan sheets are not required with an abbreviated TESC plan, they should be included if necessary to describe work to be done by the Contractor and help ensure the Contractor understands where BMP placement is needed to protect Waters of the State.

The Contractor is required to take measures to minimize discharges and prevent discharges wherever feasible. If discharges cannot be prevented, ensure they are managed to prevent impacts to Waters of the State and conduct monitoring. If evidence suggests a compliance issue (e.g. a turbidity plume, oil sheen) in the receiving water, the Contractor must initiate the Environmental Compliance Assurance Procedure (ECAP).

#### Qualified Personnel

Once the TESC Plan is ready for implementation, qualified personnel must be assigned to install, maintain, inspect, and test the system. The ESC Lead, Project Engineer, and Inspectors play crucial roles in the implementation of the plan and therefore must have the proper training and qualifications. Typically, the roles and responsibilities for erosion and sediment control are as follows:

## ESC Lead

### *Responsibilities:*

- attend the Pre-Construction Conference
- implement the TESC Plan including the installation and adaptive management of all BMPs
- maintenance of all BMPs
- develop and maintain a tracking table to show identified TESC compliance issues are fully resolved within 10 calendar days
- update the TESC Plan to reflect current field conditions
- sample and report water quality, as required
- develop and maintain the Site Log Book, as required
- perform and document site inspections of TESC BMPs
- be the primary point of contact on the Contractor's Emergency Contact List for TESC-related issues

**Training and Certification:** The ESC Lead must have a current Certificate of Training in Construction Site Erosion and Sediment Control (CESCL) from a course approved by the Department of Ecology.

## Project Engineer

### *Responsibilities:*

- overall responsibility for enforcing the Contract
- delegate authority as appropriate
- ensure site inspections are occurring
- verify non-compliance events are escalated and reported
- ensure TESC Plans are maintained to reflect current field conditions
- confirm reporting and documentation requirements are met
- understand specific site requirements, including all Permits issued by regulatory agencies

If the Contractor fails to comply with the Contract requirements the Project Engineer may impose a suspension of work in accordance with *Standard Specifications* Section 1-08.6. The Project Engineer should also use the Prime Contractor Performance Report to encourage good behavior and reward excellent environmental compliance.

## Project Inspectors

### *Responsibilities:*

- ensure BMPs are installed correctly
- verify DMR reporting is occurring monthly as required, and perform discharge compliance verification sampling if accuracy of data is in question
- verify the TESC Plan is reflective of current site conditions
- verify BMP maintenance and adaptive management
- communicate and work with the ESC Lead regarding deficiencies, or other matters as necessary
- escalate known deficiencies within Project Office structure

Training and Certification: The WSDOT Construction Site Erosion and Sediment Control Class offered through HQ Erosion Control Program is required every three years for Inspectors involved with the design, implementation, or verification inspection of TESC BMPs.

### Implementation of the Plans

The Contractor must meet AKART (All Known, Available, and Reasonable methods of Prevention, Control and Treatment) as defined in [WAC 173-218-030](#) prior to discharging from the construction site. To meet the AKART requirement the ESC Lead must select, install, maintain, and adaptively manage BMPs as required to ensure continued functional performance throughout construction. The ESC Lead documents this work in the TESC Plan.

Inspecting BMP installation is necessary to ensure proper methods and materials are used. Improperly installed BMPs will not be effective and can contribute to an erosion or non-compliance event. Some temporary products have materials requirements outlined in *Standard Specifications* Section 9-14.

If a Contractor wants to exceed the maximum acreage exposure limits allowed by *Standard Specifications* Section 8-01, they must request approval from the Project Engineer.

If the Project Engineer grants the Contractor's request to exceed these limits, the Contractor must provide to the Project Engineer revised TESC and SPCC plans, commensurate with the scope and risk of the variance proposed, stating what measures will be used to protect the project site from erosion damage, how water quality and sensitive areas will be protected, and include the schedule of methods employed to regain adherence to *Standard Specifications* Section 8-01. The CSWGP prohibits the Project Engineer from increasing the time periods required in *Standard Specifications* Section 8-01 for covering erodible soil that is not being worked.

### Adaptive Management and Feedback/Maintenance

The ESC Lead and Inspectors must inspect the area surrounding the installed BMPs to ensure they are installed and functioning properly, looking for signs of erosion, turbid water, or sheen. When BMP adaptive management is necessary, the ESC Lead must update a tracking table to show that identified TESC compliance issues are fully resolved within 10 calendar days after the issue was identified. The on-site TESC plan and SPCC plan must be updated with any changes including changes to BMP types and locations and changes to discharge points. These changes can be made by hand or electronically, as long as it can be accessed on-site. In all cases, the ESC Lead must document what adaptive management was done and include a completion date. If effective adaptive management is not feasible within 10 calendar days, Department of Ecology may approve additional time if the ESC Lead requests an extension within the initial 10 day timeframe.

As construction progresses, modifications of BMPs and the TESC Plan are necessary and required by the CSWGP to address changing site conditions. There are three common triggers to indicate when ESC Leads need to make these changes:

1. Visual monitoring or site inspection findings indicate BMPs are not performing as required. Under no circumstances should concentrated flow be allowed to develop. This type of flow can cause significant damage to the site as well as water pollution.
2. A change in work activity, site conditions, schedule, or design that impact erosion related risk(s).
3. A discharge sample over 25 NTU

### SS 8-01.3(1)C Water Management

Several different permits can require water quality monitoring whether work is being done in the water or on land. Sampling frequency and location, compliance triggers, planning and reporting requirements vary depending on the type of Permit or certification issued.

For projects with a CSWGP:

The two most common measurements for pollutants are turbidity and pH:

1. Turbidity measures the clarity of water in nephelometric turbidity units (NTUs), most commonly using a turbidometer. The CSWGP establishes monitoring benchmarks between 25 to 250 NTU.
2. Water impacted by pH modifying sources must be characterized and, if authorized, must be neutralized prior to discharge to ensure it is within the range 6.5 to 8.5.

Projects that involve in-water work may be issued a Hydraulic Project Approval (HPA), a Letter of Verification (LOV), or a 401 Individual Water Quality Certification. Compliance for in-water work is evaluated differently than work covered by a CSWGP. In-water sampling (e.g., upstream and downstream) is different than discharge sampling for a CSWGP.

The Permittee is required by law to report any water quality exceedance or Permit violation to the Department of Ecology. WSDOT has developed an internal ECAP, outlined in [SS 1-07.5](#) of the *Construction Manual* that must be implemented immediately by the individual discovering the potential non-compliance event.

### Documentation/Compliance/Reporting

Monthly reporting requirements begin as soon as the CSWGP is issued by Department of Ecology, even if construction has not yet started or a discharge has not occurred. Project Office staff are required to submit monthly Discharge Monitoring Reports (DMRs) until the CSWGP is transferred to the Contractor.

When WSDOT remains the Permittee, the Project Office is responsible for all Permit requirements including discharge sampling and the monthly DMR submittal to Department of Ecology's WebDMR system. The Contractor will identify an ESC Lead to perform the Permit required site inspections.

Once ground disturbing construction begins, weekly site inspections and discharge sampling become required. Site inspections are required at a minimum weekly and within 24 hours of a runoff event.

Inspection and discharge sampling of temporarily stabilized, inactive sites may be reduced to once every calendar month with Project Engineer approval. The Project Engineer should consider the risks associated with less frequent inspections before approving reduction of inspections, including BMP failures, erosion potential, and seasonal factors.

Discharge monitoring must occur weekly and be scheduled around the weather, using a calibrated turbidometer (refer to [TESC 4-1.3](#) for more details). Testing equipment must be onsite at all times, and must be calibrated per the manufacturer instructions. An updated calibration log must be maintained and stored with the equipment. The Inspector needs to be aware of benchmarks and when they are exceeded. The Contractor is required to document, adaptively manage, and report (if necessary) when this happens.

### Documentation

The Site Log Book information may be kept electronically by the Permittee, but must be accessible on-site and must contain the following:

- Permit coverage issuance letter or completed Transfer of Coverage (TOC) form
- Updated TESC plan, SPCC plan, other related plans (e.g., chemical treatment plan)
- Discharge sampling data
- Site inspection reports
- Documentation of BMP adaptive management
- Contact information for onsite ESC Lead who performs site inspections
- Other Permit related documents or approvals (e.g., sanitary sewer Permit, Administrative Order, approval for use of chemical treatment)

The Inspector should be checking the Site Log Book periodically to ensure it is kept up to date.

### Environmental Compliance Assurance Procedure (ECAP) & Environmental Report Tracking System (ERTS)

Transparency with regulatory agencies when non-compliance occurs builds trust and sends a message that good faith efforts are made.

ESC Leads or other on site personnel must notify the Project Engineer immediately upon discovery of a water quality standard exceedance or other situation that may lead to a violation of the CSWGP by initiating ECAP. All effort will be made to cease the exceedance or rectify the non-compliance event before any work in or around the area resumes.

The ECAP is an internal procedure designed to escalate potential non-compliance issues. This may need to include notification of regulatory agencies, organization of cleanup activities, or further enforcement of the Contract up to or including suspension of part or all of the Work causing the non-compliance. WSDOT staff who observe a potential non-compliance event must submit specific information to their supervisor after the initial notification has been made. Refer to the procedure contained in [SS 1-07.5](#) for more information on ECAP.

Initiating ECAP ensures that the non-compliance events are identified and fully addressed including preventing it from recurring. The Project Engineer and Regional Environmental Manager (REM) will work together on an appropriate response to the notification trigger. Minor non-compliance events that do not pose a threat to human health or the environment may be addressed and reconciled at the project level.

When the Permit has been transferred and the ECAP process is triggered, the Contractor shall fill out the ECAP Form (WSDOT form #422-011) and provide it to the Project Engineer within 48 hours of the non-compliance event.

In contrast to ECAP, Environmental Report Tracking System (ERTS) is a reporting system required by the CSWGP. While it is meant to escalate significant or severe non-compliance events similar to ECAP, ERTS is the notification system of the Department of Ecology. ERTS reports must be completed by the Permittee within 24 hours of a discharge of 250 NTUs or more or if non-compliance with WQS is confirmed. Department of Ecology must also be notified of events that pose a threat to human health or the environment. ECAP is initiated prior to submission of a report in ERTS. An ECAP report will usually have the same information required by ERTS.

### **SS 8-01.3G Completion/Close-out/Restoration**

The CSWGP makes an important distinction between temporary and final stabilization. Termination of the Permit cannot occur until the project has reached final stabilization and the Contract work is physically complete. For final stabilization, all temporary BMPs must be removed unless approved by the Project Engineer to remain, and all exposed soil areas must be fully stabilized with permanent BMPs such as vegetation, rock, or equivalent permanent stabilization measures. Care must be taken to minimize soil disturbance upon removing temporary BMPs. Non-biodegradable BMPs must also be removed and soil must be permanently stabilize prior to submitting the Notice of Termination form. All Permit requirements must be performed until the CSWGP has been terminated.

Some projects may choose to leave sediment control BMPs such as silt fence in place until permanent vegetation has established, even if the duration extends beyond Contract completion. However, if the silt fence is left in place, the Permit cannot be terminated and all of the CSWGP requirements still apply, including the monthly reporting requirements. The Project Engineer may elect to coordinate with WSDOT Maintenance forces to arrange for silt fence or other BMP removal occurring after the Contract is completed.

Once Physical Completion has been granted the Contractor is required to submit a Notice of Termination (NOT) to the Project Engineer for review prior to submitting to Department of Ecology. Project Office staff must walk the site to ensure the NOT requirements have been met prior to NOT submittal. Once the Project Engineer confirms the requirements have been met, the Contractor must submit the NOT to Department of Ecology. If requirements have not been met, the NOT cannot be submitted to Department of Ecology. Prematurely submitting the NOT is a Permit violation. If the site has not achieved final stabilization, yet all other Contract work is complete, and the project is “waiting for grass to grow”, the Contractor may request to transfer the CSWGP back to WSDOT. If the CSWGP is transferred back to WSDOT (at the Project Engineers discretion), the Project Office becomes fully responsible for CSWGP compliance including site inspections, discharge sampling, and reporting until the CSWGP is terminated. To terminate the CSWGP after it is transferred back to WSDOT, the Project Office must submit the NOT to Department of Ecology.

Once a NOT is submitted, Department of Ecology may request a site visit or notify the Permittee that the termination request is denied. If no contact is made by Department of Ecology, the Permit is considered terminated the 31st calendar day after the date Department of Ecology received the NOT form.

Once the CSWGP is terminated, it should be “inactive” in Department of Ecology’s PARIS database. The Project Engineer should check the status of the Permit in PARIS to make sure it is “inactive”. If the Permit status is active in PARIS, monthly DMR requirements will continue to generate in WebDMR and the Permittee (WSDOT or the Contractor) may

need to follow-up with the Department of Ecology Permit administrator to ensure the terminated Permits have been inactivated in PARIS.

### **SS 8-01.3(2)B Temporary Seeding**

Temporary seeding is the establishment of a temporary vegetative cover on disturbed areas by seeding with an annual herbaceous plant (i.e. cover crop such as sterile wheat) which is quick to germinate than other species used for permanent establishment. Temporary seeding can stabilize disturbed areas that will be inactive for an extended period.

### **SS 8-01.3(2)D Temporary Mulching**

Temporary mulching is a method of soil cover for temporary erosion prevention and control. It is also used to improve the soil environment for establishing vegetation. Organic mulches such as straw, wood fiber, chips, compost and bark are most effective for these purposes.

Both organic and synthetic tackifiers can be added to bind the mulch, seed, and fertilizer to the disturbed soil surface until vegetation is established. These tackifiers can reduce the displacement of soil particles, seeds, and mulch caused by wind or rainfall.

### **SS 8-01.3(3) Biodegradable Erosion Control Blanket**

In order to control the possible erosion resulting from fast runoff on steep slopes, biodegradable erosion control blankets are often used. Blankets also get used on flatter slopes where erodible soils are encountered. Using biodegradable erosion control blankets can provide a quick temporary protection until the grass has grown enough to be permanent protection for the soil, but the blanket cannot be expected to hold up to concentrated flows, so top of slope protections should be made to prevent such flows from developing and hitting the slope. Ditching, drains or dispersion BMPs such as compost socks should control drainage from above or beyond the raw slope. Every effort should be made to ensure that this kind of runoff is diverted away from the slope. In some cases, as determined by geotechnical analysis, permanent erosion control blankets or turf reinforcement mats (non-biodegradable) may be needed to stabilize a slope.

## **Emergency Projects**

Department of Ecology uses the Federal expectations as outlined in the EPA's Construction General Permit for emergency-related projects. Emergency projects require immediate authorization to avoid imminent endangerment to human health or the environment, public safety, or to reestablish public services. Such projects are authorized to discharge immediately on the condition that a complete and accurate NOI is submitted within 30 calendar days after commencing earth-disturbing activities. Department of Ecology's Regional Permit Administrators should be contacted as soon as possible as their project specific expectations may vary. WSDOT's emergency projects should operate as if covered under a CSWGP, including collecting discharge samples as soon as earth-disturbing work begins (document sample data onsite until a Permit is issued and data can be reported in WebDMR). While no TESC plan is required for emergency projects, these projects shall use the other site log book documentation requirements (e.g. record of implementation of Permit requirements such as the site inspections and adaptive management of BMPs) to meet the pollution prevention intent of a TESC plan.

## 8-02 Roadside Restoration

### GEN 8-02.1 General

The *Roadside Policy Manual* sets forth the following policy: *The Washington State Department of Transportation (WSDOT) recognizes roadsides as an asset. WSDOT manages roadsides, balancing operational and environmental functions and lowest life cycle costs consistent with a reliable, safe, and sustainable transportation system. Roadsides are an important component of highway planning, design, operation, and maintenance because of the operational and environmental benefits the roadside provides. In reality, these functional benefits are interrelated and inseparable, and they affect the appearance of the roadside. Properly designed and maintained vegetation complements the functions of the roadway, integrates the roadway into the surrounding landscape, and has a positive effect on the traveling public. Roadside restoration is the process of replacing or rehabilitating functions lost through construction or other roadside disturbances.*

According to [RCW 47.40.010](#), the “planting and cultivating of any shrubs, trees, hedges or other domestic or native ornamental growth, the improvement of roadside facilities and view points, and the correction of unsightly conditions, upon the right-of-way of any state highway is hereby declared to be a proper state highway purpose.”

Proper implementation of this section is key in insuring the roadside features and functions are properly restored and continue to fulfill their intended purpose after the project is completed. It is understood that roadside restoration is often one of the last activities and it is for that reason that it is so important that inspections are timely and thorough.

This section is written to provide a unified source of information for project personnel engaged in construction phase roadside restoration activities. When questions of adequacy of roadside restoration materials and procedures are encountered, or when differences of opinion concerning the acceptance or rejection of materials occur and the answers are not readily found in this section, the Region Landscape Architect or HQ Landscape Architect should be consulted for assistance. In cases where insect damage and diseases are suspected, the services of an entomologist or plant pathologist may be required.

Ongoing coordination is needed between the Project Engineer, Inspectors, and Landscape Architects to assist in the successful completion of the project and a successful hand-off to Maintenance at the end of plant establishment.

### GEN 8-02.2 Landscape Terminology

**Acid Soil/Alkaline Soil** – The acidity or alkalinity of a soil is measured in terms of its pH. Various plants respond differently to pH variations. Generally, the soil west of the Cascades is acidic, while east of the Cascades is more basic. The pH scale ranges from 0 to 14. A pH measurement of 7 indicates a neutral soil; a pH measurement below 7 indicates an acidic soil; and a pH measurement above 7 indicates an alkaline soil or basic soil. Generally, plants are selected for a particular area based on their ability to survive without a need to change the pH of the soil.

**Balled and Burlapped (B&B)** – Plants are prepared for transplanting by digging them so that the soil immediately around the larger, central roots remains undisturbed. The ball of earth and root is then bound in burlap or similar mesh fabrics. An acceptable B&B



root ball should contain 90 percent (visual estimate of volume) of the earth material held together with root system when removed from the burlap. The soil must remain moist, but not fully saturated, before planting.

**Bare Root (BR)** – Most deciduous plants are dug when dormant. The roots are cleaned, pruned, and usually stored in moist material. Roots must remain moist and not allowed to dry out.

**Botanical Name** – The botanical, or scientific name is the plant name, written in Latin, which is used universally. The common name is the name used in a local area, and is not necessarily the same name used in other areas. The correct botanical name is usually found in “Standardized Plant Names” and is available from the Landscape Architect. The botanical name usually consists of two names, Genus and Species, but may include additional names.

Genus: 1st word  
Species: 2nd word  
Variety: 3rd word (if appropriate)  
Example: Sambucus racemosa melanocarpa  
Genus: Sambucus  
Species: Racemosa  
Variety: Melanocarpa

**Branch** – An offshoot from a trunk or main stem. It could be also called a bough or a portion of a main stem.

**Bud** – A small protuberance on a stem, branch, or cutting containing an undeveloped shoot, leaves or flowers.

**Caliper** – The diameter of the trunk of a deciduous tree is measured 6 inch above ground level, up to 4 inch caliper size. If greater caliper than 4 inch, it is measured at 4.5 feet above ground level. The measurement at 4.5 feet is commonly referred to as diameter at breast height (dbh).

**Cambium** – A thin layer of generative tissue lying between the bark and the wood of a stem, most active in woody plants. The cambium produces new layers of phloem on the outside and of xylem (wood) on the inside, thus increasing the diameter of the stem. Healthy cambium is green in color.

**Cane** – A primary stem which starts from the ground of a shrub or at a point not higher than  $\frac{1}{4}$  the height of the plant. A cane generally only refers to growth on particular plant material, such as roses, etc.

**Clumps** – Plants with at least double the number of canes required for standard material; trees with three or more main stems starting from the ground. Vine maples are sometimes sold by the clump.

**Collected Material** – Trees, shrubs, or other plant material collected from native stands, including Christmas tree stock and plants from native stands or forest plantings. After one growing season at the nursery, they are no longer considered collected material.

**Compost** – Stable, mature, decomposed organic solid waste that is the result of the accelerated aerobic biodegradation and stabilization under controlled conditions. The result has a uniform, dark, soil like appearance that smells like rich earth. Any ammonia smell indicates the compost is immature and a Solvita test should be run on the material.

**Container Grown** – Plants grown and delivered to the job site in plastic pots or other containers. Container grown plant should not be allowed to dry out while in the container. Usually, plants grown in containers are in a very free draining soil mixture made up of nutrient free components. Container grown plants have a tendency to dry out and decline in vigor when not under the care of the nursery.



Container grown material should have a firm root ball which will hold 90 percent (visual estimate of volume) of the ball material when removed from the container. Good container grown materials will hold virtually all of the soil in the root zone when a good growing medium is used. Some root growth should be visible in the outer edges of the ball. Excessive roots at the bottom of the ball indicate lack of proper root pruning. Excessive roots at the side or bottom of the container could indicate a root bound condition.

**Cuttings** – Cuttings are detached leaf buds or portions of branches which under favorable circumstances are capable of producing roots when placed in a growing medium. Common species used as cuttings are willow, cottonwood, and red osier dogwood.

**DBH** – Diameter at breast height. This is a standard measurement of a standing tree trunk and is measured at a height of 4.5 feet.

**Fertilizer** – Any natural or artificial material added to the soil or directly to the leaves to supply one or more plant nutrients. Generally, a complete fertilizer refers to a fertilizer that contains nitrogen, phosphorous, and potassium (NPK). Occasionally, sulfur (S) is used, especially in alkaline soils to lower the pH. Indications on a container are usually numerical 10-8-6 or 20-10-5, etc. These numbers indicate the percentage of actual nutrient element available, i.e., 10 percent nitrogen, 8 percent phosphorous, and 6 percent potassium (10-8-6). Other minor nutrients are sometimes added to NPK such as magnesium, manganese, boron, iron, zinc, calcium, etc.

Applying the wrong type of fertilizer can harm or kill plants. Consult with the Regional Landscape Architect or HQ Design Landscape Architect before applying fertilizers not specified in contract. In addition, approval by the State Construction Office may be required and approval by the Project Engineer and Regional Construction/Operations Engineer's Office is required (see the Change Order Check list).

**Heeling In** – A method of temporarily storing plants by covering roots with moist sawdust, mulch, soil, or a mixture of other materials capable of good moisture retention, to keep the roots from drying out.

**Herbicide** – A herbicide is a pesticide chemically formulated to control or destroy weeds. Herbicides are broken down into two main groups: Postemergence Herbicide and Preemergence Herbicide. Postemergence herbicide is a plant killing material that acts on the active growing surface of a plant after the plant has emerged from the soil. It is usually most effective during the rapid growth of the plant. Preemergence herbicide is a plant killing herbicide which acts to prevent the seeds, bulbs, tubers, stolons, etc., from sprouting (before-emergence).

**Inoculated Seed** – Seeds of the legume family that have been treated with nitrogen-fixing bacteria to enable them to make use of nitrogen from the soil atmosphere.

**Mulch** – Mulch is any loose material placed over soil, usually to retain moisture, reduce or prevent weed growth, insulate soil, or improve the general appearance of the plant bed. Additional fertilizer is sometimes necessary in order to offset the loss of plant nutrients used by the microorganisms that break down the mulch, especially when using non-native stock.

**Mycorrhiza** – A beneficial group of fibrous fungi that attach to the roots and absorb water and nutrients in solution and transfer this solution to the roots of plants. In effect, they multiply the plants' root systems many times. These can be seen as fine white netting on moist compost or bark mulch. This is a good thing and not something to be concerned about.

**Node** – A small protuberance on a stem, branch or cutting containing an undeveloped shoot, leaves or flowers.

**Pesticide** – A pesticide is any substance or mixture of substances intended to control insects, rodents, fungi, weeds, or other forms of plants or animal life that are considered to be pests.

**Root Ball** – Ball of earth encompassing the roots of a plant. Generally, the root ball will have a good portion made up of root networks. A “manufactured-root ball” is one where the root system is not adequate to hold the soil in place. Manufactured root balls should not be accepted, since the root system is not developed sufficiently.

**Rootbound (Pot Bound)** – The condition of a potted or container plant whose roots have become densely matted and most often encircle the outer edges of the container. Generally, this condition is a result of holding the plant in the container for too long a period. Root bound plants should be rejected. See *Standard Specifications* Section 9-14.6(2). Circling roots will eventually kill the plant.



**Root Collar (Plant Crown)** – Root Collar is the line of junction between the root of the plant and its stem, also known as the plant crown. The plant needs to be planted so the root collar is at or within an inch above the soil surface.

**Runner** – A long, slender, trailing stem that puts out roots along the ground. Where the nodes make contact with the ground, a new plant is produced. (For example: Kinnikinnick or wild strawberry.)

**Soil Bioengineering** – Soil bioengineering combines the use of live plants or cuttings, dead plant material, and inert structural members to produce living, functioning land stabilization systems.

**Soil Amendment** – A mixture of a growing medium, such as compost with the native top soil.

**Vigorous** – Plants that demonstrate vigorous growth have bright green cambium, strong stems and healthy leaves with no indication of stress (discoloration of leaves, insect damage, or wilt). Plants growing in a vigorous condition also have a well formed and healthy full crown with plump, firm and moist roots that have light growing tips during the growing season. A vigorous stand of grass has a lush, rich-green appearance with no dead patches or major gaps of growth within the established area. A stand of grass that displays rusting, wilting, stunted growth, diseased grass, or browning and yellowing of leaves is not considered vigorous.

**Watering-in** – Watering-in is a process used to settle the soil with water by eliminating air pockets during the planting process. This is also known as “puddling”.

**WSNLA** – Washington State Nursery and Landscape Association.

### **GEN 8-02.3 Reference Reading**

Roadside restoration designs are in accordance with direction provided in the current version of WSDOT [Roadside Policy Manual](#) (RPM). Designers use guidance provided in the WSDOT [Roadside Manual](#) (RM), where appropriate, when implementing the provisions of the RPM. The RM addresses design issues such as law and policy, soil bioengineering, contour grading, vegetation, irrigation, etc. Another resource is the *Inspection Guide for Landscape Planting* published by AASHTO.

### **SS 8-02.2 Materials**

Materials for roadside restoration include many items besides plant material, such as compost, topsoil, bark or wood chip mulch, soil amendment, pesticides, fertilizer, seed, hydromulch, staking and tying material, irrigation/electrical material (pipe, pumps, sprinklers, backflow control devices, valves, etc.). Drainage and surfacing materials are covered in their respective sections of the manual.

### **SS 8-02.3 Construction Requirements**

#### **SS 8-02.3(2) Work Plans**

##### **SS 8-02.3(2)A Roadside Work Plan**

The Roadside Work Plan is a Type 2 Working Drawing that is required for all projects that disturb the roadside beyond 20 feet from the pavement or where trees or native vegetation will be removed. The Roadside Work Plan is intended to ensure that all impacts to the roadside vegetation and soils are minimized, preparatory activities are planned and coordinated with planting, and planting is coordinated with the removal of erosion control items.

The Roadside Work Plan is required to be submitted prior to performing work that disturbs the earth. Project Engineers should forward questions on Roadside Work Plans to the Region Landscape Architect or the HQ Design Landscape Architect.

The Contractor’s progress schedule should show the order in which the Contractor proposes to perform the roadside restoration work and it is expected that the Progress Schedule will be reviewed in conjunction with the Roadside Restoration Plan.

The Roadside Work plan must indicate the proposed timing to perform the work and must include the following activities:

#### **Limiting Impacts to Roadsides**

The Plan should show the limits of Work including locations of staging or parking. In the case of staging and parking areas, these areas could become compacted and the Plan may need to address protection and/or decompaction. The Plan should also indicate areas outside the clearing limits where vegetation must be removed for access or other reasons such as stockpiling of topsoil. Preservation and stockpile of topsoil or other native materials is expected for areas outside the clearing limits.

#### **Roadside Restoration**

The Plan must include a discussion of how and when the propagation and procurement of plants will occur. Contracts with large quantities of plants should show these activities in the Progress schedule. Delays have occurred due to unavailability of plants in the past.

Means and methods to limit soil compaction where seeding and planting are to occur, such as steel plates, hog fuel access roads, wood mats for sensitive areas (including removal) and decompaction for unavoidable impacts.

The Plan should indicate when erosion control items will be incorporated or removed.

#### **Lawn Installation**

The Plan should indicate the schedule for lawn installation work. It must also discuss the establishment and maintenance regimen for lawns.

### **SS 8-02.3(2)B Weed and Pest Control Plan**

This plan is required when the proposal contains the item “Weed and Pest Control,” and prior to application of any chemicals or weed control activities, the Contractor shall submit a Type 2 Working Drawing. The Weed and Pest Control Plan is intended to ensure that only approved pesticides are applied by licensed applicators. Only those pesticides listed in the table Herbicides Approved for Use on WSDOT Rights of Way and approved as part of the Weed and Pest Control Plan may be used. Refer to the website for the list of approved herbicides: [Herbicides Approved for Use on WSDOT Rights of Way](#). The Contractor may request written authorization from the Engineer to use herbicides that are not on the list. In that case it is recommended that the Project Engineer consult with the Region or HQ Landscape Architect prior to approving the request. The Plan also requires SDS sheets are submitted in order to fulfill hazard communication. The Plan must include provisions to ensure worker safety until re-entry time periods have elapsed.

The Project Engineer should review the Working Drawing for completeness and consult with the Region or HQ Landscape Architect, as necessary.

### **SS 8-02.3(2)C Plant Establishment Plan**

This Type 2 Working Drawing is required when the proposal contains the item “PSIPE\_\_”, and must be completed prior to Initial Planting. The Plant Establishment Plan shall describe activities necessary to ensure continued health and vigor of planted and seeded areas in accordance with the requirements of Sections [8-02.3\(12\)](#) and [8-02.3\(13\)](#). Should the plan become unworkable at any time during the first-year plant establishment, the

Contractor shall submit a revised plan prior to proceeding with further Work. The Plant Establishment Plan shall include:

1. Proposed scheduling of joint inspection meetings, activities, materials, equipment to be utilized for the first-year plant establishment. [Section 8-02.3\(13\)](#) requires the Contractor to meet monthly or at an agreed upon schedule with the Engineer for joint inspections. This plan should state when those inspections will occur.
2. Proposed adaptive management activities to ensure successful establishment of seeded, sodded, and planted areas. The plan should address when watering and fertilizer will be applied.
3. A contact person. This should be the person responsible for all plant establishment activities, including regular inspections and plant replacement.
4. Management of the irrigation system, when applicable. The plan should include provisions for regular inspection and winterization.

### **SS 8-02.3(3) Weed and Pest Control**

Weed and Pest Control occurs in strategic areas and includes various methods. Product use, type and timing of application could affect target species control success. Improper weed and pest control application could damage desirable species to remain and cause inadvertent harm to people and the environment. The person applying the pesticides must be a licensed applicator and perform work according to Weed and Pest Control Plan. The licensed applicator is responsible to only apply according to the label to ensure the proper material is used on the specific target, and with an appropriate timing of application. The pesticide label will give instructions such as intended use of the product, directions for use, and warnings. Ensure all chemical pesticides are delivered to the job site in the original containers or if pre-mixed off-site, obtain certification of the components and formulation from the supplier. The licensed applicator or operator shall complete WSDOT Form 540-509, Commercial Pesticide Application Record, each day the pesticide is applied and furnish a copy to the Project Engineer by the following business day. The Project Engineer is to distribute a copy of this record daily to the Region Operations or Maintenance Engineer and to the Roadside Maintenance Section at the HQ Maintenance and Operations Office in Olympia. Only herbicides listed at the [Roadside Vegetation Management](#) website shall be used.

Damage to adjacent areas, either on or off the Highway Right of Way, shall be repaired to the satisfaction of the Project Engineer or the property owner at no cost to the Contracting Agency.

### **SS 8-02.3(4) Topsoil**

With increased focus on stormwater in Washington and new understanding of the role of soils in the mitigation of water quality and quantity, engineered soil and soil amendments have become an important stormwater Best Management Practice (BMP). Topsoil is a biologically active system of minerals, organic matter, air, water, and microorganisms that can take thousands of years to develop. Topsoil nourishes and provides structural support for plant roots and absorbs and cleans water. Most of our roadside projects strip away the desirable existing topsoil leaving behind a compacted layer unsuitable for plant growth. This requires the landscape architect to either amend existing soils or add suitable topsoil back on site.

Be aware that not all topsoils are created equal. [SS 8-02.3\(4\)](#) describes the main differences between Topsoil Type A, B and C.

Imported topsoil (Topsoil Type A) can be used to provide a medium for plant growth when native soil has been removed or is highly disturbed.

Remove, stockpile, and replace existing topsoil when appropriate. Existing topsoil can have necessary nutrients, organic matter, and microorganisms. The use of existing topsoil onsite (Topsoil Type B) can reduce the costs of disposing of excess excavated material. An examination of the site with an inventory of existing vegetation is necessary prior to determining when to use existing topsoil. Stockpiling of topsoil might not be advisable when noxious weeds and their seeds are present. Consult the Landscape Architect for assistance. Topsoil Type C is also existing naturally occurring native topsoil meeting the requirements of Topsoil Type B but obtained from a source provided by the Contractor outside of the Contracting Agency owned right of way. The Engineer needs to approve the material prior to removing from the proposed source.

Ensure the project obtains the specified material to ensure not only healthy and viable plants, but to ensure topsoil quality and type that meets what the project bid and paid for. Certain topsoil can exceed heavy metals, chemicals or other soil properties detrimental to plant growth and sometimes harmful to humans and the environment. In this case, designers may require soil testing (to determine acceptable soils on our right of way) in addition to meeting the material standard requirements.

When provided in the Contract, topsoil should be evenly placed on the slopes at the specified depth for areas to be seeded. After placement of top soil, large clods, hard lumps, rocks 2 inches in diameter or larger, and litter shall be raked up, removed, and disposed of by the Contractor. Refer to *Standard Specifications* Section 8-02.3(4) for more information.

### **SS 8-02.3(5) Roadside Seeding, Lawn and Planting Area Preparation**

Complete preparation steps prior to installation of plant materials according to the requirements of the Contract Plans and Specifications:

- Weeds are controlled throughout the entire planting and seeding areas, as called for by the Contract Specifications. Inspect weed root systems to ensure complete weed eradication. The interior color of dead or dying roots is usually tan or brown, whereas healthy roots are usually white. If the weed's root systems are still alive, delay planting until they can be killed. Perennial weeds with extensive root systems such as Canada thistle, Japanese and Bohemian knotweed, horsetail, wild pea, field bindweed, and quack grass (see [Common Weeds of the United States](#) – United States Department of Agriculture) should only be controlled with herbicides by a licensed applicator, to avoid the spread of live plant parts that might produce further weed patches with manual removal.
- Areas to be seeded are to be prepared after final grading so that the soil surface is rough and loose, with ridges and furrows (narrow depressions) perpendicular to the slope or to the natural flow of water. This will slow the water velocity, increase water detention and infiltration, decrease runoff, and promote grass growth. This can be done through catwalking, the use of a cleated roller, crawler tractor, or similar equipment. Refer to *Standard Specifications* Section 8-01.3(2)A for more information.

- Seed and fertilizer are to be uniformly applied on the slopes at the rate and mixture specified in the Contract. Application shall be by hydro-seeder, blowing equipment, properly equipped helicopters, or power drawn drills or seeders. Where areas are inaccessible for this equipment, or when specified, approved hand seeding will be permitted.
- The Project Engineer should measure using the appropriate means to verify the acreage or square foot for seeding, fertilizing and mulching.
- During the seeding and fertilizing operation, the Inspector must verify that the material is placed at a uniform rate and compare the amount of seed and fertilizer applied, by counting the number of bags of material, with the area covered to verify that the proper rate of application is being placed.
- The seed and fertilizer may be applied in one application provided the seed and fertilizer are not mixed more than 1 hour prior to application. Mixing more than 1 hour prior to application will damage the seed. Otherwise, the seed shall be applied in a separate application prior to fertilizing and mulching. Lime, if specified should be applied separately from the seed and mulch.
- Planting holes, pockets, or beds are excavated to the required size and depth, and spaced as shown on plans.
- The backfill mixture is prepared and stockpiled according to Contract Specifications.
- The planting holes are excavated to the sizes indicated in the Contract Plans. The [Standard Plans](#) contain minimum planting hole diameters.

### SS 8-02.3(6) Soil Amendments

The decision to use a soil amendment depends upon the existing soil and the desired outcome. Some soil amendments might encourage unwanted exotic vegetation, while the combination of other soil amendments with native soils might favor native vegetation.

**Planting Media** – Various additives are sometimes used to improve the root growing environment of the soil that exists on a site. Generally, soil amendment consists of compost. Additives may be either used as a blanket or incorporated into the existing soil. Check the planting (growing) media material against the specification.

#### SS 8-02.3(6)A Compost

Compost is used for multiple functions on projects. It serves as a soil amendment, may be a component of topsoil, and is used as an erosion control BMP when applied as a blanket over soil.

- Prior to placement review the compost for physical contaminants (plastics, concrete, ceramics, metal, etc.) and ammonia odor.
- The permanent protection of earth cut and fill slopes should be accomplished as soon as possible. When provided in the Contract, compost blanket should be evenly placed on the slopes to a depth specified, prior to seeding or other planting. The timing and scheduling of the compost application may occur as early as possible for erosion control purposes and not necessarily immediately prior to seeding and planting operations. If compost is applied days or weeks before seeding and mulching, or in arid and/or windy climates, the soil or compost needs to have a tackifier applied to prevent the compost from blowing away.



**SS 8-02.3(6)B Fertilizers**

Apply fertilizers in accordance with the Specifications. Cross check the label on the bag or container with the Specifications. When water soluble nitrogen fertilizers are used, particularly in lawn areas, adequate moisture is needed to prevent fertilizer burn of the grass.

**SS 8-02.3(7) Layout of Planting, Lawn and Seeding Areas**

The layout of planting areas in wetlands or stormwater facilities is critically important to the wetland's success. Many plants have exact water requirements and will not thrive or even survive if planted in water too deep or too shallow. Changed conditions happen frequently during the grading phase. Work with the Landscape Architect to ensure the hydrology of the grades are finished to the necessary elevations before planting. Close coordination with the designer during the grading and plant layout phases can identify potential problems and fix them before they become costly mistakes.

Tree locations might need to be adjusted to anticipate the size of the tree when fully grown for:

- Minimum clearance to roadways
- Mowing edge setbacks
- Sight lines
- Existing utilities
- Signs
- Structures
- Drains

Planting areas might also need to be adjusted to align with the plans and the disturbed areas, and the edge should create a "flowing" outline that is aesthetically pleasing and mowable. It is important that sufficient stakes are used to clearly outline the planting areas. Again, the Landscape Architect should be consulted to ensure proper planting area placement.

- Review the plan sheets, quantities, details, Specifications, and other provisions in the Contract with the Contractor. Questions or interpretations can be answered or problems resolved through discussion with the Region Landscape Architect.
- All materials that have Specification requirements shall have an approval of source prior to incorporation or use on the project. The Contractor is required to submit samples of materials to verify that the materials adhere to the specifications. See [Chapter 9](#) of this manual for further instructions and Section 8-2.6 for examples.
- The Inspector should check and accept the stakeout of all planting areas and planting hole locations prior to excavation. Minor relocation of planting areas and holes can be done at this time to avoid utility lines, rock outcrops, drainage ditches, signs, obstructions, or impervious or wet soil conditions. If minor relocation of plantings is not possible, the Inspector should contact the Landscape Architect to adjust the design requirements or quantities.

**SS 8-02.3(8) Planting****SS 8-02.3(8)A Dates and Conditions for Planting**

Planting must be done during the planting windows, per the *Standard Specifications* to allow for maximum growth during the rainy season.

**SS 8-02.3(8)B Plant Installation**

Proper storage and handling of plant material is expected of the Contractor to ensure healthy plant material prior to planting.

**Plant Material**

Drying out, excessive heat and cold, and other environmental stresses can be extremely detrimental to a restoration effort. The planting plan was developed to respond to the contract impacts, but the quality and treatment of the materials on the site will be of the utmost importance to ensure success.

**Inspection During Planting** – Planting stock on hand and ready for planting at the construction site should have been inspected upon delivery, in accordance with the checklist under “Inspection at the Construction Site”.

**Inspection at the Nursery** – Upon Contractor request, inspections may be done at the nursery. However, acceptance is only given once on-site inspection determines the adequacy of the material to meet the specifications. The Region Landscape Architect or HQ Landscape Architect should perform this inspection and make recommendations to the PEO to be communicated to the Contractor.

Inspection at the nursery or other source of supply should include the following:

1. Review the general condition of the plant in the block from which the stock is to be taken:
  - a. **Uniformity of Leaf Coloration** – Yellowing or other leaf discoloration could indicate poor drainage, fertilizer deficiency, herbicide damage, insect damage, or disease, and may not meet specifications.
  - b. **Bud Development** – During dormant periods of the growth cycle, plants should have buds that are firm, moist, and uniformly spaced. A slight cut into the bark may be made to determine that the cambium, or growing layer just beneath the bark, is moist and green.
  - c. **Uniformity of Growth** – Acceptable plants in any given block should exhibit uniform vigor and health.
  - d. **Spacing of Plants in the Nursery Row** – Sufficient spacing is needed to permit vigorous development of the individual plant.
  - e. **Soil** – Plants to be balled and burlapped must be grown from soil that will hold a firm ball. Reject broken or loose balls due to the potential for damage to the hair roots.
  - f. **Presence of Weeds** – Reject containers with an abundance of weeds in the containers. An overgrown, weed-infested nursery block indicates lack of care and the plants growing in it may be in a poor state of vigor.
2. Check individual plants for freedom from defects such as:
  - a. **Decay** – Reject trees with spots of decayed tissue on the trunk and branches.
  - b. **Sunscald or Sunburn** – Plants with damage to cambium tissue and bark due to sun scald on the south or southwest side are unacceptable due to the potential for secondary insect and/or disease infestation.

- c. **Abrasions of the Bark** – Abrasions severe enough to damage the cambium tissue may be sufficient for rejection.
  - d. **Girdling Roots** – Roots that grow around another root or a stem are cause for rejection.
  - e. **Improper Pruning** – Pruning cuts should be made just outside the branch collar and close to the trunk or supporting branch. When a cut is made to encourage branching, it should be made back to a bud. Improperly pruned stubs that have died back are a significant point of entry for disease organisms.
  - f. **Frost Cracks** – Long vertical splits in the bark and/or wood may occur on the south and southwest sides of young and thin-barked trees. Such cracks may be invaded by canker or decay-producing fungi and bacteria.
  - g. **Signs of Injury** – Dead leaves, dry buds; dieback of twigs and branches; blackened sapwood and sudden, discolored patches of bark (sunscald) on the trunk or limbs.
  - h. **Diseases** – Look for abnormal growth of leaves, twigs, fruits, discoloration of leaves and bark, unusual discharges of sap through the bark, etc. Reject plants showing evidence of disease.
  - i. **Insects** – Look for insect eggs, spider webs, or evidence of damage from insect feeding on leaves, twigs, buds, or other plant parts. Examine the trunks of trees for borer holes which appear as tunnels drilled into the bark and inward into the wood of the trunk. Reject trees with evidence of borers or other insect damage. Often sawdust-like material can be found below bore holes.
3. Check individual plants for proper habit of growth as follows:
    - a. If a particular habit, i.e., single stem, multiple stem, has been specified, plants must conform to this requirement.
    - b. If no particular growth habit has been specified, then the current American Standard for Nursery Stock, Z60.1 as published by the American Association of Nurserymen should be used as a guide
    - c. Top growth on shade and flowering trees should be symmetrically balanced, have a single leader, and well-developed branching characteristic of the species.
    - d. Evergreen trees should be uniformly dense. Sheared plants, such as Douglas fir sheared for Christmas trees, are not allowed, unless specified.
    - e. Shrubs should be well branched in a manner characteristic of the species. If not specified in the contract, the standards for size and number of branches by species listed in the current American Standard for Nursery Stock, Z60.1 applies.
  4. Remove a random sampling of plants from their containers to verify that the root system is healthy. Reject root-bound plants and plants that have insufficiently developed root systems to hold the soil together. Healthy roots will hold the soil mass together yet not be crowded around the outside perimeter of the container.
  5. Tag planting stock meeting the above criteria with seals placed on all plants or representative samples at the nursery to assist in future inspection of these plants when delivered on the job site. Seals placed on planting stock for later identification do not imply acceptance on the construction site.

**Inspection at the Construction Site** – Acceptance of stock may only be given at the construction site according to the *Standard Specifications*. It ensures that the plants delivered are from an accepted source, are in a healthy and undamaged condition, and conform to sizes, quantities, and standards called for in the specifications. Plant inspection lots should be established and a representative number of plants should be inspected in accordance with Section 9-4.44.

Inspect the condition of the plant and verify that proper handling procedures have been followed from the time of initial inspection to delivery at the construction site. If there are questions about the following checklist, consult with the Landscape Architect for clarification.

Inspect plants delivered to the construction site for the following:

1. All planting stock are of the genus, species, variety, and sizes specified and conform to the contract specifications for the particular species, or variety, regarding straightness of trunk, branching structure, proportion, and size of material.
2. Individual plant measurements meet the contract specifications. If a particular detail of measurement has not been specified, the current edition of [American Standard for Nursery Stock](#), Z60.1 shall be used.
3. Use judgment and selectivity to sample plant materials. Inspect the entire lot for the same criteria as in the nursery inspection. Ensure each shipment of plants is free of disease and insect pests, and meets all applicable State and Federal certification requirements. All necessary quarantine or State nursery inspection certificates accompany each shipment.
4. All trees and a representative sample of shrubs are legibly tagged with the correct botanical name, common name, and size to agree with the specifications and plant list. Bare-root plants have been shipped in bundles with each bundle properly tagged.
5. Inspect planting stock as the material is being unloaded, or immediately thereafter, so that plants that are obviously unacceptable can be set aside for removal from the project site.
  - a. It is sometimes helpful to mark the pots of unacceptable plants with a dot of spray paint to ensure they are set aside to return to the supplier.
  - b. Set plants in blocks of 10, 25, 50, or 100 containers for ease of counting plants – block size is dependent on the scale of the project.
6. Large root stubs on nursery grown balled or bare-root stock are indicative of lack of proper care and root pruning, and sufficient grounds for rejection of such plants. Root stubs frequently characterize “collected” stock and precautions should be taken to ensure that root systems are adequate
7. Damage to plant material caused by improper operation of mechanical diggers may be sufficient cause for rejection at the construction site. Plants dug with equipment leave a cone-shaped ball; these should be carefully checked to make sure that an excessive portion of the root system has not been cut away. Feeder roots are the newly formed roots, usually white in color.



8. Bare Root Plants:
  - a. Where root formation is irregular on bare-root plants, measure the average spread of the roots, considering all sides of the plant, rather than the maximum root spread. The Inspector may allow moderate deviations ( $\pm 10$  percent) from exact measurements in the case of plants which normally have irregular root systems. Example: Vine Maple.
  - b. Bare root plants must be dormant when gathered and prepared for shipping. The normal test for dormancy is observation; if the plant has been subjected to cooling environment and the majority of the leaves have fallen naturally it is a good indication of dormancy. Expert advice from the Landscape Architect should be obtained in all other cases. Bare-rooted plants meeting the quality expectation have adequate live, damp, fibrous roots, free of rot and mold. Earth balls should be unbroken and of specified size.
  - c. Precautions should be taken to prevent the drying of root systems in all shipments of plants to ensure arrival in good condition. During transport, plants must have been protected by a covering such as canvas or plastic sheeting. Bare-root plants should have been protected by moist burlap, sawdust and surrounded by plastic, etc. Under no conditions should the roots system have been allowed to dry out. All plants must exhibit normal health and vigor.
  - d. Reject plants with roots that have dark brown tips, are shriveled, dried up, soft, slimy, smelly, or moldy.
  - e. Reject plants with dull green, streaked, or brown cambium. The inspector is authorized to examine cambium on randomly selected woody plants by removing a thin scraping of bark with a fingernail, small knife, or other tool.
  - f. Following completion of inspection, all plants accepted should be carefully stored as required below until planted.
9. Quality – The size and quality of planting stock are standardized as much as is practicable considering that the materials are live and may vary due to growing conditions. Judgment should be exercised and allowances made for reasonable variation in growth and appearance.

**Interim Care of Planting Stock** – Plants not planted on the day of arrival at the site should be stored and handled as follows:

- Outside storage should be shaded and protected from the wind.
- Plants stored on the project should be heeled-in to protect them from drying out at all times by covering the bare root or balls with moist sawdust, wood chips, shredded bark, peat moss, or other accepted mulching material. Plants, including those in containers, should be kept in a moist condition until planted by using a fine mist spray or soaker hose, instead of a heavy stream which may cause damage.
- Avoid damaging plants being moved from the storage area to the planting site. Balled and Burlapped (B&B) plants should be protected against drying and handled carefully to avoid cracking or breaking the earth ball. Plants should not be handled by the trunk or stems.
- Bare-root plants should be watered when removed from the heeling-in bed to protect the roots from drying and they must be planted quickly.

- Should damage occur, or be found at this time, the plants should be rejected and removed from the site.
- At the time of planting, the Inspector should be alert for any damaged soil balls, leaders, major branches, or roots. Pruning is permitted to remove minor damaged branches, if it will not affect the characteristic shape of the plant (see *Western Garden Book – Pruning Techniques*). All rejected plants should be replaced during the current planting season. All broken, torn, or damaged roots should be pruned, leaving a clean cut surface to help prevent rot and disease.
- In order to ensure against reuse of discarded plants, seals should be removed and the trunk or stems above the root crowns should be marked with a small spot of paint or dye. Since discarded plants are the property of the Contractor, they should not be marked or mistreated in such a way as to make them unfit for other uses.

**Planting Operation** – The Contract Specifications identify the work necessary to accomplish the planting. The following is a checklist of horticultural practices that may be used by the Inspector.

- Plantings should be performed only during the specified planting season according to the specifications.
- Check for proper positioning of the plants and the spread of the root system in the planting hole. For example, on live stakes, the buds must point up, see Standard Plan [H-10-15-00](#).
- When laying out shrub and ground cover beds, define the perimeter by placing plants in a flowing line that clearly outlines the bed border. The interior should then be staked in accordance with the plant pattern and spacing.
- Before B&B plants are set into the planting hole, burlap, twine, and all other foreign materials shall be completely removed.
- Check for correct depth of the root collar. Tree root collars should be above the soil but roots must be completely covered by soil. Occasionally, Contractors leave a portion of the rootball above the soil on the assumption that the mulch will cover it up. This is not an acceptable practice. Plants should not be planted deeper than the root collar – this is the point where the roots begin to spread from the trunk. In some cases, trees may have been planted too deeply at the nursery so make sure root collars are visible above the soil surface before planting.
- Before backfilling, especially in drilled holes, the sides and bottoms must be scratched and loosened to break all “glazing.” This promotes moisture transfer between different soils (existing and backfill).
- Place accepted backfill material around plant roots or plant balls, being careful not to damage the ball or the fine root system of bare-rooted plants. Do not allow backfill which is frozen or saturated.
- Eliminate air pockets in the backfill by filling, tamping, and watering. It is required in the *Standard Specifications* to water the plants thoroughly before the backfilling of the pit is completed. Container plants should be moist at the time of planting.
- When the above operations have been completed, unless otherwise specified, the *Standard Plans* planting detail [H-10-10-00](#) requires a berm of soil to be formed from soil around the perimeter of the pit to form a basin or saucer to facilitate watering and retention of rain or irrigation water. When planting on slopes, the berm should be on the downhill side only. This allows the plant to catch runoff from up slope.

- Plants should be mulched to the specified depth with accepted mulch material. The Standard Plans require mulch to be feathered away from tree root collars. When mulching ground covers, ensure the plants are not buried in mulch.
- Excessive moisture in a planting area is defined as visible water in an area not designated as a wetland, and may require elimination or adjustment of planting in that area. Consult with the Region Landscape Architect when excessive moisture is encountered. Mounding may be considered when it is necessary to raise the bed above the water table. Planting in saturated soil often kills the plant because the water keeps oxygen from reaching the plant roots.

### **SS 8-02.3(8)C Pruning, Staking, Guying, and Wrapping**

Plants should be wrapped and staked only if specified. Details for staking are shown in Standard Plan [H-10-10-00](#).

- Trees normally should not be pruned except for broken branches, unless otherwise specified or directed.
- All staking and tying shall be removed at the end of the first year of plant establishment to prevent damage to the plant.

### **SS 8-02.3(9) Seeding, Fertilizing, and Mulching**

Seed mixes are chosen specifically to meet different functions that include erosion and weed control, aesthetics, and permit obligations. Applying the incorrect seed mix to an area can lead to costly erosion and weed control problems.

- Collect seed labels from each bag and check them against the Specification.
- Verify all the applicable licenses, endorsements, and seed test certification from a certified seed testing laboratory as stated in the Specifications.

Seeding for permanent erosion control must be done during the seeding windows, per the *Standard Specifications* to allow for maximum germination and establishment during the rainy season.

Seed on soil is not considered adequate erosion control until a stabilizing cover of vegetation is established. For this reason, mulch is often applied with seeding to provide immediate coverage. Straw, wood strand mulch, and compost often get used with seeding application, as do a variety of hydraulically-applied erosion control products (HECPs).

West of the summit of the Cascade Mountain Range, HECPs may be applied with seed and fertilizer. Each pass must be applied from a different direction to get complete coverage of the soil.

East of the summit of the Cascade Mountain Range, the seed and fertilizer must be applied in a first pass. Short-term mulch may be added as a tracer. Consult with the Region Landscape Architect or the HQ Design Landscape Architect if assistance is needed.

Mulch is uniformly applied to the seeded areas within 48 hours after seeding. Straw mulch is to be applied with a forced air spreader. Straw mulch may not be practical in windy areas or in areas of concentrated flow. HECP is normally applied with a hydroseeder. Checks are necessary to determine that the mulch is applied uniformly and at the required rate. HECP should completely cover the ground surface with no gaps. In areas that cannot be reached by a mulch spreader, hand methods resulting in uniform application may be used.

**SS 8-02.3(10) Lawn Installation**

Lawn installation is not a typical restoration roadside practice but it may be required in more built or developed areas and be a result of project commitments. Refer to the *Standard Specifications* for dates and conditions for lawn installation and establishment.

**SS 8-02.3(11) Mulch**

Mulches can be used on the surface for temporary erosion prevention and control and incorporated into the soil to improve the soil environment for establishing vegetation. Organic mulches such as straw, wood fiber, chips, Compost Type 2, and bark are most effective for these purposes.

**SS 8-02.3(12) Completion of Initial Planting**

The planting is complete when:

- 100 percent of plants are installed and watered-in. Watering is required by *Standard Specifications* Section 8-02.3(8) as a part of plant installation
- The planting areas are completely cleaned up.
- All repairs to irrigation systems have been completed, mulch is applied, and weeds are completely controlled.

**SS 8-02.3(13) Plant Establishment**

Plant establishment begins at Initial Planting Acceptance. The major items included in plant establishment are watering, weed control, litter pickup, start up and shut down of irrigation systems, and replanting. Weather and soil conditions dictate the need for watering. Over-watering is as harmful as under-watering. Plant establishment work is needed to ensure the survival and ongoing vigor of the plants.

**Inspection During the Plant Establishment Period**

Plants may be planted in any given area a considerable period of time prior to the granting of initial planting acceptance. During the interim between when plants are installed and initial planting acceptance the Contractor is responsible for the upkeep of planting areas and continued growth of plants.

Although planting stock has been properly selected, delivered to the planting site in a vigorous, healthy condition, and planted in accordance with good horticultural practices, survival and normal growth depend to a large degree upon appropriate care during the establishment period. A well rounded program of horticultural practices used during the establishment period may include watering, fertilizing, pruning, insect, disease, and weed control, and replacement of unsatisfactory plants in accordance with the specifications.

When plant establishment starts the area should be inspected to make sure that all plants are in place and healthy. Monthly inspections of the planting areas should take place with the Contractor on or near the first of each month during the Plant Establishment Period to spot any potential problems to which the Contractor needs to attend.

If differences of opinion concerning the need for a particular procedure occur, and the answers are not readily found in this guide, the Inspector should consult with the Region or HQ Landscape Architect.

The project Specifications should clearly indicate the length of the establishment period, which may vary from one area of the state to another, depending on the local conditions,



project commitments, climate, and the type of plant materials utilized. A minimum of three years of plant establishment work is required for all planted areas in western Washington, and planted and/or seeded areas in eastern Washington. The default period for plant establishment performed by the Contractor in the *Standard Specifications* is a minimum of one year. Subsequent years will be funded from Capital Program Development & Management through environmental mitigation and roadside restoration funding. Work will be managed by WSDOT.

- A. **Inspection Checklist** – The following inspection checklist includes the primary items which should be observed periodically during establishment.
- The project areas are weeded.
  - Plants that have sagged, fallen over, or are otherwise not situated in a natural growing position, as appropriate for the species, may require repositioning.
  - Firmly embed stakes or reinstall as necessary.
  - Protect the root mass to avoid disturbance to the root mass. Replace topsoil as required if soil has subsided.
  - Staked trees are straight. Adjustment of stakes may be needed. Where used, protective wrapping on trunks or stems is secure.
  - Damage due to vandalism, vehicles, or fire is noted and corrective action taken.
  - Record damage caused by animals (i.e., deer, rodents) and seek advice on protective measures.
  - Report infestations of insects and disease to the Landscape Architect for corrective action.
  - Broken branches have been pruned just above the break.
  - Where discoloration of foliage occurs, especially in evergreen material, seek advice on corrective measures. Once evergreen foliage is brown recovery is not possible.
  - Dead and severely damaged plants are removed immediately and replaced during the next appropriate planting period.
  - Mulch is to the correct overall depth. Add or replace as required.
  - Berms and water basins (constructed for the purpose of retaining water) are functioning properly. Repair and rebuild as necessary.
  - If natural rainfall during the establishment period is insufficient for normal plant growth, supplemental water has been supplied.
  - Supplemental fertilizers have been applied if required by the Contract Specification.

- B. **Inspection at the End of the Plant Establishment Period** – Conduct a plans-in-hand review of each planting area or bed to determine that the arrangement, number, and species of healthy plants called for on the Planting Plans are present.

This inspection is of major importance to the ultimate success of the project; include a Landscape Architect, the Inspector, and Contractor on the inspection team.

Remove all plants rejected during the inspection and replace with new plants that meet all of the requirements of the contract and the *Standard Specifications*.

The final acceptance of the project is not complete until all plant establishment requirements have been satisfactorily made.

**SS 8-02.3(14) Plant Replacement**

Inspect and approve all replacement plant material prior to installation.

**SS 8-02.3(15) Bioengineering**

Soil bioengineering is the use of plant material, living or dead, to alleviate environmental problems such as shallow rapid landslides, and eroding slopes and streambanks. In bioengineering systems, plants are an important structural component, not just an aesthetic component. Soil bioengineering may be used as a BMP to stabilize and revegetate slopes and stream banks when changes in condition require adaptation to control sediment and erosion. For more information on the uses of soil bioengineering, see the [Roadside Manual](#) M 25-30 Chapter 740.

**SS 8-02.3(16) Roadside Maintenance Under Construction**

For larger construction projects that span multiple seasons, certain areas of the roadside will require additional work when WSDOT maintenance crews have no access within project limits. Expectations for roadside mowing and ditch maintenance are outlined in the *Standard Specifications* if the item "Roadside Maintenance Under Construction" is included in the Contract.

**SS 8-02.5 Payment**

The Project Engineer shall make an inspection of the planting areas before payment is made, to determine if the required work has been accomplished and the number and species of plants shown on the Planting Plans are in a healthy condition. No payments shall be made for plants that are not in a healthy condition, although partial payment may have been made following a previous inspection.

**8-03 Irrigation System****GEN 8-03.1 General**

The objective of irrigation on WSDOT contracts is to help ensure plant survival by supplementing natural precipitation during dry periods. This can often be accomplished with far less water than that required to obtain maximum growth and yields. Application rates of irrigation systems are, therefore, designed from the standpoint of minimum moisture requirements of the plants.

A properly designed and installed irrigation system will distribute water uniformly over the intended planting area at a predetermined precipitation rate, or by irrigating within the root zone of plants by bubblers or a drip system. Many factors influence the efficiency of a system's operation and must be taken into consideration during the design stage. In addition, care must be taken when inspecting installation of the irrigation system to ensure that the system not only follows the designer's intent, but also fully conforms to the *Standard Specifications*, project plans and provisions, and the manufacturer's requirements and recommendations.

The most efficient and economical irrigation design is only as good as its installation, and this depends upon careful and thorough inspections.

## **GEN 8-03.2 Inspection**

Thorough inspections, carefully conducted during construction, are of utmost importance to help ensure proper installation. To be adequately prepared for inspecting the installation of irrigation systems, it is of great benefit for the Inspector to have previous knowledge, preferably some experience, in at least one of the various aspects of irrigation design, installation, and maintenance. This not always being possible, it becomes necessary for the Inspector to first familiarize themselves with those portions *Standard Specifications* Sections 8-03 and 9-15 and contract documents that pertain to inspection and irrigation systems before attempting the necessary inspections. In addition, since irrigation inspection requires such varied and versatile knowledge and experience, it is advisable for the Inspector to obtain additional advice and/or assistance from WSDOT personnel having the expertise in these specialty areas.

An inspection shall be conducted on all irrigation system components delivered to the project site to determine acceptance or rejection. If at any time, until the system is completed and turned over to WSDOT, components are found that are damaged, defective, or not formally accepted for use on the project, they shall be rejected. Information indicating acceptance or rejection of components shall be properly documented and maintained by the Inspector at all times.

## **SS 8-03.2 Materials**

All components intended for use in an irrigation system must receive acceptance prior to their incorporation into the project as required in Section 9-49.9.

Acceptance of items is determined from information supplied on the Request for Approval of Material (RAM) (WSDOT Form 350-071) and accompanying catalog cuts. Items selected off the *Qualified Products List* are already accepted for use and do not require the submittal of a RAM. All components of the irrigation system shall be listed and identified by their corresponding bid item number where applicable. Sufficient information must be included to positively identify each item listed. Each item shall be identified by size, catalog number, and the name of the manufacturer.

If samples are requested for preliminary evaluation, it will be the Contractor's responsibility to obtain and submit the designated items to the Project Engineer for testing. Unless destructive testing is required, all items will be returned to the Contractor upon completion of testing, at which time accepted items may be incorporated into the project.

## **8-03.3 Construction Requirements**

### **8-03.3(1) Layout of Irrigation System**

Irrigation is installed before planting. The outlines for turf areas and planting beds shall be designated prior to staking the irrigation system. If adjustments to a head-to-head irrigation system are required, the Contractor must produce a system which will provide a uniform spray pattern without leaving dry areas.

Spray heads to be located adjacent to the perimeter of planting beds should be laid out first to approximate as closely as possible the designed or accepted revised configuration of the planting area. The remainder of the planting area should then be filled with the spacing between heads not to exceed that which is shown on the plans or recommended by the manufacturer.

Review all layouts and measure the distance between adjacent heads to ensure that full coverage of water will be attained. If the pattern is not uniform in coverage, or if the distance between heads exceeds that recommended by the manufacturer, the layout will need to be adjusted.

Unless otherwise specified in the project provisions, all irrigation systems shall be completed, tested, accepted, and properly backfilled before planting can begin.

Advise the Regional Landscape Architect when the irrigation system has been staked in the field.

#### **SS 8-03.3(4) Irrigation Water Service**

The Project Engineer should contact the serving water utility as soon as the Contractor's schedule is known to arrange for the actual service connections, and to ensure that all agreements are completed, and billing procedures are established.

#### **SS 8-03.3(5) Irrigation Electrical Service**

The Project Engineer should contact the serving electrical utility as soon as the Contractor's schedule is known to arrange for the actual service connections, and to ensure that all agreements are completed, and billing procedures are established.

#### **SS 8-03.3(9) Irrigation System Installation**

Once the irrigation system layout has been staked and accepted by the Project Engineer, the Contractor may commence excavation.

Trench bottoms shall be relatively smooth to provide support along the entire length of pipes to be installed. In addition, and as specified in *Standard Specifications* Section 8-03.3(2), trench bottoms shall be of sand or other suitable material free from rocks, stones, or any material which might damage the pipe.

All system components shall be installed in accordance with the project plans and documents, using methods or techniques recommended by the respective component manufacturers.

Solvent welding is a technique used to bond PVC pipe and fittings together. The solvent cement used in this type of installation is, as its name implies, a solvent which dissolves those portions of the pipe and fittings surfaces to which it is applied, to form a continuous bond between the mating surfaces. During the construction of PVC solvent weld joints, excess cement is forced out by the insertion of the pipe into the fitting socket. This excess cement, if not immediately removed, will dissolve the surface of the pipe at its point of accumulation and will result in a permanently weakened spot. It is necessary, therefore, that this excess cement be wiped at the time the joint is made and that the Inspector check to ensure that it has been done.

Plastic pipe is subject to considerable expansion and contraction with temperature changes. To provide for this, pipe should be snaked from side-to-side in the trench.

Care shall be taken during the installation of the pipe to ensure that rock, dirt or other debris is not allowed to enter the open ends of the pipe.

Protection from freezing must be provided as specified in the project documents. Either a three-way valve with compressed air fitting for blowing water out of the lines, or drain valves placed at the low point of each lateral must be used. If the three-way valve and air fitting is to be used, it must comply with one of the designed installations accepted for use by the Washington State Department of Health. If drain valves are used, care must be taken to ensure that the lateral lines are properly sloped to provide complete drainage. When handles are included as an integral part of the valves, the Contractor shall remove the handles and give them to the Project Engineer for ultimate distribution to the Maintenance Division.

#### **SS 8-03.3(9)F Cross-Connection Control Device Installation**

Installation of cross-connection control devices shall conform to the Standard Specifications, the project plans and documents, the manufacturer's recommendations, and the "Accepted Procedure and Practice in Cross-Connection Control Manual". In all cases, the backflow prevention device shall be tested by a certified inspector prior to activating the system. Additionally, the Contractor shall fill out DOT Form 540-020 and submit the form to the Project Engineer for record. Contact your Region Landscape Architect if any questions arise.

#### **SS 8-03.3(9)G Electrical Wire Installation**

Electrical control wire between the automatic controller and the automatic control valves, shall be bundled together at 10-ft intervals and snaked from side-to-side in the trench, either adjacent to or beneath the irrigation pipe. Snaking of the wire helps eliminate wire stressing or breakage caused by expansion or contraction of the earth due to variations in moisture content or extreme seasonal temperature fluctuations. Placement of the wires adjacent to or beneath the irrigation pipe is for protection against damage from possible future excavation. After partial backfilling of the irrigation trench, detectable marking tape shall be placed above the irrigation and wiring lines to facilitate future location of the lines. All electrical layouts shall be installed per the plans or manufacturer's recommendations.

Electrical splices shall be permitted only in valve boxes, junction boxes, pole bases, or at control equipment. No direct burial splices shall be allowed. Types of electrical splices allowed in WSDOT irrigation projects shall be only those accepted for use by the State Materials Laboratory. Accepted electrical splices are listed in the *Qualified Products List* or may be accepted through the use of a RAM.

#### **SS 8-03.3(13) As-Built Plans**

The Project Engineer is required to submit As-Built Plans in accordance with *Standard Specifications* 8-03.3(13).

Accurate As-Built Plans are a valuable and necessary aid in designing and constructing future projects for the area, and for maintenance and repair of the irrigation system. Therefore, it is imperative that these As-Built Plans show the true location, size, and quantity of components installed.

*Standard Specifications* Sections 1-05.3 and 8-03.3(13) state that the Contractor is responsible for supplying working drawings, corrected shop drawings, schematic circuit diagrams or other drawings necessary for the Engineer to prepare corrected plans to show the work as constructed. To help ensure accuracy of this information requires that

the Contractor or field representative record each change as it is completed. In addition, the Inspector shall inspect and verify this information prior to the commencement of backfilling. Upon completion of this, all working drawings and pertinent information shall be submitted for the Project Engineer's acceptance and use in preparing the As-Built Plans.

The Contractor may also be required to conduct a training and orientation session for WSDOT personnel covering the operation, adjustment, and maintenance of the irrigation system. The Project Engineer shall arrange to have the maintenance personnel who will be involved with the irrigation system attend this orientation session. The As-Built Plans shall be available at the meeting so they can be reviewed and all features explained. One copy of the As-Built Plans shall be presented to the maintenance personnel, along with parts lists, keys to vaults, and service manuals for all equipment at the time of the meeting.

## 8-04 Curbs, Gutters, Spillways, and Inlets

### SS 8-04.3 Construction Requirements

#### SS 8-04.3(1) Cement Concrete Curbs, Gutters, and Spillways

The *Standard Specifications* specify the class of concrete to use when constructing the various items. Quite often the Contractor places the concrete for these miscellaneous items at the same time of placing concrete for other work. When this is the case, it is usually more convenient for the Contractor to use the same class of concrete for all the work during the day. At the Contractor's request, the Project Engineer may accept a higher class of concrete in lieu of the class specified at no increased cost to WSDOT. This substitution should be documented in the Inspector's Daily Report, or other records.

## 8-11 Guardrail

### GEN 8-11.1 General Instructions

Guardrail is designed to minimize exposure to roadside hazards. Since guardrail is expensive to construct and requires continual maintenance, it should be constructed only where specific conditions justify its use. Conditions may change between the design and construction phases of work. Contact the Design Project Office if there are any questions regarding the placement location or type of new runs of guardrail.

It is good practice to double check the location, layout and arrangement of new guardrail and terminals in the field after the embankment has been constructed but before the guardrail has been installed. Consult with the Design Project Office if any apparent problem is discovered at the site and certainly before deleting or modifying a run of guardrail.

### SS 8-11.3 Construction Requirements

#### SS 8-11.3(1) Beam Guardrail

##### SS 8-11.3(1)A Erection of Posts

The posts shall be set to the true line and grade of the highway and spaced as shown on the *Standard Plans*. Posts may be placed in dug or drilled holes. Ramming or driving will be

permitted only if allowed by the Engineer and if no damage to the pavement, shoulders and adjacent slopes results therefrom. The post holes shall be of sufficient dimensions to allow placement and thorough compaction of selected backfill material completely around the post.

When there is an underground conflict such as a utility line, drainage structure, or other type of obstruction the Contractor may submit an RFI in accordance with Section 1-05.1(2) for omission of a post(s). Contact your HQ Design ASDE for further assistance.

### **SS 8-11.3(1)C Terminal and Anchor Installation**

Installation of guardrail terminals shall be supervised by the manufacturer's representative, or an installer who has been trained and certified by the manufacturer within the last 5 years for the specific device being installed. The Inspector will verify that a copy of the installer's certification is on file prior to installation.

After installation is complete, the Inspector will collect an original signed manufacturer's terminal assembly/inspection checklist for every terminal installed. A copy of the checklist will be attached to the Inspector's Daily Report and the original will be retained at the Project Office.

The Project Engineer should invite the area Maintenance Superintendent to the pre-construction conference to discuss final inspection of the guardrail terminals. The area Maintenance Superintendent can give the Project Engineer the contact information for the Lead Technician assigned to the project at this time. The Lead Technician assigned will be the point of contact for final guardrail terminal inspection.

At intervals determined by the Project Office and the Lead Technician, or at a time and date agreed upon, the Inspector and Lead Technician will conduct a final walk through of the new guardrail and end terminals installed on the Contract. It is suggested this final walk through occur while the Contractor is still on-site, and before opening to traffic. The walk through will allow the Inspector and Maintenance Technician to perform the following tasks:

- Conduct a final inspection of the new guardrail and end terminals using the installation checklists provided by the installer (performed by the Lead Technician and Inspector)
- Enter installation checklists into the maintenance database HATS (performed by the Maintenance Technician)
- Conduct an as-built survey and inventory of the location of each guardrail terminal and enter information into HATS (performed by the Maintenance Technician)

The original installation checklists collected during the life of the project will be handed off to the Maintenance Technician during the final walk through.

The walk through should be conducted prior to the completion of physical work, in the event the Contractor must correct deficiencies or provide temporary traffic control. Coordination with the Contractor may be needed to plan the inspections with Maintenance.

## 8-12 Chain Link Fence and Wire Fence

### SS 8-12.3 Construction Requirements

Since preservation of natural growth is being stressed, clearing will have to be performed specifically for the fence construction on many projects. In these cases, only the width necessary to accommodate the fence construction should be cleared. Some grading is usually necessary to prevent short and abrupt breaks in the ground contour that will affect the aesthetic appearance of the top of the fence. Care needs to be exercised to prevent clogging natural drainage channels while grading the fence line.

## 8-14 Cement Concrete Sidewalks

### SS 8-14.3 Construction Requirements

#### SS 8-14.3(2) Forms

Forms may be of wood or metal and full depth of the sidewalk. The forms should be straight or uniformly curved and in good condition.

In rest areas and park areas where the sidewalks are normally laid out in a winding pattern rather than in straight lines, care must be taken in setting the forms so that the sidewalk will present a pleasing appearance with no kinks or angle breaks. The forms must be braced and staked sufficiently to maintain them to grade and alignment. Usually, spreaders are necessary to properly space the forms and hold them in position until the concrete is placed. If the Contractor uses thin strips of form material for winding sidewalks, more than one thickness with staggered joints should be used to obtain the smooth flowing lines. In forested areas, all roots should be removed or cut back. After the forms have been set, the foundation shall be brought to the required grade, compacted and well dampened. Prior to placement of concrete, the inspector shall verify that the forms are set to line and grade, and shall check the forms for cross-slope and grade of the sidewalks and ramps, for conformance with the Plans, and to ensure that the requirements of the Americans with Disabilities Act (ADA) are met. If there are junction boxes, cable vaults, manholes or other utilities present in the sidewalk or ramp surface, they must be flush with the sidewalk or ramp surface.

#### SS 8-14.3(3) Placing and Finishing Concrete

Air entrained concrete Class 3000 (or Commercial Concrete) shall be used for construction of sidewalks. After the concrete is placed, it should be struck off with a straightedge. The concrete should be troweled smooth with a steel trowel and then lightly brushed in a transverse direction with a soft brush. On grades of over 4 percent, the surface shall be finished with a stipple brush or as the Engineer may direct. Following brushing of the surface, the concrete shall be edged and jointed as shown in the plans or the *Standard Plans*. In areas adjacent to existing sidewalks, the jointing pattern should be similar to the existing pattern. Consideration should be given to placing crack control joints adjacent to cracks in the existing sidewalk if they are not going to be repaired. If the cracks in the existing sidewalk are full depth, they may cause reflective cracking in the new adjacent sidewalk.

Expansion joints shall be constructed at the locations and of the sizes as detailed in the plans or in the *Standard Plans*.



All concrete sidewalks shall be properly cured. During this curing period, all traffic, both pedestrian and vehicular, shall be excluded. Vehicular traffic should be discouraged and by no means allowed until the concrete has reached its design strength. There is a risk that the sidewalk can be damaged as it was not designed to take these loads. Before any decision to allow vehicles on a sidewalk there should be a clear agreement that any damage will be repaired and who will pay for it.

## **8-20 Illumination, Traffic Signal Systems, and Electrical**

### **GEN 8-20.1 General**

Illumination and traffic signal systems, due to the very nature of the work, are a highly specialized type of installation. In designing these systems, every effort is made to avoid problems for construction, maintenance, and the utility company. If problems arise, the Engineer should contact those responsible for the design and operations for help in solving them.

### **GEN 8-20.2 Inspection**

Inspection on electrical projects involves two aspects of work. The first of these is the physical aspect wherein conformance to the plan requirements relative to the materials used and general construction techniques must be the criterion for judgment. An Inspector who is thoroughly familiar with the requirements of *Standard Specifications* Section 8-20 and with normal construction techniques should be assigned the inspection responsibility for this portion of any signal or illumination project. The Fabrication Inspector shall be consulted if lighting or traffic signal standards arrive on the jobsite without prior inspection.

The second aspect of electrical work involves the conformance by the Contractor with the contract requirements in addition to the requirements of the State electrical construction codes and the National Electric Code. This aspect of inspection must be performed by an electrical Inspector. A further consideration within this aspect of work involves any changes authorized in the contract plans as it may affect circuit stability, circuit adequacy, and the ability of related electrical control devices to properly function through any such change of plans. The performance testing of the system is part of the second aspect of the electrical work.

Electrical work is a specialized field of endeavor within WSDOT; therefore the Project Engineer must arrange for the assistance of an electrical Inspector from the Regional office. The electrical Inspector shall make periodic inspections throughout the course of construction of all electrical projects and shall advise the Project Engineer of appropriate times to enable the Project Engineer to occasion the required field tests of electrical circuits, as discussed in *Standard Specifications* Section 8-20, at such times that cause a minimum interference of the work scheduled by the Contractor. Should any question arise on a project pertaining to the technical nature of the work, the Project Engineer shall consult with the electrical Inspector or with the Regional Traffic Engineer, if necessary.

Our plans and specifications are designed generally to conform with existing national electrical codes. There are instances when the Department permits methods of construction that are considered equivalent to state and national codes.

Generally, local inspection authorities do not inspect highway work that is within the state highway right of way. From time to time, however, the Department of Labor and Industries or local electrical inspectors may visit a project to inspect or review the Contractor's work. They should be treated courteously and their judgment respected. The Department does have authority to permit alternate methods when equivalent objectives can be met if the work is within the State right of way. Should any question arise over a conflict between our plans and their opinions, the matter should be referred to the State Construction Office for advice.

## **SS 8-20.2 Materials**

### **SS 8-20.2(1) Equipment List and Drawings**

All materials for installation on illumination and traffic signal projects shall be selected off the *Qualified Products List* (QPL) or be listed on a Request for Approval of Material (RAM). Items not selected off the QPL shall be submitted to the State Materials Laboratory for appropriate action on a RAM. This list shall be complete and cover all materials which are identified on the plans or in the specifications. The list shall include the source of supply, name of manufacturer, size and catalog number of the units, and shall be supplemented by such other data as may be required including catalog cuts, detailed scale drawings, wiring diagrams of any nonstandard or special equipment. All supplemental data shall be submitted in six copies.

The Record of Materials (ROM) from the State Materials laboratory will list items for which preliminary samples or data are required. Preliminary and acceptance samples shall be submitted as required by the ROM, received from the State Materials Laboratory at the beginning of the project or as noted on the RAM. See [Section 9-4](#) for material specific acceptance requirements.

### **Working Drawings for Illumination and Signal Standards**

The Contractor is required to submit working drawings for all types of signal standards and for light standards without pre-approved plans. Pre-approved plans are listed in the [Contract Provisions and on the Bridge and Structures](#) website. If light standards with pre-approved plans are proposed, a working drawing submittal is not required. There are two different approval procedures for shop drawings. They are the State Bridge and Structures office approval, and Project Engineer approval only. In either case, the Contractor is required to submit one set of drawings as a Type 2E Working Drawing per instructions in *Standard Specifications* Section 1-05.3. The two approval procedures include the following:

#### **A. Bridge and Structures Office Approval**

- Light standards without pre-approved plans.
- Types II, III, IV, V signal standards without pre-approved plans.
- Type SD (Special Design) signal standards.

#### **B. Project Engineer Approval Only**

- Types PPB, PS, I, RM and FB signal standards.
- Types II, III, IV, V signal standards with pre-approved plans.

After the Contractor has submitted working drawings, the Engineer shall make a field check of both contract plans and working drawings. The Project Engineer is responsible for checking the geometric features of these items. Specific items that should be checked include the following:

- Foundation locations.
- Light source to base dimension (H1), if required in the special provisions and clearance to overhead utility wires.
- Mast arm lengths. If foundation offsets are changed, mast arm lengths must be adjusted.
- Horizontal dimensions from single standard pole centerline to signal head attachment points.
- Vertical dimensions from signal standard base plate to signal mast arm connection points. Assistance is available from the Traffic Design office in estimating mast arm deflection to ensure vertical clearance requirements are met.
- Orientations of mast arms and all pole-mounted appurtenances.
- Signal head mounting details.
- Hand hole location and orientation.
- Base treatment for lighting standards (fixed, or slip, or breakaway).

If there are no changes to dimensions or orientations, the Project Engineer shall mark the drawings with a statement that all standards shall be fabricated according to dimensions and orientations shown in the Contract.

If there are corrections, the Project Engineer shall note all corrections on one set of shop drawings, with green markings only, and attach copies of signal standard chart and/or luminaire schedule from contract, noting any dimension changes in green. Or the Project Engineer may note the changes in a list form and submit it with the PDF within the email.

The State Bridge and Structures office will conduct a structural review, and make comments in red, incorporating the Project Engineer's geometric review comments.

The working drawings for supports without pre-approval shall be submitted to the State Bridge and Structures office, which will coordinate approval with the State Materials Laboratory as necessary. After approval, the State Bridge and Structures office will retain one set and forward the approved PDF file to the Project Office. The Project Engineer will forward the approved PDF file to the Fabrication Inspector, the Region Signal Superintendent (or designate), and the Contractor, who will forward to the Fabricator. See the Shop Plans and Working Drawings Table in [Section SS 1-05.3](#).

If pre-approved shop plans have been submitted, a structural review by the State Bridge and Structures office is not required. The Project Engineer shall mark all changes in red on the PDF file. The Project Engineer will then forward to the Regional Operations/Construction Engineer, the Fabrication Inspector, the Region Signal Superintendent, and the Contractor, who will forward to the Fabricator. See the Shop Plans and Working Drawings Table in [Section SS 1-05.3](#).

All drawings shall be clearly marked ([See SS 1-05.3](#)) before returned to the Contractor, whether reviewed and checked by the Project Engineer or the Bridge and Structures Office.

### **SS 8-20.3 Construction Requirements**

#### **SS 8-20.3(4) Foundations**

The foundations shall be located and constructed as detailed on the plans wherever possible. When foundations cannot be constructed as detailed, due to rock, bridge footings, drainage structures, or other obstructions, an effective foundation will have to be developed for the conditions encountered and acceptance obtained. The location of lighting standards or signal standards shall not be moved without discussing the problem with the Regional Operations/Construction Engineer and the Regional Traffic Engineer.

Foundations located on fills, especially those adjacent to bridge abutments, shall be deepened to provide stability as provided for in *Standard Specifications* Section 8-20.3(4).

#### **SS 8-20.3(5) Conduit**

Generally, conduit runs should be located on the outer shoulder areas, well away from the position where signs, delineators, guardrails and other facilities will be placed.

On new construction, all conduit located under paved surfaces shall be placed prior to construction of base course and pavement. It shall be the responsibility of the Project Engineer to see that all contractors on any project coordinate their work to this end.

Sufficient cover must be provided to protect the conduit from damage as provided in *Standard Specifications* Section 8-20.3(5).

At locations where plastic conduit is allowed and hard rock is encountered within the minimum depth required, steel conduit should be substituted for the affected runs, and the depth adjusted as necessary.

#### **SS 8-20.3(5)B Conduit Type**

##### **SS 8-20.3(5)B1 Rigid Metal Conduit**

Installation of conduit should be supervised to ensure against physical abrasion of the conduit or for rust on threads which would destroy the integrity of the galvanizing.

Electrically caused corrosion of metallic conduit is easy to avoid by proper construction supervision. If the causes of this type of corrosion are not properly inspected and controlled, the extent of electrically caused corrosion is commonly far more severe than the chemically caused corrosion.

In any metallic conduit system, the metallic conduit itself serves an electrical function. This function is to provide a low resistance return path for electricity which may leak out of an electrical conductor due to scraped insulation, cracks, or other causes. A point at which electricity can leak or escape from an electrical wire is called a "fault". When electricity flows through any non-insulated path (conduit), it can establish an electrical phenomenon called electrolysis. Electrolysis results in the transfer of metal from one location to metal at another location. Through this means, the metal that was used to make the metallic conduit may be transferred to other locations on the same conduit run or to other metallic appurtenances. With the ultimate degeneration of conduit at any point, the return path for the electricity through the conduit system itself is destroyed. In the event that a portion of a conduit was destroyed in this means and with the subsequent damage or failure of electrical conductors beyond that point, electricity would not have the ability to complete the circuit from the wire through the conduit system

and return to service enclosure which would, in turn, cause a fuse to blow or a circuit breaker to trip. Hence, the protection offered by our electrical overload equipment is totally nullified.

To prevent this type of ultimate failure of the electrical system, all conduit joints should be carefully inspected to ensure that they are physically tight and that a good electrical bond does exist from one piece of conduit through the nipple to each adjoining piece of conduit. Additionally, conduit threads should be painted with an accepted corrosion inhibiting conduit paint. Any loose or improper union between conduit sections or conduit and junction boxes is a point of high resistance to the flow of electricity. When such a condition exists and with the faulting of an electrical conductor within the system, electricity does not have an easy return to its point of service. Electricity then takes alternate routes through the earth, structures, etc. This, in particular, establishes the condition of electrolysis and results in even greater failure of the physical system. The physical system failure attributed to this may present itself from two to five years after construction.

The seriousness of this matter cannot be overstressed in electrical construction. It is so important that if one factor, and only one factor, was to be examined on each electrical project, it would be the search for conditions that would result in electrolysis and the sloppy workmanship that causes them.

Additionally, to prevent electrical damage to the conduit system and, in particular, during the time of project construction, the conduit shall not be used as a temporary neutral return nor shall the conduit be used for the ground of construction equipment, i.e., welders, hand tools.

### **SS 8-20.3(5)B2 Conduit Plowing**

Prior to installation, conduit shall be inspected for damage and deformities. For High Density Polyethylene (HDPE) conduit, this shall be done while the conduit is still on the reel. The inspector also needs to verify that HDPE conduit meets the thickness requirements in the Contract (examples: Schedule 80; SDR 9).

The inspector should verify that the plow shoe is marked as required by *Standard Specifications* Section 8-20.3(5)E2. The inspector should monitor the plow operation to ensure that the mark remains below ground for the entire run. Should the mark come above ground, required actions are defined in *Standard Specifications* Section 8-20.3(5)E2. Spot checks of conduit depth are recommended. The most effective method for verifying conduit depth is continuous monitoring of the plow shoe during the plowing operation. The plow trench tends to cave in behind the plow, making measurement after placement difficult.

### **SS 8-20.3(6) Junction Boxes, Cable Vaults, and Pull Boxes**

In most designs, precast concrete junction boxes are being used. These boxes are simple to install. A sump is excavated and partially filled with gravel. The open-bottom box is then seated by working it into the gravel until the required grade is reached. Care must be taken in junction box location to provide for drainage. Junction boxes and conduit should be placed away from areas that water is funneled to prevent it from entering into the conduits. For example, the bottom of ditches, sag vertical curves should be avoided or other low spots where water is likely to collect.

**SS 8-20.3(8) Wiring**

An electrical system is only as good as its conductors, terminals and splices, and it is important that the requirements of *Standard Specifications* Section 8-20.3(8) be strictly adhered to. If there is any doubt concerning the adequacy of a connector, the advice of the Regional Electrical Inspector should be obtained.

Practically all wiring for traffic signal and illumination systems is exposed to the elements, and it is very important that all splices be insulated with waterproof material, as prescribed in *Standard Specifications* Section 8-20.3(8) and 9-29.12.

**SS 8-20.3(9) Bonding, Grounding**

Because of the hazards of electrical shock, all grounds and ground bonds referred to in the plans and in the special provisions should be given special attention to ensure their effectiveness and completeness. See *Standard Specifications* Section 8-20.3(9) and *Standard Plan for Typical Grounding Detail*.

**SS 8-20.3(10) Service, Transformer, and Intelligent Transportation System (ITS) Cabinets**

Generally, Type "B," "C," "D," and "E" service cabinets etc., will be factory assembled from drawings submitted with the material lists. Type "A" service equipment will be assembled in the field. Care shall be taken to ensure compliance with all provisions of the plans and specifications, and to determine that all bonds and grounds are complete.

**Relations With the Serving Utility**

Generally, during the design of an illumination or traffic signal system, the serving utility is consulted concerning the availability of power, the voltage needed, the location of the most convenient point of service, and agreements are prepared prior to the awarding of the contract. The Project Engineer should review all utility agreements and contact the serving utility as soon as the Contractor commences work to arrange for the actual service connections and other work which may have been agreed upon. The matter is important since, in many cases, the utility will have to extend lines, install transformers, and do other related work. Upon completion of the contract, the Project Engineer will instruct the serving utility to direct all future billings to the appropriate maintenance division.

**Electrical Safety Tags**

Commencing at the time that the serving utility makes the power drop to WSDOT electrical service cabinets, electrical safety tags shall be used. Any electrician working on any main or branch circuit shall cause that circuit to be de-energized and shall place an electrical safety tag at the point that the circuit is open. The electrician shall sign the electrical safety tag and only that electrician may make subsequent circuit alterations or remove the tag.

If the circuit that the electrician de-energized to work on is serving traffic, the electrician shall arrange the work so the circuit may be energized for nighttime operation. The electrician shall remove the safety tag and energize the circuit before leaving the jobsite and upon returning to work on the circuit, shall de-energize it again and place an electrical safety tag back on the circuit.

**SS 8-20.3(11) Testing**

All illumination and traffic signal systems shall be tested as outlined in *Standard Specifications* Sections 8-20.3(11) and 8-20.3(14)D. Particular care shall be taken in the performance of test No. 3. The Project Engineer shall insure that readings of the megohmmeter taken on every electrical circuit are furnished to the Regional Electrical Inspector. Caution must be exercised in the performance of this test to protect control mechanisms from damage due to the nature of the test voltages used. Also, the records made of this series of tests must identify the readings observed with each branch of the electrical circuit involved. Representative sampling of the Contractor's test readings may be made by the Electrical Inspector using State test equipment.

Field Test No. 4 of *Standard Specifications* Section 8-20.3(11) is to be performed on all illumination and signal projects. It is especially important that the Project Engineer obtain the consultation of the Regional Traffic Engineer in this portion of the field test when the tests are being performed in a traffic signal controller. Since the mechanism in these controllers is so interrelated and complex, only persons thoroughly schooled in such control mechanisms are qualified to determine when particular timing circuits and sequences are functioning properly. The simple turning on of an electrical switch and watching a light come on is not an acceptable electrical test.

**SS 8-20.3(13) Illumination Systems****SS 8-20.3(13)A Light Standards**

In erecting lighting standards or signal standards, rope or fabric slings should be used to reduce the danger of damage to galvanized or finished aluminum surfaces.

**Existing Illumination Systems**

Where existing illumination or traffic signal systems are to be removed, and the material stockpiled at the site of the work for delivery to WSDOT, it will be advantageous if prior arrangements are made to have Department personnel meet the contractor at the delivery storage site. These arrangements should be made with either the Regional Maintenance Engineer or the Regional Traffic Engineer.

**Existing Communication Conduit Repair**

When existing communication conduits are likely to be encountered during construction, the contractor should be prepared to immediately restore any communication conduit and cables damaged by the contractor's activities. This includes all types of conduit, including those with innerduct, and electrical and/or fiber optic cables.

When existing communication conduits are present within the project work area, the Engineer should coordinate a meeting between the contractor and WSDOT Maintenance personnel to develop a pre-approved repair procedure for damaged communication conduits and cables. This plan should include the method of repair, how long the repair would take, and the availability and type of repair kit to be used.

Communication conduit damaged during the work shall be repaired with an approved manufactured repair kit appropriate for the size and type of conduit. The repair kit shall be provided by the contractor.

Replacement communication conduit and cable shall be subject to the acceptance requirements of the appropriate *Standard Specifications*.

Damaged communication conduit and communication cables shall be repaired and the communication system shall be fully operational within 24 hours of being damaged. Temporary splices or repairs may be accepted in order to restore operation; however any temporary repairs that do not meet the requirements of the *Standard Specifications* shall be removed and replaced with permanent repairs in accordance with the *Standard Specifications*.

### **SS 8-20.3(14) Signal Systems**

Traffic signal systems are a very specialized type of work. All work shall be done in strict accordance with the plans, the special provisions, and the *Standard Specifications*. The Regional Traffic Engineer will be responsible for the proper timing of each signal installation and will assist the Engineer in any way needed to ensure the proper completion of the work. The checklist (Figure 8-1) is provided to assist the Project Engineer in identifying the specific tasks that must be completed prior to signal turn-on. This checklist is a guide, and line items may be added or deleted as necessary to fit each specific signal installation.

### **SS 8-20.3(17) "As-Built" Plans**

The Project Engineer is required to submit As-Built Plans in accordance with Section 10-3.7. For proper maintenance and repair of the electrical system, it is imperative that the location of all conduits and the diagram of all circuits be properly shown on the AsBuilt Plans.

Normally, the conduits should be constructed in the locations shown on the contract plans. Many times these conduits are positioned in a particular place to eliminate conflict with future construction.

*Standard Specifications* Section 8-20.3(17) requires the Contractor to submit any corrected shop drawings, schematic circuit diagrams or other drawings necessary to prepare the corrected as-built plans.

### **GEN 8-20.6B1 Conduit Plowing**

Prior to installation, conduit shall be inspected for damage and deformities. For High Density Polyethylene (HDPE) conduit, deformities are usually visible while conduit is still on the reel. The inspector also needs to verify that HDPE conduit meets the thickness requirements in the Contract (examples: Schedule 80; SDR 9).

The inspector shall verify that the plow shoe is marked for the required depth as required by *Standard Specifications* Section 8-20.3(5)E2. The mark must remain below ground for the entire run. Should the mark come above ground, required actions are defined in *Standard Specifications* Section 8-20.3(5)E2. Spot checks of conduit depth are recommended. The recommended method for verifying conduit depth is continuous monitoring of the plow shoe during the plowing operation. The plow trench tends to cave in behind the plow, making measurement after placement difficult.



**8-20.6D Wire and Cable**

An electrical system is only as good as its conductors, terminals and splices, and it is important that the requirements of *Standard Specifications* Section 8-20.3(8) be strictly adhered to. If there is any doubt concerning the adequacy of a connector, the advice of the Regional Electrical Inspector should be obtained.

Practically all wiring for traffic signal and illumination systems is exposed to the elements, and it is very important that all splices be insulated with waterproof material, as prescribed in *Standard Specifications* Section 8-20.3(8) and 9-29.12.

Wire and cable pulling, including fiber-optic cable, requires the use of a dynamometer in accordance with *Standard Specifications* Section 8-20.3(8) to verify cable tension. Wire and cable pulling by means other than by hand shall not be allowed without a dynamometer present.

Figure 8-1 Traffic Signal Turn-on Checklist Revised 1/10/00 (Page 1 of 2)

Contract #: \_\_\_\_\_ Location: \_\_\_\_\_

Project Engineer: \_\_\_\_\_ Date: \_\_\_\_\_

Proposed\* turn-on date: \_\_\_\_\_ Proposed\* test date: \_\_\_\_\_

Point of contact: \_\_\_\_\_ Phone Number: \_\_\_\_\_

**This checklist highlights the critical items of work that are to be complete before the signal system can be placed into operation.**

\*The Project Engineer has the authority to reschedule the test date or signal turn-on at their discretion.

	Applicable to project	Complete
<b>Signaling</b>		
1. Advance warning "Signal Ahead/W3-3" signs (permanent)		
2. "New Signal" or "Signal Revision" signs (temporary)		
3. "Left Turn Must Yield on Green Ball" sign		
4. Lane control signs		
5. Street name signs		
<b>Striping (Installed or scheduled)</b>		
6. Stop Bar(s)		
7. Crosswalk stripes		
8. Channelization		
9. Channelization aligns with signal heads		
<b>Signal Display System</b>		
10. All vehicle displays are connected and tested		
11. All pedestrian displays are connected and tested		
12. Restrictive left turn display is over left turn lane		
13. Combination of restrictive/permissive left turn display is over the gore stripe.		
14. Optically programmed displays are properly programmed for the intended movement.		
15. Vertical clearances are met.		
<b>Signal Detection System</b>		
16. All vehicle detection (temporary and permanent) is tested.		
17. If staging is required, all side street stop bar detection is tested as a minimum for semi actuated operation.		
18. All pedestrian detection (push buttons) are tested.		
19. All emergency vehicle preemption detection are tested.		
20. Railroad preemption is tested.		

Figure 8-1 Traffic Signal Turn-on Checklist Revised 1/10/00 (Page 2 of 2)

	Applicable to project	Complete
<b>Signal Control System</b>		
21. Controller is tested and available		
22. Cabinet is installed, wired and ready for controller hookup.		
23. Interconnect is tested.		
24. Permanent power source is supplied to the system.		
<b>Contractor Contact Responsibilities</b>		
25. Controller manufacturer representative (not required if state supplied controller)		
26. Uniformed Police/State Patrol for Traffic Control		
<b>Electrical Inspector Contact Responsibilities (Five (5) days prior to proposed* signal test date)</b>		
27. Signal Maintenance		
28. Signal Operations		
<b>Project Engineer Contact Responsibilities (Five (5) days prior to proposed* signal test date)</b>		
29. Local Agencies (City, County, State Patrol, Fire District, etc.)		
Comments:		

## 8-21 Permanent Signing

### GEN 8-21.1 General

The complex design of today's freeway facilities has created an increased demand on signing. Signing is one of the features a layperson readily can evaluate on a new facility. Improper or inadequate signing detracts from the quality of the basic construction features of the project. Misplaced or irregular usage of signs on interchanges creates a critical hazard to traffic and hinders the proper operation of the facility.

Today's destination sign has increased in size to the extent that it is no longer a minor installation and the amount of time required to install an average freeway sign project has been extended to the point that close cooperation between all forces on highway construction projects is vital so that the facility is signed properly when opened to traffic.

Any sign that is erected on a section of roadway carrying traffic ahead of the time the message on the sign will be applicable to the traffic shall be covered in accordance with *Standard Specifications* Section 8-21.3(3) until the appropriate time for uncovering it. It is essential that signs with conflicting messages not be displayed.

### SS 8-21.2 Materials

All materials for installation on permanent signing projects should be selected off the *Qualified Products List* (QPL) or listed on the Request for Approval of Materials (RAM). Materials listed on RAM which are not listed on the QPL shall be submitted to the State Materials Laboratory for appropriate action as soon as possible. This list shall be complete and cover all materials which are identified on the plans or in the specifications. The list shall include the source of supply, name of manufacturer, size and catalog number of the units, and shall be supplemented by such other data as may be required including catalog cuts, detailed scale drawings, wiring diagrams of any nonstandard or special equipment. All supplemental data shall be submitted in accordance with [Section 1-05.3](#).

### SS 8-21.3 Construction Requirements

#### SS 8-21.3(1) Location of Signs

Since it is impossible to visualize the actual physical features of final grade elevations, vertical curves, trees, and other factors that affect proper sign placement in the initial sign plan stage, it becomes necessary to make adjustments in sign location just prior to installation. The Project Engineer and Regional Traffic Engineer should coordinate a study of each location to determine that each sign will be in the most efficient location for visibility and nighttime reflectivity. Advance Destination signs may be moved up to 500 ft in either direction if severe ground or slope conditions are encountered. If the sign must be moved more than 500 ft, consideration should be given to revising the distance on the sign. All sign locations shall be staked by the Engineer prior to installation by the Contractor.

Following staking of the signs, the Project Engineer should furnish the Contractor with the list of post lengths for steel posts. For wooden posts, the Contractor should be able to order posts in commercial lengths from the approximate lengths shown in the plans. Final lengths of timber posts will be determined or verified by the Engineer at the request of the Contractor prior to fabrication.

**SS 8-21.3(2) Placement of Signs**

A “fabrication approval” decal dated and signed by the Sign Fabrication Inspector shall appear on the back of all permanent signs that are received on the project. Signs without such indicated acceptance shall not be permitted on the project. Damaged signs shall be rejected at the project site.

At the completion of a sign installation, the Project Engineer shall request the Regional Traffic Engineer to assist in making a final inspection.

**SS 8-21.3(9) Sign Structures****SS 8-21.3(9)A Shop Drawings for Sign Structures**

Working drawings of sign structures shall be reviewed by the Project Engineer for conformance with the *Standard Plans* Section G. The Project Engineer approves plans in conformance with the standard plans. Any request to deviate from standard plans should be reviewed by the State Bridge and Structures Office.

The working drawings of special design sign structures and/or special sign fittings shall be submitted to the State Bridge and Structures office, which will coordinate approval with the State Materials Laboratory. After approval, the State Bridge and Structures office will retain one set and forward the approved PDF file to the Project Office. The Project Engineer will forward the approved PDF file to the Fabrication Inspector, the Region Signal Superintendent (or designate), and the Contractor, who will forward to the Fabricator.

If a structural review is not required by the State Bridge and Structures office, the Project Engineer shall mark all changes in red on a PDF and distribute in accordance with the Working Drawings, Shop Plans, or Submittal Type in [Section SS 1-05.3](#).

All drawings shall be clearly marked (See [SS 1-05.3](#)) before returned to the Contractor, whether reviewed and checked by the Project Engineer or the State Bridge and Structures Office. The Project Engineer is responsible for checking the geometric features of these items. Specific items that should be checked include the following:

- Foundation Location
- Handrail fitup with VMS Door Opening

The special provisions of the contract deal to a great extent with the proper fabrication of the signs to be installed and the manufacturing process requiring the use of approved application equipment. It is necessary, therefore, that the firm who actually makes the signs be approved as a source of supply. Such approval is made by the State Materials Laboratory.

**SS 8-21.3(9)G Sign Structure Identification Information**

Anytime an existing bridge mounted sign bracket, cantilever sign structure, or sign bridge structure is removed from service, the Contractor shall remove any existing sign structure identification plate and give it to the Project Engineer. The Project Engineer will return the identification plate to the State Bridge Preservation Office so the sign structure can be removed from the inventory.

**SS 8-21.3(12) Steel Sign Posts and Structures**

It is important to ensure the proper torque is applied to bolts connecting the bases when installing Standard Plan G-24.10.00 through G-24.60.00 Sign Structures. Procedures for assembling and inspecting high strength bolts are covered in Section 6-3.6B. All base assemblies shall be checked with a torque wrench. This can be accomplished either by observing the Contractor's torquing or by the Inspector utilizing the Region's torque wrench. Documentation of the torquing method used should be accomplished by proper entries in the Inspector's Daily Reports.

## 9-1 General

The quality of materials used on the project will be evaluated and accepted in various ways, whether by testing of samples, visual inspection, or certification of compliance. This chapter details the manner in which these materials can be accepted. Requirements for materials are described in *Standard Specifications for Road, Bridge, and Municipal Construction* M 41-10 Section 1-06 and Division 9.

The State Materials Engineer is responsible for the state's materials approval and acceptance program, and the Quality Assurance Program. Any changes or deviations to the approval or acceptance of materials, or the Quality Assurance Program beyond what is allowed in this chapter will require approval from the State Materials Engineer or the Assistant State Materials Engineer. The State Materials Engineer can issue changes via memorandums or emails that amend and replace the directions and policies in [Chapter 9 Materials](#) as well as materials approval, acceptance and Quality Assurance Program policies and directions in this manual to address unforeseen issues.

It is the Project Engineer's responsibility to accept materials in accordance with this chapter. For materials that do not meet specification requirements, the Project Engineer shall contact the State Construction Office which will coordinate with the State Materials Engineer or Assistant State Materials Engineer to determine the appropriate action.

### 9-1.1 ***PE Authority for Materials Approval and Acceptance***

This chapter covers the Project Engineer's authority to approve and modify the acceptance of certain materials while maintaining normal approval and acceptance by the State Materials Laboratory and Region. The use of these processes mentioned within this Section are to be implemented prior to work being performed and not to retroactively justify deficiencies discovered after the completion of work, with the exception that Reducing Frequency of Testing is implemented during the work. It is recommended that the Project Engineer office review the original Record of Materials to determine if items can be modified within the guidelines of this section. The Record of Material should be actively maintained per [Section 9-1.2C](#). Materials accepted in accordance with these options shall be identified in the Project Engineer's preparation of the Certification of Materials under [Section SS 1-09.12](#), Audits.

The options that are available to the Project Engineer for approving and modifying the acceptance of materials are the following sections:

- [Section 9-1.1A](#) Sampling and Testing for Small Quantities of Materials
- [Section 9-1.1B](#) Reducing Frequency of Testing
- [Section 9-1.1C](#) Project Engineer Discretionary Materials Approval/Acceptance
- [Section 9-1.1D](#) Optional Approval/Acceptance for Materials

The Reduced Acceptance Criteria Checklist DOT Form 350-120 shall be completed and retained in the materials file when Reducing Frequency of Testing, Sampling and Testing for Small Quantities of Materials and Project Engineer Discretionary Materials Approval/Acceptance are invoked. All information requested on the checklist shall be filled in completely. Any items that do not require approval from the State Materials Laboratory and the State Construction Office may be approved at the Project Engineer level.

For approval of changes beyond the Project Engineer's authority (items marked with a "yes" and an "x" on DOT Form 350-120), a request must be transmitted to the State Materials Laboratory and may require approval from the State Construction Office as well. The completed checklist shall accompany the request and represents the minimum information required to process the modification. The State Materials Laboratory and the State Construction Office have final authority to approve or reject any request for modification. Written approval by the State Materials Laboratory and State Construction Office constitutes agreement with the proposal. The signed checklist and all supporting documentation are to be placed in the project Materials File.

For approval contact the following:

- **State Materials Laboratory** – Areas of responsibility: All changes to materials approval and acceptance, and to *Standard Specifications* Division 9. Initial contact: Materials Quality Assurance Engineer
- **State Construction Office** – Areas of responsibility: *Standard Specifications* Divisions 1, 2, 3, 4, 5, 6, 7, 8, 10, and 11.

### 9-1.1A Sampling and Testing for Small Quantities of Materials

The Project Engineer may elect to accept small quantities of materials without meeting minimum sampling and testing frequencies using the following criteria. The use of this process is to be implemented prior to work being performed and not to retroactively justify deficiencies discovered after the completion of work.

An item can be accepted as a small quantity if the proposed quantity for a specific material is less than the minimum required testing frequency

Materials that will not be considered under the small quantity definition are:

- Concrete with a 28-day compressive strength of 4000 psi or greater.

Some issues that the Project Engineer may consider prior to use of small quantity acceptance are:

- Has the material been previously approved?
- Is the material certified?
- Do we have a mix design or reference mix design?
- Has it been recently tested with satisfactory results?
- Is the material structurally significant?

Small quantity acceptance could be visual, by certification, or other methods and the basis of acceptance shall be documented on DOT Form 350-120. For visual documentation, an entry should be made in the project records as to the basis of acceptance of the material, and the approximate quantity involved.

The small quantity acceptance may be used for any quantity of the following:

- Curbs and sidewalks
- Driveways and road approaches
- Paved ditches and slopes

Where jobsite mixing of concrete occurs in accordance with *Standard Specifications* Section 6-02.3(4)B small quantity acceptance can be used for acceptance of packaged concrete meeting the requirements of ASTM C 387. The packaged concrete bag must state that the concrete meets the requirements of ASTM C 387.



### 9-1.1B Reducing Frequency of Testing

Reducing the frequency of testing of materials is intended for WSDOT projects with a high volume of materials. In instances of uniform material production where the statistical acceptance testing data shows the material is running well within specification limits deviations from the testing frequency schedule may be instituted. Sampling frequency reduction may be considered only after ten consecutive samples taken at the normal testing frequency indicate full conformance with the specifications. The sampling and testing frequency will revert back to the normal frequency if there are any failing tests. The use of this process is to be implemented prior to work being performed and not to retroactively justify deficiencies discovered after the completion of work.

The Statistical Analysis of Materials (SAM) program will be utilized to develop and support approvals to reduce testing frequency and/or to eliminate selected test properties. Testing on selective materials may be reduced or eliminated without statistical data on select material, for example selective relief would be reduction/elimination of fracture determinations and sand equivalent testing for production from quarry sources.

All deviations from the testing frequency must be documented in the project records, and fully explained by the Project Engineer. Lack of personnel, equipment, and facilities will not be considered sufficient reasons for such deviation.

The authority given below to approve deviations to testing frequencies shall not be subdelegated within the regions.

- The Project Engineer, licensed as a Professional Engineer in the State of Washington, may initiate and approve up to 10 percent deviations from the testing frequency schedule. The Project Engineer does not have the authority to reduce sampling frequencies for the following materials: Hot Mix Asphalt, Warm Mix Asphalt, Structural Concrete and Cement Concrete Pavement.
- The Region Materials Engineer, licensed as a Professional Engineer in the State of Washington, may approve requests from project engineers for an additional 10 percent deviation from the testing frequency schedule. The Region Materials Engineer does not have the authority to reduce sampling frequencies for the following materials: Hot Mix Asphalt, Warm Mix Asphalt, Structural Concrete and Cement Concrete Pavement.
- Elimination of fracture and/or SE from a Quarry Site requires approval from the Region Materials Engineer. Elimination of any other testing will require approval of State Materials Engineer or the Assistant State Materials Engineer.
- Request for sampling frequency deviations exceeding the Project Engineer and Region Materials Engineer reduction authority requires approval from the State Materials Engineer or the Assistant State Materials Engineer.
- Request for sampling frequency deviations for Hot Mix Asphalt, Warm Mix Asphalt, Structural Concrete and Cement Concrete Pavement require approval from the State Materials Engineer or the Assistant State Materials Engineer.

A copy of all testing frequency deviations with substantiating data approved by the Project Engineer and/or the Region Materials Engineer will be sent to the State Materials Engineer.

### 9-1.1C Project Engineer Discretionary Materials Approval/Acceptance

In advance of or during the course of the project, in the interest of economy and efficiency, noncritical items of work may be identified for which the Project Engineer is allowed to approve the Request for Approval of Material (RAM), and may choose to modify the normal inspection or testing procedures. In taking these actions, the Project Engineer is acting under the professional responsibility inherent in all actions as a representative of the department and as a Licensed Professional Engineer. Full accountability of such actions is expected. The scope of such actions should not exceed \$20,000 for a single bid item, nor exceed \$50,000 for an entire project. Approval above these dollar amounts requires approval from the State Materials Engineer or Assistant State Materials Engineer and the State Construction Office. The use of this process is to be implemented prior to work being performed and not to retroactively justify deficiencies discovered after the completion of work.

The nature of the work to be accepted in this manner will generally be limited to minor and isolated items. Acceptance would typically involve dimensional conformance to the plans and a visual determination that the materials are suitable; however, the Project Engineer may require some testing or other means to support a decision. In such an action, the Project Engineer should be guided by the principle of achieving the intent of the contract, attaining reasonable expectations of service life proportional to cost, and protection of public safety. The changes in acceptance procedures will only be made to work occurring outside of vertical lines through the horizontal limits of the traveled way. Consideration should be given to the consequences of subsequent failure, ease of replacement, whether or not there is a high variability in the quality of similar work, or any other pertinent facts. Actions taken in accepting such materials should be identified in the project records with acknowledgment by signature of the Project Engineer, licensed as a Professional Engineer in the State of Washington.

### 9-1.1D Optional Approval/Acceptance for Materials

The materials listed in [Table 9-1](#) may be accepted by visual acceptance at the option of the Project Engineer. The Project Engineer can test or require additional documentation for any of the materials in this section if quality appears to be in question per *Standard Specifications* Section 1-06.1. Visual acceptance requires field verification per [Section 9-1.5](#), unless additional documentation is stipulated in the Contract documents. The use of this process must be implemented prior to Work being performed and not retroactively to justify deficiencies discovered after the project is complete.

The Project Engineer is allowed to approve the Request for Approval of Material (RAM). If there is a question on the quality or ability of the material to perform its intended use, it is the responsibility of the Project Engineer to determine if it is appropriate to accept the materials by visual acceptance or if additional acceptance testing or certification is required. This includes contacting Headquarters or the Region subject matter expert for assistance to determine if additional acceptance testing or certification is required for a material.

Other items can be considered for addition to this list. Suggestions are encouraged and may be made to the State Construction Office or the Materials Quality Assurance Engineer at the State Materials Laboratory.

Material approved under this authority is subject to Buy America and/or Build America/ Buy America (BABA) requirements when included in the Contract or by Special Provision.

Figure 9-1 Reduced Acceptance Criteria Checklist DOT Form 350-120



**Washington State  
Department of Transportation**

### Reduced Acceptance Criteria Checklist

This checklist is required to be filled out for individual materials and be put in the Materials File.

If the material is listed in the CM Section 9-1.3C - 'Low Risk Materials' or this material qualifies for Visual Acceptance per 9-1.4C, then **you do not need to proceed with this form.**

Contract Number	Contract Title	Date	
Bid Item Number	Plan Quantity	Material Description	
<b>Description of Change to Materials Acceptance:</b> Explain the work being performed and the proposed changes to the normal materials acceptance, and/or inspection criteria. Explain why this is being proposed, what is the justification for the change, is this a 'critical' item of work and has proper approval (RAM/QPL) been performed?			
Acceptance Criteria per RAM/QPL		Proposed Acceptance Criteria	
R = Region Materials Engineer M = State Materials Engineer/Asst. State Materials Engineer C = State Construction Office		Yes	No
		Required Approvals	
<b>I. Sampling and Testing for Small Quantities of Material (CM 9-1.1A)</b>			
Is the proposed quantity greater than the minimum required frequency?		<input type="checkbox"/>	<input type="checkbox"/>
		STOP If 'Yes'	
For concrete, is the concrete CI 4000 psi or greater?		<input type="checkbox"/>	<input type="checkbox"/>
		STOP If 'Yes'	
Is the material structurally 'significant'?		<input type="checkbox"/>	<input type="checkbox"/>
		M	C
<b>II. Reduce Frequency of Testing: (CM 9-1.1B)</b>			
Is the material running well within specification limits?		<input type="checkbox"/>	<input type="checkbox"/>
		STOP If 'Yes'	
Have ten consecutive samples been taken at normal frequency that indicate complete conformance within specification requirements?		<input type="checkbox"/>	<input type="checkbox"/>
		STOP If 'Yes'	
Is the proposal for deviation greater than 10% and less than 20%?		<input type="checkbox"/>	<input type="checkbox"/>
		R	
Is the proposal for deviation greater than 20% or elimination of test?		<input type="checkbox"/>	<input type="checkbox"/>
		M	
For Quarry Sites, is 'fracture' being eliminated?		<input type="checkbox"/>	<input type="checkbox"/>
		R	
<b>III. Project Engineer Discretionary Materials Acceptance (CM 9-1.1C)</b>			
Is the work 'within' the vertical limits of the roadway?		<input type="checkbox"/>	<input type="checkbox"/>
		M	C
Is the dollar amount over \$20,000 for this Bid Item? \$		<input type="checkbox"/>	<input type="checkbox"/>
		M	C
Is the total dollar amount over \$50,000 for the entire project? \$		<input type="checkbox"/>	<input type="checkbox"/>
		M	C

Attach email concurrence if used.

<b>Approvals</b>	
Project Engineer Approval By: _____	Date: _____
Region Materials Laboratory: _____	Date of Concurrence: _____
State Materials Engineer/Asst. State Materials Engineer: _____	Date of Concurrence: _____
State Construction Office: _____	Date of Concurrence: _____

Distribution:  Region Materials Lab  State Materials Engineer  State Construction Office

DOT Form 350-120  
Revised 12/2020

**Table 9-1 Optional Approval/Acceptance for Materials**

Material	Standard Specifications Reference	Construction Manual Section 9-4
Access Control Gate	Std. Plan L-70.10 & L-70.20	
Adhesive for Girder Stop Pads	Special Provision	
Agricultural Grade Dolomite Lime	9-14.5(5)	
Agricultural Grade Gypsum	9-14.5(6)	
Air Relief Valve	9-15.16	9-4.49
Anchor Bars for Extruded Curb	Std. Plan F-10.42	
Asphalt Primer & Adhesive for Deck Seal Membrane	Special Provision	
Automatic Control Valves	9-15.7(2)	9-4.49
Automatic Control Valves with Pressure Regulator	9-15.7(3)	9-4.49
Automatic Controller	9-15.3	9-4.49
Bark or Wood Chips	9-14.5(3)	9-4.48
Barrier Delineator Adhesive	Special Provision	
Biodegradable Erosion Control Blanket	9-14.6(2)	9-4.80
Bollard Type 1 and 2	See Std. Plan for Bollards	9-4.95
Butyl Rubber	9-04.10	
Butyl Rubber Sealant	9-04.11	
Chain Link Gates	9-16.1(1)E	9-4.50
Check Dams	9-14.6(4)	9-4.80
Check Valves	9-15.12	9-4.49
Chemical Pesticides	8-02.3(2)A	
Coir Log	9-14.6(7)	9-4.80
Compost	9-14.5(8)	9-4.48
Compost Sock	9-14.6(6)	9-4.80
Concrete	9-16.1(1)F & 9-16.2(1)J	9-4.76
Concrete Block for Manholes and Catch Basins	9-12.1	9-4.48
Concrete Brick	9-12.2	9-4.98
Detectable Marking Tape	9-15.18	9-4.49
Detectable Underground Warning Tape	9-29.1(6)	
Drain Grate for Soil Nail Walls	Plan Sheet	
Drain Valves	9-15.9	9-4.49
Drip Tubing	9-15.2	9-4.49
Electrical Wire and Splices	9-15.17	9-4.49
Expanded Polystyrene	9-04.6	
External Sealing Band	9-04.12	
Fertilizer	9-14.4	9-4.47
Fittings and Hardware	9-16.1(1)D	9-4.50
Foam Backer Rod	9-08.8	
Flow Control Valves	9-15.15	9-4.49
Galvanized Pipe and Fittings (Irrigation System)	9-15.1(1)	9-4.49
Galvanizing Repair Paint (Fence)	9-08.1(2)	9-4.35
Gate Valves	9-15.6	9-4.49
Hose Bibs	9-15.10	9-4.49
Hydraulically Applied Erosion Control Products (HECPs)	9-14.5(2)	9-4.48
Inlet Protection	8-01.3(9)D	9-4.80
Irrigation Heads	9-15.4	9-4.49
Log Weirs and Root Wads with associated hardware	Special Provisions	
Loop Sealant for Induction Loop	Special Provision	

**Table 9-1 Optional Approval/Acceptance for Materials**

Material	Standard Specifications Reference	Construction Manual Section 9-4
Mailbox Support Type 3	Std. Plan H-70.30	
Manual Control Valves	9-15.7(1)	9-4.49
Miscellaneous Fence Hardware	9-16.2(1)H	9-4.50
Mortar Blocks (Dobies)	6-02.3(24)C	9-4.29
Nitrile Rubber	9-04.10	
Pipe, Tubing, and Fittings (Irrigation System)	9-15.1	9-4.49
Pipe Hanger	Std. Plan J-90.10, J-90.20, & J-90-21	
Plants	9-14.6(1)	9-4.44
Plastic Covering	9-14.6(3)	
Polyacrylamide (PAM)	9-14.6(1)	9-4.80
Polyethylene Pipe (Irrigation System)	9-15.1(3)	9-4.49
Single Component Polyurethane Sealant	9-04.2(3), 9-08.7, & 6-07.3(10)G	9-4.35
Polyvinyl Chloride Pipe and Fittings (Irrigation System)	9-15.1(2)	9-4.49
Premolded Joint Filler	9-04.1(1) & 9-04.1(2)	9-4.12
Prepackage Concrete	6-02.3(4)B	9-4.76
Prepackage Mortar Type 2	9-20.4(3)	9-4.81
Pressure Regulating Valves	9-15.13	9-4.49
Quick Coupling Equipment	9-15.8	9-4.49
Rebar Chairs and Spacers	6-02.3(24)C	9-4.29
Riprap and Quarry Spalls for Stabilized Construction Entrances	8-01.3(7)	9-4.42
Rock and Aggregate Material for Landscape Features	9-03 & 9-13	
Rust Penetrating Caulk	6-07.3(10)G	
Seed	9-14.3	9-4.46
Semi-Open Concrete Masonry Units (Slope Protection)	9-13.5(1)	9-4.43
Silt Fence and All Components	8-01.3(9)A	9-4.80
Site Furnishings (benches, trash, recycling, and ash receptacles, bike security stations and planters)	Special Provision	
Sod	9-14.7(4)	
Stakes, Guys, and Wrapping	9-14.8	9-4.49
Staples and Wire Clamps	9-16.2(1)D	9-4.50
Straw	9-14.5(1)	9-4.48
Tackifier	9-14.5(7)	9-4.48
Temporary Curb	8-01.3(14)	
Temporary Pipe Slope Drain	8-01.3(14)	
Three-Way Valves	9-15.14	9-4.49
Topsoil Type A	9-14.2(1)	9-4.45
Topsoil Type B	9-14.2(2)	9-4.45
Topsoil Type C	9-14.2(3)	9-4.45
Valve Boxes and Protective Sleeves	9-15.5	9-4.49
Vertical Cinch Stays	9-16.2(1)G	9-4.50
Wattles	9-14.6(5)	9-4.80
Weed Control (Herbicides)	8-02.3(2)	
Wire Fence and Gates	9-16.2	9-4.50 & 9-4.36
Wood Strand Mulch	9-14.5(4)	9-4.48
Wye Strainers	9-15.19	9-4.49

## 9-1.2 Control of Materials

The succeeding parts of this chapter outline the detailed method to be used in the control of materials. The expenditure made for materials is a large portion of construction costs. If faulty materials are permitted to be incorporated into the project, the cost of replacement may exceed the original cost.

[Section 9-2](#) Materials Fabrication Inspection Office – Inspected Items Acceptance explains the process for the acceptance of fabricated items, and the types of Fabrication acceptance markings used to identify approved fabrication items.

[Section 9-3](#) Guidelines for Job Site Control of Materials provides the engineer with additional information to assist in determination of the point of acceptance for materials from WSDOT and Contractor sources, the basis of acceptance, verification sampling and testing, and the sampling and testing frequency guide.

[Section 9-4](#) Specific Requirements for each Material provides specific requirements about each material that includes the following information:

1. Approval of Material
2. Preliminary Samples
3. Acceptance or Acceptance/Verification
4. Field Inspection
5. Specification Requirements
6. Other Requirements

[Section 9-5](#) Quality Assurance Program defines the requirements for the materials tester to become qualified. The requirements for the Independent Assurance Program are also included.

[Section 9-6](#) Radioactive Testing Devices explains policy on the administration of radioactive testing devices.

[Section 9-7](#) WSDOT Test Methods/Field Operating Procedures defines the testing procedures and lists the equipment that are used in the field.

### 9-1.2A Materials Management Computer Programs

There is a series of material management computer programs that have been developed to aid the Project Engineer office's in tracking, approving, accepting, and testing materials.

- Record of Materials (ROM) – A listing of the construction items that have been identified from the plans and specifications for each project. The ROM, which is organized by Bid Item - Sub Item, identifies the kinds and quantities of materials, the standard Acceptance Methods and the number of acceptance and verification samples required for each material that will be used on the project. It also lists the acceptance requirements for materials requiring other actions, such as fabrication inspection, manufacturer's certificate of compliance, shop drawings or catalog cuts. The ROM is also used to track material deficiencies and has various reports available for tracking materials documentation. The ROM is not a payment or purchasing document.

- Aggregate Source Approval (ASA) – A program that tracks aggregate sources, approvals and expiration dates for the different aggregate material types that could be used on a construction project. This application is designed to allow the user to query the database for the intended source of aggregate to be used, determine if it is approved, and print the ASA report.
- Qualified Product List (QPL) – A program that lists products that have been found capable of meeting the requirements of the *Standard Specifications* or General Special Provisions under which they are listed and, therefore, have been “Approved.” These may be “Accepted” in the field by fulfilling the requirements of the Acceptance Code and any notes that apply to the product.
- Statistical Analysis of Materials (SAM) – A program that is used for the statistical acceptance of materials according to *Standard Specifications* Section 1-06. The testing data will be kept electronically for quality and compliance audits and for historical references. The program will generate the reports showing the composite pay factors and project totals.
- Materials Testing System (MATS) – A testing program where all materials testing will be recorded. This includes the testing performed at the State Materials Laboratory, the Region Materials Laboratory, and the project office acceptance testing. The program will generate the transmittal, provide for tracking the samples throughout the testing process, and automatically bills for the testing performed. The program will also provide a report detailing the test results, and distribute the reports according to the established distribution list.

### 9-1.2B Materials Forms

A number of form letters have been prepared as an aid to the Project Engineer in transmitting information to the State Materials Laboratory. In order to minimize delays to completion of material testing, transmittal letters should include all the information that is pertinent to the sample in question. In order to assist the State Materials Laboratory, copies of the transmittal letters should be retained in the Project Engineers Office. The following is a list of the forms that may be used for transmittal of samples and/or information to the State Materials Laboratory:

350-016	Asphalt Emulsion Sample Label
350-023	Pit Evaluation Report
350-040	Concrete Mix Design
350-041	Request for Reference HMA Mix Design
350-042	HMA Mix Design Submittal
350-071	Request for Approval of Material
350-072	Transmittal of Catalog Cuts
350-073	Hot Mix Asphalt Test Point Evaluation Report
350-074	Field Density Test
350-092	Hot Mix Asphalt Compaction Report
350-115	Contract Materials Checklist
350-572	Manufacturer Certification of Compliance Check List
351-015	Daily Compaction Test Report
410-025	Project Engineer Transmittal

### 9-1.2C Record of Materials

The Record of Materials (ROM) is used to track material type, make/model, approval, acceptance, field verification documentation, Certificate of Materials Origin and other materials documentation. The ROM is organized by Bid Item – Sub Item and the program also tracks deficiencies and has various reports available for tracking documentation. The ROM is not a payment or purchasing document. The program is located at: <http://webapps.wsdot.loc/Materials/Tracking>

The Construction Materials - Materials Quality Assurance Section (MQAS) uploads the initial materials and acceptance criteria into the ROM shortly after the contract is awarded. This initial listing of materials identifies the types and planned quantities for all materials requiring acceptance. It further identifies the minimum number of acceptance and verification samples that would be required based on the Summary of Quantities.

The Project Office uses the ROM computer program to maintain the materials documentation information for each State Contract that is administered by that office except as follows. When the MQAS does not provide the initial upload of materials acceptance into the ROM, the Project Office is not required to use the ROM computer program. When an initial materials and acceptance criteria is not uploaded into the ROM by the MQAS, the Project Engineer may request the MQAS to set up a blank ROM template for the Project Office to populate, track, and maintain permanently incorporated materials, or the Project Engineer may utilize other documentation methods to track and document permanently incorporated materials that are placed on the Contract.

The Project Office utilizes the ROM program to track all permanently incorporated materials that are placed on the Contract. Temporary materials are also tracked in the ROM when the contract documents contain temporary material requirements. The Project Engineer is responsible for the accuracy of the ROM, other documentation methods used, and Certification of Materials. Acceptance requirements shown in the ROM can be modified by referencing the properly submitted QPL page or the approved Request for Approval of Materials. Reviewing the contract plans and provisions may identify additional materials documentation requirements as well as construction items that shall be added to the ROM and tracked for completion throughout the course of the project work.

In order to ensure clarity upon completion of the work and to allow for easy certification of the project by both the Project Engineer and the Region, the ROM needs to be maintained throughout the course of the project. “Maintained” and “maintain” means the ROM is updated to reflect materials placed within 30 calendar days of the material payment. This includes material type, make/model, approval, acceptance, field verification documentation, Certificate of Materials Origin and other materials documentation.

The Project Office is required to maintain the Status Work Completed (WC)/ Documentation Complete (DC) /Not Used (NU) fields in the ROM by Project Materials Certification per CM 9-1.2F.

The Project Office is required to maintain quantities paid, quantities placed, quantities field verified for materials that have sampling frequencies, WSDOT Fabrications Inspection items, where the Acceptance Criteria requires quantities such as Manufacturer Certificate of Compliance, or when quantities are noted in the initial materials and acceptance criteria. Any changes to the acceptance requirements, additional permanently incorporated materials used, or any additional materials added to the project by Change



Order or Force Account need to be documented and tracked either in the ROM or for Contracts that do not use the ROM program documented and tracked by other methods in the project records. A copy of the ROM Materials Documentation Report shall be included in the final records or if the ROM program is not used a copy of the documents used to track the above information shall be included in the final records.

The Project Engineer is encouraged to contact the MQAS for assistance with questions on materials documentation requirements.

### 9-1.2D Vacant

### 9-1.2E Certification of Materials Origin

**For Contracts Advertised Before January 11, 2016 - Contact the State Construction Office for Buy America Requirements**

**Contracts Advertised After January 11, 2016:**

#### **Buy America - Steel and Iron**

Buy America (23 CFR 635.410, 23 USC 313) requires that all steel or iron material permanently incorporated into the project are made in the United States for:

- Contracts that include federal funding in the construction phase, or
- Any project defined in the Federal Record Decision under the National Environmental Policy Act (NEPA).
  - If federal funds were used in any of the previous phases of the Contract (Design or Right of Way), the construction Contract must include Buy America requirements, even if federal funds were not used in the construction phase.

Buy America requirements are incorporated into the Contract by General Special Provision.

WSDOT uses a certification process to ensure compliance with Buy America requirements. **A Certification of Materials Origin (CMO) must be submitted to the Project Engineer for all steel and iron permanently incorporated into the project prior to placement.** There are no exceptions to this requirement. The Contractor may use DOT Form 350-109 or another form containing the same information.

The Contractor may choose to utilize minor quantities of foreign steel and iron, as allowed in the General Special Provision. Foreign steel and iron material costs cannot exceed one-tenth of one percent of the total Contract cost or \$2,500.00, whichever is greater.

A tracking sheet is available on the Construction SharePoint site to track the cost of foreign steel and iron permanently incorporated into the project using the amounts shown on submitted CMOs (if any). If the tracking sheet shows that the foreign steel and iron allowance has been exceeded, contact the State Construction Office immediately. Exceeding the allowable amount of foreign steel and iron will likely result in the loss of federal funding for the whole project.

State Agency and/or Contractor supplied material and proprietary items are subject to Buy America requirements. They require a CMO and must be included in the calculation when determining the amount of foreign steel and iron incorporated for each project.

The Project Engineer must ensure the CMOs are on file prior to placing or paying for bid items containing steel or iron as defined below.

### Fabricated Items

- WSDOT Fabrication Inspection Office will review the supporting documents (mill certifications and CMOs) prior to inspecting and stamping fabricated material. The required CMO for steel and iron incorporated into fabricated material will be provided by the manufacturer to the Project Office through the Contractor for retention. The WSDOT Fabrication Inspection Office may retain a copy of the CMO for retention.
- The Project Inspector is required to document if fabricated material has been stamped with a “D” for domestic or an “F” for foreign to indicate the material origin as outlined in Section 9-1.5. Fabricated items stamped with an “F” or that do not have any stamp when delivered to the job site will require additional verification prior to incorporation of the material into the project.
  - If the item is stamped with an “F” contact the WSDOT Fabrication Office or the Contractor to request a copy of the CMO. The dollar amounts shown for foreign steel or iron incorporated into the item must be added to the foreign steel tracking sheet - DOT Form 350-005 Buy America Foreign Steel Tracking Sheet is available for use.
  - Contact the WSDOT Fabrication Office for direction for fabricated items requiring inspection that are lacking any stamp.

### Non-Fabricated Items

- The Project Engineer will ensure that a completed CMO for all material containing steel or iron that is permanently incorporated is submitted prior to incorporation and that it is retained with the project documentation.

### Build America/Buy America (BABA) - Construction Materials

Build America/Buy America - BABA (Public Law 117-58) requires that all construction material permanently incorporated into the project be made in the United States for:

- Contracts that include federal funding in the construction phase

BABA requirements are incorporated into the Contract by General Special Provision.

WSDOT uses a certification process to ensure compliance with BABA requirements. A Certification of Materials Origin (CMO) must be submitted to the Project Engineer for all construction material incorporated into the project before payment of each progress estimate. The CMO will certify that all the construction materials installed during the current progress estimate period were made in the United States. The Contractor may use DOT Form 350-110 or another form containing the same information.

State Agency and/or Contractor supplied material and proprietary items are subject to Buy America requirements, requiring a CMO.

**The Project Engineer cannot approve payment for a progress estimate if a CMO is not on file to certify that material installed meets BABA requirements.**

If a CMO is received showing that foreign made construction material was installed the Project Engineer will:

- Defer the amount shown as the “Invoice Cost” of the foreign material prior to approving payment.
- Direct the Contractor to remove the foreign made construction material.

After the foreign made construction material has been replaced, request an updated CMO to support release of the deferred payment and document that all construction materials installed were made in the United States.

If removing the foreign construction materials will significantly impact project time/schedule or be cost-prohibitive, contact your Assistant State Construction Engineer (ASCE) for guidance on the appropriate way to proceed.

A list is available on the Construction SharePoint site to determine those materials that are designated as a construction material under BABA requirements. This list is for reference only and is subject to change as the BABA requirements become more defined by FHWA.

#### **Build America/Buy America (BABA) - Manufactured Products**

A nationwide waiver has been approved for material identified as manufactured products and the BABA requirements noted above do not apply to them.

### **9-1.2F Project Material Certification**

The Project Engineer is responsible for obtaining all required materials documentation or otherwise ensuring that all required materials testing is completed, all with satisfactory results, prior to the materials being incorporated into the project. The Project Engineer is also responsible for maintaining a comprehensive accounting for the materials incorporated into the project in order to support the Region's Certification of Materials. Managing and accounting for materials used in the construction of a project are to be administered in the same manner regardless of its funding source; Federal, State, or a combination of both.

The Region is responsible for periodic reviews of each project's materials documentation at the Project Engineer's Office. Upon completion of the project the Region will prepare a Region Materials Certification letter listing all variances that were identified and their resolution. On projects that involve Federal participation where material deficiencies are documented, these deficiencies must be resolved with the State Construction Office through the Region before the Region Certification of Materials can be completed. On projects that involve State Funds only, documented deficiencies must be resolved with the Region prior to the Region Certification of Materials. The Regional Administrator or their designee is responsible for signing and distributing the certification letter.

The State Materials Laboratory will also perform Construction Quality Audits on a sampling of active projects statewide where the materials have yet to be certified.

#### **9-1.2F(1) Definitions**

##### **(I) Certification**

A Region Materials Certification based on a documented evaluation of the project's materials inspection, sampling, testing, and other materials acceptance activities for their conformance to the contract documents, *Standard Specifications*, and this manual. The certification reflects the project's conformance with the Record of Materials as adjusted by the Project Engineer for:

1. Actual project quantities utilized.
2. Acceptance practices as provided for in this chapter.
3. Adjusted sampling/testing frequencies as provided for in [Section 9-3](#).
4. Work added by Change Order.

## (II) Variance

An identified difference between the materials acceptance requirements noted in this manual, the contract documents, the *Standard Specifications*, and a review of the completed projects Record of Materials. All variances must be noted. Such notations must include the basis by which the material was accepted and how the requirements for that material were met. Any variance between the recognized acceptance requirements and the Project Engineer's use of the material must be resolved with the Region, State Construction Office, and/or State Materials Laboratory, as appropriate.

### 9-1.2F(2) Project Material Certification Process

The Project Engineer Office completes the Contract Materials Checklist (DOT Form 350-115) prior to Completion of Final Project Records.

Any contract materials checklist items marked "No" constitute a Materials Certification deficiency.

- a. Each "No" requires the contract item number for the affected item to be shown along with an attachment to the Materials Checklist detailing the circumstances of use, the method used for acceptance of the material, the Project Engineer's evaluation of the material, suitability for its application, and determination as to whether or not it may have met the specification in spite of the materials documentation oversight.
- b. If the project is federally funded, the Project Engineer should also include a recommendation for Federal participation in light of the use of undocumented materials.

The Project Engineer Office submits the completed Contract Materials Checklist Form along with documentation of materials variances to the Construction Division Documentation Engineer

The Construction Division Documentation Engineer will review the contract materials checklist variances and coordinates with FHWA to determine federal funding eligibility for variances.

The Documentation Engineer will send a letter of resolution to Region identifying degree of federal participation on the project.

An example of the Region Materials Certification letter and its distribution is available on the [Construction SharePoint](#) site.

### 9-1.3 Approval of Materials

Prior to use, the Contractor must notify the engineer of all proposed materials to be permanently incorporated into the project in accordance with *Standard Specifications* Section 1-06.1. Some temporary items may require approval if required by the Contract Documents. This may be accomplished by a Qualified Product List (QPL) submittal or by submitting a Request for Approval of Material (RAM) [DOT Form 350-071](#).

When materials are approved, it does not necessarily constitute acceptance of the materials for incorporation into the work. All additional acceptance actions, as noted by the code on the RAM or QPL must be completed prior to the materials being used in the work.

### 9-1.3A Aggregate Source Approval and the Qualified Products List

#### 9-1.3A(1) Aggregate Source Approval

The State Materials Engineer establishes requirements for aggregate source sampling, testing and approval of aggregate sources in the Aggregate Source Approval (ASA) database. The ASA engineer at the State Materials Laboratory maintains and updates the ASA computer database, records source approvals, and coordinates with source owners and the Region materials engineers on sampling and testing for source approvals.

The Region Materials Engineer, licensed as a Professional Engineer in the State of Washington, manages the aggregate sources in their region. This includes:

- Being the primary point of contact for privately owned aggregate sources located in their Region
  - This includes communication on approval, disapproval, discussion of test results, etc. The QPL/ASA Engineer is available to assist the Region Materials Engineer with arrangements for testing and payments required. Evaluation letters will be sent by the QPL/ASA Engineer to the aggregate source point of contact.
- Providing the recommended approval time or disapproval for privately owned aggregate source to the QPL/ASA Engineer
  - The length of approval time will not exceed 5 years and may be less than 5 years based upon the Region Materials Engineers determination of the quality of materials in the source.
  - For aggregate sources having variable quality, the Region Materials Engineer may have remarks added to the ASA database indicating that the aggregate source approval is on a stockpile basis. The Region Materials Engineer may approve these aggregate sources by either a stockpile(s) or on a project-by-project basis provided the aggregate source approval duration has not expired.
  - Can initiate and approve up to a 3 month extension of an aggregate source on a project-by-project basis for a WSDOT construction project as long as the extension is approved prior to the aggregate source/material expiration date.

#### 9-1.3A(2) Qualified Products List (QPL)

Products listed in the QPL have been found capable of meeting the requirements of the *Standard Specifications*, General Special Provision, Bridge Special Provision and Standard Plans under which they are listed and, therefore, have been “Approved.” These products may be “Accepted” by fulfilling the requirements of the Acceptance Code and any notes that apply to the product. If the Contractor elects to use the QPL, the most current list available at the time the product is proposed for use, shall be used. During the life of the Contract, acceptance methods for materials in the QPL may change, becoming more stringent or less stringent. The acceptance method detailed on the originally submitted QPL page will continue to be the acceptance method for the life of the contract, unless the Contractor submits a new QPL page for the material. This is the case regardless of whether the acceptance method becomes more stringent or less stringent. Instructions are given in the QPL for processing QPL submittals. Contractors and Project Offices are encouraged to use the QPL database for submittals. The QPL database is constantly updated with additions and/or deletions and can be accessed at [https://www.wsdot.wa.gov/biz/mats/QPL/QPL\\_Search.cfm](https://www.wsdot.wa.gov/biz/mats/QPL/QPL_Search.cfm)

The Project Office shall review the material submittal for consistency with the Bid Item and shall promptly notify the Contractor of any concerns, working with the Contractor toward resolving these issues. QPL submittals inconsistent with the intended use for the Bid Item should be marked “unacceptable for intended use” and returned to the Contractor. Copies of QPL pages for materials that are to carry a WSDOT Fabrication Inspection “Stamp/Tag” or Sign Inspection “Decal” shall be forwarded to the WSDOT Headquarters Fabrication Inspection Office.

### 9-1.3B Request for Approval of Material – Submittal

The Contractor submits all Request for Approval of Materials (RAM) to the Project Office using the WSDOT RAM form [DOT Form 350-071](#).

The coding of the RAM is to determine if the proposed material on the RAM is capable of meeting the established standards and defining the material acceptance method. Acceptance determines if the material being placed on the contract meets the established standards.

If a RAM is submitted with a material found on the QPL, the Project Office may code the RAM as defined in [Section 9-1.3B\(1\)](#).

RAMs submitted by the Contractor that contain errors should be returned to the Contractor for correction. The Project Office needs to provide details to the Contractor on why the RAM is being returned, noting what needs to be corrected. The Project Office may elect to modify the RAM submitted by the Contractor to clarify minor errors. Any modifications by the Project Office to the Contractor’s submitted RAM shall have written documentation from the Contractor showing the Contractor’s request to modify the RAM, and contain the specific details that were missing in the original Contractor submittal. The written documentation from the Contractor shall be attached to the RAM that was modified.

If a RAM is submitted with a material not identified under the Project Office Approval Coding ([Section 9-1.3B\(1\)](#)), the Project Office shall submit the RAM to the Construction Materials - Materials Quality Assurance Section for coding. The Project Engineer or delegated representative will sign, date, and code the items with a “7” – “Approval Pending” and forward it to the Materials Quality Assurance Section at [MLRAM@wsdot.wa.gov](mailto:MLRAM@wsdot.wa.gov). If the RAM is not filled out correctly it will be returned to the Project Office prior to any action being taken.

A copy should also be returned to the Contractor at this point to inform them that the RAM has been sent to the Materials Quality Assurance Section for approval. Submit any additional documentation, including appropriate transmittals that may assist the RAM engineer in approving the proposed material; such as Test Reports, Catalog Cuts, Manufacturer’s Certificate of Compliance, etc. The page number of the Special Provision or Plan Sheet will also aid in expediting the approval process.

The Materials Quality Assurance Section may elect to delegate approval of some specialty items.

All RAMs shall be signed and dated by the Project Engineer and copies distributed as indicated at the bottom of the RAM form.

### 9-1.3B(1) Project Engineer's Office Approval Coding

#### (I) QPL Reference Materials

The engineer may code the RAM if the product listed on the RAM is identified in the QPL by make, model, batch, color, size, part no., etc. The product must also be listed in the QPL under the appropriate *Standard Specifications* for the intended use as indicated by the Bid Item and Specification Reference shown on the RAM. The RAM should be coded with the 4-digit QPL acceptance code and any notes and/or restrictions restated as "Remarks" on the RAM.

#### (II) Aggregates

Aggregate Sources will be approved by consulting the Aggregate Source Approval database for the use intended. The Project Engineer shall approve the RAM, coding when there is a sampling frequency in [Section 9-3.7](#) with a "1" – "Conditionally Approved: Acceptance based upon Satisfactory Test Report." Aggregates that do not have a sampling frequency should be coded per requirements of the ASA database. Print the ASA Report and attach it to the approved RAM.

The Region Materials Engineer may have added remarks to the ASA database for aggregate sources having variable quality. Contact the Region Materials Engineer prior to use. It has been demonstrated that some of these sources can provide quality material through diligent production and stockpile management. The Region Materials Engineer may approve these aggregate sources by the stockpile(s) or on a project-by-project basis.

Review the approval date on the ASA Report to verify that the approval of the aggregate source has not expired or will not expire before the end of your contract. If the aggregate source is approved at the beginning of your project, it does not mean that it is approved for the duration of the project. If the aggregate source requires evaluation, contact the Region materials office for further direction. If samples are required, the Region materials office will coordinate with the Materials Quality Assurance Section QPL/ASA Engineer to obtain the necessary samples in accordance with SOP 128.

The remarks in the ASA Report also need to be reviewed to make sure that there are no additional requirements or restrictions on the material that you intend to use. If you are using concrete aggregate, review the ASR values to see if ASR mitigation is required for the concrete mix design.

#### (III) Optional Approval/Acceptance

The Project Engineer may elect to approve some materials by invoking [Section 9-1.1D](#). This process allows the Project Engineer to approve the RAM. The PE needs to verify the material being approved meets the requirements listed and is for the same specifications as the material listed in [Section 9-1.1D](#). After verifying concurrence with [Section 9-1.1D](#), the Project Engineer shall approve the RAM, coding with an "8 – Approved per CM [Section 9-1.1D](#)."

#### (IV) Proprietary Materials

When the Contract documents state "shall be..." and list specific products by name and model, the Contractor must submit a Request for Approval of Material (RAM) indicating the intended choice. The Project Engineer will approve the RAM, coding it with an "8" – "Source Approved" and note the page number where it is listed in the Contract documents as a proprietary material. Occasionally proprietary materials will have

additional acceptance criteria that needs to be noted on the RAM. The subject matter expert for the material being placed may also ask for additional documentation.

Proprietary materials are subject to Buy America and/or Build America/Buy America (BABA) requirements when included in the Contract by Special Provision. The Buy America and BABA requirements should be addressed by the Designer prior to including the material in the Special Provisions. Ultimately it is the responsibility of the Project Engineer to verify that the requirements are met using the guidance provided in 9-1.2E of this manual.

#### **(V) Agency Supplied Materials**

An approved RAM is not required for agency supplied materials. If a RAM is submitted to the Project Engineer, approve the RAM by coding it with an “8” – “Source Approved” and note the page number where it is listed in the Contract documents as an agency supplied material. Additional acceptance criteria may be required in the Special Provisions or Contract Plans.

Agency supplied materials are subject to Buy America and/or Build America/Buy America requirements when included in the Contract by Special Provision. Buy America and BABA requirements should be addressed by the Designer prior to including the material into the Special Provisions. Ultimately it is the responsibility of the Project Engineer to verify that the requirements are met using the guidance provided in [Section 9-1.2E](#) of this manual.

#### **(VI) Concrete and Asphalt Batch Plants**

For Concrete Batch Plants, the Project Engineer office shall ensure requirements of [Standard Specifications](#) Section 6-02.3(4)A are met prior to approving the RAM.

For Asphalt Mixing Plants, the Project Engineer office shall ensure requirement of [Standard Specifications](#) Section 5-04.3(1) are met. There is no approval on the RAM required for Asphalt Mixing Plants, however coding the RAM with an “8” – “Source Approved” would be appropriate.

#### **(VII) Recycle Materials for Aggregate**

Requirements for recycled materials in aggregates are described in [Standard Specifications](#) Section 9-03.21 which applies to recycled hot mix asphalt, recycled concrete aggregate, glass aggregates and steel furnace slag. The Project Engineer is required to verify that recycled material imported to the job site is not classified as a Dangerous Waste per the Dangerous Waste Regulations [WAC 173-303](#). Recycled materials obtained from the Contracting Agency’s roadways will not require testing and certification for toxicity testing or certification for toxicity characteristics.

The Project Engineer needs to do the following in order to determine and document the recycled material is not classified as a Dangerous Waste and is acceptable for use on a WSDOT project:

- Have the Contractor provide documentation identifying what recycled materials the Contractor is proposing to use and sampling documentation.
- Have the Contractor provide testing information from representative samples of the recycled material and check to ensure the recycled material is below the Maximum Concentration of Contaminates for the Toxicity Characteristics in the Toxicity Characteristics List in [WAC 173-303-090](#).
- Have the Contractor certify that the recycled material is not a Washington State Dangerous Waste per [WAC 173-303](#).



The Project Engineer can contact the WSDOT Hazardous Materials Program to help evaluate sample approach, lab results, help in determining if changes in the recycled material warrant additional testing, or other assistance as needed. The Hazardous Material Program can be reached at 360-570-6656.

The Contractor is required to do sampling and testing for toxicity of the recycled material at the frequency specified in *Standard Specifications* Section 9-03.21(1) prior to combining with other materials and not less than one sample and test from any single source. If the Project Engineer suspects the recycled material may be contaminated based on a change in odor, appearance, or knowledge of the source of material, the WSDOT Hazardous Materials Program should be contacted to determine if a verification sample should be tested for toxicity. Sample results are expected to exhibit the average properties of the stockpile of material being proposed for use. The final blended product shall meet the acceptance requirements for the specified type of aggregate.

Once it has been determined that the recycled material is not classified as a Dangerous Waste the Project Engineer shall code the RAM either as an “8” Source Approved or as a “9” Submit samples for preliminary evaluation depending on what type of aggregate material the recycled material is being proposed for.

The RAM should be coded with an “8 & 1” and noted as “certification and acceptance testing per *Standard Specifications* Section 9-03.21” in the remark field for the following aggregate materials; Section 9-03.8 Aggregates for Hot Mix Asphalt (recycle HMA only), Section 9-03.10 Aggregate for Gravel Base, Section 9-03.12(1)B Gravel Backfill for Foundations Class B, Section 9-03.12(2) Gravel Backfill for Walls, Section 9-03.12(3) Gravel Backfill for Pipe Zone Bedding, Section 9-03.12(4) Gravel Backfill for Drains, Section 9-03.12(5) Gravel Backfill for Drywells, Section 9-03.13 Backfill for Drains, Section 9-03.13(1) Sand Drainage Blanket, Section 9-03.14(1) Gravel Borrow, and Section 9-03.14(2) Select Borrow.

The RAM should be coded with a “9” and noted “source properties evaluation and indicate the standard specification being proposed” in the remarks field for the following aggregate materials; Section 9-03.8 Aggregates for Hot Mix Asphalt (recycle steel furnace slag only), Section 9-03.9(1) Ballast, Section 9-03.9(2) Permeable Ballast, Section 9-03.9(3) Crush Surfacing, Section 9-03.12(1)A Gravel Backfill for Foundations Class A, and Section 9-13.1 Riprap and Quarry Spalls. Include copies of the toxicity tests results with the preliminary sample that is submitted to the State Materials Laboratory for evaluation of source properties.

Engrossed Substitute House Bill 1695 requires the use of recycled concrete aggregates (RCA) in the amount of 25 percent on all WSDOT projects. This requirement only applies to those materials listed in *Standard Specification* Section 9-03.21 table that allow the use of RCA, see Section [SS 1-06.6](#). To encourage and streamline the use of RCA on WSDOT projects the State Materials Laboratory developed quality control plans for RCA. There are three tiers of quality for RCA;

- Tier 1 pertains to those aggregate materials that do not require preliminary testing for source property requirements such as LA Wear, WSDOT Degradation, and Specific Gravity and applies to *Standard Specifications* Sections 9-03.10 Aggregates for Gravel Base, 9-03.12(1)B Gravel Backfill for Foundations Class B, 9-03.12(2) Gravel Backfill for Walls, 9-03.12(3) Gravel Backfill for Pipe Zone Bedding, 9-03.14(1) Gravel Borrow, 9-03.14(2) Select Borrow, 9-03.14(2) Select Borrow (greater than 3 feet below subgrade and side slope), 9-03.14(3) Common Borrow, 9-03.14(3)

Common Borrow (greater than 3 feet below subgrade and side slope), 9-03.17 Foundation Material Class A and Class B, 9-03.18 Foundation Material Class C, and 9-03.19 Bank Run Gravel for Trench Backfill. See Section 9-4.11 for approval and acceptance requirements.

- Tier 2 pertains to RCA from WSDOT projects and returned concrete. Returned concrete is concrete that was returned to the concrete plant that was produced from a WSDOT approved aggregate source. For a reclamation facility to participate in Tier 2 the reclamation facility must be compliant with WSDOT Standard Practice QC 9 “Standard Practice for Approval of Reclamation Facilities for WSDOT Recycled Concrete and Returned Concrete”. See Section 9-4.11 for approval and acceptance requirements.
- Tier 3 pertains to RCA from stockpiles of unknown sources. For reclamation facility to participate in Tier 3 the reclamation facility must be compliant with WSDOT Standard Practice QC 10 “Standard Practice for Approval of Recycled Materials Facilities from Stockpiles of Unknown Sources” See Section 9-4.11 for approval and acceptance requirements.

Reclamation facilities that are compliant with WSDOT’s quality control plans will be listed on the QPL under *Standard Specifications* Section 9-03.21(1)B.

### **(VIII) Preliminary Evaluation Samples**

The Project Engineer may elect to approve some materials by submitting samples for testing by coding the RAM with a “9” – “Submit Samples for Preliminary Evaluation.” This authority is applicable only to the materials that the State Materials Laboratory is capable of testing. The Project Engineer must review the Standard Specifications and Contract documents for compliance prior to submitting the sample for testing.

The Project Engineer can contact the State Materials Laboratory at 360-709-5400 if assistance is needed to determine their testing capabilities.

Upon receipt of a satisfactory test report from the State Materials Laboratory, the Project Engineer shall approve the RAM, coding it with an “8” – Source Approved.

Material approved under this authority is subject to Buy America and/or Build America/ Buy America (BABA) requirements when included in the Contract by Special Provision.

### **(IX) Region Special Provisions**

The Project Engineer is allowed to approve the RAM for material specified in the Region Special Provisions. In taking these actions, the Project Engineer is acting under the professional responsibility inherent in all actions as a representative of the Department and as a Licensed Professional Engineer. Full accountability of such actions is expected. It is the responsibility of the Project Engineer to determine the appropriate acceptance criteria for the material; which may require testing or other means to support a decision. This includes contacting the Region or Headquarters subject matter expert if assistance is needed.

Material approved under this authority is subject to Buy America and/or Build America/ Buy America (BABA) requirements when included in the Contract by Special Provision. Buy America and BABA requirements should be addressed by the Designer prior to including the material in the Special Provisions. Ultimately it is the responsibility of the Project Engineer to verify that the requirements are met.

### 9-1.3C Low Risk Materials

There are low risk materials that may be used in the project without Contractor identification per *Standard Specifications* Section 1-06 or any other documentation unless stipulated in the Contract documents. Low risk materials are subject to Buy America and/or Build America/Buy America (BABA) requirements when included in the Contract by Special Provision. Materials identified as low risk are listed in Table 9-2. Other items can be considered for addition to this list. Suggestions are encouraged and may be made to the State Construction Office or the Materials Quality Assurance Engineer at the State Materials Laboratory.

**Table 9-2 Low Risk Materials**

- Asphaltic felt for bridge approach slabs and pavement seats
- Backer Rod for Induction Loop Vehicle Detectors
- Bond breaking material for cement concrete pavement
- Clear plastic covering
- Colloidal copper compound
- Concrete Drain Tile with Cover for Ground Rods
- CSL Access Tubes and Caps
- Duct tape for bridge approach slab anchors
- Dust Palliative
- Electrical pull string
- Electrical tape
- Expanded polystyrene for bridge approach slab anchors
- Friction tape, and moisture proof varnish for friction tape
- Fasteners for Mailbox Supports (bolts, nuts, and washers)
- Galvanized wire mesh and hardware for screens on sign bridges and cantilever sign structure bases
- Material for Painting/Coating preparation (abrasive blast media, bird guano treatment, fungicide treatment, filter fabric, foam backer rod)
- Mailbox Support Type 1
- Metal Form For Light Standard Foundation
- Nails
- Oxide Inhibitors for Aluminum Conductors
- Parting Compound for Concrete Forms
- Pea gravel for decorative purposes
- Pipe wrap and spacers for electrical conduit
- Pipe Joint Lubricant
- Polypropylene rope for induction loop centralizers
- Premolded joint filler for expansion joints in sidewalks, curbs, and gutters
- PVC pipe for bridge approach slab anchors
- PVC Pipe for Weep Holes through Bridge Abutment Pier Walls, Reinforced Concrete Retaining Wall Stem Walls, and Concrete Fascia Panels
- PVC solvent cement
- Rebar tie wire (plain and epoxy-coated)
- Shims for Concrete Barrier
- Shims for Oak Blocks for Bridges
- Shims (plastic) for precast drainage items
- Grout for cosmetic purposes
- High Visibility Fence including hardware and stakes
- Locknuts for terminating conduit
- Loose Woody Debris
- Signal Foundation Identification Tag and Epoxy adhesive to attach them
- Silicone sealant for electrical service cabinets
- Spacers for electrical conduit duct bank
- Spacers for rebar columns
- Steel Reinforcing Bar Centralizers
- Weed-free straw bales not used as mulch or check dams
- Wire marking sleeve

## 9-1.4 Acceptance Methods for Materials

Materials acceptance is accomplished by several different methods. Once a material is approved and has demonstrated the ability to meet the applicable specification, a proper method of acceptance is determined for that type of product. The approved Request for Approval of Material or submitted Qualified Product List page will state the acceptance method.

Types of Acceptance methods are Sampling and Testing, WSDOT Fabrications Inspection, Manufacturer's Certificate of Compliance, Miscellaneous Certificates of Compliance, Shop Drawings, Catalog Cuts, Optional Approval/Acceptance for Materials, Visual Acceptance or Reduced Acceptance Criteria. Sampling and testing is the highest level of acceptance method showing conformance to the requirements. All designated acceptance documentation is to be approved and retained prior to material being placed except for verification samples and Manufacturer's Certificate of Compliance within the restraints of *Standard Specifications* Section 1-06.3.

### 9-1.4A Testing

Project Engineer offices are responsible for tracking the acceptance/verification tests performed on their contracts. Refer to *Standard Specifications* Section 1-06.2(1) and this chapter for testing criteria and frequency information. This chapter also includes a large variety of test procedures that may be performed in the field office lab or at the jobsite by a qualified tester. All testers shall be qualified to perform sampling/testing for those acceptance tests found in the *Construction Manual* M 41-01.

#### 9-1.4A(1) Reference Test Report

When a Satisfactory Test Report is required, a Reference Test Report may be used if allowed in [Section 9-4](#) for that specific material. A Reference Test Report as listed below will not be allowed for HMA Mix Designs or other materials unless allowed per [Section 9-4](#).

A Reference Test Report shall consist of a printed copy of the current electronic QPL database page showing "referenced" lots previously tested during the current calendar year. The lot number in the QPL must match the lot number of the material used. The information will be listed in the "description" field for specific materials in the QPL. The QPL page used as the "Reference Test Report" shall be within the same calendar year that the material is used on the project. The QPL page must reflect the same specification as the material to be used and be received prior to installation of the intended material.

The use of a test report from another contract is not acceptable as a Reference Test Report.

#### 9-1.4A(2) Statistical Acceptance With SAM

The Statistical Analysis of Materials program (SAM) has been developed to calculate the percent within limits of materials being statistically accepted per *Standard Specifications* Section 1-06.2(2). When the test results for at least three samples has been entered, the program will calculate the percent within limits based on the upper and lower acceptance limits, calculate the pay factor for each, and calculate the composite pay factor (CPF) for the material being evaluated.

### **(I) Initial Material Set-up**

When a contract requires statistical analysis to be used, the “lot” acceptance criteria for the material needs to be entered into SAM. A lot is defined as 15 sublots; the final lot may be increased to 25 sublots. All samples from a material type, i.e., gravel backfill for walls, mineral aggregate, concrete aggregate, or CSBC shall be evaluated collectively. For paving concrete, each class of mix shall be evaluated collectively. For hot mix asphalt, each job mix formula, and all changes to that job mix formula shall be evaluated collectively.

Make sure that this information is correct. Once test data has been entered, the lot acceptance criteria cannot be altered. There are three ways to establish the lot acceptance criteria:

1. Select the material. The appropriate specifications will be automatically retrieved.
2. For HMA, you can enter the mix design number, and the JMF, the acceptance specifications, the tolerances, price adjustment factors, and the upper and lower acceptance limits will be automatically retrieved.
3. Pick User Define and you will be able to add new requirements, or edit existing requirements. For HMA, make sure that you calculate the upper and lower acceptance criteria based on the tolerance limits.

If there is a change to the HMA job mix formula, (JMF), the program allows you to copy existing lots. The original mix design and a “-1, -2, -3...” number is added, and you are allowed to edit the JMF. These JMF’s will be evaluated collectively.

It is important to delete lots that are not used from the program. The statistical acceptance results are used by other programs to evaluate the material.

### **(II) Inputting Test Results**

Once the testing has been completed, the test results need to be entered into the program for the material being tested as soon as possible. Once the office starts using the Materials Testing Program for the field testing, the test results will be retrieved into the statistical program.

### **(III) Review Work**

As with all materials documentation, this information entered into the statistical program needs to be reviewed regularly to make sure that there are no mistakes. If an error has been found in the test data, the original data can be revised. If an error has been found in the lot acceptance criteria, all of the test data will have to be deleted and re-entered under the new lot.

### **(IV) Contractor Access**

The PEO documentation engineer will give the contractor access to the statistical program. This will allow the contractor access to the statistical program for the work order they are working on to view the acceptance results. They will not be able to change the lot acceptance criteria or any test results. They will be able to access the acceptance portion of the program, and view the gradation report, the compaction report, and the contract detail report.

## 9-1.4B Fabricated Items

### 9-1.4B(1) Stamp/Tag

Items that are inspected and found to meet contract document requirements by the WSDOT Materials Fabrication Inspection Office are identified by a Stamp or Tag. This type of inspection is generally performed at the manufacturing or fabrication plants. There are various types of Stamps or Tags used for acceptance of inspected items, which attest that the item was in full conformance with the specifications at the time of inspection. The inspected items, along with the type of Stamp or Tag designation, are covered under [Section 9-2](#).

It is the responsibility of the Project Engineer office to notify the WSDOT Materials Fabrication Inspection Office when their inspection services are needed by sending a 'cc' of the approved RAM or submitted QPL page to WSDOT Fabrications at [fabinspect@wsdot.wa.gov](mailto:fabinspect@wsdot.wa.gov). The Contractor or the Fabricator may also contact the WSDOT Materials Fabrication Inspection Office for needed inspection.

To schedule a fabrication inspection contact:

Fabrication Inspection – 360-709-5504  
Mail Stop to send hardcopy documents – MS 47365 Attn: Fabrication Inspection  
Email Address: [fabinspect@wsdot.wa.gov](mailto:fabinspect@wsdot.wa.gov)  
Physical Address: 1655 S 2nd Ave. SW, Tumwater, WA 98504-7365

- Online at [Materials Laboratory Testing and Field Inspection](#)

If there are no stamps or tags present, inform the Contractor that the item is not acceptable and contact the Materials Fabrication Inspection Office to determine the status of the inspection. The Project Engineer may accept an email from the WSDOT Fabrication Inspection Office as field verification documentation that an item delivered with a missing/unreadable tag or stamp has been inspected and was acceptable at the time/place of inspection by the WSDOT Fabrication Inspector. With the exception of items that have been verified as acceptable by the WSDOT Fabrication Inspection Office, items lacking stamps or tags and those items damaged during shipping should be rejected and the material tagged or marked appropriately. The Fabrication Office typically performs inspections at fabrication shops and may elect to inspect materials at the project site or other site located within Washington State and will coordinate with the Project Office when that occurs.

### 9-1.4B(2) Signing Decal

Signing items that are inspected and found to meet contract document requirements by the WSDOT Materials Fabrication Inspection Office are identified by a Decal. This type of inspection is performed at the sign fabrications plant. The Decal present attests that the item was in full conformance with the specifications at the time of inspection. The Decal designation is covered under [Section 9-2](#).

It is the responsibility of the Project Engineer office to notify the WSDOT Materials Fabrication Inspection Office when their inspection services are needed by sending a 'cc' of the approved RAM or submitted QPL page to WSDOT Fabrications at [fabinspect@wsdot.wa.gov](mailto:fabinspect@wsdot.wa.gov). The Contractor or the Fabricator may also contact WSDOT Materials Fabrication Inspection Office as listed in Section 9-1.4B(1) for needed inspection.

### 9-1.4B(3) Concrete Pipe Acceptance Report

Concrete Pipe less than 30 in in diameter that are inspected and found to meet contract document requirements by the WSDOT Materials Fabrication Inspection Office are identified by a Concrete Pipe Acceptance Report.

The Concrete Pipe Acceptance Report will indicate the date and original test results as performed by the Fabrication Inspector and will bear the appropriate certification from the fabricator.

It is the responsibility of the Project Office Field Inspector to verify material delivered to the jobsite is represented by the Concrete Pipe Acceptance Report delivered with the pipe. The Concrete Pipe Acceptance Report is only valid for a 90 day period starting from the manufacturing date of the tested pipe.

The Field Inspector is required to verify the following:

- Manufacturing date of the pipe is within the 90-day window on the report.
- Pipe is at the age of the specified days or older as stated on the concrete pipe acceptance report.

**Note:** Concrete Pipe 30 inches and greater require different acceptance per [Section 9-4](#).

The WSDOT Materials Fabrication Inspection Office can be contacted as listed in Section 9-1.4B(1).

### 9-1.4C Visual Acceptance

Visual Acceptance is appropriate for material that has the lowest risk and consequence of failure. The field inspector is required to verify that proper “Approval” has been performed per Section 9-1.3. No further documentation is required for acceptance unless the Contract Documents mandate additional information.

### 9-1.4D Manufacturer’s Certificate of Compliance

As designated by the Specifications and Contract Special Provisions, certain materials may be accepted on the basis of a Manufacturer’s Certificate of Compliance. This acceptance is an alternative to job site sampling and testing. The submitted *Qualified Products List* page or approved Request for Approval of Material shall stipulate the items for which a compliance certification is an acceptable basis of acceptance. The Manufacturer’s Certificate of Compliance is required prior to permanent installation of the material. See Section [SS 1-06.3](#) for guidance on allowing material to be placed without certification.

The form of the Manufacturer’s Certificate of Compliance will vary considerably based on both the material and the origin, and may take the form of standard certificate form, individual letter from manufacturers, or overstamp on bill of lading. Certain information is required and is designated by the specifications. This information includes the identity of the manufacturer, the type and quantity of material being certified, the applicable specifications being affirmed, and the signature of a responsible representative of the manufacturer. Supporting mill tests or documents may also be required. A Manufacturer’s Certificate of Compliance is required for each delivery of material to the project and the lot number, where lot numbers apply, of material being certified shall be identified.

Upon receipt of the Manufacturer’s Certificate of Compliance at the project office, it shall be reviewed for compliance with the specification requirements using the preceding guidelines and the checklist for Transmittal of Manufacturer’s Certificate of Compliance

Check List [DOT Form 350-572](#). The manufacturer of the material must make the certification. A supplier certificate is not acceptable except as evidence for lot number and quantity shipped and can only be accepted when accompanied by a certificate from the manufacturer, which meets the requirements of *Standard Specifications* Section 1-06.3. The Project Office is required to retain the signed and dated Manufacturer's Certificate of Compliance Check List for each submittal.

#### 9-1.4E Miscellaneous Certificates of Compliance

As designated by the Specifications and Contract Special Provisions, certain materials may be accepted on the basis of a Certificate of Compliance. Various Certificates of Compliance, such as a Lumber Grading Certificate, Lumber Grading Stamp, Certificate of Treatment, Bag Label, Concrete Delivery Ticket and/or Electronic Ticket, Asphalt Certification of Shipment (BOL), Supplier's Certificate of Compliance and Contactor's Certificate of Compliance, may be required for acceptance on different types of materials. A Supplier's Certificate of Compliance or Contactor's Certificate of Compliance shall be on Company letterhead, specifying the Contract number, name, the material being certified, the WSDOT Standards or Specifications being affirmed, and signed and dated by the company official.

*Standard Specifications*, Contract Provisions, and Chapter 9 may require written verification or retention of the Certificate of Compliances by the Project Engineer office Field Inspector.

#### 9-1.4F Shop Drawings

As designated by the specifications and contract special provisions, certain materials may be accepted on the basis of a Shop Drawing. Shop drawings are generally manufacturer's or fabricator's drawings that show details about an item being built for a specific job. Approval of Shop Plans and Working Drawings is per Section 1-2.4H and [Figure 1-1](#).

The Shop Drawing shall be retained and placed in the Materials Files for acceptance.

#### 9-1.4G Catalog Cuts

As designated by the Contract documents, certain materials may require the acceptance method be based on a Catalog Cut. A Catalog Cut may also be required in support of approving a Request for Approval of Materials (RAM) per [Section 9-1.3B](#). The approved Catalog Cut is required prior to installation of the material.

Upon receipt of the Catalog Cut information at the Project Office, an initial review for compliance with the established Specifications and Contract documents should be performed. All information shall be accompanied by the "Transmittal of Catalog Cuts" form generated with the Record of Materials. The Project Office shall follow the directions on the Transmittal of Catalog Cuts [DOT Form 350-072](#) and submit the package to the State Materials Lab Documentation Section for approval, or as per the original Record of Material. The Transmittal of Catalog Cuts form and Catalog Cuts for those materials listed in *Standard Specifications* Section 9-14 and 9-15, and accepted based on approved Catalog Cuts, should be submitted to the Region or State Roadside and Site Development Office for approval.

The Catalog Cut may be forwarded by mailing, electronically transferring or faxing.



### 9-1.5 **Field Verification of Materials**

All material permanently incorporated into a Contract shall be field verified by the Inspector. Field verification documentation for aggregate, all components of hot mix asphalt and concrete is by receipt of delivery tickets and/or Electronic Tickets (see [Section 10-2.1C](#) for Electronic Ticket details). Field verification shall occur prior to or during placement of the material. When the Field Inspector signs/initials a Field Note Record (FNR), they are affirming that items requiring field verification have been checked and have been found to be acceptable.

The Field Inspector shall inspect the product, material and construction processes for conformity to the Contract requirements. The Field Inspector shall also inspect the product or material for shipment and handling damage.

The Field Inspector is required to verify that the material being placed is the same material that was submitted on the *Qualified Products List* (QPL) page or as listed on the approved Request for Approval of Material (RAM). The field inspector is also required to verify that the material being installed is the same lot/heat number/roll of material that was tested or certified for acceptance.

For WSDOT Fabrications Inspected items, the Field Inspector shall document the quantity, WSDOT Tag/Stamp/Decal, and Material Origin Foreign or Domestic (F or D) designation in either the Inspector's Daily Report (IDR), QPL Contractor Product Information Page, FNR, or other forms of documentation. The Project Engineer may accept an email from the WSDOT Fabrication Inspection Office as field verification documentation that an item delivered with a missing/unreadable tag or stamp has been inspected and was acceptable at the time/place of inspection by the WSDOT Fabrication Inspector.

If the placement of the materials has occurred prior to approval or acceptance, the Field Inspector is required to document in either the IDR, QPL Contractor Product Information Page, FNR or other forms of documentation all information that can be gathered such as quantity, Manufacturer, Lot, Heat Number, Model or Type. The note in the FNR or IDR will link what was placed once the approval and acceptance documents have been received. The Field Inspector should immediately notify the Office Engineer of the deficiency to ensure missing documentation is obtained.

Photos with dates are good supporting documentation and are highly recommended for all permanently placed materials.

## 9-2 **Materials Fabrication Inspection Office – Inspected Items Acceptance**

### 9-2.1 **General**

All fabrication inspection of construction materials is performed by the WSDOT Materials Fabrication Inspection Office, unless otherwise approved by the State Materials Engineer or Assistant State Materials Engineer - Materials Quality.

Items that are inspected and found to meet Contract requirements by the WSDOT Materials Fabrication Inspection Office are identified by a tag or stamp or an email sent to the Project Office. This type of inspection is generally performed at the manufacturing or fabrication plants; however there are items that are inspected at the job site as identified in [Section 9-4](#). There are various types of stamps or tags used for acceptance of inspected

items, which attest that the item was in full conformance with the Specifications at the time of inspection. The inspected item along with the type of stamp designation is covered under Section 9-2.2.

### 9-2.1A Acceptance of Fabricated Items

The following is the process for the acceptance of WSDOT Fabrication Inspection Office inspected items.

1. The manufacturing or fabrication plant must be approved via the "Request for Approval of Material," (RAM) or the *Qualified Products List* (QPL)
2. The WSDOT Fabrication Inspection Office Inspector will obtain the necessary mill certifications, Certificate of Material Origin (CMO), or other documentation from the manufacturer. After assuring the inspected item and documentation meets Contract requirements the Inspector will identify approved material by applying a stamp or tag shown in [Figure 9-3](#) through [9-7](#).

The WSDOT Fabrication Inspection Office may provide the Project Engineer an email verification that items have been accepted when the Fabrication Inspection Office is certain the materials at the jobsite were inspected. The WSDOT Fabrication Office's email to the Project Engineer will also identify whether the item contained foreign or domestic steel.

Items containing foreign steel or iron, and coating or other processes that were performed outside the United States will be stamped with an "F" identifier. Items containing steel or iron that have been determined to be of domestic origin will be stamped with a "D" identifier. See [Figure 3A](#) and [3B](#). This stamp is in addition to the appropriate acceptance tag or stamp in [Figure 9-3](#), [9-4](#), [9-5](#), and [9-7](#). The "F" or "D" identifier will be stamped next to the acceptance stamp. For those items with an acceptance tag, the "F" or "D" stamp will be stamped on the back of the Tag.

**Figure 3A and 3B Domestic or Foreign Identifier Stamp**

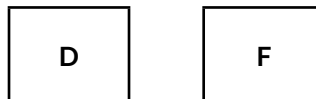

For projects with the Buy America requirement, the Project Engineer is required to obtain the CMO for foreign steel from the Contractor prior to incorporating the material into the project. The amount shown on the CMO as foreign material must be added to the foreign steel and iron tracking sheet for the Contract - DOT Form 350-005 Buy America Foreign Steel Tracking Sheet is available for use.

## 9-2.2 Inspected Items, Stamps, and Tagging Identification

The following are examples of the types of stamps and tags used by the WSDOT Materials Fabrication Inspection Office. The letter or letter number combination on the stamp or tag represents the Inspector who performed the inspection. In [Figure 9-3](#), the Inspector identification is denoted “M” and “G.” In [Figure 9-4](#), the Inspector identification is denoted “N,” and the “001234” is the inspection identification number.

### 9-2.2A Inspected Stamp Identification

The Stamp shown in [Figure 9-3](#) identifies inspection and the Inspector of the following items:

- Expansion Joints (Excluding Modular Expansion Joints)
- Precast Concrete Barrier
- Precast Concrete Catch Basins
- Precast Concrete Drywell
- Precast Concrete Inlets
- Precast Concrete Manholes
- Precast Concrete risers and adjustment sections 12 inches and above
- Signing Hardware
- Other items per the Contract
- Precast Concrete Junction Boxes Type 1, 2, and 8

All documentation associated with the Stamp in [Figure 9-3](#) will be reviewed and approved by the WSDOT Materials Fabrication Inspection Office and kept at the point of Manufacture. Quantities of foreign steel used on the project will not be tracked by the WSDOT Materials Fabrication Inspection Office.

**Figure 9-3 Stamps**

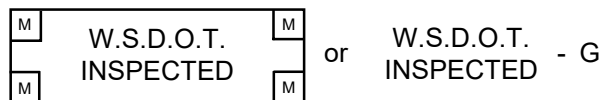

### 9-2.2B Inspected Stamp and Tag Identification

The Stamp shown in [Figure 9-4](#) or Tag shown in [Figure 9-5](#) identifies inspection and the inspector of the following items:

- Anchor Bolts (ASTM A449 and ASTM F1554 Grade 105)
- Bridge Bearings (Disc, Spherical, Cylindrical, and Fabric Pad)
- Cattle guard
- Concrete Drain, Perforated Underdrain, Culvert, and Storm Sewer Pipe (30" and above in diameter)
- Concrete Sanitary Sewer Pipe (30" and above in diameter)
- Epoxy Coated Steel Reinforcing Bars
- Grates (Grate Inlets and Drop Inlets)
- Handrail
- High Mast Light Poles (Contract Provisions)
- High Strength Bolts (shop provided)
- Light and Signal Standards
- Metal Bridge Railing (Steel and Aluminum)
- Miscellaneous Welded Shop Items
- Modular Expansion Joint
- Piles (Structural, Coated, Timber, Composite, Treated Wood, Prestressed Concrete, Steel Pipe Piles for Concrete-Filled Steel Tubes, and Soldier)
- Precast Concrete Bridge Deck Panels
- Precast Concrete Box Culverts, and Split Box Culverts
- Precast Concrete Cable Vaults
- Precast Concrete Floor Panels
- Precast Concrete Junction Boxes Type 4, 5, and 6
- Precast Concrete Marine Pier Deck Panels
- Precast Concrete Noise Barrier Walls
- Precast Concrete Pier Caps
- Precast Concrete Pull Boxes
- Precast Concrete Retaining Walls
- Precast Concrete Roof Panels
- Precast Concrete Structural Earth Walls
- Precast Concrete Vaults (Utility, Drainage, etc.)
- Precast Concrete Wall Panels
- Precast Concrete Wall Stem Panels
- Precast Reinforced Concrete Three Sided Structures
- Prestressed Concrete Girders
- Guardrail Posts with Welded Base Plates
- Seismic Retro Fit Earthquake Restrainers
- Sign Structures
- Steel for Bridges
- Steel Column Jackets
- Structural Steel for State Ferry System
- Wood Bridges
- Other items per the Contract

With the exception of Steel Bridges, Prestressed Concrete Girders, and Bridge and Cantilever Sign Structures, all documentation associated with the stamp in [Figure 9-4](#) or the tag in [Figure 9-5](#) will be reviewed and approved and kept at the point of manufacture. Documentation associated with Steel Bridges, Prestressed Concrete Girders, and Bridge and Cantilever Sign Structures will be reviewed and approved by the WSDOT Materials Fabrication Inspection Office and kept at the WSDOT Materials Fabrication Inspection Office until the documents are sent to the State Records Center for retention. Quantities of foreign steel used on the project will not be tracked by the WSDOT Materials Fabrication Inspection Office.

Figure 9-4 Stamp

**APPROVED  
FOR SHIPMENT  
WASH. DEPT. TRANSP.**

N001234

Figure 9-5 Tag

**APPROVED  
FOR  
SHIPMENT**

\_\_\_\_\_  
Inspector, Washington State  
Department of Transportation

\_\_\_\_\_  
Date

DOT 350-021  
Revised 11/03

### 9-2.2C Inspected Tag Identification

The Tag in [Figure 9-6](#) identifies inspection and the inspector of Treated Timber, Piling and Poles.

All documentation associated with the tag in [Figure 9-6](#) will be reviewed and approved by the WSDOT Materials Fabrication Inspection Office and kept at the WSDOT Materials Fabrication Inspection Office and kept at the point of manufacture.

Figure 9-6 Tag



### 9-2.2D Inspected Casting Stamp Identification

The Stamp shown in [Figure 9-7](#) identifies inspection and the inspector of the following items:

- Gray-Iron Castings
- Steel Castings
- Ductile-Iron Castings (Catch Basin Frame and Grates, Manhole Ring and Covers, etc.)
- Other items per the contact

For Rectangular Frames and Grates, each set shall be stamped aligning the adjacent mating surfaces to each other. This alignment is critical as the leveling pads are ground to prevent rocking of the grates in the frames.

All documentation associated with the stamp in [Figure 9-7](#) will be reviewed and approved by the WSDOT Materials Fabrication Inspection Office and kept at the point of manufacture. Quantities of foreign steel used on the project will not be tracked by the WSDOT Materials Fabrication Inspection Office.

(This Stamp is impressed on the casting and will be circled with spray paint for ease of visibility of the Stamp.)

**Figure 9-7** Stamp

## WSDOT-A

### 9-2.3 **Permanent Sign Inspection**

All permanent signs are required to be inspected prior to installation. The Project Engineer office has the option of inspecting the project signs as detailed in Section 9-2.3B prior to installation or can contact the WSDOT Fabrication office to inspect the permanent signs per Section 9-2.3A at the fabrication facility prior to shipment to the project. The difference is a matter of convenience to the Project Engineer and the choice is up the Project Engineer.

#### 9-2.3A **Sign Inspection by WSDOT Materials Fabrication Inspection Office**

The Project Engineer Office will need to contact the WSDOT Fabrication Inspection Office to schedule the inspection. The WSDOT Materials Fabrication Inspection Office inspects permanent signs at the fabrication facility. Construction and temporary signs are not inspected by the WSDOT Materials Fabrication Inspection Office. The Materials Fabrication Inspector will verify that signs meet the requirements of the contract. The Fabrication inspector will attach a "Fabrication Approved" decal (see [Figure 9-8](#)) to all approved signs prior to shipment of the sign to the job site (except double sided signs). Sign mounting hardware provided by the Sign Fabricator will be inspected and approved by the Materials Fabrication Inspector prior to shipment to the job site. The inspector will stamp each box of hardware "WSDOT INSPECTED" (see [Figure 9-3](#)).

All documentation associated with the decal in [Figure 9-8](#) and stamp in [Figure 9-3](#) will be reviewed and approved by the WSDOT Materials Fabrication Inspection Office and kept at the point of manufacture.

Pre-approval of the Sign Fabricator by Traffic Operations and the WSDOT Materials Fabrication Inspection Office is required.

Figure 9-8



**9-2.3B Sign Inspection by the WSDOT Project Engineer**

If the Project Engineer elects to inspect the signs, the Project Engineer is responsible for inspection of permanent Signs detailed in the Contract Plans. The Project Engineer will verify that signs meet the requirements of the contract. The Project Engineer will attach a “PEO Approved” decal (see Figure 9-9) to all approved signs (except double sided signs, construction, and temporary signs). PEO Approved Decals will be provided to the Project Engineer by WSDOT Materials and Fabrication Inspection Office. Sign mounting hardware provided by the Sign Fabricator will be inspected and approved by the Project Engineer at the job site.

Figure 9-9



## 9-2.4 **Pipe Acceptance Report**

The WSDOT Materials Fabrication inspection Office periodically inspects and witnesses testing of concrete pipe less than 30 in in diameter at approved fabricators. During this inspection, samples of each type, size, and class of pipe are inspected and tested to verify compliance with the *Standard Specifications*.

For a 90-day period from the date of manufacture, concrete pipe less than 30 in in diameter may be shipped and accepted based on “Concrete Pipe Acceptance Reports.” The concrete pipe that ships must be at the age or older than the concrete pipe tested and represented by the Concrete Pipe Acceptance Report. This report is prepared by the Materials Fabrication Inspector and copies are thereafter supplied by the fabricator to accompany each shipment of pipe.

All documentation associated with inspection and acceptance of concrete pipe, and the Concrete Pipe Acceptance Report will be kept at the point of manufacture.

## 9-3 **Guidelines for Job Site Control of Materials**

### 9-3.1 **General**

The intent of sampling and testing is to ensure that the material provided to the project conforms to the specifications. The frequency schedule in [Section 9-3.7](#) covers the minimum requirements for sampling and testing at the project level. The Project Engineer is responsible for obtaining the number of samples necessary to ensure adequate control of the material being produced under the circumstances and conditions of the particular project. There may be cases where production is just getting under way, where source material is variable or marginal in quality. Also operations from commercial sources when small lots of material are being sampled (as for barge loads of aggregate) or when stockpiles are built and depleted may require more frequent sampling and testing. A minimum of one acceptance test is required unless the Project Engineer reduces materials acceptance per [Section 9-1.1](#).

When in doubt as to sampling requirements, refer to Record of Materials (ROM), Request for Approval of Material (RAM), and [Section 9-4](#).

In some instances, items usually sampled by project engineers representative may be sampled and tested by representatives of the State Materials Laboratory or other representatives. Such items as shown in this chapter, when properly identified with an “APPROVED FOR SHIPMENT” Tag, may be accepted for use by the Project Engineer without any further sampling or testing.

### 9-3.2 **Sample Types**

#### 9-3.2A **Preliminary Samples and Tests**

Preliminary samples are intended to show the general character of the materials available or proposed for use. The sample may be taken from a natural deposit, the general stock of a dealer, or elsewhere. The material sampled may require further treatment before it will meet the specification requirements. Preliminary samples are a basis for approving which aggregate site or brand of material will be considered for use. Deliveries cannot be accepted on the basis of preliminary samples unless the samples represent an identified lot of materials.



Unless specified for a particular purpose, preliminary sampling and testing of materials from a potential source are not mandatory functions. It is to be performed when requested by the Project Engineer, Region Materials Engineer or the State Materials Laboratory on the Request for Approval of Material DOT Form 350-071.

### **9-3.2A(1) Sampling and Testing for Aggregate Source Approval**

A pit or quarry source owner may contact the State ASA Engineer directly to request an ASA source approval and will pay all sampling and testing charges. If the Region or project offices elect to sample a pit or quarry for source approval for a project and this is paid by project funds, the samples will have to be obtained by the Region Materials Engineer's designated representative according to WSDOT SOP 128 and include all of the required documentation.

### **9-3.2A(2) Sampling and Testing for Preliminary Hot Mix Asphalt Mix Design**

These samples are used to determine if the aggregate source is capable of meeting the mix design specification requirements. Preliminary samples shall be taken in accordance with WSDOT FOP for AASHTO R 90 and consist of a minimum of 200 pounds of mineral material. Contact the Region materials office if preliminary samples are required. Give full details of type of construction proposed.

### **9-3.2B Acceptance Samples and Tests**

Acceptance samples and tests are defined as those samples tested for determining the quality, acceptability, and workmanship of the materials prior to incorporating the materials into the project. The results of these tests are used to determine conformance to the contract requirements. The minimum frequency for sampling and testing of acceptance samples is detailed in [Section 9-3.7](#).

The Code of Federal Regulations, [49 CFR](#), has listed certain materials to be hazardous. When shipping hazardous materials using a common carrier, i.e. UPS or Fed Ex, the USDOT and the carrier have special requirements that need to be followed. The following is a list of hazardous materials that we commonly sample and test on our projects; paint, epoxy part B, pigmented sealer, form release oil, and polyester resin. When these materials or other hazardous materials need to be sent for testing, contact the Region Materials Laboratory for shipping instructions. The Region Materials Laboratory needs to contact the shipper for proper shipping requirements.

### **9-3.2C Verification Samples and Tests**

Verification samples and tests are used for verifying the reliability of a manufacturer's test results when acceptance of the material is based upon a Manufacturer's Certificate of Compliance. In the event of a failing verification test, the Project Engineer office will be notified by the State Materials Laboratory or the State Construction Office. The Project Office needs to verify whether the material has been used. If the material was used, the Project Engineer office shall contact the State Construction Office which will coordinate with the State Materials Engineer or Assistant State Materials Engineer to determine the appropriate action.

### 9-3.3 Test Numbering

A separate series of numbers, starting with “No. 1” in each instance, shall be used for acceptance, independent assurance, and verification samples for each type of material for which there is a separate bid item. Verification samples shall be referenced to the corresponding Manufacturer’s Certificate of Compliance.

### 9-3.4 Point of Acceptance

#### 9-3.4A State Owned Source

Material produced from a State owned source may be accepted either as it is placed into stockpile or as it is placed in hauling vehicles for delivery to the roadway. The sampling and testing frequency during stockpiling shall be in conformance with [Section 9-3.7](#).

#### 9-3.4B Contractor’s Source

If stockpiled material is set aside exclusively for use on WSDOT projects it may be accepted the same as a state-owned source. If stockpiles are constructed for general use, materials for WSDOT projects shall be tested for acceptance from samples taken by the Project Engineer representative in accordance with WSDOT FOP for AASHTO R 90. The engineer will determine the exact point of acceptance. If an existing stockpile was built without acceptance testing during material production, and later set aside exclusively for use on state projects, the material may be accepted with satisfactory test results from samples taken by the Project Engineer representative in accordance with WSDOT FOP for AASHTO R 90. The sampling and testing frequency shall conform to [Section 9-3.7](#).

### 9-3.5 Basis for Acceptance

The basis of acceptance of Hot Mix Asphalt is by statistical or visual evaluation. The basis of acceptance of aggregate is by statistical or non-statistical evaluation. The method to be used is specified in the *Standard Specifications* or Contract Documents.

#### 9-3.5A Basis for Acceptance – Statistical Evaluation

For materials being accepted using statistical evaluation procedures, random samples will be evaluated to determine quality level within a defined tolerance band. Acceptance, bonus, and disincentive procedures are defined in the contract documents.

Test results with acknowledged errors or equipment deficiencies are to be immediately discarded without recourse and another sample run.

##### 9-3.5A(1) Contractor HMA Retest

Test results for Hot Mix Asphalt may be retested at the request of the Contractor, as defined in the *Standard Specifications* Section 5-04.3(9)B7. This specification allows the Contractor to request a retest of any subplot, provided the request is submitted in writing and within seven calendar days after the specified test results have been posted to a WSDOT website.

A split of the original acceptance sample must be tested utilizing different equipment and a different qualified tester. It is therefore necessary that a split of every field sample (i.e., opposite quarter from acceptance test) be saved in a secure area, accurately marked, and be available for retesting if necessary. The specification requires that the retesting

be performed in the Region Materials Laboratory or the State Materials Laboratory. When the Contractor requests a retest, it is expected that the split sample be sent and tested as quickly as possible. This will require that testing of these samples be prioritized. By expediting the retest, problems that may exist in testing or with the material being produced can be identified and corrected, lessening the impact to both the Contractor and WSDOT.

### **9-3.5B Basis for Acceptance – Non-Statistical Evaluation**

#### **9-3.5B(2) Aggregate**

When the test results for aggregate that are accepted by non-statistical evaluation fall outside the specification limits, the aggregate will be statistically evaluated according to the *Standard Specifications* Section 3-04.3(5).

For materials that do not meet specifications, the Project Engineer office shall contact the State Construction Office which will coordinate with the State Materials Engineer or Assistant State Materials Engineer to determine the appropriate action.

### **9-3.5C Basis for Acceptance – Performance Graded Asphalt Binder and Emulsified Asphalt**

The basis for acceptance of asphalt binder and emulsified asphalts is compliance with existing specifications as modified to include the tolerance as follows:

1. If a binder or emulsified asphalt sample fails to meet the required specifications, the binder or emulsified asphalt samples prior to and subsequent to the failed sample will be tested. Samples of asphalt binder or emulsified asphalt will continue to be tested until samples taken both prior to and subsequent to the failing samples meet the specifications.
2. If a binder or emulsified asphalt sample does not meet the specifications but is not more than 10 percent outside the specification limits and the binder or emulsified asphalt sample prior to and subsequent to the out of specification binder or emulsified asphalt both meet the specifications, there will be no price adjustment.
3. If the binder or emulsified asphalt sample is more than 10 percent out of specification or if the binder or emulsified asphalt sample is less than 10 percent out of specification and the binder or emulsified asphalt sample prior to or subsequent to the out of specification sample does not meet the specifications, the HMA or emulsified asphalt will be rejected.

### **9-3.6 Vacant**

### 9-3.7 Acceptance Sampling and Testing Frequency Guide

Item	Test	Acceptance Sample
Gravel Borrow	Grading & SE	1 – 4000 Ton
Select Borrow	Grading & SE	1 – 4000 Ton
Gravel Borrow for Structural Earth Wall See Note 6	Grading & SE	1 – 4000 Ton
Sand Drainage Blanket	Grading	1 – 4000 Ton
Gravel Base	Grading, SE & Dust Ratio	1 – 4000 Ton
CSTC	Grading, SE & Fracture	1 – 2000 Ton
CSBC	Grading, SE & Fracture	1 – 2000 Ton
Streambed Sediment	Grading	1 – 500 Tons
Maintenance Rock	Grading, SE & Fracture	1 – 2000 Ton
Ballast	Grading, SE & Dust Ratio	1 – 2000 Ton
Permeable Ballast	Grading & Fracture	1 – 2000 Ton
Backfill for Sand Drains	Grading	1 – 2000 Ton
Crushed Coverstone	Grading, SE & Fracture	1 – 1000 Ton
<b>Crushed Screening</b>		
$\frac{5}{8}$ – No. 4	Grading & Fracture	1 – 1000 Ton
$\frac{1}{2}$ – No. 4	Grading & Fracture	1 – 1000 Ton
No. 4 – 0	Grading & Fracture	1 – 1000 Ton
<b>Gravel Backfill for</b>		
Foundations	Grading & SE	1 – 1000 Ton
Walls	Grading, SE & Dust Ratio	1 – 1000 Ton
Pipe Zone Bedding	Grading & SE	1 – 1000 Ton
Drains	Grading	1 – 500 Ton
Dry Wells	Grading	1 – 500 Ton
<b>Concrete Patching Material</b>		
Cylinder (3 hour and 24 hour)	Compressive Strength	1 per Shift
Air Content	Air	1 per Shift
<b>Grout Type 2</b>		
Cube molds (7 day)	Compressive Strength	1 per bridge pier or 1 per Shift
<b>Grout Type 3</b>		
Cube molds (3 hour, 1 day, 7 day)	Compressive Strength	1 per bridge pier or 1 per Shift
<b>Grout Type 4 (Structural Applications)</b>		
Cube mold/cylinder (7 day)	Compressive Strength	1 per bridge pier or 1 per Shift
<b>Mortar Type 3</b>		
Cube molds (7 day)	Compressive Strength	1 per day
<b>CC Paving</b>		
Coarse Aggregate See Note 3	Grading	1 – 2000 CY
Fine Aggregate See Note 3	Grading	1 – 2000 CY
Combined Aggregate See Note 3	Grading	1 – 2000 CY
Air Content	Air	1 – 500 CY
Cylinders (28-day)	Compressive Strength	1 – 500 CY
Measurement	Thickness	1 – 15 Panels
<b>CC Structures (See Note 7)</b>		
Coarse Aggregate See Note 3	Grading	1 – 1000 CY
Fine Aggregate See Note 3	Grading	1 – 1000 CY
Combined Aggregate See Note 3	Grading	1 – 1000 CY
Consistency See Note 4	Slump	1 for every 10 trucks, See Note 4
Air Content See Note 4	Air	1 for every 10 trucks, See Note 4
Temperature See Note 4	Temperature	1-1000 CY
Cylinders (28-day)	Compressive Strength	1 for every 10 trucks, See Note 4

Item	Test	Acceptance Sample
<b>Hot Mix Asphalt (See Note 8)</b>		
Completed Mix, See Note 1		
<20,000 Tons	Va, VMA, Grading & Asphalt Content	1 - 1,000 Tons
20,000 to 30,000 Tons	Va, VMA, Grading & Asphalt Content	1 - 1,500 Tons
>30,000 Tons	Va, VMA, Grading & Asphalt Content	1 - 2,000 Tons
<20,000 Tons	Compaction	1 - 100 Ton
20,000 to 30,000 Tons	Compaction	1 - 150 Ton
>30,000 Tons	Compaction	1 - 200 Ton
<b>Hot Mix Asphalt Aggregate (See Note 8)</b>		
Aggregate	SE, Fracture, Uncompacted Void Content of Fine Aggregate	1 - 2,000 Ton

Asphalt Materials		Certification	
Asphalt Binder (PG, Etc.)	Verification:	2-1 quart	Every other mix acceptance sample, see Note 2
Emulsified Asphalt for Bituminous Surface Treatment (BST)	Verification:	2-1 quart	Every other shipment
Emulsified Asphalt for Fog Seal	Verification:	None Required	
Emulsified Asphalt for HMA Tack Coat	Verification:	2-1 quart	1 sample per project (Statistically Evaluated Projects Only)

<b>Compaction (See Note 5)</b>	
Embankment	1 - 2500 CY
Cut Section	1 - 500 LF
Surfacing	1 - 1,000 LF (per layer)
Backfill	1 - 500 CY

- Note 1 Mix design conformation samples shall be submitted to the State Materials Laboratory Bituminous Materials Section. For all projects, beginning with the first Acceptance sample, submit one sample (two representative quarters) every 10,000 mix tons. The conformation samples should be taken in conjunction with and be representative quarters of the acceptance samples taken for the project as described in FOP for AASHTO R47.
- Note 2 The first sample of asphalt binder will be taken with the second Hot Mix Asphalt (HMA) mix sample.
- Note 3 The frequency for fine, course, and combined concrete aggregate samples for CC Paving and CC Structures shall be based on the cubic yard (CY) of concrete.
- Note 4 Sample the first truck, and each load until loads meet specifications, and then randomly test one load for every 100 CY. If at any time one load fails to meet specifications, continue testing every load until two successive loads meet specifications, and then randomly test one load for every 100 CY.
- Note 5 For materials placed in a non-structural application outside the roadway prism such as slope flattening or shoulder dressing, acceptance for compaction may be based on visual inspection to the satisfaction of the engineer.
- Note 6 The gravel borrow for structural earth walls shall be tested for Los Angeles Wear and Degradation prior to placement and the test data may come from an approved source in the aggregate source approval database. For geosynthetic reinforcement, the gravel borrow shall be tested for pH prior to placement. For metallic reinforcement, the gravel borrow shall be tested for pH, resistivity, chlorides, and sulfates prior to placement. If the resistivity of the backfill material equals or exceeds 5,000 ohm-cm, the specified chloride and sulfate limits may be waived. If the aggregate source has variable quality, additional testing may be required. Contact the Regional Materials Engineer or the State Geotechnical Engineer for direction.
- Note 7 The following concrete applications shall be accepted based on a Certificate of Compliance in accordance with *Standard Specification* Section 6-02.3(5)B and sampling and testing of the aggregate is not required;
- Lean Concrete
  - Commercial Concrete
  - Class 4000P concrete for Roadside Steel Sign Support Foundations.
  - Class 4000P concrete for Type II, III, and CCTV Signal Standard Foundations that are 12'-0" or less in depth.
  - Class 4000P concrete for Type IV and V Strain Pole Foundations that are 12'-0" or less in depth.
  - Class 4000P concrete for Steel Light Standard Foundations Types A & B.
- Note 8 Sampling and testing of HMA will be at the option of the Engineer in accordance with *Standard Specifications* Section 5-04.3(9)D for the following applications; Commercial HMA, sidewalks, road approaches, ditches, slopes, paths, trails, gores, pre-level, temporary pavement, pavement repair, and other non-structural applications approved by the Engineer.

## 9-4 Specific Requirements for Each Material

Materials may be subject to Buy America and/or Build America/Buy America (BABA) requirements when included in the Contract by Special Provision. Refer to Section 9-1.2F.

Section Number	Specific Requirements for Each Material Alphabetical Listing	Page Number
9-4.58	Admixtures for Concrete	9-90
9-4.5	Aggregates for Bituminous Surface Treatment, Ballast, Permeable Ballast, Crushed Surfacing Base and Top Course, Maintenance Rock, and Gravel Backfill for Foundations Class A	9-46
9-4.6	Aggregates for Hot Mix Asphalt (HMA)	9-47
9-4.25	Anchor Bolts, Nuts, and Washers	9-61
9-4.51	Beam Guardrail, Guardrail Anchors, and Guardrail Terminals	9-83
9-4.2	Bituminous Materials	9-44
9-4.32	Bridge Approach Slab Anchors	9-67
9-4.71	Bridge Bearings – Cylindrical, Disc, Fabric Pad, Pin, Spherical	9-99
9-4.76	Concrete	9-103
9-4.4	Concrete Aggregates	9-45
9-4.98	Concrete Blocks	9-119
9-4.16	Concrete Drain, Perforated Underdrain, Culvert, and Storm Sewer Pipe	9-54
9-4.81	Concrete Patching Material, Grout and Mortar	9-107
9-4.64	Conduit	9-95
9-4.75	Construction Geosynthetics (Geotextiles and Geogrids)	9-102
9-4.17	Corrugated Galvanized Steel, Aluminized Steel, Aluminum: Drain, Perforated Underdrain, Culvert Pipe Arch, and Storm Sewer Pipe	9-55
9-4.30	Dowels and Tie Bars for Concrete Pavement	9-65
9-4.70	Elastomeric Pads	9-99
9-4.13	Elastomeric Expansion Joint Seals	9-53
9-4.65	Fiber Optic Cable, Electrical Conductors, and Cable	9-95
9-4.93	Electrical Service Cabinets	9-117
9-4.60	Epoxy Systems	9-91
9-4.80	Erosion Control Devices	9-106
9-4.78	Expansion Joints	9-104
9-4.89	Fabricated/Welded Miscellaneous Metal Drainage Items: Grate Inlets and Drop Inlets	9-115
9-4.50	Fencing and Gates	9-82
9-4.47	Fertilizer	9-78
9-4.97	Flow Restrictors and Oil Separators	9-119
9-4.62	Gabion Cribbing, Hardware, and Stone	9-93
9-4.9	Aggregate Materials for Walls (Gravel Borrow for Structural Earth Walls)	9-48
9-4.52	Guardrail Posts and Blocks	9-85
9-4.24	High Strength Bolts, Nuts, and Washers	9-60
9-4.7	Hot Mix Asphalt (HMA)	9-47
9-4.15	Hot Poured Joint Sealants	9-54
9-4.100	Intelligent Transportation Systems (ITS)/System Operations Management (SOM) Materials	9-120
9-4.49	Irrigation System	9-81
9-4.85	Junction Boxes, Cable Vaults, and Pull Boxes	9-111
9-4.57	Liquid Concrete Curing Compound	9-90
9-4.68	Luminaires, Lamps, and Light Emitting Diodes (LED)	9-97
9-4.28	Mechanical Splices	9-63
9-4.101	Media Filter Drain Mix	9-122
9-4.74	Metal Bridge Rail	9-101
9-4.96	Metal Trash Racks, Debris Cages, and Safety Bars for Culvert Pipe and Other Drainage Items	9-118
9-4.8	Mineral Filler	9-48

Section Number	Specific Requirements for Each Material Alphabetical Listing	Page Number
9-4.10	Miscellaneous Aggregates: Gravel Base, Gravel Backfill for Foundation Class B, Gravel Backfill for Walls, Gravel Backfill for Pipe Zone Bedding, Gravel Backfill for Drains, Gravel Backfill for Drywells, Backfill for Sand Drains, Sand Drainage Blanket, Gravel Borrow, Select Borrow, Common Borrow, Native Materials for Trench Backfill, Foundation Material Class A, B, and C, and Bank Run Gravel for Trench Backfill	9-49
9-4.53	Miscellaneous Precast Concrete Products (Block Traffic Curb, Precast Traffic Curb)	9-85
9-4.90	Miscellaneous Steel Structures (Cattle Guards, Handrail, Guardrail Posts with Welded Base Plate, Seismic Retrofit Earthquake Restrainers, Column Jackets)	9-115
9-4.91	Miscellaneous Welded Structural Steel	9-116
9-4.84	Modular Expansion Joint	9-111
9-4.94	Monument Case, Cover, and Riser	9-118
9-4.48	Mulch	9-79
9-4.35	Painting, Paints, Coating, and Related Materials	9-68
9-4.3	Pavement Marker Adhesive	9-45
9-4.55	Pavement Marking Materials	9-86
9-4.38	Piling – All Types	9-71
9-4.44	Plant Material	9-75
9-4.59	Plastic Waterstop	9-91
9-4.18	Polyvinyl Chloride (PVC) and Corrugated Polyethylene (PE) Drain, Perforated Underdrain, Culvert, and Storm Sewer Pipe	9-56
9-4.1	Portland Cement, Blended Hydraulic Cement, Rapid Hardening Hydraulic Cement, Fly Ash, and Other Cementitious Materials	9-43
9-4.14	Poured Rubber Joint Sealer – Two Component	9-53
9-4.86	Precast Bridge Deck Panels, Floor Panels, Marine Pier Deck Panels, Noise Barrier Walls, Pier Caps, Retaining Walls, Roof Panels, Structural Earth Walls, Wall Panels, and Wall Stem Panels	9-113
9-4.72	Precast Concrete Barrier	9-100
9-4.40	Precast Concrete Manholes, Catch Basins, Inlets and Drywells	9-73
9-4.41	Adjustment Sections for Drainage Structures	9-73
9-4.88	Precast Concrete Vaults (Utility, Drainage, etc.)	9-114
9-4.87	Concrete Three Sided Structures, Box Culverts and Split Box Culverts	9-114
9-4.12	Premolded Joint Filler for Expansion Joints	9-52
9-4.54	Prestressed Concrete Girders	9-86
9-4.34	Prestressing/Post Tensioning Reinforcement – Bar	9-68
9-4.33	Prestressing/Post Tensioning Reinforcement – Strand	9-67
9-4.29	Rebar Chairs, Mortar Blocks (Dobies), and Spacers	9-64
9-4.11	Recycled Materials	9-50
9-4.26	Reinforcing Bars for Concrete (Uncoated and Epoxy Coated Rebar)	9-62
9-4.61	Resin Bonded Anchors	9-92
9-4.42	Riprap, Rock for Erosion and Scour Protection, Quarry Spalls, Rock for Rock Wall and Chinking Material, Backfill for Rock Wall, and Stone for Gabions	9-74
9-4.21	Sanitary Sewers	9-58
9-4.46	Seed	9-77
9-4.43	Semi-Open Slope Protection	9-75
9-4.56	Signing Materials, Mounting Hardware, Posts, and Sign Supports	9-87
9-4.95	Steel Bollards	9-118
9-4.20	Steel, Gray-Iron, and Ductile-Iron Castings: Manhole Rings and Covers; Metal Frame, Grate, and Solid Metal Cover for Catch Basins or Inlets; Cast Metal Inlets; Frame (Ring), Grate, and Cover for Drywells	9-57
9-4.66	Steel Poles – ITS, Pedestrian, Light, Signal Standards, and High Mast Light Poles	9-96
9-4.63	Steel Sign Structures – Cantilever, Sign Bridge, Bridge Mounted, Roadside	9-94
9-4.82	Streambed Aggregates	9-109
9-4.19	Structural Plate Pipes, Arches, and Boxes	9-56



Section Number	Specific Requirements for Each Material Alphabetical Listing	Page Number
<a href="#">9-4.22</a>	Structural Steel for Bridges	<a href="#">9-59</a>
<a href="#">9-4.83</a>	Temporary Traffic Control Materials	<a href="#">9-109</a>
<a href="#">9-4.36</a>	Timber and Lumber	<a href="#">9-70</a>
<a href="#">9-4.45</a>	Topsoil	<a href="#">9-76</a>
<a href="#">9-4.79</a>	Traffic Signal Controller Assembly	<a href="#">9-105</a>
<a href="#">9-4.23</a>	Unfinished Bolts (Ordinary Machine Bolts), Nuts, and Washers	<a href="#">9-60</a>
<a href="#">9-4.69</a>	Water Distribution System	<a href="#">9-98</a>
<a href="#">9-4.77</a>	Water for Concrete	<a href="#">9-104</a>
<a href="#">9-4.31</a>	Wire Reinforcement for Concrete	<a href="#">9-66</a>
<a href="#">9-4.92</a>	Wood Bridges	<a href="#">9-117</a>
<a href="#">9-4.27</a>	Vacant	<a href="#">9-63</a>
<a href="#">9-4.37</a>	Vacant	<a href="#">9-71</a>
<a href="#">9-4.39</a>	Vacant	<a href="#">9-72</a>
<a href="#">9-4.40</a>	Vacant	<a href="#">9-76</a>
<a href="#">9-4.67</a>	Vacant	<a href="#">9-97</a>
<a href="#">9-4.73</a>	Vacant	<a href="#">9-101</a>
<a href="#">9-4.99</a>	Vacant	<a href="#">9-120</a>

### 9-4.1 **Portland Cement, Blended Hydraulic Cement, Rapid Hardening Hydraulic Cement, Fly Ash, and Other Cementitious Materials**

1. **Approval of Material** – In accordance with *Standard Specifications* Section 1-06, approval of materials is required prior to use. Materials will be approved by the Qualified Products List or Request for Approval of Material DOT Form 350-071. Be certain to verify that the product is in fact qualified for its intended use and the product is listed under the appropriate specification.
2. **Preliminary Samples** – Preliminary samples will be required only if coded on the Request for Approval of Material DOT Form 350-071.
3. **Acceptance/Verification**
  - a. **Acceptance**
    - i. **Bulk Cement** – Acceptance shall be by receipt of a Manufacturer’s Mill Test Report. The Mill Test Report Number shall be reported on each certified Concrete Delivery Ticket and/or Electronic Ticket.
    - ii. **Bagged Cement**
      - **Less than 400 Bags** – Visual Acceptance per [Section 9-1.4C](#). Verify each Bag is labeled meeting the requirements of AASHTO M 85 or ASTM C150.
      - **400 Bags and Greater** – Acceptance shall be by “Satisfactory” test reports from the State Materials Laboratory. Obtain a 10-pound sample from one of every 400 bags and ship to the State Materials Laboratory for testing.
    - iii. **Rapid Hardening Hydraulic Cement** – Acceptance shall be by receipt of a Manufacturer’s Mill Test Report submitted with Mix Design.
    - iv. **Fly Ash** – Acceptance shall be by receipt of a Manufacturer’s Mill Test Report submitted with Mix Design.
    - v. **Ground Granulated Blast Furnace Slag** – Acceptance shall be by receipt of a Manufacturer’s Mill Test Report submitted with Mix Design.

- vi. **Microsilica Fume** – Acceptance shall be by receipt of a Manufacturer’s Mill Test Report submitted with Mix Design.
  - vii. **Natural Pozzolan** – Acceptance shall be by receipt of a Manufacturer’s Mill Test Report submitted with Mix Design.
  - viii. **Blended Supplementary Cementitious Material** – Acceptance shall be by receipt of a Manufacturer’s Mill Test Report submitted with Mix Design.
- b. **Verification** – Cement producers, importers/distributors, and suppliers that certify Portland cement or blended cement will provide samples directly to the State Materials Laboratory on a quarterly basis for comparison with the manufacturer’s mill test report per WSDOT Standard Practice QC-1. The Project Engineer office will be notified in the event of a failing test report. The PEO will be required to check Concrete Delivery Tickets and/or Electronic Tickets for failing mill test numbers to ensure that the failing cement from that mill test was not placed.
4. **Field Inspection** – Field verify per [Section 9-1.5](#).
5. **Specification Requirements** – See *Standard Specifications* Section 9-01, 9-23.9, 9-23.10, and 9-23.11. Review contract documents to determine if supplemental specifications apply.
6. **Other Requirements** – Allow a minimum of 14 days from receipt of the sample at the Laboratory for testing. DO NOT permit the use of bagged cement until a “Satisfactory” test report has been received from the State Materials Laboratory.

#### 9-4.2 Bituminous Materials

1. **Approval of Material** – In accordance with *Standard Specifications* Section 1-06, approval of materials is required prior to use. Materials will be approved by the Qualified Products List or Request for Approval of Material DOT Form 350-071. Be certain to verify that the product is in fact qualified for its intended use and the product is listed under the appropriate specification.
2. **Preliminary Samples** – A preliminary sample of the material will be required only if coded on the Request for Approval of Material DOT Form 350-071.
3. **Acceptance/Verification**
  - a. **Acceptance** – Acceptance shall be by the Asphalt Supplier’s Certification of Compliance incorporated in their Bill of Lading with the information required by *Standard Specifications* Section 9-02.
  - b. **Verification** – Samples for verification conformance will be taken based on the frequencies stated in [Section 9-3.7](#). Because the entire sample may be used in testing, it is necessary to take a backup for each sample. The samples shall be taken and labeled in duplicate by the engineer with both samples forwarded promptly to the State Materials Laboratory. Consult the FOP for AASHTO R 66 for detailed sampling procedures.

Enter complete data on gummed label DOT Form 350-016 and attach to each of the two cans. Complete a Sample Transmittal DOT Form 350-056 and attach it, in its envelope, to the container. If tape is used to attach envelope to container, or the containers together, be sure the tape is not contacting the label(s).

The Project Engineer office will be notified in the event of a failing test report. The PEO shall refer to Section 9-3.5C and contact WSDOT Roadway Construction Office for possible price adjustment.

4. **Field Inspection** – Field verify per [Section 9-1.5](#).
5. **Specification Requirements** – See *Standard Specifications* Section 9-02. Review contract documents to determine if supplemental specifications apply.
6. **Other Requirements** – None.

### 9-4.3 **Pavement Marker Adhesive**

1. **Approval of Material** – In accordance with *Standard Specifications* Section 1-06, approval of materials is required prior to use. Materials will be approved by the Qualified Products List or Request for Approval of Material DOT Form 350-071. Be certain to verify that the product is in fact qualified for its intended use and the product is listed under the appropriate specification.
2. **Preliminary Samples** – A preliminary sample of the material will be required only if coded on the Request for Approval of Material DOT Form 350-071. Submit Manufacturers Certificate of Compliance meeting the requirements of *Standard Specifications* Section 1-06.3, including supporting tests reports to State Materials Laboratory for evaluation.
3. **Acceptance**
  - a. **Flexible Bituminous Pavement Marker Adhesive** – If the lot is listed on the QPL, it may be used without testing on current projects per Section 9-1.4A(1). If the lot is not on the QPL, submit a sample taken by, or in the presence of, an agency representative for each lot. Samples must be submitted for testing 10 days prior to use of adhesive. Samples submitted shall be accepted on receipt of “Satisfactory” test reports from the State Materials Laboratory.
  - b. **Epoxy Adhesive** – Acceptance shall be by the Manufacturer’s Certificate of Compliance per [Section 9-1.4D](#).
4. **Field Inspection** – Field Verify per [Section 9-1.5](#).
5. **Specification Requirements** – See *Standard Specifications* Section 9-02.1(8) and 9-26.2. Review contract documents to determine if supplemental specifications apply.
6. **Other Requirements** – There may be special shipping requirements for adhesive. These samples shall be transported to the Region Materials Laboratory for proper shipping.

Materials may be subject to Buy America and/or Build America/Buy America (BABA) requirements when included in the Contract by Special Provision. Refer to Section 9-1.2E.

### 9-4.4 **Concrete Aggregates**

1. **Approval of Material** – In accordance with *Standard Specifications* Section 1-06, approval of materials is required prior to use. Consult the Aggregate Source Approval (ASA) database for approval status of the material for each source. If the ASA database indicates the aggregate source has expired or will expire before the end of the project, a source evaluation will be required. Contact the Region Materials Office for further

direction. If samples are required, the Region Materials Office will coordinate with the Materials Quality Assurance Section QPL/ASA Engineer to obtain the necessary samples in accordance with SOP 128.

Source approval is not required for aggregates used for Commercial Concrete, as described in *Standard Specifications* Section 6-02.3(2)B.

2. **Preliminary Samples** – A preliminary sample of the material will be required only if coded on the Request for Approval of Material DOT Form 350-071.
3. **Acceptance** – Acceptance shall be administered in accordance with *Standard Specifications* Section 3-04. Acceptance samples shall be obtained, tested, and recorded in accordance with the contract documents, and Sections 9-3.7 and 9-7.
4. **Field Inspection** – Field verify per [Section 9-1.5](#).
5. **Specification Requirements** – See *Standard Specifications* Section 3-02, 3-04, 6-02.3(2) B, 9-03.1, and 9-03.2. Review contract documents to determine if supplemental specifications apply.
6. **Other Requirements** – Consult the ASA database to see if Alkali Silica Reactive (ASR) mitigation is required. ASR mitigation is not required for Commercial Concrete as identified in *Standard Specifications* Section 6-02.3(B).

#### **9-4.5 Aggregates for Bituminous Surface Treatment, Ballast, Permeable Ballast, Crushed Surfacing Base and Top Course, Maintenance Rock, and Gravel Backfill for Foundations Class A**

1. **Approval of Material** – In accordance with *Standard Specifications* Section 1-06, approval of materials is required prior to use. Consult the Aggregate Source Approval (ASA) database for approval status of the material for each source. If the ASA database indicates that the aggregate source has expired, or will expire before the end of the project, a source evaluation may be required. Contact the Region Materials Office for further direction. If samples are required, the Region Materials Office will coordinate with the Materials Quality Assurance Section QPL/ASA Engineer to obtain the necessary samples according to SOP 128.
2. **Preliminary Samples** – A preliminary sample of the material will be required only if coded on the Request for Approval of Material DOT Form 350-071.
3. **Acceptance** – Acceptance shall be administered in accordance with *Standard Specifications* Section 3-04. Acceptance samples shall be obtained, tested, and recorded in accordance with the contract documents, and Sections 9-3.7 and 9-7.
4. **Field Inspection** – Field verify per [Section 9-1.5](#).
5. **Specification Requirements** – See *Standard Specifications* Section 3-02, 3-04, 9-03.4, 9-03.9, and 9-03.12(1)A. Review contract documents to determine if supplemental specifications apply.
6. **Other Requirements** – Refer to *Standard Specifications* Section 9-03.21 to see if recycled materials are permitted.

### 9-4.6 **Aggregates for Hot Mix Asphalt (HMA)**

1. **Approval of Material** – In accordance with *Standard Specifications* Section 1-06, approval of materials is required prior to use. Consult the Aggregate Source Approval (ASA) database for approval status of the material for each source. If the ASA database indicates that the aggregate source has expired, or will expire before the end of the project, a source evaluation may be required. Contact the Region Materials Office for further direction. If samples are required, the Region Materials Office will coordinate with the Materials Quality Assurance Section QPL/ASA Engineer to obtain the necessary samples according to SOP 128.
2. **Preliminary Samples** – A preliminary sample of the material will be required only if coded on the Request for Approval of Material DOT Form 350-071.
3. **Acceptance** – Acceptance shall be administered in accordance with contract documents and *Standard Specifications* Sections 3-04 and 5-04.3(8)2. Acceptance samples shall be obtained, tested, and recorded in accordance with the contract documents, and Sections 9-3.7 and 9-7.

The requirements for fracture, sand equivalent and uncompacted void content of fine aggregate shall apply at the time of its introduction to the cold feed of the mixing plant. Acceptance of the aggregate for gradation shall be in accordance with [Section 9-4.7](#).

4. **Field Inspection** – Field verify per [Section 9-1.5](#).
5. **Specification Requirements** – See *Standard Specifications* Sections 3-02, 3-04, 5-04, and 9-03.8. Review contract documents to determine if supplemental specifications apply.
6. **Other Requirements** – Refer to *Standard Specifications* Section 9-03.21 and contract provisions to see if recycled materials are permitted.

### 9-4.7 **Hot Mix Asphalt (HMA)**

1. **Approval of Material** – In accordance with *Standard Specifications* Section 1-06, approval of materials is required prior to use. Materials will be approved by the Qualified Products List. Be certain to verify that the product is in fact qualified for its intended use and the product is listed under the appropriate specification. Commercial HMA may be approved without evaluating mix design, contact the State Materials Laboratory.
2. **Preliminary Samples** – Not required.
3. **Acceptance** – Acceptance samples shall be obtained, tested, and recorded in accordance with the *Standard Specifications*, the contract special provisions, and [Section 9-3](#) and [9-7](#). When used in HMA, the Recycled Asphalt Pavement (RAP) and Reclaimed Asphalt Shingles (RAS) components are considered incidental to the HMA acceptance testing.
  - a. **Statistical** – Acceptance shall be administered under *Standard Specifications* Section 5-04.
  - b. **Visual** – Acceptance shall be at the option of the Project Engineer.
  - c. **Commercial** – Acceptance shall be at the option of the Project Engineer.

4. **Field Inspection** – Field verify per [Section 9-1.5](#).
5. **Specification Requirements** – See *Standard Specifications* Section 5-04 and 9-03.8. Review contract documents to determine if supplemental specifications apply.
6. **Other Requirements** – The Project Engineer should perform a plant inspection prior to production. Contact the Region materials office for assistance with this inspection.

#### 9-4.8 **Mineral Filler**

1. **Approval of Material** – In accordance with *Standard Specifications* Section 1-06, approval of materials is required prior to use. Materials will be approved by the Qualified Products List or Request for Approval of Material DOT Form 350-071. Be certain to verify that the product is in fact qualified for its intended use and the product is listed under the appropriate specification.
2. **Preliminary Sample** – A preliminary sample of the material will be required only if coded on the Request for Approval of Material DOT Form 350-071. If required, ship 3 pounds in a polyethylene bag.
3. **Acceptance** – Acceptance of mineral filler (commercial stone dust) shall be based on “Satisfactory” laboratory tests only for each lot of 50 tons or less. Portland cement may be accepted without test if it is furnished in original factory sacks and is not lumpy.
4. **Field Inspection** – Field verify per [Section 9-1.5](#).
5. **Specification Requirements** – See *Standard Specifications* Section 9-03.8(5). Review contract documents to determine if supplemental specifications apply.
6. **Other Requirements** – None.

#### 9-4.9 **Aggregate Materials for Walls (Gravel Borrow for Structural Earth Walls)**

1. **Approval of Material** – In accordance with *Standard Specifications* Section 1-06 approval of materials is required prior to use. Consult the Aggregate Source Approval (ASA) database for approval status of the material for each source. If the ASA database indicates that the aggregate source has expired, or will expire before the end of the project, a source evaluation may be required. Contact the Region materials office for further direction. If samples are required, the Region materials office will coordinate with the Materials Quality Assurance Section QPL/ASA Engineer to obtain the necessary samples according to SOP 128.
2. **Preliminary Samples** – A preliminary sample of the material will be required only if coded on the Request for Approval of Material DOT Form 350-071.
  - a. **Gravel Borrow for Structural Earth Walls** – Shall be tested for Los Angeles Wear and Degradation prior to placement. If the source has current testing and listed in the ASA database, then the Los Angeles Wear and Degradation value can be used for approval. If the material does not have a current listing in the ASA database, a sample will have to be tested for Los Angeles Wear and Degradation.
  - i. **Geosynthetic Reinforcement** – Prior to delivery of the material to the project a preliminary sample of material will be required to be tested for pH to determine if the material in fact meets specification requirements for the intended use.

- ii. **Metallic Reinforcement** – Prior to delivery of the material to the project a preliminary sample of material will be required to be tested for pH, Resistivity, Chlorides, and Sulfates to determine if the material in fact meet specification requirements for the intended use. If the Resistivity equals or exceeds 5,000 ohm-cm, the specified Chlorides and Sulfates limits may be waived.
3. **Acceptance** – Acceptance shall be administered in accordance with *Standard Specifications* Section 3-04. Acceptance samples shall be obtained, tested, and recorded in accordance with contract documents and Sections 9-3.7 and 9-7.
4. **Field Inspection** – Field verify per Section 9-1.5.
5. **Specification Requirements** – See *Standard Specifications* Sections 3-02, 3-04, 9-03.12(2), and 9-03.14(4). Review contract documents to determine if supplemental specifications apply.
6. **Other Requirements** – Refer to *Standard Specifications* Section 9-03.21 to see if recycled materials are permitted. Gravel Borrow for Structural Earth Walls, refer to *Standard Specifications* Section 9-03.14(4) if recycled materials are permitted.

**9-4.10 Miscellaneous Aggregates: Gravel Base, Gravel Backfill for Foundation Class B, Gravel Backfill for Wall, Gravel Backfill for Pipe Zone Bedding, Gravel Backfill for Drains, Gravel Backfill for Drywells, Backfill for Sand Drains, Sand Drainage Blanket, Gravel Borrow, Select Borrow, Common Borrow, Native Materials for Trench Backfill, Foundation Material Class A, B, and C, and Bank Run Gravel for Trench Backfill**

1. **Approval of Material** – Approval is not required.
2. **Preliminary Samples** – A preliminary sample of the materials will be required only if coded on the Request for Approval of Material DOT Form 350-071.
  - a. **Common Borrow** – Prior to delivery of the materials consult with the Region Materials Engineer to determine if a preliminary sample is required to determine if the material meets the requirements of *Standard Specifications* Section 9-03.14(3).
3. **Acceptance**
  - a. **Aggregate for Gravel Base, Gravel Backfill for Foundations Class B, Gravel Backfill for Wall, Gravel Backfill for Pipe Zone Bedding, Gravel Backfill for Drains, Gravel Backfill for Drywells, Backfill for Sand Drains, Gravel Borrow, Select Borrow, Foundation Material Class A, B, and C, and Bank Run Gravel for Trench Backfill** – Acceptance shall be administered in accordance with *Standard Specifications* Section 3-04. Acceptance samples shall be obtained, tested, and recorded in accordance with the contract documents, and Sections 9-3.7 and 9-7.
  - b. **Native Material for Trench Backfill** – Visual Acceptance per Section 9-1.4C. Verify that trench backfill is free of wood waste, debris, clods or rock greater than 6 inches in any dimension.
  - c. **Common Borrow** – Visual Acceptance per Section 9-1.4C. Verify that common borrow is free of deleterious materials such as wood, organic waste, coal, charcoal, or any other extraneous or objectionable material.
4. **Field Inspection** – Field verify per Section 9-1.5.

5. **Specification Requirements** – See *Standard Specifications* Section 3-02, 3-04 and 9-03. Review contract documents to determine if supplemental specifications apply.
6. **Other Requirements** – Refer to *Standard Specifications* Section 9-03.21 to see if recycled materials are permitted.

#### 9-4.11 Recycled Materials

1. **Approval of Materials** – In accordance with *Standard Specifications* Section 1-06 approval of recycled material is required prior to use. Recycled materials will be approved by the [Qualified Products List \(QPL\)](#) or Request for Approval of Materials (RAM) DOT Form 350-071. Prior to incorporating recycled materials into the work or storage on the job site, the certification shall be received and retained on the source of all recycled materials. This certification shall state that either the recycled materials are from the contracting agency's roadways or not from the contracting agency's roadways. Recycled materials obtained from the contracting agency's roadways will not require toxicity testing or certification for toxicity characteristics unless requested by the Engineer. Recycled materials that are not from the contracting agency's roadways shall not be incorporated into the work or imported to the jobsite until testing and certification of toxicity characteristics is provided to the Engineer.

Reclaimed Asphalt Shingles shall be non-asbestos containing material (ACM) in accordance with *Standard Specifications* Section 9-03.21(1)A.

Source approval is not required for Recycled Concrete Aggregates used in Commercial Concrete as described in *Standard Specifications* Section 6-02.3(2).

**RAM Submittal** – The Project Engineer can approve the RAM. The Region Materials Engineer can assist the Project Engineer in evaluating these submittals.

2. **Preliminary Samples**
  - a. **Recycled Materials from the Contracting Agency's Roadway** – Certification for toxicity characteristics in accordance with *Standard Specifications* Section 9-03.21(1) is not required. Contact Region Materials Engineer to determine if preliminary sample is required.
  - b. **Recycled Concrete Aggregate Reclamation Facilities listed on the QPL** – For those reclamation facilities that are not participating in WSDOT's quality control programs and are not listed on the QPL, preliminary samples shall be in accordance with Section 2c2 – Recycled Concrete Aggregate. For those reclamation facilities that are participating in WSDOT's quality control programs and are listed on the QPL, preliminary samples shall be accordance with the following:
    - i. **Tier 1** – Preliminary sample for aggregate source properties (LA Wear, Degradation, and Specific Gravity) are not required. Certification for toxicity characteristics in accordance with *Standard Specifications* Section 9-03.21(1) is required prior to delivery and placement.
    - ii. **Tier 2** – Preliminary sample for aggregate source properties (LA Wear, Degradation, and Specific Gravity) are not required unless determined by the Project Engineer. Certification for toxicity characteristics in accordance with *Standard Specifications* Section 9-03.21(1) is not required unless determined by the Project Engineer.



- iii. **Tier 3** – Preliminary sample will be required if the recycled concrete aggregate is being proposed for *Standard Specification* Sections; 9-03.9(1) Ballast, 9-03.9(2) Permeable Ballast, 9-03.9(3) Crush Surfacing, 9-03.12(1)A Gravel Backfill for Foundations Class A, and 9-13.1 Riprap and Quarry Spalls. Certification for toxicity characteristics in accordance *Standard Specifications* Section 9-03.21(1) is required prior to delivery and placement.
- c. **Recycled Materials from Other Sources** – Certification for toxicity characteristics in accordance with *Standard Specifications* Section 9-03.21(1) is required prior to delivery and placement.
- i. **Recycled HMA/Recycled Asphalt Pavement (RAP)** – A preliminary sample will be required if the recycled HMA is being proposed for *Standard Specifications* Sections; 9-03.8 Aggregate for HMA, 9-03.9(1) Ballast, 9-03.9(2) Permeable Ballast, 9-03.9(3) Crushed Surfacing, and 9-03.12(1)A Gravel Backfill for Foundations Class A.
  - ii. **Recycled Concrete Aggregate** – A preliminary sample will be required if the recycled concrete aggregate is being proposed for *Standard Specifications* Sections; 9-03.9(1) Ballast, 9-03.9(2) Permeable Ballast, 9-03.9(3) Crushed Surfacing, 9-03.12(1)A Gravel Backfill for Foundations Class A, and 9-13.1 Riprap and Quarry Spalls.
  - iii. **Recycled Glass (glass cullet)** – A preliminary sample will be required if the recycled glass is being proposed for *Standard Specifications* Sections; 9-03.9(1) Ballast, 9-03.9(2) Permeable Ballast, 9-03.9(3) Crushed Surfacing, and 9-03.12(1)A Gravel Backfill for Foundations Class A.
  - iv. **Reclaimed Aggregate** – Reclaimed aggregate is aggregate that has been recovered from the plastic concrete by washing away the cementitious materials. Reclaimed aggregate is permitted to be used for *Standard Specifications* Section 9-03.1(1). A preliminary sample and certification of toxicity characteristics is not required.
  - v. **Re-Used Aggregate** – A preliminary sample will be required if the re-used aggregate is being proposed for *Standard Specifications* Sections; 9-03.1 Fine and Coarse Concrete Aggregate, 9-03.4 Aggregate for Bituminous Surface Treatment, 9-03.8 Aggregate for Hot Mix Asphalt, 9-03.9(1) Ballast, 9-03.9(2) Permeable Ballast, 9-03.9(3) Crushed Surfacing, 9-03.11 Streambed Aggregates, 9-03.12(1)A Gravel Backfill for Foundations Class A, Section 9-03.14(4) Gravel Borrow for Structural Earth Walls, and 9-13 Riprap and Quarry Spalls.
  - vi. **Steel Furnace Slag** – A preliminary sample will be required if the steel furnace slag is being proposed for *Standard Specifications* Sections; 9-03.9(1) Ballast, 9-03.9(2) Permeable Ballast, 9-03.9(3) Crushed Surfacing, and 9-03.12(1)A.

3. **Acceptance**
  - a. **Concrete Aggregate** – See Section 9-4.4.
  - b. **Aggregate for Bituminous Surface Treatment, Ballast, Permeable Ballast, Crush Surfacing, Maintenance Rock, and Gravel Backfill for Foundations Class A** – See [Section 9-4.5](#).
  - c. **Aggregate for Hot Mix Asphalt (HMA)** – See [Section 9-4.6](#).
  - d. **Recycled Asphalt Pavement (RAP) and Reclaimed Asphalt Shingles (RAS)** – See Section 9-4.7.
  - e. **Gravel Backfill for Walls** – See [Section 9-4.9](#).
  - f. **Gravel Base, Gravel Backfill for Foundations Class B, Gravel Backfill for Pipe Zone Bedding, Gravel Backfill for Drains, Gravel Backfill for Drywells, Backfill for Sand Drains, Sand Drainage Blanket, Gravel Borrow, Select Borrow, Common Borrow, Foundation Material Class A, B, and C, and Bank Run Gravel for Trench Backfill** – See [Section 9-4.10](#).
  - g. **Riprap and Quarry Spalls** – See [Section 9-4.42](#).
4. **Field Inspection** – Field Verify per [Section 9-1.5](#).
5. **Specification Requirements** – See *Standard Specifications* Section 9-03. Review contract documents to determine if supplemental specifications apply.  
**Other Requirements** – If there are questions about the recycled material and its intended use contact the Region Materials Engineer.

#### 9-4.12 **Premolded Joint Filler for Expansion Joints**

1. **Approval of Material** – In accordance with *Standard Specifications* Section 1-06, approval of materials is required prior to use. Materials will be approved by the Qualified Products List or Request for Approval of Material DOT Form 350-071. Be certain to verify that the product is in fact qualified for its intended use and the product is listed under the appropriate specification.
2. **Preliminary Samples** – A preliminary sample of the material will be required only if coded on the Request for Approval of Material DOT Form 350-071. When a preliminary sample is required, it shall consist of a 1 square foot Section of the proposed material. Submit sample to the State Materials laboratory for testing.
3. **Acceptance** – Visual Acceptance per [Section 9-1.4C](#).
4. **Field Inspection** – Field verify per [Section 9-1.5](#).
5. **Specification Requirements** – See *Standard Specifications* Section 9-04.1(2). Review contract documents to determine if supplemental specifications apply.
6. **Other Requirements** – Materials may be subject to Buy America and/or Build America/Buy America (BABA) requirements when included in the Contract by Special Provision. Refer to Section 9-1.2E.

### 9-4.13 **Elastomeric Expansion Joint Seals**

1. **Approval of Material** – Approval of materials is required prior to use. Materials will be approved by the Qualified Products List or Request for Approval of Material DOT Form 350-071. Be certain to verify that the product is in fact qualified for its intended use and the product is listed under the appropriate specification.
2. **Preliminary Samples** – A preliminary sample of the material will be required only if coded on the Request for Approval of Material DOT Form 350-071. When a preliminary sample is required, it shall consist of a 2 feet Section from each lot of material used. Submit sample to the State Materials Laboratory for testing.
3. **Acceptance** – If the lot is listed on the QPL, it may be used without testing on current projects per Section 9-1.4A(1). If the lot is not on the QPL, submit a sample taken by, or in the presence of, an agency representative for each lot. Samples must be submitted for testing 10 days prior to use of joint seal. Samples submitted shall be accepted on receipt of “Satisfactory” test reports from the State Materials Laboratory.  
**Sample** – The sample shall consist of a 2 feet Section from each lot of material used.
4. **Field Inspection** – Field verify per [Section 9-1.5](#).
5. **Specification Requirements** – See *Standard Specifications* Section 9-04.1(4). Review contract documents to determine if supplemental specifications apply.
6. **Other Requirements** – Materials may be subject to Buy America and/or Build America/Buy America (BABA) requirements when included in the Contract by Special Provision. Refer to Section 9-1.2E.

### 9-4.14 **Poured Rubber Joint Sealer – Two Component**

1. **Approval of Material** – In accordance with *Standard Specifications* Section 1-06, approval of materials is required prior to use. Materials will be approved by the Qualified Products List or Request for Approval of Material DOT Form 350-071. Be certain to verify that the product is in fact qualified for its intended use and the product is listed under the appropriate specification.
2. **Preliminary Samples** – A preliminary sample of the material will be required only if coded on the Request for Approval of Material DOT Form 350-071.
3. **Acceptance** – If the lot is listed on the QPL, it may be used without testing on current projects per Section 9-1.4A(1). If the lot is not on the QPL, submit a sample taken by, or in the presence of, an agency representative for each lot. Samples must be submitted for testing 10 days prior to use of joint sealer. Samples submitted shall be accepted on receipt of “Satisfactory” test reports from the State Materials Laboratory.  
**Sample:** The sample shall consist of an unopened container of each component (kit) from each lot, mixing instructions, and SDS sheets. Submit sample to the State Materials Laboratory for testing.
4. **Field Inspection** – Field verify per [Section 9-1.5](#).
5. **Specification Requirements** – See *Standard Specifications* Section 9-04.2(2). Review contract documents to determine if supplemental specifications apply.
6. **Other Requirements** – Materials may be subject to Buy America and/or Build America/Buy America (BABA) requirements when included in the Contract by Special Provision. Refer to [Section 9-1.2E](#).

### 9-4.15 Hot Poured Joint Sealants

1. **Approval of Material** – In accordance with Section 1-06 of the *Standard Specifications*, approval of materials is required prior to use. Materials will be approved by the Qualified Products List (QPL) or Request for Approval of Material (RAM) DOT Form 350-071. Be certain to verify that the product is in fact qualified for its intended use and the product is listed under the appropriate specification.

**RAM Submittal** – If the hot poured sealant material is not listed on the QPL submit one box sample to the State Materials Laboratory for preliminary evaluation. The Project Engineer can approve the RAM for the material components of the Sand Slurry.

2. **Preliminary Samples** – A preliminary sample of the material will be required only if coded on the Request for Approval of Material DOT Form 350-071.
3. **Acceptance**
  - a. **Hot Poured Sealants** – If the lot is listed on the QPL, it may be used without testing on current projects per Section 9-1.4A(1). If the lot is not on the QPL, submit a sample taken by, or in the presence of, an agency representative for each lot. Samples must be submitted for testing 10 days prior to use of joint sealant. Samples submitted shall be accepted on receipt of “Satisfactory” test reports from the State Materials Laboratory.

**Sample** – When a sample is required, submit a one box sample to the State Materials Laboratory for testing.
  - b. **Sand Slurry** – Acceptance shall be by Visual Acceptance per [Section 9-1.4C](#).
4. **Field Inspection** – Field verify per [Section 9-1.5](#).
5. **Specification Requirements** – See *Standard Specifications* Section 9-04.2(1) for hot poured joint sealants. Review contract documents to determine if supplemental specifications apply.
6. **Other Requirements** – Materials may be subject to Buy America and/or Build America/Buy America (BABA) requirements when included in the Contract by Special Provision. Refer to [Section 9-1.2E](#).

### 9-4.16 Concrete Drain, Perforated Underdrain, Culvert, and Storm Sewer Pipe

1. **Approval of Material** – Approval of the Fabricator is required prior to fabrication. The Fabricator will be approved by the Qualified Products List or Request for Approval of Material DOT Form 350-071. Be certain to verify that the product is in fact qualified for its intended use, and the product is listed under the appropriate specification. Materials used within the fabricated item do not require approval through the Project Engineer office. Provide the WSDOT Materials Fabrication Inspection Office with a copy of the Qualified Products Page or Request for Approval of Material listing the Fabricator. Review of the Contract Special Provisions is necessary to determine if special qualifications or testing is required for approval of the fabricator.
2. **Preliminary Samples** – A preliminary sample of the material will be required only if coded on the Request for Approval of Material DOT Form 350-071.

### 3. Acceptance

- a. Concrete pipe less than 30 inch in diameter is accepted based on “Concrete Pipe Acceptance Reports” which shall accompany the pipe to the job site. Inspect the manufacture date marked on each pipe to verify that it was made within the period covered by the Concrete Pipe Acceptance Report.
- b. Concrete pipe 30 inch in diameter and larger are individually inspected and stamped for approval by the Materials Fabrication Inspector at the fabrication facility prior to shipment. Acceptance is based on “APPROVED FOR SHIPMENT” Stamp (Figure 9-4). An “F” or “D” will be stamped to indicate the steel or iron is of foreign or domestic origin.

### 4. Field Inspection - Field verify per Section 9-1.5.

### 5. Specification Requirements – See *Standard Specifications* Section 9-05. Review contract documents to determine if supplemental specifications apply.

### 6. Other Requirements

- a. **Materials Fabrication Inspected CMO (30 inch in Diameter and larger) –** Certification of Material Origin will be the responsibility of the Materials Fabrication Inspector as defined in Section 9-2.1A.

Materials may be subject to Buy America and/or Build America/Buy America (BABA) requirements when included in the Contract by Special Provision. Refer to Section 9-1.2E.

- b. **Non-Fabrication Inspected CMO (less than 30 inch in Diameter) –** Materials may be subject to Buy America and/or Build America/Buy America (BABA) requirements when included in the Contract by Special Provision. Refer to Section 9-1.2E

## 9-4.17 ***Corrugated Galvanized Steel, Aluminized Steel, Aluminum: Drain, Perforated Underdrain, Culvert Pipe Arch, and Storm Sewer Pipe***

1. **Approval of Material** – In accordance with *Standard Specifications* Section 1-06, approval of materials is required prior to use. Materials will be approved by the Qualified Products List or Request for Approval of Material DOT Form 350-071. An on-site inspection of the fabricating facilities prior to approval will be required only if a new manufacture is requested on the Request for Approval of Material DOT Form 350-071. Be certain to verify that the product is in fact qualified for its intended use and the product is listed under the appropriate specification.
2. **Preliminary Samples** – A preliminary sample of the material will be required only if coded on the Request for Approval of Material DOT Form 350-071.
3. **Acceptance**
  - a. **Treated** – Acceptance shall be by the Manufacturer’s Certificate of Compliance with supporting Mill Certification per Section 9-1.4D.  
  
The Project Office is required to inspect treated culvert pipe for uniformity of coating, no hanging treatment drips inside the pipe or other problems with the coating. Upon request the State Materials Laboratory Fabrication Inspection office can come inspect the treated metal culvert pipe at the jobsite if there

are concerns about the thickness of the treatment, and uniformity of the coating. WSDOT Fabrication inspectors are able to measure the thickness using non-destructive testing.

- b. **Untreated** – Acceptance shall be by Visual Acceptance per [Section 9-1.4C](#). Verify that the appropriate AASHTO specification for the steel sheet, gauge thickness, and heat number is stamped on the pipe. Pipe not bearing this stamp shall not be installed. Any pipe, which is damaged in any way from shipping or handling, should not be accepted. If the manufacturer of the pipe delivered to the job site cannot be identified, a Bill of Lading showing the manufacturer should be requested prior to accepting or installing the pipe.
4. **Field Inspection** – Field verify per [Section 9-1.5](#).
5. **Specification Requirements** – See *Standard Specifications* Section 9-05. Review contract documents to determine if supplemental specifications apply.
6. **Other Requirements** – Materials may be subject to Buy America and/or Build America/Buy America (BABA) requirements when included in the Contract by Special Provision. Refer to [Section 9-1.2E](#).

#### 9-4.18 ***Polyvinyl Chloride (PVC) and Corrugated Polyethylene (PE) Drain, Perforated Underdrain, Culvert, and Storm Sewer Pipe***

1. **Approval of Material** – Approval of materials is required prior to use. Materials will be approved by the Qualified Products List or Request for Approval of Material DOT Form 350-071. Be certain to verify that the product is in fact qualified for its intended use and the product is listed under the appropriate specification.
2. **Preliminary Samples** – A preliminary sample of the material will be required only if coded on the Request for Approval of Material DOT Form 350-071.
3. **Acceptance**
  - a. **Drain Pipe, Perforated Underdrain Pipe, Solid Wall PVC Culvert and Storm Sewer Pipe** – Visual Acceptance per [Section 9-1.4C](#).
  - b. **Profile Wall PVC Culvert and Storm Sewer Pipe, Corrugated PE Culvert and Storm Sewer Pipe** – Acceptance shall be by the Manufacturer's Certificate of Compliance per [Section 9-1.4D](#), shall accompany materials delivered to the project and shall include production lots for all materials represented.
4. **Field Inspection** – Field verify per [Section 9-1.5](#).
5. **Specification Requirements** – See *Standard Specifications* Section 9-05. Review contract documents to determine if supplemental specifications apply.
6. **Other Requirements** – Materials may be subject to Buy America and/or Build America/Buy America (BABA) requirements when included in the Contract by Special Provision. Refer to [Section 9-1.2E](#).

#### 9-4.19 ***Structural Plate Pipes, Arches, and Boxes***

1. **Approval of Material** – In accordance with *Standard Specifications* Section 1-06, approval of materials is required prior to use. Materials will be approved by the Qualified Products List or Request for Approval of Material DOT Form 350-071. Approval of fabrication facility as well as the base metal must be obtained. An on-site

inspection by the WSDOT Materials Fabrication Inspection Office of the fabricating facilities prior to approval will be required only if a new manufacture is requested on the Request for Approval of Material DOT Form 350-071. Be certain to verify that the product is in fact qualified for its intended use and the product is listed under the appropriate specification.

2. **Preliminary Samples** – A preliminary sample of the material will be required only if coded on the Request for Approval of Material DOT Form 350-071.
3. **Acceptance** – Acceptance shall be on the basis of Manufacturer’s Certificate of Compliance, with accompanying mill test reports per [Section 9-1.4D](#). The mass of zinc coating for each heat number in the shipment must be present on the “Manufacturer’s Certificate of Compliance.” The mill test report will contain both chemical and physical analysis of the base metal.

All suppliers of structural plate pipes, arches and boxes are to transmit four copies of the certification to the Project Engineer. At least one copy must accompany the shipment; the others may be forwarded through the Contractor. Two copies of the certification are to be retained in the Project Engineer’s files.

4. **Field Inspection** – Field verify per [Section 9-1.5](#).
5. **Specification Requirements** – See *Standard Specifications* Section 9-05.6. Review contract documents to determine if supplemental specifications apply.
6. **Other Requirements** – Materials may be subject to Buy America and/or Build America/Buy America (BABA) requirements when included in the Contract by Special Provision. Refer to [Section 9-1.2E](#)

#### **9-4.20 Steel, Gray-Iron, and Ductile-Iron Castings: Manhole Rings and Covers; Metal Frame, Grate, and Solid Metal Cover for Catch Basins or Inlets; Cast Metal Inlets; Frame (Ring), Grate, and Cover for Drywells**

1. **Approval of Material** – In accordance with *Standard Specifications* Section 1-06, approval of the Fabricator is required prior to fabrication. The Fabricator will be approved by the Qualified Products List or Request for Approval of Material DOT Form 350-071. Be certain to verify that the product is in fact qualified for its intended use, and the product is listed under the appropriate specification. Materials used within the fabricated item do not require approval through the Project Engineer office. Provide the Fabrication Inspection Office with a copy of the Qualified Products Page or Request for Approval of Material listing the fabricator.
2. **Preliminary Samples** – A preliminary sample of the material will be required only if coded on the Request for Approval of Material DOT Form 350-071.
3. **Acceptance** – Acceptance is based on “WSDOT-A” ([Figure 9-7](#)) Stamp impressed stamped into all castings. In [Figure 9-7](#), the “A” is an inspector identifier, and will be different for each individual inspector. An “F” or “D” will be stamped to indicate the steel or iron is of foreign or domestic origin. Only properly stamped castings may be accepted.
  - a. For Rectangular Frames and Grates, the frame and grate will each be stamped in such a fashion as to align adjacent mating surfaces to each other. This alignment is critical as the leveling pads are ground to prevent rocking of the grates in the frames.

4. **Field Inspection** – Field verify per [Section 9-1.5](#).
5. **Specification Requirements** – See *Standard Specifications* Section 9-05.15. Review contract documents to determine if supplemental specifications apply.
6. **Other Requirements** – Certification of Material Origin will be the responsibility of the Materials Fabrication Inspector as defined in Section 9-2.1A.

Materials may be subject to Buy America and/or Build America/Buy America (BABA) requirements when included in the Contract by Special Provision. Refer to [Section 9-1.2E](#).

#### 9-4.21 Sanitary Sewers

1. **Approval of Material** – Approval of materials and or the Fabricator is required prior to use or fabrication depending on the method of acceptance detailed below. The materials or Fabricator will be approved by the Qualified Products List or Request for Approval of Material DOT Form 350-071. If approval is by the QPL, be certain to verify that the product is in fact qualified for its intended use, and the product is listed under the appropriate specification. Materials used within the fabricated item do not require approval through the Project Engineer office. Provide the WSDOT Materials Fabrication Inspection Office with a copy of the Qualified Products Page or Request for Approval of Material listing the fabricator.
2. **Preliminary Samples** – A preliminary sample of the material will be required only if coded on the Request for Approval of Material DOT Form 350-071.
3. **Acceptance** – Material may be accepted upon receipt of an “Approved” document in lieu of sampling as shown below:
  - a. **Concrete Pipe Less Than 30 inch in Diameter** – Acceptance shall be based on “Concrete Pipe Acceptance Reports” which shall accompany the pipe to the job site. Inspect the manufacture date marked on each pipe to verify that it was made within the period covered by the Concrete Pipe Acceptance Report.
  - b. **Concrete Pipe 30 inch in Diameter and Larger** – Acceptance is based on “APPROVED FOR SHIPMENT” Stamp ([Figure 9-4](#)). An “F” or “D” will be stamped to indicate the steel or iron is of foreign or domestic origin. Pipes are individually inspected and stamped for approval by the Materials Fabrication Inspector at the fabrication facility prior to shipment.
  - c. **Vitrified Clay Sewer Pipe and Ductile Iron Sewer Pipe** – Acceptance shall be by the Manufacturer’s Certificate of Compliance per [Section 9-1.4D](#).
  - d. **PVC Sewer Pipe and ABS Composite Sewer Pipe** – Visual Acceptance per [Section 9-1.4C](#).
4. **Field Inspection** - Field verify per [Section 9-1.5](#).
5. **Specification Requirements** – See *Standard Specifications* Section 7-17. Review contract documents to determine if supplemental specifications apply.



## 6. Other Requirements

- a. **Materials Fabrication Inspected CMO** – Certification of Material Origin will be the responsibility of the Materials Fabrication Inspector as defined in Section 9-2.1A.

Materials may be subject to Buy America and/or Build America/Buy America (BABA) requirements when included in the Contract by Special Provision. Refer to Section 9-1.2E.

- b. **Non-Fabrication Inspected CMO** – Materials may be subject to Buy America and/or Build America/Buy America (BABA) requirements when included in the Contract by Special Provision. Refer to Section 9-1.2E.

### 9-4.22 Structural Steel for Bridges

1. **Approval of Material** – Approval of the Fabricator is required prior to the start of fabrication. The Fabricator will be approved by the Qualified Products List or Request for Approval of Material DOT Form 350-071. Be certain to verify that the product is in fact qualified for its intended use, and the product is listed under the appropriate specification. Approval of material sources through the QPL or RAM process for materials used by the Fabricator is not required. Provide the WSDOT Materials Fabrication Inspection Office with a copy of the Qualified Products Page or Request for Approval of Material listing the fabricator.
2. **Preliminary Samples** – A preliminary sample of the material will be required only if coded on the Request for Approval of Material DOT Form 350-071.
3. **Acceptance** – Acceptance is based on “APPROVED FOR SHIPMENT” Stamp and/or Tag ([Figure 9-4](#) or [9-5](#)). An “F” or “D” will be stamped to indicate the steel or iron is of foreign or domestic origin.

The Materials Fabrication Inspector will provide a weekly Fabrication Progress Report to the Project Engineer while the structural steel is being fabricated.

4. **Field Inspection** – Field verify per [Section 9-1.5](#).
5. **Specification Requirements** – See *Standard Specifications* Section 6-03 and 9-06. Review contract documents to determine if supplemental specifications apply.
6. **Other Requirements**

- a. **Materials Fabrication Inspected CMO** – Certification of Materials Origin will be the responsibility of the Materials Fabrication Inspector as defined in Section 9-2.1A.

Materials may be subject to Buy America and/or Build America/Buy America (BABA) requirements when included in the Contract by Special Provision. Refer to [Section 9-1.2E](#).

- b. **Non-Fabrication Inspected CMO** – Materials may be subject to Buy America and/or Build America/Buy America (BABA) requirements when included in the Contract by Special Provision. Refer to [Section 9-1.2E](#).

### 9-4.23 **Unfinished Bolts (Ordinary Machine Bolts), Nuts, and Washers**

1. **Approval of Material** – In accordance with *Standard Specifications* Section 1-06, approval of materials is required prior to use. Materials will be approved by the Qualified Products List or Request for Approval of Material DOT Form 350-071. Be certain to verify that the product is in fact qualified for its intended use and the product is listed under the appropriate specification.
2. **Preliminary Samples** – A preliminary sample of the material will be required only if coded on the Request for Approval of Material DOT Form 350-071.
3. **Acceptance** – Acceptance of unfinished bolts, nuts, and washers shall be by the Manufacturer's Certificate of Compliance per [Section 9-1.4D](#).
4. **Field Inspection** – Field verify per [Section 9-1.5](#).
5. **Specification Requirements** – See *Standard Specifications* Section 9-06.5(1). Review contract documents to determine if supplemental specifications apply.
6. **Other Requirements** – Materials may be subject to Buy America and/or Build America/Buy America (BABA) requirements when included in the Contract by Special Provision. Refer to [Section 9-1.2E](#).

### 9-4.24 **High Strength Bolts, Nuts, and Washers**

1. **Approval of Material** – Approval of materials is required prior to use. Materials will be approved by the Qualified Products List or Request for Approval of Material DOT Form 350-071. If approval is by QPL, be certain to verify that the product is in fact qualified for its intended use, and the product is listed under the appropriate specification.
2. **Preliminary Samples** – A preliminary sample of the material will be required only if coded on the Request for Approval of Material DOT Form 350-071.
3. **Acceptance**
  - a. **Materials Fabrication Inspected Item** – Acceptance for high strength bolts, nuts, and washers associated with items receiving Materials Fabrication Inspection shall be an "APPROVED FOR SHIPMENT" Stamp and/or Tag ([Figure 9-4](#) or [9-5](#)) stamped on the container of bolts, nuts and washers. The Materials Fabrication Inspector will inspect hardware if it is available at the time of inspection at the point of manufacture. High strength bolts, nuts and washers not present during Materials Fabrication Inspection and delivered to the job site without an approval stamp shall be accepted by "Non-Fabrication Inspected Items" (see below). An "F" or "D" will be stamped to indicate the steel or iron is of foreign or domestic origin.
  - b. **Non-Fabrication Inspected Items:**
    - i. **Fabrication Inspection Sampled** – Acceptance shall be by the Manufacturer's Certificate of Compliance for each heat number or manufacturing lot per [Section 9-1.4D](#). When the materials are received on the job site stamped "WSDOT Sampled," the material shall also be accepted by the PEO on receipt of "Satisfactory" test reports from the State Materials Laboratory.



- b. **Non-Fabrication Inspected Items** – Acceptance for ASTM F 1554 Grade 36 or Grade 55 anchor bolts, rods, nuts and washers shall be based on receipt of Manufacturer’s Certificate of Compliance.

Nuts and washers for ASTM F 1554 Grade 105 anchor bolts and rods not containing an “APPROVED FOR SHIPMENT” Tag and/or Stamp shall be accepted by a Manufacturer’s Certificates of Compliance per [Section 9-1.4D](#) and it will be the responsibility of the Contractor to supply the certifications to the Project Engineer’s Office prior to use.

- 4. **Field Inspection** – Field verify per [Section 9-1.5](#).
- 5. **Specification Requirements** – See *Standard Specifications* Section 9-06.5(4), 9-28.14(2), and 9-29.6(5). Review contract documents to determine if supplemental specifications apply.

6. **Other Requirements**

- a. **Materials Fabrication Inspected CMO** – Certification of Materials Origin will be the responsibility of the Materials Fabrication Inspector as defined in Section 9-2.1A.

Materials may be subject to Buy America and/or Build America/Buy America (BABA) requirements when included in the Contract by Special Provision. Refer to [Section 9-1.2E](#).

- b. **Non-Fabrication Inspected CMO** – Materials may be subject to Buy America and/or Build America/Buy America (BABA) requirements when included in the Contract by Special Provision. Refer to [Section 9-1.2E](#).

#### 9-4.26 **Reinforcing Bars for Concrete (Uncoated and Epoxy Coated Rebar)**

- 1. **Approval of Material** – In accordance with *Standard Specification* Section 1-06, approval of materials, and the coating facility is required prior to use.

Materials, and the coating facility will be approved by the Qualified Products List or Request for Approval of Material DOT Form 350-071. An on-site inspection by WSDOT State Materials Laboratory’s Fabrication Office of the coating facility prior to approval will be required only if a new coating facility is requested on the Request for Approval of Materials DOT Form 350-071. Be certain to verify that the product is in fact qualified for its intended use and the product is listed under the appropriate specification. Materials used within the fabricated item do not require approval through the Project Engineer office. Provide the WSDOT State Materials Laboratory Fabrication Office with a copy of the Qualified Products Page or Request for Approval of Material list the coating facility. Review of the Contract Special Provisions is necessary to determine if special qualifications or testing is required for approval of the bender cutter and the coating facility.

RAM Submittal:

- a. **Reinforcing Steel Rebar (Deformed and Plain Steel Bar)** – Submit documentation or a web link that demonstrates the Steel Reinforcing Bar Manufacturer is listed and compliant with the NTPEP audit program for Reinforcing Steel (rebar) Manufacturer as required in *Standard Specification* Section 9-07.1(1)A.
- b. **Coating Facility** – Submit the following information; Name of Facility, Contact Person, phone number, email address, and facility address.

2. **Preliminary Samples** – A preliminary sample of the material will be required only if coded on the Request for Approval of Material DOT Form 350-071.
3. **Acceptance**
  - a. **Reinforcing Steel Rebar (Uncoated)**
    - i. **Acceptance** – Shall be by the Manufacturer’s Certification of Compliance and Certified Mill Test Reports that will accompany each shipment per Section 9-1.4D.
    - ii. **Verification** – A representative of the State Materials Laboratory Fabrication Office may take random samples at the point of manufacture or fabrication for testing. The Project Engineer office will be notified in the event of a failing test report. The PEO will be required to check reinforcing bars for failing heat numbers to ensure that the failing reinforcing bars from that heat number was not installed.

**Note:** If Mill Test reports are not available, do not permanently incorporate steel into the project i.e. reinforcing steel being cast in concrete.
  - b. **Epoxy-Coated Steel Reinforcing Bar** – Acceptance shall be by an “APPROVED FOR SHIPMENT” Tag ([Figure 9-5](#)) attached to a representative number of bundles of epoxy coated reinforcing steel bars. An “F” or “D” will be stamped to indicate the steel or iron is of foreign or domestic steel.
4. **Field Inspection** – Field verify per [Section 9-1.5](#).
5. **Specification Requirements** – See *Standard Specifications* Section 9-07. Review contract documents to determine if supplemental specifications apply.
6. **Other Requirements** –
  - a. **Materials Fabrication Inspected CMO** – Certification of Materials Origin will be the responsibility of the Materials Fabrication Inspector as defined in Section 9-2.1A.

Materials may be subject to Buy America and/or Build America/Buy America (BABA) requirements when included in the Contract by Special Provision. Refer to [Section 9-1.2E](#).
  - b. **Non-Fabricated Inspected CMO** – Materials may be subject to Buy America and/or Build America/Buy America (BABA) requirements when included in the Contract by Special Provision. Refer to [Section 9-1.2E](#).

#### 9-4.27 **Vacant**

#### 9-4.28 **Mechanical Splices**

1. **Approval of Material** – In accordance with *Standard Specifications* Section 1-06, approval of materials is required prior to use. Materials will be approved by the Qualified Products List or Request for Approval of Material DOT Form 350-071. Be certain to verify that the product is in fact qualified for its intended use and the product is listed under the appropriate specification.
2. **Preliminary Sample** – A preliminary sample of the material will be required only if coded on the Request for Approval of Material DOT Form 350-071. Required preliminary samples shall include a made up splice for each size bar to be used and the

manufacturer's product information. The overall length of the sample shall be 6 feet plus the length of the splice.

3. **Acceptance** – Materials shall be accepted on receipt of “Satisfactory” test reports from the State Materials Laboratory. The sample shall be from Contractor's assembled samples (see Note) taken from the project. A Manufacturer's Certificate of Compliance and other technical data MUST be submitted with the samples. The overall length of the sample shall be 6 feet plus the length of the splice, and shall consist of one made up splice for each size bar to be used.

**Note:** This is a test of the Contractor's ability to properly assemble the splice as much as it is a test of the quality of the materials. For this reason the spliced bars must be assembled by the contractor's personnel, witnessed by the inspector and transmitted intact to the State Material Lab for testing.

4. **Field Inspection** – Field verify per [Section 9-1.5](#).
5. **Specification Requirements** – See *Standard Specifications* Section 6-02.3(24)F and G. Review contract documents to determine if supplemental specifications apply.
6. **Other Requirements** – Materials may be subject to Buy America and/or Build America/Buy America (BABA) requirements when included in the Contract by Special Provision. Refer to [Section 9-1.2E](#).

#### 9-4.29 **Rebar Chairs, Mortar Blocks (Dobies), and Spacers**

1. **Approval of Material** – Approval of materials is required prior to use. Materials will be approved by the Qualified Products List or Request for Approval of Material DOT Form 350-071. Be certain to verify that the product is in fact qualified for its intended use and the product is listed under the appropriate specification.

RAM Submittal

- a. **Mortar Blocks (Dobies)** – If approval action is being requested via the RAM process, attach the Manufacturer's Certificate of Compliance per [Section 9-1.4D](#) to assist in the approval process.
- b. **Rebar Chairs and Spacers** – Submit sample of each size and type with the Request for Approval of Material.
2. **Preliminary Sample** – A preliminary sample of the material will be required only if coded on the Request for Approval of Material DOT Form 350-071.
3. **Acceptance**
  - a. **Mortar Blocks (Dobies)** – Acceptance shall be by the Manufacturer's Certificate of Compliance per [Section 9-1.4D](#).
  - b. **Rebar Chairs and Spacers** – Visual Acceptance per [Section 9-1.4C](#).
4. **Field Inspection** – Field verify per [Section 9-1.5](#).
5. **Specification Requirements** – See *Standard Specifications* Section 6-02.3(24)C. Review contract documents to determine if supplemental specifications apply.
6. **Other Requirements** – Materials may be subject to Buy America and/or Build America/Buy America (BABA) requirements when included in the Contract by Special Provision. Refer to [Section 9-1.2E](#).

### 9-4.30 Dowels and Tie Bars for Concrete Pavement

1. **Approval of Material** – In accordance with *Standard Specification 1-06*, approval of materials and coating facility are required prior to use. The materials and coating facility will be approved by the Qualified Products List or Request for Approval of Material DOT Form 350-071. Be certain to verify that the product is in fact qualified for its intended use and the product is listed under the appropriate specification.

#### RAM Submittal

- a. **Epoxy-Coated Dowel Bars (for Cement Concrete Pavement Rehabilitation)** – Submit the following;
  - i. Identification of the epoxy coater and,
  - ii. Identification of the dowel bar fabricator and,
  - iii. Manufacturer's Certification of Compliance and supporting certified mill tests for chemical composition and mechanical properties of current or previous productions for the steel dowel bar and epoxy coating material. Mill tests shall be less than 2 years old.
- b. **Corrosion Resistant Dowel Bars (for Cement Concrete Pavement)**
  - i. **Stainless Steel Clad Dowel Bars and Zinc Clad Dowel Bars** – Submit the following;
    1. Identification of the dowel bar fabricator and,
    2. Manufacturer's Certification of Compliance and supporting certified mill tests for chemical composition and mechanical properties of current or previous production for the steel dowel bar and the clad. Mill tests shall be less than 2 years old.
  - ii. **Stainless Steel Tube Dowel Bars** – Submit the following;
    1. Identification of the dowel bar fabricator and,
    2. Manufacturer's Certification of Compliance and supporting certified mill tests for chemical composition and mechanical properties of current or previous production for the steel dowel bar and stainless steel tube. Mill tests shall be less than 2 years old.
  - iii. **Stainless Steel Solid Dowel Bars and Corrosion-Resistant Low Carbon Chromium Plain Steel Bars** – Submit the following;
    1. Identification of the stainless steel dowel bar fabricator and,
    2. Manufacturer's Certification of Compliance and supporting certified mill tests for chemical composition and mechanical properties of current or previous production for the steel dowel bar. Mill test shall be less than 2 years old.
  - iv. **Corrosion-Resistant Steel Tubes**
    1. Identification of the stainless steel dowel bar fabricator and,
    2. Manufacturer's Certification of Compliance and supporting certified mill tests for chemical composition and mechanical properties of current or previous production for the steel tube. Mill test shall be less than two years old.

- c. Tie Bars (for Cement Concrete Pavement)
  - i. **Epoxy Coated (AASHTO A 775) Tie Bars** – Submit the following;
    1. Identification of the epoxy coater and,
    2. Identification of the tie bar fabricator and,
    3. Manufacturer's Certification of Compliance and supporting certified mill tests for chemical composition and mechanical properties of current or previous production for the steel tie bar and the epoxy coating material. Mill tests shall be less than 2 years old.
  - ii. **Corrosion-Resistant Tie Bars** – Submit the following;
    1. Identification of the tie bar fabricator and;
    2. Manufacturer's Certification of Compliance and supporting certified mill tests for chemical composition and mechanical properties of current or previous production for the tie bar. Mill tests shall be less than 2 years old.
2. **Preliminary Sample** – A preliminary sample of the material will be required only if coded on the Request for Approval of Material (DOT Form 350-071).
3. **Acceptance** – Acceptance shall be by the Manufacturer's Certificate of Compliance and Certified Mill Test Report for both steel and coating process that will accompany each shipment per [Section 9-1.4D](#).
4. **Field Inspection** – Field verify per [Section 9-1.5](#).
5. **Specification Requirements** – See *Standard Specifications* Sections 9-07.5 and 9-07.6. Review contract documents to determine if supplemental specifications apply.
6. **Other Requirements** – Materials may be subject to Buy America and/or Build America/Buy America (BABA) requirements when included in the Contract by Special Provision. Refer to [Section 9-1.2E](#).

#### 9-4.31 **Welded Wire Reinforcement for Concrete**

1. **Approval of Material** – In accordance with *Standard Specifications* Section 1-06, approval of materials is required prior to use. Materials will be approved by the Qualified Products List or Request for Approval of Material DOT Form 350-071. Be certain to verify that the product is in fact qualified for its intended use and the product is listed under the appropriate specification.
2. **Preliminary Samples** – A preliminary sample of the material will be required only if coded on the Request for Approval of Material DOT Form 350-071.
3. **Acceptance** – Acceptance shall be by the Manufacturer's Certificate of Compliance and Certified Mill Test Reports that will accompany each shipment per [Section 9-1.4D](#).
4. **Field Inspection** – Field verify per [Section 9-1.5](#).
5. **Specification Requirements** – See *Standard Specifications* Section 9-07.7, 9-07.8, and 9-07.9. Review contract documents to determine if supplemental specifications apply.
6. **Other Requirements** – Materials may be subject to Buy America and/or Build America/Buy America (BABA) requirements when included in the Contract by Special Provision. Refer to [Section 9-1.2E](#).



### 9-4.32 Bridge Approach Slab Anchors

1. **Approval of Material** – Approval of materials is required prior to use. Materials will be approved by the Qualified Products List or Request for Approval of Material DOT Form 350-071. Be certain to verify that the product is in fact qualified for its intended use and the product is listed under the appropriate specification.
2. **Preliminary Sample** – A preliminary sample of the material will be required only if coded on the Request for Approval of Material DOT Form 350-071.
3. **Acceptance**
  - a. **Anchors Type A** – Acceptance for the Steel Rod and Plate shall be by the Manufacturer’s Certificate of Compliance per [Section 9-1.4D](#).
  - b. **Anchors Type B** – Acceptance for the Threaded Steel Rod and Steel Plate shall be by the Manufacturer’s Certificate of Compliance per [Section 9-1.4D](#).
  - c. **Other Anchor Rod materials** – Plastic pipe, polystyrene, and duct tape are identified as Low Risk Materials per Section 9-1.3C.
4. **Field Inspection** – Field verify per [Section 9-1.5](#).
5. **Specification Requirements** – See Standard Plans A-40.50.00 and *Standard Specifications* Section 6-02.3(10). Review contract documents to determine if supplemental specifications apply.
6. **Other Requirements** – Materials may be subject to Buy America and/or Build America/Buy America (BABA) requirements when included in the Contract by Special Provision. Refer to [Section 9-1.2E](#).

### 9-4.33 Prestressing/Post Tensioning Reinforcement – Strand

1. **Approval of Material** – In accordance with *Standard Specifications* Section 1-06 approval of materials is required prior to use. Materials will be approved by the Qualified Products List or Request for Approval of Material DOT Form 350-071. Be certain to verify that the product is in fact qualified for its intended use and the product is listed under the appropriate specification.
2. **Preliminary Samples** – A preliminary sample of the material will be required only if coded on the Request for Approval of Material DOT Form 350-071.
3. **Acceptance/Verification**
  - a. **Acceptance** – Acceptance shall be by the Manufacturer’s Certificate of Compliance, Certified Mill Test Reports and the stress/strain curve that will accompany each reel.
  - b. **Verification** – The strand shall be tested for verification prior to placement. Samples for verification of conformance will be taken randomly at a frequency of 1 sample for every 5 reels. Sample per AASHTO M203. The samples shall be 6 to 7 feet in length. All samples must include the Manufacturer’s Certificate of Compliance, a mill certificate with supporting test report, and the stress/strain curve.

Submit 1 sample for each 5 reels to the State Materials Laboratory for testing. A copy of the Manufacturer's Certificate of Compliance, a mill certificate with supporting test report, and the stress/strain curve MUST accompany each sample submitted for testing. If the submitted sample fails the testing, submit two additional samples from the same heat number for additional testing.

4. **Field Inspection** – Field verify per [Section 9-1.5](#).
5. **Specification Requirements** – See *Standard Specifications* Section 9-07.10. Review contract documents to determine if supplemental specifications apply.
6. **Other Requirements** – Materials may be subject to Buy America and/or Build America/Buy America (BABA) requirements when included in the Contract by Special Provision. Refer to [Section 9-1.2E](#).

#### 9-4.34 ***Prestressing/Post Tensioning Reinforcement – Bar***

1. **Approval of Material** – In accordance with *Standard Specifications* Section 1-06, approval of materials is required prior to use. Materials will be approved by the Qualified Products List or Request for Approval of Material DOT Form 350-071. Be certain to verify that the product is in fact qualified for its intended use and the product is listed under the appropriate specification.
2. **Preliminary Samples** – A preliminary sample of the material will be required only if coded on the Request for Approval of Material DOT Form 350-071.
3. **Acceptance** – Materials shall be accepted on receipt of “Satisfactory” test reports from the State Materials Laboratory. Send two samples from each heat number. If supplemental requirements apply, send additional samples of two bars from each heat number. See Contract documents. Sample per AASHTO T244. The samples must be a minimum of 6 feet in length, plus the length of the splice. A copy of the Manufacturer's Certificate of Compliance and Certified Mill Test Reports shall accompany each heat number of reinforcing bar.
4. **Field Inspection** – Field verify per [Section 9-1.5](#).
5. **Specification Requirements** – Review contract documents to determine specification requirements.
6. **Other Requirements** – Materials may be subject to Buy America and/or Build America/Buy America (BABA) requirements when included in the Contract by Special Provision. Refer to [Section 9-1.2E](#).

#### 9-4.35 ***Painting, Paints, Coating, and Related Materials***

1. **Approval of Material** – In accordance with *Standard Specifications* Section 1-06, approval of the materials and painting/coating facility is required prior to the application of the paint/coating. The materials and painting/coating facility will be approved by the Qualified Products List or Request for Approval of Material DOT Form 350-071. Be certain to verify that the product is in fact qualified for its intended use and the product is listed under the appropriate specification. Materials/coating facility(s) used to produce the fabricated item do not require approval through the Project Engineer office. Provide the WSDOT Materials Fabrication Inspection Office with a copy of the Qualified Products Page or Request for Approval of Materials listing for the painting/coating facility.

- Materials for Painting/Coating preparation (i.e., Abrasive blast media, bird guano treatment, fungicide treatment, filter fabric, foam backer rod) do not require approval documentation. It is within the inspector's authority to ask for additional documentation if the products are not performing satisfactorily.

**RAM Submittal** – Vinyl Pretreatment, Inorganic Zinc-Rich Primer, Epoxy Polyamide, Rust-Penetrating Sealer, Black Enamel, Orange Equipment Enamel, Exterior Acrylic Latex Paint-White, Single-Component Polyurethane Sealant, NEPCOAT Qualified Products (List A & B), and Galvanizing Repair Paint (High Zinc Dust Content): Attach Catalog Cut showing conformance with the Contract Documents to assist in approving the RAM.

2. **Preliminary Samples** – Preliminary Samples will be required only if coded on the Request for Approval of Material DOT Form 350-071.
3. **Acceptance**
  - a. **Shop/Fabrications Coated Materials for Items Delivered to the Jobsite** – Acceptance is based on “APPROVED FOR SHIPMENT” Stamp and/or Tag (Figure 9-4 or 9-5). See Section 9-4 for individual materials acceptance.
  - b. **Jobsite Coated Materials**
    - i. **Primer Zinc Filled Single Component Moisture** – Cured Polyurethane, Intermediate and Stripe Coat Single Component Moisture-Cured Polyurethane, Top Coat Single-Component Moisture-Cured Polyurethane:
      - **20 gallons or Less** – Acceptance shall be by the Manufacturer's Certificate of Compliance per Section 9-1.4D. The Manufacturer's Certificate of Compliance shall include a list of materials and quantities used.
      - **Greater than 20 Gallons** – If the lot is listed on the QPL, it may be used without testing on current projects per Section 9-1.4A(1). If the lot is not on the QPL, a one-quart sample for each lot is required. The WSDOT Fabrication Inspection Office will pick up the sample from the Manufacturer/Distributor. Samples must be submitted for testing 10 days prior to use. Materials shall be accepted on receipt of “Satisfactory” test reports from the State Materials Laboratory.
    - ii. **Vinyl Pretreatment, Inorganic Zinc** – Rich Primer, Epoxy Polyamide, Rust-Penetrating Sealer, Black Enamel, Orange Equipment Enamel, and Exterior Acrylic Latex Paint-White: Visual Acceptance per Section 9-1.4C.
    - iii. **Pigmented Sealer Materials for Coating of Concrete Surfaces** – If the lot is listed on the QPL, it may be used without testing on current projects per Section 9-1.4A(1). If the lot is not on the QPL, submit a one-quart sample taken by, or in the presence of, an agency representative for each lot. Samples must be submitted for testing 10 days prior to use. Materials shall be accepted on receipt of “Satisfactory” test reports from the State Materials Laboratory.
    - iv. **Single-Component Polyurethane Sealant** – Visual Acceptance per Section 9-1.4C.
    - v. **Repair material for Powder Coated Items** – Visual Acceptance per Section 9-1.4C that the repair material is per Contract Documents and is as specified in the Contractor's powder coating plan as specified by the engineer.

- vi. **Galvanizing Repair Paint (High Zinc Dust Content)** – Visual acceptance per [Section 9-1.4C](#) that the spray can label states that the material meets “Federal Specification MIL-P-21035.”
4. **Field Inspection** – Field verify per [Section 9-1.5](#).
5. **Specification Requirements** – See *Standard Specifications* Section 9-08. Review contract documents to determine if supplemental specifications apply.
6. **Other Requirements** – Materials may be subject to Buy America and/or Build America/Buy America (BABA) requirements when included in the Contract by Special Provision. Refer to [Section 9-1.2E](#).

#### 9-4.36 Timber and Lumber

1. **Approval of Material** – Approval of the Treatment Facility for treated lumber 6 in by 6 in and larger is required prior to the start of treatment. The Treatment Facility will be approved by the Qualified Products List or Request for Approval of Material DOT Form 350-071. Be certain to verify that the product is in fact qualified for its intended use and the product is listed under the appropriate specification. Materials used within the Treatment Facility do not require approval through the Project Engineer office. Review of the Contract Special Provisions is necessary to determine if special qualifications or testing is required for approval of the Treatment Facility.  
  
The Project Engineer is responsible for obtaining the approval for all untreated lumber and treated lumber less than 6 in by 6 in prior to use. Materials will be approved by the Qualified Products List or Request for Approval of Material DOT Form 350-071. Be certain to verify that the product is in fact qualified for its intended use and the product is listed under the appropriate specification.
2. **Preliminary Samples** – A preliminary sample of the material will be required only if coded on the Request for Approval of Material DOT Form 350-071.
3. **Acceptance**
  - a. **Untreated** – Acceptance shall be by a Lumber Grading Stamp or Grading Certificate for Timber and Lumber. The Grading Certificate will be issued by the grading bureau whose authorized stamp is being used, or by the mill grading the timber or lumber under the supervision of one of the following lumber grading agencies: West Coast Lumber Inspection Bureau (WCLIB), Western Wood Products Association (WWPA), or the Pacific Lumber Inspection Bureau (PLIB). Check that all lumber and timber has the proper lumber grade stamps.  
  
Typically Lumber Grade Stamps, as used by the various inspection agencies are shown in the QPL, Appendix B:
  - b. **Treated**
    - i. Acceptance for Treated Timber and Lumber 6 in × 6 in and greater shall be an “APPROVED FOR SHIPMENT” tag ([Figure 9-6](#)).
    - ii. Acceptance for Treated Timber and Lumber less than 6 in × 6 in shall be by a Lumber Grading Stamp or Grading Certificate and Certificate of Treatment.
4. **Field Inspection** – Field verify per [Section 9-1.5](#).

5. **Specification Requirements** – See *Standard Specifications* Section 9-09, 9-16.2, 9-28.14, and 9-32.4. Review contract documents to determine if supplemental specifications apply.
6. **Other Requirements** – Aquatic use requires additional documentation per *Standard Specifications* Section 9-09.3.

Materials may be subject to Buy America and/or Build America/Buy America (BABA) requirements when included in the Contract by Special Provision. Refer to [Section 9-1.2E](#).

#### 9-4.37 Vacant

#### 9-4.38 Piling – All Types

1. **Approval of Material** – In accordance with Section 1-06 approval of the Fabricator, coating facility and treatment facility is required prior to the start of fabrication. The Fabricator or treatment facility will be approved by the Qualified Products List or Request for Approval of Material DOT Form 350-071. Be certain to verify that the product is in fact qualified for its intended use and the product is listed under the appropriate specification. Materials used within the fabricated item do not require approval through the Project Engineer office. Provide the WSDOT Materials Fabrication Inspection Office with a copy of the Qualified Products Page or Request for Approval of Material listing the Fabricator. Review of the Contract Special Provisions is necessary to determine if special qualifications or testing is required for approval of the fabricator.

The Project Engineer is responsible for obtaining the approval of materials prior to use. Materials listed as “Project Engineer Office accepted” will be approved by the Qualified Products List or Request for Approval of Material DOT Form 350-071. Be certain to verify that the product is in fact qualified for its intended use and the product is listed under the appropriate specification.

2. **Preliminary Samples** – A preliminary sample of the material will be required only if coded on the Request for Approval of Material DOT Form 350-071.
3. **Acceptance**
  - a. **WSDOT Fabricated Inspected**
    - i. **Treated Wood Piling** – Acceptance shall be by an “APPROVED FOR SHIPMENT” Tag ([Figure 9-6](#)). Aquatic use requires additional documentation per *Standard Specifications* Section 9-09.3.
    - ii. **Timber Composite Piling** – Acceptance shall be an “APPROVED FOR SHIPMENT” Tag ([Figure 9-6](#)). Aquatic use requires additional documentation per *Standard Specifications* Section 9-09.3.
    - iii. **Coated Steel Piling** – Acceptance shall be by an “APPROVED FOR SHIPMENT” Stamp ([Figure 9-4](#)). An “F” or “D” will be stamped to indicate the steel or iron is of foreign or domestic origin.

- iv. **Prestressed Concrete Piling** – Acceptance shall be by an “APPROVED FOR SHIPMENT” Stamp (Figure 9-4). An “F” or “D” will be stamped to indicate the steel or iron is of foreign or domestic origin.
  - v. **Structural Steel Piling (open-ended and close-ended pipe piles), H-pile, and Soldier Pile** – Acceptance shall be by an “APPROVED FOR SHIPMENT” Stamp (Figure 9-4). An “F” or “D” will be stamped to indicate the steel or iron is of foreign or domestic origin.
  - vi. **Steel Pipe Piles for Concrete-Filled Steel Tubes (CFST)** – Acceptance shall be by an “APPROVED FOR SHIPMENT” Stamp (Figure 9-4). An “F” or “D” will be stamped to indicate the steel or iron is of foreign or domestic origin.
- b. **Project Engineer Office Accepted**
- i. **Untreated Wood Piling** – Visual Acceptance per Section 9-1.4C and by field inspection per *Standard Specifications* Section 9-10.1(1).
  - ii. **Steel Casing** – Acceptance shall be by the Manufacturer’s Certificate of Compliance and Certified Mill Test Reports that will accompany each shipment per Section 9-1.4D.
  - iii. **Steel Pile Tips, Shoes, and Pile Strapping** – Acceptance shall be by the Manufacturer’s Certificate of Compliance and Certified Mill Test Reports that will accompany each shipment per Section 9-1.4D.
  - iv. **Micropiles (Casing)** – Acceptance shall be by the Manufacturer’s Certificate of Compliance and Certified Mill Test reports that accompany each shipment per Section 9-1.4D.
  - v. **Cast-In-Place Concrete Piling** – Acceptance of the concrete shall be in accordance with Section 9-4.76 and the acceptance of the reinforcement shall be in accordance with Section 9-4.26.
4. **Field Inspection** – Field verify per Section 9-1.5.
5. **Specification Requirements** – See *Standard Specifications* Sections 9-10.1(1) and 9-19.1. Review contract documents to determine if supplemental specifications apply.
6. **Other Requirements**
- a. **Materials Fabrication Inspected CMO** – Certification of Materials Origin for domestic steel will be the responsibility of the WSDOT Materials Fabrication Inspector as defined in Section 9-2.1A.  
  
Materials may be subject to Buy America and/or Build America/Buy America (BABA) requirements when included in the Contract by Special Provision. Refer to Section 9-1.2E.
  - b. **Non-Fabrication Inspected CMO** – Materials may be subject to Buy America and/or Build America/Buy America (BABA) requirements when included in the Contract by Special Provision. Refer to Section 9-1.2E.

### 9-4.39 Vacant

#### 9-4.40 **Precast Concrete Manholes, Catch Basins, Inlets, and Drywells**

1. **Approval of Material** – In accordance with *Standard Specifications* Section 1-06, approval of the Fabricator is required prior to the start of fabrication. The Fabricator will be approved by the Qualified Products List or Request for Approval of Material DOT Form 350-071. Be certain to verify that the product is in fact qualified for its intended use and the product is listed under the appropriate specification. Materials used within the fabricated item do not require approval through the Project Engineer office. Provide the Fabrication Inspection Office with a copy of the Qualified Products Page or Request for Approval of Material listing the Fabricator. Review of the Contract Special Provisions is necessary to determine if special qualifications or testing is required for approval of the fabricator.
2. **Preliminary Samples** – A preliminary sample of the material will be required only if coded on the Request for Approval of Material DOT Form 350-071.
3. **Acceptance**
  - Acceptance is based on “WSDOT INSPECTED” Stamp ([Figure 9-3](#)). An “F” or “D” will be stamped to indicate the steel or iron is of foreign or domestic origin.
4. **Field Inspection** – Field verify per [Section 9-1.5](#).
5. **Specification Requirements** – See *Standard Specifications* Section 7-05 and 9-05.50(2), 9-05.50(3), 9-05.50(4), and 9-05.50(5). Review contract documents to determine if supplemental specifications apply.
6. **Other Requirements** – Certification of Material Origin will be the responsibility of the Materials Fabrication Inspector as defined in Section 9-2.1A.

Materials may be subject to Buy America and/or Build America/Buy America (BABA) requirements when included in the Contract by Special Provision. Refer to [Section 9-1.2E](#)

#### 9-4.41 **Adjustment Sections for Drainage Structures**

1. **Approval of Material**

**Precast Concrete and Metal Castings** - In accordance with *Standard Specifications* Section 1-06, approval of materials is required prior to use. Materials will be approved by the Qualified Products List or Request for Approval of Material DOT Form 350-071. An on-site inspection by the WSDOT Materials Fabrication Office of the fabricating facilities prior to approval will be required only if a new manufacturer is requested on the Request for Approval of Material DOT Form 350-071. Be certain to verify that the product is in fact qualified for its intended use and the product is listed under the appropriate specification.

**Concrete Block, Concrete Brick and Expanded Polypropylene Foam** - In accordance with *Standard Specifications* Section 1-06, approval of materials is required prior to use. Materials will be approved by the Qualified Products List or Request for Approval of Material DOT Form 350-071. Be certain to verify that the product is in fact qualified for its intended use and the product is listed under the appropriate specification.

2. **Preliminary Samples** – A preliminary sample of the material will be required only if coded on the Request for Approval of Material DOT Form 350-071.

### 3. Acceptance

#### a. Precast Concrete

**Sections 12 inches and Greater** - Acceptance shall be a "WSDOT INSPECTED" Stamp (Figure 9-3). An "F" or "D" will be stamped to indicate the steel or iron is of foreign or domestic origin.

**Sections less than 12 inches** - Visual Acceptance in accordance with Section 9-1.4C.

#### b. Metal Casting

**Sections 4 inches and Greater** - Acceptance shall be a "WSDOT INSPECTED" Stamp (Figure 9-3). An "F" or "D" will be stamped to indicate the steel or iron is of foreign or domestic origin.

**Sections less than 4 inches** - Acceptance shall be by a Manufacturer's Certificate of Compliance in accordance with Section 9-1.4D.

#### c. Concrete Block and Concrete Brick

- Acceptance shall be by the Certificate of Compliance per Section 9-1.4E.

#### d. Expanded Polypropylene Foam

- Visual Acceptance in accordance with Section 9-1.4C.

### 4. Field Inspection – Field verify per [Section 9-1.5](#).

### 5. Specification Requirements – See Standard Specifications Section 9-05.51. Review Contract documents to determine if supplemental specifications apply.

### 6. Other Requirements – Certification of Material Origin will be the responsibility of the Materials Fabrication Inspector as defined in Section 9-2.1A.

Materials may be subject to Buy America and/or Build America/Buy America (BABA) requirements when included in the Contract by Special Provision. Refer to [Section 9-1.2E](#).

#### **9-4.42 Riprap, Rock for Erosion and Scour Protection, Quarry Spalls, Rock for Rock Wall and Chinking Material, Backfill for Rock Wall, and Stone for Gabions**

#### 1. Approval of Material – In accordance with *Standard Specifications* Section 1-06, approval of materials is required prior to use. Consult the Aggregate Source Approval (ASA) database for approval status of the material for each source. If the ASA database indicated that the aggregate source has expired, or will expire before the end of the project, a source evaluation may be required. Contact the Region Materials Office for further direction. If samples are required, the Region Materials Office will coordinate with the Materials Quality Assurance Section QPL/ASA engineer to obtain the necessary samples according to SOP 128.

When the usage is for non-structural applications, the Region Materials Engineer may approve the source.

#### 2. Preliminary Samples – A preliminary sample of the material will be required only if coded on the Request for Approval of Material DOT Form 350-071.

#### a. Stone for Gabions – Prior to incorporating the material into the project a preliminary sample of material will be required; Stone for filling gabions shall be dense enough to pass the unit weight test described in *Standard Specifications* Section 8-24.3(3)F.



3. **Acceptance**
  - a. Acceptance for quantities less than or equal to 150 cubic yards shall be by a Visual Acceptance per [Section 9-1.4C](#).
  - b. Acceptance for quantities that exceed 150 cubic yards, the Project Engineer shall determine and document that the grading is in conformance with the *Standard Specifications* and contract special provisions.
  - c. Acceptance for non-structural applications shall be by a Visual Acceptance per [Section 9-1.4C](#).
4. **Field Inspection** – Field verify per [Section 9-1.5](#).
5. **Specification Requirements** – See *Standard Specifications* Sections 9-13 or 9-27.3(6). Review contract documents to determine if supplemental specifications apply.
6. **Other Requirements** – Refer to *Standard Specifications* Sections 9-13 and 9-13.4 to see if recycled materials are permitted.

#### 9-4.43 **Semi-Open Slope Protection**

1. **Approval of Material** – Approval of materials is required prior to use. Materials will be approved by the Qualified Products List or Request for Approval of Material DOT Form 350-071. Be certain to verify that the product is in fact qualified for its intended use and the product is listed under the appropriate specification.  
**RAM Submittal** – Attach Catalog Cuts using the Catalog Cut Transmittal DOT Form 350-072 to assist in the approval process.
2. **Preliminary Samples** – A preliminary sample of the material will be required only if coded on the Request for Approval of Material DOT Form 350-071.
3. **Acceptance** – Acceptance shall be by the Certificate of Compliance which will accompany each shipment per [Section 9-1.4E](#).
4. **Field Inspection** – Field verify per [Section 9-1.5](#).
5. **Specification Requirements** – See *Standard Specifications* Section 9-13.5(1). See Standard Plans. Review contract documents to determine if supplemental specifications apply.
6. **Other Requirements** – None.

#### 9-4.44 **Plant Material**

1. **Approval of Material** – In accordance with Section 1-06 of the *Standard Specifications*, approval of the Nursery is required prior to the start of planting. The Nursery will be approved by the Qualified Products List or Request for Approval of Material DOT Form 350-071. Be certain to verify that the product is in fact qualified for its intended use and the product is listed under the appropriate specification.  
**RAM Submittal** – The Project Engineer can approve the Request for Approval of Material (RAM). The Regional Landscape Architect or HQ Design Landscape Architect can assist the Project Engineer in these evaluations.

2. **Preliminary Samples** – A preliminary Site Inspection will be required only if coded on the Request for Approval of Material DOT Form 350-071. Contact the Regional Landscape Architect or HQ Design Landscape Architect.
3. **Acceptance** – Visual Acceptance per [Section 9-1.4C](#).

Check for uniformity of plants within each lot and for representative sample lot based on the following:

(N = total number of plants in lot) (n = number of plants in sample lot)

Total Number of Plants (N)	Minimum No. of Plants Required to Make Sample Lot (n)
0 – 500	All plants
501 – 1,000	500
1,001 – 5,000	600
5,001 – 30,000	850
Over 30,000	1000

Should 5 percent or less of the sample lot fail, the entire lot may be accepted. Should over 5 percent of the acceptance sample lot fail to meet nominal specification requirements, the entire lot shall be rejected and removed from the project. The engineer may accept the plants if there is a large percentage of plants that appears to be exceptionally hearty and vigorous after sorting by the Contractor. If done immediately, the contractor shall be allowed to sort and remove the substandard portion of the plants.

After the contractor has completed sorting, a new sample lot based on the above schedule of the remaining stock will again be selected and inspected. Should 5 percent or less of this sample lot fail, the sorted lot may be accepted.

4. **Field Inspection** – Field verify per [Section 9-1.5](#).
5. **Specification Requirements** – See *Standard Specifications* Section 9-14.7. Review contract documents to determine if supplemental specifications apply.
6. **Other Requirements** – If there is a question on the plant material, contact the Regional Landscape Architect or HQ Design Landscape Architect at 360-705-7230.

Materials may be subject to Buy America and/or Build America/Buy America (BABA) requirements when included in the Contract by Special Provision. Refer to [Section 9-1.2E](#)

#### 9-4.45 Topsoil

1. **Approval of Material** – In accordance with *Standard Specifications* Section 1-06, approval of materials is required prior to use. Materials will be approved by the Request for Approval of Material DOT Form 350-071. Be certain to verify that the product is in fact qualified for its intended use and the product is listed under the appropriate specification.

**RAM Submittal** – The Project Engineer can approve the Request for Approval of Material (RAM). The Regional Landscape Architect or HQ Design Landscape Architect can assist the Project Engineer in these evaluations.

2. **Preliminary Samples** – A preliminary sample of the material will be required only if coded on the Request for Approval of Material DOT Form 350-071.

3. **Acceptance**
  - Type A – Acceptance shall be as stated in the Contract Documents.
  - Type B & C – Visual Acceptance per [Section 9-1.4C](#).
4. **Field Inspection** – Field verify per [Section 9-1.5](#).
5. **Specification Requirements** – See *Standard Specifications* Section 9-14.2. Review contract documents to determine if supplemental specifications apply.
6. **Other Requirements** – If there is a question on the top soil, contact the Regional Landscape Architect or HQ Design Landscape Architect at 360-705-7230.

#### 9-4.46 Seed

1. **Approval of Material** – In accordance with *Standard Specifications* Section 1-06, approval of materials is required prior to use. Materials will be approved by the Qualified Products List or Request for Approval of Material DOT Form 350-071. Be certain to verify that the product is in fact qualified for its intended use and the product is listed under the appropriate specification.

**RAM Submittal** – Attach business license issued by the supplier’s state or provincial Department of Licensing with a “seed dealer” endorsement. The Project Engineer can approve the Request for Approval of Material (RAM). The Region Landscape Architect or the HQ Design Landscape Architect can assist the Project Engineer in evaluating these submittals.

2. **Preliminary Samples** – A preliminary sample of the material will be required only if coded on the Request for Approval of Material (DOT Form 350-071).
3. **Acceptance**
  - a. **Non-Native or Non-Source Identified Seed** – Acceptance shall be by Certificate of Compliance per [Section 9-1.4E](#). Retain label and certifications during each placement pay period showing analysis for Contract records. Seed shall be accepted based on analysis shown on the label/tag meeting contract requirements and by certification demonstrating compliance with [WAC 16-302](#) for prohibited weed, noxious weeds, other weeds, and other crops.
  - b. **Native Seed, Source Not Identified** – Acceptance shall be by Certificate of Compliance per [Section 9-1.4E](#). Retain label and certifications during each placement pay period showing analysis for Contract records. Seed shall be accepted based upon the analysis shown on the label/tag meeting contract requirements and by certification that seed meets or exceeds Washington State Department of Agriculture Seed Standards and by certification (blue tag) demonstrating compliance with [WAC16-302](#) for prohibited weed, noxious weeds, other weeds, and other crops.
  - c. **Native Seed, Source Identified** – Acceptance shall be by Certificate of Compliance per [Section 9-1.4E](#). Retain label and certifications during each placement pay period showing analysis for Contract records. Seed shall be accepted based upon the analysis shown on the label/tag meeting contract requirements and by certification that seed meets or exceeds Washington State Department of Agriculture Seed Standards and by certification (blue tag) demonstrating compliance with [WAC 16-302](#) for prohibited weed, noxious weeds, other weeds, and other crops and certification by yellow seed label from the Association of Official Seed Certifying Agents (AOSCA) or by site identification log.

4. **Field Inspection** – Field verify per [Section 9-1.5](#).
5. **Specification Requirements** – See *Standard Specifications* Section 9-14.3. Review contract documents to determine if supplemental specifications apply.
6. **Other Requirements** – If there is a question on the correct seed for the intended use, or other questions, contact the Region Landscape Architect or HQ Design Landscape Architect at 360-705-7230.

Materials may be subject to Buy America and/or Build America/Buy America (BABA) requirements when included in the Contract by Special Provision. Refer to [Section 9-1.2E](#).

#### 9-4.47 Fertilizer

1. **Approval of Material** – In accordance with *Standard Specifications* Section 1-06, approval of materials is required prior to use. Materials will be approved by the Qualified Products List or Request for Approval of Material DOT Form 350-071. Be certain to verify that the product is in fact qualified for its intended use and the product is listed under the appropriate specification.  
**RAM Submittal** – The Project Engineer can approve the Request for Approval of Material (RAM). The Regional Landscape Architect or HQ Design Landscape Architect can assist the Project Engineer in these evaluations.
2. **Preliminary Samples** – A preliminary sample of the material will be required only if coded on the Request for Approval of Material DOT Form 350-071.
3. **Acceptance**
  - a. **Fertilizer for General Use** – Visual Acceptance per [Section 9-1.4C](#). Verify that the material and chemical content shown on container label meets contract requirements.
  - b. **Fertilizer for Erosion Control**
    - i. **Less than 5 Acres** – Visual Acceptance per [Section 9-1.4C](#). Verify that the material and chemical content shown on container label meets contract requirements.
    - ii. **5 Acres and Greater** – Acceptance of fertilizer shall be by receipt of a Manufacturer's Certificate of Compliance (*Standard Specifications* Section 1-06.3) per [Section 9-1.4D](#).
4. **Field Inspection** – Field verify per [Section 9-1.5](#).
5. **Specification Requirements** – See *Standard Specifications* Section 9-14.4. Review contract documents to determine if supplemental specifications apply.
6. **Other Requirements** – If there is a question on the intended use of the fertilizer, contact the Region or State Roadside and Site Development Office at 360-705-7230.

Materials may be subject to Buy America and/or Build America/Buy America (BABA) requirements when included in the Contract by Special Provision. Refer to [Section 9-1.2E](#).

**9-4.48 Mulch**

1. **Approval of Material** – In accordance with *Standard Specifications* Section 1-06, approval of materials is required prior to use. Materials will be approved by the Qualified Products List or Request for Approval of Material DOT Form 350-071. Be certain to verify that the product is in fact qualified for its intended use and the product is listed under the appropriate specification.

**RAM Submittal** – The Project Engineer can approve the Request for Approval of Material (RAM). The Regional Landscape Architect or HQ Design Landscape Architect can assist the Project Engineer in these evaluations.

- a. **Straw** – A certificate of compliance from either North America Weed Management Association (NAWMA) or Washington Wilderness Hay and Mulch (WWHAM) program indicating the straw is weed free or provide certification that the straw is steam or heat treated and is weed free.
- b. **Hydraulically Applied Erosion Control Products (HECP), Moderate-Term Mulch, and Short-Term Mulch** – Submit the following:
  - Test results dated within three years prior to the date of application from independent laboratory demonstrating compliance with Table 1 of *Standard Specifications* Section 9-14.5(2). Test results shall be reported on WSDOT Form 220-043, Temporary HECP Mulch Test Result Submission.
  - If the HECP contains cotton or straw, provide documentation that the material has been steam or heat treated to kill seeds or provide a U.S., Washington, or other State's Department of Agriculture laboratory test reports, dated within 90 days prior to the date of application, showing there are no viable seeds in the mulch.
  - Safety Data Sheet (SDS) that demonstrates that the product is not harmful to plants, animals, and aquatic life.
- c. **Hydraulically Applied Erosion Control Products (HECP), Long-Term Mulch** – Submit the following:
  - Test results dated within three years prior to the date of application from independent laboratory demonstrating compliance with Tables 1 and 2 of *Standard Specifications* Section 9-14.5(2). Test results shall be reported on WSDOT Form 220-042, Long Term HECP Mulch Test Result Submission.
  - If the HECP contains cotton or straw, provide documentation that the material has been steam or heat treated to kill seeds or provide a U.S., Washington, or other State's Department of Agriculture laboratory test reports, dated within 90 days prior to the date of application, showing there are no viable seeds in the mulch.
  - Safety Data Sheet (SDS) that demonstrates that the product is not harmful to plants, animals, and aquatic life.
  - Independent test results from the National Transportation Product Evaluation Program (NTPEP) for ASTM D 6459.
- d. **Wood Strand Mulch** – Submit preliminary sample to the State Materials Laboratory for evaluation.

- e. **Organic Synthetic Tackifier** – Submit the following:
    - Test results dated within three years prior to the date of application from independent laboratory demonstrating compliance with Table 1 of *Standard Specifications* Section 9-14.4(2).
    - Safety Data Sheet (SDS) that demonstrates that the product is not harmful to plants, animals, and aquatic life.
  - f. **Compost** – Submit the following:
    - A copy of the Solid Waste Handling Permit issued to the manufacturer by the Jurisdictional Health Department in accordance with [WAC 173-350](#).
    - Provide laboratory analysis from independent Seal of Testing Assurance (STA) Program certified laboratory that the material complies with the processes, testing, and standards specified in [WAC 173-350](#) and *Standard Specifications* 9-14.5(8).
    - A copy of the manufacturer's Seal of Testing Assurance (STA) certification as issued by the U.S. Composting Council.
2. **Preliminary Samples** – A preliminary sample of the material will be required only if coded on the Request for Approval of Material DOT Form 350-071.
  3. **Acceptance**
    - a. **Straw** – Acceptance shall be by Visual Acceptance per [Section 9-1.4C](#).
    - b. **Hydraulically Applied Erosion Control Products (HECPs), Long-Term Mulch, Moderate-Term Mulch, and Short-Term Mulch** – Acceptance shall be by Visual Acceptance per [Section 9-1.4C](#).
    - c. **Bark or Wood Chips** – Acceptance shall be by the Certification of Compliance per [Section 9-1.4E](#).
    - d. **Tackifier** – Acceptance shall be by Visual Acceptance per [Section 9-1.4C](#).
    - e. **Compost** – Materials shall be accepted on receipt of “Satisfactory” test report from an independent STA program certified laboratory, documentation stating that the compost facility is STA certified, waste handling permit, etc., see contract provisions.
    - f. **Wood Strand Mulch** – Acceptance shall be by “Satisfactory” test report from the Contractor, performed in accordance with WSDOT Test Method 125 and Safety Data Sheet (SDS) that demonstrates the product is not harmful to plant life.
  4. **Field Inspection** – Field verify per [Section 9-1.5](#).
  5. **Specification Requirements** – See *Standard Specifications* Section 9-14.5. Review contract documents to determine if supplemental specifications apply.
  6. **Other Requirements** – If there is a question on the intended use of mulch, contact the Region Landscape Architect, or State Roadside and Site Development Office at 360-705-7230.

Materials may be subject to Buy America and/or Build America/Buy America (BABA) requirements when included in the Contract by Special Provision. Refer to [Section 9-1.2E](#).

**For Compost Only** – Samples may be tested using the Solvita Compost Maturity Test by the Contracting Agency at the Engineer’s discretion. To purchase Solvita Compost Maturity Test Kits for field office use, contact Woods End Research Laboratory, Inc., Box 297, Mount Vernon, Maine 04352, 207-293-2457, email [info@woodsendlab.org](mailto:info@woodsendlab.org).

**Note:** If the compost smells like ammonia, the Solvita test should be performed.

#### 9-4.49 Irrigation System

1. **Approval of Material** – In accordance with *Standard Specifications* Section 1-06, approval of materials is required prior to use. Materials will be approved by the Qualified Products List or Request for Approval of Material DOT Form 350-071. Be certain to verify that the product is in fact qualified for its intended use and the product is listed under the appropriate specification.

**RAM Submittal** – If approval action is being requested via the RAM process, attach Catalog Cuts or other appropriate documents, using proper transmittal, to assist in the approval process. All Irrigation System materials being requested via RAM process will be sent to the Region or State Roadside and Site Development Office, except for Electrical Wire and Splices, which will be sent to the State Materials Laboratory. Atmospheric vacuum breaker assemblies (AVBA), pressure vacuum breaker assemblies (PVBA), double check valve assemblies (DCVA) and reduced pressure backflow devices (RBF) shall be of a manufacturer and model approved for use by the Washington State Department of Health. When approved, be certain to verify that the product is in fact qualified for its intended use, and the product is listed under the appropriate specification.

2. **Preliminary Samples** – A preliminary sample of the material will be required only if coded on the Request for Approval of Material DOT Form 350-071.
3. **Acceptance**
  - a. **QPL Acceptance**
    - i. **PVC Pipe and Fittings, Automatic Controllers, Spray Heads, Valve Boxes and Protective Sleeves, Automatic Control Valves with Pressure Regulator, Quick Coupling Equipment, Electrical Wire and Splices** – Visual Acceptance per [Section 9-1.4C](#).
    - ii. **Cross-Connection Control Devices** – Visual Acceptance per [Section 9-1.4C](#). Document that the model number of the device is listed on the current Washington State Department of Health (WSDOH) listing.
  - b. **Non-QPL Acceptance**
    - i. **PVC Pipe, Polyethylene Pipe, and Detectable Marking Tape** – Visual Acceptance per [Section 9-1.4C](#).
    - ii. **Galvanized Iron Pipe** – Manufacturer’s Certificate of Compliance per [Section 9-1.4D](#).
    - iii. **PVC Pipe Fittings, Drip Tubing, Automatic Controllers, Spray Heads, Valve Boxes and Protective Sleeves, Gate Valves, Manual Control Valves, Automatic Control Valves, Automatic Control Valves with Pressure Regulator, Quick Coupling Equipment, Drain Valves, Hose Bibs, Check Valves, Pressure Regulating Valves, Three-Way Valves, Flow Control Valves, Air Relief Valves, Electrical Wire and Splices, Wye Strainers** – Catalog Cut per [Section 9-1.4G](#).

- iv. **Cross Connection Control Devices** – Manufacturer's Certificate of Compliance per [Section 9-1.4D](#), indicating device is approved by Washington State Department of Health (WSDOH) listing, and Catalog Cut per Section 9-1.4G.
4. **Field Inspection** – Field verify per [Section 9-1.5](#).
5. **Specification Requirements** – See *Standard Specifications* Section 9-15. Review contract documents to determine if supplemental specifications apply.
6. **Other Requirements** – Materials may be subject to Buy America and/or Build America/Buy America (BABA) requirements when included in the Contract by Special Provision. Refer to [Section 9-1.2E](#).

#### 9-4.50 **Fencing and Gates**

1. **Approval of Material** – In accordance with *Standard Specifications* Section 1-06, approval of materials is required prior to use. Materials will be approved by the Qualified Products List or Request for Approval of Material DOT Form 350-071. Be certain to verify that the product is in fact qualified for its intended use and the product is listed under the appropriate specification.  
RAM Submittal
  - a. **Chain Link Fabric** – Submit a manufacturer's certification of compliance demonstrating compliance with Section 9-16.1(1)B of the *Standard Specifications*.
  - b. **Wire Mesh** – Submit a manufacturer's certificate of compliance demonstrating compliance with Section 9-16.2(1)C of the *Standard Specifications*.
  - c. **Tension Wire** - Submit a manufacturer's certificate of compliance demonstrating compliance with Section 9-16.1(1)C of the *Standard Specifications*.
  - d. **Barbed Wire** - Submit a manufacturer's certificate of compliance demonstrating compliance with Section 9-16.2(1)E of the *Standard Specifications*.
  - e. **Grade 1 Post Material**
    - i. **Rails and Grade 1 Posts for Chain Link Fence** – Sample to consist of one post and 12-in sample from each end of the rail, where appropriate.
    - ii. **Corner Posts or Brace Posts** – One complete post assembly.
    - iii. **Wire Fence Line Posts** – One complete post with plate.
  - f. **Colored Ultraviolet-Insensitive Coating Material** – The Project Engineer can approve the Request for Approval of Materials. The State Materials Engineer can assist the Project Engineer in these evaluations.
2. **Preliminary Samples** – A preliminary sample of the material will be required only if coded on the Request for Approval of Material DOT Form 350-071.
3. **Acceptance**
  - a. The following materials shall be accepted on receipt of an acceptable Manufacturer's Certificate of Compliance per [Section 9-1.4D](#):
    - i. Chain Link Fabric and Wire Mesh
    - ii. Tension Wire and Barbed Wire
    - iii. Grade 1 and Grade 2 Post Material



- iv. Rails, Corner Posts, and Brace Posts
- v. Wire Fence Line Posts
- b. **Gates, Miscellaneous Fence Hardware, and Colored Ultraviolet-Insensitive Coating Material** – Visual Acceptance per [Section 9-1.4C](#).  
Miscellaneous fence hardware includes such items as tie wire, hog rings, galvanized bolts, nuts, washers, fence clips, stays, post caps, tension band and bars, rail end caps, etc.
- c. **Project Office Optional Testing** - Materials of questionable quality may be sampled and tested at Project Engineer discretion.
  - i. Chain Link Fabric - One sample consisting of three wires across full width of fabric, from one roll.
  - ii. Wire Mesh - One 12 inch sample across full width of roll.
  - iii. Tension Wire - One 3 foot sample from roll.
  - iv. Barbed Wire - One 3 foot sample from roll.
- 4. **Field Inspection** – Field verify per [Section 9-1.5](#).
- 5. **Specification Requirements** – See *Standard Specifications* Section 9-16. Review contract documents to determine if supplemental specifications apply.
- 6. **Other Requirements** – Materials may be subject to Buy America and/or Build America/Buy America (BABA) requirements when included in the Contract by Special Provision. Refer to [Section 9-1.2E](#).

#### 9-4.51 **Beam Guardrail, Guardrail Anchors, and Guardrail Terminals**

1. **Approval of Material** – In accordance with *Standard Specifications* Section 1-06, approval of materials is required prior to use. Materials will be approved by the Qualified Products List or Request for Approval of Material DOT Form 350-071. An on-site inspection by the WSDOT Materials Fabrications Inspection Office of the fabricating facilities prior to approval will be required only if a new manufacture is requested on the Request for Approval of Material DOT Form 350-071. Be certain to verify that the product is in fact qualified for its intended use and the product is listed under the appropriate specification.

##### RAM Submittal

- **Beam Guardrail Fabricator** – Submit the following information; Name of facility, contact person, phone number, email address, and facility address.
- **Guardrail Anchor Components**
  - **Foundation Tube** – Submit a manufacturer’s certificate of compliance demonstrating compliance with Section 9-16.3(5) of the *Standard Specifications*.
  - **Anchor Plate Assembly and Anchor Cable** – Submit a manufacturer’s certificate of compliance and supporting test report demonstrating compliance with Section 9-16.3(5) of the *Standard Specifications*.
  - **Swaged Cable Fitting** – Submit one sample in accordance with Section 9-16.3(5).
- **Guardrail Terminal (Proprietary Systems)** – Submit either NCHRP Report 350 or Manual for Assessment of Safety Hardware (MASH) crash testing report.

2. **Preliminary Samples** – A preliminary sample of the material will be required only if coded on the Request for Approval of Material DOT Form 350-071.
3. **Acceptance**
  - a. **Beam Guardrail and Components**
    - **W-Beam and Thrie Beam Rail Element, Backup Plates, Reducer Sections, and End Sections and Galvanizing** – Acceptance shall be by a manufacturer’s certificate of compliance in accordance with [Section 9-1.4D](#).
    - **Post and Block** – Acceptance shall be in accordance with [Section 9-4.52](#).
    - **Hardware**
      - **Unfinished Bolts, Nuts, and Washers** – Acceptance shall be in accordance with [Section 9-4.23](#).
      - **High Strength Bolts, Nuts, and Washers** – Acceptance shall be in accordance with [Section 9-4.24](#).
  - b. **Guardrail Anchor and Components**
    - **Foundation Tube** – Acceptance shall be by a manufacturer’s certificate of compliance in accordance with [Section 9-1.4D](#).
    - **Anchor Plate Assembly and Anchor Cable** – Acceptance shall be by a manufacturer’s certificate of compliance and supported test results in accordance with [Section 9-1.4D](#).
    - **Swage Cable Fitting** – Acceptance shall be by a “Satisfactory test report from the State Materials Laboratory. Sample shall be prepared in accordance with [Section 9-16.3\(5\)](#) of the *Standard Specifications*.
  - c. **Guardrail Terminals**
    - **Non-Proprietary Systems**
      - **W-Beam and Thrie Beam Rail Element, Backup Plates, Reducer Sections, and End Sections and Galvanizing** – Acceptance shall be by a manufacturer’s certificate of compliance in accordance with [Section 9-1.4D](#).
      - **Post and Block** – Acceptance shall be in accordance with [Section 9-4.52](#).
      - **Hardware**
        - **Unfinished Bolts, Nuts, and Washers** – Acceptance shall be in accordance with [Section 9-4.23](#).
        - **High Strength Bolts, Nuts, and Washers** – Acceptance shall be in accordance with [Section 9-4.24](#).
    - **Proprietary Systems** – Review contract documents to determine acceptance criteria.
4. **Field Inspection** – Field verify per [Section 9-1.5](#).
5. **Specification Requirements** – See *Standard Specifications* [Section 9-16.3](#) and *Standard Plans* M 21-01.
6. **Other Requirements** – Materials may be subject to Buy America and/or Build America/Buy America (BABA) requirements when included in the Contract by Special Provision. Refer to [Section 9-1.2E](#).

### 9-4.52 **Guardrail Posts and Blocks**

1. **Approval of Material** – In accordance with *Standard Specifications* Section 1-06, approval of materials is required prior to use. Materials will be approved by the Qualified Products List or Request for Approval of Material DOT Form 350-071. An on-site inspection by the WSDOT Materials Fabrications Inspection Office of the Fabrication and Treatment Facilities prior to approval will be required only if a new manufacture is requested on the Request for Approval of Material DOT Form 350-071. Be certain to verify that the product is in fact qualified for its intended use and the product is listed under the appropriate specification.
2. **Preliminary Samples** – A preliminary sample of the material will be required only if coded on the Request for Approval of Material DOT Form 350-071.
3. **Acceptance**
  - a. **Treated Timber Posts and Blocks** – Shall be accepted by a Lumber Grading Stamp or Grading Certificate for Timber and Lumber and Certificate of Treatment.
  - b. **Steel Post and Blocks** – Shall be accepted by a Manufacturer's Certificate of Compliance per [Section 9-1.4D](#).
  - c. **Alternate Block Material** – Shall be accepted by documentation demonstrating conformance to the requirements of NCHRP Report 350 or the AASHTO Manual for Assessing Safety Hardware (MASH).
4. **Field Inspection** – Field verify per [Section 9-1.5](#).
5. **Specification Requirements** – See *Standard Specifications* Section 9-16.3 and Standard Plans.
6. **Other Requirements** – Materials may be subject to Buy America and/or Build America/Buy America (BABA) requirements when included in the Contract by Special Provision. Refer to [Section 9-1.2E](#).

### 9-4.53 **Miscellaneous Precast Concrete Products (Block Traffic Curb, Precast Traffic Curb)**

1. **Approval of Material** – Approval of materials is required prior to use. Materials will be approved by the Qualified Products List or Request for Approval of Material DOT Form 350-071. An on-site inspection by the WSDOT Materials Fabrication Office of the fabricating facilities prior to approval will be required only if a new manufacture is requested on the Request for Approval of Material DOT Form 350-071. Be certain to verify that the product is in fact qualified for its intended use and the product is listed under the appropriate specification.
2. **Preliminary Samples** – A preliminary sample of the material will be required only if coded on the Request for Approval of Material DOT Form 350-071.
3. **Acceptance**
  - a. **Precast Traffic Curb** – Visual Acceptance per [Section 9-1.4C](#). Unless the curb sections have been inspected prior to shipping they are to be carefully inspected upon arrival on the project site. Check for surface color and damage, such as cracks, broken corner or edges, contour and alignment. Surface color and texture should match advanced sample provide by the manufacturer. See Standard Plans for details.

- b. **Block Traffic Curb** – Visual Acceptance per [Section 9-1.4C](#). Check exposed faces of curb sections for damage such as chips, cracks, and air holes. See *Standard Specifications* Section 9-18.3 for details. Compressive strength may be determined in accordance with the FOP for ASTM C 805.
4. **Field Inspection** – Field verify per [Section 9-1.5](#).
5. **Specification Requirements** – See *Standard Specifications* Section 9-18. Review contract documents to determine if supplemental specifications apply.
6. **Other Requirements** – Materials may be subject to Buy America and/or Build America/Buy America (BABA) requirements when included in the Contract by Special Provision. Refer to [Section 9-1.2E](#).

#### 9-4.54 **Prestressed Concrete Girders**

1. **Approval of Material** – Approval of the Fabricator is required prior to the start of fabrication. The Fabricator will be approved by the Qualified Products List or Request for Approval of Material DOT Form 350-071. Be certain to verify that the product is in fact qualified for its intended use and the product is listed under the appropriate specification. Materials used within the fabricated item do not require approval through the Project Engineer office. Provide the WSDOT Materials Fabrication Inspection Office with a copy of the Qualified Products Page or Request for Approval of Material listing the Fabricator. Review of the Contract Special Provisions is necessary to determine if special qualifications or testing is required for approval of the Fabricator.
2. **Preliminary Samples** – A preliminary sample of the material will be required only if coded on the Request for Approval of Material DOT Form 350-071.
3. **Acceptance** – Acceptance is based on “APPROVED FOR SHIPMENT” Stamp and/or Tag ([Figure 9-4](#) or [9-5](#)). An “F” or “D” will be stamped to indicate the steel or iron is of foreign or domestic origin.

The Materials Fabrication Inspector will provide a weekly Fabrication Progress Report to the Project Engineer while the girders are being fabricated.

4. **Field Inspection** – Field verify per [Section 9-1.5](#).
5. **Specification Requirements** – See *Standard Specifications* Section 6-02.3(25), 6-05.3(3), 6-02.3(28), and Section 9-19. Review contract documents to determine if supplemental specifications apply.
6. **Other Requirements** – Certification of Material Origin will be the responsibility of the Materials Fabrication Inspector as defined in Section 9-2.1A.

Materials may be subject to Buy America and/or Build America/Buy America (BABA) requirements when included in the Contract by Special Provision. Refer to [Section 9-1.2E](#).

#### 9-4.55 **Pavement Marking Materials**

1. **Approval of Material** – In accordance with *Standard Specifications* Section 1-06, approval of materials is required prior to use. Materials will be approved by the Qualified Products List or Request for Approval of Material DOT Form 350-071. Be certain to verify that the product is in fact qualified for its intended use and the product is listed under the appropriate specification.

**RAM Submittal** – Pavement Marking Paint and Plastic that are not listed on the QPL shall provide test data from an independent laboratory and field test documentation from northern NTPEP (National Transportation Product Evaluation Program) or test deck information conducted by other public entities may be considered provided the data is similar to a northern NTPEP Test Deck.

Raised Pavement Markers that are not listed on the QPL shall provide a sample and test data from an independent laboratory and field test documentation from northern NTPEP (National Transportation Product Evaluation Program) or test deck information conducted by other public entities may be considered provided the data is similar to a northern NTPEP Test Deck.

Glass Beads that are not listed in the QPL shall provide test data from an independent laboratory demonstrating compliance with *Standard Specifications* Section 9-34.4.

2. **Preliminary Samples** – A preliminary sample of the material will be required only if coded on the Request for Approval of Material DOT Form 350-071.
3. **Acceptance** – Visual Acceptance per [Section 9-1.4C](#).
4. **Field Inspection** – Field verify per [Section 9-1.5](#).
5. **Specification Requirements** – See *Standard Specifications* Section 9-21 and 9-34. Review contract documents to determine if supplemental specifications apply.
6. **Other Requirements** – There may be special shipping requirements for epoxy and adhesive. These samples shall be transported to the Region Materials Laboratory for proper shipping.

Materials may be subject to Buy America and/or Build America/Buy America (BABA) requirements when included in the Contract by Special Provision. Refer to [Section 9-1.2E](#).

#### **9-4.56 *Signing Materials, Mounting Hardware, Posts, Sign Supports and Digital Printing System – Reflective Sheeting with its Integrated Engineered Matched Component System: Ink, Clear Overlay Film and Digital Printer and Sign Fabricator***

1. **Approval of Material** – In accordance with *Standard Specifications* Section 1-06, approval of the Sign Fabricator as well as the manufacturer of the sign blanks, panels, reflective sheeting, posts, and sign supports is required prior to the start of fabrication. The Fabricator will be approved by the Qualified Products List (QPL) or Request for Approval (RAM) of Material DOT Form 350-071. Be certain to verify that the product is in fact qualified for its intended use and the product is listed under the appropriate specification. Materials used within the fabricated item, approved by Materials Fabrication Inspection Office do not require approval through the Project Office. The Project Office has the option of inspecting the project signs prior to installation as detailed in Section 9-2.3B or they can request that the WSDOT Fabrication Office inspect the permanent sign at the fabrication facility prior to shipment to the project per Section 9-2.3A. If the Project Office elects to have the signs inspected by the Fabrication Inspection Office they must send a copy of the Qualified Products Page or Request for Approval of Material listing the Fabricator to the WSDOT Materials Fabrication Inspection Office. Review of the Contract Special Provisions is necessary to determine if special qualifications or testing is required for approval of the Fabricator.

A RAM will not be required for sign mounting hardware provided by the Sign Fabricator. Mounting hardware from a source other than the sign fabrication facility will require approval by Request for Approval of Material DOT Form 350-071.

RAM Submittal:

- a. **Sign Fabricator, and the Manufacturers of Sign Blanks, Panels, Reflective Sheeting, Posts, and Sign Supports** – Submit the following information; Name of Facility, Contact Person, phone number, email address, and facility address.
  - b. **Sign Support Types; AP, AS, PL, PL-T, PL-U, SB-1, SB-2, SB-3, ST-1, ST-2, ST-3, ST-4, TPA, and TPB** – Submit either NCHRP Report 350 or Manual of Assessment of Safety Hardware (MASH) crash test report.
  - c. **Digital Printing System**
    - i. Product Number for Reflective Sheeting, Ink and Overlay Material and Type and Model Number for Digital Printer
    - ii. A detailed Certification Letter that identifies the specific Sign Fabricator and identifies in the letter the integrated engineered match component system the plant is being certified for
    - iii. **Sign Fabricator**
      - If Sign Fabricator is an approved sign shop – submit digitally printed signs and a Certification Letter from the sign material manufacturer that identifies an integrated engineer match component system that is listed in the QPL under Section 9-28.10
      - If Sign Fabricator is not an approved sign shop – submit the following information; Name of Facility, Contact Person, phone number, email address, and facility address
2. **Preliminary Samples** – A preliminary sample of the material may be required only if coded on the Request for Approval of Material DOT Form 350-071, or as requested by the Sign Fabricator Inspector.
3. **Acceptance**
- a. **Materials Fabrication Inspected Items**
    - i. **Sign** – Acceptance is based on a “FABRICATION APPROVED” Decal (Figure 9-8).
    - ii. **Sign Mounting Hardware** – Hardware supplied by the Sign Fabricator will have the mounting hardware certifications verified at the sign fabricator’s facility by the Materials Fabrication Inspector to ensure the materials meet the contract requirements. These records will be kept at the sign fabrication facility. Fabrication inspectors will verify sign mounting hardware as it is packaged for shipment and stamp it “WSDOT INSPECTED” (Figure 9-3). An “F” or “D” will be stamped to indicate the steel or iron is of foreign or domestic origin.

Contractors who purchase sign mounting hardware separately from a source other than a WSDOT approved sign fabrication facility will be required to supply a Manufacturer’s Certificates of Compliance per Section 9-1.4D and it will be the responsibility of the Contractor to supply the certifications to the Project Engineer’s Office prior to use.

- iii. **Bolts for Roadside Wood Posts** – Acceptance for A307 bolts, nuts and washers shall be by Visual Acceptance per [Section 9-1.4C](#).
  - b. **Non-Fabrication Inspected items (Project Engineer Acceptance)**
    - i. **Sheet Aluminum Signs, Fiberglass Reinforced Plastic Signs, Reflective Sheeting, Hardware (Bolts, U-Bolts, Washers, Nuts, Locknuts, Rivets, Post Clips, Wind Beams, Angles and “Z” Bars, Straps, and Mounting Brackets), and Posts** – Acceptance shall be by a Manufacturer’s Certificate of Compliance per [Section 9-1.4D](#).
    - ii. **Bolts for Roadside Wood Posts** – Acceptance for A307 bolts, nuts and washers shall be by Visual Acceptance per [Section 9-1.4C](#).
    - iii. **Sign Support Types; AP, AS, PL, PL-T, PL-U, SB-1, SB-2, SB-3, ST-1, ST-2, ST-3, ST-4, TPA, and TPB** – Acceptance shall be by Visual Acceptance in accordance with [Section 9-1.4C](#).
    - iv. **Reflective Sheeting with its Integrated Engineered Matched Component System: Ink, Clear Overlay Film and Digital Printer** – Acceptance shall be by Visual Acceptance in accordance with [Section 9-1.4C](#).
4. **Field Inspection**
  - a. **Materials Fabrication Inspected Items** – Field verify per [Section 9-1.5](#). Double-faced signs, which do not receive decals, will be approved on visual inspection at the fabricator’s facility and in the field. A list/invoice of all inspected and accepted signs will be kept in the WSDOT Materials Fabrication Inspection Office files. Check that all overhead signs are mounted with stainless steel bolts, U-bolts, washers, nuts, locknuts, mounting brackets and straps. Mounting hardware shall include bolts, nuts, washers, locknuts, rivets, post clips, windbeams, angles, “Z” bar, straps and mounting brackets.

If there is not a Decal present, inform the Project Engineer. If the sign is installed it should be removed and sent back to the fabrication facility or if not installed just sent back to the fabrication facility. The Project Office has the option to proceed with Project Engineer Acceptance as detailed below. Items lacking decals or stamps, or which are damaged during shipping, should be rejected and that material tagged or marked appropriately.
  - b. **Non-Fabrication Inspected Items (Project Engineer Acceptance)** – Field verify per [Section 9-1.5](#).
5. **Specification Requirements** – See *Standard Specifications* Section 9-28 and [Section 9-1.4B\(2\)](#). Review contract documents to determine if supplemental specifications apply.
6. **Other Requirements**
  - a. **Non-Fabrication Inspected Items (Project Engineer Acceptance)** – Once the Project Engineer has confirmed the sign complies with WSDOT specification requirements the Project Engineer shall apply “WSDOT PE APPROVED” decal (Figure 9-10) to the sign.

**b. Buy America Provisions**

- **Materials Fabrication Inspected CMO** – Certification of Materials Origin will be the responsibility of the Materials Fabrication Inspector as defined in Section 9-2.1A.

Materials may be subject to Buy America and/or Build America/Buy America (BABA) requirements when included in the Contract by Special Provision. Refer to [Section 9-1.2E](#).

- **Non-Fabrication Inspected CMO** – Materials may be subject to Buy America and/or Build America/Buy America (BABA) requirements when included in the Contract by Special Provision. Refer to [Section 9-1.2E](#).

**9-4.57 Liquid Concrete Curing Compound**

1. **Approval of Material** – In accordance with *Standard Specifications* Section 1-06, approval of materials is required prior to use. Materials will be approved by the Qualified Products List or Request for Approval of Material DOT Form 350-071. Be certain to verify that the product is in fact qualified for its intended use and the product is listed under the appropriate specification.
2. **Preliminary Samples** – A preliminary sample of the material will be required only if coded on the Request for Approval of Material DOT Form 350-071.
3. **Acceptance** – If the lot is listed on the QPL, it may be used without testing on current projects per Section 9-1.4A(1). If the lot is not on the QPL, submit a one-quart sample taken by, or in the presence of, an agency representative for each lot. Samples must be submitted for testing 10 days prior to use of curing compound. Samples submitted shall be accepted on receipt of “Satisfactory” test reports from the State Materials Laboratory.
4. **Field Inspection** – Field verify per [Section 9-1.5](#).
5. **Specification Requirements** – See *Standard Specifications* Section 9-23. Review contract documents to determine if supplemental specifications apply.
6. **Other Requirements** – Materials may be subject to Buy America and/or Build America/Buy America (BABA) requirements when included in the Contract by Special Provision. Refer to [Section 9-1.2E](#).

**9-4.58 Admixtures for Concrete**

1. **Approval of Material** – Approval of materials is required prior to use. Materials will be approved by the Qualified Products List or Request for Approval of Material DOT Form 350-071. Be certain to verify that the product is in fact qualified for its intended use and the product is listed under the appropriate specification.
2. **Preliminary Samples** – A preliminary sample of the material will be required only if coded on the Request for Approval of Material DOT Form 350-071.
3. **Acceptance** – Materials shall be accepted on the basis of a Certified Concrete Delivery Ticket and/or Electronic Ticket indicating the product and dosage of the admixture conform to the concrete mix design.
4. **Field Inspection** – Field verify per [Section 9-1.5](#).



5. **Specification Requirements** – See *Standard Specifications* Section 6-02.3(5)B and 9-23. Review contract documents to determine if supplemental specifications apply.
6. **Other Requirements** – Check Concrete Delivery Ticket and/or Electronic Ticket for proper admixture dosage.

Materials may be subject to Buy America and/or Build America/Buy America (BABA) requirements when included in the Contract by Special Provision. Refer to [Section 9-1.2E](#).

#### 9-4.59 **Plastic Waterstop**

1. **Approval of Material** – Approval of materials is required prior to use. Materials will be approved by the Qualified Products List or Request for Approval of Material DOT Form 350-071. Be certain to verify that the product is in fact qualified for its intended use and the product is listed under the appropriate specification.
2. **Preliminary Samples** – A preliminary sample of the material will be required only if coded on the Request for Approval of Material DOT Form 350-071.
3. **Acceptance** – Material shall be accepted by a Manufacturer's Certificate of Compliance per [Section 9-1.4D](#).
4. **Field Inspection** – Field verify per [Section 9-1.5](#).
5. **Specification Requirements** – See *Standard Specifications* Section 9-24. Review contract documents to determine if supplemental specifications apply.
6. **Other Requirements** – Materials may be subject to Buy America and/or Build America/Buy America (BABA) requirements when included in the Contract by Special Provision. Refer to [Section 9-1.2E](#).

#### 9-4.60 **Epoxy Systems**

1. **Approval of Material** – In accordance with *Standard Specifications* Section 1-06, approval of materials is required prior to use. Materials will be approved by the Qualified Products List or Request for Approval of Material DOT Form 350-071. Be certain to verify that the product is in fact qualified for its intended use and the product is listed under the appropriate specification.
2. **Preliminary Samples** – A preliminary sample of the material will be required only if coded on the Request for Approval of Material DOT Form 350-071.
3. **Acceptance**
  - a. **Epoxy Bonding Agents** – Materials shall be accepted on receipt of "Satisfactory" test reports from the State Materials Laboratory. For epoxy bonding agents, submit mix ratios, intended use and a representative sample of each component with MSDS sheet for each batch or lot number. Samples shall be submitted to the State Materials Laboratory. A period of 21 calendar days should be allowed for testing.

**Sample** – A representative sample shall be a minimum of a 1 pint container of each component or a pre-packaged kit. The sample size shall represent the mixing ratio, (for example; 1 pint of A and 2 pints of B, or 1 pint A and 3 pints of B). Containers shall be identified as "Component A" (Epoxy Resin) and "Component B" (Curing Agent) and shall be marked with the name of the manufacturer, the date of manufacture and the lot number.

- b. **Epoxy Grout/Mortar/Concrete** – Materials shall be accepted on receipt of “Satisfactory” test reports from the State Materials Laboratory. For epoxy grout/mortar/concrete, submit mix ratios, intended use and a representative sample of each component for each batch or lot number. Samples shall be submitted to the State Materials Laboratory. A period of 15 working days should be allowed for testing.

**Sample** – A representative sample shall be a minimum of a 1 pint container of each component or a pre-packaged kit. The sample size shall represent the mixing ratio, (for example; 1 pint of A and 2 pints of B, or 1 pint A and 3 pints of B). Containers shall be identified as “Component A” (Epoxy Resin), “Component B” (Curing Agent), and “Aggregate Component” and shall be marked with the name of the manufacturer, the date of manufacture and the lot number.

Acceptance for aggregate for non-Prepackaged Epoxy Grout/Mortar/Concrete shall be by the Certificate of Compliance per [Section 9-1.4E](#).

4. **Field Inspection** – Field verify per [Section 9-1.5](#).
5. **Specification Requirements** – See *Standard Specifications* Section 9-26. Review contract documents to determine if supplemental specifications apply.
6. **Other Requirements** - Type IV epoxy bonding agent may be substituted for and be tested to the same criteria as Type I when used in the application identified in *Standard Specifications* Section 5-01.3(6) and 5-05.3(10). Ensure that the transmittal states the Standard Specifications for which the material is being tested for.

Aggregate for non-Prepackaged Epoxy Grout/Mortar/Concrete shall meet the requirements of *Standard Specifications* Section 9-03.1(2).

There may be special shipping requirements for epoxy. These samples shall be transported to the Region Materials Laboratory for proper shipping.

Materials may be subject to Buy America and/or Build America/Buy America (BABA) requirements when included in the Contract by Special Provision. Refer to [Section 9-1.2E](#).

#### 9-4.61 **Resin Bonded Anchors**

1. **Approval of Material** – In accordance with *Standard Specifications* Section 1-06, approval of materials is required prior to use. Materials will be approved by the Qualified Products List or Request for Approval of Material DOT Form 350-071. Be certain to verify that the product is in fact qualified for its intended use and the product is listed under the appropriate specification.

**RAM Submittal** – If approval is being requested by the Request for Approval of Material process, submit independent laboratory test report indicating resin bonded anchor system, for the specified size rods, meets specification requirements when tested in accordance with ASTM E 488.

2. **Preliminary Samples** – A preliminary sample of the material will be required only if coded on the Request for Approval of Material DOT Form 350-071.

3. **Acceptance**
  - a. **Resin adhesive** – Acceptance shall be by Visual Acceptance per [Section 9-1.4C](#).
  - b. **Threaded Rod, Nut, and Washer or Other Inserts** – Acceptance shall be by the Manufacturer's Certificate of Compliance per [Section 9-1.4D](#).
4. **Field Inspection** – Field verify per [Section 9-1.5](#).
5. **Specification Requirements** – Review contract documents to determine if supplemental specifications apply.
6. **Other Requirements**

Materials may be subject to Buy America and/or Build America/Buy America (BABA) requirements when included in the Contract by Special Provision. Refer to [Section 9-1.2E](#).

There may be special shipping requirements for resin adhesive. These samples shall be transported to the Region Materials Laboratory for proper shipping.

#### **9-4.62 Gabion Cribbing, Hardware, and Stone**

1. **Approval of Material**

**Gabion Cribbing and Hardware** – In accordance with *Standard Specifications* Section 1-06, approval of materials is required prior to use. Materials will be approved by the Qualified Products List or Request for Approval of Material DOT Form 350-071. Be certain to verify that the product is in fact qualified for its intended use and the product is listed under the appropriate specification.

**Stone** – See Section 9-4.42.
2. **Preliminary Samples** – A preliminary sample of the material will be required only if coded on the Request for Approval of Material DOT Form 350-071.
3. **Acceptance**

**Gabion Cribbing and Hardware** – Acceptance shall be by the Manufacturer's Certificate of Compliance per [Section 9-1.4D](#).

**Stone** – See Section 9-4.42
4. **Field Inspection** – Field verify per [Section 9-1.5](#).
5. **Specification Requirements** – See *Standard Specifications* Section 9-27.3. Review contract documents to determine if supplemental specifications apply.
6. **Other Requirements** – Materials may be subject to Buy America and/or Build America/Buy America (BABA) requirements when included in the Contract by Special Provision. Refer to [Section 9-1.2E](#).

**9-4.63 Steel Sign Structures – Cantilever, Sign Bridge, Bridge Mounted, Roadside**

1. **Approval of Material** – Approval of the fabricator is required prior to the start of fabrication. The fabricator will be approved by the Qualified Products List or Request for Approval of Material DOT Form 350-071. Be certain to verify that the product is in fact qualified for its intended use and the product is listed under the appropriate specification. Materials used within the fabricated item do not require approval through the Project Engineer office. Provide the WSDOT Materials Fabrication Inspection Office with a copy of the Qualified Products Page or Request for Approval of Material listing the fabricator. Review of the Contract Special Provisions is necessary to determine if special qualifications or testing is required for approval of the fabricator.
2. **Preliminary Samples** – A preliminary sample of the material will be required only if coded on the Request for Approval of Material DOT Form 350-071.
3. **Acceptance** – The fabricated sign structure and associated hardware will be accepted on the basis of an “APPROVED FOR SHIPMENT” Stamp and/or Tag ([Figure 9-4](#) or [9-5](#)). An “F” or “D” will be stamped to indicate the steel or iron is of foreign or domestic origin.

- a. **Sign Structure** – Cantilever, Sign Bridge, Bridge Mounted, and Roadside Type PLT/PLU – Acceptance is based on “APPROVED FOR SHIPMENT” Stamp and/or Tag ([Figure 9-4](#) or [9-5](#)). An “F” or “D” will be stamped to indicate the steel or iron is of foreign or domestic origin.

**Note:** The Materials Fabrication Inspector will inspect hardware if it is available at the time of inspection at the point of manufacture. Acceptance for Roadside Sign Structure Hardware not present during Materials Fabrication inspection and delivered to the job site without an approval stamp shall be by the Manufacturer’s Certificate of Compliance per [Section 9-1.4D](#). High strength bolts, nuts and washers in quantities over 50 require sampling.

- b. **Roadside** – Except Type PLT and PLU – Acceptance for Roadside sign structures except for Types PLT and PLU shall be by the Manufacturer’s Certificate of Compliance per [Section 9-1.4D](#).

4. **Field Inspection** – Field verify per [Section 9-1.5](#).
5. **Specification Requirements** – See *Standard Specifications* Section 9-06.16 and 9-28.14. Review contract documents to determine if supplemental specifications apply.

6. **Other Requirements**

- a. **Materials Fabrication Inspected CMO** – Certification of Materials Origin will be the responsibility of the Materials Fabrication Inspector as defined in [Section 9-2.1A](#).

Materials may be subject to Buy America and/or Build America/Buy America (BABA) requirements when included in the Contract by Special Provision. Refer to [Section 9-1.2E](#).

- b. **Non-Fabrication Inspected CMO** – Materials may be subject to Buy America and/or Build America/Buy America (BABA) requirements when included in the Contract by Special Provision. Refer to [Section 9-1.2E](#).

#### 9-4.64 Conduit

- 1. Approval of Material** – In accordance with *Standard Specifications* Section 1-06, approval of materials is required prior to use. Materials will be approved by the Qualified Products List or Request for Approval of Material DOT Form 350-071. Be certain to verify that the product is in fact qualified for its intended use and the product is listed under the appropriate specification.  
**RAM Submittal** – Attach Catalog Cuts using the Catalog Cut Transmittal DOT Form 350-072 to assist in the approval process.
- 2. Preliminary Samples** – A preliminary sample of the material will be required only if coded on the Request for Approval of Material DOT Form 350-071.
- 3. Acceptance** – Visual Acceptance per [Section 9-1.4C](#) is required for Rigid Galvanized Steel, Aluminum, PVC, PE, HDPE, Fiberglass, and Flexible Metal Conduit including hardware such as (fittings, couplings, spacers, adapters, split internal expansion plugs, duct plugs, connectors, clamps, conduit bodies, and conduit supports), Expansion Fittings, Deflection Fittings, Combination Deflection and Expansion Fittings.
- 4. Field Inspection** – Field verify per [Section 9-1.5](#).
- 5. Specification Requirements** – See *Standard Specifications* Section 9-29.1. Review contract documents to determine if supplemental specifications apply.
- 6. Other Requirements** – Materials may be subject to Buy America and/or Build America/Buy America (BABA) requirements when included in the Contract by Special Provision. Refer to [Section 9-1.2E](#).

#### 9-4.65 Fiber Optic Cable, Electrical Conductors, and Cable

- 1. Approval of Material** – In accordance with *Standard Specifications* Section 1-06, approval of materials is required prior to use. Materials will be approved by the Qualified Products List or Request for Approval of Material DOT Form 350-071. Be certain to verify that the product is in fact qualified for its intended use and the product is listed under the appropriate specification.  
**RAM Submittal** – Attach Catalog Cut using DOT Form 350-072 to assist in the approval process. The Project Engineer can approve the Request for Approval of Material (RAM). The Region Traffic Engineer or the State Materials Laboratory can assist the Project Engineer in these evaluations.
- 2. Preliminary Samples** – A preliminary sample of the material will be required only if coded on the Request for Approval of Material DOT Form 350-071.
- 3. Acceptance** – Visual Acceptance per [Section 9-1.4C](#) of this manual.
- 4. Field Inspection** – Field verify per [Section 9-1.5](#).
- 5. Specification Requirements** – See *Standard Specifications* Section 9-29.3. Review Contract Documents to determine if supplemental requirements apply.
- 6. Other Requirements** – Materials may be subject to Buy America and/or Build America/Buy America (BABA) requirements when included in the Contract by Special Provision. Refer to [Section 9-1.2E](#).

### 9-4.66 Steel Poles – ITS, Pedestrian, Light, Signal Standards, and High Mast Light Poles

1. **Approval of Material** – In accordance with Section 1-06 of the *Standard Specifications*, approval of the fabricator is required prior to the start of fabrication. The fabricator will be approved by the Qualified Products List or Request for Approval of Material DOT Form 350-071. Be certain to verify that the product is in fact qualified for its intended use and the product is listed under the appropriate specification. Materials used within the fabricated item do not require approval through the Project Office. Provide the WSDOT Materials Fabrication Inspection Office with a copy of the Qualified Products Page or Request for Approval of Material listing the fabricator. Review of the Contract Special Provisions is necessary to determine if special qualifications or testing is required for approval of the fabricator.
2. **Preliminary Samples** – A preliminary sample of the material will be required only if coded on the Request for Approval of Material DOT Form 350-071.
3. **Acceptance**
  - a. **Steel Light and Signal Standards Type II – V, ITS, and High Mast Light Poles**  
– As determined by the Materials Fabrications Inspection Office, Steel Light, Signal Standards and High Mast Light Poles may be inspected at the point of manufacture prior to shipping or at the jobsite by the Materials Fabrication Inspector. Acceptance is based on “APPROVED FOR SHIPMENT” Stamp and/or Tag (Figure 9-4 or 9-5). An “F” or “D” will be stamped to indicate the steel or iron is of foreign or domestic origin.

Steel Light, Signal Standards and High Mast Light Poles delivered to the job site without “APPROVED FOR SHIPMENT” stamps and/or tags require Materials Fabrication Inspection. Contact the WSDOT Materials Fabrication Inspection Office for field inspection. Provide the Materials Fabrication Inspector the following documentation for their review prior to their physical inspection of the Steel Light, Signal Standards and High Mast Light Poles.

- Approved shop drawings not listed in Contract General Special Provisions.
- Manufacturer’s Certificate of Compliance for all steel and associated hardware identified in the pre-approved plan or approved shop drawing.
- Nondestructive test reports generated by the fabricator for inspection of welds.
- Certificate of Material Origin.

**Note:** The Materials Fabrication Inspector will inspect hardware if it is available at the time of inspection at the point of manufacture or at the jobsite. Hardware not present during Materials Fabrication inspection and delivered to the job site without an approval stamp may be accepted by the project office based on Manufacturer’s Certificate of Compliance with supporting material certifications and Certificate of Material Origin. When high strength bolting materials are received on the job site without Fabrications Inspection Stamp, acceptance shall be by the Manufacturer’s Certificate of Compliance per Section 9-1.4D for each heat number or manufacturing lot. Acceptance shall also be by a “Satisfactory” test report from the State Materials Laboratory, when samples are required, for each consignment lot as defined by *Standard Specifications* Section 9-06.5(3). A separate transmittal and materials certification shall accompany each sample of bolts, nuts, and washers.

- b. **Standards Type I, Ramp Meter & Flashing Beacon** – Acceptance shall be by a Manufacturer’s Certificate of Compliance with supporting Mill Certification in accordance with [Section 9-1.4D](#) and:
  - Approved shop drawings not listed in the Contract Special Provisions.
  - Manufacturer’s Certificate of Compliance for all steel and associated hardware identified in the pre-approval plan or approved shop drawing.
  - Nondestructive test reports generated by the Fabricator for inspection of welds.
  - High strength bolts, nuts, and washers – Acceptance shall be in accordance with Section 9-4.24.
- c. **Standards Type Pedestrian Push Button and Pedestrian Signal** – Visual Acceptance in accordance with [Section 9-1.4C](#) and:
  - Approved shop drawings not listed in Contract General Special Provisions.
4. **Field Inspection** – Field verify per [Section 9-1.5](#).
5. **Specification Requirements** – See *Standard Specifications* Section 9-06.5(3) and 9-29.6. Review contract documents to determine if supplemental specifications apply.
6. **Other Requirements**
  - a. **Materials Fabrication Inspected CMO** – Certification of Materials Origin will be the responsibility of the Materials Fabrication Inspector as defined in Section 9-2.1A.

Materials may be subject to Buy America and/or Build America/Buy America (BABA) requirements when included in the Contract by Special Provision. Refer to [Section 9-1.2E](#).
  - b. **Non-Fabrication Inspected CMO** – Materials may be subject to Buy America and/or Build America/Buy America (BABA) requirements when included in the Contract by Special Provision. Refer to [Section 9-1.2E](#).

#### 9-4.67 Vacant

#### 9-4.68 **Luminaires, Lamps, and Light Emitting Diodes (LED)**

1. **Approval of Material** – In accordance with *Standard Specifications* Section 1-06, approval of materials is required prior to use. Materials will be approved by the Qualified Products List or Request for Approval of Material DOT Form 350-071. Be certain to verify that the product is in fact qualified for its intended use and the product is listed under the appropriate specification.

**RAM Submittal** – Luminaires and Lamps – Attach Catalog Cuts using the Catalog Cut Transmittal DOT Form 350-072 to assist in the approval process.

**LED** – Submit Independent Test Report verifying compliance with the Contract Document requirements along with Catalog Cuts using the Catalog Cut Transmittal DOT Form 350-072 to assist in the approval process.

2. **Preliminary Samples** – Preliminary samples will be required only if coded on the Request for Approval of Material DOT Form 350-071.
3. **Acceptance** – Visual Acceptance per [Section 9-1.4C](#).

4. **Field Inspection** – Field verify per [Section 9-1.5](#).
5. **Specification Requirements** – See *Standard Specifications* Section 9-29.10. Review contract documents to determine if supplemental specifications apply.
6. **Other Requirements** – Materials may be subject to Buy America and/or Build America/Buy America (BABA) requirements when included in the Contract by Special Provision. Refer to [Section 9-1.2E](#).

#### 9-4.69 **Water Distribution System**

1. **Approval of Material** – In accordance with *Standard Specifications* Section 1-06, approval of materials is required prior to use. Materials will be approved by the Qualified Products List or Request for Approval of Material DOT Form 350-071. Be certain to verify that the product is in fact qualified for its intended use and the product is listed under the appropriate specification.  
**RAM Submittal** – Attach Catalog Cuts using the Catalog Cut Transmittal DOT Form 350-072 to assist in the approval process.
2. **Preliminary Samples** – A preliminary sample of the material will be required only if coded on the Request for Approval of Material DOT Form 350-071.
3. **Acceptance**
  - a. **QPL Acceptance**
    - i. **Ductile Iron Pipe and Fittings, PVC Pipe and Fittings, Restrained Joints, Restrained Flexible Couplings, Gate Valves (3-in to 16-in), Butterfly Valves, Saddles, Corporation Stops** – Visual Acceptance per [Section 9-1.4C](#).
    - ii. **Copper Tubing and Polyethylene Tubing** – Manufacturer’s Certificate of Compliance per [Section 9-1.4D](#).
  - b. **Non-QPL Acceptance**
    - i. **Ductile Iron Pipe, Steel Pipe, Polyvinyl Chloride (PVC) Pipe, Polyethylene (PE) Pressure Pipe, Polyethylene Encasement** – Manufacturer’s Certificate of Compliance per [Section 9-1.4D](#).
    - ii. **Fittings for Ductile Iron, Steel, PVC, and PE Pipe. Restrained Joints, Bolted Sleeve-type Couplings for Plain End Pipe, Restrained Flexible Couplings, Grooved and Shoulder Joints, Fabricated Mechanical Slip-type Expansion Joints, Gate Valves (3-in to 16-in), Butterfly Valves, Valve Stem Extensions, Combination Air Release/Vacuum Valves, Tapping Sleeve and Valve Assemblies, Hydrants, End Connections, Hydrant Extensions, Hydrant Restraints, Traffic Flanges, Saddles, Corporation Stops, Copper Tubing, Polyethylene Tubing, Service Fittings, Meter Setters, Bronze Nipples and Fittings, and Meter Boxes** – Catalog Cut per Section 9-1.4G.
    - iii. **Valve Boxes, Valve Marker Posts, and Guard Posts** – Visual Acceptance per [Section 9-1.4C](#).
4. **Field Inspection** – Field verify per [Section 9-1.5](#).
5. **Specification Requirements** – See *Standard Specifications* Section 9-30. Review contract documents to determine if supplemental specifications apply.



## 6. Other Requirements

- a. Water distribution pipe requires testing after installation in conformance with the *Standard Specifications* Section 7-09.
- b. Materials may be subject to Buy America and/or Build America/Buy America (BABA) requirements when included in the Contract by Special Provision. Refer to [Section 9-1.2E](#).

### 9-4.70 **Elastomeric Pads**

1. **Approval of Material** – In accordance with Section 1-06 of the *Standard Specifications*, approval of materials is required prior to use. Materials will be approved by the Qualified Products List or Request for Approval of Material DOT Form 350-071. Be certain to verify that the product is in fact qualified for its intended use and the product is listed under the appropriate specification.

RAM Submittal

- a. **Load Bearing** – Submit Manufacturer’s Certificate of Compliance and supporting tests in accordance with *Standard Specifications* Section 1-06.3, demonstrating compliance with *Standard Specifications* Section 9-31.
  - b. **Non-Load Bearing; Girder Stop Pads and Seismic Restrainer Pads** – Attach Catalog Cut using Transmittal of Catalog Cut DOT Form 350-072 to assist in the approval process. The Project Engineer can approve the Request for Approval of Material (RAM).
2. **Preliminary Samples** – A preliminary sample of the material will be required only if coded on the Request for Approval of Material DOT Form 350-071.
  3. **Acceptance**
    - a. **Load Bearing** – Acceptance shall be by a Manufacturer’s Certificate of Compliance per [Section 9-1.4D](#) accompanied by a test report identifying the specific batch of material and demonstrating conformance to *Standard Specifications* Section 9-31.
    - b. **Non-Load Bearing; Girder Stop Pads and Seismic Restrainer Pads** – Visual acceptance per [Section 9-1.4C](#) or this manual.
  4. **Field Inspection** - Field verify per Section 9-1.5.
  5. **Specification Requirements** – See *Standard Specifications* Section 9-31. Review contract documents to determine if supplemental specifications apply.
  6. **Other Requirements** – Materials may be subject to Buy America and/or Build America/Buy America (BABA) requirements when included in the Contract by Special Provision. Refer to [Section 9-1.2E](#).

### 9-4.71 **Bridge Bearings – Cylindrical, Disc, Fabric Pad, Pin, Spherical**

1. **Approval of Material** – Approval of the Fabricator is required prior to the start of fabrication. The Fabricator will be approved by the Qualified Products List or Request for Approval of Material DOT Form 350-071. Be certain to verify that the product is in fact qualified for its intended use and the product is listed under the appropriate specification. Materials used within the fabricated item do not require approval through the Project Engineer office. Provide the WSDOT Materials Fabrication Inspection Office with a copy of the Qualified Products Page or Request for Approval

of Material listing the Fabricator. Review of the Contract Special Provisions is necessary to determine if special qualifications or testing is required for approval of the fabricator.

2. **Preliminary Samples** – A preliminary sample of the material will be required only if coded on the Request for Approval of Material DOT Form 350-071.
3. **Acceptance** – As determined by the WSDOT Materials Fabrication Inspection Office, Bridge Bearings may be inspected at the point of manufacture prior to shipping or at the jobsite by the Materials Fabrication Inspector. Contract Provision may provide for job site inspection of the Bridge Bearings by the engineer. Acceptance is based on “APPROVED FOR SHIPMENT” Stamp and/or Tag (Figure 9-4 or 9-5). An “F” or “D” will be stamped to indicate the steel or iron is of foreign or domestic origin.

Bridge Bearings delivered to the job site without “APPROVED FOR SHIPMENT” stamps and/or tags require Materials Fabrication Inspection. Contact the WSDOT Materials Fabrication Inspection Office for inspection and required documentation needed prior to their physical inspection of the Bridge Bearing.

4. **Field Inspection** – Field verify per Section 9-1.5.
5. **Specification Requirements** – Bearings specifications are currently defined in General Special Provisions and Bridge Special Provisions. Review the contract documents to determine the specification requirements.
6. **Other Requirements** – Certification of Material Origin will be the responsibility of the Materials Fabrication Inspector as defined in Section 9-2.1A.

Materials may be subject to Buy America and/or Build America/Buy America (BABA) requirements when included in the Contract by Special Provision. Refer to Section 9-1.2E.

#### 9-4.72 Precast Concrete Barrier

1. **Approval of Material** – In accordance with *Standard Specifications* Section 1-06, approval of the Fabricator and materials is required prior to the start of fabrication. The Fabricator will be approved by the Qualified Products List or Request for Approval of Material DOT Form 350-071. Be certain to verify that the product is in fact qualified for its intended use and the product is listed under the appropriate specification. Materials used within the fabricated item do not require approval through the Project Engineer office. Provide the WSDOT Materials Fabrication Inspection Office with a copy of the Qualified Products Page or Request for Approval of Material listing the Fabricator. Review of the Contract Special Provisions is necessary to determine if special qualifications or testing is required for approval of the fabricator.
2. **Preliminary Samples** – A preliminary sample of the material will be required only if coded on the Request for Approval of Material DOT Form 350-071.
3. **Acceptance**
  - a. **Concrete Barrier** – Acceptance is based on “WSDOT INSPECTED” Stamp (Figure 9-3). An “F” or “D” will be stamped to indicate the steel or iron is of foreign or domestic origin.



5. **Specification Requirements** – See *Standard Specifications* Section 6-06.3(2) and 9-06.18. Review contract documents to determine if supplemental specifications apply.
6. **Other Requirements** – Certification of Material Origin will be the responsibility of the Materials Fabrication Inspector as defined in Section 9-2.1A.

Materials may be subject to Buy America and/or Build America/Buy America (BABA) requirements when included in the Contract by Special Provision. Refer to [Section 9-1.2E](#).

#### 9-4.75 **Construction Geosynthetics (Geotextiles and Geogrids)**

1. **Approval of Material** – In accordance with *Standard Specifications* Section 1-06 approval of materials is required prior to use. Materials will be approved by the Qualified Products List or Request for Approval of Material DOT Form 350-071. Be certain to verify that the product is in fact qualified for its intended use and the product is listed under the appropriate specification.  
RAM Submittal
  - a. **Underground Drainage, Separation, Soil Stabilization, Permanent Erosion Control, Ditch Lining, Prefabricated Drainage Mat, and Permanent Geosynthetic Retaining Walls, Reinforced Slopes, Reinforced Embankments, and other Geosynthetic Reinforcement Applications** – Refer to *Standard Specifications* Section 9-33.4(1) for submittal requirements.
  - b. **Temporary Geosynthetics (Geotextile and Geogrid) Applications** – Approval of material is not required.
2. **Preliminary Samples** – A preliminary sample of the material will be required only if coded on the Request for Approval of Material DOT Form 350-071.
3. **Acceptance**
  - a. **Underground Drainage**
    - i. **Less than 100 SY** – Acceptance shall be by the Manufacturer’s Certificate of Compliance per [Section 9-1.4D](#).
    - ii. **100 SY and greater** – Materials shall be accepted on receipt of “Satisfactory” test reports from the State Materials Laboratory.
  - b. **Geosynthetic Reinforcement in Permanent Geosynthetic Retaining Walls, Reinforced Slopes, Reinforced Embankments, and other Geosynthetic Reinforcement Applications** – Materials shall be accepted on receipt of “Satisfactory” test reports from the State Materials Laboratory.
  - c. **Separation, Soil Stabilization, Permanent Erosion Control, Ditch Lining, and Prefabricated Drainage Mat** – Acceptance shall be by the Manufacturer’s Certificate of Compliance per [Section 9-1.4D](#).
  - d. **Temporary Erosion Control Materials** – Visual Acceptance per [Section 9-1.4C](#).
4. **Field Inspection** – Field verify per [Section 9-1.5](#).

5. **Specification Requirements** – See *Standard Specifications* Section 9-33. Review contract documents to determine if supplemental specifications apply.
6. **Other Requirements** – If seams are sewn in the field, refer to *Standard Specifications* Section 9-33.4(5) for sampling and testing requirements.

Materials may be subject to Buy America and/or Build America/Buy America (BABA) requirements when included in the Contract by Special Provision. Refer to [Section 9-1.2E](#).

#### 9-4.76 Concrete

1. **Approval of Material** – In accordance with *Standard Specifications* Section 1-06, approval of all materials is required prior to use. Materials will be approved by the Qualified Products List or Request for Approval of Material DOT Form 350-071. Be certain to verify that the product is in fact qualified for its intended use and the product is listed under the appropriate specification.

Cement – See [Section 9-4.1](#).

Concrete Aggregate – See [Section 9-4.4](#).

Admixtures for Concrete – See [Section 9-4.58](#).

Water – See [Section 9-4.77](#).

Submittal and approval of the Concrete Mix Design shall be per *Standard Specifications* Section 6-02.3(2) and 9-03.1(1) and Section 6-2.1A. Contractor must submit a concrete mix design on DOT Form 350-040. All concrete must come from a National Ready Mix Concrete Association (NRMCA) certified Batch Plant.

For mix designs proposed for cement concrete pavement the contractor is required to submit flexural and compressive strength test results in accordance with *Standard Specifications* Section 5-05 as part of the concrete mix design.

**Note:** If the Aggregate Source Approval (ASA) database Tracking System requires Alkali Silica Reactivity (ASR) mitigation, the concrete mix design submittal may include the use of either a low alkali cement (per *Standard Specifications* Section 9-01.3(3)) or fly ash (*Standard Specifications* Section 9-23.9) as approved by the engineer. The contractor shall provide test results for ASTM C 1567 showing the mitigating measures are effective (see *Standard Specifications* Section 9-03). Contact the State Materials Engineer if the contractor is proposing to use other mitigating measures.

2. **Preliminary Samples** – Not required.
3. **Acceptance**
  - a. **Prepackaged Concrete** – Visual Acceptance per [Section 9-1.4C](#) that all bags are labeled meeting the requirements of ASTM C387.
  - b. **Controlled Density Fill (CDF)** – Check Concrete Delivery Ticket and/or Electronic Ticket to verify the mix provided is in accordance with the approved Mix Design.
  - c. **Commercial and Lean Concrete** – Is accepted based on a Certificate of Compliance to be provided by the supplier as described in *Standard Specifications* Section 6-02.3(5)B.

- d. **Cement Concrete Pavement** – Compressive Strength shall be accepted on receipt of “Satisfactory” test reports. Acceptance samples shall be obtained, tested, and recorded in accordance with the contract documents, and [Section 9-3](#) and [9-7](#). Air Content will be tested at the time of placement and documented on the Concrete Delivery Ticket and/or Electronic Ticket per [Section 10-2](#). Acceptance samples shall be obtained, tested, and recorded in accordance with the contract documents, and this chapter.
  - e. **Structural Concrete** – Compressive Strength shall be accepted on receipt of “Satisfactory” test reports. Acceptance samples shall be obtained, tested, and recorded in accordance with the contract documents, and [Section 9-3](#) and [9-7](#). Slump, Air Content and Temperature will be tested at the time of placement and documented on the Concrete Delivery Ticket and/or Electronic Ticket per [Section 10-2](#). Acceptance samples shall be obtained, tested, and recorded in accordance with the contract documents, and this chapter.
4. **Field Inspection** – Field verify per [Section 9-1.5](#).
  5. **Specification Requirements** – See *Standard Specifications* Section 2-09.3(1)E, 9-03.1, 5-05, and 6-02.
  6. **Other Requirements** – None.

#### 9-4.77 Water for Concrete

1. **Approval of Material** – Not required.
2. **Preliminary Samples** – Not required.
3. **Acceptance** – Acceptance is based on test results provided by the contractor. If the Contractor is using potable water that is clear and apparently clean, then no testing is required.
  - a. **Physical Requirements** – Testing will be conducted on a weekly interval for the first four weeks and thereafter on monthly interval.
  - b. **Chemical Requirements** – Testing will be conducted on a monthly interval.
4. **Field Inspection** – Field verify per [Section 9-1.5](#).
5. **Specification Requirements** – See *Standard Specifications* Section 9-25.1.
6. **Other Requirements** – None.

#### 9-4.78 Expansion Joints

1. **Approval of Material** – Approval of the Fabricator is required prior to the start of fabrication. The Fabricator will be approved by the Qualified Products List or Request for Approval of Material DOT Form 350-071. Be certain to verify that the product is in fact qualified for its intended use and the product is listed under the appropriate specification. Provide the WSDOT Materials Fabrication Inspection Office with a copy of the Qualified Products Page or Request for Approval of Material listing the Fabricator. Review of the Contract Special Provisions is necessary to determine if special qualifications or testing is required for approval of the fabricator.

The Project Engineer is responsible for obtaining the approval of materials prior to use. Materials will be approved by the Qualified Products List or Request for Approval of Material DOT Form 350-071. Be certain to verify that the product is in fact qualified for its intended use and the product is listed under the appropriate specification.

2. **Preliminary Samples** – A preliminary sample of the material will be required only if coded on the Request for Approval of Material DOT Form 350-071.
3. **Acceptance** – The Project Engineer shall collect, review and approve all of the documentation from the Fabricator for the various material items used in Manufacturing the expansion joints as listed below.
  - a. **Gland Strip** – Acceptance shall be by the Manufacturer’s Certificate of Compliance per [Section 9-1.4D](#).
  - b. **Steel Plates and Shapes** – Acceptance shall be by the Manufacturer’s Certificate of Compliance per [Section 9-1.4D](#).
  - c. **Coatings for Steel Parts** – Acceptance shall be by the Manufacturer’s Certificate of Compliance per [Section 9-1.4D](#).

The Materials Fabrications Inspection Office will inspect the workmanship of the Expansion Joint at the jobsite. Acceptance for the expansion joints is based on a “WSDOT INSPECTED” ([Figure 9-3](#)) Stamp.

4. **Field Inspection** – Field verify per [Section 9-1.5](#).
5. **Specification Requirements** – Review contract documents to determine specification requirements.
6. **Other Requirements** – Materials may be subject to Buy America and/or Build America/Buy America (BABA) requirements when included in the Contract by Special Provision. Refer to [Section 9-1.2E](#).

#### 9-4.79 **Traffic Signal Controller Assembly**

##### 1. **Approval of Material**

**Signal Controller Assembly** – Approval of the Signal Controller Assembly Fabricator is required prior to the start of fabrication. The Fabricator will be approved by the Qualified Products List or Request for Approval of Material DOT Form 350-071. Be certain to verify that the product is in fact qualified for its intended use and the product is listed under the appropriate specification. Review of the Contract Special Provisions is necessary to determine if special qualifications or testing is required for approval of the fabricator.

**Signal Controller Assembly “Pluggable” Components** – The Project Engineer is responsible for obtaining the approval of traffic signal control equipment prior to use. Materials will be approved by the Qualified Products List or Request for Approval of Material DOT Form 350-071. Be certain to verify that the product is in fact qualified for its intended use and the product is listed under the appropriate specification.

**RAM Submittal** – Attach Catalog Cuts for components using the Catalog Cut Transmittal DOT Form 350-072 and fully dimensioned Shop Drawings to assist in the approval process.

2. **Preliminary Samples** – A preliminary sample of the individual components will be required only if coded on the Request for Approval of Material DOT Form 350-071.
3. **Acceptance**
  - a. **Traffic Signal Controllers** – Shall be accepted on receipt of “Satisfactory” test reports. A “Satisfactory” test report is defined as acceptable performance in the following tests:
    - WSDOT Test Method 421, Traffic Controller Inspection and Test Procedure
    - WSDOT Test Method 422, Transient Voltage Test (Spike Test) Procedure (Optional)
    - WSDOT Test Method 423, Conflict Monitor Testing
    - WSDOT Test Method 424, Power Interruption Test Procedure (Only for Type 170 and NEMA Controllers)
    - WSDOT Test Method 425, Environmental Chamber Test
    - WSDOT SOP 429, Method for Determining the Acceptability of Traffic Signal Controller Assembly
    - WSDOT Test Method T 427, Loop Amplifier Test (Optional)
    - WSDOT Test Method T 428, Compliance Inspection and Test Procedure
  - b. **Signal Controller Assembly “Pluggable” Components** – Visual Acceptance per [Section 9-1.4C](#). Document functionality of the “pluggable” component at the start up by the Region Traffic Signal Inspector.
4. **Field Inspection** – Field verify per [Section 9-1.5](#).
5. **Specification Requirements** – See *Standard Specifications* Section 9-29.13. Review contract documents to determine if supplemental specifications apply.
6. **Other Requirements** – Materials may be subject to Buy America and/or Build America/Buy America (BABA) requirements when included in the Contract by Special Provision. Refer to [Section 9-1.2E](#).

#### 9-4.80 Erosion Control Devices

1. **Approval of Material** – In accordance with *Standard Specifications* Section 1-06, approval of materials is required prior to use. Materials will be approved by the Qualified Products List or Request for Approval of Material DOT Form 350-071. Be certain to verify that the product is in fact qualified for its intended use and the product is listed under the appropriate specification.

**RAM Submittal** – The Project Engineer can approve the Request for Approval of Material (RAM). The Regional Landscape Architect or HQ Design Landscape Architect can assist the Project Engineer in these evaluations.

- a. **Polyacrylamide (Pam), Coir Log Including Wood Stakes and Rope Ties, Clear Plastic Covering, and High Visibility Fencing** – Attached Catalog Cuts using Catalog Cut Transmittal DOT Form 350-072 to assist the approval process.
- b. **Erosion Control Blanket** – Submit the following:
  - Independent test results from the National Transportation Product Evaluation Program (NTPEP).
  - If netting is present, attach Catalog Cut using the Catalog Cut Transmittal DOT Form 350-072) to assist the approval process.



- c. **Check Dams**
    - **Biodegradable Check Dams** – Submit the following:
      - Refer to the RAM submittal requirements for Wattles, Compost Socks, and Coir Logs
    - **Non-biodegradable Check Dams** – Submit the following:
      - Geosynthetic material, submit Manufacturer's Certificate of Compliance
      - Attach Catalog Cuts using Catalog Cut Transmittal DOT Form 350-072 to assist the approval process.
  - d. **Wattles and Compost Socks** – Submit the following:
    - Attach Catalog Cuts using Catalog Cut Transmittal DOT Form 350-072 to assist the approval process.
    - **Compost Fill Material** – See the RAM transmittal requirements for compost in [Section 9-4.48](#).
2. **Preliminary Samples** – A preliminary sample of the material will be required only if coded on the Request for Approval of Material DOT Form 350-071.
  3. **Acceptance** – Acceptance for all erosion control devices shall be by Visual Acceptance per [Section 9-1.4C](#).
  4. **Field Inspection** – Field verify per [Section 9-1.5](#).
  5. **Specification Requirements** – See *Standard Specifications* Section 8-01, 9-14, and 9-33.
  6. **Other Requirements** – If there is a question on the intended use of erosion control devices, contact the Statewide Erosion Control Program Lead at 360-570-6654.  
  
Materials may be subject to Buy America and/or Build America/Buy America (BABA) requirements when included in the Contract by Special Provision. Refer to [Section 9-1.2E](#).

#### **9-4.81 Concrete Patching Material, Grout and Mortar**

1. **Approval of Material** – In accordance with *Standard Specifications* Section 1-06, approval of materials is required prior to use. Materials will be approved by the Qualified Products List or Request for Approval of Material DOT Form 350-071. Be certain to verify that the product is in fact qualified for its intended use and the product is listed under the appropriate specification.  
  
**RAM Submittal** – If the product is not listed on the QPL, submit test data from an accredited independent laboratory confirming that the concrete patching material, grout or mortar meets *Standard Specifications* Section 9-20.
2. **Preliminary Samples** – A preliminary sample of the material will be required only if coded on the Request for Approval of Material DOT Form 350-071.
3. **Acceptance**
  - a. **Concrete Patching Materials** – Concrete Patching materials shall be accepted on receipt of “Satisfactory” tests report for air content and compressive strength performed once per shift. The Contractor must submit a mix design meeting the requirements of *Standard Specifications* Section 9-20 for the concrete patching material.

- b. **Grout**
- i. **Grout Type 1** – Materials shall be accepted by Visual Acceptance per [Section 9-1.4C](#).
  - ii. **Grout Type 2** – Materials shall be accepted by receipt of “Satisfactory” test report for compressive strength, testing to be performed once per bridge pier or 1 per shift. Acceptance samples shall be obtained, tested, and recorded in accordance with the contract documents and [Section 9-3](#) and [9-7](#).
  - iii. **Grout Type 3** – Materials shall be accepted by receipt of “Satisfactory” test report for compressive strength. Testing to be performed once per bridge pier or 1 per shift, and shall be by the Manufacturer’s Certificate of Compliance per [Section 9-1.4D](#) to verify conformance to AASHTO T 22 (ASTM C39), or AASHTO T 106 (ASTM C109), ASTM C1583 or ASTM C882 and ASASHTO T 160 (ASTM C157) requirements. Acceptance samples shall be obtained, tested, and recorded in accordance with the contract documents and [Section 9-3](#) and [9-7](#).
  - iv. **Grout Type 4**
    - **Structural Applications** – Materials shall be accepted by receipt of “Satisfactory” test report for compressive strength, testing to be performed once per bridge pier or 1 per shift, and shall be by Visual Acceptance per [Section 9-1.4C](#). Acceptance samples shall be obtained, tested, and recorded in accordance with the contract documents and [Section 9-3](#) and [9-7](#).
    - **Soils Nails and Ground Anchors** – Acceptance shall be by Visual Acceptance per [Section 9-1.4C](#).
    - **Nonstructural Applications** – Acceptance for column jacket pour back or bridge or retaining wall shaft CSL access tube pour back will be by Visual Acceptance per [Section 9-1.4C](#).
- c. **Mortar**
- i. **Mortar Type 1 for Finishing Applications** – Visual Acceptance per [Section 9-1.4C](#) and will require confirmation of *Standard Specifications* blending ratio.
  - ii. **Mortar Type 2 for Masonry Applications** – Visual Acceptance per [Section 9-1.4C](#) and will require confirmation of *Standard Specifications* blending ratio.
  - iii. **Mortar Type 3** – Shall be accepted on receipt of “Satisfactory” test report for compressive strength, testing to be performed once per day. Acceptance samples shall be obtained, tested, and recorded in accordance with the contract documents, and [Section 9-3](#) and [9-7](#).
- d. **Aggregate Extender for Concrete Patching Material** – Materials shall be accepted on receipt of “Satisfactory” test reports meeting the requirements of *Standard Specifications* Section 9-20.1.
- e. **Aggregate Extender for Grout Type 3** – Materials shall be accepted by a Certificate of Compliance stating that the aggregate being used meets the Specifications and recommendations and will be mixed and placed in accordance with the grout manufacturer’s requirements.

4. **Field Inspection** – Field verify per [Section 9-1.5](#).
5. **Specification Requirements** – See *Standard Specifications* Section 9-20. Review contract documents to determine if supplemental specifications apply.
6. **Other Requirements** – Grouts extended with coarse aggregate will require 4" × 8" test specimens per WSDOT FOP for AASHTO R 100. Grouts extended with fine aggregate will require test specimens per WSDOT TM 813.

#### 9-4.82 Streambed Aggregates

1. **Approval of Material** – In accordance with *Standard Specifications* Section 1-06, approval of materials is required prior to use. Consult the Aggregate Source Approval (ASA) database for approval status of the material for each source. If the ASA database indicated that the aggregate source has expired, or will expire before the end of the project, a source evaluation may be required. Contact the Region materials office for further direction. If samples are required, the Region materials office will coordinate with the Materials Quality Assurance Section QPL/ASA engineer to obtain the necessary samples according to SOP 128.
2. **Preliminary Samples** – A preliminary sample of the material will be required only if coded on the Request for Approval of Material DOT Form 350-071.
3. **Acceptance**
  - a. **Streambed Sediment** – Acceptance shall be administered in accordance with *Standard Specifications* Section 3-04. Acceptance samples shall be obtained, tested, and recorded in accordance with the contract documents, and [Section 9-3](#) and [9-7](#).
  - b. **Streambed Cobbles, Streambed Boulders and Habitat Boulders** – Visual Acceptance per [Section 9-1.4C](#). Approximate size can be determined per *Standard Specifications* Section 9-03.11.
4. **Field Inspection** – Field verify per [Section 9-1.5](#).
5. **Specification Requirements** – See *Standard Specifications* Sections 3-02, 3-04, and 9-03.11. Review contract documents to determine if supplemental specifications apply.
6. **Other Requirements** – Streambed aggregates shall be naturally occurring water rounded aggregates. Aggregates from quarries, ledge rock, and talus slopes are not permitted.

Refer to *Standard Specifications* Section 9-03.11 to see if recycled materials are permitted.

#### 9-4.83 Temporary Traffic Control Materials

1. **Approval of Materials and Systems** – In accordance with *Standard Specifications* Section 1-06, approval of materials prior to use is required for:
  - a. **Transportable Attenuators** – Materials will be approved by the Qualified Products List or Request for Approval of Material DOT Form 350-071. Be certain to verify that the product is in fact qualified for its intended use and the product is listed under the appropriate specification.

**RAM Submittal** – The contractor shall provide certification that the unit complies with NCHRP 350 Test Level 3 requirements or the comparable requirement from the AASHTO Manual for Assessing Safety Hardware (MASH) Test Level 3 per Section 1-10.2(3).

- b. **Portable Temporary Traffic Control Signal** – Material will be approved per *Standard Specifications* Section 1-10.3(3)K.
- c. **Pavement Markings** – Refer to Section 9-4.55.

Prior approval is not required for:

- Barricades
- Construction Signs
- Portable Changeable Message Signs
- Sequential Arrow Signs
- Sign Covering
- Stop/Slow Paddles
- Tall Channelizing Devices
- Traffic Cones
- Traffic Safety Drums
- Tubular Markers
- Warning Lights and Flashers
- Wood Sign Posts

2. **Preliminary Samples** – No preliminary sample required.

3. **Acceptance**

- a. **Stop/Slow Paddles, Wood Sign Supports, Sign Covering** – Visual Acceptance per [Section 9-1.4C](#) to ensure good condition and conformance to the appropriate *Standard Specifications*.
- b. **Construction Signs, Sequential Arrow Signs, Portable Changeable Message Signs, Barricades, Traffic Safety Drums, Traffic Cones, Tubular Markers, Warning Lights and Flashers, Tall Channelizing Devices** – Visual Acceptance per [Section 9-1.4C](#) to ensure the signs and traffic control devices are acceptable or marginal as defined in Quality Guidelines for Temporary Traffic Control Device and conform to the appropriate *Standard Specifications*.
- c. **Portable Temporary Traffic Control Signal** – Visual Acceptance per [Section 9-1.4C](#). All Portable Temporary Traffic Control Signals must be accepted prior to use. Inspect all Portable Temporary Traffic Control Signals to ensure good condition, functionality and conformance to the appropriate *Standard Specifications*.
- d. **Transportable Attenuator (TMA)** – Visual Acceptance per [Section 9-1.4C](#) and inspected for condition, reflectivity and conformance to the appropriate *Standard Specifications*. No sampling or testing will be done except that deemed necessary to support the visual inspection.

4. **Field Inspection** – Field verify per [Section 9-1.5](#).

5. **Specification Requirements** – See *Standard Specifications* Sections 1-10, 8-21.3(3), and 9-35. Review contract documents to determine if supplemental specifications apply.

6. **Other Requirements** – Materials may be subject to Buy America and/or Build America/Buy America (BABA) requirements when included in the Contract by Special Provision. Refer to [Section 9-1.2E](#).

#### 9-4.84 **Modular Expansion Joint**

1. **Approval of Material** – Approval of the Fabricator is required prior to the start of fabrication. The Fabricator will be approved by the Qualified Products List or Request for Approval of Material DOT Form 350-071. Be certain to verify that the product is in fact qualified for its intended use and the product is listed under the appropriate specification. Materials used within the fabricated item do not require approval through the Project Engineer office. Provide the WSDOT Materials Fabrication Inspection Office with a copy of the Qualified Products Page or Request for Approval of Material listing the Fabricator. Review of the Contract Special Provisions is necessary to determine if special qualifications or testing is required for approval of the fabricator.
2. **Preliminary Samples** – Preliminary samples of the material will be required by the contract provisions or if coded on the Request for Approval of Material DOT Form 350-071).
3. **Acceptance** – As determined by the WSDOT Materials Fabrication Inspection Office, Modular Expansion Joints may be inspected at the point of manufacture prior to shipping or at the jobsite by the Materials Fabrication Inspector. Contract Provision may provide for job site inspection of the Modular Expansion Joints by the engineer. Acceptance is based on “APPROVED FOR SHIPMENT” Stamp and/or Tag ([Figure 9-4](#) or [9-5](#)). An “F” or “D” will be stamped to indicate the steel or iron is of foreign or domestic origin.

Modular Expansion Joints delivered to the job site without “APPROVED FOR SHIPMENT” stamps and/or tags require Materials Fabrication Inspection. Contact the WSDOT Materials Fabrication Inspection Office for inspection and required documentation needed prior to their physical inspection of the Modular Expansion Joints.

4. **Field Inspection** – Field verify per [Section 9-1.5](#).
5. **Specification Requirements** – Modular Expansion Joints specifications are currently specified in General Special Provisions. Review the contract documents to determine the specification requirements.
6. **Other Requirements** – Certification of Material Origin will be the responsibility of the Materials Fabrication Inspector as defined in Section 9-2.1A.

Materials may be subject to Buy America and/or Build America/Buy America (BABA) requirements when included in the Contract by Special Provision. Refer to [Section 9-1.2E](#).

#### 9-4.85 **Junction Boxes, Cable Vaults, and Pull Boxes**

1. **Approval of Material**

**Fabrication Inspection items** – In accordance with *Standard Specifications* Section 1-06, approval of the Fabricator is required prior to the start of fabrication. The Fabricator will be approved by the Qualified Products List or Request for Approval of Material DOT Form 350-071. Be certain to verify that the product is in fact qualified for its intended use and the product is listed under the appropriate specification. Materials used within the fabricated item do not require approval through the Project Engineer office. Provide the WSDOT Materials Fabrication Inspection Office with a copy of the Qualified Products Page or Request for Approval of Material listing the

Fabricator. Review of the Contract Special Provisions is necessary to determine if special qualifications or testing is required for approval of the fabricator.

**Note:** Approved design/shop drawings are available online at [www.wsdot.wa.gov/design/traffic/shop\\_drawings.htm](http://www.wsdot.wa.gov/design/traffic/shop_drawings.htm). Online drawings represent fabricators designs that have passed initial proof load testing for design approval. The Online drawings maintained by the WSDOT Traffic Design Office are used to inspect Concrete Junction Boxes, Cable Vaults and Pull Boxes.

**Non-Fabrication Inspection Items** – Approval of the Structure Mounted and Non-Concrete Junction Boxes are required prior to use. The Structure Mounted and Non-Concrete Junction Boxes will be approved by the Qualified Products List or Request for Approval of Material DOT Form 350-071. Be certain to verify that the product is in fact qualified for its intended use and the product is listed under the appropriate specification.

RAM Submittal

- a. **Standard Duty Junction Boxes Types 1,2, and 8** – Submittal and approval of Standard Duty Junction Boxes Types 1, 2, and 8 shall be in accordance with *Standard Specifications* Sections 9-29.2(1), 9-29.2(1)A, 9-29.2(1)A1, and 9-29.2(5).
  - b. **Heavy Duty Junction Boxes Types 4, 5, and 6** – Submittal and approval of Heavy Duty Junction Boxes Types 4, 5, and 6 shall be in accordance with *Standard Specifications* Sections 9-29.2(1), 9-29.2(1)B and 9-29.2(5).
  - c. **Standard Duty Cable Vaults and Pull Boxes** – Submittal and approval of Standard Duty and Heavy Duty Cable Vaults and Pull Boxes shall be in accordance with *Standard Specifications* Sections 9-29.2(2), 9-29.2(2)A, and 9-29.2(5).
  - d. **Heavy Duty Cable Vaults and Pull Boxes** – Submittal and approval of Standard Duty and Heavy Duty Cable Vaults and Pull Boxes shall be in accordance with *Standard Specifications* Sections 9-29.2(2), 9-29.2(2)B, and 9-29.2(5).
  - e. **Structure Mounted Junction Boxes** – Attach Catalog Cuts using the Catalog Cut Transmittal DOT Form 350-072 and/or Shop Drawing to the State Materials Laboratory to assist in the approval process.
  - f. **Non-Concrete Junction Box** – Submittal and approval of Non-Concrete Junction Boxes shall be in accordance with *Standard Specifications* Sections 9-29.2(1), 9-29.2(1)A, 9-29.2(1)A2, and 9-29.2(5)
2. **Preliminary Samples** – A preliminary sample of the material will be required only if coded on the Request for Approval of Material DOT Form 350-071.
  3. **Acceptance**
    - a. **Type 1, 2, and 8 Junction Boxes**
      - **Concrete** – Acceptance is based on “WSDOT INSPECTED” Stamp (Figure 9-3). An “F” or “D” will be stamped to indicate the steel or iron is of foreign or domestic origin.
      - **Non-Concrete** – Visual Acceptance per Section 9-1.4C, verifying that the number stamped on the box and lid are from a current WSDOT Approved drawing located at: [www.wsdot.wa.gov/design/traffic/shop\\_drawings.htm](http://www.wsdot.wa.gov/design/traffic/shop_drawings.htm).

- b. **Type 4, 5, and 6 Junction Boxes** – Acceptance is based on “APPROVED FOR SHIPMENT” Stamp and/or Tag (Figure 9-4 or 9-5). An “F” or “D” will be stamped to indicate the steel or iron is of foreign or domestic origin.
  - c. **Cable Vaults and Pull Boxes** – Acceptance is based on “APPROVED FOR SHIPMENT” Stamp and/or Tag (Figure 9-4 or 9-5). An “F” or “D” will be stamped to indicate the steel or iron is of foreign or domestic origin.
  - d. **Structure Mounted Junction Boxes** – Visual Acceptance per Section 9-1.4C.
4. **Field Inspection** – Field verify per Section 9-1.5.
  5. **Specification Requirements** – See *Standard Specifications* Section 9-29.2 and Standard Plans sheets J-40.10-02, J-40.20-00, J-40.30-02, and J-40.36-00. Review contract documents to determine if supplemental specifications apply.
  6. **Other Requirements**
    - a. **Materials Fabrication Inspected CMO** – Certification of Materials Origin will be the responsibility of the Materials Fabrication Inspector as defined in Section 9-2.1A.

Materials may be subject to Buy America and/or Build America/Buy America (BABA) requirements when included in the Contract by Special Provision. Refer to Section 9-1.2E.
    - b. **Non-Fabrication Inspected CMO** – Materials may be subject to Buy America and/or Build America/Buy America (BABA) requirements when included in the Contract by Special Provision. Refer to Section 9-1.2E.

**9-4.86 Precast Bridge Deck Panels, Floor Panels, Marine Pier Deck Panels, Noise Barrier Walls, Pier Caps, Retaining Walls, Roof Panels, Structural Earth Walls, Wall Panels, and Wall Stem Panels**

1. **Approval of Material** – Approval of the Fabricator is required prior to the start of fabrication. The Fabricator will be approved by the Qualified Products List or Request for Approval of Material DOT Form 350-071. Be certain to verify that the product is in fact qualified for its intended use and the product is listed under the appropriate specification. Materials used within the fabricated item do not require approval through the Project Engineer office. Provide the WSDOT Materials Fabrication Inspection Office with a copy of the Qualified Products Page or Request for Approval of Material listing the Fabricator. Review of the Contract Special Provisions is necessary to determine if special qualifications or testing is required for approval of the fabricator.
2. **Preliminary Samples** – A preliminary sample of the material will be required only if coded on the Request for Approval of Material DOT Form 350-071.
3. **Acceptance** – Acceptance is based on “APPROVED FOR SHIPMENT” Stamp and/or Tag (Figure 9-4 or 9-5). An “F” or “D” will be stamped to indicate the steel or iron is of foreign or domestic origin.
4. **Field Inspection** – Field verify per Section 9-1.5.
5. **Specification Requirements** – See *Standard Specifications* Section 6-02.3(25), 6-02.3(28), 6-11, 6-12, and 6-13. Review contract documents to determine if supplemental specifications apply.

6. **Other Requirements** – Certification of Material Origin will be the responsibility of the Materials Fabrication Inspector as defined in Section 9-2.1A.

Materials may be subject to Buy America and/or Build America/Buy America (BABA) requirements when included in the Contract by Special Provision. Refer to [Section 9-1.2E](#).

#### 9-4.87 **Concrete Three Sided Structures, Box Culverts and Split Box Culverts**

1. **Approval of Material** – Approval of the Fabricator is required prior to the start of fabrication. The Fabricator will be approved by the Qualified Products List or Request for Approval of Material DOT Form 350-071. Be certain to verify that the product is in fact qualified for its intended use and the product is listed under the appropriate specification. Materials used within the fabricated item do not require approval through the Project Engineer office. Provide the WSDOT Materials Fabrication Inspection Office with a copy of the Qualified Products Page or Request for Approval of Material listing the Fabricator. Review of the Contract Special Provisions is necessary to determine if special qualifications or testing is required for approval of the fabricator.
2. **Preliminary Samples** – A preliminary sample of the material will be required only if coded on the Request for Approval of Material DOT Form 350-071.
3. **Acceptance** – Acceptance is based on “APPROVED FOR SHIPMENT” Stamp and/or Tag ([Figure 9-4](#) or [9-5](#)). An “F” or “D” will be stamped to indicate the steel or iron is of foreign or domestic origin.
4. **Field Inspection** – Field verify per [Section 9-1.5](#).
5. **Specification Requirements** – Review the contract documents to determine the specification requirements.
6. **Other Requirements** – Certification of Material Origin will be the responsibility of the Materials Fabrication Inspector as defined in Section 9-2.1A.

Materials may be subject to Buy America and/or Build America/Buy America (BABA) requirements when included in the Contract by Special Provision. Refer to [Section 9-1.2E](#).

#### 9-4.88 **Precast Concrete Vaults (Utility, Drainage, etc.)**

1. **Approval of Material** – Approval of the Fabricator is required prior to the start of fabrication. The Fabricator will be approved by the Qualified Products List or Request for Approval of Material DOT Form 350-071. Be certain to verify that the product is in fact qualified for its intended use and the product is listed under the appropriate specification. Materials used within the fabricated item do not require approval through the Project Engineer office. Provide the WSDOT Materials Fabrication Inspection Office with a copy of the Qualified Products Page or Request for Approval of Material listing the Fabricator. Review of the Contract Special Provisions is necessary to determine if special qualifications or testing is required for approval of the fabricator.
2. **Preliminary Samples** – A preliminary sample of the material will be required only if coded on the Request for Approval of Material DOT Form 350-071.



3. **Acceptance** – Acceptance is based on “APPROVED FOR SHIPMENT” Stamp and/or Tag (Figure 9-4 or 9-5). An “F” or “D” will be stamped to indicate the steel or iron is of foreign or domestic origin.
4. **Field Inspection** – Field verify per Section 9-1.5.
5. **Specification Requirements** – Review the contract documents to determine the specification requirements.
6. **Other Requirements** – Certification of Material Origin will be the responsibility of the Materials Fabrication Inspector as defined in Section 9-2.1A.

Materials may be subject to Buy America and/or Build America/Buy America (BABA) requirements when included in the Contract by Special Provision. Refer to Section 9-1.2E.

#### **9-4.89 Fabricated/Welded Miscellaneous Metal Drainage Items: Grate Inlets and Drop Inlets**

1. **Approval of Material** – Approval of the Fabricator is required prior to the start of fabrication. The Fabricator will be approved by the Qualified Products List or Request for Approval of Material DOT Form 350-071. Be certain to verify that the product is in fact qualified for its intended use and the product is listed under the appropriate specification. Materials used within the fabricated item do not require approval through the Project Engineer office. Provide the WSDOT Materials Fabrication Inspection Office with a copy of the Qualified Products Page or Request for Approval of Material listing the Fabricator. Review of the Contract Special Provisions is necessary to determine if special qualifications or testing is required for approval of the fabricator.
2. **Preliminary Samples** – A preliminary sample of the material will be required only if coded on the Request for Approval of Material DOT Form 350-071.
3. **Acceptance** – Acceptance is based on “APPROVED FOR SHIPMENT” Stamp and/or Tag (Figure 9-4 or 9-5). An “F” or “D” will be stamped to indicate the steel or iron is of foreign or domestic origin.
4. **Field Inspection** – Field verify per Section 9-1.5.
5. **Specification Requirements** – See *Standard Specifications* Section 9-05.16. Review contract documents to determine if supplemental specifications apply.
6. **Other Requirements** – Certification of Material Origin will be the responsibility of the Materials Fabrication Inspector as defined in Section 9-2.1A.

Materials may be subject to Buy America and/or Build America/Buy America (BABA) requirements when included in the Contract by Special Provision. Refer to Section 9-1.2E.

#### **9-4.90 Miscellaneous Steel Structures (Cattle Guards, Handrail, Guardrail Posts with Welded Base Plate, Seismic Retrofit Earthquake Restrainers, Column Jackets)**

1. **Approval of Material** – Approval of the Fabricator is required prior to the start of fabrication. The Fabricator will be approved by the Qualified Products List or Request for Approval of Material DOT Form 350-071. Be certain to verify that the product is in fact qualified for its intended use and the product is listed under the appropriate

specification. Materials used within the fabricated item do not require approval through the Project Engineer office. Provide the WSDOT Materials Fabrication Inspection Office with a copy of the Qualified Products Page or Request for Approval of Material listing the Fabricator. Review of the Contract Special Provisions is necessary to determine if special qualifications or testing is required for approval of the fabricator.

2. **Preliminary Samples** – A preliminary sample of the material will be required only if coded on the Request for Approval of Material DOT Form 350-071.
3. **Acceptance** – Acceptance is based on “APPROVED FOR SHIPMENT” Stamp and/or Tag ([Figure 9-4](#) or [9-5](#)). An “F” or “D” will be stamped to indicate the steel or iron is of foreign or domestic origin.
4. **Field Inspection** – Field verify per [Section 9-1.5](#).
5. **Specification Requirements** – See *Standard Specifications* Section 6-03. Review contract documents to determine if supplemental specifications apply.
6. **Other Requirements** – Certification of Material Origin will be the responsibility of the Materials Fabrication Inspector as defined in Section 9-2.1A.

Materials may be subject to Buy America and/or Build America/Buy America (BABA) requirements when included in the Contract by Special Provision. Refer to [Section 9-1.2E](#).

#### 9-4.91 **Miscellaneous Welded Structural Steel**

1. **Approval of Material** – Approval of the Fabricator is required prior to the start of fabrication. The Fabricator will be approved by the Qualified Products List or Request for Approval of Material DOT Form 350-071. Be certain to verify that the product is in fact qualified for its intended use and the product is listed under the appropriate specification. Materials used within the fabricated item do not require approval through the Project Office. Provide the WSDOT Materials Fabrication Inspection Office with a copy of the Qualified Products Page or Request for Approval of Material listing the Fabricator. Review of the Contract Special Provisions is necessary to determine if special qualifications or testing is required for approval of the fabricator.
2. **Preliminary Samples** – A preliminary sample of the material will be required only if coded on the Request for Approval of Material DOT Form 350-071.
3. **Acceptance** – Acceptance is based on “APPROVED FOR SHIPMENT” Stamp and/or Tag ([Figure 9-4](#) or [9-5](#)). An “F” or “D” will be stamped to indicate the steel or iron is of foreign or domestic origin.
4. **Field Inspection** – Field verify per [Section 9-1.5](#).
5. **Specification Requirements** – See *Standard Specifications* Section 6-03. Review contract documents to determine if supplemental specifications apply.
6. **Other Requirements** – Certification of Material Origin will be the responsibility of the Materials Fabrication Inspector as defined in Section 9-2.1A.

Materials may be subject to Buy America and/or Build America/Buy America (BABA) requirements when included in the Contract by Special Provision. Refer to [Section 9-1.2E](#).

### 9-4.92 Wood Bridges

1. **Approval of Material** – Approval of the Fabricator is required prior to the start of fabrication. The Fabricator will be approved by the Qualified Products List or Request for Approval of Material DOT Form 350-071. Be certain to verify that the product is in fact qualified for its intended use and the product is listed under the appropriate specification. Materials used within the fabricated item do not require approval through the Project Office. Provide the WSDOT Materials Fabrication Inspection Office with a copy of the Qualified Products Page or Request for Approval of Material listing the Fabricator. Review of the Contract Special Provisions is necessary to determine if special qualifications or testing is required for approval of the fabricator.
2. **Preliminary Samples** – A preliminary sample of the material will be required only if coded on the Request for Approval of Material DOT Form 350-071.
3. **Acceptance** – Acceptance is based on “APPROVED FOR SHIPMENT” Stamp and/or Tag ([Figure 9-4](#) or [9-5](#)). An “F” or “D” will be stamped to indicate the steel or iron is of foreign or domestic origin.
4. **Field Inspection** – Field verify per [Section 9-1.5](#).
5. **Specification Requirements** – Review contract documents to determine the specification requirements.
6. **Other Requirements** – Certification of Material Origin for steel components will be the responsibility of the Materials Fabrication Inspector as defined in [Section 9-2.1A](#).  
Materials may be subject to Buy America and/or Build America/Buy America (BABA) requirements when included in the Contract by Special Provision. Refer to [Section 9-1.2E](#).

### 9-4.93 Electrical Service Cabinets

1. **Approval of Material** – In accordance with *Standard Specifications* Section 1-06, approval of materials is required prior to use. Materials will be approved by the Qualified Products List or Request for Approval of Material DOT Form 350-071. Be certain to verify that the product is in fact qualified for its intended use and the product is listed under the appropriate specification.  
**RAM Submittal** – Attach Catalog Cuts for components using the Catalog Cut Transmittal DOT Form 350-072) and fully dimensioned Shop Drawings to assist in the approval process.
2. **Preliminary Samples** – A preliminary sample of the material will be required only if coded on the Request for Approval of Material DOT Form 350-071.
3. **Acceptance** – Acceptance shall be by a Manufacturer’s Quality Check List included with the cabinet and signed by the Region Electrical Inspector.
4. **Field Inspection** – Field verify per [Section 9-1.5](#).
5. **Specification Requirements** – See *Standard Specifications* Section 9-29.24. Review contract documents to determine if supplemental specifications apply.
6. **Other Requirements** – Materials may be subject to Buy America and/or Build America/Buy America (BABA) requirements when included in the Contract by Special Provision. Refer to [Section 9-1.2E](#).

#### 9-4.94 Monument Case, Cover, and Riser

1. **Approval of Material** – Approval of materials is required prior to use. Materials will be approved by the Qualified Products List or Request for Approval of Material DOT Form 350-071. An on-site inspection of the fabricating facilities prior to approval will be required only if a new manufacture is requested on the Request for Approval of Material DOT Form 350-071. Be certain to verify that the product is in fact qualified for its intended use and the product is listed under the appropriate specification.
2. **Preliminary Samples** – A preliminary sample of the material will be required only if coded on the Request for Approval of Material DOT Form 350-071.
3. **Acceptance** – Acceptance shall be by the Manufacturer's Certificate of Compliance with supporting Mill Certification per [Section 9-1.4D](#).
4. **Field Inspection** – Field verify per [Section 9-1.5](#).
5. **Specification Requirements** – See *Standard Specifications* Section 9-22. Review contract documents to determine if supplemental specifications apply.
6. **Other Requirements** – Materials may be subject to Buy America and/or Build America/Buy America (BABA) requirements when included in the Contract by Special Provision. Refer to [Section 9-1.2E](#).

#### 9-4.95 Steel Bollards

1. **Approval of Material** – Approval of materials is required prior to use. Materials will be approved by the Qualified Products List or Request for Approval of Material DOT Form 350-071. An on-site inspection by the WSDOT Materials Fabrication Office of the fabricating facilities prior to approval will be required only if a new manufacture is requested on the Request for Approval of Material DOT Form 350-071. Be certain to verify that the product is in fact qualified for its intended use and the product is listed under the appropriate specification.
2. **Preliminary Samples** – A preliminary sample of the material will be required only if coded on the Request for Approval of Material DOT Form 350-071.
3. **Acceptance** – Acceptance shall be by the Manufacturer's Certificate of Compliance with supporting Mill Certification per [Section 9-1.4D](#).
4. **Field Inspection** – Field verify per [Section 9-1.5](#).
5. **Specification Requirements** – Review contract documents to determine the specification requirements.
6. **Other Requirements** – Materials may be subject to Buy America and/or Build America/Buy America (BABA) requirements when included in the Contract by Special Provision. Refer to [Section 9-1.2E](#).

#### 9-4.96 Metal Trash Racks, Debris Cages, and Safety Bars for Culvert Pipe and Other Drainage Items

1. **Approval of Material** – In accordance with *Standard Specifications* Section 1-06, approval of materials is required prior to use. Materials will be approved by the Qualified Products List or Request for Approval of Material DOT Form 350-071. An on-site inspection by the WSDOT Materials Fabrication Office of the fabricating facilities prior to approval will be required only if a new manufacture is requested on

the Request for Approval of Material DOT Form 350-071. Be certain to verify that the product is in fact qualified for its intended use and the product is listed under the appropriate specification.

2. **Preliminary Samples** – A preliminary sample of the material will be required only if coded on the Request for Approval of Material DOT Form 350-071.
3. **Acceptance** – Acceptance shall be by the Certificate of Compliance per [Section 9-1.4E](#).
4. **Field Inspection** – Field verify per [Section 9-1.5](#).
5. **Specification Requirements** – See *Standard Specifications* Section 9-05.18. Review contract documents to determine if supplemental specifications apply.
6. **Other Requirements** – Materials may be subject to Buy America and/or Build America/Buy America (BABA) requirements when included in the Contract by Special Provision. Refer to [Section 9-1.2E](#).

#### 9-4.97 **Flow Restrictors and Oil Separators**

1. **Approval of Material** – In accordance with *Standard Specifications* Section 1-06, approval of materials is required prior to use. Materials will be approved by the Qualified Products List or Request for Approval of Material DOT Form 350-071. An on-site inspection by the WSDOT Materials Fabrication Office of the fabricating facilities prior to approval will be required only if a new manufacture is requested on the Request for Approval of Material DOT Form 350-071. Be certain to verify that the product is in fact qualified for its intended use and the product is listed under the appropriate specification.
2. **Preliminary Samples** – A preliminary sample of the material will be required only if coded on the Request for Approval of Material DOT Form 350-071.
3. **Acceptance** – Acceptance shall be by the Certificate of Compliance per [Section 9-1.4E](#).
4. **Field Inspection** – Field verify per [Section 9-1.5](#).
5. **Specification Requirements** – Review contract documents to determine the specification requirements.
6. **Other Requirements** – Materials may be subject to Buy America and/or Build America/Buy America (BABA) requirements when included in the Contract by Special Provision. Refer to [Section 9-1.2E](#).

#### 9-4.98 **Concrete Blocks**

1. **Approval of Material**

**Ecology Blocks** – Approval of materials is not required.

**Masonry Units** – In accordance with *Standard Specifications* Section 1-06, approval of materials is required prior to use. Materials will be approved by the Qualified Products List or Request for Approval of Material DOT Form 350-071. Be certain to verify that the product is in fact qualified for its intended use and the product is listed under the appropriate specification.

**Precast Concrete Block** – In accordance with *Standard Specifications* Section 1-06, approval of materials is required prior to use. Materials will be approved by the Qualified Products List or Request for Approval of Material DOT Form 350-071. An on-site inspection by the WSDOT Materials Fabrication Office of the fabricating facilities prior to approval will be required only if a new manufacture is requested on the Request for Approval of Material DOT Form 350-071. Be certain to verify that the product is in fact qualified for its intended use and the product is listed under the appropriate specification.

2. **Preliminary Samples** – A preliminary sample of the material will be required only if coded on the Request for Approval of Material DOT Form 350-071.
3. **Acceptance**
  - a. **Ecology Block** – Visual Acceptance per [Section 9-1.4C](#).
  - b. **Masonry Units** – Acceptance shall be by the Certificate of Compliance per Section 9-1.4E.
  - c. **Precast Concrete Block** – Acceptance shall be by the Manufacturer’s Certificate of Compliance per [Section 9-1.4D](#). A cylinder test report is required for each lot of blocks delivered to the job site. The freeze/thaw report shall be acceptable for a period of two years from the date the block was manufactured.
4. **Field Inspection** – Field verify per [Section 9-1.5](#).
5. **Specification Requirements** – See *Standard Specifications* Sections 6-13.3(4), 8-24.2, 9-12, and 9-13.5(1). Review contract documents to determine if supplemental specifications apply.
6. **Other Requirements** – Certification of Material Origin will be the responsibility of the Materials Fabrication Inspector as defined in Section 9-2.1A.

Materials may be subject to Buy America and/or Build America/Buy America (BABA) requirements when included in the Contract by Special Provision. Refer to [Section 9-1.2E](#).

#### 9-4.99 Vacant

#### 9-4.100 **Intelligent Transportation Systems (ITS)/System Operations Management (SOM) Materials**

1. **Approval of Material** – In accordance with *Standard Specifications* Section 1-06, approval of materials is required prior to use. Materials will be approved by the Qualified Products Lists or Request of Approval of Material DOT Form 350-071. An on-site inspection by the WSDOT Materials Fabrications Inspection Office of the fabricating facilities prior to approval will be required only if a new manufacturer is requested on the Request for Approval of Material DOT Form 350-071. Be certain to verify that the product is in fact qualified for its intended use and the product is listed under the appropriate specification. The Project Engineer is allowed to approve the Request of Approval of Materials (RAM) for ITS/SOM Non-Standard Materials. For ITS/SOM Standard Materials the Project Engineer is required to follow the approval requirements located in [Table 9-4.100-1](#).

## 2. RAM Submittal

- a. **ITS/SOM Non-Standard Materials** – The Project Engineer can approve the Request for Approval of Materials (RAM) for ITS/SOM non-standard materials used in the following applications:
- Cameras, Closed Circuit Television Systems, and other Surveillance Devices
  - Highway Advisory Radios, Variable and Dynamic Message Signs, and Road/Weather Information Systems
  - ITS Controller Cabinet, Data Station, and Fiber Backbone
  - Electronic Tolling, License Plate Reader and Radar Detectors
  - Weigh-in-Motion Systems and Commercial Vehicle Tag Readers
  - Traffic Data Collectors and Ramp Meters

Material submittal requirements for these materials shall be determine by the requirements of the contract, and/or consultation with either Region Traffic Engineer or the State Materials Laboratory.

- b. **ITS/SOM Standard Materials** – For ITS/SOM Standard Materials, the Project Engineer is required to follow the approval requirements per the referenced sections listed in Table 9-4.100-1:

3. **Preliminary Samples** – A preliminary sample of the material will be required only if coded on the Request for Approval of Material DOT Form 350-071.

## 4. Acceptance

- a. **ITS/SOM Non-Standard Materials** – Acceptance of ITS/SOM materials shall be determined by the requirements of the contract, and/or consultation with either Region Traffic Engineer or the State Materials Laboratory.
- b. **ITS/SOM Standard Materials** – Acceptance requirements for the following standard materials are located in the referenced sections in Table 9-4.100-1.

**Table 9-4.100-1**

Material	Construction Manual Section
Anchor Bolts, Rods, Nuts, and Washers	9-4.25
Concrete	9-4.76
Conduit	9-4.64
Electrical Conductors and Fiber Optic Cable	9-4.65
Electrical Service Cabinets	9-4.93
High Strength Bolts, Nuts, and Washers	9-4.24
Junction Boxes, Cable Vaults, and Pull Boxes	9-4.85
Luminaires, Lamps, and Light Emitting Diodes (LED)	9-4.68
Painting, Paints, Coating, and Related Materials	9-4.35
Precast Concrete Vaults (Utility, Drainage, etc.)	9-4.88
Resin Bonded Anchors	9-4.61
Signing Materials and Mounting Hardware	9-4.56
Steel Poles – ITS, Pedestrian, Light, Signal Standards, and High Mast Light Poles	9-4.66
Steel Sign Structures – Cantilever, Sign Bridge, Bridge Mounted, Roadside	9-4.63
Timber and Lumber	9-4.36
Traffic Signal Controller Assembly	9-4.79

5. **Field Inspection** – Field verify per [Section 9-1.5](#).
6. **Specification Requirements** – See *Standard Specifications* Sections 8-20 and 9-29. Review contract documents to determine if supplemental specifications apply.
7. **Other Requirements** – If there is a question on the intended use of ITS/SOM materials contact the Region Traffic Engineer or the State Materials Laboratory.
  - a. If the Contractor submits an ITS/SOM material that is not specifically identified in the contract provisions, and it has been determine by either the Region Traffic Engineer or the State Materials Laboratory as an approved equal, contact with the State Construction Office is required.
  - b. **Materials Fabrication Inspected CMO** – Certification of Material Origin will be the responsibility of the Materials Fabrication Inspector as defined in Section 9-2.1A. Materials may be subject to Buy America and/or Build America/Buy America (BABA) requirements when included in the Contract by Special Provision. Refer to [Section 9-1.2E](#).
  - c. **Non-Fabrication Inspected CMO** – Materials may be subject to Buy America and/or Build America/Buy America (BABA) requirements when included in the Contract by Special Provision. Refer to [Section 9-1.2E](#).

#### 9-4.101 Media Filter Drain Mix

1. **Approval of Material** – In accordance with *Standard Specifications* Section 1-06, approval of materials is required prior to use. Material will be approved by the Qualified Products List or Request for Approval of Material DOT Form 350-071. Be certain to verify that the product is in fact qualified for its intended use and the product is listed under the appropriate specification. For the aggregate component, if the ASA database indicates the aggregate source has expired, or will expire before the end of the project, a source evaluation may be required, Contact Region Materials office for further direction. If samples are required, the Region Materials office will coordinate with the Materials Quality Assurance Section QPL/ASA engineer to obtain the necessary samples in accordance with SOP 128.
2. **RAM Submittal**
  - a. **Horticultural Grade Perlite, Agricultural Grade Dolomite Lime, and Agricultural Grade Gypsum** – Attach Catalog Cut or supply a bag label showing conformance with the contract documents to assist in approving the RAM.
3. **Preliminary Sample** – A preliminary sample of material will be required only if coded on the Request for Approval of Material DOT Form 350-071.
4. **Acceptance**
  - a. **Aggregate for Media Filter Drain Mix** – Acceptance shall be administered under *Standard Specifications* Section 3-04 for “Other Materials” based on one sample every 1000 tons. Acceptance samples shall be tested for grading and fracture.
  - b. **Horticultural Grade Perlite, Agricultural Grade Dolomite Lime, and Agricultural Grade Gypsum** – Miscellaneous Certificate of Compliance per [Section 9-1.4E](#) or Catalog cuts per Section 9-1.4G.



5. **Field Inspection** – Field verify per [Section 9-1.5](#).
6. **Specification Requirements** – Review contract documents for specification requirements.
7. **Other Requirements** – If there is a question on the intended use of Media Filter Drain Mix, contact Headquarters Hydraulics Office at 360-705-7260.

Materials may be subject to Buy America and/or Build America/Buy America (BABA) requirements when included in the Contract by Special Provision. Refer to [Section 9-1.2E](#).

## 9-5 Quality Assurance Program

### 9-5.1 General

The purpose of the WSDOT Quality Assurance Program (QAP) is to ensure that materials incorporated into any highway construction project are in conformity with the approved plans and specifications, including any approved changes. This program also conforms to the criteria in FHWA regulation for *Quality Assurance Procedures for Construction* (23 CFR 637).

The QAP includes the following:

- WAQTC Testing Technician Qualification Program
- Method Qualified Tester Program
- Equipment Calibration/Standardization/Check and Maintenance Program
- Qualified Laboratory Program
- Independent Assurance (IA) Program

It is the responsibility of the Project Engineer to ensure that all personnel sampling or testing materials on a project or in a field laboratory are WAQTC Certified or Method Qualified per Sections 9-5.3 and 9-5.4.

## 9-5.2 Quality Assurance Program Structure and Responsibilities

Table 9-3 outlines the structure of the quality program for WSDOT.

Table 9-3

State Materials Laboratory (SML) Requirements	
<b>State Materials Engineer</b>	Oversees: <ul style="list-style-type: none"> <li>• WSDOT Quality System Program</li> <li>• Accreditation of State Materials Laboratory</li> <li>• Program compliance reports to FHWA</li> </ul>
<b>Assistant State Materials Engineer</b>	Oversees: <ul style="list-style-type: none"> <li>• WAQTC Testing Technician Qualification Program</li> <li>• Method Qualified Tester Program</li> </ul>
<b>Quality Systems Manager</b>	Management of WSDOT's Quality System Program which includes: <ul style="list-style-type: none"> <li>• WAQTC Testing Technician Qualification Program</li> <li>• WSDOT Method Qualified Tester Program</li> <li>• Independent Assurance</li> <li>• Tester Qualification Database</li> <li>• Maintain Construction Materials AASHTO/CCRL Laboratory Accreditation at the State Materials Laboratory Building</li> <li>• Maintain up-to-date Test Procedures in the <i>Materials Manual M 46-01</i></li> <li>• Maintain Equipment Calibration/Standardization and Check Procedures</li> <li>• Audit SML and Region Materials Laboratories for compliance with the Quality Assurance Program</li> <li>• Qualified Laboratory Program</li> <li>• Certification of all Written and Performance Examiners for tester certification</li> <li>• Certification of all Independent Assurance Inspectors</li> <li>• Annual Independent Assurance Program report to FHWA</li> </ul>
<b>SML Laboratory Managers</b>	Management of their laboratories QAP which includes: <ul style="list-style-type: none"> <li>• Maintain WAQTC Certified and Method Qualified Testers</li> <li>• Maintain SML WAQTC Tester and Method Tester Certification records in the Tester Qualification database with greater than 90 percent accuracy</li> <li>• Maintain calibrated/standardized/checked equipment for their department</li> <li>• Maintain AASHTO Resource/CCRL Accreditation</li> </ul>

Table 9-3

Region Requirements	
<b>Regional Construction Manager</b>	<p>Manages the overall Region Quality Assurance Program that includes;</p> <ul style="list-style-type: none"> <li>• Reference CM Sections 9-5 and GEN 1-00.4(5)</li> <li>• Sends yearly Region IA report to the Director per CM <a href="#">Section 9-5.7C</a> and GEN 1-00.4(5)</li> </ul>
<b>Region Materials Engineer</b>	<p>Oversees:</p> <ul style="list-style-type: none"> <li>• Region Quality System Program</li> <li>• Qualification of Region Materials Laboratory</li> </ul>
<b>Region Laboratory Supervisor</b>	<p>Management of the Region Laboratory Quality System Program which includes:</p> <ul style="list-style-type: none"> <li>• Maintain WAQTC Certified and Method Qualified Testers</li> <li>• Maintain calibrated/standardized/checked equipment for the Region Materials Laboratory and field laboratories</li> <li>• Participate in biannual laboratory review</li> </ul>
<b>Region Independent Assurance Inspector</b>	<p>Management of the Region Independent Assurance Program which includes:</p> <ul style="list-style-type: none"> <li>• WAQTC Certified and Method Qualified Tester <ul style="list-style-type: none"> <li>- Determine how the program will be implemented in the Region within the guidelines of this Section and the WAQTC program</li> <li>- Schedule certification events</li> <li>- Proctor written and proficiency examinations</li> <li>- Maintain documentation of WAQTC Certifications and Method Tester Qualifications as both physical and/or digital records</li> <li>- Amendments or corrections to certification or qualification by the IA with concurrence of the QSM is permissible</li> <li>- Maintain the Region WAQTC Tester and Method Tester Certification records in the Tester Qualification database with greater than 90 percent accuracy</li> </ul> </li> <li>• Independent Assurance <ul style="list-style-type: none"> <li>- Annual audits of active WAQTC Certified Testers and Method Qualified Testers</li> <li>- Maintain annual audit records and send copies to the Quality System Manager</li> <li>- Determine frequency of visits</li> <li>- Witness IA process in the field</li> <li>- Investigate excessive deviations on split samples and aid in the review of reports of deviation from specified sampling and testing procedures</li> <li>- Investigations of complaints against a WAQTC certified tester or method qualified testers</li> <li>- Providing yearly Region IA report of IA to the Regional Construction Manager per CM <a href="#">Section 9-5.7C</a></li> </ul> </li> <li>• Other functions (optional by Region) <ul style="list-style-type: none"> <li>- Conduct initial training</li> <li>- Mentor new or newly WAQTC Certified/Method Qualified Testers to enhance efficiency and confidence</li> <li>- Assist in conducting testing and inspection training in concert with the Region Construction Trainer</li> <li>- Review materials, test-related records, and forms</li> <li>- Radiation Safety Officer</li> </ul> </li> </ul>

Table 9-3

<b>Project Engineering Office Requirements</b>	
<b>Project Engineer</b>	Management of the Project Office QAP which includes: <ul style="list-style-type: none"> <li>• Training of testers               <ul style="list-style-type: none"> <li>- Provide training opportunities</li> <li>- Provide opportunity for experience in the field</li> <li>- Maintain WAQTC Certified/Method Qualified Testers on projects</li> <li>- Maintain staff of WAQTC Certified/Method Qualified Testers to perform testing on all projects under the management of the Project Engineer</li> <li>- Verify WAQTC Testers are certified in all modules and test methods that are required to test materials on projects by obtaining copies of tester certifications</li> <li>- Maintain paper or digital copies of the WAQTC Tester Certifications and Method Qualified Tester Certifications in the Project Records</li> </ul> </li> </ul>
<b>PE Office Contact (appointed by PE as the office contact to the IAI)</b>	<ul style="list-style-type: none"> <li>• Track Certified/Method qualification of Testers</li> <li>• Assist Testers in registering for next certification or method qualification event</li> <li>• Assist testers in scheduling audits</li> </ul>
<b>Individual Tester Requirements</b>	
<b>Certified and or Method Qualified Tester</b>	Management of personal qualification which includes: <ul style="list-style-type: none"> <li>• Prepare for recertification/requalification</li> <li>• Notify Project Office contact and Region IAI of approaching expiration of certification/ qualification; notification should be at least one year in advance of the expiration of certification and one month in advance of the expiration of method qualification</li> <li>• Register for next WAQTC event prior to module expiration</li> <li>• Notify office contact and IAI to schedule annual audits</li> </ul>
<b>Uncertified and/ or Unqualified Method Tester</b>	Management of personal certifications and or method qualifications, which includes: <ul style="list-style-type: none"> <li>• Maintain certification/qualification</li> <li>• Read test procedure</li> <li>• Attend appropriate training</li> <li>• Hands-on practice of test procedure</li> <li>• Notify Project Office contact and IAI when ready to register for next certification or method qualification event</li> </ul>

### 9-5.3 WAQTC Testing Technician Qualification Program

All WSDOT employees that conduct QA/QV testing for Aggregates, Hot Mix Asphalt, Concrete, or In-Place Density of soils, HMA, and Aggregates shall be certified by the Western Alliance for Quality Transportation Construction (WAQTC). Within the WAQTC program concrete testers are American Concrete Institute certified testers. For registration information contact the Region Independent Assurance Inspector.

The purpose of this program is to provide uniform statewide testing by ensuring technicians meet the WAQTC certification and method qualification process below. This program is based on AASHTO R 25.

Refer to the WAQTC and Method Registration Policies & Information Handbook for program requirements.

The Region Independent Assurance Inspectors are responsible for maintaining the Tester Qualification database information for their Region WAQTC Testers as well as maintaining the WAQTC internal certifications and records (paper copy and digital).

#### **9-5.4 Method Qualified Tester Program**

The Method Qualified Tester program will follow the WAQTC and Method Registration Policies & Information Handbook for program requirements.

The purpose of this program is to provide uniform statewide testing by ensuring technicians meet the WAQTC certification and method qualification process below.

All personnel who perform tests not included in a WAQTC module must be method qualified in the test method they are performing or may work under the direct supervision of a qualified tester as a trainee. An individual may only work as a trainee for one year.

A method qualification for FOP for AASHTO T 166, and WSDOT T 813 are still permissible.

The Region Independent Assurance Inspectors are responsible for maintaining the Tester Qualification database information for their Region Method Testers as well as maintaining the Method internal certifications and records (physical and digital).

##### **9-5.4A Method Qualified Tester**

A method qualified tester is an individual that has proficiency in one or more test procedures or sampling modules. The following is a list of typical method qualified procedures and other procedures may be added by the Region IAI: FOP for AASHTO R 90, FOP for AASHTO R 97, FOP for AASHTO R 66, FOP for AASHTO T 166, WSDOT TM 813, AASHTO T 22, AASHTO T 106, and AASHTO T 304. A Sampling module (ST) has been added to accommodate previous method certifications for AASHTO R 90, R97 and R 66. This method qualification process will also extend to the State Materials Laboratory and Regional Laboratories for any of their inherent procedures. A complete listing of those procedures can be found in the *WSDOT Materials Manual M 46-01*.

##### **9-5.4B Independent Assurance**

An Independent Assurance (IA) audit will be performed a minimum of once per year on all active testers performing sampling, acceptance testing or verification testing. A qualified IAI will perform the IA and submit a report of findings to the Project Engineer, Region Materials Engineer and the Quality Systems Manager. Refer to [Section 9-5.7](#) Independent Assurance Program and [Section 9-5.7C](#) Independent Assurance Report.

Active Method Qualified Testers must notify the IAI to schedule an IAI visit. Failure to notify the IAI that you are performing sampling acceptance testing or verification testing is an act of Negligence. The IA Annual audits will normally be conducted in person by the IAI. If extenuating circumstances exist that prevent the IAI from observing the tester in-person, then with written approval from the State Materials Laboratory Quality Systems Manager, the IAI may perform the IA audit remotely via camera with the tester in place of the in-person review.

### **9-5.5 Calibration/Standardization/Check of Equipment**

All laboratory equipment will be calibrated/standardized/checked as required by the test procedures, AASHTO R 18 or WSDOT Verification Procedures.

The State Materials Laboratory will calibrate/standardize/check all required equipment every 12 months unless otherwise stated in the test procedure, AASHTO R 18 or the WSDOT Verification Procedures.

Region and field laboratories will calibrate/standardize/check all required equipment once a year unless otherwise specified by the WSDOT Verification Procedures. All calibration/standardization/checks will be completed by April 1st of each year. A tag bearing the year the calibrate/standardize/check expires will be affixed to all calibrated/standardized/checked equipment. The tags will be provided to the regions each year by the Quality Systems Manager.

### **9-5.6 Qualified Laboratories**

The State Materials Laboratory is an AASHTO Accreditation Program (AAP) accredited laboratory. The State Materials Laboratory will review and qualify testing laboratories performing testing on WSDOT projects. Approval or disapproval will be in accordance with Section 9-5.6A or Section 9-5.6B.

#### **9-5.6A Qualification of Region and Private Testing Laboratories**

The State Materials Laboratory Quality Systems Office qualifies WSDOT region testing laboratories and private testing laboratories to perform materials testing in accordance with WSDOT Standard Practice [QC 3](#) Quality System Laboratory Review. The laboratory review will typically be an on-site laboratory review but may be a remote laboratory review at the discretion of the Quality Systems Manager.

A hybrid laboratory review would include a combination of remote review of electronic documentation and on-site performance review of testing. A remote laboratory review would include review of electronic documentation and remote on-site performance review via camera or electronic platform, such as Teams, Zoom or other option approved by the Quality Systems Manager.

Testing laboratories may be qualified for up to two years with the approval of the Quality Systems Manager. The laboratory approval may be extended up to one additional year with approval of the Assistant State Materials Engineer. Interim laboratory reviews of the laboratory may be done at any time at the discretion of the Quality Systems Manager.

#### **9-5.6B Qualification of Specialty Testing Laboratories**

The State Materials Laboratory - Quality Systems Office qualifies specialty testing laboratories to perform materials testing based upon the specialty testing laboratory accreditation. Specialty Testing laboratories may be qualified for up to five years with the approval of the Quality Systems Manager. All laboratory qualification, tester certification, and equipment calibration records are maintained at the private testing laboratory facility.

WAQTC certifications and WSDOT method qualification do not apply to specialty testing laboratories unless the WSDOT laboratory qualification letter states otherwise.

### 9-5.7 Independent Assurance Program (IAP)

The IAP shall consist of a system-based approach to Independent Assurance (IA). This approach bases the frequency of IA audits on time, regardless of the number of tests, quantities of materials, or numbers of projects tested by the active tester. This program is based on AASHTO R 44.

The Region's IAs are responsible for managing the IAP for the Regions. Each active WAQTC Certified or Method Qualified Tester will have an IA audit annually for each WAQTC Module Certification or Method Qualification in which tests are performed. The IA Annual audits will normally be conducted in person by the IAI. If extenuating circumstances exist that prevent the IAI from observing the tester in-person, then with written approval from the State Materials Laboratory Quality Systems Manager the IAI may perform the IA audit remotely via camera with the tester in place of the in-person review.

If the Region IAI is unable to audit a tester the Region IAI will document the reason any annual tester audit was not completed and submit the information with the Independent Assurance Report to the Quality System Manager per [Section 9-5.7C](#), Independent Assurance Report.

- An active tester is defined as any tester performing at least one acceptance or verification test per year. The tester is responsible for contacting the Region IAI and scheduling an IA audit.

The on-site audit shall include evaluation of all test methods in the applicable WAQTC module. Method Qualified Testers will be audited in the performance of the individual test method.

IAP audits will be performed as follows:

- Concrete and Density test method evaluations will be by observation
- Hot Mix Asphalt and Aggregate test methods shown in Table 9-5 will be evaluated by observation and split sample. All other Hot Mix Asphalt and Aggregate test methods will be evaluated by observation only
- The field split of HMA or Aggregate will be tested by the individual who sampled and reduced the material, under the observation of the IAI or a qualified Region laboratory staff member under the direction of the Region Materials Engineer
- The laboratory split of the IA sample must remain in the custody of the IAI until the sample is logged into the Region Materials Laboratory
- A tester from the Region Materials Laboratory will perform the testing on the laboratory portion of the split sample. The same tester may not perform both the field and the laboratory testing on an IA sample
- The same equipment may not be used to test the laboratory and the field portions of the IA split sample
- All equipment used for testing the split samples will be evaluated for condition and current calibration/standardization/check tags

A record of the audits will be kept by the IAI in the Region Office and provided to the PE upon request. The record should contain the following:

- Name of tester
- Observations concerning the condition of the testing equipment
- Observations concerning the performance of the qualified tester including suggestions or on-the-spot corrections for improving the tester's performance

### 9-5.7A Comparison Evaluation of the Independent Assurance Sample

The IA split sample will be tested by the Region laboratory except, when the Region laboratory performs the acceptance testing. If the Region Materials Laboratory performs the acceptance testing then, the IA split sample will be tested by the State Materials Laboratory or another Region Materials Laboratory. The tester performing the comparison evaluation of the Independent Assurance sample must be qualified in the procedures being evaluated.

The calibrated/standardized/checked testing equipment used for the comparison must be different equipment than that used by the field during the split sample evaluation.

### 9-5.7B Assurance and Acceptance Test Results

Independent Assurance split samples will be compared using Table 9-5. Reports of the degree of conformance will be sent to the Project Engineer and the Region IAI by the Region Materials Engineer (RME).

Table 9-5

Test	Normal Range of Deviation	Maximum Range of Deviation
Sand Equivalent	± 8 points	± 15 points
Fracture	± 5 percent	± 10 percent
Asphalt Binder Content (HMA)	± 0.3 percent	± 0.6 percent
Sieve Analysis – All Items:		
No. 4 sieve and larger	± 5 percent	± 8 percent
No. 6 sieve to No. 80 sieve	± 3 percent	± 6 percent
No. 100 sieve to No. 200 sieve	± 2 percent	± 4 percent

Comments reflecting the degree of conformance will be entered in the remarks Section of the report by the Region Materials Engineer. The degree of conformance will be determined according to the deviation ranges noted below. Gradation test results will be compared only on specification screens.

In the table above, "Normal Range" indicates an acceptable range of variation between test results and no action is required. Test results that fall in this category will be so indicated by the wording "*normal deviation*" on the IA reports.

Test results falling outside of the "Normal Range" but within the "Maximum Range," will be indicated by the wording "*questionable deviation*" on the IA reports.



Deviations falling into the questionable category will be reviewed by the Region IAI. The review may include the following:

- Check for calculation errors
- Review of sampling and splitting procedure
- Review of test procedure

Findings of the review will be documented and a copy of the report retained in the Region IAI's file.

Test results exceeding the maximum range will be indicated by the wording "*excessive deviation*". Deviations falling in the excessive category will require a review by the Region IAI. The review will include the items listed under questionable deviations and may require the field tester to pull another IA sample. The IAI will document the findings of the review. If further action is required, the IAI will submit a report to the Region Materials Engineer and Project Engineer. If further action is not required a copy of the report will be retained in the IAI's files.

### 9-5.7C Independent Assurance Report

WSDOT is required by 23 CFR Part 637 to provide an annual report to the FHWA summarizing the results of the WSDOT Independent Assurance program. These reports provide a tool for the Region and WSDOT to analyze trends, identify training needs, and make improvements.

Each Region IAI will submit an annual Region Independent Assurance (IA) report in January to the Regional Construction Manager and CC the Regional Materials Engineer. The Regional Construction Manager will submit a Region Annual Independent Assurance (IA) report to the Director of the Construction Division with an electronic copy sent to the State Materials Engineer by the last working day in January.

The Region IA report will summarize the Annual Region IA results of the previous year. The Annual Region IA report will include the following:

1. Number and percent of testers audited
2. The testers name, list of tester certifications, and date each tester was audited
3. If applicable, the reason the annual tester audit was not completed on a tester or testers; see [Section 9-5.7 Independent Assurance Program](#)
4. Any tester certification revocations
5. What, if any, problems occurred and why
6. A general statement as to how any problems that were reported were resolved

The focus of Independent Assurance sampling is based on individual tester activity and is not intended to provide independent assurance sample reports on all projects or on all materials on any particular project.

The State Materials Laboratory Quality Systems Manager will submit the WSDOT Annual IA Report to FHWA by the last working day in February unless other arrangements are made with FHWA.

## 9-6 Radioactive Testing Devices

### 9-6.1 Administration and Safety

This chapter provides guidance for personnel using, transporting, and administering the use of, nuclear density gauges. The instructions included in this chapter will be used throughout the Washington State Department of Transportation for the express purpose of regulating the use of nuclear density gauges containing radioactive materials.

Each Region shall have a Radiation Administration Officer (RAO) and a Radiation Safety Officer (RSO) whose duties are described in [Section 9-6.2](#) and [9-6.3](#) respectively. All Regional RAO and RSO personnel must have radiation safety training. Only personnel who have successfully completed the WSDOT “Nuclear Gauge Safety and Operations” course are authorized to use or transport the nuclear density gauge. Personnel transporting gauges are also required to have training that satisfies USDOT training requirements of [49 CFR 172](#), subpart H (HAZMAT). This training can be satisfied by successful completion of the (WSDOT) eLearning course “Hazmat Training for the Portable Nuclear Gauge.” Recurrent training is required every three years. Personnel performing acceptance testing with the nuclear density gauge must become a qualified or interim tester in either TM-8, In-Place Density of Bituminous Mixtures Using the Nuclear Moisture Gauge, and or, T-310, In-Place Density and Moisture Content of Soils and Soil-Aggregate by Nuclear Method. The operator’s responsibilities for safety and security of the gauges are described in [Section 9-6.4](#).

All personnel using or responsible for the nuclear density gauge shall be:

1. Thoroughly familiar with the safe handling techniques for using radioactive materials.
2. Fully informed of the hazards to health that exists near radioactive materials.
3. Completely familiar and in compliance with the following rules and regulations:
  - a. Rules and Regulations for Radiation Protection by the State Department of Health, Division of Radiation Protection, [Title 246 WAC](#).
  - b. [Radiation Emergency Handbook](#) by the State Department of Health.

Copies of the above publications will be kept by the Region Radiation Safety Officer and at the storage location of the gauge. A copy of the [Radiation Emergency Handbook](#) will also be supplied with each nuclear density gauge. Authorized Operator(s) will read this handbook before using the radioactive testing device for testing.

If an emergency as outlined in the [Radiation Emergency Handbook](#) occurs, the following people or agencies should be notified by the individual in charge of the nuclear density gauge:

- Radiation safety officer
- Radiation administration officer

The RSO or the RAO will notify the following people or agencies:

- Radiation Control Program, Health Services Division, State Department of Health, Olympia, WA (Phone 206/NUCLEAR).
- Washington State Patrol, if a public hazard exists.
- Radiation Administration Officer or Radiation Safety Officer, at the State Materials Laboratory.

The telephone numbers of these agencies or individuals will be posted at all storage sites and a copy of these numbers shall be kept with each nuclear density gauge.

WSDOT employees that work around or with nuclear gauges need to know the potential health and safety hazards of working with nuclear gauges and their individual rights. Each office that uses or stores nuclear gauges shall have a copy of the latest “*Sealed Source Edition Rules and Regulations for Radiation Protection*” published by the Department of Health. Every employee that uses a nuclear gauge, or works near the storage location of the nuclear gauges, must review the applicable Chapters 246-220 Radiation – General Provisions; 246-221 Radiation Protection Standards; 246-222 Radiation Protection – Worker Rights and sign the “Acknowledgment of the Hazards of Working with Radiation Sources” form which is available through the Radiation Safety Officer.

Any individual using radioactive sources or receiving on the job training with radioactive sources must wear a radiation exposure badge which records exposure the body may receive. Radiation exposure badges are assigned to individuals they are not to be used by any other person. Any individual using radioactive sources or receiving on the job training with radioactive sources must be familiar with the conditions outlined in [WAC 246-221-010](#) and [WAC 246-221-055](#) regarding radiation exposure during pregnancy and dose limits to the embryo/fetus. Personnel with valid safety or health concerns may be released from the operation of nuclear gauges without prejudice to their career opportunities with WSDOT.

The acquisition of radiation exposure badges, as needed by each Region, shall be the responsibility of the Region Radiation Safety Officer or a designated individual with radiation safety training. Three-month TLD (Thermal Luminescent Dosimeter) badges indicating exposure to gamma, beta, x-ray, and neutron radiation will be used as a minimum.

Each nuclear density gauge will be supplied in the manufacturer’s shipping container with an adequate latch. While transporting and when storing the nuclear density gauge, it must be secured with a minimum of three levels of security using locks:

1. Security level one is considered to be a combination of a lock on the handle of the nuclear density gauge, and a lock on the manufacturer’s shipping container.
2. Security level two is considered to be the chain and lock combination, or other locking mechanism, used to secure the manufacturer’s shipping container to the vehicle if in transport or field use, or to a storage bench or locker in an approved storage facility.

**Note:** Security level two must prevent the manufacturer’s shipping container from being opened if the lock is removed.

3. Security level three is considered to be:
  - a. If a passenger vehicle is used for transporting, the manufacturer’s shipping container containing the nuclear density gauge, which is secured and locked in the trunk.
  - b. If a station wagon, van, or panel truck is used, the manufacturer’s shipping container containing the nuclear density gauge, which is secured and locked in the back of the vehicle in such a manner as to prevent it from moving during transport.

**Note:** If the manufacturer’s shipping container can be seen through a window or other opening it must be covered.

- c. If a truck with a utility box is used, the manufacturer's shipping container containing the nuclear density gauge must be secured in the utility box with the storage lid locked. The nuclear density gauge shall not be transported in the cab of the truck.
- d. If a truck with a canopy is used, the manufacturer's shipping container containing the nuclear density gauge must be secured to the bed of the truck and the canopy lid locked. The nuclear density gauge shall not be transported in the cab of the truck.
- e. If a licensed storage location, or temporary storage facility approved by the Region RSO is used, the storage facility door must be locked.

At all times, the key(s) for the security locks will be in the possession of the individual responsible for the nuclear density gauge.

Every effort shall be made to store and transport nuclear density gauges in a manner that minimizes its view from the general public.

When the nuclear density gauges are not in use or in transit, they must be stored with three levels of security in licensed storage locations, or temporary storage facilities approved by the Region RSO.

Performance audits shall be conducted randomly by the Region Radiation Safety Officer or designee to ensure that each gauge operator and transporter:

1. Understands the security and transportation requirements described above.
2. Has the necessary means available to use three levels of security in each of their transport vehicles.
3. Is actively employing the three levels of security while gauges are out of a licensed storage area.

The Region Radiation Safety Officer shall retain records of performance audits.

### **9-6.2 Radiation Administration Officer (Region Materials Engineer)**

The Radiation Administration Officer (RAO) will be responsible for administering the use of radioactive material within the Region.

The RAO will obtain, revise, and renew the Region's Radioactive Material License issued by the Washington State Department of Health. A license indicates the strength and type of radioactive sources that a Region may possess.

Licenses are issued subject to all the requirements of the Washington Rules and Regulations for Radiation Protection and to the conditions specified in the license. Licenses are also subject to any additional requirements of the Department of Health as stated in letters issued by DOH. Where a letter containing a license condition requirement differs from the Regulations, the letter will supersede the regulations insofar as the license is concerned.

When a change occurs in the radiation program, which would require a change to the current Radioactive Material License, the Licensee (RSO) will notify the Department of Health and request an appropriate amendment.

The Radiation Safety Officer (RSO) must be listed on the license. Individual operators are not required to be listed on the license, but the RAO or RSO must maintain a list of

Authorized Operators. This list of Authorized Operators should include the operator's name, type of training, final test score, and a copy of the training certificate. The RAO or RSO will be responsible for the storage of the nuclear density gauge when not in field use and the assignment of nuclear density gauges to the individual project offices. The RAO or RSO will be responsible for maintaining the following records:

1. List of qualified operators within the Region.
2. List of qualified gauge transporters within the Region.
3. Radioactive testing device location records.
4. Radioactive testing device shipping records.

Prior to shipping or transferring a nuclear density gauge from one licensed organization to another, the shipper shall check, and be assured that, the receiver has a valid radioactive material license; and that the shipped or transferred sources do not exceed the limitations of the receiver's license. Shipment to authorized personnel within the Region is covered by the Region's license. The State Materials Laboratory shall be notified when repairs or calibration are needed for any of WSDOT's nuclear density gauges. When the nuclear density gauges are not in field use, the normal storage will be at the Region office. The Region office shall have an area designated for this purpose. The following information shall be posted on the walls of the storage facility to notify personnel of the existence of radiation:

1. "Caution – Radioactive Materials" sign.
2. DOH Form RHF-3 "Notice to Employees."
3. [WAC Chapters 246-220](#), [246-221](#), and [246-222](#) of the Rules and Regulations for Radiation Protection.
4. DOH Form "Notification of a Radiation Emergency."

### 9-6.3 **Radiation Safety Officer**

The Radiation Safety Officer (RSO) will be responsible for maintaining the radioactive material license. The RSO will be responsible for maintaining the following records:

1. Leak test records.
2. Medical records.
3. Radiation Exposure Report.
4. Minor testing device maintenance as outlined in the Radioactive Materials License.
5. The Acknowledgment of the Hazards of Working with Radiation Sources form.

Leak testing is required by law and is simply a swabbing of the sealed source to ascertain that no radioactive contamination has occurred from the nuclear source. The Region RSO shall be responsible for having each source leak tested every twelve months. The analysis of leak tests shall be done by a commercial firm licensed to do this work.

The service contract will be obtained by individual regions. Records of leak test results shall be kept in units of micro-curies and maintained for inspection. Any leak test revealing the presence of 1850 Bq or more of removable radioactive material shall be reported to the Department of Health, Division of Radiation Protection, P.O. Box 47827, Olympia, WA 98504-7827, within five days of the test. This report should include a description of the defective source or device, the results of the test, and the corrective action taken.

The RSO will be responsible for radiation exposure reports for personnel in that Region. Exposure records shall be kept on Department of Health Form RFH-5, or in a manner which includes all information required on said form. Each entry shall be for a period of time not exceeding one calendar quarter.

#### 9-6.4 **Authorized Operators**

The Authorized Operators will be directly responsible to the RAO for the use and storage of the nuclear density gauge in the field and to the RSO for all safety in regard to the nuclear density gauge.

The Authorized Operators shall be responsible for posting the following information at all field storage areas:

1. "Caution – Radioactive Materials" Sign.
2. DOH Form RHF-3 "Notice to Employees."
3. [WAC Chapters 246-220, 246-221, and 246-222](#) of the Rules and Regulations for Radiation Protection.
4. DOH Form Notification of a Radiation Emergency

The Authorized Operator must keep the RAO or RSO informed of the location of the nuclear density gauge at all times. (The State Radiation Control Unit inspectors will want the sources produced or the exact locations given during their periodic inspections.) If the exact location where the nuclear density gauge will be used is known in advance, it should be noted before leaving the Region office, and if unknown, shall be forwarded to the RAO or RSO as soon as it is known.

The operation of the shutter-operating device should be frequently checked, and any malfunction reported to the RAO or RSO immediately. When not in use, the source index handle will be locked and the nuclear density gauge locked in an adequate storage facility. When operating the nuclear gauge (i.e., when the handle is in the "USE" position), unauthorized persons are not to be within 15 feet (5 meters) of the gauge.

#### 9-6.5 **Authorized Transporters**

It is permissible for employees to be an authorized transporter of nuclear density gauges providing they have the training described in [Section 9-6.1](#). It is not necessary for authorized transporters who are not also authorized operators to be assigned a radiation exposure badge. Authorized transporters will be issued a card stating the employee has "satisfactorily completed Hazmat training for transportation of the portable Nuclear Gauge as described in [49 CFR 172.700](#)." Authorized transporters are subject to performance audits as described in [Section 9-6.1](#).

## 9-7 Field Operating Procedures and other Related Test Methods

All test methods are located in the [Materials Manual](#) M 46-01. The below list contains commonly used Field Operating Procedures and other related Test Methods. Click any of the Procedure Numbers to access that specific Test Method or click here to access the full [Materials Manual](#) M 46-01.

Procedure Number	Owner	Test Method
<a href="#">TM 2</a>	WAQTC	FOP for WAQTC TM 2, Sampling Freshly Mixed Concrete
<a href="#">T 23</a>	WAQTC	FOP for AASHTO T 23, Method of Making and Curing Concrete test Specimens in the Field
<a href="#">T 27/11</a>	WAQTC	FOP for AASHTO T 27/T 11, Sieve Analysis of Fine and Coarse Aggregates
<a href="#">T 30</a>	WAQTC	FOP for AASHTO T 30, Mechanical Analysis of Extracted Aggregate
<a href="#">R 47</a>	WAQTC	FOP for AASHTO R 47, Reducing Samples of Hot Mix Asphalt (HMA) to Testing Size
<a href="#">R 66</a>	WAQTC	FOP for AASHTO R 66, Sampling Asphalt Materials
<a href="#">R 76</a>	WAQTC	FOP for AASHTO R 76, Reducing Samples of Aggregates to Testing Size
<a href="#">R 90</a>	WAQTC	FOP for AASHTO R90, Sampling Aggregate Products
<a href="#">R 97</a>	WAQTC	FOP for AASHTO R 97, Standard Practice for Sampling Asphalt Mixtures
<a href="#">T 99</a>	WAQTC	FOP for AASHTO T 99, Moisture-Density Relations of Soils Using a 5.5-lb Rammer and a 12-in Drop
<a href="#">R 100</a>	WAQTC	FOP for AASHTO R 100, Method of Making and Curing Concrete Test Specimens in the Field
<a href="#">T 119</a>	WAQTC	FOP for AASHTO T 119, Slump of Hydraulic Cement Concrete
<a href="#">T 123</a>	WSDOT	Method of Test for Bark Mulch
<a href="#">T 152</a>	WAQTC	FOP for AASHTO T 152, Air Content of Freshly Mixed Concrete by the Pressure Method
<a href="#">T 166</a>	WAQTC	FOP for AASHTO T 166, Bulk Specific Gravity ( $G_{mb}$ ) of Compacted Hot Mix Asphalt (HMA) Using Saturated Surface-Dry Specimens
<a href="#">T 176</a>	WAQTC	FOP for AASHTO T 176, Plastic Fines in Grade Aggregates and Soils by the Use of the Sand Equivalent Test
<a href="#">T 209</a>	WAQTC	FOP for AASHTO T 209, Theoretical Maximum Specific Gravity ( $G_{mm}$ ) and Density of Hot Mix Asphalt (HMA) Paving Mixtures – “Rice Density”
<a href="#">T 255</a>	WAQTC	FOP for AASHTO T 255, Total Evaporable Moisture Content of Aggregate by Drying
<a href="#">T 272</a>	WAQTC	FOP for AASHTO T 272, One-Point Method for Determining Maximum Dry Density and Optimum Moisture
<a href="#">T 304</a>	WSDOT	FOP for AASHTO T 304, Uncompacted Void Content of Fine Aggregate
<a href="#">T 308</a>	WAQTC	FOP for AASHTO T 308, Determining the Asphalt Binder Content of Hot Mix Asphalt (HMA) by the Ignition Method
<a href="#">T 309</a>	WAQTC	FOP for AASHTO T 309, Temperature of Freshly Mixed Portland Cement Concrete
<a href="#">T 310</a>	WAQTC	FOP for AASHTO T 310, In-Place Density and Moisture Content of Soil and Soil-Aggregate by Nuclear Methods (Shallow Depth)
<a href="#">T 312</a>	WAQTC	FOP for AASHTO T 312, Asphalt Mixture Specimens by Means of the Superpave Gyrotory Compactor
<a href="#">T 329</a>	WAQTC	FOP for AASHTO T 329, Moisture Content of Asphalt Mixtures by Oven Method
<a href="#">T 335</a>	WAQTC	FOP for AASHTO T 335, Determining the Percentage of Fracture in Coarse Aggregate
<a href="#">T 355</a>	WAQTC	FOP for AASHTO T 355, In-Place Density of Asphalt Mixtures by Nuclear Method
<a href="#">SOP 615</a>	WSDOT	Standard Operating Procedure for Determination of the % Compaction for Embankment & Untreated Surfacing Materials using the Nuclear Moisture-Density Gauge

Procedure Number	Owner	Test Method
T 716	WSDOT	Method of Random Sampling for Location of Testing and Sampling Sites
SOP 729	WSDOT	Standard Operating Procedure for Determination of the Moving Average of Theoretical Maximum Density (TMD) for HMA
SOP 730	WSDOT	Standard Operating Procedure for Correlation of Nuclear Gauge Determined Density with Hot Mix Asphalt Cores
SOP 731	WSDOT	Standard Operating Procedure for Method for Determining Volumetric Properties of Hot Mix Asphalt
SOP 733	WSDOT	Standard Operating Procedure for Determination of Pavement Density Differentials Using the Nuclear Density Gauge
SOP 734	WSDOT	Standard Operating Procedure for Sampling Hot Mix Asphalt (HMA) after Compaction (Obtaining Cores)
SOP 735	WSDOT	Standard Operating Procedure for Longitudinal Joint Density
SOP 736	WSDOT	Standard Operating Procedure for In-Place Density of Bituminous Mixes Using Cores
C 805	WSDOT	Rebound Hammer Determination of Compressive Strength of Hardened Concrete
T 813	WSDOT	Field Method of Fabrication of 2-in. Cube Specimens for Compressive Strength Testing of Grouts and Mortars
T 818	WSDOT	Air Content of Freshly Mixed Self-Compacting Concrete by the Pressure Method
T 819	WSDOT	Making and Curing Self-Compacting Concrete Test Specimens in the Field
T 914	WSDOT	Practice for Sampling of Geotextiles for Testing
C 939	WSDOT	FOP for ASTM for Flow of Grout for Preplaced-Aggregate Concrete (Flow Cone Method)
C 1611	WSDOT	FOP for ASTM for Slump Flow of Self-Consolidating Concrete
C 1621	WSDOT	FOP for ASTM for Passing Ability of Self-Consolidating Concrete by J-Ring



# Chapter 10      Documentation

---

## 10-1      General

### 10-1.1    Introduction

This chapter is intended to provide a reference and to act as guidance for the project office in the keeping of Construction Contract Records. While there may be differing needs or circumstances that must also be met within each project office, it is intended that this guidance be used to help identify the minimum requirements that are necessary in order to establish an adequate method of record keeping. These minimum requirements also help to establish a basic level of uniformity among all project offices statewide. This can help to facilitate the review of records by others and promotes greater efficiency when engineering personnel are transferred or reassigned between different projects or even different project offices. If a clear method of record keeping can be identified prior to the beginning of work, then original field notes and records can be easily prepared and maintained as the work progresses. This will also help to reduce the effort required to produce the final contract records upon completion of the project.

Successful Contract documentation requires that measurements and calculations supporting contract payments are accurate and that records of these actions are complete. Contract records and documentation must be sufficiently detailed and maintained in a manner that will withstand an audit and be clear enough to be read and understood by anyone unfamiliar with the project. The Project Engineer is responsible to ensure that these accurate and complete records are maintained for all construction project work. If questions arise or assistance is needed, the statewide Documentation Engineer and the Regional Documentation Engineer are both available as resources for the Construction Project Office's use.

It is recommended that original field notes be kept in a form that can be filed and retained as basic documentation. Field notes taken on scratch paper and then passed to the office should not be considered as acceptable documentation. Transcription of field notes to final record form should be avoided due to the possibilities of error and the unnecessary cost of duplication.

All personnel are responsible to ensure that notes are made correctly and are complete with all pertinent information. Sample notes have been included with this chapter and are intended as a guide or reference in preparing final record notes.

Facsimile machines, scanned documents, and electronic mail are normal business practices in most state and private offices. It is acceptable to take action on these types of correspondence; however, in order to properly document and follow the conditions noted in the contract, exchanging or mailing original copies of the documents should follow up all facsimile, scanned documents, and electronic mail. This is especially true for any item that requires a commitment by either the Contractor or the Washington State Department of Transportation (WSDOT). Follow-up mail copies are required for all issues that require an original signature.

Documents which must stand up in a court of law or meet the requirements of a State or Federal Audit require a signature.

A signature, whether digital, electronic, or hand-written, is primarily a symbol signifying intent and identifying those who worked on the documentation record. Now that we are conducting a substantial portion of our business via the computer, each individual should become familiar with those documents which require an original signature and which are acceptable with a printed/computer generated name.

[Chapter 11](#) lists the various electronic construction forms made available by WSDOT. These forms may be used to record, document, and make payment for construction activities and materials on WSDOT construction projects. The forms are categorized by:

- Those persons responsible for completing the form (e.g., project office, Contractor, Materials Lab).
- Whether an original signature is required or a printed/computer generated signature is acceptable.

### 10-1.2 Requirements for Notes

Documentation of contract items that are not specifically covered by the sample field notes can, in most instances, be created using the examples as a guide for similar items. The following notations should be carefully observed for correct procedure:

1. Each set of notes should contain the date when they were made and the initials of the persons making them.
2. Each set of notes, except staking notes, should contain the date when the phases of work are accomplished, the initials of the persons who compute and check the quantities noted, the dates when the quantities were computed, the dates when the computations were subsequently checked, the locations where the work was performed, and the corresponding group number.
3. When field notes are used as the basic source document in supporting a payment to the Contractor, they must include the date and initials of the person making the entry into the project ledger, the person verifying the entry, and the six-digit entry number.
4. Each pay quantity identified in the field notes should be designated with the corresponding item number and correct item name listed in the contract.
5. It is recommended that the correct field book or loose leaf sheet always be used for the particular kind of work being staked or measured.
6. The degree of accuracy required for computing unit quantities should be consistent with standards established in [Section 10-2.1B](#).
7. It is recommended that sets of field notes and field books be numbered and titled in order to prevent their loss and to aid in tracking payments and their supporting information.

### 10-1.3 Source Documents

Field notes are one of the many items that might be considered as a Source Document. It is recommended that all field notes, base line notes, centerline notes, and grade books be recorded in bound books. If looseleaf books are to be used, care must be exercised to prevent lost pages.

Notes should be recorded in a manner that is neat, clear, uncrowded, and in sufficient detail so as to be easily understood.

Original entries later determined to be in error must not be obliterated by erasing, application of correction fluid, taped over, or in the case of computer-generated documents, deleted. Instead, a line should be cleanly drawn through the mistaken entry and corrections entered directly above with the date of the correction and the initials of the person making the change. This is very important, as erasures, or deletions will destroy the legal standing of notes. When revisions require abandonment of a considerable portion of notes, they shall be crossed out and a cross reference made of the book and page number where the revised notes may be found.

Each Final Records book should be labeled and contain a title page using [DOT Form 422-009](#) and [422-009B](#). Each book is to be numbered and a table of contents included on the first page following each book's title sheet. It is essential that original field notes and documents be carefully organized, kept, recorded, and maintained in safe filing facilities during the active stage of a project. These documents should be transferred to safe, adequate, and recoverable storage after the contract is completed. At all times, when not in use, all source documents, reports, survey notes, etc., should be kept in fire resistant files where possible. Additional information on source documents can also be found in [Section 10-4.2](#).

## 10-2 Measurement of Items of Work

### 10-2.1 General

#### 10-2.1A Introduction

The Project Engineer must ensure proper controls are exercised when measuring items of Work and that payment made for any item can be substantiated by the project records, regardless of the Work's stage of completion. Items that are paid for based on weight or truck volume require measurement of the quantities involved, evidence of receipt for the materials, and documentation for both operations through use of Item Quantity Tickets (IQT), receiver logs, or other delivery methods.

#### 10-2.1B Quantity Details

The number of significant decimal places to which quantities are measured and/or computed varies with the value or unit bid price of the respective items involved. Unless advised otherwise, the Project Engineer will use the following guidelines.

Bid Price	Significant Decimal Per Unit
Less than \$10 per unit	1.0
From \$10 to \$100 per unit	0.1
Over \$100 per unit	0.01

If a higher significant decimal place is used to calculate various parts of a particular quantity, the total payment amount will be determined using the guidelines above. For example, when totaling daily item quantity tickets, calculate the quantity to the decimal point recorded on the tickets. Payment totals for the day will be rounded to the proper significant decimal place shown above and the rounded quantity is recorded in the CAPS project ledger.

Quite often, good practice would dictate that the various parts of a particular quantity be calculated to a higher significant decimal place or in some other unit, a unit other than that used for payment, and then be converted to the payment unit in the summation.

Good judgment should be used in selecting when to actually apply rounding to the quantity. In general, it is considered proper to apply rounding at the first summation of each isolated part. For example, at the summation of a day's item quantity tickets the quantity to be recorded should be rounded to the proper significant decimal place and the rounded quantity recorded into the project ledger.

### 10-2.1C Item Quantity Ticket

IQTs are used to document items that are paid for based on quantities of material or other bid item services that are received at the project site. IQTs can be provided by the State, the Contractor, commercial sale companies or suppliers at commercial plants/material sources.

The State provided IQT (DOT Form 422-021) shown in Figure 10-1 can be used to document material or services that do not require the use of electronic tickets. The Contractor will receive a copy of all State provided IQTs.

The Project Engineer will ensure that all IQTs include the items noted below, identified as the minimum required information for documenting receipt of materials and for supporting payment of those materials. Additional information may be added to IQTs at the option of the Project Engineer as a convenience when monitoring material use.

All IQTs must include the following minimum required information:

- Contract Number
- Date
- Contract Unit Bid Item No.
- Unit of measure
- Identification of hauling vehicle
- Record of the gross, tare, and net weights
  - If the scale has a tare beam so that the net weight can be read directly or when using batch plants or storage silos with direct reading scales, only the net weight need be recorded.

*If the unit of measurement is cubic yards, hours, etc. only the net quantity needs to be recorded.*

In addition to the minimum required information, there are a number of other items that could also be included on IQTs. While this information is helpful to others who may also be using these same tickets for monitoring materials, materials placement, or other issues, this additional information is not required to support payment for materials received. Recording this information on IQTs is solely at the option of the Project Engineer. Some of these optional items may include:

- Group, Station or Mile of material placement
- Contractor/Subcontractor completing the work
- Cumulative totals for the day
- Pit number identifying the source of the material
- Time weighed and initials of the person issuing the ticket
- Time materials or services are received on the job site
- Description of the material that matches the unit bid item name
- Ticket serial number, etc.

## Electronic Tickets

An electronic ticket is an example of a Contractor provided IQT. When the Contract requires use of electronic tickets, a WSDOT representative is responsible for monitoring and tracking loads of delivered material at the delivery site or at the site where the item is placed. The receiver can use the Contactless Receipt Log (DOT Form 410-001), to document the number of delivery loads received for each type of material placed. Use of an alternative form is allowed if all the same information included on the Contactless Receipt Log is documented.

Electronic tickets are uploaded by the Contractor to a designated site where the Project Inspector can access them, allowing for additional information to be recorded on the electronic ticket as necessary. If additional notes cannot be made directly on the electronic ticket, record additional information in the comments column of the Contactless Receipt Log.

Use of electronic tickets allows the receiver to observe and record deliveries from a safe distance away from the point of delivery. Locate the receiver in an area where the Work can be visually observed while maintaining the Contactless Receipt Log. The receiver can access electronic tickets and record the weight of the material incorporated into the project when delivered. If electronic tickets are not immediately accessible, due to internet connection or other issues, the weight can be added when access is restored. If a partial load is placed, note the amount of material incorporated in the weight column and make a note in the comment field.

At the end of each work shift, the receiver will reconcile quantities captured in the Contactless Receipt Log with the electronic tickets uploaded for each day. To reconcile the form:

- Ensure that tickets are on file for each load received, and
- Add the weight from each ticket to the Contactless Receipt Log
  - To be done throughout the day as incorporated, or once access is restored
- Note partial loads placed in the Comments column to account for any discrepancies between the electronic tickets and the Contactless Receipt Log
- Reconcile any differences between the Contactless Receipt Log and the Contractor provided Daily Summary Report

Once reconciled, check the “Reconciled” box on the bottom of the Contactless Receipt Log and electronically sign the form indicating that the loads shown were delivered and are accepted.

Contactless Receipt Logs are retained with the associated electronic tickets and daily summary reports and filed with the payment documentation. Reconcile missing tickets with the Contractor immediately to avoid contention for payment later as payment. Payment will be based on the reconciled Contactless Receipt Log.

For materials or services that are not paid for by weight, the receiver will complete a State provided IQT at the point of delivery.

### Electronic Delivery Management System - E Ticketing System

When the Contract requires the use of electronic tickets, the Contractor is responsible for providing a system capable of meeting the requirements of *Standard Specification 1-09.2* and a Type 2 Drawing that details how the system used meets specification.

The working drawing will need to address:

- How partial loads will be tracked
- Contingency plans for lost internet connectivity and/or phone reception
- Training for everyone who is required to access the e-ticket information
- An alternative method for creating tickets if internet or cell phone service is temporarily unavailable where material is loaded

This would be the appropriate time to discuss other information that would be beneficial to include on the electronic ticket. Many of the systems will have the ability to print information on the tickets that can be used by Project Office staff to help with tracking materials.

#### 10-2.1D Conversion Factors

Where the Plans require a weight measurement for minor items of construction, the Contractor may request permission to convert volume to weight. When approved by the Project Engineer, an agreed factor may be used to make this conversion and volume may be used to calculate the corresponding weight for payment. The provisions for this conversion factor can be found in *Standard Specification* Section 1-09.2(5). When using a conversion factor, the Project Engineer must perform adequate tests and retain supporting data establishing the conversion factor or new price quotation. A letter of agreement or change order for the conversion factor is needed.

### 10-2.2 Items Measured by Weight

#### 10-2.2A General Instructions

All materials paid by weight are to be weighed in accordance with the *Standard Specifications*. The Contractor has the option of using:

- Contractor provided scale operations - scales are set up specifically for the project and are used to weigh all or most of the material utilized in the Contract Work, or
- Commercial scale operations - scales that are used to sell materials to the public

All scales must be capable of producing electronic tickets that include the necessary weights and information on the Item Quantity Tickets in accordance with [Section 10-2.1C](#)

The Project Engineer will collect the documentation required in SS 1-09.2(5) for scale verification checks. Scale verification checks:

- Are required twice per project year for Contractor provided scale operations - once near the beginning of scale operation and then again near the end of when the scale will be used.
- Are at the option of the Project Engineer for commercial scale operations.

For most materials, material and tare weights will be measured to the nearest 100 pounds. In determining quantities for materials produced from batch type mixing plants, where individual components of each batch materials are weighed before mixing, the batch weights are acceptable for measurement and payment.

### 10-2.2B Weighing Equipment

Scales for the weighing of natural, manufactured, or processed highway and bridge construction materials that are required to be proportioned or measured and paid for by weight, are to be furnished, erected, and maintained by the Contractor, or be permanently installed, certified, commercial scales. All weighing equipment and scale operations must meet the specific requirements noted in *Standard Specifications* Section 1-09.2.

When batching scales or platform scales are used, the Project Engineer will collect scale certifications meeting the Standard Specification requirements before use at a new site and 6-month intervals afterwards.

## 10-2.3 Items Measured by Volume

### 10-2.3A Truck Measure

Except as noted below, when materials are measured and paid on volume delivered in trucks, the Project Engineer should ensure that a receiver is assigned at the point of delivery to issue or receive load tickets and to make periodic computations of yield where applicable.

Use Item Quantity Tickets (see [Section 10-2.1C](#)) when recording the volume of materials paid based on truck measure. The tickets should include all information previously noted as required for materials measured by weight, with the substitution of measured volume in place of measured weight to be shown as the quantity received.

#### **Surfacing Material, Gravel, Topsoil, Etc.**

In lieu of issuing individual load tickets when surfacing materials, gravel backfill, top soil, etc., are measured and paid for based on of volume delivered in trucks, it is acceptable for the Project Engineer to maintain a field record showing a recording for each delivery, issuing one ticket for the total amount delivered for each item at the end of each work shift. The field record will show the Contract number, date, identification number of hauling vehicles, Contract bid item number, time of delivery, and volume for each load. The daily ticket issued will include all pertinent data including reference to the field number.

In documenting the size of loads received, ensure the following procedures are followed:

1. The volume of each truck box will be calculated and recorded to the nearest 0.1 cubic yard based on a struck or water level height for the leveled load
  - The volume may be calculated by using a measurement of the truck box (either from the interior or exterior of the bed) using any standard measurement method. This measurement may be performed by a representative of the Project Engineer or by the Contractor, as verified by the Project Engineer
  - The calculation may also be made based upon verified manufacturer's truck bed dimensions supplied to the Contractor by the manufacturer, or
  - By filling the truck bed and measuring the volume of a full load after it is dumped.

Although State law requires 6 inches of freeboard on loaded aggregate material trucks, the actual quantity hauled or calculated may exceed the measured capacity. This is due to the normal practice of heaping material in the center of the load.

2. The material receiver should have sufficient loads leveled at the point of delivery to judge consistency in the quantity being hauled.
3. Load volume will be recorded to the nearest cubic yard for pay purposes using the volume calculation methods described in part (1) above. If the Project Inspector questions whether a truck is fully loaded, the load will be leveled. If the vehicle is not fully loaded, the Project Inspector will measure and document the amount delivered to the nearest cubic yard.

### **Water**

The amount of water delivered to a project will be documented either by use of a Contactless Receipt Log or by a Contractor provided Item Quantity Ticket (IQT).

If the Contactless Receipt Log is used, the Project Inspector will complete the form and record the number of deliveries made each day.

Contractors can also provide an IQT using the state provided form, or a form that includes:

- Delivery location of each load
- Contract number
- Identifying number for hauling vehicle
- Amount delivered for each load
- Time each load was delivered

If a Contractor provided IQT is used, the Project Inspector must perform daily spot checks to verify quantities delivered and document these checks in the Inspector's Daily Report and on the Item Quantity Ticket. If a note cannot be made directly on the IQT received, the information can be recorded on the Field Note Record when payment is made.

The capacity of each water truck will be determined by measuring, weighing, or using the truck make and model. Record the method used and capacity of each truck in the project records.

When water meters are installed at the discharge point for hydrants or water trucks, the Project Inspector must record the meter reading at the beginning and end of each shift and document readings on the Contactless Receipt Log for the net quantity of water placed in accordance with Contract Specifications for the item.

### **10-2.3B Cross-Sections**

Many excavation items are measured by field cross sections and/or template notes. The Project Engineer will ensure that the project is staked and measured accurately in accordance with guidance noted in the "Basic Surveying" manual and utilizing sound engineering practices. At a minimum, show the date the data was taken, weather, crew members, and their assigned duties in the field records. When these measurements are required, it is important that the same base line and elevation datum be used.

Documentation of volume measurement for excavation areas which require original and final measurements, should contain cross references between the original notes and the re-measure notes. Also reference the transit notes and elevation datum for that excavation area.



### 10-2.3C Neat Line Measurement

Some items, such as concrete volumes, are paid based on dimensions detailed in the plans. For these items, the quantities need to be calculated and the calculations made a part of the record. If additional sketches or dimensions are also required to compute the quantities, include in the records as well.

Other items, such as structure excavation and gravel backfill, are measured for payment using neat line volumes based on plan dimensions as a maximum limit. These items require field measurement to determine pay quantities that may be less than neat line maximums. Many times, sketches with the dimensions shown are desirable.

Include dimensions to show the limits of the actual Work, except when these limits exceed the maximum allowed for payment, then the dimensions will be limited to the maximum allowed.

### 10-2.4 Items Measured by Hour/Day

When Contract items are to be measured and paid for on an hourly or daily basis, the Project Engineer is to ensure that a WSDOT representative is assigned to verify the hours or days of payment, and issue Item Quantity Tickets or other verified field note records. Issue at least one ticket at the end of each work shift or working period and show all pertinent information for the item involved.

Some items measured by the hour may be eligible for payment during non-shift hours; for example, a 24-hour flashing arrow used for lane closures or detours in effect during nonworking hours. In these situations, an Item Quantity Ticket for one shift may show more hours for payment than are actually available within the shift.

To ensure agreement on the hours or days of work performed, Item Quantity Tickets for items of work measured by the hour or by the day should be initialed by the Project Inspector and signed by the Contractor's representative daily.

### 10-2.5 Items Measured by Lump Sum

For items that are to be paid on a Lump Sum basis, the project records should identify the item, the date that the material was received, and/or the date work was accomplished. This can be accomplished by ensuring that a field note record is made showing the dates work was performed, has the initial of the Project Inspector, and shows the work to be 100 percent complete. A field note should also be used to show any estimated portions for progress payment of a Lump Sum amount prior to 100 percent completion. It must include the basis on which any quantities used for progress estimate payments were calculated.

### 10-2.6 Items Measured by Other Units

#### 10-2.6A Linear Measurement

Records for materials measured by length should show the length measured, initials of the persons making the measurements, and the date measured.

For features, such as guard rail and barrier, that are paid by length and which contain repetitive elements or units, the length may be "measured" by calculation. In other words, if the length of a single element is known, then the number of elements may be counted and multiplied by that amount and a total "measured" length determined. Care should be

taken to account for odd length elements, such as end sections and custom-fabricated pieces, and for areas where elements overlap or gaps exist.

Records for measurement should also include the beginning and ending stations of the work, recorded by the Project Inspector or person making the measurement, tying the work to its location on the project. The dates of construction should also be recorded.

#### **10-2.6B Area Measurement**

Records for materials or work measured by area should show the length and width measured or otherwise determined, initials of the persons making the measurements, and the date measured. In many instances a sketch of the area with the measurements would be very helpful in showing the computed area. The dates of construction should also be recorded.

#### **10-2.6C Per Each Measurement**

Records for materials or work measured per each unit should provide a listing showing the location of each item constructed, dates constructed, and initials of the Project Inspector or person measuring the item.

### **10-2.7 Items Bid at “No Charge”**

Normal documentation procedures are not required for items bid at “no charge” if the items do not physically constitute a portion of the finished work. However, notes in the Inspector’s Daily Report are necessary to show when the work was done. Examples of these items might include water, haul, and embankment compaction.

For items bid at “no charge” which physically constitute a portion of the finished work, normal documentation procedures, such as Item Quantity Tickets or cross sections, are required to show how the item was incorporated into the project. Examples of these items might include layering materials and prime coat aggregate.

## **10-3 Final Records for Projects Constructed by Contract**

### **10-3.1 Records**

All records created during a construction project are placed in one of two categories, *Permanent Final Records* - records kept by Headquarters and State Archives for future reference, and *Temporary Final Records* - records kept for a limited period of time after which they are discarded. Any record created during the life of a project not specified as a Permanent Final Record becomes part of the Temporary Final Records.

#### **10-3.1A Permanent Final Records**

Documents designated as Permanent Final Records are permanently filed, meaning that they are never destroyed. Permanent Final Records are filed electronically using the Enterprise Content Management (ECM) system.

Contact the State Construction Office to request approval to file Permanent Final Records in paper format for projects that are not in Unifier or that are older and have received most or all submittals in paper.

The following documents are part of the Permanent Final Records and are filed in the ECM by HQ - specifically Accounting Financial Services (AFS) or Region Staff:

- Original Signed Contract Form - filed by AFS
- Original Change Orders - filed by Region
- Contract Estimate Payments - filed by AFS
- Final Contract Voucher Certification - filed by AFS
- Final Estimate Package - filed by AFS

To use the ECM, projects must be in CCIS and set up individually in the system. Project Offices can set projects up in the ECM by sending an email to the address shown in the Construction ECM User Guide available on the [Construction SharePoint](#) site.

Refer to the ECM User Guide for detailed instruction on submitting Permanent Final Records.

Permanent Final Records stored in the ECM must meet the following criteria:

**Type/Format:** All documents uploaded to the ECM must be flattened PDF's and created electronically. Scanned documents are acceptable if emailed from a recognized agent of the Contractor.

**Resolution:** 300 DPI

**Dimensions:** Electronic records shall be standard dimensions of 8 ½"×11" or 11"×17".

**File names:** When each document is created by WSDOT or submitted by the Contractor or Design Builder, it must be named according to the naming conventions outlined in the ECM User Guide.

Permanent Final Records are filed in books as outlined below:

1. Final Records Book No. 1 (See [Section 10-3.2](#) for requirements)
2. Construction Project Diaries (DOT Form 422-004A)
3. Inspector's Daily Reports
4. Traffic Control Reports
5. Pile Driving Records
6. Post Tensioning Records
7. Contaminated Materials Records
8. Miscellaneous Records

Permanent Final Records also include a set of electronic as-built plans and complete Contractor provided shop drawings.

After documents are uploaded into the directory, they can be found in the ECM Portal located at <http://wsdotecm/Portal>. Refer to the Construction ECM Search Guide for more information.

Once all electronic final record documents for the Contract are assembled and complete at the project engineer office, they are sent to Region for review through the ECM. When one group completes their review, the records are locked to that group and are made available to the next. If a reviewer finds issues within the records, comments are added, and the records are returned to the previous reviewer. Once all reviews are complete, HQ Record Services are notified by Region that final records for the Contract are complete.

### 10-3.1B Temporary Final Records

Records designated as *Temporary Final Records* are retained for a period of three years after which they may be destroyed. If a claim, lawsuit, or other circumstance is pending at the end of this three-year period, the Region will further retain those pertinent records until the issues have been resolved.

For State-funded projects, the three-year retention period begins when the Final Contract Voucher is signed by the State Construction Engineer, shown as the Acceptance Date in the CCIS A1 screens:



Acceptance Date: 12 30 2020

For Federally funded projects, the three-year retention period begins when FHWA accepts the final payment voucher. The Headquarters Accounting and Financial Services (AFS) Division will send a Retention of Records on Federal Aid Projects letter to the Region that specifically indicates when the three-year retention period begins and ends.

Prior to destroying Temporary Final Records, complete a Public Records Destruction Log, DOT Form 720-025, to request approval from the Records Officer (identified on the form) and attach a copy of:

- A CCIS screenshot (Page 4 of the A1 screens) for State-funded projects showing the acceptance was at least three years prior
- The letter sent from AFS indicating that the retention period has been met for Federal funded projects

Regions must keep copies of approved destruction logs in a location that is easily accessible for public disclosure requests.

The following list contains some of the items that may be kept as Temporary Final Records. This listing is not a complete listing of all the possible items that could be grouped into this category. In short, Temporary Final Records consist of all project records that are not identified as Permanent Final Records. If Temporary Final Records are kept in numbered books, begin with Book Number 9 to eliminate confusion with Permanent Final Records.

Examples of Temporary Final Records include:

- Item Quantity Tickets
- Project Engineer's Copy of Estimates Payments - with the PE's signature
- Project Correspondence
- Inspector's Record of Field Tests
- Concrete Pour Records
- Approval of Source of Materials - Request for Approval of Materials (RAM) and Qualified Product Lists (QPL)
- Quantity Computation Sheets
- Surfacing Depth Check Records
- Source document files
- Alignment (Transit) Book
- Grade Book
- Cross-Section Notes
- Drainage Notes
- Photographs
- Falsework and Form Plans
- Daily Report of Force Account Worked
- Field Note Records
- Final DBE Utilization Plan Report
- Milestone Letters (Substantial, Physical and Completion)
- Washington State Patrol Field Check list
- Recycled Material Report and Utilization Plan

Documents submitted to the Project Engineer through Labor and Industries' Prevailing Wage, Intents and Affidavits (PWIA) system will be stored within and do not need to be printed for inclusion with the Temporary Final Records. PWIA's retention schedule keeps records for six years after the Notice of Completion for the project or longer if there are outstanding issues, exceeding our retention schedule for Temporary Final Records. Examples of records stored in PWIA include:

- Statement of Intents
- Affidavits of Wages Paid
- Certified Payrolls
- Apprenticeship Utilization Reports
- Apprenticeship GFE Documentation
- Apprenticeship Utilization Plan

### 10-3.2 Final Record Book No. 1

Final Record Book No. 1 is the first book of the *Permanent Final Records* for a construction Contract. It contains indices for the records that have been compiled for both *Permanent and Temporary Final Records*. It identifies the people who worked on the project and provides specific summary information. Final Record Book No. 1 is signed by the Regional Administrator or designee and contains a title page [DOT Form 422-009](#).

The following records are to be incorporated into Final Record Book No. 1 in the order as arranged below. No other documentation is included in this book.

1. **Title Page and Index** – Include a completed copy of DOT Form 422-009 as the first page. There are also two indices included in Final Record Book No. 1.
  - The first is an index or detailed listing showing the various sections of Final Record Book No. 1 itself. An example of an index for Final Record Book No. 1 can be found in [Figure 10-2](#).
  - The second index provides a detailed listing of all records that have been kept and assembled for the project in both the Permanent and Temporary Records. An example of this index can be found in [Figure 10-3](#).
2. **WSDOT Personnel List** – Section 2 of Final Record Book No. 1 contains a listing of all WSDOT personnel assigned to the project and their classifications. Each person noted should place their electronic signature and initials after their name on the listing in the same manner as it appears in other final record documents. The Project Office may use Project Personnel Listing [DOT Form 422-001](#) for this purpose.
3. **Comparison of Quantities** – Section 3 of Final Record Book No. 1 contains this CAPS report prepared from the Final Estimate.
4. **Change Orders** – Section 4 of Final Records Book No. 1 contains a listing of all change orders prepared for the completed project.
5. **Record of Construction Materials** – Section 5 of Final Records Book No. 1 contains a tabulation showing the source of all construction materials. If material of a certain type was obtained from two or more sources, the station limits or parts of a structure relative to each source should be shown. A copy of the final maintained Record of Materials per *Construction Manual* [Section 9-1.2C](#) shall also be included.

When preparing the individual Final Record Books, other than Book No. 1, it is not necessary to label pages within each book. Where it is appropriate, a table of contents may be added to identify sections within a particular book.

### 10-3.3 Construction Project Diaries - Final Records Book No. 2

The Project Engineer may include records of conversations, meetings, or other pertinent information that is not covered by routine reporting. Page 2 of the Inspector's Daily Report (DOT Form 422-004A) may be used to document:

- Routine matters if the circumstances are unusual
- Conferences or meetings with the Contractor or the Contractor's field representative
- Agreements made with the Contractor
- Special notes regarding equipment or labor conditions, weather, or any other causes for delays
- Matters that might impact completion of the Contract

Book No. 2 can also be used to incorporate emails, photos, or other documents that the Project Engineer wants to include in the Permanent Final Records. As these records are kept forever, only include documentation that includes information outside of daily correspondence.

### 10-3.4 Inspector's Daily Report - Final Records Book No. 3

The Inspector's Daily Report (IDR) is a record of operations for a specific type of work on the project, such as surfacing, grading, paving, bridge, etc., which is being inspected by the writer. The IDR documents the normal work process completed each day and anything unusual that occurred on the project.

The first section of the IDR is a structured sheet of questions addressing identification of Work operations and the associated labor and equipment being used to accomplish the Work. Fill out the first section completely for all questions that pertain to the specific type of Work activity being inspected.

The second section is a narrative portion that should include a notation of any orders given or received, discussions with the Contractor, unusual conditions, delays in the operations, and the presence of any visitors. If an operation is being inspected which results in the partial payment of an item, the item should be identified along with the basis for calculating the partial payment. It is also of value to note the Project Inspector or Engineer's activities in the daily report.

Electronic versions of Inspector's Daily Reports are available depending on the application used during administration:

SharePoint - DOT Form 422-004 & 422-004A

Unifier - Use IDR forms built into the system

IDRs are required for each day any contractor is on-site or any chargeable working day and are submitted to the Project Engineer daily. Each page of the IDR will be stored electronically in the Permanent Final Records.

When necessary, the Project Engineer will add clarifying comments or remarks on the electronic copies of the IDR after they have been submitted. The Project Engineer will:

- Create a copy of the IDR
- Add clarifying comments or remarks to the document
- Initial and date all changes made
- Save the changed IDR using the original file name with "-amended"

## IDR Content

The IDR is intended to document communication, progress of Work, Contractor workforce/equipment and materials sampling/acceptance. The following are general rules for content of IDRs (including those created in Unifier):

1. The IDR is public record and may be called upon in case of litigation. The level of detail and professionalism exhibited may be of great benefit.
2. Do not make (or document) derogatory comments, as this is unprofessional behavior, and may be used to demonstrate that the inspector was hostile toward the Contractor and did not behave in a manner consistent with good faith.
3. All statements must be based on facts and requirements should reference the contract requirements.
4. All entries should be clear, concise, correctly spelled, concurrent and complete.
5. Summarize key points of any discussion of work activities with the Contractor.
6. Attach relevant photos to document the Work happening to ensure they are included with the IDR in the Permanent Final Records. Photos can be added to the IDR by including them with the written narrative of daily activities or electronically attached to the document.

Every photo taken does not need to be attached to the IDR, only photos that enhance the written notation for the Work activities performed that day or if unusual circumstances occurred.

7. Be specific when recording information about Work activities. Use drainage codes, exact bid item numbers, line and station limits, etc. Avoid referencing a co-worker's IDR, but if doing so, attach a copy.
8. Be specific when recording deliveries of materials to the project. Use bid item numbers, drainage codes, RAM number, etc. Record heat numbers, lot numbers, "Approved For Shipment" and "WSDOT Inspected" tags or stamps, etc. Using the IDR as materials documentation is acceptable. If used as documentation for acceptance, a copy of the IDR, with the appropriate items high-lighted, should be included with the materials documentation file.
9. Daily Equipment Status Reports should be complete and current.
  - Record all equipment, including any trailer or transport used to deliver equipment to the project.
  - Record the make, model and year of equipment. Request an equipment list from the Contractor and keep it updated. Photos make a good record of condition and configuration.
  - Record the exact bid item on which the equipment was working.
  - Understand the difference between down, idle, and standby time and use the correct term on the report.
  - Record crew composition (once a week or whenever it changes) along with the hours worked where practicable. This can be done on a separate IDR or in the narrative portion (page 2).

10. Record a chronology of events throughout the day, as they occur. Taking notes and transferring them to the IDR will work, but duplicates work and introduces an opportunity for error.
11. Record any potential delay, in as much detail as possible. Include start and end time, who was notified of the issue and when; along with any mitigating action by the Inspector or the Contractor.
12. Record every time the Contractor disagrees with a determination or protests a decision by the Project Engineer, and refer the Contractor to follow the process for protest as defined in the *Standard Specifications*.

### 10-3.5 Traffic Control Reports - Final Records Book No. 4

#### 10-3.5A Record of Collisions and Traffic Surveillance

Records of Accidents (now known as Record of Collisions) received by the Project Office are recorded by the WSP and are part of WSDOT's Transportation Data Office records (TDO), and do not need to be kept in the Temporary or Permanent Final Records.

If it is necessary to change traffic control as a result of a collision, the Project Office only needs to reference the Record of Collision report in the Project Construction Diaries or the Inspector's Daily Report. The Record of Collisions is only used during the life of the project to augment decisions on changing traffic control plans during construction. It should be noted that Section [SS 1-10](#), Temporary Traffic Control does not require a collision report be obtained for every collision that may occur within the project limits.

A separate file should also contain the records of traffic control surveillance prepared in accordance with Section [SS 1-10](#), Temporary Traffic Control. Information in this file should be kept current until completion of the Contract. When the Washington State Patrol provides the Project Engineer with traffic control assistance they also provide the engineer with a WSP Traffic Control Checklist [DOT Form 421-045](#). While this form is a part of the traffic control operations, it can be kept separately and made part of the Temporary Final Records.

#### 10-3.5B Contractor's Daily Report of Traffic Control

The Contractor's Daily Report of Traffic Control ([DOT Form 421-040A](#) and [421-040B](#)), completed by the Contractor's Traffic Control Supervisor, is also included as part of the project's Permanent Final Records. The Contractor's Daily Report of Traffic Control is discussed in more detail in Section [SS 1-10](#), Temporary Traffic Control.

### 10-3.6 Pile Driving Records - Final Records Book No. 5

Pile Driving Record Book [DOT Form 450-004](#) or Pile Driving Log [DOT Form 450-004A](#), if used, is a part of the Permanent Final Records. The requirements for pile driving and pile driving records are further detailed in [Chapter 6](#).



### 10-3.7 Post Tensioning Records - Final Records Book No. 6

Post Tensioning Record Book DOT Form 450-005, if used, is a part of the *Permanent Final Records*. The requirements for post tensioning and post tensioning records are further detailed in [Chapter 6](#).

### 10-3.8 Contamination Material Records - Final Records Book No. 7

Contamination records document the disposal of contaminated materials.

### 10-3.9 Miscellaneous Records - Final Records Book No. 8

Miscellaneous Records are optional records and may be included in the permanent records at the Project Engineer's discretion. This part of the permanent records is intended to allow for inclusion of records that might be considered of added importance by the Project Engineer. Optional records could include the following:

- Photographs – photos of special features or construction methods.
- Traffic Information – information on openings to traffic.
- Ceremonies – reports on dedication activities.

Miscellaneous Records that must be included in Book 8 are:

- Environmental Contamination – records or documents on environmental contamination. Disposal records of contaminated materials are placed in Book 7.

*Documents placed in the Permanent Final Records are retained forever and are subject to public disclosure requests.*

### 10-3.10 As-Built Plans and Shop Drawings

As-built plans are a record of changes made to the originally intended physical product of the Contract. As-built plans reflect the same degree of detail as the original plan drawings, and preserve the historical detail of what occurred on the project. As-built plans can also be used as a basis to plan and design future projects in the same location and to make repairs to damaged structural components or other non-functioning facilities. In addition, state law requires that owners of “underground facilities” be able to locate these facilities within 24 inches of the outside dimensions. As-built plans offer a convenient means for recording these facilities.

#### 10-3.11A Preparing As-Built Plans

As-built plans are prepared as electronic flattened PDF files. A full set of the Contract plans are available on the Active Contract Directory ([FTP DIRECTORY](#)). This set of plans can be used by the Project Engineer for the purpose of preparing as-built plans. Contract plans that are locked can be flattened by printing to PDF (for best results, select the option “Choose paper source by PDF page size” under Page Sizing & Handling:

Figure 10-3.11A-1

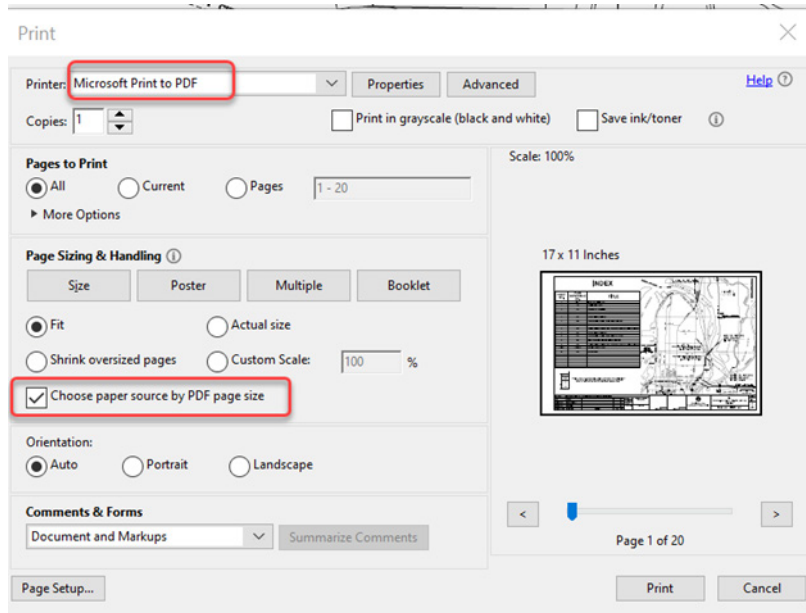

All corrections, repairs, revisions and additional details necessary to depict the Work as it was constructed shall be shown on the as-built plans, whether considered the practice of engineering or not and whether considered a change to the Contract or not.

Corrections to existing plans are to be made by lining out quantities or features that were changed during construction, then noting the correction or change in red. Note corrections and revisions on the plans in a manner that results in neat and legible sheets. Use medium width line styles when making changes or corrections to plan sheets. If desired, the changes may be further identified by placing them in a “cloud” symbol.

Include the most current version of additional or replacement plan sheets from change orders in the as-built plans. The changes shall be clearly marked by methods that may include revision numbers, clouding or other means and need not be made in red.

Changes shown in as-built plans shall include a reference to the appropriate change order number, if applicable.

Note construction changes on all Contract plan sheets that were affected the by the change. For instance, the change in location of a catch basin or manhole may affect the location listed in the structure note sheet, the drainage plan view sheet, and the drainage profile sheet.

As-built plans for Design-Build Contracts must meet the same requirements as any other set of as-built plans, unless specifically stated otherwise in the Contract documents. This is to include formatting, file size, and naming conventions.

If concrete foundations are partially removed, show the remaining portions of the foundations on the as-built plans. It is not required that the as-built, Summary of Quantity sheets be revised to reflect final estimate quantities. Summary of Quantity sheets reflect original plan quantities which are shown as preliminary estimates of the Work. Final as-built quantities for individual unit bid items can be obtained from the final CAPS ledger for the project.

In order to help identify changes in Work location or changes in the Work completed at a particular location, the Quantity Tabulation and Structure Note sheets must be updated to show the actual physical feature items or the locations of installations where changes were made. Changes may include revisions to guardrail, guardrail termini, post types, anchors or anchor types, revisions to monuments, structure notes that were added or revised, pipe size and types that were changed, revised locations for catch basins, manholes, etc. The intent is to show what changes to the planned Work were made. Changes to quantities of items used which increase or decrease the original quantities by more than 25 percent and items added or deleted at a particular installation, shall be updated. Final as-built quantities for the individual unit bid items can be more accurately obtained from the final CAPS ledger for the project.

In addition to the requirements outlined above for as-built plans, the *Standard Specifications* also require that the Contractor furnish the Project Engineer with an electronic copy of: shop drawings, schematic circuit drawings, prestressed structural elements, structural steel components, etc. to be included with the electronic copy of the as-builts. Refer to the *Standard Specifications* for specific requirements of each plan.

### **As-Built Plans for Bridges and Structures**

Changes shown in as-built plans considered practice of engineering and also a change to the Contract shall include the signed and dated seal of the Engineer-of-Record approving the change. Changes shown in as-built plans considered practice of engineering but not a change to the Contract shall include a reference to the licensed Professional Engineer who evaluated the change and the date of their recommendation. See Section [SS 1-04.4](#) Changes/Responsibility of Licensed Professionals for Changes to Structural Engineered Drawings During Design-Bid-Build Construction Contracts for reference.

Prior to submitting the as-built plans to Engineering Records, the Project Engineer shall submit a draft version to the Bridge and Structures Office for review. The Bridge and Structures Office will compare the draft as-built plans with their construction support records, and will inform the Project Engineer if any discrepancies are noted. Please allow 30 days for this review process.

#### **10-3.11A(1) Requirements for Submitting Electronic As-Built Plans and Shop Drawings**

As-built plans and shop drawings can be electronically transferred as PDF files into the designated download site shown below. For each Contract that is submitted electronically, a Region staff member must be responsible for:

- Verifying that all necessary documentation is complete,
- Uploading all electronically transferred as-built content into the Electronic Content Management System (ECM)
- Verifying that the as-builts are available to view in the ECM before deleting the Region's copy of the electronic as-builts

**Format** – PDF

**Dpi** – 300

**Size** – 11 in × 17 in (capable of printing full size plan sheets)

**As-Built Plans** – Mark each sheet with “FOR AS-BUILT PLANS ONLY” or “FOR AS-CONSTRUCTED PLANS ONLY”. This mark can either be a grey watermark applied to each sheet or stamped in red to each sheet.

**As-built Sheet Contract Numbers** – Each sheet should have the Contract number applied, for example, “1234”.

**Naming Convention** – Each PDF document must be named using the Contract number, for example, “001234.pdf”. If the Contract is large, you would need to break it up in volumes no greater than 50 Mb each. An example of PDF naming with the Contract number and volume for volume 1 of a 10 volume set would be “001234-Vol-1-of-10.pdf”. An example of PDF naming for volume 10 of a 10 volume set would be “001234-Vol-10-of-10.pdf”.

**As-Built Cover Sheet** – The first page of Volume 1 will be a completed As-Built Cover Sheet, DOT Form 722-025, which will be used to key in the metadata. Fill out the form electronically and include it as the first page of Volume 1. WSDOT Form 722-025 shall be signed and sealed by the Project Engineer.

**Design-Bid Build P.E. Stamps and Signatures** – All appropriate WSDOT P.E. stamps and signatures as shown in awarded Contract Plans must be shown on the as-builts plans.

**Design Builder P.E. Stamps & Signatures** – All appropriate Design-Builder P.E. stamps and signatures as shown in the Released for Construction (RFC) plans must be shown on the final as-builts.

**ILINX Capture of PDF Files** - Upload PDFs to the ECM using the ILINX Capture for As-Builts. Refer to the ECM Construction User Guide for additional information.

### 10-3.12 Final Record Field Notebooks

Field notebooks are bound books of notes that are used for specific kinds of work such as alignment notes, grading notes, pile driving notes, etc. Field notebooks can also consist of loose leaf field notes that have been bound together into books as well. Records that appear in the field books should not be duplicated and placed in other final record books. The only exception to this rule is copies of Field Note Records with multiple item numbers which may be copied as described in [Section 10-4.3](#).

Field notebooks should be consecutively numbered and each should have the pages numbered beginning with number one. Typing information in the field book is not necessary as hand lettering is preferred. As with other project records, erasure corrections of any kind are not permitted.

The quantities for payment for each item of Work in the field notebook shall correspond directly to entries in the CAPS project ledger. Adequate cross-referencing must be made between the field notebook and the project ledger in order to trace item quantities and entries from one to the other.

The field notes should show the initials of the persons or person making them, the date, and the weather conditions if appropriate. In some cases, different stages of Work will be noted on the same page, such as staking, measurement, and construction. This would require dates and initials at each stage of work. The notes shall also show the dates that quantities are computed and checked along with the initials of those persons doing the work. In all cases, field notes should be neat and legible and show all necessary information. [Figure 10-4](#) and [10-5](#) show sample field notes and summary for clearing.

Sketches should be shown when necessary to compute a quantity that cannot be computed from the As-Built Plans. Sometimes structure excavation sketches are helpful for determining the pay limits and computing the volume; other sketches are helpful on special details.

Current business practices provide for electronic calculation and storage of all types of detailed surveying data, quantity calculations, etc. Data forms for template input, calculation setup, forms for direct recording of field information, storage media for electronic files, as well as output for the calculated data shall all be treated as an original source documents. See [Section 10-3.13](#) for further direction in regards to electronic data.

Remeasure cross section notes, where a deviation from the established roadway section or slopes has occurred, should be indexed carefully so that they can be identified readily with the original cross section. For convenience of calculation on remeasure, plotted cross sections may also be used.

Structure and drainage notes in the Final Record Field Notebook should show the stationing, distance left or right, angle or skew if applicable, flow line elevation and grade in the case of culverts, drains and ditches, and all information necessary for computation of the pay items involved in the construction. For convenience, it is recommended that all pay quantities pertaining to the construction of items listed on the Structure Notes sheets of the plans, be shown in the field book with structure note number, item number, and quantities, and that cross-references be used to show where the totals were obtained. It should be remembered that quantities must be segregated by group number as shown in the summary of quantities contained in the contract plans.

For use as an example, [Figure 10-6](#) and [10-7](#) show the front and back of a completed field note for the installation of a reinforced concrete sewer pipe.

### 10-3.13 Electronically Produced Documents

There are many computer applications available for use on a WSDOT highway construction project. Included are programs for earthwork quantities, mass diagrams, basic cut and fill, geometrics, surveying, and for determining structural quantities. In addition, there are many other “stand alone” applications created by individuals in each office for use on personal computers that are also recognized for these kinds of uses.

When electronic computations are used, the output generated must be bound together and identified with a title sheet for final record purposes. These documents are to be made a part of the three-year *Temporary Final Records* retained by the Region as explained in [Section 10-3.1](#). When a computer program is used to calculate quantities for payment, the summary sheets containing the quantities entered in the project ledger must be treated as source documents with all required signatures, dates, ledger entry number, and sufficient cross-referencing to provide a good audit trail.

### 10-3.14 Photographs

A detailed photographic record is an important part of the project documents. A photographic record could consist of filmed photographs, digital photos, infrared photographs, video, etc. A photographic record should be taken of unusual equipment, construction methods, problem areas, areas of possible controversy, traffic control, and especially conditions in the area of an accident. In addition to these are “before” and “after” views taken from the same vantage point. These are particularly useful in

documenting the progress of work. When photographs are to be maintained as a part of the project documents they must be fully identified. Photographs should clearly note when they were taken (date and time), where they were taken, and who took the picture. Although photographs are placed in the category of three-year *Temporary Final Records*, some regions have extended the Region retention period for photographs or have even included them as a part of the project's *Permanent Final Records* for permanent retention.

### 10-3.15 Pre-Estimate Reports

A pre-estimate report prepares the CAPS system to make an estimate payment. This report provides the opportunity for the Project Office to preview the estimate and is a means to allow for any corrections or deferments to be made before actual payment. The corrected pre-estimate report used to make a progress payment must be signed by the Project Engineer in order to indicate authorization for payment. The signed pre-estimate report must be retained in the project files and become a part of the three-year *Temporary Final Records*. For additional information regarding progress payments and the CAPS system, see Section [SS 1-09.9](#), Payments.

### 10-3.16 Estimate Reports

When a payment is made to the Contractor for a progress or Final Estimate, the Project Office receives a copy of all the reports that are sent to the Contractor along with the warrant. The Contract Estimate Payment Advice report and the Contract Estimate Payment Totals report should be compared to the pre-estimate report verifying that the amount actually paid is the same as the amount authorized. These estimate reports should be kept with the completed pre-estimate reports in the project files, and become a part of the three-year *Temporary Final Records*. For additional information regarding progress payments and the CAPS system, see Section [SS 1-09.9](#), Payments.

### 10-3.17 Final DBE Utilization Plan Report

The Final DBE Utilization Plan Report (DOT Form 272-055) is required on all projects that include DBE requirements and must be accompanied by a report of the final amounts paid to DBE's. Most likely, this will be a final report from an electronic DBE payment system (DBEP, B2GNow, etc.). The signed "Final DBE Utilization Plan Report" and the attached final amounts paid report become part of the three-year *Temporary Final Records* retained by the Region. The form may be signed by the Project Engineer, Region Construction Engineer or the Region EEO officer.

The Final DBE Utilization Plan Report represents a certification that on-site performance has been monitored, and signing it indicates that all DBE On-site Reviews are complete, on file, and can be retrieved as supporting documentation for the certification.

This certification is a requirement of 49 CFR Part 26.37(b).

## 10-4 Project Ledger System

### 10-4.1 General

The Contract Administration and Payment System (CAPS) provides both an accounting and payment system, while also acting as an information collection system. The CAPS program uses an electronic project ledger that is maintained current throughout the life

of the project as the backbone of the system. All items of work on a project for which payment is made must be entered into the electronic project ledger. Items posted in the ledger become the basis for payment and summary record document for dollars paid to the Contractor, quantity of work performed by the Contractor, status reports during the active life of the contract, and are also used as the basis for final reports when the project is completed.

As work is completed on the project, the project office continuously enters those quantities into the ledger; those records then become eligible for payment when the next progress estimate is due. Processing of monthly progress and project final estimates is further detailed in Section [SS 1-09.9](#), Payments. With the ledger entries completed, the application compiles all those records eligible for payment and transfers the data to the payment portion of the CAPS system. Because of the system's ability to store information it is also used as an extensive resource for corporate information regarding the construction program and is used extensively by many other groups throughout WSDOT.

All electronic data incorporated into the CAPS system is stored on either an active file or a history file. These files are both permanently retained and are available for use whenever the need arises. It is not necessary, or intended, that paper copies of the project ledger be retained for final records.

Detailed instructions for the use of the CAPS system can be found in the [CAPS Manual](#) available on-line at: [wwwi.wsdot.wa.gov/Accounting/Manuals/CAPSManual.htm](http://wwwi.wsdot.wa.gov/Accounting/Manuals/CAPSManual.htm)

A key function of CAPS is to provide a complete accounting trail for every pay item. An accounting trail must be clearly maintained from the original source document through the actual payment to the Contractor. Audits are an effective tool used by both state and federal governments to ensure established procedures and processes are correctly used to maintain the most effective use of the public's funds. It is important that WSDOT maintain sufficient records and documentation to clearly identify an accounting trail that is capable of withstanding the test of audits.

In order to satisfy the requirements of an accounting audit, the following conditions must be met:

- There must be a source document for every ledger entry and vice-versa.
- There must be an orderly filing system to facilitate timely retrieval of source documents.
- Both Interim Progress Estimate and Final Estimate reports must be signed by the Project Engineer.
- The Contract Estimate Payment Advice report must be filed along with its corresponding Progress Estimate report.

### 10-4.2 Source Documents

Each ledger entry must be supported by a detailed source document, which specifically identifies the type, amount, and location of the work or material that is being entered into CAPS for payment. Source documents used to support these entries are intended to be complete documents, documents that stand alone, and fully support the payment that is being made. If information from other documents is used in the source document, these additional document(s) must be clearly identified in order to complete the audit trail.

Some examples of source documents include Item Quantity Tickets, Field Note Records, and Force Account sheets. Source documents are the beginning of the audit trail. They show that a WSDOT Inspector has observed and determined the amount of work performed by the Contractor. Also, the source document must show that all calculations have been checked by a second WSDOT employee to ensure they are correct.

Source documents must show four sets of dated initials or full names for each person who:

- (1) completed the original calculations,
- (2) checked the original calculations,
- (3) entered the payment quantity/amount in the CAPS ledger, and
- (4) verified the CAPS ledger entry.

*For Unifier documents, the audit log meets the requirements listed above.*

In addition, the source document must also show the ledger entry number.

All of the checks and initials or names noted above must be complete prior to payment to ensure that information entered into the CAPS ledger is accurate. It is not appropriate to complete any of these checks after payment is made.

Ledger entries for estimates of monthly progress quantities for grading, lump sum, or other such items must also be supported by a source document. Among other things, the source document must show the method used for determining the estimate. These methods and source documents must lead to an accurate measurement after the item of work has been completed. For lump sum items, the field notes or diaries can show an estimated percentage of work completed. If this percentage method is used, then a brief discussion outlining the basis for the calculation and any assumptions that were used should also be included.

Many project offices use electronic data collectors for surveying work. These data collectors eliminate the need for hand prepared field transit and field level books. Many project offices have also developed or routinely use other electronic programs or applications, which perform calculations and produce a report of the results. In using these applications there can be confusion regarding the need for checking data that has been compiled and reported electronically. In the absence of specific direction, when an electronically produced record or set of notes is used as a source document for a contract payment, the individual who originated the document should be noted. A second person can then check both input and output for both reasonableness and accuracy. This check may range from duplicating the process to verifying the input. Whatever the case may be, it is recommended that the dated initials of those two individuals be on the source document.

### 10-4.3 Source Document Filing Systems

Basic criteria for a good Source Document Filing System would include ease of set up, ease of use, and the capability to retrieve any specific document in a timely manner. The source document filing system should also be set up to coordinate easily with final records requirements. The filing system described here for source documents is not mandatory. However, it is presented as one alternative that works well with the CAPS electronic ledger system, the final records process, and is easy to use. The unique ledger entry number from CAPS makes this method work. Files are set up in two books or sets of notes. The first book is organized by Unit Bid Item Number and the second book



is organized by Structure Note Number. Source documents are filed by Unit Bid Item Number except for drainage items, which are filed by Structure Note Number. With this method there is only one item per source document except for the drainage items. Drainage items are filed by Structure Note Number because their source document (field note record) normally has multiple items while the Structure Note Number is unique to a specific drainage facility. For all other items, if more than one item appears on a source document, a copy is made for each item noted, the desired item number is highlighted, and then the copy is filed behind their respective Unit Bid Item Number locations. This works extremely well if the source documents are placed in order by date in their respective files.

To look at the source document for a ledger entry, simply note the item number, entry number, and date; go to the file and look for the entry number within the item file. If files are maintained in order by date, this is made even easier. For ledger entries of drainage items, it is necessary to include the structure note number in the remarks section.

This system allows anyone to easily locate the source documents that support a contract payment. These records are retained in the Project Office until Final Record time when the source documents are bound into books with their respective titles and made a part of the three-year *Temporary Final Records*.

## 10-5 Region Project Documentation Reviews

### 10-5.1 General

The Region is responsible to ensure that reviews of record keeping and documentation procedures are completed during the progress of the work. This will help to ensure that the original field records and pay notes are being properly prepared and that proper procedures are being followed. The Region should review specific pay items for correctness of the payments made as well as for procedural requirements for documenting and processing of contract payments, acceptance of materials and other pertinent contract administration requirements. Reviews of specific pay items should be recorded on [DOT Form 421-014](#). Reviews of procedural items should be recorded on either [DOT Form 230-036A](#) or [230-036B](#). Version A should be used for the first review made on a project. Version B places more emphasis on individual pay items and should be used for the second review or on larger projects during the initial review phase where this emphasis is more appropriate.

On projects that are estimated to cost more than \$1,000,000, and require more than 35 working days to construct, the Region should conduct an interim documentation review when the project is approximately 50 percent complete. This review should be thorough and complete to ensure that the documentation records are adequate and are being properly maintained. This review should include both procedural checks for those items listed on [DOT Form 230-036A](#) and detailed reviews of specific pay items for accurate documentation practices of contract payments completed to date. Audit work for pay items may also be started at this time in preparation for the Final Records general Review at Physical Completion. This early audit work could consist of checking any individual items that have been fully completed. Reviews of completed items that are recorded on [DOT Form 421-014](#) can be kept and then made a part of the Final Records check upon Physical Completion. Once the project has been completed, information from both procedural reviews and specific pay item reviews can then become a part of the *Temporary Final Records*.

On projects that are estimated to cost more than \$500,000 and require more than 100 working days to construct, the interim documentation review should be considered as early as 30 percent completion but, where possible, no later than 50 percent completion. On these larger projects, it is particularly important that the interim reviews be sufficient to verify both documentation and procedural practices. However, on many projects, the nature of the work completed at 30 percent may not provide an adequate representation of the documentation procedure to merit a documentation review. In these instances, the Region should exercise considerable judgment regarding the timing of interim documentation reviews.

The Region reviewer should also exercise considerable judgment in deciding whether or not to perform additional documentation reviews in conjunction with the reviews described above. In addition to cost and time, other criteria should also be used to evaluate the need for additional documentation reviews. This could include results of previous documentation reviews as well as the history, knowledge, and experience of the specific Project Office personnel involved. The Region reviewer should be satisfied on a case-by-case basis that each project's records are adequate and are being properly maintained.

It is recommended that each time a documentation review is performed on a project the Region reviewers discuss the results of the review with the Project Office staff, leaving a completed copy of DOT Form 230-036 and [421-014](#) to be included in the project temporary records.

### **10-5.2 Review Procedures for Final Estimates and Final Records**

When work on the project is physically complete, it is important that the final records be completed and assembled in as timely a manner as possible. The final quantities should be checked and the final estimate or Final Contract Voucher Certification furnished to the Contractor as soon as is reasonably possible.

In order to facilitate this, the Project Engineer should ensure that the overall project final records, including the final contract quantities, are made ready for Region review as timely as can be and that the Region has completed their review work shortly thereafter.

The Region is responsible to ensure that the final records for the contract are complete, accurate and maintained in an orderly manner. The Region may exercise considerable judgment regarding the procedures used for this check. These procedures may include a complete check of all records or a representative sampling of records in order to validate all records maintained. If problems are discovered during the review of the representative sample, and if those problems indicate that the entire population might be flawed, then the entire population should be checked and corrected by the field office and a new representative sample taken. In conducting these final reviews the Region reviewer should mark the areas that have been checked, initialing and dating the records or portions of records that have been reviewed. The Examination Sheets for Contract Items [DOT Form 421-014](#) and Documentation Review (Procedures) [DOT Form 230-036A](#) and [230-036B](#) should be kept until the contract final records check is completed and then filed with the *Temporary Final Records* where they can be further reviewed should an audit occur.

Figure 10-1



**Washington State  
Department of Transportation**

## Item Quantity Ticket

Date *	Location	Group
Remarks		
Time Received	<input type="radio"/> AM <input type="radio"/> PM	Time Weighed
Received By *	Weighed By	
Pit Number	Truck Number *	
Check One *  <input type="radio"/> Tons <input type="radio"/> Hours <input type="radio"/> Cu. Yds. <input type="radio"/> M. Gal. <input type="radio"/> LBS. <input type="radio"/> Each <input type="radio"/> Days	Legal Gross Weight	
	Gross *	
	Tare *	
	Net *	
Other Unit of Measure	This Load	Total

Item Identification	
Contract Number *	Item Number *
Item Description	
Subcontractor	
Contractor	
<b>* Required Information</b>	Ticket Number

DOT Form 422-021  
Revised 4/00

Figure 10-2

**Contract #6767  
Johnson Creek Bridge 112/38  
Columbia Basin Region  
Final Records Book 1**

Item	Section
Index of Final Records Books	1
Listing of State Personnel	2
Comparison of Quantities	3
Listing of Change Orders	4
Record of Construction Materials	5

Figure 10-3

<b><u>Contract # 7767</u></b>	
<b><u>Johnson Creek Bridge 112/38</u></b>	
<b><u>Columbia Basin Region</u></b>	
<b><u>Permanent Final Records</u></b>	
<b>(Retained at HQ Records Services)</b>	
<b><u>Book Description</u></b>	<b><u>Book No.</u></b>
Final Records Book No. 1	1
Construction Project Diaries	2
Inspector's Daily Reports	3
Traffic Control Reports	4
Pile Driving Records	5
Post Tensioning Records	6
Contaminated Materials Disposal Bills	7
Miscellaneous Records	8
As-Built Plans (Submitted under separate cover dated 08/10/2000)	
<b><u>Temporary Final Records</u></b>	
<b>(Retained Within the Region)</b>	
<b><u>Description</u></b>	<b><u>Book No.</u></b>
Item Quantity Tickets	9
Project Engineer's Copy of Estimates	10
Inspector's Record of Field Tests	11
Scale Test Report	12
Concrete Pour Records	13
Field Note Records	14
Drainage Notes	15
Approval of Source of Materials	16
Daily Report of Force Account Worked	17
Other Source Document Files	18
Quarterly Report of Amounts Credited DBE Participation	19
Quarterly Report of Amounts Paid MBE/WBE Participation	20
Contractor's Payrolls (Fed-Aid Projects)	21
FHWA Form 1589 (ARRA Projects)	22
Alignment (Transit) Book	23
Grade Book	24
Cross Section Notes	25
Quantity Computation Sheets	26
Record of Field Audits	27
Surfacing Depth Checks	28
Washington State Patrol Field Checklist	29

Figure 10-4



**Washington State  
Department of Transportation**

## Field Note Record

Contract No. <b>4747</b>	Station <b>SEE DETAIL</b>	Line <b>L-LINE</b>	C/S <b>2316</b>
Staked By <b>M. Lewis</b>	Date <b>2-12-98</b>	Work Started <b>2-5-98</b>	Work Completed <b>2-9-98</b>
Calculated By <b>J.P.</b>	Date <b>2-14-98</b>	Checked By <b>CB</b>	Date <b>2-15-98</b>
Inspector's Signature <b>John Smith</b>		Date <b>2-9-98</b>	

**CREW: LEWIS M, BARNES, TOMS**  
**WEATHER: CLEAR, COOL**

**CLEARING & GRUBBING**

**GROUP 1 TOTAL      21172 M<sup>2</sup> FROM REVERSE SIDE**  
**= 2.12 HECTARES**

**GROUP 2 TOTAL      14609 FROM PAGE 4**  
**= 1.46 HECTARES**

**PROJECT TOTAL      = 3.58 HECTARES**

Item No.	Material	Manufacturer	Brand Name Model/Type	RAMS/QPL Ref. No.	Appr/Accept Code	Basis of Acceptance

Item No.	Item Description	Group	Date Work Completed	Unit	Quantity	CAPS Entry No.	Posted By		Checked By		Est. No.
							Initials	Date	Initials	Date	
<b>2</b>	<b>CLEARING &amp; GRUBBING</b>	<b>1</b>	<b>2-9-98</b>	<b>HECTARE</b>	<b>2.12</b>	<b>7</b>	<b>AS</b>	<b>4/16</b>	<b>CR</b>	<b>4/20</b>	<b>1</b>
<b>2</b>	<b>" "</b>	<b>2</b>	<b>2-9-98</b>	<b>HECTARE</b>	<b>1.46</b>	<b>8</b>	<b>AS</b>	<b>4/16</b>	<b>CR</b>	<b>4/20</b>	<b>1</b>

DOT Form 422-635 EF  
Revised 3/98

Page No. \_\_\_\_\_



Figure 10-6



Washington State Department of Transportation

Field Note Record For Drainage

Book No. \_\_\_\_\_ Page No. \_\_\_\_\_

Contract No. 4747	Station 62+170 to 62+220	Line L LINE	C/S 1701	Code Number 9-15
Staked By T. ROBERTS	Date 1-12-98	Work Started 1-16-98	Work Completed 1-24-98	
Calculated By TMC	Date 1-26-98	Checked By DEM	Date 1-30-98	Inspector's Signature C. Stakes
		Date 1-24-98		

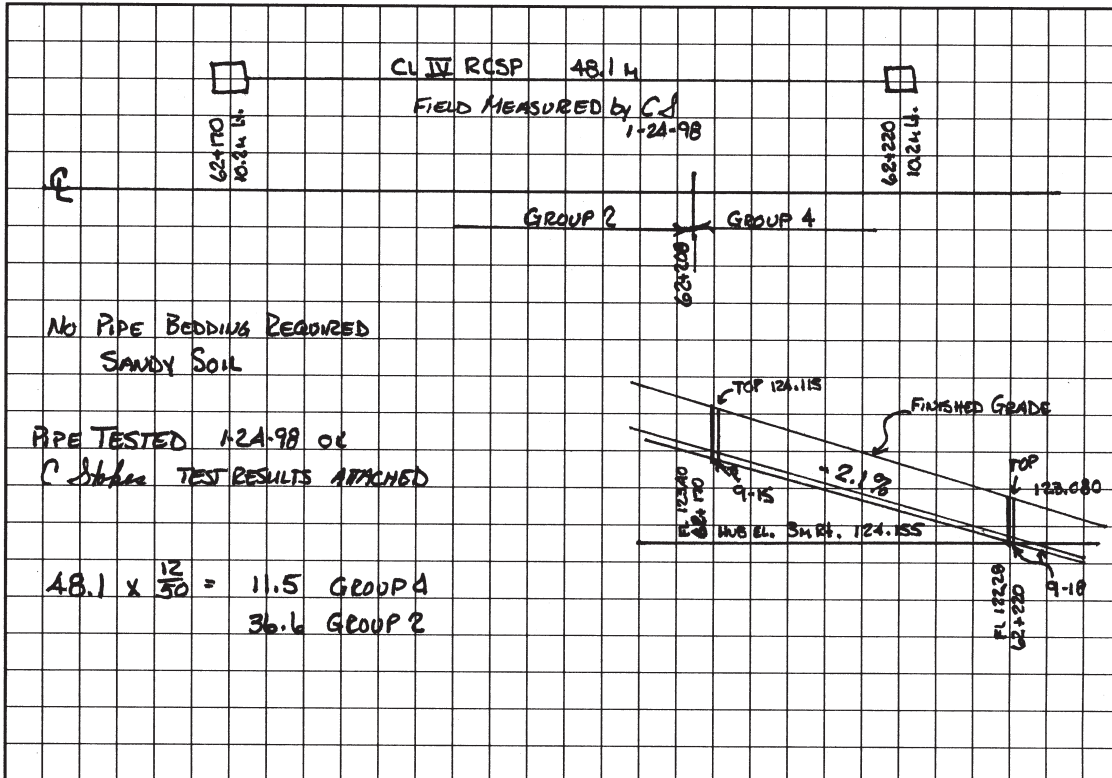

Item No.	Item	Group No.	Date	Unit	Quantity	RAMS No.	Basis of Material Acceptance	CAPS Entry No.	Initials		Est. No.
									Post	OK	
7	STR. EXC. CL. B	2	1/8/98	M <sup>3</sup>	17.6			53	DS 1/19	CR 1/20	1
7	" " "	4	1/8/98	M <sup>3</sup>	6.7			54	DS 1/19	CR 1/20	1
24	CL IV RCSP 300MM	2	1/24/98	M	36.6	4063	TAG # A123A56	76	DS 1/25	CR 1/26	1
24	" " "	4	1/24/98	M	11.5	4063	TAG # A123A56	77	DS 1/25	CR 1/26	1
25	TESTING SEWER PIPE	2	1/24/98	M	36.6			78	DS 1/25	CR 1/26	1
25	" " "	4	1/24/98	M	11.5			79	DS 1/25	CR 1/26	1
26	C.B. TYPE 1	2	1/24/98	EACH	1	4063	TAG # A123A56	80	DS 1/25	CR 1/26	1

DOT Form 422-637 EF  
Revised 9/97





Figure 10-8



**Washington State  
Department of Transportation**

## Field Note Record

<b>Contract No.</b> C7616	<b>Station</b> Project Limits	<b>Mile/Line:</b> SR 26	<b>C/S</b> 0134 - G1/ 3830 - G2
<b>Staked by</b> Jason Lefler 3/23/2009		<b>Work Started Date</b> 4/27/2009	<b>Work Completed Date</b> 4/27/2009
<b>Calculated by</b> Jason Lefler 4/27/2009		<b>Checked by</b> Sean Carpenter 5/6/2009	<b>Inspector</b> Jason Lefler 4/27/09

One Type B Guardrail Connection installed at each bridge corner; 4 total.

Group 1  
Station 299+93 Left and Right = 2  
Pay 2.00 each

Group 2  
Station 302+43 Left and Right = 2  
Pay 2.00 each



Item Num	Material Brand Name/Model Type	Manufacturer	RAMS/QPL Ref. No.	Appr/Acc Code	Basis of Accept	Acceptance	
						Date	Init.
019.01	9-16 Fence and Guardrail W and Thrie Beam + componants	Trinity Highway Products, LLC	QPL-0012	3002	Document conformance to approved plan	04/27/09	JL
019.02.00	9-09 Timber and Lumber	Superior Wood Treating	QPL-0013	2110	Verify Cert of Treatment and Lumber Grade Stamp.	04/27/09	JL
019.02.02	Steel Fasteners Threaded Rods,Nuts,and Washers	Portland Bolt and Mfrg	QPL-0022	2015	Verify Product along with MCC and CMO	04/27/09	JL
019.02.03	9-26 Epoxy Resins Acrylic Tie (AT)	Simpson Strong Tie Co., Inc.	QPL-0021	3008	Visually Verify Product	04/27/09	JL

Item Num	Item Description	Grp	Date Work Complete	Unit	Quantity	Ledger Entry No.	Posted By		Checked By		Est. No.
							Init.	Date	Init.	Date	
0019	TYPE B GUARDRAIL CONNECTION	1	4/27/2009	EACH	2.00	48	rah	05/07/09	TH	05/07/09	
0019	TYPE B GUARDRAIL CONNECTION	2	4/27/2009	EACH	2.00	49	rah	05/07/09	TH	05/07/09	

**Attachments**

File Attachment

DOT Form IP 422-635ER EF  
Revised 2/2009

Figure 10-9

**IDR Sheet 1 of 3 Sheets**



**Washington State  
Department of Transportation**

## Inspector's Daily Report

Contract C7762	SR Nos. SR 206	Day Tuesday	Shift Day	Date 7/28/2009
-------------------	-------------------	----------------	--------------	-------------------

Weather  
AM  PM

Prime Contractor A. Inland Asphalt	Representative/Title Tony Via		
Subcontractor or Agent a Northstar	Appr'd y	DBE y	Representative/Title Jeremy Simpkins

**Work Activity Summary**  
Description and Location

Installing Class A construction signs.

**Pay Note Made Today?**

No - Work not complete. Will complete Paynote on completion or at estimate cutoff.

No - LS Item. Work is not completed. Will complete paynote on completion or percentage at estimate cutoff.

**NOTE:** Any "No" will be explained in Diary.

Required Backup Samples Taken

Mats Documentation Approved

Mats Source Approved

Item No.	Contract Item Description	Location	Y/N	Y/N	Y/N	Y/N
41	Construction Signs Class A	Throughout project	NA	No	NA	No

**File Upload**

File Attachment

**Contractor's Equipment**  
Operating Contractors Id (A-E Above)

No.	Equipment - ID No. and Description	Opr	Stdby	Down	Idle
a 1	GMC 3500 20,000 GVW flatbed truck, #45A	8			
a 1	Dodge 1500 pickup, #39A	6			
a 1	20 foot flatbed trailer #18	8			

**Contractor's Workforce**  
Operating contractors ID(A-E see above)

No.	Number/Hours								Number			
	Laborers	Carpenters	Operators	Teamsters	IronWorkers	Masons	Flaggers	Electricians	Male	Female	Appr	Trnee
a 4	32						1	3	4	1		

**Traffic Control**

Was Traffic Control Labor Required Today?  Yes  No

Was WZTC according to approved TCP?  Yes  No

Photos/Video taken Today?  Yes  No

Do all Flaggers and Spotters have current flagging card?  Yes  No

Inspector's On Site Hours

From	<input type="text" value="9:00 am"/>	Inspector
To	<input type="text" value="2:30 PM"/>	Reviewed By

DOT Form IP 422-004 EF  
Revised 3/2009

Reviewed by  **C.I./P.M.**  **A.P.E.**  **P.E.**  **O.E.**

Figure 10-9 (continued)

**IDR Sheet 3 of 3 Sheets**



Washington State  
Department of Transportation

## Inspector's Daily Report

Contract C7762	Day Tuesday	Date 2009-07-28
-------------------	----------------	--------------------

**File Upload**

File Attachment

DIARY - Including but not limited to: a report of the day's operations, time log (if applicable), orders given and received, discussions with contractor, and any applicable statements for the monthly estimate.

Northstar called the office this morning at 8:30 with questions about the Class A signing. This was the first we heard that they were working today. Northstar still does not have an approved traffic control plan for short duration shoulder work.

I met the installation crew on the jobsite around 9:00 am and answered their questions. A couple of stakes had been knocked over which I located and set back in place.

Kevin Littleton and Chad Swenson visited the site to evaluate the proposal to not grind out the shoulders between US 2 and Yale rd. to avoid adjusting the drainage structures.

Spent the day on site answering questions from the sign installation crew and working on documentation.

Off site at 2:30 PM

Gordon Hurt  
Inspector

## 11-1      **Introduction**

This chapter acquaints engineers and inspectors with the various forms provided by WSDOT for keeping records of construction activities, payment for the various phases of the work and establishes policy related to the use of signatures as they relate to highway project construction contract administration.

This Chapter contains a list of forms available for use when reporting project progress. Copies of the forms are available via two different methods:

- The WSDOT internal Forms website accessible from the intranet homepage.
- The WSDOT external website at [www.wsdot.wa.gov/forms](http://www.wsdot.wa.gov/forms).

## 11-2      **Definitions**

**Electronic Signature** - as defined by [RCW 19.360.030](#) and the Universal Electronic Transaction Act (UETA) means an electronic sound, symbol, or process attached to or logically associated with a Contract or other record and executed or adopted by a person with the intent to sign the record.

- A document that was signed by hand and then scanned and transmitted by the signer meets the definition of electronic signature. Furthermore, it shows consent to conduct that transaction electronically as required by the RCW.
- Creating a PDF by scanning a document received from the Contractor with a wet signature does not show intent and consent to conduct business electronically and is not acceptable.

## 11-3      **General Instructions**

Downloading forms using one of the methods listed in [Section 11-1](#) will ensure the latest version of the form is utilized.

Forms are listed numerically in this chapter and are categorized by either requiring a Signature (Electronic or Digital) or those that are acceptable without. Project Office personnel will need to review the forms to familiarize themselves with the signature requirement of each form.

### **Signatures**

[RCW 19.360.030](#) requires consent from both parties to conduct business electronically.

For all documents with a signature block, except those requiring additional identity verification as shown in the list below, an Electronic Signature on a PDF document is acceptable, as long as the following requirements are met prior to accepting the document:

- The Project Engineer shall verify that it bears the required signature(s)
- The document is legible and in PDF file format
- It is sent or transmitted from a recognized agent of the Contractor or Subcontractor, as appropriate

The Project Engineer will ensure two of the following conditions are met for external signers when accepting documents identified below as requiring additional identify verification:

- Verification that the email address used to transmit the document being signed is associated with an agent of the company.
- Verify a text message or phone call from a phone number associated with the individual used to unlock or allow the individual to sign the document.
- Verify the identity of the signer through use of a password that is used by the signer to unlock the document prior to signing.
- Verify the identity of the signer using a government issued identification during the signing process.
- Use Knowledge Based Authentication (KBA). This method uses a third party to authenticate the user by requiring them to answer a series of questions that only they know the answer to.
- Verify the Digital Signature is accompanied by a trusted certificate.
- Transmittal of the document is through a secure document control system using a trusted or verified account assigned to the individual.

These verifications may be done as part of an automated process built into the electronic or digital signature software.

Verification of identity may also be done separately, but must be documented and that documentation must accompany the record during document storage and archival. Verification must be recoverable or reproducible, when necessary.

If a document is received that does not meet requirements listed above, return it to the sender immediately, and notify the Prime Contractor that a document was received from an unknown email address and cannot be accepted.

### **Signature Blocks**

Any form, on which the word "Signature" appears in the block, requires a signature in that block (e.g., Inspector's Signature\_\_\_\_\_, Contractor's Signature\_\_\_, Project Engineer's Signature\_\_\_). Any form on which the signature block contains anything other than "Signature" are considered Bylines and do not require a signature (e.g., Completed by\_\_\_, Prepared by\_\_\_, Submitted by\_\_\_, Inspector\_\_\_). Signature blocks on these forms are "open" to allow the originator of the form to type in their name.

When filling out and completing our construction forms, all signature or initial blocks must be completed. Leaving them blank is not acceptable.

## **Software**

Documents that are created internally that do not require Contractor or other non-WSDOT signatures may use various software solutions to apply electronic signatures. It is preferred to use a digital signature with a self-signed certificate such as those available in Adobe Acrobat, Bluebeam Revu, or CoSign. Examples of internal documents include:

- Estimate and pre-estimate reports
- Pay Notes
- Project Material Certifications
- Prime Contractors Performance Report

There are no specific software requirements for documents generated, used or signed by the Contractor, or other non-WSDOT entities. These documents will be accepted using the above criteria regardless of the software used to apply the signature.

The Project Engineer will use Adobe Sign for all documents requiring additional identity verification. These documents will require use of Knowledge-Based Authentication (KBA) or password authentication for verification of all external signers (Contractors). KBA or password authentication are not necessary for internal signers of these documents including WSDOT employees and consultants that use WSDOT email accounts to conduct transactions.

If the password authentication method is used, the sender must ensure the following:

- A unique password is used for each signer
- The password is not shared via email. Another method must be used to share the password
- The password must not be provided by the sender to anyone other than the signer

## **Project Personnel Signature List**

Project Offices need to keep a list of personnel assigned to the project. The list must be kept current throughout the life of the project, updating it as new staff are assigned.

WSDOT personnel signature list (Project Personnel Listing [DOT Form 422-001](#)) is available for Project Office use.

**11-3A Numerical Listing of Forms**

Form Number	Form Title	Additional Identity Verification Required
134-146	Final Contract Voucher Certificate	x
226-012	Trainee Interview Questionnaire	
226-013	MSVWBE On-Site Review for Construction Subcontractors/Supplier/Manufacturers (MS Word)	
226-014	Project Office MSVWBE On-Site Review for Architect & Engineering and Professional Services Firms (MS Word)	
230-036A	Initial Documentation Review (Procedures)	
230-036B	Follow-up Documentation Review	
272-049	Training Program	
272-050	Apprentice/Trainee Approval Request	
272-051	DBE/UDBE On-Site Review Form/Commercially Useful Function Architect & Engineering/Professional Services Firm (MS Word)	
272-052	DBE/UDBE Commercially Useful Function On-Site Review for Construction Contractors/Subcontractors (MS Word)	
272-060	Federal-Aid Highway Construction Annual Project Training	
272-061	Federal-Aid Highway Construction Cumulative Training Report	
272-062	Contract Compliance Review Request for Additional Information	
272-064	DBE/UDBE Commercially Useful Function On-Site Review for Regular Dealer and Manufacturers (MS Word)	
350-004	Fabrication Progress Report	
350-009	Concrete Test Cylinder Transmittal	
350-016	Asphalt Emulsion Label	
350-110	Certificate of Material Origin (Required for the Acceptance of Construction Materials)	
350-023	Pit Evaluation Report	
350-026	Preliminary Sample Transmittal	
350-040	Concrete Mix Design	
350-042	HMA Mix Design Submittal	
350-056	Sample Transmittal	
350-071	Request for Approval of Material	
350-073	Hot Mix Asphalt Test Point Evaluation Report	
350-074	Field Density Test	
350-092	Hot Mix Asphalt Compaction Report (Station)	
350-092A	Mile Post Hot Mix Asphalt Compaction Report	
350-092B	Hot Mix Asphalt Compaction Report (80 Ton)	
350-109	Certification of Materials Origin	
350-112	Correlation - Nuclear Gauge to Core Density	
350-115	Contract Materials Checklist	
350-126	Asphalt Plant Inspection	
350-130	Field Acceptance/Verification Report (RAM/QPL)	
350-157	Rice Density	
350-161	HMA Mineral Aggregates	
350-162	Volumetrics Worksheet	
350-514	Moisture - Density Relationship Report	
350-560	Ignition Furnace Worksheet	
350-572	Manufacturer's Certificate of Compliance Checklist	



Form Number	Form Title	Additional Identity Verification Required
351-015	Daily Compaction Test Report	
351-021	Statement of Receipt of Radioactive Material	
410-010	Request for Information (RFI)	
410-010A	Request for Information (RFI) Internal Review	
410-025	Project Engineer Transmittal (to BSO)	
410-027	Test Pile Report	
410-029	Contractor's Construction Process Evaluation	
420-004	Contractor and Subcontractor or Lower-Tier Subcontractor Certification for Federal-Aid Projects	
421-005A	Change Order - Minor Change (2 Page)	
421-006	Order to Suspend Work	
421-007	Order to Resume Work	
421-009	Release - Retainage Percentage (Except Landscaping)	x
421-010	Prime Contractor Performance Report	
421-012	Request to Sublet Work	
421-014	Examination Sheet for Contract Items	
421-023	Quarterly Report of Amounts Paid MBE/WBE Participants	
421-040A	Contractor's Daily Report of Traffic Control - Summary	
421-040B	Contractor's Daily Report of Traffic Control - Traffic Control Log	
421-045	WSP Field Check List	
422-001	Project Personnel Listing	
422-001A	Change Order Authorization Signature	
422-002	Change Record	
422-003	Change Order Checklist	
422-004	Inspector's Daily Report	
422-004A	Inspector's Daily Report Diary Page	
422-004B	(Street) Inspector's Daily Report	
422-007	Report of Protested Work	
422-008	Daily Report of Force Account Worked	
422-009	Final Records Notes Title Page	
422-009B	Final Record Notes Title Page	
422-010	Force Account Equipment Rate Request	
422-012	Final Record Notes - Title Sticker	
422-020	Record of Field Tests	
422-020A	Aggregate Record of Field Tests	
422-020B	Inspector's Record of Field Tests	
422-021	Item Quantity Ticket	
422-024	Water Delivery Record	
422-100	Interim Inspection of Federal-Aid Projects	
422-101	Final Inspection and Acceptance of Federal-Aid Projects	
422-102	Quarterly Report of Amounts Credited as DBE Participation	
422-568	Load Tally Sheet	
422-635	Field Note Record	
422-636	Field Note Record (Sketch Grid)	
422-637	Field Note Record of Drainage	
422-644	Daily Report of BST Operations	
422-700	Daily Work Quantities	

Form Number	Form Title	Additional Identity Verification Required
424-003	Employee Interview Report	
450-001	Manufacturer's Certificate of Compliance for Ready Mixed Concrete	
450-004	Pile Book	
450-004A	Pile Driving Log	
450-005	Post-Tensioning Record	
540-020	Backflow Prevention Assembly Test Report	
540-509	Commercial Pesticide Application Record	
591-020A	Daily Traffic Item Ticket (Equipment)	
591-020B	Daily Traffic Item Ticket (Labor)	
591-020C	Summary of Daily Traffic Item Ticket	
722-025	As Built Cover Sheet	
750-001	Fall Protection Plan	
750-001A	Tower and Bridge Fall Protection Plan	
820-010	Monthly Employment Utilization Report	
FHWA-1391	Federal-Aid Highway Construction Contractor's Annual EEO Report	
FHWA-1392	Federal-Aid Highway Construction Summary of Employment Data	