

- [1310.01 General](#)
- [1310.02 Design Considerations](#)
- [1310.03 Design Elements](#)
- [1310.04 U-Turns](#)
- [1310.05 Intersection Sight Distance](#)
- [1310.06 Signing and Delineation](#)
- [1310.07 Procedures](#)
- [1310.08 Documentation](#)
- [1310.09 References](#)

## 1310.01 General

Intersections are a critical part of Washington State Department of Transportation (WSDOT) highway design because of increased conflict potential. Traffic and driver characteristics, bicycle and pedestrian needs, physical features, and economics are considered during the scoping and design stages to develop channelization and traffic control to provide multimodal traffic flow through intersections.

See chapters in the 1100 series for instruction on multimodal practical design, including identifying project needs, context, design controls, modal performance, alternatives analysis, and design element dimensioning.

This chapter provides guidance for designing intersections, including ramp terminals. Refer to the following chapters for additional information:

Chapter	Subject
<a href="#">1103</a>	Design controls
<a href="#">1106</a>	Design element dimensions
<a href="#">1230</a>	Geometric cross section
<a href="#">1300</a>	Intersection control type
<a href="#">1320</a>	Roundabouts
<a href="#">1330</a>	Traffic signals
<a href="#">1340</a>	Driveways
<a href="#">1360</a>	Interchanges
<a href="#">1510</a>	Pedestrian facilities
<a href="#">1520</a>	Roadway bicycle facilities

For assistance with intersection design, contact the Headquarters (HQ) Design Office.

## 1310.02 Design Considerations

Consider all potential users of the facility in the design of an intersection. This involves addressing the needs of a diverse mix of user groups, including passenger cars, heavy vehicles of varying classifications, bicycles, and pedestrians. Often, meeting the needs of one user group results in a compromise in service to others. Intersection design balances these competing needs, resulting in appropriate levels of operation for all users.

In addition to reducing the number of conflicts, minimize the conflict area as much as possible while still providing for the design vehicle (see [Chapter 1103](#)). This is done to control the speed of turning vehicles and reduce the area of exposure for vehicles, bicycles, and pedestrians. For additional information on pedestrian needs, see [Chapter 1510](#). For intersections with shared-use paths, see [Chapter 1515](#). For bicycle considerations at intersections, see [Chapter 1520](#).

### 1310.02(1) *Non-Geometric Considerations*

Geometric design considerations, such as sight distance and intersection angle, are important. Equally important are perception, contrast, and a driver's age. Perception is a factor in the majority of crashes. Regardless of the type of intersection, the function depends on the driver's ability to perceive what is happening with respect to the surroundings and other vehicles. When choosing an acceptable gap, the driver first identifies the approaching vehicle and then determines its speed. The driver uses visual clues provided by the immediate surroundings in making these decisions. Thus, given equal sight distance, it may be easier for the driver to judge a vehicle's oncoming speed when there are more objects to pass by in the driver's line of sight. Contrast allows drivers to discern one object from another.

### 1310.02(2) *Intersection Angle and Roadway Alignment*

An important intersection design characteristic is the intersection angle. The desirable intersection angle is 90°, with 60° to 120° allowed. Do not put angle points on the roadway alignments within intersection areas or on the through roadway alignment within 100 feet of the edge of traveled way of a crossroad. However, angle points within the intersection are allowed at intersections with a minor through movement, such as at a ramp terminal (see [Exhibit 1310-2](#)).

When feasible, locate intersections such that curves do not begin or end within the intersection area. It is desirable to locate the PC and PT 250 feet or more from the intersection so that a driver can settle into the curve before the gap in the striping for the intersection area. Do not locate short curves where both the PC and PT are within the intersection area.

### 1310.02(3) Lane Alignment

It is desirable that entering through traffic is aligned with the exit lanes. However, the entering and exit lanes may be offset up to 6 feet when the following conditions are met:

- Illumination is provided.
- The intersection is not within a horizontal curve, nor is it within a crest vertical curve.
- The taper rates provided in [Exhibit 1310-1](#) are used.
- There is a posted speed of 55 mph or less.

Consider dotted extension lines that continue through the intersection.

**Exhibit 1310-1 Lane Alignment Taper Rate**

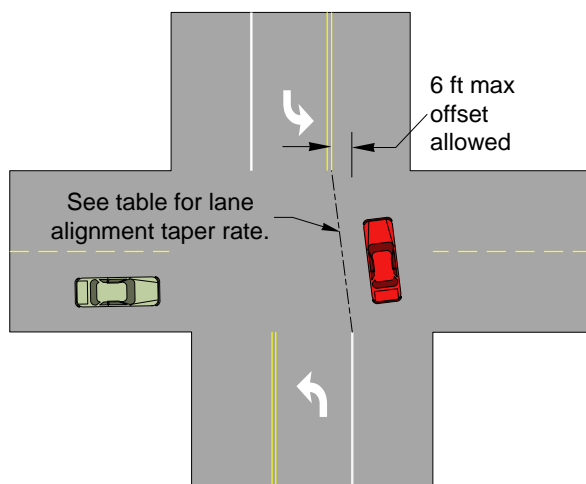

Posted Speed	Taper Rate
55 mph	55:1
50 mph	50:1
45 mph	45:1
40 mph	27:1
35 mph	21:1
30 mph	15:1
25 mph	11:1

### 1310.02(4) Intersection Spacing

Provide intersection spacing for efficient operation of the highway. The minimum design intersection spacing for highways with limited access control is covered in [Chapter 530](#). For other highways, the minimum design intersection spacing is dependent on the managed access highway class. (See [Chapter 540](#) for minimum intersection spacing on managed access highways.)

As a minimum, provide enough space between intersections for left-turn lanes and storage length. Space signalized intersections and intersections expected to be signalized to maintain efficient signal operation. Space intersections so that queues will not block an adjacent intersection.

Evaluate existing intersections that are spaced less than shown in Chapters 530 and 540. Also, evaluate closing or restricting movements at intersections with operational issues. Document the spacing of existing intersections that will remain in place and the effects of the spacing on operation, capacity, and circulation.

### **1310.02(5) Accommodating vs. Designing for Vehicles**

Accommodating for a vehicle allows encroachment of other lanes, shoulders, or other elements to complete the required maneuver. Designing for a vehicle does not require encroachment on those elements.

There are competing design objectives when considering the crossing needs of pedestrians and the turning needs of larger vehicles. To design for large design vehicles, larger turn radii are used. This results in increased pavement areas, longer pedestrian crossing distances, and longer traffic signal arms. (See Chapter 1103 for design vehicle selection criteria.)

When appropriate, to reduce the intersection area, consider accommodating for large vehicles instead of designing for them. This reduces the potential for vehicle/pedestrian conflicts, decreases pedestrian crossing distance, and controls the speeds of turning vehicles. Use turn simulation software (such as AutoTURN®) to verify the design.

### **1310.02(6) Sight Distance**

For stopping and decision sight distance criteria, see Chapter 1260. Intersection sight distance criteria are discussed in section 1310.05.

### **1310.02(7) Crossroads**

When the crossroad is a city street or county road, design the crossroad beyond the intersection area in cooperation with the local agency.

When the crossroad is a state facility, design the crossroad according to the *Design Manual*. Continue the cross slope of the through roadway shoulder as the grade for the crossroad. Use a vertical curve that is at least 60 feet long to connect to the grade of the crossroad.

Evaluate the profile of the crossroad in the intersection area. The crown slope of the main line might need to be adjusted in the intersection area to improve the profile for the cross traffic.

Design the grade at the crosswalk to meet the requirements for accessibility. (See Chapter 1510 for additional crosswalk information.)

In areas that experience accumulations of snow and ice for all legs that require traffic to stop, design a maximum grade of  $\pm 4\%$  for a length equal to the anticipated queue length for stopped vehicles.

### **1310.02(8) Rural Expressway At-Grade Intersections**

Evaluate grade separations at all intersections on rural expressways.

Design high-speed at-grade intersections on rural expressways as indirect left turns, split intersections, or roundabouts.

The State Traffic Engineer's approval is required for any new intersection or signal on a rural expressway.

### 1310.02(9) Interchange Ramp Terminals

When stop control or traffic signal control is selected, the design to be used or modified is shown in [Exhibit 1310-2](#). Higher-volume intersections with multiple ramp lanes are designed individually. Provide ramp terminal designs consistent with the speed of the crossroad.

Where stop control or signal control is implemented, the intersection configuration criteria for ramp terminals are normally the same as for other intersections. One exception is that an angle point is allowed between an off-ramp and an on-ramp. This is because the through movement of traffic getting off the freeway, going through the intersection, and getting back on the freeway is minor.

Another exception is at ramp terminals where the through movement is eliminated (for example, at a single-point interchange). For ramp terminals that have two wye connections, one for right turns and the other for left turns, and no through movement, the intersection angle has little meaning and does not need to be considered.

Due to the probable development of large traffic generators adjacent to an interchange, width for a median on the local road is desirable whenever such development is expected. This allows for future left-turn channelization. Use median channelization when justified by capacity determination and analysis or by the need to provide a smooth traffic flow.

Adjust the alignment of the intersection legs to fit the traffic movements and to discourage wrong-way movements. Use the allowed intersecting angles of 60° to 120° in designing the best alignment for efficiency and intersection operations.

#### Exhibit 1310-2 Ramp Terminal Intersection Details

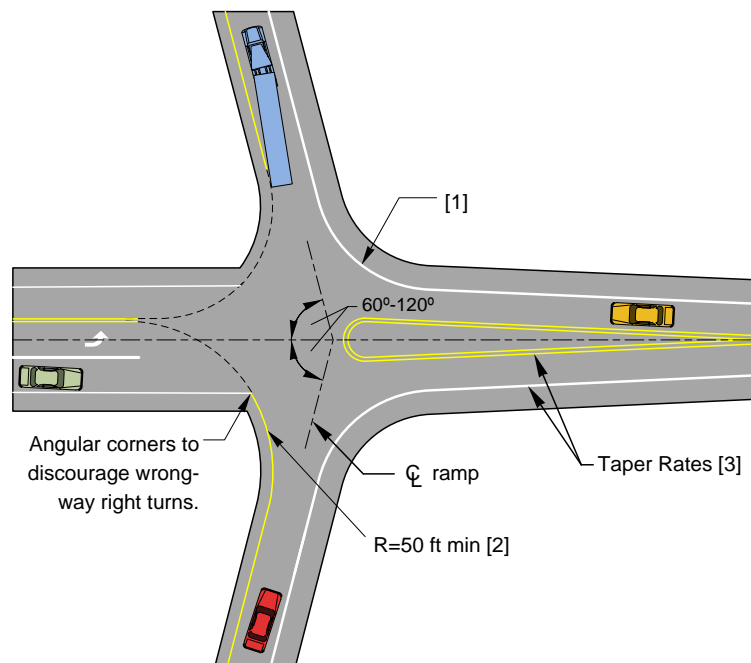

#### Notes:

- [1] For right-turn corner design, see [Exhibit 1310-6](#).
- [2] Use turn simulation software to verify that the design vehicle can make the turn.
- [3] For taper rates, see [Exhibit 1310-10a](#), Table 1.

## 1310.02(10) **Wrong-Way Movement Countermeasures**

Wrong-way crashes, though infrequent, have the potential to be more serious than other types of crashes, especially on high-speed facilities. Crash data show that impaired and older drivers are overrepresented and that a high percentage of these occurrences are at night. Washington State data show approximately equal numbers of crashes on the Interstate and multilane urban principal arterial highways. Discourage wrong-way maneuvers at all stages of design.

### 1310.02(10)(a) **Wrong-Way Driving Countermeasure Categories**

There are three categories of countermeasures to discourage wrong-way driving:

- Signing and delineation
- Intelligent transportation systems
- Geometric design

#### 1310.02(10)(a)(1) **Signing and Delineation**

Signing and delineation countermeasures include:

- DO NOT ENTER and WRONG WAY signs.
- ONE WAY signs.
- Turn restriction signs.
- Red-backed raised pavement markers (RPMs).
- Directional pavement arrows.
- Yellow edge line on left and white edge line on right side of exit ramps.
- Pavement marking extension lines to direct drivers to the correct ramp.

Signing can be a more effective countermeasure when the signs are lowered. At night, lowered signs are better illuminated by low-beam headlights. Other improvements may include a second set of signs, supplemental sign placards, oversized signs, flashing beacons, internal illumination, overhead-mounted signs, red reflective tape on the back of signs, extra overhead lighting, and red-backed guideposts on each side of the ramp up to the WRONG WAY sign.

#### 1310.02(10)(a)(2) **Intelligent Transportation Systems (ITS)**

Wrong-way ITS countermeasures are wrong-way detection and warning systems. Contact the region Traffic Office for assistance when considering an ITS wrong-way warning system.

#### 1310.02(10)(a)(3) **Geometric Design**

Geometric countermeasures include separating wrong-way movements from other movements, discouraging wrong-way movements, encouraging right-way movements, and improving the visibility of the right-way movement.

##### **a. Separate On- and Off-Ramp Terminals**

Consider the separation of on- and off-ramp terminals, particularly at interchanges where the ramp terminals are closely spaced (for example, partial cloverleaf ramps combined with

other ramps). Wider medians between off- and on-ramp terminals provide room for signing and allow the median end to be shaped to help direct vehicles onto the correct roadway. The minimum width of the raised median is 7 feet, face of curb to face of curb, to accommodate a 36 inch sign.

Extend the raised median on a two-way ramp from the ramp terminal intersection to the split of the on- and off-ramps. The median outside of the intersection area may be reduced to the width of a dual-faced mountable curb. (See [Exhibit 1310-3](#) for an example of the minimum median at the terminal of a two-way ramp.)

### Exhibit 1310-3 Median at Two-Way Ramp Terminal

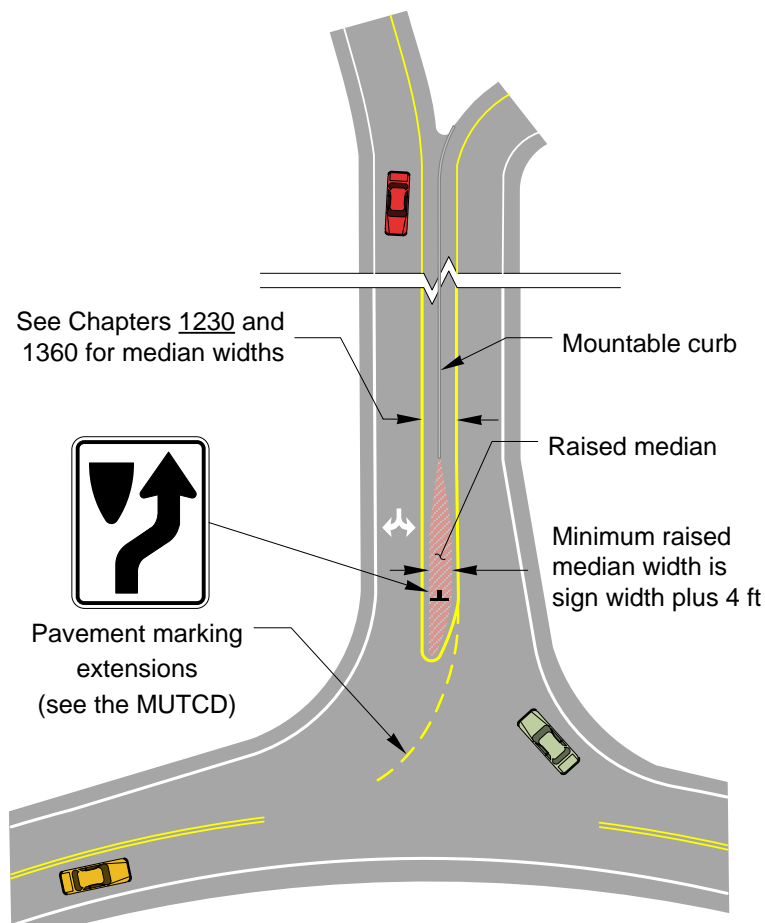

#### b. Reduced Off-Ramp Terminal Throat Width

Reducing the width of the off-ramp throat has been a successful method of discouraging wrong-way movements. A smaller opening makes the wrong-way entry less inviting, particularly for closely spaced ramps. When off-ramp terminals have right-turn lanes, a raised island will reduce the potential for a wrong-way movement.

### c. Increased On-Ramp Terminal Throat Width

Increasing the width of the on-ramp throat can encourage right-way movements. A larger opening for the on-ramp makes it easier to turn into. To increase the throat width of on-ramps, use flat radii for left- and right-turning traffic and remove islands.

### d. Intersection Balance

When drivers make a left turn, they are required to leave the intersection in the extreme left-hand lane lawfully available. As a result, left-turning drivers tend to head for a point between 50% and 60% of the way through the intersection.

At a two-way ramp terminal, the desirable throat width for the on-ramp roadway is not less than the off-ramp roadway width to accommodate this behavior (see [Exhibit 1310-4](#)). Much of this can be achieved by adjusting the stop bar position on the interchange cross street.

**Exhibit 1310-4 Intersection Balance Example**

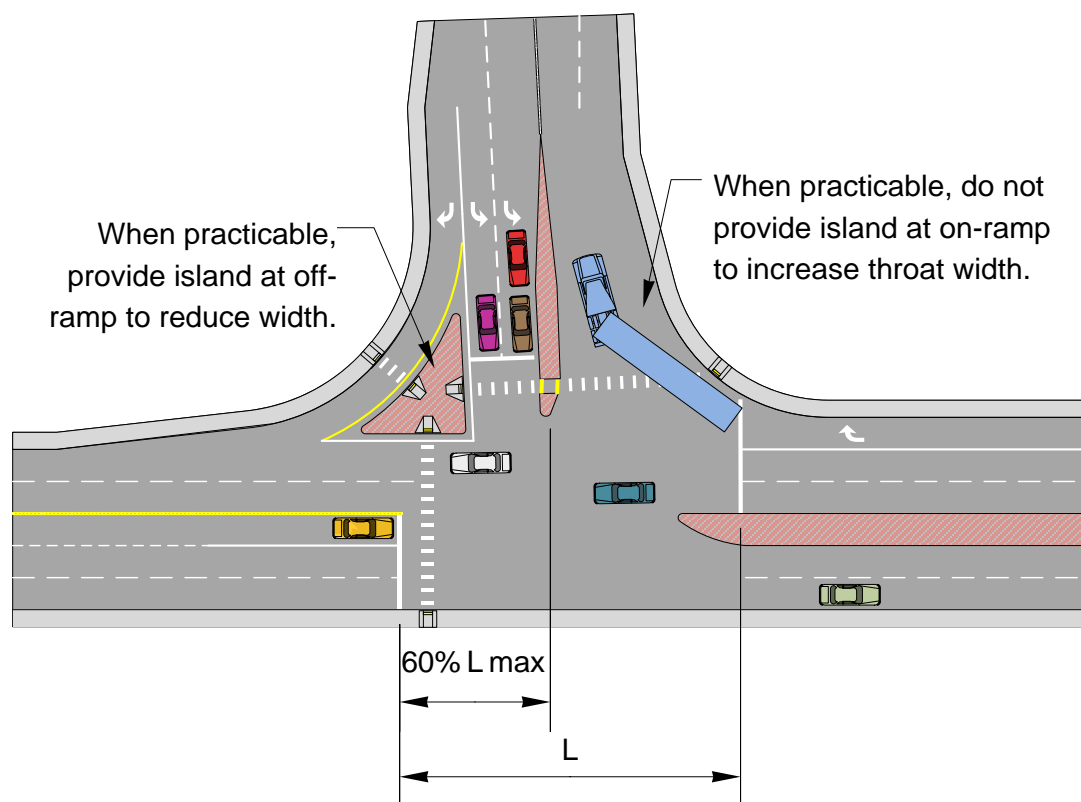

### e. Visibility

When drivers can see and recognize the roadway they want to turn onto, they are less likely to make a mistake and turn onto the wrong roadway. For two-way ramps and divided multilane roadways with barrier in the median, end the barrier far enough from the intersection that a left-turning driver can see and recognize the roadway going the correct



direction. Drivers need to see the delineation pavement markings, curbs, or other elements to locate the correct roadway.

#### **f. Angular Corners on the Left of Off-Ramp Terminals**

Angular corners on the left side of off-ramp terminals will discourage wrong-way right turns. Provide a corner design as angular as feasible that will provide for the left turn from the off-ramp. Circular curves can look inviting for a wrong-way right turn onto the off-ramp (see [Exhibit 1310-2](#)).

### **1310.02(10)(b) Countermeasure Applications**

Following are applications of wrong-way countermeasures for some common locations. For assistance with signing and delineation, contact the region Traffic Office.

#### **1310.02(10)(1) All Ramps**

Countermeasures that can be used on almost any ramp or intersection with potential wrong-way concerns include:

- Enlarged warning signs.
- Directional pavement arrows at ramp terminals.
- Redundant signing and pavement arrows.
- Roundabout ramp terminal intersections, where room is available.
- Red-backed RPMs.

#### **1310.02(10)(2) One-Way Diamond Off-Ramp**

Diamond interchanges are common, and although drivers are familiar with them, they can still get confused and go the wrong way. In addition to signing and pavement markings for these interchanges, provide:

- Angular corners to discourage wrong-way right turns.

#### **1310.02(10)(3) Diamond Interchange With Advance Storage**

Diamond interchanges with advance storage have left-turn storage lanes that extend from the on-ramp past the off-ramp (see [Exhibit 1310-5](#)). This allows for a potential early left turn onto the off-ramp. Following are additional countermeasures for interchanges with advanced left-turn storage:

- Provide a raised median to discourage the wrong-way left turn.
- Provide signing and directional arrows to direct traffic to the correct left-turn point.

## Exhibit 1310-5 Diamond Interchange With Advance Storage

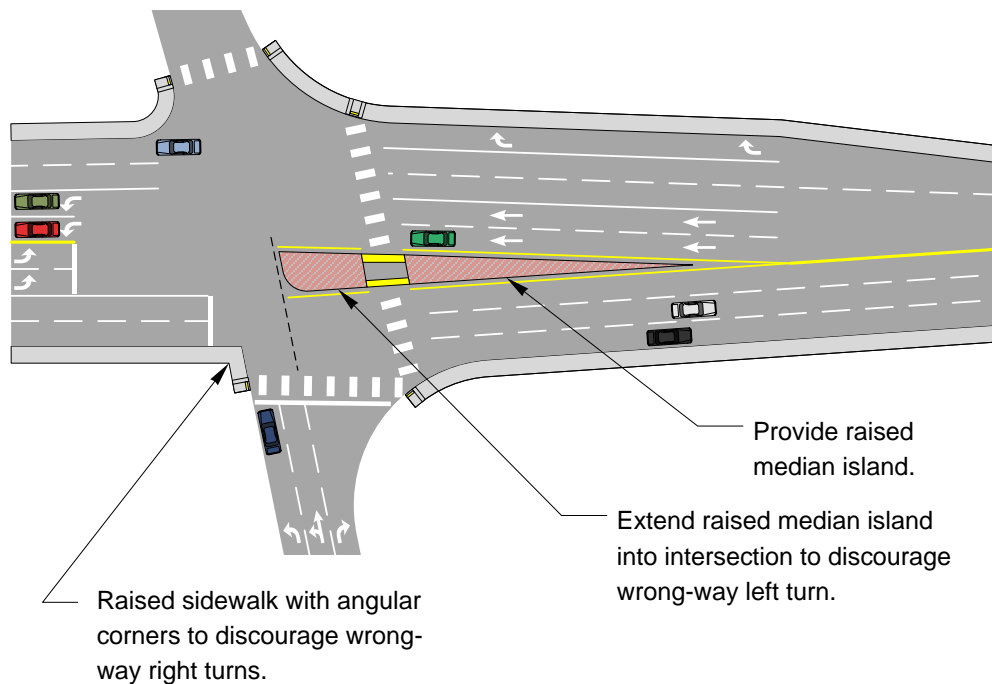
**1310.02(10)(4) Two-Way Ramps**

Two-way ramps have the on- and off-ramp adjacent to each other. They are used at partial cloverleaf, trumpet, and button hook interchanges. Because the on and off roadways are close to each other, they are more vulnerable to wrong-way driving. Also, when the separation between on and off traffic is striping only, the ramps are susceptible to drivers entering the correct roadway and inadvertently crossing to the wrong ramp. In addition to signing and delineation, the following are countermeasures for two-way ramps:

- Separate the on- and off-ramp terminals.
- Reduce off-ramp terminal throat width.
- Increase on-ramp terminal throat width.
- Maintain intersection balance.
- Improve on-ramp visibility.
- Provide a raised median or dual-faced curb from the ramp terminal intersection to the gore nose.

**1310.02(10)(5) HOV Direct Access Ramps**

HOV direct access ramps are two-way ramps in the median; therefore, the ability to provide separation between the on and off traffic is limited by the width of the median. An additional concern is that HOV direct access ramps are left-side ramps. Drivers normally enter the freeway using a right-side ramp and they may mistakenly travel the wrong way on

a left-side ramp. Review existing and proposed signing for inadvertent misdirection. (See [Chapter 1420](#) for HOV direct access and countermeasures for wrong-way driving at HOV direct access ramps.)

### **1310.02(10)(6) Multilane Divided Roadways**

Wrong-way driving can also occur on multilane divided nonfreeway facilities. Wrong-way drivers may enter multilane divided facilities at driveways and at-grade intersections. Countermeasures for wrong-way driving on nonfreeway multilane divided highways include:

- Wrong-way signing and delineation at the intersections.
- Right-in/right-out road approaches.

## **1310.03 Design Elements**

When designing an intersection, identify and address the needs of all intersection users.

If pedestrian facilities are present, the design objective becomes one of reducing the potential for vehicle/pedestrian conflicts. This is done by minimizing pedestrian crossing distances and controlling the speeds of turning vehicles. Pedestrian refuge islands can be beneficial. They minimize the pedestrian crossing distance, reduce the conflict area, and minimize the impacts on vehicular traffic. When designing islands, speeds can be reduced by designing the turning roadway with a taper or large radius curve at the beginning of the turn and a small radius curve at the end. This allows larger islands while forcing the turning traffic to slow down. Use turn simulation software (such as AutoTURN<sup>®</sup>) to verify the design.

Channelization, the separation or regulation of traffic movements into delineated paths of travel, can facilitate the orderly movement of pedestrians, bicycles, and vehicles. Channelization includes left-turn lanes, right-turn lanes, speed change lanes (both acceleration and deceleration lanes), and islands.

### **1310.03(1) Right-Turn Corners**

[Exhibit 1310-6](#) shows initial ranges for right-turn corner designs using a simple curve with a taper. These are considered approximate pavement areas to accommodate the design vehicles without encroachment on the adjacent lane at either leg of the curve.

Depending on the context of the roadway and right-turn corner (and whether the right-turn corner will be designed for or will accommodate a design vehicle), there may be several design considerations. Consider vehicle-pedestrian conflicts; vehicle encroachment on the shoulder or adjacent same-direction lane at the exit leg; capacity restrictions for right-turning vehicles or other degradation of intersection operations; and the effects on other traffic movements.

Other design considerations may include a combination of simple or compound curves, tapers at the beginning or end of the turn, and so on. Verify the design vehicle can make the turn using turn simulation software (such as AutoTURN<sup>®</sup>).

Exhibit 1310-6 Initial Ranges for Right-Turn Corner (Simple Curve-Taper)

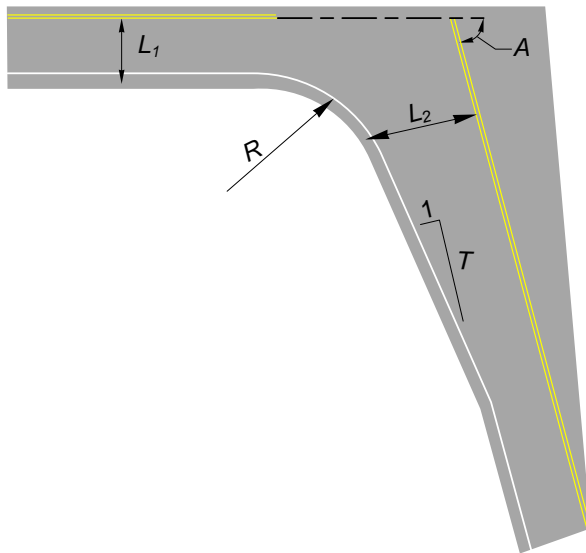

- $L_1$  = Available roadway width [2] that the vehicle is turning from
- $L_2$  = Available roadway width [2] for the vehicle leaving the intersection
- $R$  = Radius to the edge of traveled way
- $T$  = Taper rate (length per unit of width of widening)
- $A$  = Delta angle of the turning vehicle

Vehicle	A	R	$L_1$ [1]	$L_2$ [2]	T
P	All	30	11	11	25
SU-30 & CITY-BUS	All	50	11	11	25
WB-40	All	55	11	15	7.5
WB-67	All	50-85	11	22-24	7

**Notes:**

- [1] When available roadway width is less than 11 ft, widen at 25:1.
- [2] Available roadway width includes the shoulder, less a 2-ft clearance to a curb, and all the same-direction lanes of the exit leg at signalized intersections.

**General:**

All distances given in feet and angles in degrees

### 1310.03(2) **Left-Turn Lanes and Turn Radii**

Left-turn lanes provide storage, separate from the through lanes, for left-turning vehicles waiting for a signal to change or for a gap in opposing traffic. (See [1310.03\(4\)](#) for a discussion on speed change lanes.)

Design left-turn channelization to provide sufficient operational flexibility to function under peak loads and adverse conditions.

#### 1310.03(2)(a) **One-Way Left-Turn Lanes**

One-way left-turn lanes are separate storage lanes for vehicles turning left from one roadway onto another. One-way left-turn lanes may be an economical way to lessen delays and crash potential involving left-turning vehicles. In addition, they can allow deceleration clear of the through traffic lanes. Provide a minimum storage length of 100 feet for one-way left-turn lanes. When evaluating left-turn lanes, include impacts to all intersection movements and users.

At signalized intersections, use a traffic signal analysis to determine whether a left-turn lane is needed and the storage length. If the length determined is less than the 100-foot minimum, make it 100 feet (see [Chapter 1330](#)).

At unsignalized intersections, use the following as a guide to determine whether or not to provide one-way left-turn lanes:

- A traffic analysis indicates congestion reduction with a left-turn lane. On two-lane highways, use [Exhibit 1310-7a](#), based on total traffic volume (DHV) for both directions and percent left-turn traffic, to determine whether further investigation is needed. On four-lane highways, use [Exhibit 1310-7b](#) to determine whether a left-turn lane is recommended.
- A study indicates crash reduction with a left-turn lane.
- Restrictive geometrics require left-turning vehicles to slow greatly below the speed of the through traffic.
- There is less than decision sight distance for traffic approaching a vehicle stopped at the intersection to make a left turn.

A traffic analysis based on the *Highway Capacity Manual* (HCM) may also be used to determine whether left-turn lanes are needed to maintain the desired level of service.

Exhibit 1310-7a Left-Turn Storage Guidelines: Two-Lane, Unsignalized

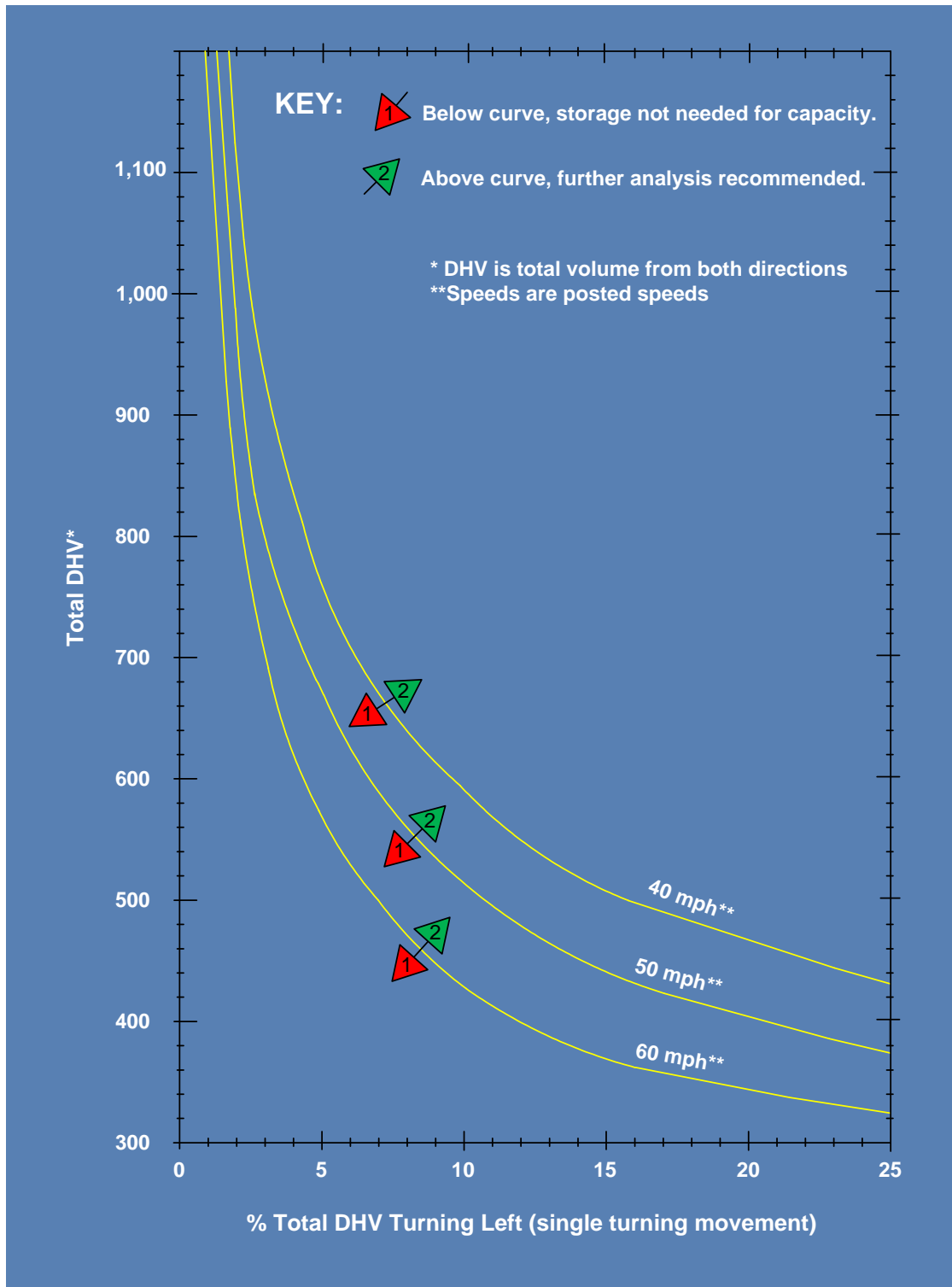

## Exhibit 1310-7b Left-Turn Storage Guidelines: Four-Lane, Unsignalized

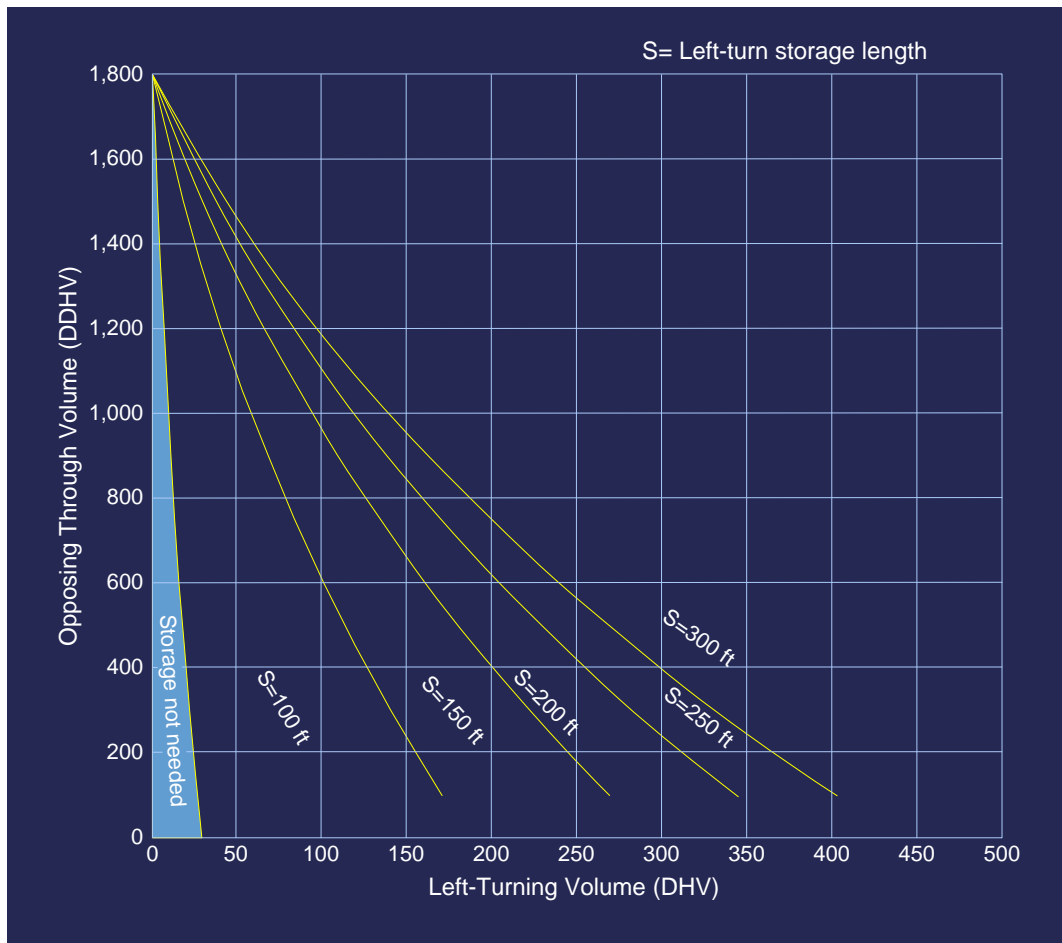

Determine the storage length on two-lane highways by using [Exhibits 1310-8a through 8c](#). On four-lane highways, use [Exhibit 1310-7b](#). These lengths do not consider trucks. Use [Exhibit 1310-9](#) for storage length when trucks are present.

Use turn simulation software (such as AutoTURN®) to verify that left-turn movements for the design vehicle(s) do not have conflicts. Design opposing left-turn design vehicle paths with a minimum 4-foot (12-foot desirable) clearance between opposing turning paths.

Where one-way left-turn channelization with curbing is to be provided, evaluate surface water runoff and design additional drainage facilities if needed to control the runoff.

Provide illumination at left-turn lanes in accordance with the guidelines in [Chapter 1040](#).

Exhibit 1310-8a Left-Turn Storage Length: Two-Lane, Unsignalized (40mph)

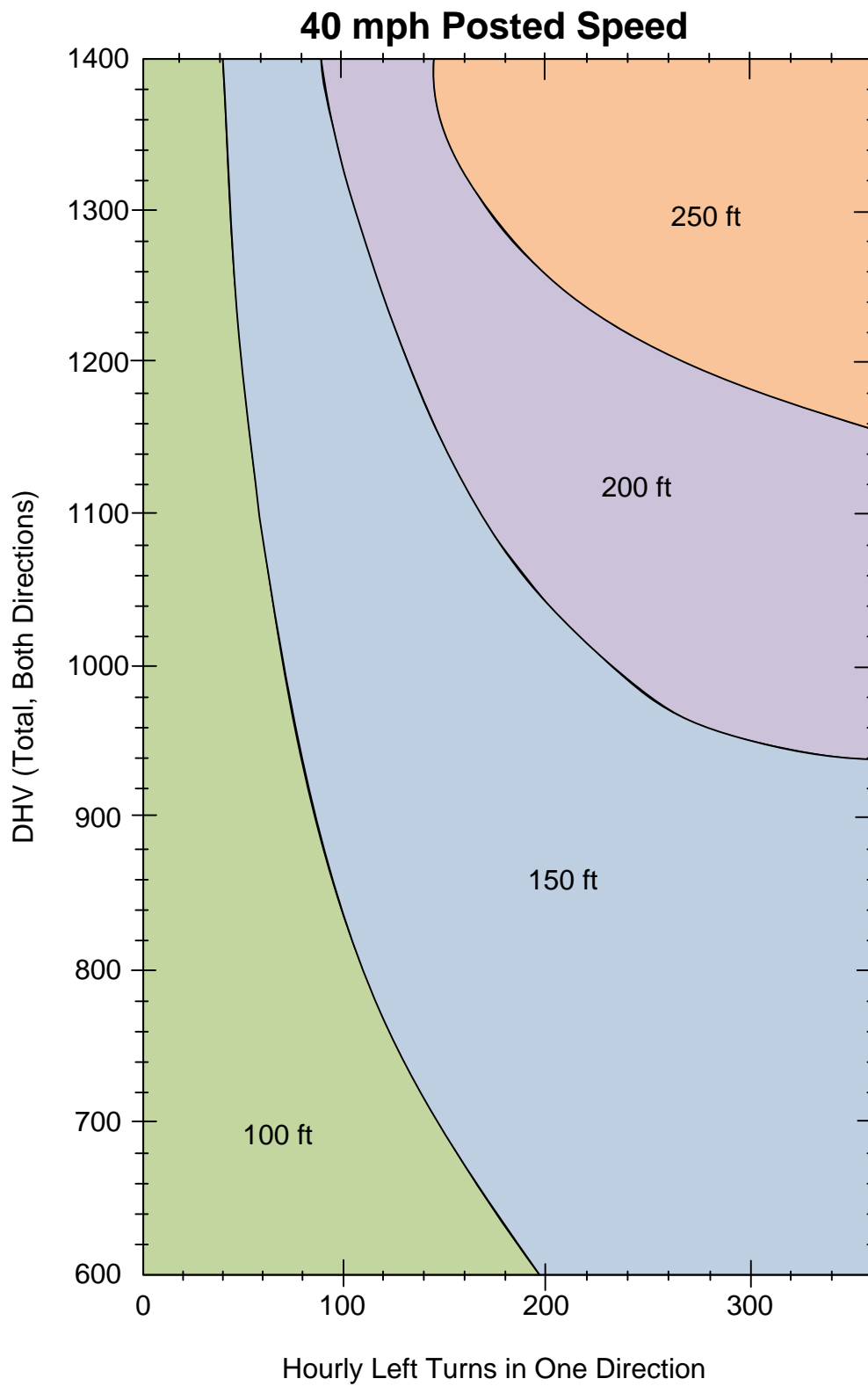



Exhibit 1310-8b Left-Turn Storage Length: Two-Lane, Unsignalized (50 mph)

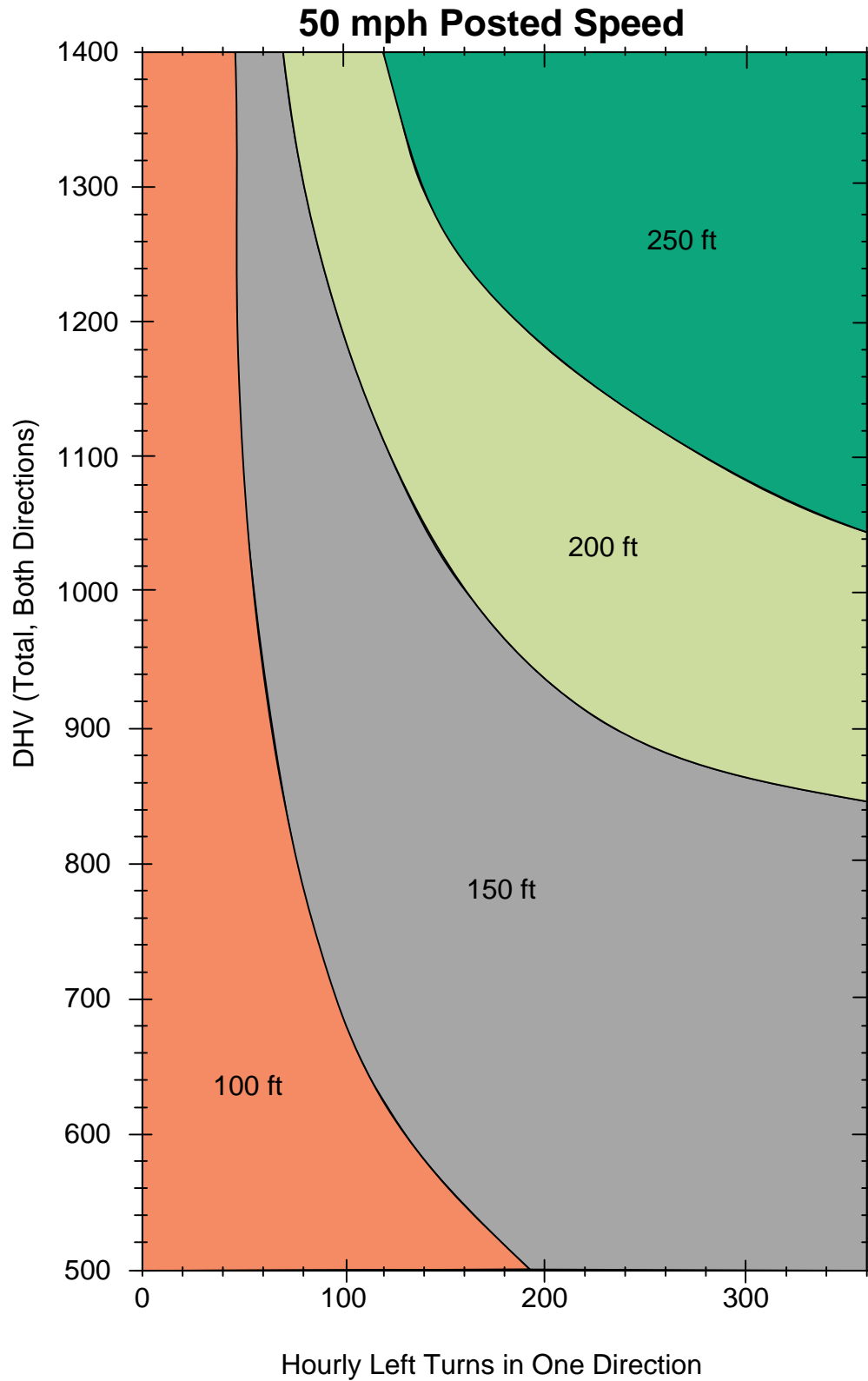
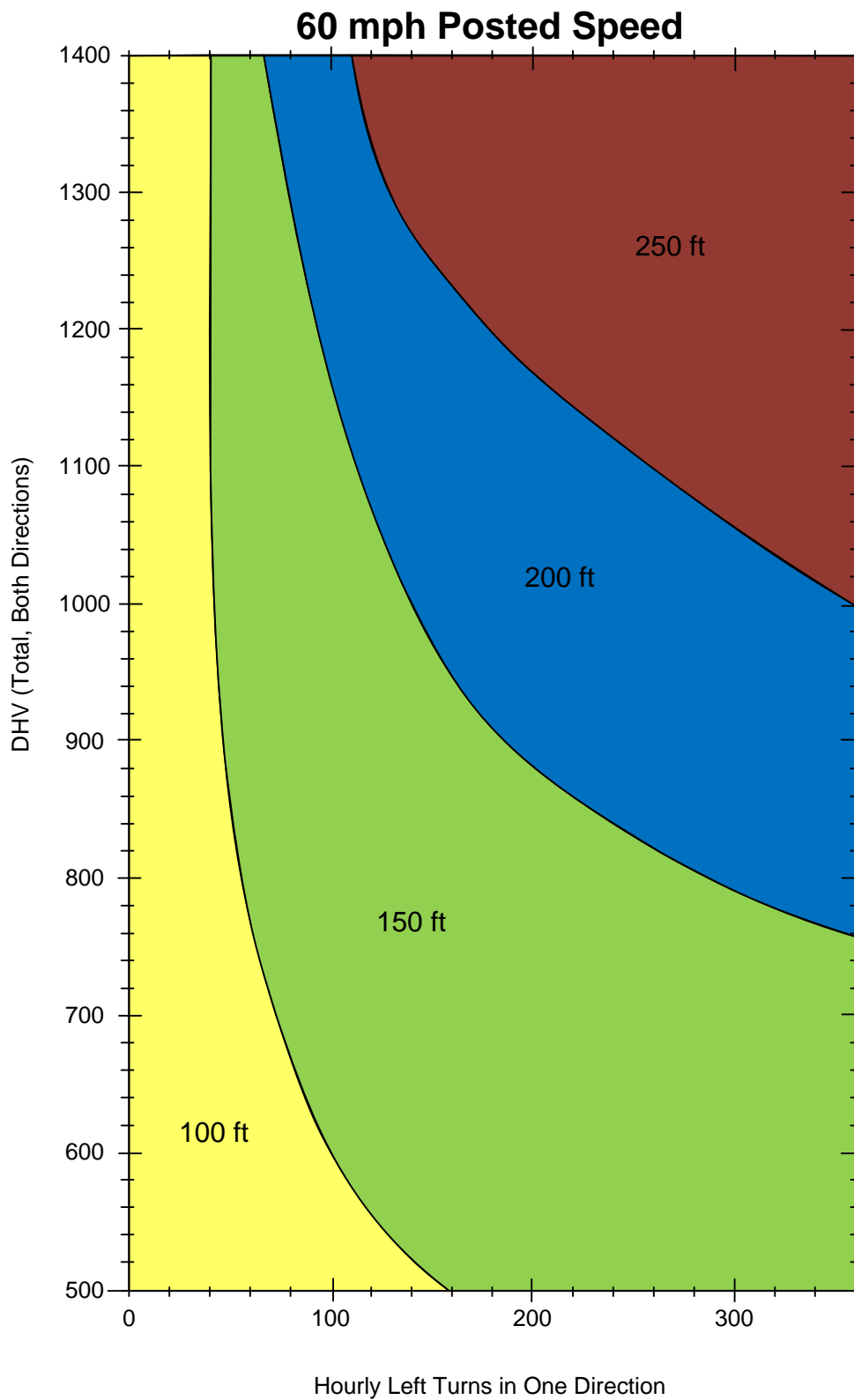

Exhibit 1310-8c Left-Turn Storage Length: Two-Lane, Unsignalized (60 mph)



## Exhibit 1310-9 Left-Turn Storage With Trucks (ft)

Storage Length* (ft)	% Trucks in Left-Turn Movement				
	10	20	30	40	50
100	125	125	150	150	150
150	175	200	200	200	200
200	225	250	275	300	300
250	275	300	325	350	375
300	350	375	400	400	400

\*Length from Exhibits 1310-7b and 1310-8a, 8b, or 8c.

At signalized intersections with high left-turn volumes, double (or triple) left-turn lanes may be needed to maintain the desired level of service. For a double left-turn, a throat width of 30 to 36 feet is desirable on the exit leg of the turn to offset vehicle offtracking and the difficulty of two vehicles turning abreast. Use turn simulation software (such as AutoTURN®) to verify that the design vehicle can complete the turn. Where the design vehicle is a WB 40 or larger, it is desirable to provide for the design vehicle in the outside lane and an SU-30 vehicle turning abreast rather than two design vehicles turning abreast.

Exhibits 1310-10a through 10f show left-turn lane geometrics, which are described as follows:

#### 1310.03(2)(a)(1) Widening

It is desirable that offsets and pavement widening (see Exhibit 1310-10a) be symmetrical about the centerline or baseline. Where right of way or topographic restrictions, crossroad alignments, or other circumstances preclude symmetrical widening, pavement widening may be on one side only.

#### 1310.03(2)(a)(2) Divided Highways

Widening is not needed for left-turn lane channelization where medians are 11 feet wide or wider (see Exhibits 1310-10b through 10d). For medians between 13 feet and 23 feet or where the acceleration lane is not provided, it is desirable to design the left-turn lane adjacent to the opposing lane (see Exhibit 1310-10b) to improve sight distance and increase opposing left-turn clearances.

A median acceleration lane (see Exhibits 1310-10c and 10d) may be provided where the median is 23 feet or wider. The median acceleration lane might not be needed at a signalized intersection. When a median acceleration lane is to be used, design it in accordance with 1310.03(4), Speed Change Lanes. Where medians have sufficient width, provide a 2-foot shoulder adjacent to a left-turn lane.

#### 1310.03(2)(a)(3) Minimum Protected Left Turn With a Median

At intersections on divided highways where channelized left-turn lanes are not provided, provide the minimum protected storage area (see Exhibit 1310-10e).

### 1310.03(2)(a)(4) Modifications to Left-Turn Designs

The left-turn lane designs discussed above and given in Exhibits 1310-10a through 10e may be modified when determined by design element dimensioning (see Chapter 1106.) Document the benefits and impacts of the modified design, including changes to vehicle-pedestrian conflicts; vehicle encroachment; deceleration length; capacity restrictions for turning vehicles or other degradation of intersection operations; and the effects on other traffic movements. Provide a modified design that is able to accommodate the design vehicle, and provide for the striping (see the *Standard Plans* and the *MUTCD*). Verify the design vehicle can make the turn using turn simulation software (such as AutoTURN®); include a plot of the design and verification.

#### Exhibit 1310-10a Median Channelization: Widening

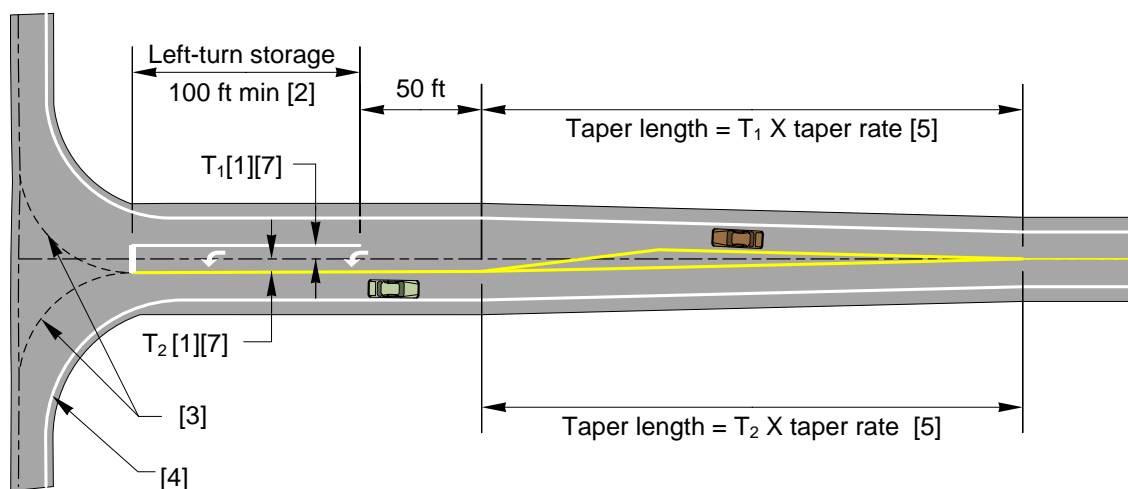

**Notes:**

- [1] The minimum width of the left-turn storage lane ( $T_1+T_2$ ) is 11 ft.
- [2] For left-turn storage length, see Exhibits 1310-7b for 4-lane roadways or 1310-8a through 8c for 2-lane roadways.
- [3] Use turn simulation software (such as AutoTURN®) to verify the design vehicle can make the turn.
- [4] For right-turn corner design, see Exhibit 1310-6.
- [5] For desirable taper rates, see Table on this Exhibit. With justification, taper rates from the Table in Exhibit 1310-10c may be used.
- [6] For pavement marking details, see the *Standard Plans* and the *MUTCD*.
- [7] Where curb is provided, add the width of the curb and the shoulders to the left-turn lane width. For shoulder widths at curbs, see 1310.03(6) and Chapter 1230.

$T_1$  = Width of left-turn lane on approach side of centerline  
 $T_2$  = Width of left-turn lane on departure side of centerline

Posted Speed	Desirable Taper Rate [6]
55 mph	55:1
50 mph	50:1
45 mph	45:1
40 mph	40:1
35 mph	35:1
30 mph	30:1
25 mph	25:1

## Exhibit 1310-10b Median Channelization: Median Width 11 ft or More

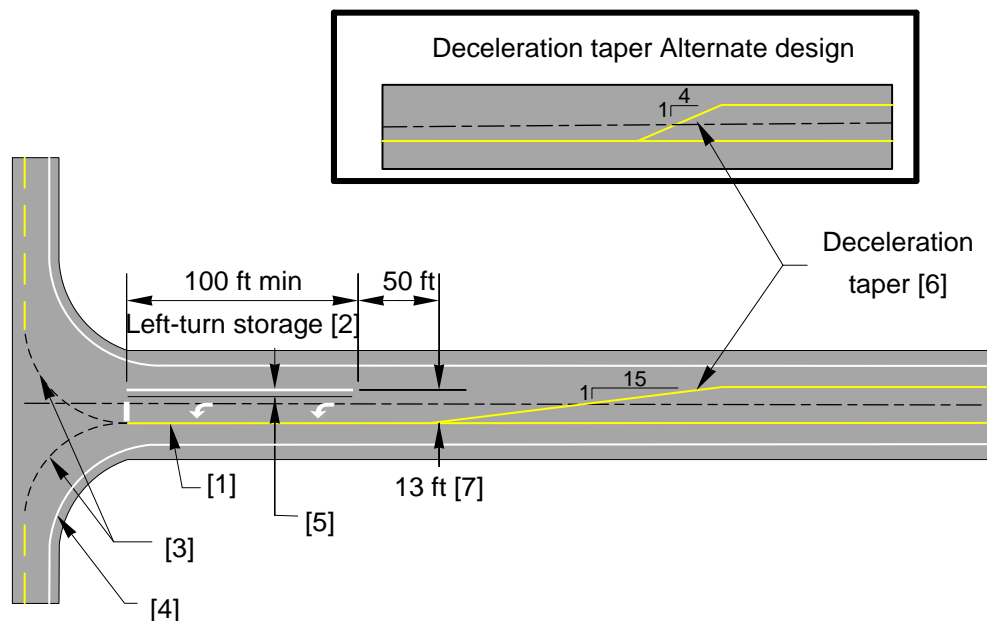
**Notes:**

- [1] Where curb is provided, add the width of the curb and the shoulders. For shoulder widths at curbs, see [1310.03\(6\)](#) and Chapter [1230](#).
- [2] For left-turn storage length, see Exhibits [1310-7b](#) for 4-lane roadways or [1310-8a](#) through [8c](#) for 2-lane roadways.
- [3] Verify the design vehicle can make the turn using turn simulation software (such as AutoTURN®).
- [4] For right-turn corner design, see [Exhibit 1310-6](#).
- [5] For median widths greater than 13 ft, it is desirable to locate the left-turn lane adjacent to the opposing through lane with excess median width between the same-direction through lane and the turn lane.
- [6] For increased storage capacity, the left-turn deceleration taper alternate design may be used.
- [7] Reduce to lane width for medians less than 13 ft wide.

**General:**

For pavement marking details, see the [Standard Plans](#) and the [MUTCD](#).

Exhibit 1310-10c Median Channelization: Median Width 23 ft to 26 ft

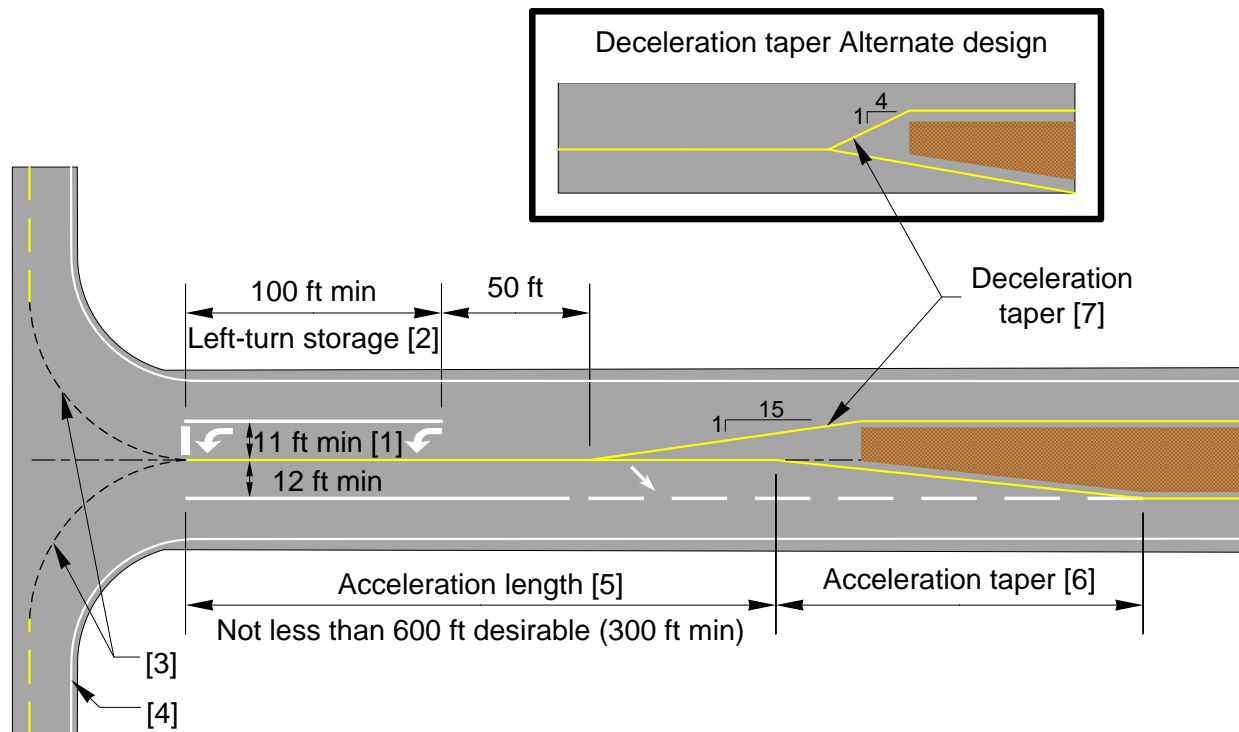

Notes:

- [1] When curb is provided, add the width of the curb.
- [2] For left-turn storage length, see Exhibits 1310 7b for 4-lane roadways or 1310-8a through 8c for 2-lane roadways.
- [3] Verify the design vehicle can make the turn using turn simulation software (such as AutoTURN®).
- [4] For right-turn corner design, see Exhibit 1310 6.
- [5] The minimum total length of the median acceleration lane is shown in Exhibit 1310-14.
- [6] For acceleration taper rate, see Table on this exhibit.
- [7] For increased storage capacity, the left-turn deceleration taper alternate design may be used.

Posted Speed	Taper Rate
55 mph	55:1
50 mph	50:1
45 mph	45:1
40 mph	27:1
35 mph	21:1
30 mph	15:1
25 mph	11:1

General:

For pavement marking details, see the *Standard Plans* and the *MUTCD*.

## Exhibit 1310-10d Median Channelization: Median Width of More Than 26 ft

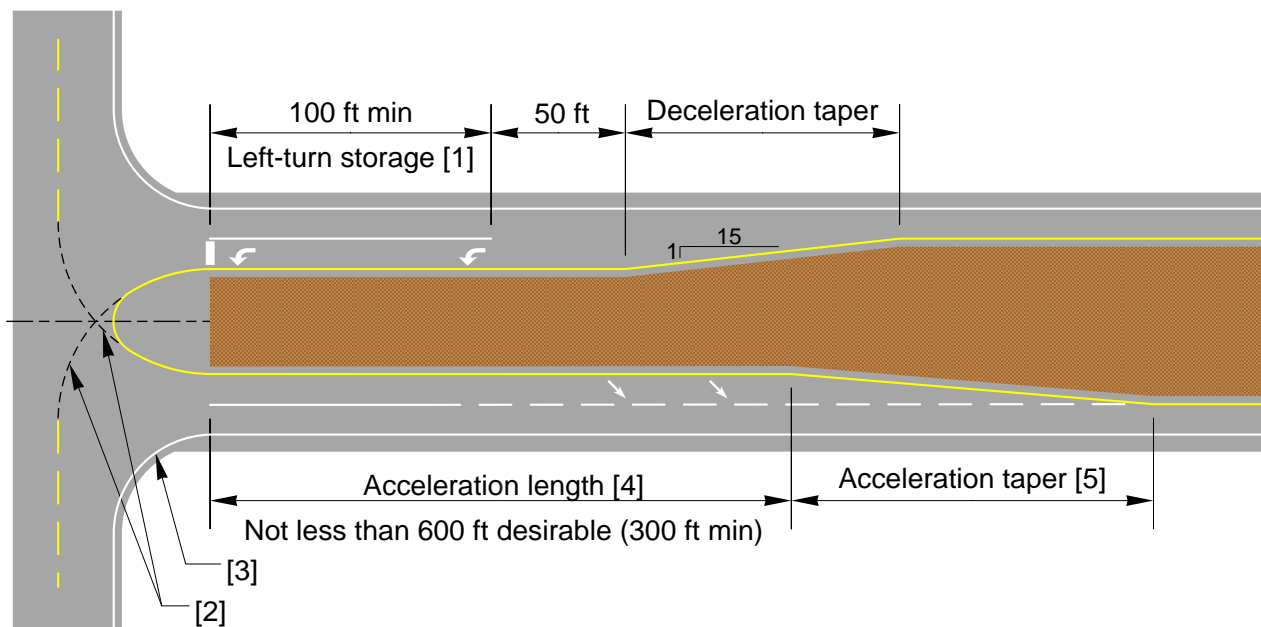
**Notes:**

- [1] For left-turn storage length, see Exhibits [1310-7b](#) for 4-lane roadways or [1310-8a](#) through [8c](#) for 2-lane roadways.
- [2] Verify the design vehicle can make the turn using turn simulation software (such as AutoTURN®).
- [3] For right-turn corner design, see [Exhibit 1310-6](#).
- [4] The minimum length of the median acceleration lane is shown in [Exhibit 1310-14](#).
- [5] For acceleration taper rate, see the Table on Exhibit [1310-10c](#).

**General:**

For pavement marking details, see the [Standard Plans](#) and the [MUTCD](#).

## Exhibit 1310-10e Median Channelization: Minimum Protected Storage

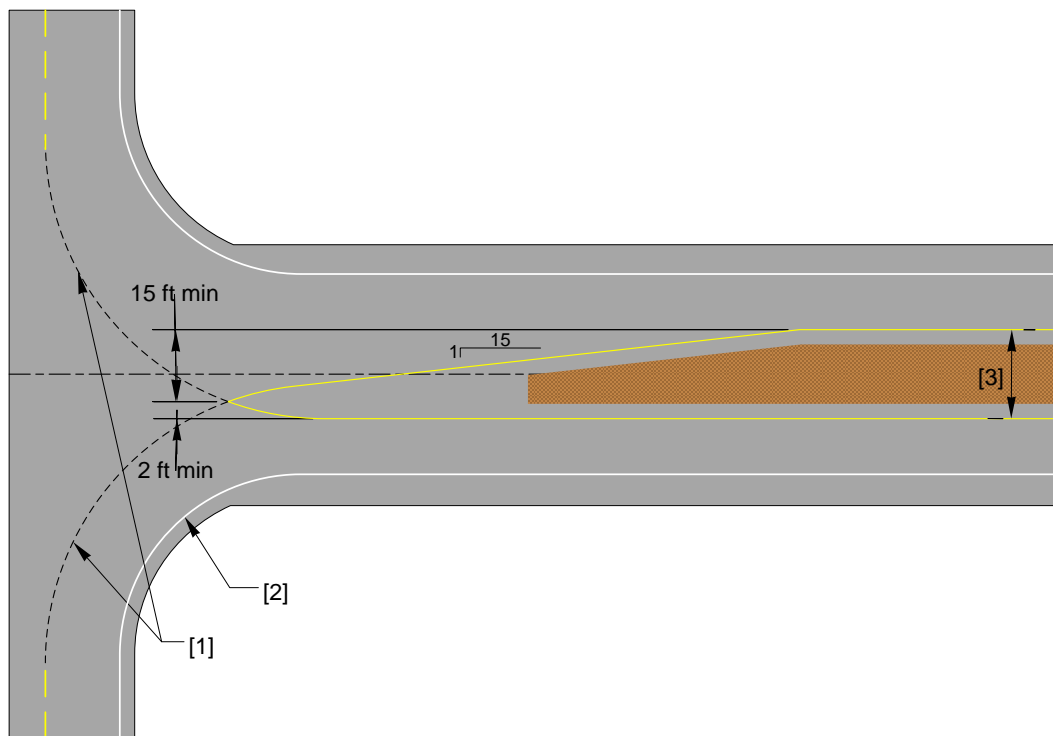
**Notes:**

- [1] Verify the design vehicle can make the turn using turn simulation software (such as AutoTURN®).
- [2] For right-turn corner design, see [Exhibit 1310-6](#).
- [3] For median width 17 ft or more. For median width less than 17 ft, widen to 17 ft. or use [Exhibit 1310-10b](#).

**General:**

For pavement marking details, see the [Standard Plans](#) and the [MUTCD](#).

**1310.03(2)(b) Two-Way Left-Turn Lanes (TWLTL)**

Two-way left-turn lanes are located between opposing lanes of traffic. They are used by vehicles making left turns from either direction, from or onto the roadway.

Use TWLTLs only on managed access highways where there are no more than two through lanes in each direction. Evaluate installation of TWLTLs where:

- A crash study indicates reduced crashes with a TWLTL.
- There are existing closely spaced access points or minor street intersections.
- There are unacceptable through traffic delays or capacity reductions because of left-turning vehicles.



TWLTLs can reduce delays to through traffic, reduce rear-end crashes, and provide separation between opposing lanes of traffic. However, they do not provide refuge for pedestrians and can encourage strip development with additional closely spaced access points. Evaluate other alternatives (such as prohibiting midblock left turns and providing for U-turns) before using a TWLTL. (See [Chapter 540](#) for additional restrictions on the use of TWLTLs, and [Chapter 1230](#) for discussion of road diets, which commonly employ a center turn lane.)

The basic design for a TWLTL is illustrated in [Exhibit 1310-10f](#). Additional criteria are as follows:

- The desirable length of a TWLTL is not less than 250 feet.
- Provide illumination in accordance with the guidelines in [Chapter 1040](#).
- Pavement markings, signs, and other traffic control devices must be in accordance with the [MUTCD](#) and the [Standard Plans](#).
- Provide clear channelization when changing from TWLTLs to one-way left-turn lanes at an intersection.

**Exhibit 1310-10f Median Channelization: Two-Way Left-Turn Lane**

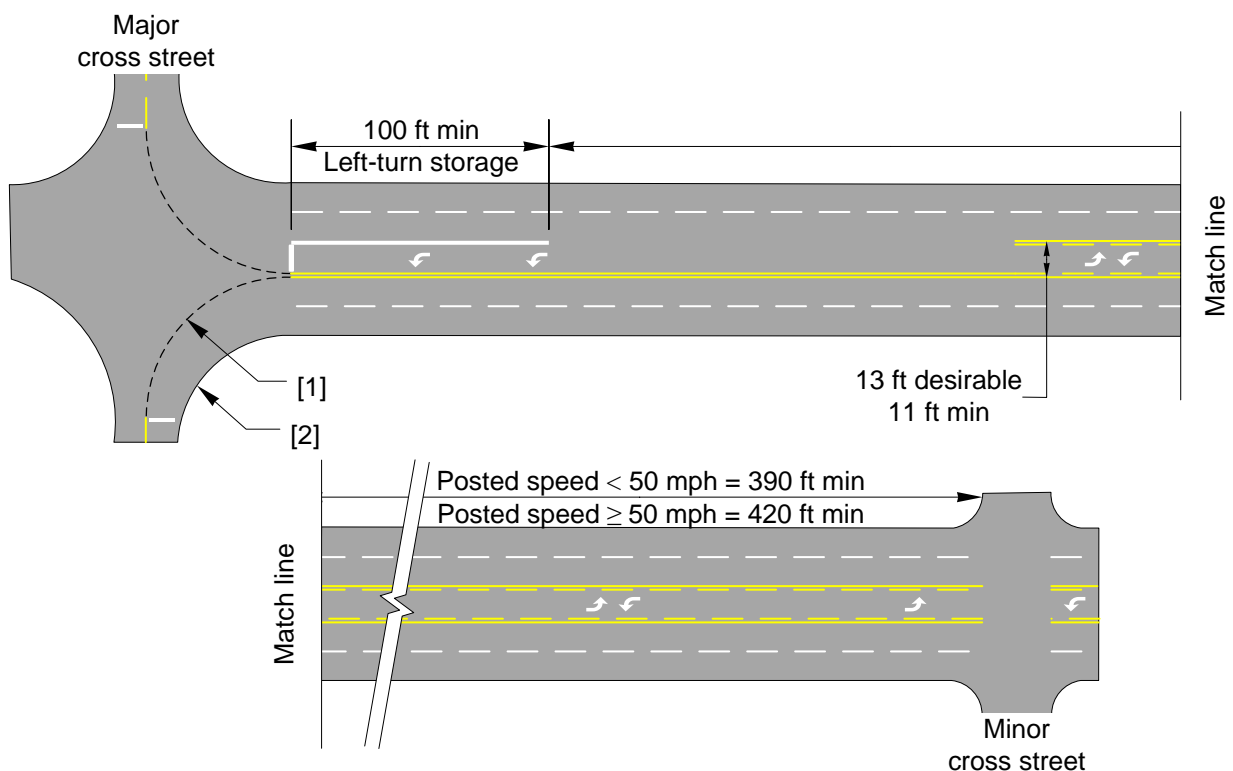

**Notes:**

- [1] Verify the design vehicle can make the turn using turn simulation software (such as AutoTURN®).
- [2] For right-turn corner design, see [Exhibit 1310-6](#).

**General:**

For pavement marking details and signing criteria, see the [Standard Plans](#) and the [MUTCD](#).

### 1310.03(3) *Right-Turn Lanes*

Right-turn movements influence intersection capacity even though there is no conflict between right-turning vehicles and opposing traffic. Right-turn lanes might be needed to maintain efficient intersection operation. Use the following to determine when to consider right-turn lanes at unsignalized intersections:

- For two-lane roadways and for multilane roadways with a posted speed of 45 mph or above, when recommended by [Exhibit 1310-11](#).
- A crash study indicates an overall crash reduction with a right-turn lane.
- The presence of pedestrians requires right-turning vehicles to stop.
- Restrictive geometrics require right-turning vehicles to slow greatly below the speed of the through traffic.
- There is less than decision sight distance for traffic approaching the intersection.
- For unsignalized intersections, see [1310.03\(4\)](#) for guidance on right-turn lane lengths. For signalized intersections, use a traffic signal analysis to determine whether a right-turn lane is needed and what the length is (see [Chapter 1330](#)).
- A capacity analysis may be used to determine whether right-turn lanes are needed to maintain the desired level of service.
- Where adequate right of way exists, providing right-turn lanes is relatively inexpensive and can provide increased operational efficiency.
- The right-turn pocket or the right-turn taper (see [Exhibit 1310-12](#)) may be used at any minor intersection where a right-turn lane is not provided. These designs reduce interference and delay to the through movement by offering an earlier exit to right-turning vehicles.
- If the right-turn pocket is used, [Exhibit 1310-12](#) shows taper lengths for various posted speeds.

## Exhibit 1310-11 Right-Turn Lane Guidelines

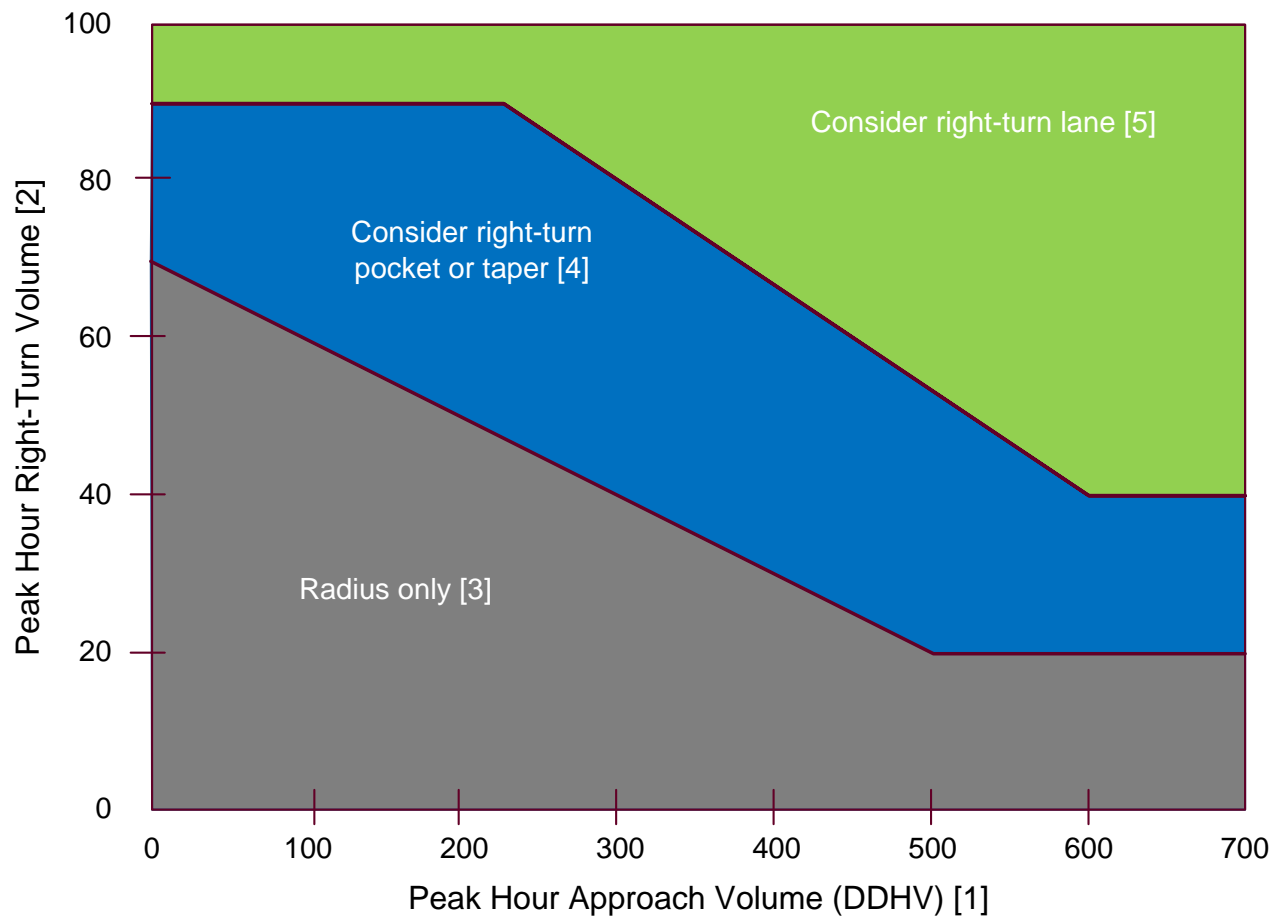
**Notes:**

- [1] For two-lane highways, use the peak hour DDHV (through + right-turn).  
For multilane, high-speed highways (posted speed 45 mph or above), use the right-lane peak hour approach volume (through + right-turn).
- [2] When all three of the following conditions are met, reduce the right-turn DDHV by 20:
- The posted speed is 45 mph or below
  - The right-turn volume is greater than 40 VPH
  - The peak hour approach volume (DDHV) is less than 300 VPH
- [3] For right-turn corner design, see [Exhibit 1310-6](#).
- [4] For right-turn pocket or taper design, see [Exhibit 1310-12](#).
- [5] For right-turn lane design, see [Exhibit 1310-13](#).

**Exhibit 1310-12 Right-Turn Pocket and Right-Turn Taper**

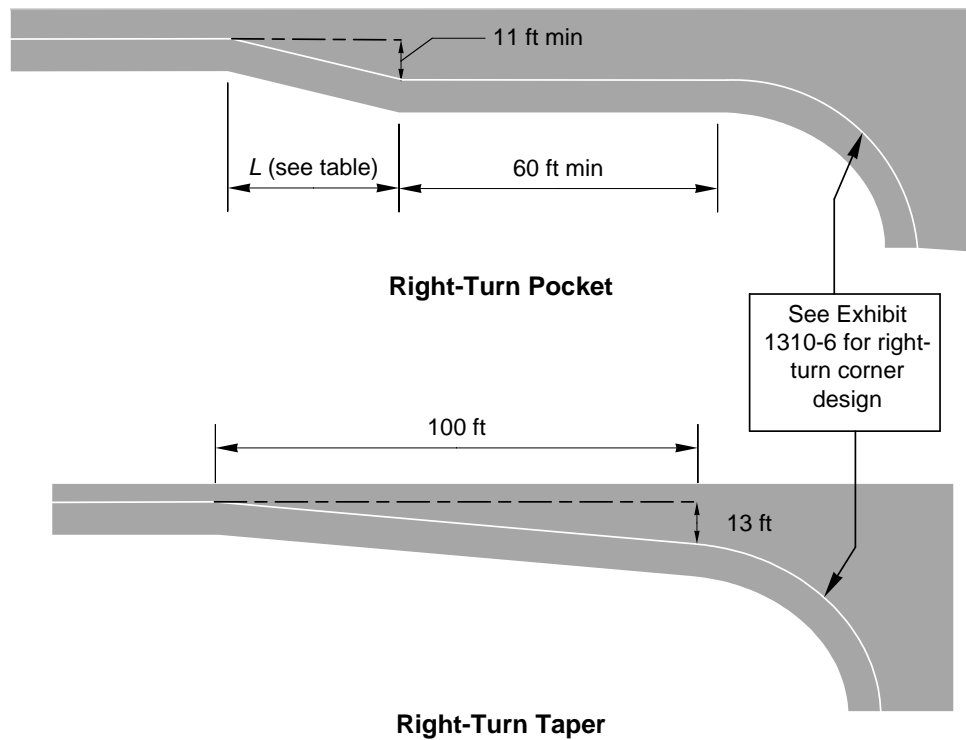

Posted Speed Limit	L
Below 40 mph	40 ft
40 mph or above	100 ft

**1310.03(4) Speed Change Lanes**

A speed change lane is an auxiliary lane primarily for the acceleration or deceleration of vehicles entering or leaving the through traveled way. Speed change lanes are normally provided for at-grade intersections on multilane divided highways with access control. Where roadside conditions and right of way allow, speed change lanes may be provided on other through roadways. Justification for a speed change lane depends on many factors, including speed; traffic volumes; capacity; type of highway; design and frequency of intersections and crash history

When either deceleration or acceleration lanes are to be used, design them in accordance with Exhibits 1310-13 and 1310-14. When the design speed of the turning traffic is greater than 20 mph, design the speed change lane as a ramp in accordance with Chapter 1360. When a deceleration lane is used with a left-turn lane, add the deceleration length to the storage length.

A dedicated deceleration lane (see Exhibit 1310-13) is advantageous because it removes slowing vehicles from the through lane.

An acceleration lane (see Exhibit 1310-14) is not as advantageous because entering drivers can wait for an opportunity to merge without disrupting through traffic. However, acceleration lanes for left-turning vehicles provide a benefit by allowing the turn to be made in two movements.

Exhibit 1310-13 Right-Turn Lane

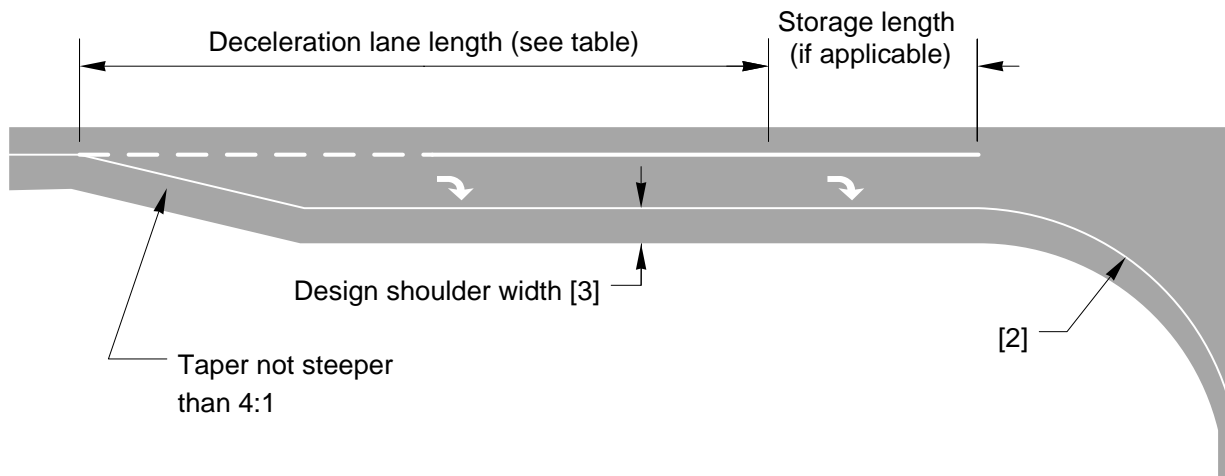

Highway Design Speed (mph)	Deceleration Lane Length (ft)
30	160 [1]
35	220
40	275
45	350
50	425
55	515
60	605
65	715
70	820

Minimum Deceleration Lane Length (ft)

Grade	Upgrade	Downgrade
3% to less than 5%	0.9	1.2
5% or more	0.8	1.35

Adjustment Multiplier for Grades 3% or Greater

Notes:

- [1] When adjusting for grade, do not reduce the deceleration lane to less than 150 ft.
- [2] For right-turn corner design, see [Exhibit 1310-6](#).
- [3] See [1310.03\(6\)](#) and [Chapter 1230](#).

General:

For pavement marking details, see the [Standard Plans](#) and the [MUTCD](#).

Exhibit 1310-14 Acceleration Lane

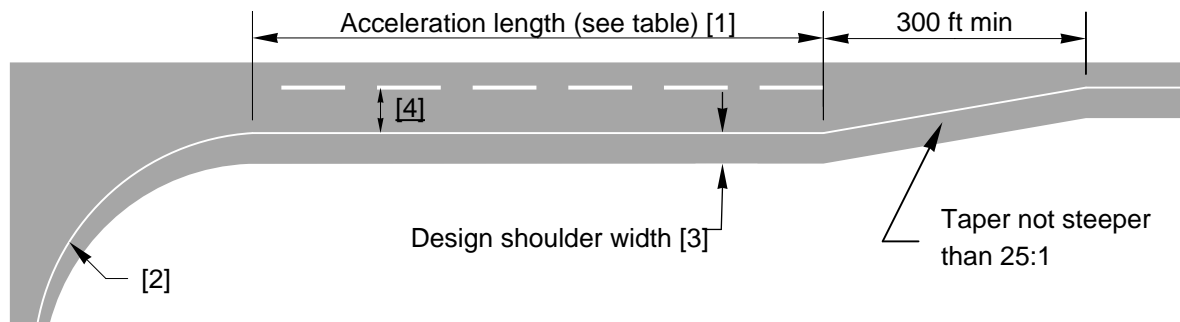

Highway Design Speed (mph)	Turning Roadway Design Speed (mph)		
	Stop	15	20
30	180	140	
35	280	220	160
40	360	300	270
45	560	490	440
50	720	660	610
55	960	900	810
60	1,200	1,140	1,100
65	1,410	1,350	1,310
70	1,620	1,560	1,520

Minimum Acceleration Length (ft) [1]

Highway Design Speed (mph)	% Grade	Upgrade	Downgrade
40	3% to less than 5%	1.3	0.7
50		1.3	0.65
60		1.4	0.6
70		1.5	0.6
40	5% or more	1.5	0.6
50		1.5	0.55
60		1.7	0.5
70		2.0	0.5

Adjustment Multiplier for Grades 3% or Greater

Notes:

- [1] At free right turns (no stop required) and all left turns, the minimum acceleration lane length is not less than 300 ft.
- [2] For right-turn corner design, see [Exhibit 1310-6](#).
- [3] See [1310.03\(6\)](#) and [Chapter 1230](#).
- [4] Lane width as determined by Chapters [1106](#) and [1230](#).

General:

For pavement-marking details, see the [Standard Plans](#) and the [MUTCD](#).

### **1310.03(5) Drop Lanes**

A lane may be dropped at an intersection with a turn-only lane or beyond the intersection. Do not allow a lane-reduction taper to cross an intersection or end less than 100 feet before an intersection. (See [Chapter 1210](#) for lane reduction pavement transitions.)

When a lane is dropped beyond signalized intersections, provide a lane of sufficient length to allow smooth merging. For facilities with a posted speed of 45 mph or higher, use a minimum length of 1,500 feet. For facilities with a posted speed lower than 45 mph, provide a lane of sufficient length that the advanced lane reduction warning sign can be placed not less than 100 feet beyond the intersection area.

When a lane is dropped beyond unsignalized intersections, provide a lane beyond the intersection not less than the acceleration lane length from [Exhibit 1310-14](#).

### **1310.03(6) Shoulders**

Shoulder width is controlled by its intended functional use and its contribution to achieving the desired safety performance when balanced with other design elements. See [Chapter 1230](#) for functional uses and recommended shoulder widths.

Reducing the shoulder width at intersections facilitates the installation of turn lanes without unduly affecting the overall width of the roadway. A narrower roadway also reduces pedestrian exposure in crosswalks and discourages motorists from using the shoulder to bypass other turning traffic.

### **1310.03(7) Islands**

An island is a defined area within an intersection between traffic lanes for the separation of vehicle movements or for pedestrian refuge. Within an intersection, a median is considered an island. Design islands to clearly delineate the traffic channels to drivers and pedestrians.

Traffic islands perform the following functions:

- Channelization islands control and direct traffic movements.
- Divisional islands separate traffic movements.
- Refuge islands provide refuge for pedestrians and bicyclists crossing the roadway.
- Islands can provide for the placement of traffic control devices and luminaires.
- Islands can provide areas within the roadway for landscaping.

#### **1310.03(7)(a) Size and Shape**

Divisional islands are normally elongated and at least 4 feet wide and 20 feet long.

Channelization islands are normally triangular. In rural areas, 75 ft<sup>2</sup> is the minimum island area and 100 ft<sup>2</sup> is desirable. In urban areas where posted speeds are 25 mph or below, smaller islands are acceptable. Use islands with at least 200 ft<sup>2</sup> if pedestrians will be crossing or traffic control devices or luminaires will be installed.

Design triangular-shaped islands as shown in Exhibits [1310-15a](#) through [15c](#). The shoulder and offset widths illustrated are for islands with vertical curbs 6 inches or higher. Where painted islands are used, such as in rural areas, these widths are desirable but may be omitted. (See [Chapter 1240](#) for desirable turning roadway widths.)

Island markings may be supplemented with reflective raised pavement markers.

Provide barrier-free access at crosswalk locations where raised islands are used. For pedestrian refuge islands and barrier-free access requirements, see [Chapter 1510](#).

### 1310.03(7)(b) Location

Design the approach ends of islands so they are visible to motorists. Position the island so that a smooth transition in vehicle speed and direction is attained. Begin transverse lane shifts far enough in advance of the intersection to allow gradual transitions. Avoid introducing islands on a horizontal or vertical curve. If the use of an island on a curve cannot be avoided, provide sight distance, illumination, or extension of the island.

#### Exhibit 1310-15a Traffic Island Designs

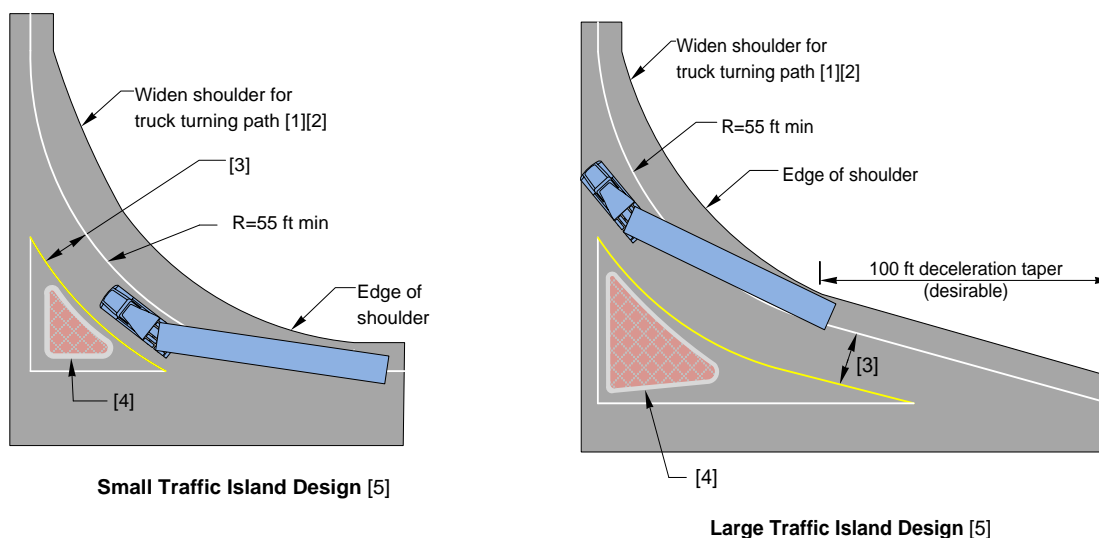

#### Notes:

- [1] Widen shoulders when right-turn radii or roadway width cannot be provided for large trucks. Design widened shoulder pavement the same depth as the right-turn lane.
- [2] Use turn simulation software (such as AutoTURN<sup>®</sup>) for the intersection design vehicle
- [3] For turning roadway widths, see [Chapter 1240](#).
- [4] For additional details on island placement, see [Exhibit 1310-15c](#).
- [5] Small traffic islands have an area of 100 ft<sup>2</sup> or less; large traffic islands have an area greater than 100 ft<sup>2</sup>.

#### General:

- Provide an accessible route for pedestrians (see [Chapter 1510](#)).
- 60° to 90° angle at stop or yield control.
- For right-turn corner design, see [Exhibit 1310-6](#).



### 1310.03(7)(c) Compound Right-Turn Lane

To design large islands, the common method is to use a large-radius curve for the turning traffic. While this does provide a larger island, it also encourages higher turning speeds. Where pedestrians are a concern, higher turning speeds are undesirable. An alternative is a compound curve with a large radius followed by a small radius (see [Exhibit 1310-15b](#)). This design forces the turning traffic to slow down.

#### Exhibit 1310-15b Traffic Island Designs: Compound Curve

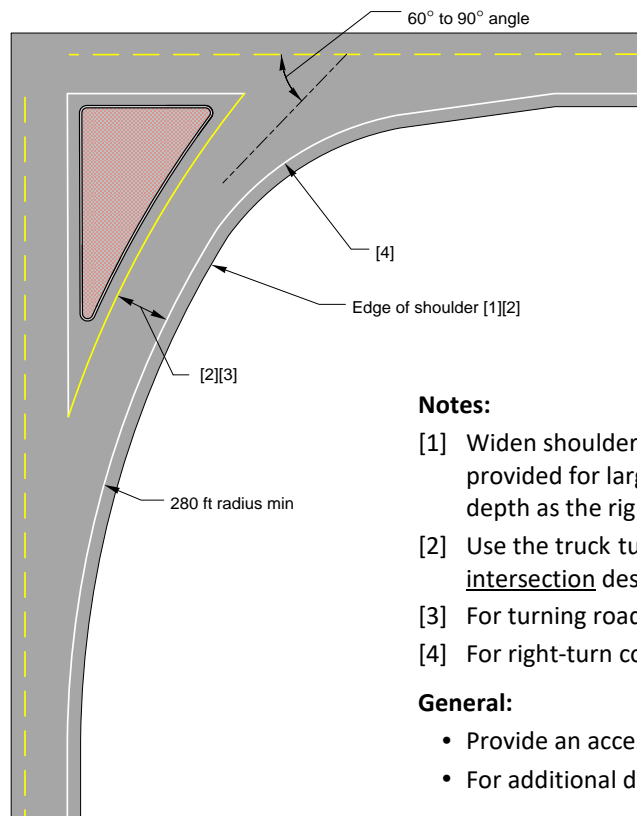

#### Notes:

- [1] Widen shoulders when right-turn radii and roadway width cannot be provided for large trucks. Design widened shoulder pavement the same depth as the right-turn lane.
- [2] Use the truck turn simulation software (such as AutoTURN®) for the [intersection](#) design vehicle.
- [3] For turning roadway widths, see [Chapter 1240](#).
- [4] For right-turn corner design, see [Exhibit 1310-6](#).

#### General:

- Provide an accessible route for pedestrians (see [Chapter 1510](#)).
- For additional details on island placement, see [Exhibit 1310-15c](#).

### 1310.03(7)(d) Curbing

Provide vertical curb 6 inches or higher for:

- Islands with luminaires, signals, or other traffic control devices.
- Pedestrian refuge islands.

Also consider curbing for:

- Divisional and channelizing islands.
- Landscaped islands.
- Stormwater conveyance.

In general, except to meet one of the uses listed above, it is desirable not to use curbs on facilities with a posted speed of 45 mph or above.

Avoid using curbs if the same objective can be attained with pavement markings.

Refer to [Chapter 1230](#) for additional information and design criteria on the use of curbs.

Exhibit 1310-15c Traffic Island Designs

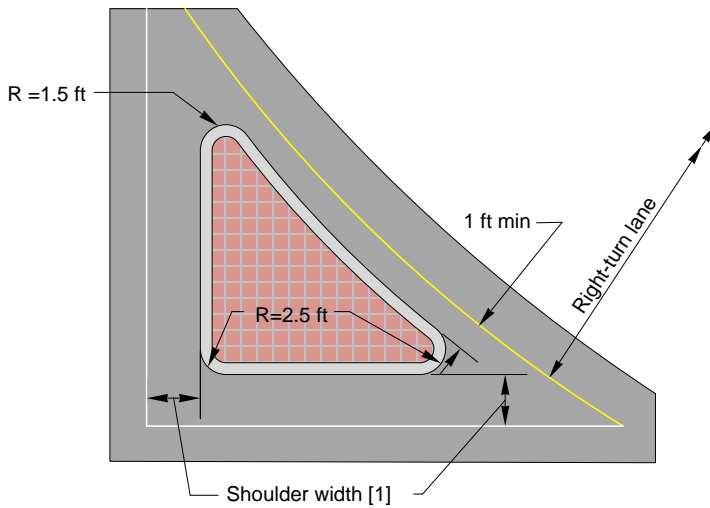

Small Raised Traffic Island [2]

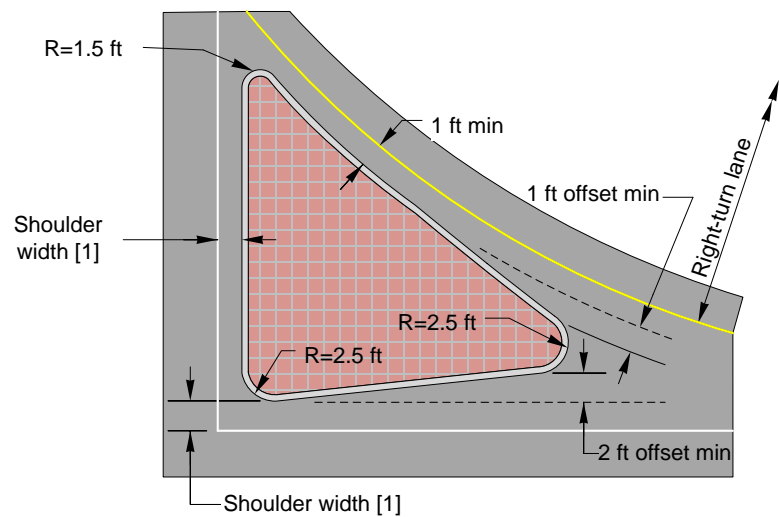

Large Raised Traffic Island [2]

**Notes:**

[1] For shoulder width at curbs, see [Chapter 1230](#). For additional information on shoulders at turn lanes, see [1310.03\(6\)](#).

[2] Small traffic islands have an area of 100 ft<sup>2</sup> or less; large traffic islands have an area greater than 100 ft<sup>2</sup>.

**General:**

Provide an accessible route for pedestrians (see [Chapter 1510](#)).

### 1310.04 U-Turns

For divided multilane highways without full access control that have access points where the median prevents left turns, evaluate the demand for locations that allow U turns. Normally, U turn opportunities are provided at intersections. However, where intersections are spaced far apart, U-turn median openings may be provided between intersections to accommodate U-turns. Use the desirable U-turn spacing (see [Exhibit 1310-16](#)) as a guide to determine when to provide U-turn median openings between intersections. Where the U-turning volumes are low, longer spacing may be used.

Locate U-turn median openings where intersection sight distance can be provided.

#### Exhibit 1310-16 U-Turn Spacing

Urban/Rural	Desirable	Minimum
Urban [1]	1,000 ft	[2]
Suburban	½ mile	¼ mile [3]
Rural	1 mile	½ mile

**Notes:**

[1] For design speeds higher than 45 mph, use suburban spacing.

[2] The minimum spacing is the acceleration lane length from a stop (see [Exhibit 1310-14](#)) plus 300 ft.

[3] For design speeds 60 mph or higher, the minimum spacing is the acceleration lane length from a stop (see [Exhibit 1310-14](#)) plus 300 ft.

When designing U-turn median openings, use [Exhibit 1310-18](#) as a guide. Where the median is less than 40 feet wide, with a large design vehicle, provide a U-turn roadway (see [Exhibit 1310-17](#)). Design A, with the U-turn roadway after the left-turn, is desirable. Use Design A when the median can accommodate a left-turn lane. Use Design B only where left-turn channelization cannot be built in the median.

## Exhibit 1310-17 U-Turn Roadway

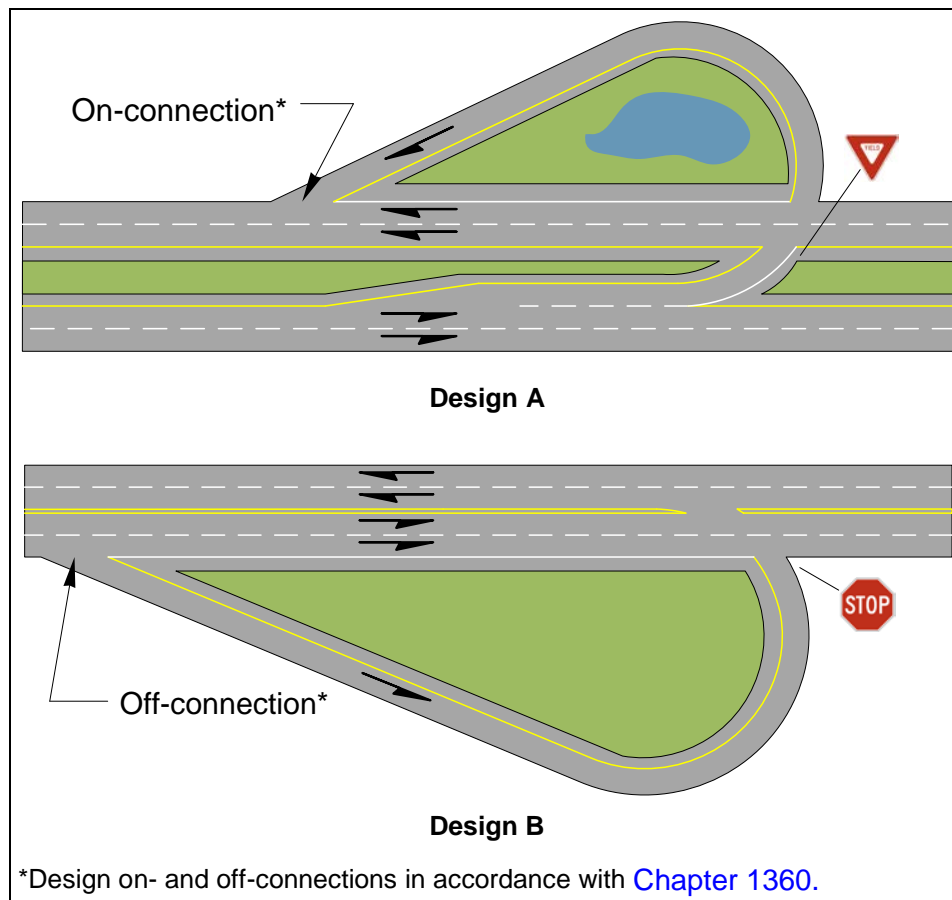

Document the need for U-turn locations, the spacing used, and the selected design vehicle. If the design vehicle is smaller than the largest vehicle using the facility, provide an alternate route.

U-turns at signal-controlled intersections do not need the acceleration lanes shown in [Exhibit 1310-18](#). For new U-turn locations at signal-controlled intersections, evaluate conflicts between right-turning vehicles from side streets and U-turning vehicles. Warning signs on the cross street might be appropriate.

## Exhibit 1310-18 U-Turn Median Openings

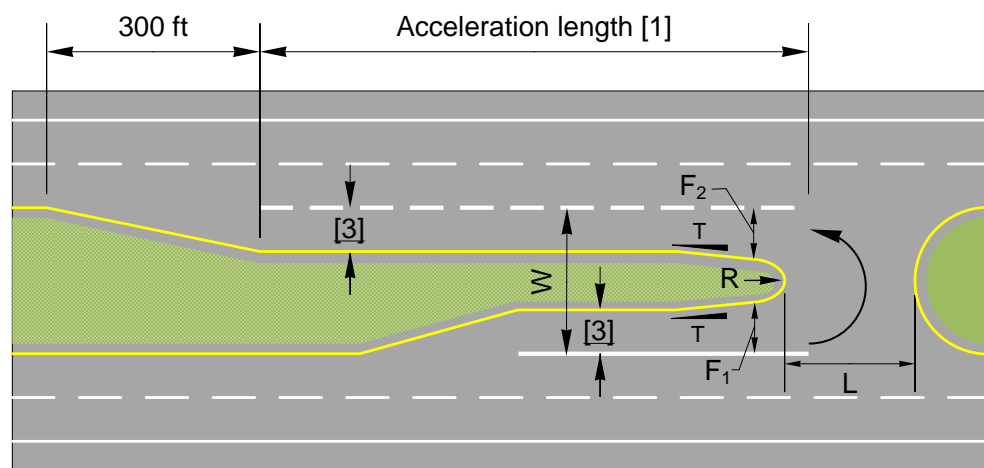
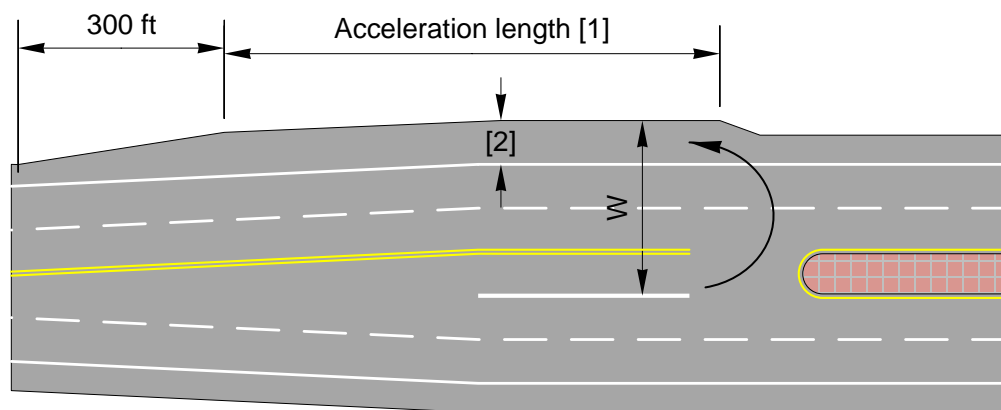

Vehicle	W	R	L	F <sub>1</sub>	F <sub>2</sub>	T
P	52	14	14	12	12	—
SU-30	87	30	20	13	15	10:1
CITY-BUS	87	28	23	14	18	10:1
WB-40	84	25	27	15	20	6:1
WB-67	94	22	49	15	35	6:1

**U-Turn Design Dimensions**

**Notes:**

- [1] The minimum length of the acceleration lane is shown in [Exhibit 1310-14](#). Acceleration lane may be eliminated at signal-controlled intersections.
- [2] When U-turn uses the shoulder, provide shoulder width sufficient for the intersection design vehicle to make the turn and shoulder pavement designed to the same depth as the through lanes for the acceleration length and taper.
- [3] Lane width as determined by Chapters [1106](#) and [1230](#).

**General:**

All dimensions are in feet.

## 1310.05 Intersection Sight Distance

Providing drivers the ability to see stop signs, traffic signals, and oncoming traffic in time to react accordingly will reduce the probability of conflicts occurring at an intersection. Actually avoiding conflicts is dependent on the judgment, abilities, and actions of all drivers using the intersection.

The driver of a vehicle that is stopped and waiting to cross or enter a through roadway needs obstruction-free sight triangles in order to see enough of the through roadway to complete all legal maneuvers before an approaching vehicle on the through roadway can reach the intersection. Use [Exhibit 1310-19a](#) to determine minimum intersection sight distance along the through roadway.

The sight triangle is determined as shown in [Exhibit 1310-19b](#). Within the sight triangle, lay back the cut slopes and remove, lower, or move hedges, trees, signs, utility poles, signal poles, and anything else large enough to be a sight obstruction. Eliminate parking to remove obstructions to sight distance. In order to maintain the sight distance, the sight triangle must be within the right of way or a state maintenance easement (see [Chapter 510](#)).

The setback distance for the sight triangle is 18 feet from the edge of traveled way. This is for a vehicle stopped 10 feet from the edge of traveled way. The driver is almost always 8 feet or less from the front of the vehicle; therefore, 8 feet are added to the setback. When the stop bar is placed more than 10 feet from the edge of traveled way, providing the sight triangle to a point 8 feet back of the stop bar is desirable.

Provide a clear sight triangle for a P vehicle at all intersections. In addition, provide a clear sight triangle for the SU-30 vehicle for rural highway conditions. If there is significant combination truck traffic, use the WB-67 rather than the SU-30. In areas where SU-30 or WB vehicles are minimal and right of way restrictions limit sight triangle clearing, only the P vehicle sight distance needs to be provided.

At existing intersections, when sight obstructions within the sight triangle cannot be removed due to limited right of way, the intersection sight distance may be modified. Drivers who do not have the desired sight distance creep out until the sight distance is available; therefore, the setback may be reduced to 10 feet. Document the right of way width and provide a brief analysis of the intersection sight distance clarifying the reasons for reduction. Verify and document that there is no identified crash trend at the intersection. Document the intersection location and the available sight distance as a [Design Analysis](#).

If the intersection sight distance cannot be provided using the reductions in the preceding paragraph, where stopping sight distance is provided for the major roadway, the intersection sight distance, at the 10-foot setback point, may be reduced to the stopping sight distance for the major roadway, with a [Design Analysis](#) and HQ Design Office review and concurrence. (See [Chapter 1260](#) for required stopping sight distance.) Document the right of way width and provide a brief analysis of the intersection sight distance clarifying the reasons for reduction. Verify and document that there is no identified crash trend at the intersection. Document the intersection location and the available sight distance as a [Design Analysis](#).

In some instances, intersection sight distance is provided at the time of construction, but subsequent vegetative growth has degraded the sight distance available. The growth may be seasonal or occur over time. In these instances, intersection sight distance can be restored through the periodically scheduled maintenance of vegetation in the sight triangle within the WSDOT right of way or state maintenance easement.

At intersections controlled by traffic signals, provide sight distance for right-turning vehicles. For intersections controlled by the geometry of roundabouts, see [Chapter 1320](#).

Designs for movements that cross divided highways are influenced by median widths. If the median is wide enough to store the design vehicle, with a 3-foot clearance at both ends of the vehicle, sight distances are determined in two steps. The first step is for crossing from a stopped position to the median storage. The second step is for the movement, either across or left into the through roadway.

Design sight distance for ramp terminals as at-grade intersections with only left- and right-turning movements. An added element at ramp terminals is the grade separation structure. [Exhibit 1310-19b](#) gives the sight distance guidance in the vicinity of a structure. In addition, when the crossroad is an undercrossing, check the sight distance under the structure graphically using a truck eye height of 6 feet and an object height of 1.5 feet.

Document a brief description of the intersection area, sight distance restrictions, and traffic characteristics to support the design vehicle and sight distances chosen.

Exhibit 1310-19a Sight Distance at Intersections

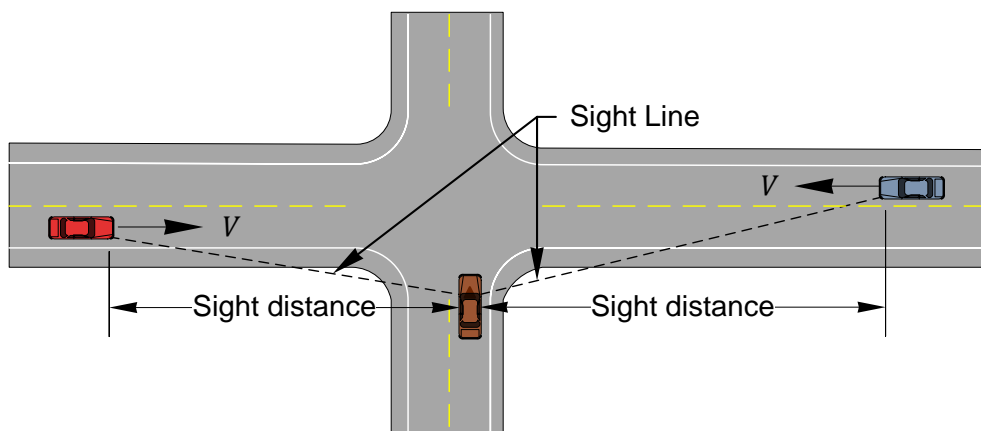

$S_i = 1.47Vt_g$
<p><b>Where:</b>  <math>S_i</math> = Intersection sight distance (ft)  <math>V</math> = Design speed of the through roadway (mph)  <math>t_g</math> = Time gap for the minor roadway traffic to enter or cross the through roadway (sec)</p>

**Intersection Sight Distance Equation  
Table 1**

**Notes:**

Adjust the  $t_g$  values listed in Table 2 as follows:

**Crossing or right-turn maneuvers:**

All vehicles      subtract 1.0 sec

**Multilane roadways:**

Left turns, for each lane in excess of one to be crossed, and for medians wider than 4 ft:

Passenger cars      add 0.5 sec

All trucks and buses      add 0.7 sec

Crossing maneuvers, for each lane in excess of two to be crossed, and for medians wider than 4 ft:

Passenger cars      add 0.5 sec

All trucks and buses      add 0.7 sec

Where medians are wide enough to store the design vehicle, determine the sight distance as two maneuvers.

**Crossroad grade greater than 3%:**

All movements upgrade for each percent that exceeds 3%:

All vehicles      add 0.2 sec

Design Vehicle	Time Gap ( $t_g$ ) in Sec
Passenger car (P)	7.5
Single-unit trucks and buses (SU-30 & CITY-BUS)	9.5
Combination trucks (WB-40 & WB-67)	11.5
<p><b>Note:</b>                      Values are for a stopped vehicle to turn left onto a two-lane two-way roadway with no median and grades 3% or less.</p>	

**Intersection Sight Distance Time Gaps ( $t_g$ )  
Table 2**



Exhibit 1310-19b Sight Distance at Intersections

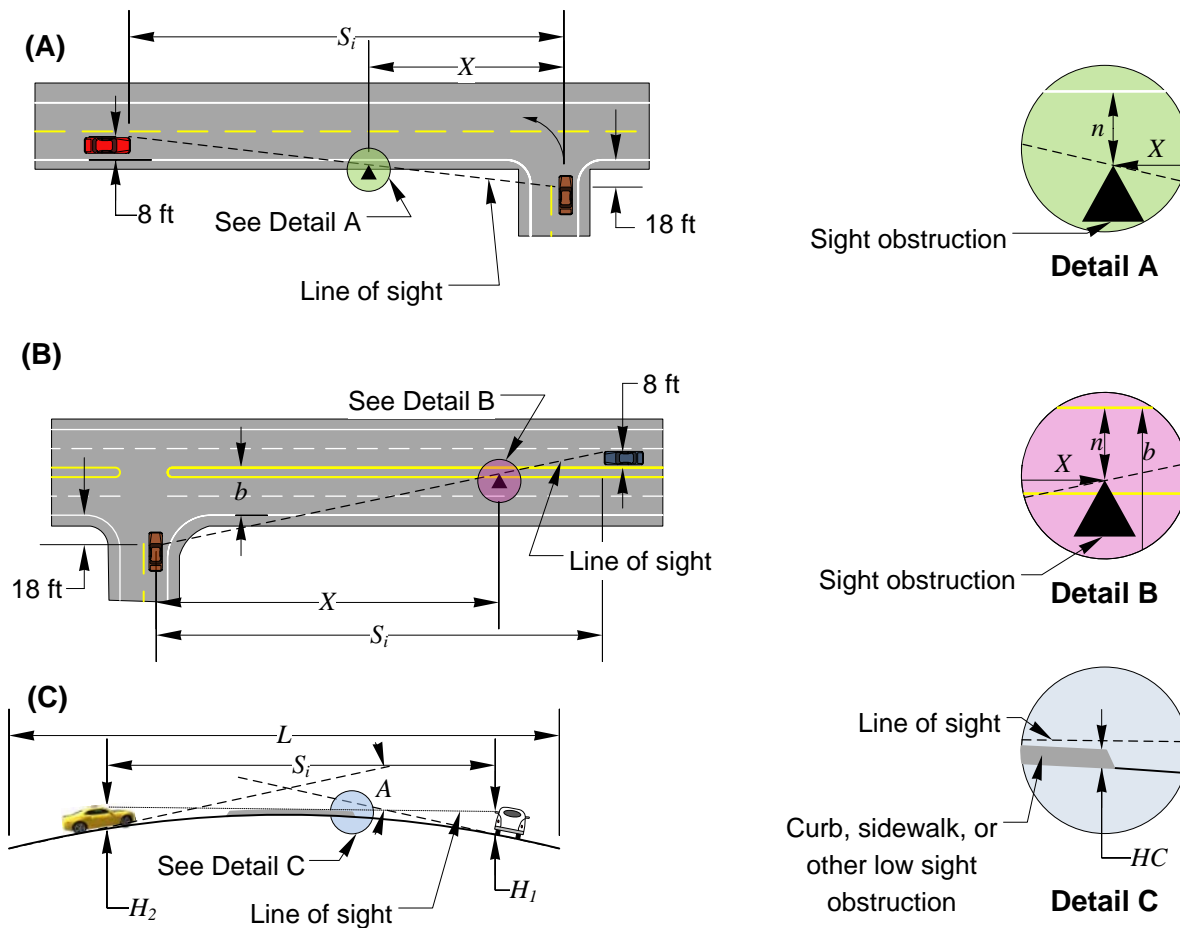

For sight obstruction driver cannot see over:

$$S_i = \frac{(26 + b)(X)}{(18 + b - n)}$$

Where:

- $S_i$  = Available intersection sight distance (ft)
- $n$  = Offset from sight obstruction to edge of lane (ft)
- $b$  = Distance from near edge of traveled way to near edge of lane approaching from right (ft) ( $b=0$  for sight distance to the left)
- $X$  = Distance from centerline of lane to sight obstruction (ft)

For crest vertical curve over a low sight obstruction when  $S < L$ :

$$S_i = \sqrt{\frac{100L[\sqrt{2(H_1 - HC)} + \sqrt{2(H_2 - HC)}]^2}{A}}$$

$$L = \frac{AS_i^2}{100[\sqrt{2(H_1 - HC)} + \sqrt{2(H_2 - HC)}]^2}$$

Where:

- $S_i$  = Available sight distance (ft)
- $H_1$  = Eye height (3.5 ft for passenger cars; 6 ft for all trucks)
- $H_2$  = Approaching vehicle height (3.5 ft)
- $HC$  = Sight obstruction height (ft)
- $L$  = Vertical curve length (ft)
- $A$  = Algebraic difference in grades (%)

## 1310.06 Signing and Delineation

Use the [MUTCD](#) and the [Standard Plans](#) for signing and delineation criteria. Provide a route confirmation sign on all state routes shortly after major intersections. (See [Chapter 1020](#) for additional information on signing.)

Painted or plastic pavement markings are normally used to delineate travel paths. For pavement marking details, see the [MUTCD](#), [Chapter 1030](#), and the [Standard Plans](#).

Contact the region or HQ Traffic Office for additional information when designing signing and pavement markings.

## 1310.07 Procedures

Document design decisions and conclusions in accordance with [Chapter 300](#). For highways with limited access control, see [Chapter 530](#).

### 1310.07(1) Approval

An intersection is approved in accordance with [Chapter 300](#). Complete the following items, as needed, before intersection approval:

- Intersection Control Type Approval (see [Chapter 1300](#))
- [Design Analyses](#) approved in accordance with [Chapter 300](#)
- Approved Traffic Signal Permit (DOT Form 242-014 EF) (see [Chapter 1330](#))

### 1310.07(2) Intersection Plans

Provide intersection plans for any increases in capacity (turn lanes) at an intersection, modification of channelization, or change of intersection geometrics. Support the need for intersection or channelization modifications with history; school bus and mail route studies; hazardous materials route studies; pedestrian use; public meeting comments; etc.

For information to be included on the intersection plan for approval, see the Intersection/Channelization Plan for Approval Checklist on the following website:

[www.wsdot.wa.gov/design/projectdev/](http://www.wsdot.wa.gov/design/projectdev/)

### 1310.07(3) Local Agency or Developer-Initiated Intersections

Intersections in local agency and developer projects on state routes must receive the applicable approvals in section [1310.07\(1\)](#) as part of the intersection design process.

The project initiator submits an intersection plan and the documentation of design decisions that led to the plan to the region for approval. For those plans requiring a [Design Analysis](#), the [Design Analysis](#) must be approved in accordance with [Chapter 300](#) prior to approval of the plan. After the plan approval, the region prepares a construction agreement with the project initiator (see the [Utilities Manual](#)).

## 1310.08 Documentation

Refer to [Chapter 300](#) for design documentation requirements.

## **1310.09 References**

### **1310.09(1) Federal/State Laws and Codes**

Americans with Disabilities Act of 1990 (ADA) (28 CFR Part 36, Appendix A)

[Revised Code of Washington \(RCW\) 35.68.075](#), Curb ramps for persons with disabilities – Required – Standards and requirements

[Washington Administrative Code \(WAC\) 468-18-040](#), Design standards for rearranged county roads, frontage roads, access roads, intersections, ramps and crossings

[WAC 468-52](#), Highway access management – Access control classification system and standards

### **1310.09(2) Design Guidance**

[Local Agency Guidelines \(LAG\)](#), M 36-63, WSDOT

[Manual on Uniform Traffic Control Devices for Streets and Highways](#), USDOT, FHWA; as adopted and modified by Chapter 468-95 WAC “Manual on uniform traffic control devices for streets and highways” (MUTCD)

[Standard Plans for Road, Bridge, and Municipal Construction](#) (Standard Plans), M 21-01, WSDOT

### **1310.09(3) Supporting Information**

*A Policy on Geometric Design of Highways and Streets* (Green Book), AASHTO

*Aspects of Traffic Control Devices*, Highway Research Record No. 211, pp 1 18, “Volume Warrants for Left-Turn Storage Lanes at Unsignalized Grade Intersections,” Harmelink, M.D.

*Guidelines and Recommendations to Accommodate Older Drivers and Pedestrians*, FHWA-RD-01-051, USDOT, FHWA, May 2001

*Highway Capacity Manual (HCM)*, Special Report 209, Transportation Research Board, National Research Council

*Intersection Channelization Design Guide*, NCHRP 279

